

See discussions, stats, and author profiles for this publication at: <https://www.researchgate.net/publication/331408283>

Model dan Bentuk Penelitian E-Learning Menggunakan Structural Equation Model

Book · February 2019

CITATION

1

READS

387

3 authors:



Ramadiani Ramadiani
Universitas Mulawarman

45 PUBLICATIONS 53 CITATIONS

[SEE PROFILE](#)



Azainil Azainil
Universitas Mulawarman

14 PUBLICATIONS 23 CITATIONS

[SEE PROFILE](#)



Achmad Nizar Hidayanto
University of Indonesia

261 PUBLICATIONS 626 CITATIONS

[SEE PROFILE](#)

Some of the authors of this publication are also working on these related projects:



Enterprise Resources Planning [View project](#)



Approach Using Interpretive Structural Model (ISM) to Determine Key Sub-Factors at Factors: Benefits, Risk Reductions, Opportunities and Obstacles in Awareness IT Governance [View project](#)

**MODEL DAN BENTUK PENELITIAN E-LEARNING
MENGUNAKAN STRUCTURAL EQUATION MODEL**

Buku ini mengajarkan dan menjelaskan bagaimana membangun model penelitian e-learning maupun mobile learning sebelum direkomendasikan untuk pengembangan prototype dan konten e-learning.



Ramadiani, S.Pd., M.Si., M.Kom., Ph.D.

Born in Palembang on November 1, 1972. Work as a Lecturer at the Faculty of Computer Science and Information Technology (FKTI) Mulawarman University.

E-mail: ramadiani@fkti.unmul.ac.id, ilkom.ramadiani@gmail.com, mmi_ugm04@yahoo.com.

Hp: 085250501973.

Ramadiani received her PhD in Computer Science and Information System from University Putra Malaysia in 2015. She graduated from Indonesia University in 2000 and graduated from Gadjah Mada University in 2005 for her Computer Master. She currently works at the Department of Computer Science in Computer Science and Information System Faculty, Mulawarman University since December 2001 until now. Ramadiani does her research in Software Engineering, Information Systems (Business Informatics) and Human-computer Interaction. Her current project is 'e-Learning and Decision Support System'.

Scopus ID: 57160272300

SINTA ID: 5974501

Google Scholar ID: 9XnXoJgAAAAJ&hl

https://www.researchgate.net/profile/Ramadiani_Ramadiani



Penerbit
Mulawarman University PRESS
Gedung LP2M Universitas Mulawarman
Jl. Krayan, Kampus Gunung Kelua
Samarinda-Kalimantan Timur – INDONESIA 75123
Telp/Fax (0541) 747432, Email : mup.unmul@gmail.com

ISBN 978-602-6834-64-5



Ramadiani
Achmad N. H.
Azainil

Heliza R. H.
Dyna M. K.
Septya M.

MODEL DAN BENTUK PENELITIAN E-LEARNING
MENGUNAKAN STRUCTURAL EQUATION MODEL



**MODEL DAN BENTUK
PENELITIAN
E-LEARNING
MENGUNAKAN
STRUCTURAL EQUATION
MODEL**

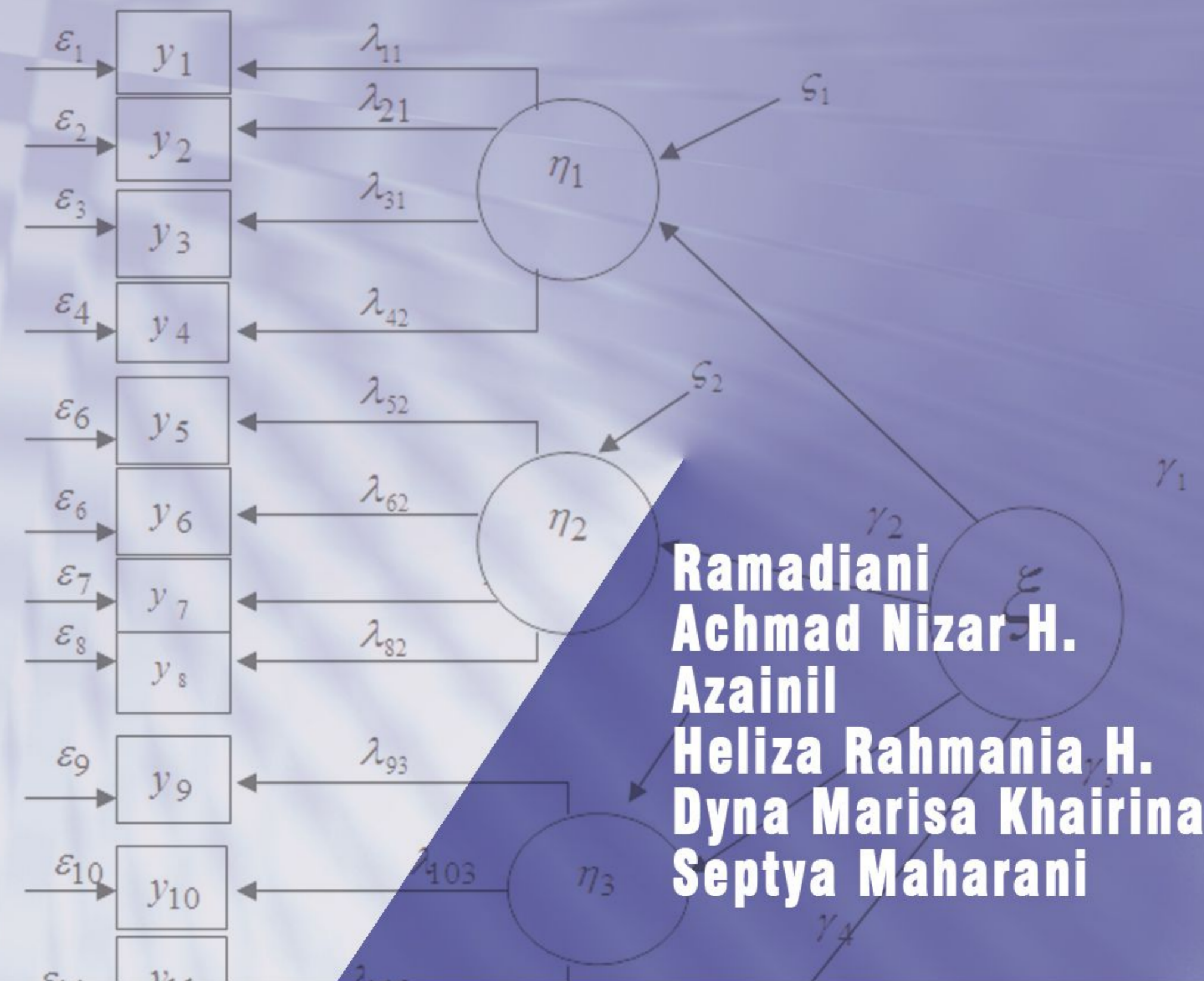

**Ramadiani
Achmad Nizar H.
Azainil
Heliza Rahmania H.
Dyna Marisa Khairina
Septya Maharani**



Mulawarman
University PRESS

MODEL DAN BENTUK
**PENELITIAN
E-LEARNING**
MENGUNAKAN
**STRUCTURAL EQUATION
MODEL**

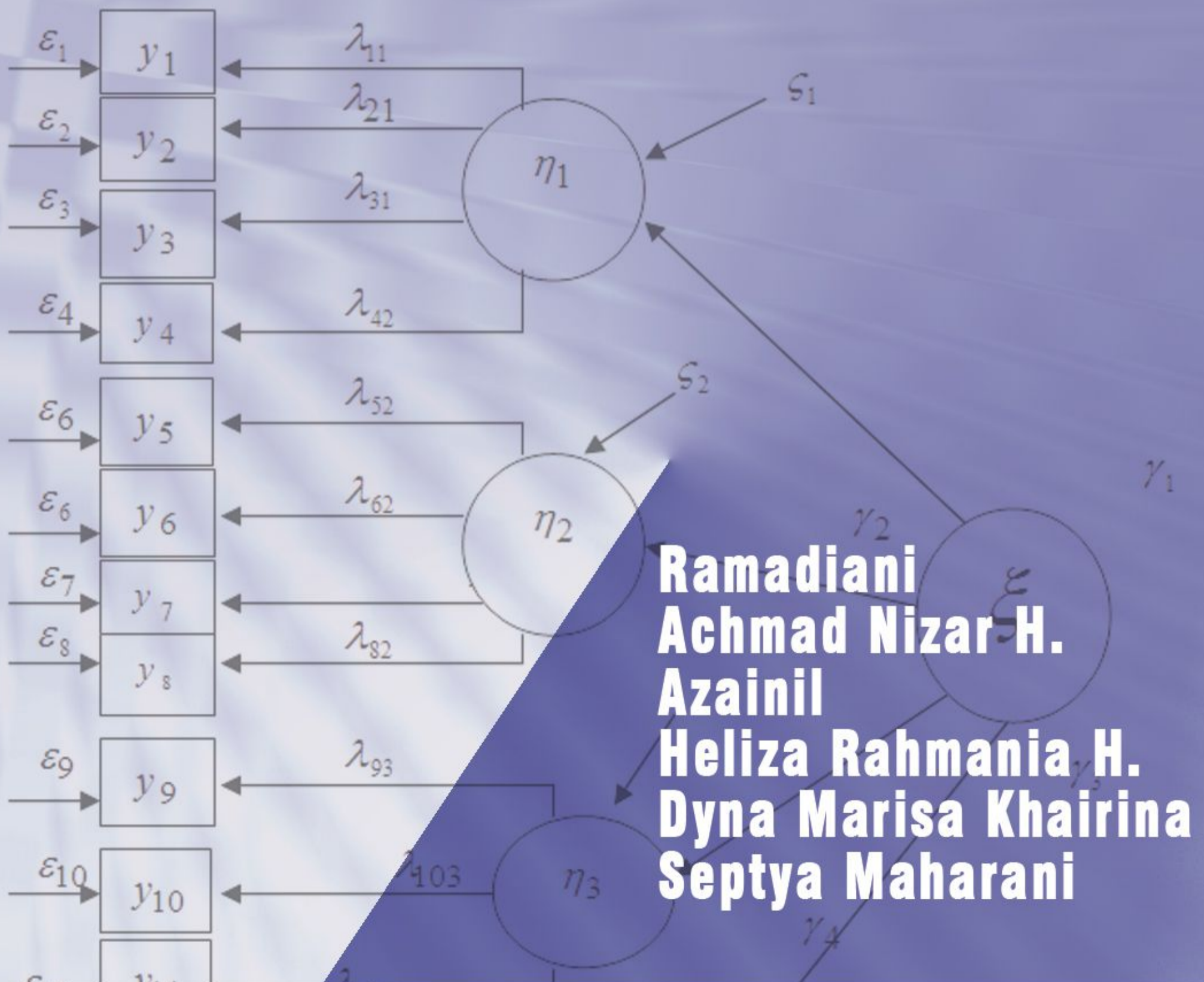

**Ramadiani
Achmad Nizar H.
Azainil
Heliza Rahmania H.
Dyna Marisa Khairina
Septya Maharani**

Ramadiani
Achmad N. H.
Azaini

Heliza R. H.
Dyna M. K.
Septya M.

**MODEL DAN BENYUK PENELITIAN E-LEARNING
MENGUNAKAN STRUKTURAL EQUATION MODEL**





**Mulawarman
University PRESS**

MODEL DAN BENTUK PENELITIAN E-LEARNING MENGUNAKAN STRUCTURAL EQUATION MODEL

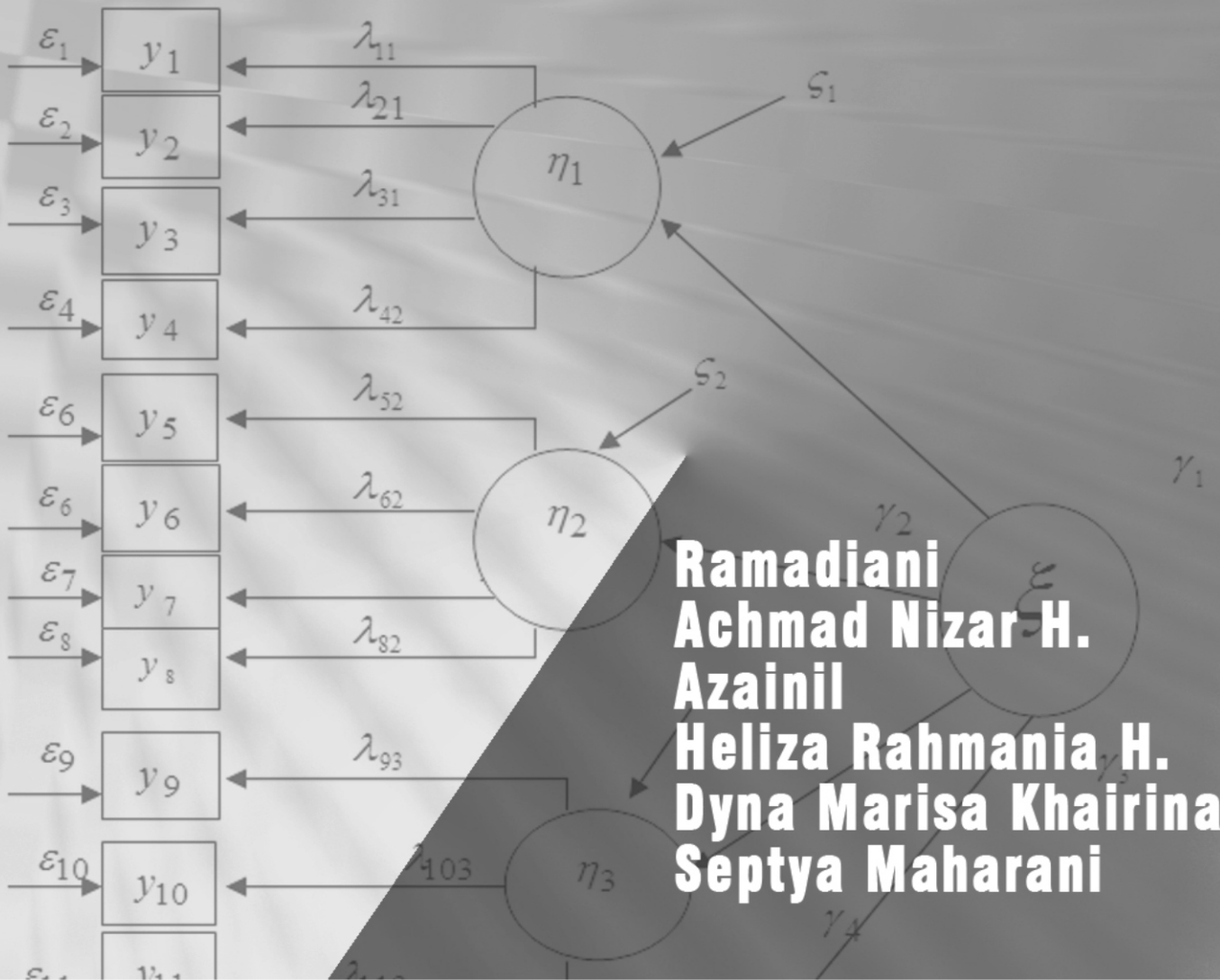

**Ramadiani
Achmad Nizar H.
Azainil
Heliza Rahmania H.
Dyna Marisa Khairina
Septya Maharani**

MODEL dan BENTUK PENELITIAN E-LEARNING MENGUNAKAN STRUCTURAL EQUATION MODEL

Penulis : Ramadiani
Achmad Nizar H.
Azainil
Heliza Rahmania H.
Dyna Marisa Khairina
Septya Maharani

Penata Letak : Ramadiani

Cover Design : Didik Dwi Jayanto

ISBN : 978-602-6834-64-5
© 2018. Mulawarman University Press

Cetakan Pertama : September 2018

Hak Cipta Dilindungi Undang-Undang
Dilarang memperbanyak atau memindahkan sebagian atau seluruh isi buku ini dalam bentuk apapun
tanpa izin tertulis dari penerbit

Isi diluar tanggung jawab percetakan.

Ramadiani., *et al.* 2018. Teknologi Konservasi Tanah dan Alr. Mulawarman University Press.
Samarinda.



**Mulawarman
University PRESS**

Penerbit

Mulawarman University PRESS

Gedung LP2M Universitas Mulawarman Jl. Krayan, Kampus Gunung Kelua

Samarinda – Kalimantan Timur – INDONESIA 75123 Telp/Fax (0541) 747432, Email :

mup.unmul@gmail.com

DAFTAR ISI

DAFTAR ISI	
PRAKATA	
BAB I. PENDAHULUAN.....	4
BAB II. SEKILAS MENGENAI PENELITIAN.....	5
BAB III. STRUCTURAL EQUATION MODEL (SEM).....	7
1. Variabel Laten.....	7
2. Variabel Teramati.....	8
3. Model Struktural.....	8
4. Model Pengukuran.....	9
5. Kesalahan Struktural.....	9
6. Kesalahan Pengukuran.....	9
7. Model Umum SEM.....	10
8. Submodel SEM.....	11
BAB IV. <i>Linear Structural RELations</i> (LISREL).....	14
1. Spesifikasi Model.....	15
2. Hipotesa Penelitian.....	20
3. Populasi dan Sampel.....	22
4. Contoh Questioner.....	22
5. Metode Pengolahan Data.....	23
BAB V. IMPLEMENTASI MODEL.....	29
1. Penyiapan Data.....	29
2. Memasukan Data Mentah.....	30
3. Menentukan Jenis Data.....	32
4. Membuat Matriks Covarian dan Matriks Correlation.....	33
5. Screening Data	34
6. Pengolahan Data	41
7. Estimasi Model Dengan Menggunakan Metode ML.....	43
8. Model Awal.....	45
9. Model Akhir.....	53
10. Pembahasan.....	62
11. Penilaian Indikator Statistik GOF model Awal dan Model Akhir	67
12. Penghitungan Nilai Variabel UIS.....	70
BAB VI PENUTUP.....	73
DAFTAR PUSTAKA	73
CURRICULUM VITAE AUTHOR.....	74
Lampiran 1. Contoh Proposal Hibah DIKTI	75
Lampiran 2. Contoh Proposal Pengabdian Pada Masyarakat.....	98
Lampiran 3. <i>Jurnal International terindeks SCOPUS</i>	104
Lampiran 4 Paper International Conference Elsevier.....	130
Lampiran 5 Laporan Penelitian.....	138

PRAKATA

Puji syukur ke hadirat Allah SWT. yang senantiasa memberikan petunjuk dan kemudahan untuk menyelesaikan penulisan Buku berjudul Model dan Bentuk Penelitian e-Learning Menggunakan Structural Equation Model” telah selesai dibuat dan diterbitkan. Penulisan Buku Ajar ini bertujuan untuk mengajarkan dan menjelaskan bagaimana membangun model penelitian e-learning maupun mobile learning sebelum direkomendasikan untuk pengembangan prototype dan konten e-learning. Penelitian ini didanai oleh Direktorat Penelitian dan Pengabdian Masyarakat, Direktorat Jenderal Penelitian dan Pengembangan Kementerian Riset, Teknologi, dan Pendidikan Tinggi Republik Indonesia sesuai dengan Kontrak Penelitian No.146/UN17.41/KL.2018. Melalui prakata ini, Penulis ingin mengucapkan banyak terimakasih kepada:

1. Direktorat Jenderal Pendidikan Tinggi, Kementerian Riset Teknologi Dan Pendidikan Tinggi Republik Indonesia.
2. Bapak Dr. Achamd Nizar Hidayanto, M.Kom sebagai Peneliti Pengarah dari Fakultas Ilmu Komputer Universitas Indonesia.
3. Rektor Universitas Mulawarman.
4. Ketua LP2M Universitas Mulawarman.
5. Dekan Fakultas Ilmu Komputer dan Teknologi Infrmasi Universitas Mulawarman.
6. Dekan Fakultas Ilmu Komputer, Universitas Indonesia
7. Keluarga tercinta
8. Semua Dosen dan Staf di Fakultas Ilmu Komputer dan Teknologi Informasi Universitas Mulawarman
9. Semua Dosen, Pustakawan dan staf di Fakultas Ilmu Komputer, Universitas Indonesia.

Penulis menyadari sepenuhnya bahwa penulisan laporan kemajuan ini masih belum sempurna, untuk itu segala saran sangat diharapkan demi kesempurnaan penyusunan Buku ajar ini.

BAB I.

PENDAHULUAN

Siapa bilang penelitian menggunakan statistik sulit? bagaimana menentukan jenis penelitian yang sesuai? bagaimana menetapkan variabel dalam penelitian? Data seperti apa yang kita butuhkan? Bagaimana mengumpulkan data? Bagaimana menentukan metode pengukuran yang cocok, jika ternyata data dalam penelitian yang kita pilih memiliki variabel yang bertingkat? Bagaimana kita dapat mengetahui kalau variabel dan metode pengukuran yang kita pilih telah sesuai dengan data penelitian? Seberapa besar tingkat ketepatan dan tingkat kesalahan dalam pengukuran?

Semua pertanyaan di atas akan coba dijawab dalam buku ini secara ringkas, padat dan jelas serta dilengkapi dengan contoh kasus penelitian yang menggunakan SEM dan LISREL tentunya. Sesuai dengan judul buku kita " LISREL dan Structural Equation Model untuk Penelitian yang menggunakan Variabel Bertingkat ". Kasus dalam buku ini diambil dari berbagai hasil penelitian e-Learning dari proposal penelitian hibah DIKTI (PPD), propoasal pengabdian pada masyarakat (PKM) dan paper publikasi di jurnal International dan international conference yang terindeks SCOPUS. Selamat membaca...

BAB II.

SEKILAS MENGENAI PENELITIAN

Metode penelitian merupakan urutan bagaimana suatu penelitian dikerjakan, dengan alat apa, dan bagaimana prosedurnya. Prosedur penelitian diawali dengan menentukan jenis penelitian, menentukan subjek dan objek penelitian, penentuan populasi atau sampel agar dapat ditentukan alat pengambilan data yang sesuai, selanjutnya data dianalisis dan ditafsirkan secara deskriptif dan pembuktian hipotesa sebagai hasil penelitian.

Secara umum terdapat dua jenis penelitian yaitu penelitian kualitatif dan kuantitatif. Penelitian kualitatif menurut bertujuan untuk mendapatkan gambaran seutuhnya mengenai suatu hal menurut pandangan manusia yang diteliti. Penelitian kualitatif berhubungan dengan ide, persepsi, pendapat, kepercayaan orang yang diteliti, tentang suatu topik. Hal tersebut tidak selayaknya diukur dengan angka dan tidak dapat ditetapkan sebelumnya dengan jelas dan pasti. Karena itu dalam penelitian kualitatif, peneliti termasuk alat peneliti yang utama. Dan sebagai alat peneliti, ia dapat dengan luwes menyesuaikan diri dengan bermacam situasi di lapangan.

Pengertian mengenai penelitian kuantitatif adalah penelitian yang memusatkan perhatian beberapa hal yang lebih nyata, yang dapat diukur dengan angka dan berusaha mengerti hal yang diteliti dengan melakukan pengukuran (frekuensi dan intensitas variabel). Penelitian kuantitatif dilakukan bila seseorang ingin membuktikan sesuatu, yaitu menunjukkan keberadaan suatu variabel, menunjukkan hubungan antara variabel, membuktikan suatu teori. Karena itu peneliti harus merencanakan dengan terperinci dan pasti proses dan alat pengumpulan data dan juga sample yang akan diteliti, berdasarkan teoritis (konsep dan hubungan antar konsep) dan definisi operasional hanya memusatkan pada bagian yang hendak diteliti dan dalam bentuk yang hendak diterapkan peneliti dan dapat diukur dengan angka.

Karena sering ditemukannya kesulitan di dalam berbagai penelitian ilmu sosial terutama dalam merumuskan suatu model kausal. Di mana konsep dan gagasan yang mereka hadapi biasanya berkenaan dengan pengukuran secara tidak langsung. Penelitian yang berhubungan dengan behavior atau perilaku, yang kita ambil sebagai contoh kasus untuk penulisan buku ini yaitu kepuasan pengguna. Tentu saja kepuasan pengguna tidak bisa diukur secara langsung melainkan harus diukur melalui beberapa indikator yang berhubungan erat dengan variabel tersebut. Persoalan semacam ini sering disebut dengan variabel laten, yakni suatu variabel yang tidak dapat diukur secara langsung. Variabel ini dalam operasionalisasinya diamati melalui beberapa indikatornya. Setiap indikator berhubungan dengan variabel laten. Dengan menggunakan beberapa indikator untuk setiap variabel laten maka akan didapatkan gambaran sesungguhnya tentang variabel laten tersebut.

Alasan lain penggunaan variabel laten dalam studi ilmu sosial adalah bahwa sebagian besar alat ukur yang digunakan mengandung kesalahan pengukuran (kesalahan pengamatan). Kesalahan pengukuran ini muncul karena tidak sempurnanya variasi instrumen pengukuran, yang digunakan untuk mengukur seperti perilaku seseorang, sikap, persepsi, perasaan dan motivasi. Walaupun dapat membuat alat ukur yang valid untuk persoalan-persoalan tersebut, namun biasanya tidak mungkin mendapatkan peubah-peubah yang sempurna reliabilitasnya.

BAB III.

STRUCTURAL EQUATION MODEL (SEM)

SEM adalah singkatan dari model persamaan struktural (*structural equation model*) yang merupakan generasi kedua teknik analisis multivariate yang memungkinkan peneliti untuk menguji hubungan antara variabel yang kompleks baik *recursive* maupun *non-recursive* untuk memperoleh gambaran menyeluruh mengenai suatu model. Tidak seperti analisis multivariate biasa (regresi berganda dan analisis faktor). SEM dapat melakukan pengujian secara bersama-sama (Bollen, 1989), yaitu: model struktural yang mengukur hubungan antara *independent* dan *dependent construct*, serta model *measurement* yang mengukur hubungan (nilai *loading*) antara variabel indikator dengan konstruk (variabel laten). Dengan digabungkannya pengujian model struktural dan pengukuran tersebut memungkinkan peneliti untuk;

- 1). Menguji kesalahan pengukuran (*measurement error*) sebagai bagian yang tak terpisahkan dari *structural equation model*.
- 2). Melakukan analisis faktor bersamaan dengan pengujian hipotesis.

Dalam model persamaan struktural (SEM) mengandung 2 jenis variabel yaitu variabel laten dan variabel teramati, 2 jenis model yaitu model struktural dan model pengukuran serta 2 jenis kesalahan yaitu kesalahan struktural dan kesalahan pengukuran. Dan untuk memperoleh gambaran umum tentang dua jenis variabel, dua jenis model dan dua jenis kesalahan, di bawah ini akan dijelaskan secara ringkas model, variabel dan kesalahan tersebut :

1. Variabel Laten

Dalam model persamaan struktural, variabel yang menjadi kunci perhatian adalah variabel laten. Variabel laten merupakan konsep psikologi abstrak seperti perilaku orang, sikap (*attitude*), perasaan dan motivasi. Variabel laten hanya dapat diamati secara tidak langsung dan tidak sempurna melalui efeknya pada variabel teramati. Suatu metode

LISREL mempunyai dua variabel laten yaitu eksogen dan endogen. Variabel eksogen ditandai dengan huruf Yunani ξ ("ksi") dan variabel laten endogen ditandai dengan huruf Yunani η ("eta"). Kedua jenis ini dibedakan berdasarkan atas keikutsertaannya sebagai variabel terikat pada persamaan dari model. Variabel eksogen selalu muncul sebagai variabel bebas pada semua persamaan yang ada. Sedangkan persamaan endogen merupakan variabel terikat paling sedikit satu persamaan dalam model, di semua persamaan sisanya variabel tersebut adalah variabel bebas. Dimensi variabel laten endogen η adalah $m \times 1$, sedangkan variabel laten eksogen ξ adalah $n \times 1$.

2. Variabel Teramati

Variabel teramati (indikator), yang merupakan ukuran atau nilai sebenarnya, yang digunakan untuk menghubungkan variabel laten dengan riil. Variabel teramati yang berkaitan dengan variabel eksogen diberi label X dan berdimensi $q \times 1$, sedangkan yang berhubungan dengan variabel endogen diberi label Y dan berdimensi $p \times 1$. Di luar itu tidak ada perbedaan fundamental di antara keduanya, dan suatu ukuran dengan label X dalam satu model bisa diberi label Y pada model yang lain.

3. Model Struktural

Model struktural menggambarkan beberapa hubungan yang ada di antara variabel laten. Hubungan ini umumnya linier, meskipun tidak menutup kemungkinan untuk mengikutsertakan hubungan non-linear. Parameter yang menunjukkan regresi variabel laten endogen pada variabel eksogen diberi label dengan huruf Yunani γ ("gamma") dan ditulis dalam bentuk matriks Γ yang berdimensi $m \times n$. Sedangkan parameter regresi variabel laten endogen pada variabel laten endogen yang lainnya diberi huruf β ("beta") dan ditulis dalam matriks B yang berdimensi $m \times m$.

4. Model Pengukuran

Dalam model persamaan struktural atau LISREL, setiap variabel laten biasanya berkaitan dengan ukuran atau variabel ganda. Pengguna model persamaan struktural paling sering menghubungkan variabel laten dengan variabel teramati melalui model pengukuran analisis faktor. Dalam model ini setiap variabel laten dimodelkan sebagai sebuah faktor yang mendasari beberapa variabel teramati yang terkait. "Muatan faktor" atau "*factor loading*" yang menghubungkan variabel laten dengan variabel yang diamati diberi label dengan huruf Yunani λ ("lambda") dan ditulis dalam bentuk matrik Λ . Model persamaan struktural biasanya mengandung dua matriks lambda yang berbeda yaitu satu matrik Λ_x pada sisi X dengan dimensi $q \times n$ dan matrik Λ_y pada sisi Y dengan dimensi $p \times m$. Model pengukuran paling umum dalam aplikasi ini ialah model pengukuran kon-generik, dimana setiap ukuran atau variabel yang teramati hanya berhubungan dengan satu variabel laten dan semua kovariansi antara beberapa ukuran adalah sebagai akibat dari hubungan antara ukuran dan variabel laten.

5. Kesalahan Struktural

Pada umumnya pengguna model persamaan struktural tidak dapat berharap bahwa variabel bebas dapat memprediksi secara sempurna variabel terikat, sehingga pada suatu model biasanya ditambahkan komponen kesalahan struktural. Kesalahan struktural ini diberi label dengan huruf Yunani ζ (zeta) yang mempunyai dimensi $m \times 1$. Untuk memperoleh estimasi yang konsisten kesalahan struktural ini diasumsikan tidak berkorelasi dengan variabel laten eksogen (ξ) dari model.

6. Kesalahan Pengukuran

Dalam model persamaan struktural, ukuran atau variabel teramati tidak dapat secara sempurna menggambarkan variabel laten terkait yang mendasarinya. Untuk memodelkan ketidak sempurnaan ini dilakukan

penambahan ke dalam model persamaan struktural yang disebut kesalahan pengukuran. Dalam konteks analisis faktor komponen kesalahan pengukuran ini adalah faktor yang unik berkaitan dengan setiap ukuran atau variabel teramati. Komponen kesalahan pengukuran yang berkaitan dengan variabel teramati X diberi label dengan huruf Yunani δ ("delta") dan berdimensi $q \times 1$, sedangkan yang berkaitan dengan variabel Y diberi label dengan huruf Yunani ε ("epsilon") dan berdimensi $p \times 1$.

Secara konseptual, hampir semua variabel teramati mempunyai komponen kesalahan pengukuran terkait. Meskipun demikian, ketika sebuah variabel laten hanya berhubungan dengan sebuah variabel teramati tunggal maka biasanya tidak dimungkinkan melakukan estimasi besarnya kesalahan pengukuran yang terkait. Dalam kasus ini dipilih 2 alternatif yaitu: pertama, kesalahan pengukuran harus dispesifikasi terlebih dahulu sebelum melakukan estimasi parameter dan kesalahan pengukuran dapat dianggap tidak ada atau nol.

7. Model Umum SEM

Model persamaan struktural secara umum dapat dinyatakan sebagai berikut: misalnya : $\eta = (\eta_1, \eta_2, \dots, \eta_m)$ dan $\xi = (\xi_1, \xi_2, \dots, \xi_n)$ berturut-turut adalah vektor peubah laten tak bebas (independent laten variabel) dan peubah laten bebas (dependent laten variabel). Hubungan linear strukturalnya adalah sebagai berikut:

$$\eta = B\eta + \Gamma\xi + \zeta \quad (1)$$

dimana B adalah matriks berukuran $m \times m$ dan Γ adalah matriks yang berukuran $m \times n$, yang keduanya merupakan matriks koefisien. Sedangkan $\zeta = (\zeta_1, \zeta_2, \dots, \zeta_m)$ adalah vektor sisaan acak. Tanpa mengurangi sifat umum dari model, dapat diasumsikan bahwa $E(\eta) = E(\xi) = 0$ dan $E(\zeta) = 0$. Selanjutnya diasumsikan pula bahwa ζ tidak berkorelasi dengan ξ dan $(I - B)$ tak singular. Vektor-vektor η dan ξ tidak dapat diamati secara langsung, namun demikian sebagai penggantinya adalah vektor-

vektor $y' = (y_1, y_2, \dots, y_p)$ dan $x' = (x_1, x_2, \dots, x_q)$ dan yang diamati secara langsung, sehingga:

$$y = \Lambda_y \eta + \varepsilon \quad (2)$$

$$x = \Lambda_x \xi + \delta \quad (3)$$

dimana ε dan δ adalah vektor kesalahan pengukuran bagi y dan x . Diambil y dan x sebagai vektor-vektor pengamatan yang terkoreksi terhadap rataannya. Matriks-matriks Λ_y berukuran $p \times m$ dan Λ_x berukuran $q \times n$ berturut-turut adalah merupakan matriks-matriks regresi y pada η dan x pada ξ . Hal ini sesuai dengan y dan x sebagai variabel amatan dan η serta ξ sebagai variabel laten. Vektor kesalahan pengukuran ε dan δ dianggap tidak berkorelasi satu sama lain, serta tidak berkorelasi dengan variabel laten.

Tabel 3.1. Model Umum SEM dalam LISREL

No	Model Struktural	Model Pengukuran	Asumsi
1.	$\eta = \beta\eta + \Gamma\xi + \zeta$	Model pengukuran untuk y $y = \Lambda_y \eta + \varepsilon$	ζ tidak berkorelasi dng ξ
2.		Model pengukuran untuk x $x = \Lambda_x \xi + \delta$	ε tidak berkorelasi dng η
3.			δ tidak berkorelasi dng ξ
4.			$\zeta, \varepsilon, \delta$ tidak saling berkorelasi
5.			I - B adalah non-singular

8. Submodel SEM

Model umum SEM dalam LISREL mengandung 4 jenis variabel yaitu variabel y , x , η dan ξ , disamping variabel kesalahan ζ , ε dan δ . Model umum ini terdiri dari beberapa sub model sebagai kasus khusus. Sebuah submodel akan didapat jika satu atau lebih variabel y , x , η dan ξ adalah nol. Hal ini berarti satu atau lebih dari keempat jenis variabel tersebut tidak ikut dalam model. Bagi pemakai atau peneliti yang berkepentingan dengan submodel tertentu, hanya perlu memahami submodel

bersangkutan dan tak perlu mengerti model secara keseluruhan atau *full model*. Beberapa alternatif pilihan submodel yang terdapat dalam LISREL dapat dilihat dalam tabel di bawah ini.

Tabel 3. 2. Beberapa submodel dalam LISREL

- Submodel 1, model LISREL dengan hanya variabel x & ξ .

$$x = \Lambda_x \xi + \delta$$
- Submodel 2, model LISREL dengan hanya variabel y & x .

$$y = B_y + \Gamma_x + \zeta$$
- Submodel 3A, model LISREL dengan hanya variabel y, η & ξ .

$$\eta = B\eta + \Gamma\xi + \zeta$$

$$y = \Lambda_y \eta + \varepsilon$$
- Submodel 3B, model LISREL dengan hanya variabel y dan η .

$$y = \Lambda_y \eta + \varepsilon$$

$$\eta = B\eta + \zeta$$

SEM dianggap sebagai suatu alat statistik yang sangat berguna bagi penelitian sosial, sehingga SEM menjadi suatu keharusan untuk penelitian non-eksperimental, dimana metode untuk pengujian teori belum dikembangkan secara menyeluruh (Bentler,1980). Software yang menawarkan SEM antara lain adalah; LISREL (Joreskoq, 1996), AMOS (Arbuckle, 1995), EQS (Bentler,1995), ROMANO (Browne, 1994), SEPATH (Steiger,1994), dan LISCOM (Muthen, 1988).

Tabel 3.3. Keterangan Simbol Path Diagram

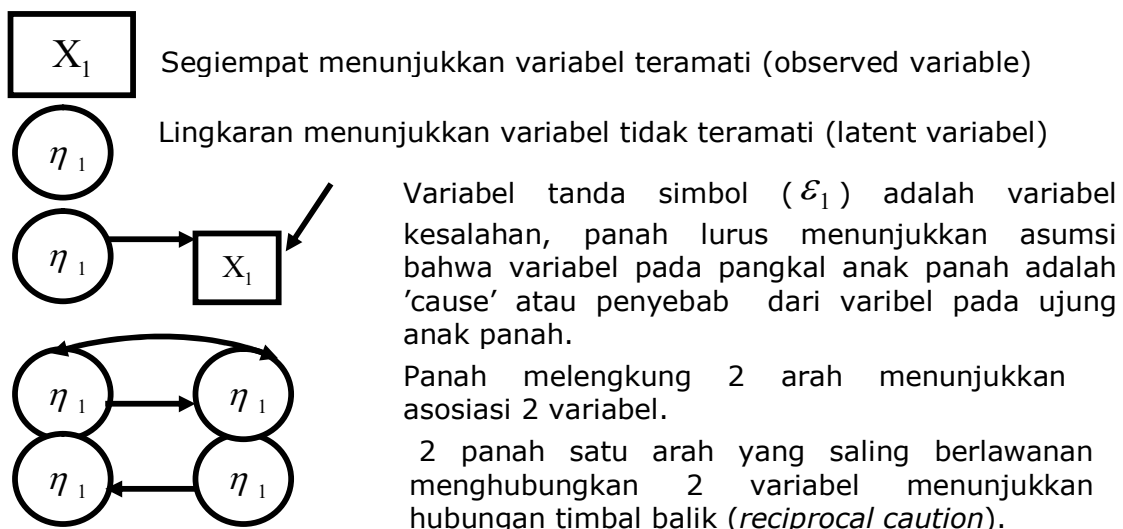

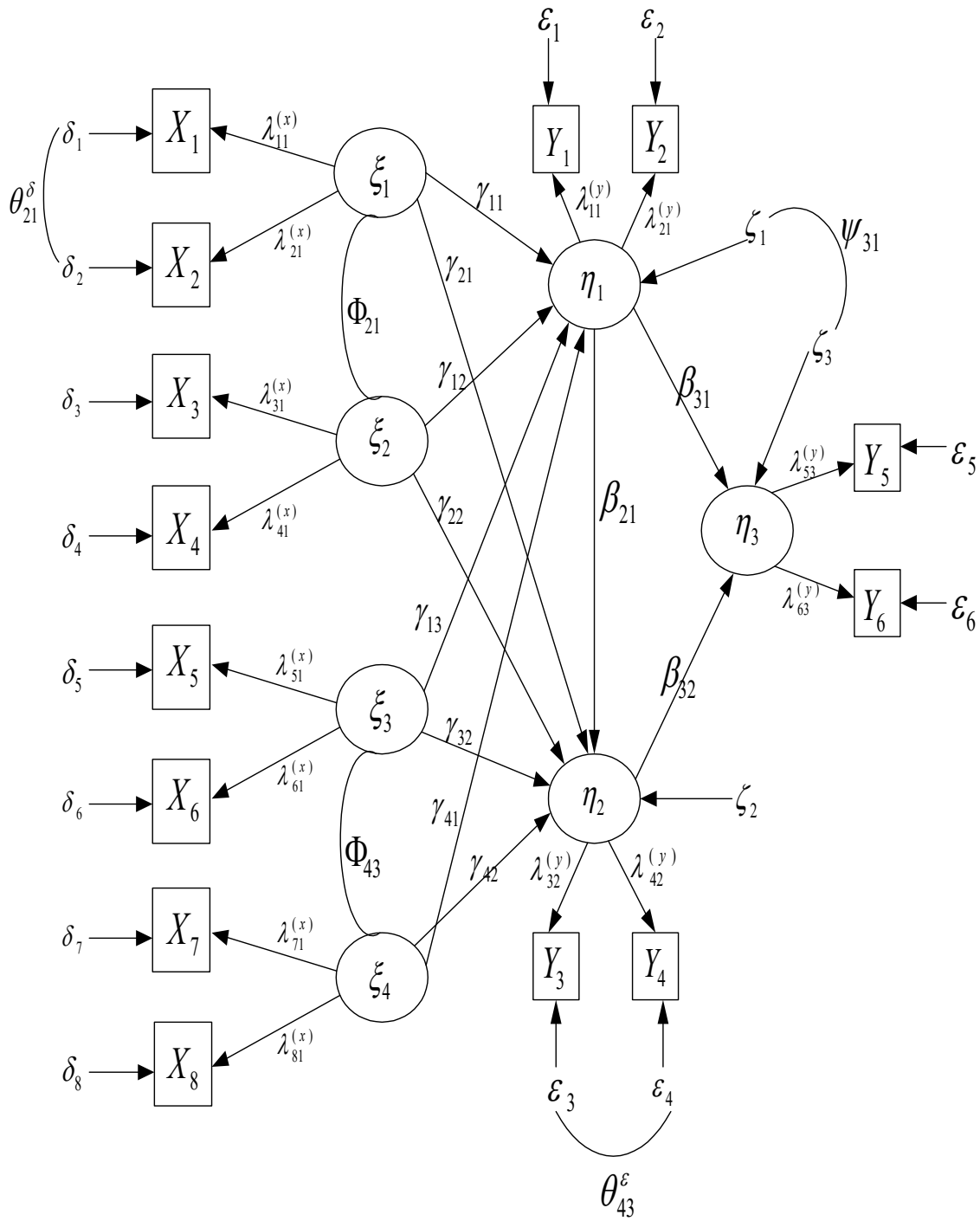

Gambar 3.1. Model Diagram Path LISREL

BAB IV.

Linear Structural RELations (LISREL)

LISREL adalah merupakan singkatan dari *Linear Structural RELations*, yakni salah satu software yang digunakan untuk mengukur hubungan struktural linier antara variabel laten dan variabel teramati dalam model matematika, dimana data yang diukur bisa bersifat skala kontinu dan ordinal. Model ini merupakan perkembangan dari permodelan persamaan ganda atau SEM yang berkaitan dengan beberapa prinsip pengukuran dibidang ilmu ekonomi, sosial dan psikologi (Hair,et.al.(1995)). Model persamaan struktural ini sebagian besar digunakan untuk menangani persoalan dengan variabel laten.

LISREL tidak saja sebagai sebuah program komputer yang menganalisis *covarian structures* tetapi juga sebagai metode yang umumnya dipakai untuk menganalisa *causal hypotheses* pada data berbasis non-experimental. Selain sering digunakan dalam menganalisa data dibidang sosiologi, psikologi, ekonomi, juga dapat digunakan pada penelitian di bidang informatika.

LISREL memiliki bahasa pemrograman yang relative sederhana, mudah untuk dipahami dan tertib yaitu; Syntax SIMPLIS dan Syntax PRELIS. Selain itu LISREL bersifat informatif dalam menyajikan data-data statistik dengan dilengkapi diagram path, sehingga modifikasi model dan penilaian tidak fitnya suatu model atau buruknya suatu model dapat dengan mudah diketahui.

Adapun langkah dalam prosedur model persamaan struktural atau LISREL secara umum menurut Bollen (1993) adalah bersifat sebagai berikut:

a. Spesifikasi model

Langkah ini berkaitan dengan pembentukan model persamaan struktural awal, sebelum dilakukan estimasi. Model awal ini diformulasikan berdasarkan suatu teori atau penelitian sebelumnya.

b. Identifikasi

Langkah ini berkaitan dengan pengkajian tentang kemungkinan diperolehnya nilai yang unik untuk setiap parameter di dalam model.

c. Estimasi

Langkah ini berkaitan dengan estimasi yang dilakukan terhadap model yang menggunakan salah satu model estimasi yang tersedia. Pemilihan model estimasi seringkali ditentukan berdasarkan karakteristik dari variabel yang dianalisis. Pilihan model estimasi; WLS, ML, GLS, dll.

d. Uji kecocokan

Langkah ini berkaitan dengan pengujian kecocokan antara model dengan data. Beberapa kriteria ukuran kecocokan, chi-square atau goodness of fit (GOF) dapat digunakan untuk penelitian ini.

e. Respesifikasi

Langkah ini berkaitan dengan respesifikasi model berdasarkan atas hasil uji kecocokan. Pelaksanaan langkah ini tergantung kepada strategi pemodelan yang digunakan. Jika strategi pemodelan yang dipilih adalah konfirmatori, maka prosedur untuk model persamaan strukturalnya berhenti sampai dengan langkah keempat dan respesifikasi tidak diperlukan. Jika strategi pengembangan model yang dipilih maka perubahan terhadap model awal dilakukan dan langkah kesatu sampai dengan keempat diulangi sampai diperoleh model dengan kecocokan yang baik.

1. Spesifikasi Model

Variabel adalah apa yang kita tatap dalam penelitian sebagai objek penelitian, apa yang nanti akan menjadi objek pengamatan dalam penelitian. Variabel penelitian disebut juga sebagai faktor yang berperan dalam peristiwa atau gejala yang akan diteliti. Operasional variabel berkaitan dengan pemberian arti kepada sebuah variabel dengan menspesifikasikan aktifitas atau operasi yang diperlukan. Dengan menetapkan angka terhadap setiap aktifitas atau kejadian dari variabel

tersebut sesuai aturan tertentu, maka pengukuran terhadap variabel tersebut dapat dilakukan.

Terdapat beberapa faktor yang perlu disiapkan dalam rangka pengujian hipotesa suatu penelitian, untuk menarik kesimpulan atas permasalahan yang akan diteliti. Misalnya dalam penelitian kepuasan pengguna terhadap informasi, secara garis besar yang dimaksud dengan variabel dalam penelitian seperti ini adalah:

- @ Variabel laten terikat (η_1) : Kualitas layanan
- @ Variabel laten terikat (η_2) : Kualitas informasi,
- @ Variabel laten terikat (η_3) : Pengetahuan & keterlibatan pengguna
- @ Variabel laten terikat (η_4) : Manfaat informasi.
- @ Variabel laten bebas (ξ) : Kepuasan Pengguna

Berdasarkan variabel yang dimiliki oleh permasalahan di atas, kita bisa menetapkan bahwa Model kepuasan pengguna adalah model *Second Order Confirmatory Factor Analysis* (2ndCFA), karena terdapat 2 tingkat variabel laten yaitu: 4 variabel laten tingkat pertama yang mewakili kualitas layanan, kualitas informasi, pengetahuan & keterlibatan pengguna serta manfaat informasi, dan 1 variabel laten tingkat ke 2 yaitu: kepuasan pengguna.

Sehingga model persamaan struktural yang akan dipakai dalam penelitian ini nanti adalah Submodel 3A atau model LISREL dengan hanya variabel y , η dan ξ sebagai berikut:

$$\eta = \Gamma\xi + \zeta \quad y = \Lambda_y\eta + \varepsilon$$

dimana: $y' = (y_1, y_2, \dots, y_{13})$ $\eta' = (\eta_1, \eta_2, \dots, \eta_4)$ $\xi = \xi_1$

$$\zeta' = (\zeta_1, \zeta_2, \zeta_3, \zeta_4) \quad \varepsilon' = (\varepsilon_1, \varepsilon_2, \dots, \varepsilon_{13})$$

$$A_y = \begin{bmatrix} \lambda_{11} & 0 & 0 & 0 \\ \lambda_{21} & 0 & 0 & 0 \\ \lambda_{31} & 0 & 0 & 0 \\ \lambda_{41} & 0 & 0 & 0 \\ 0 & \lambda_{52} & 0 & 0 \\ 0 & \lambda_{62} & 0 & 0 \\ 0 & \lambda_{72} & 0 & 0 \\ 0 & \lambda_{82} & 0 & 0 \\ 0 & 0 & \lambda_{93} & 0 \\ 0 & 0 & \lambda_{103} & 0 \\ 0 & 0 & \lambda_{113} & 0 \\ 0 & 0 & 0 & \lambda_{124} \\ 0 & 0 & 0 & \lambda_{134} \end{bmatrix} \quad \Gamma = \begin{bmatrix} \gamma_{11} \\ \gamma_{21} \\ \gamma_{31} \\ \gamma_{41} \end{bmatrix}$$

$$\begin{bmatrix} Y_1 \\ Y_2 \\ Y_3 \\ Y_4 \\ Y_5 \\ Y_6 \\ Y_7 \\ Y_8 \\ Y_9 \\ Y_{10} \\ Y_{11} \\ Y_{12} \\ Y_{13} \end{bmatrix} = \begin{bmatrix} \lambda_{11} & 0 & 0 & 0 \\ \lambda_{21} & 0 & 0 & 0 \\ \lambda_{31} & 0 & 0 & 0 \\ \lambda_{41} & 0 & 0 & 0 \\ 0 & \lambda_{52} & 0 & 0 \\ 0 & \lambda_{62} & 0 & 0 \\ 0 & \lambda_{72} & 0 & 0 \\ 0 & \lambda_{82} & 0 & 0 \\ 0 & 0 & \lambda_{93} & 0 \\ 0 & 0 & \lambda_{103} & 0 \\ 0 & 0 & \lambda_{113} & 0 \\ 0 & 0 & 0 & \lambda_{124} \\ 0 & 0 & 0 & \lambda_{134} \end{bmatrix} \left[\begin{bmatrix} \Gamma_1 \\ \Gamma_2 \\ \Gamma_3 \\ \Gamma_4 \end{bmatrix} \xi_1 + \begin{bmatrix} \varsigma_1 \\ \varsigma_2 \\ \varsigma_3 \\ \varsigma_4 \end{bmatrix} \right] + \begin{bmatrix} \mathcal{E}_1 \\ \mathcal{E}_2 \\ \mathcal{E}_3 \\ \mathcal{E}_4 \\ \mathcal{E}_5 \\ \mathcal{E}_6 \\ \mathcal{E}_7 \\ \mathcal{E}_8 \\ \mathcal{E}_9 \\ \mathcal{E}_{10} \\ \mathcal{E}_{11} \\ \mathcal{E}_{12} \\ \mathcal{E}_{13} \end{bmatrix}$$

$$\begin{bmatrix} Y_1 \\ Y_2 \\ Y_3 \\ Y_4 \\ Y_5 \\ Y_6 \\ Y_7 \\ Y_8 \\ Y_9 \\ Y_{10} \\ Y_{11} \\ Y_{12} \\ Y_{13} \end{bmatrix} = \begin{bmatrix} \lambda_{11} (\Gamma_1 \xi_1 + \varsigma_1) \\ \lambda_{21} (\Gamma_1 \xi_1 + \varsigma_1) \\ \lambda_{31} (\Gamma_1 \xi_1 + \varsigma_1) \\ \lambda_{41} (\Gamma_1 \xi_1 + \varsigma_1) \\ \lambda_{52} (\Gamma_2 \xi_1 + \varsigma_2) \\ \lambda_{62} (\Gamma_2 \xi_1 + \varsigma_2) \\ \lambda_{72} (\Gamma_2 \xi_1 + \varsigma_2) \\ \lambda_{82} (\Gamma_2 \xi_1 + \varsigma_2) \\ \lambda_{93} (\Gamma_3 \xi_1 + \varsigma_3) \\ \lambda_{103} (\Gamma_3 \xi_1 + \varsigma_3) \\ \lambda_{113} (\Gamma_3 \xi_1 + \varsigma_3) \\ \lambda_{124} (\Gamma_4 \xi_1 + \varsigma_4) \\ \lambda_{134} (\Gamma_4 \xi_1 + \varsigma_4) \end{bmatrix} + \begin{bmatrix} \mathcal{E}_1 \\ \mathcal{E}_2 \\ \mathcal{E}_3 \\ \mathcal{E}_4 \\ \mathcal{E}_5 \\ \mathcal{E}_6 \\ \mathcal{E}_7 \\ \mathcal{E}_8 \\ \mathcal{E}_9 \\ \mathcal{E}_{10} \\ \mathcal{E}_{11} \\ \mathcal{E}_{12} \\ \mathcal{E}_{13} \end{bmatrix}$$

$$y = \Lambda_y(\Gamma\xi + \zeta) + \varepsilon$$

$$\Lambda_y(\Gamma\xi + \zeta) = y - \varepsilon$$

$$\Lambda_y = \frac{y - \varepsilon}{(\Gamma\xi + \zeta)}$$

$$Y_i = \lambda_{i1}(\Gamma_1\xi_1 + \zeta_1) + \varepsilon$$

dimana

$$\Lambda_y = \frac{y - \varepsilon}{(\Gamma\xi + \zeta)} \quad y = \Lambda_y(\Gamma\xi + \zeta) + \varepsilon$$

$$\varepsilon = y - \Lambda_y(\Gamma\xi + \zeta) \quad \Gamma = \frac{y - \varepsilon - \Lambda_y\zeta}{\Lambda_y\xi}$$

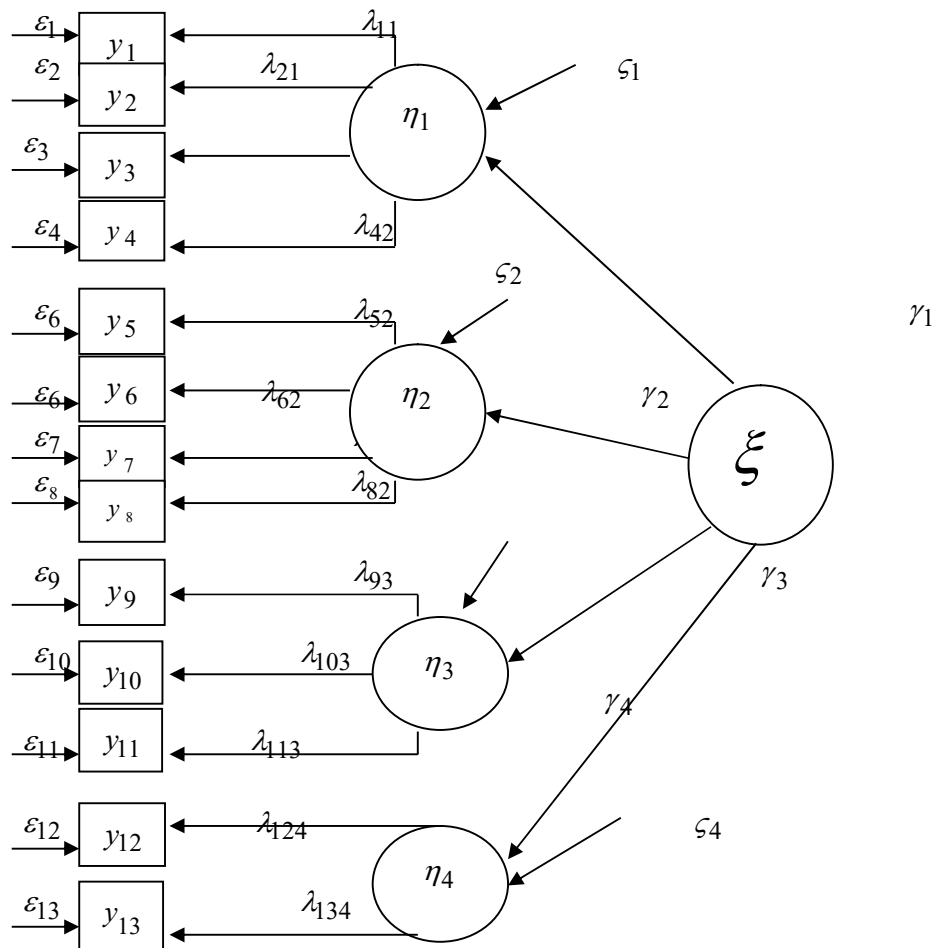

Gambar 4.1. Contoh Diagram lintas model kepuasan pengguna

keterangan Gambar 4.1

ξ = Kepuasan Informasi Pengguna (user information satisfaction).	y_5 = Kelengkapan (Completeness)
η_1 = Kualitas layanan (Servqual)	y_6 = Keterkaitan (Relevancy)
η_2 = Kualitas informasi (Infoqual)	y_7 = Ketepatan (Accuracy)
η_3 = Pengetahuan/keterlibatan pengguna (User)	y_8 = Kemutakhiran (Currency)
η_4 = Kegunaan (Usage)	y_9 = Pelatihan (Training_Provider)
y_1 = Sikap (Demeanor)	y_{10} = Pengetahuan (User_Understanding)
y_2 = Respon (Responsiveness)	y_{11} = Partisipasi (Participation)
y_3 = Kemampuan (Competence)	y_{12} = Memudahkan (Easier to the Job)
y_4 = Fasilitas pendukung (Tangible)	y_{13} = Meningkatkan produktifitas (Increase_Productivity)

Notasi LISREL:		Keterangan
q		Jumlah indikator variabel laten eksogenous
p		Jumlah indikator variabel laten edogenous
ξ		variabel laten eksogenous (n x 1)
η		variabel laten endogenous (m x 1)
ζ		kesalahan struktur pada variabel laten (m x 1)
\mathcal{E}		kesalahan pengukuran pada variabel teramati (p x 1)
X		indikator pada variabel eksogenous (q x 1)
Y		Indikator pada variabel endogenous (p x 1)
Model Struktural:		
B	β_{nm}	matriks koefisien dari variabel ξ dalam hubungan struktural
Γ	γ_{mn}	matriks koefisien dari variabel η dalam hubungan struktural
Φ	ϕ_{nn}	Matrik covarian dari ξ (n x n)
Ψ	ϕ_{mm}	Matrik covarian dari ζ (m x m)
Model Pengukuran:		
Λ_x	λ_{pm}^x	matriks dari koefisien regressi x pada ξ
Λ_y	λ_{qn}^y	matriks dari koefisien regressi y pada η
Θ_δ	δ_{qq}	Matriks covarian kesalahan δ
Θ_ε	ε_{pp}	Matriks covarian kesalahan ε

2. Hipotesa Penelitian

Model yang didefinisikan tersebut memberikan gambaran tentang hipotesa-hipotesa yang akan dilakukan dalam penelitian. Untuk setiap hipotesa penelitian akan didefinisikan ke dalam suatu hipotesa statistik yang diperlukan sebagai sarana pengujian hipotesa. Pengujian hipotesa statistik dilakukan melalui estimasi terhadap parameter γ dan λ yang terdapat pada penelitian model LISREL. Pada hipotesa statistik untuk H_0 jika parameter terkait sama dengan nol, sedangkan untuk H_a jika parameter tidak sama dengan nol. Dengan demikian jika H_0 ditolak, berarti hipotesa penelitian yang bersangkutan diterima. Adapun beberapa hipotesa tersebut adalah sebagai berikut:

Table 4.1. Simbol Hipotesis Kepuasan Pengguna

$H_{1a_0} : \lambda_{11} = 0$	$H_{1a_a} : \lambda_{11} \neq 0$	$H_{1a_0} : \lambda_{21} = 0$	$H_{1a_a} : \lambda_{21} \neq 0$
$H_{1a_0} : \lambda_{31} = 0$	$H_{1a_a} : \lambda_{31} \neq 0$	$H_{1a_0} : \lambda_{41} = 0$	$H_{1a_a} : \lambda_{41} \neq 0$
$H_{2a_0} : \lambda_{52} = 0$	$H_{2a_a} : \lambda_{52} \neq 0$	$H_{2a_0} : \lambda_{62} = 0$	$H_{2a_a} : \lambda_{62} \neq 0$
$H_{2a_0} : \lambda_{72} = 0$	$H_{2a_a} : \lambda_{72} \neq 0$	$H_{2a_0} : \lambda_{82} = 0$	$H_{2a_a} : \lambda_{82} \neq 0$
$H_{3a_0} : \lambda_{93} = 0$	$H_{3a_a} : \lambda_{93} \neq 0$	$H_{3a_0} : \lambda_{103} = 0$	$H_{3a_a} : \lambda_{103} \neq 0$
$H_{3a_0} : \lambda_{113} = 0$	$H_{3a_a} : \lambda_{113} \neq 0$	$H_{4a_0} : \lambda_{124} = 0$	$H_{4a_a} : \lambda_{124} \neq 0$
$H_{4a_0} : \lambda_{134} = 0$	$H_{4a_a} : \lambda_{134} \neq 0$	$H_{5a_0} : \gamma_1 = 0$	$H_{5a_a} : \gamma_1 \neq 0$
$H_{5c_0} : \gamma_2 = 0$	$H_{5c_a} : \gamma_2 \neq 0$	$H_{5c_0} : \gamma_3 = 0$	$H_{5c_a} : \gamma_3 \neq 0$
$H_{5d_0} : \gamma_4 = 0$	$H_{5d_a} : \gamma_4 \neq 0$		

Table 4.2. Keterangan Hipotesis untuk Masalah di atas

Hipotesis	Deskripsi Hipotesis Penelitian
H_0	Sikap staf bukan indikator kualitas layanan
H_1	Sikap staf adalah indikator kualitas layanan
H_0	Respon sistem bukan indikator kualitas layanan
H_1	Respon sistem adalah indikator kualitas layanan
H_0	Kemampuan sistem bukan indikator kualitas layanan
H_1	Kemampuan sistem adalah indikator kualitas layanan

Hipotesis	Deskripsi Hipotesis Penelitian
H_0	Fasilitas pendukung sistem bukan indikator kualitas layanan
H_1	Fasilitas pendukung sistem adalah indikator kualitas layanan
H_0	Kelengkapan bukan indikator kualitas informasi
H_1	Kelengkapan adalah indikator kualitas informasi
H_0	Keterkaitan bukan indikator kualitas informasi
H_1	Keterkaitan adalah indikator kualitas informasi
H_0	Ketepatan bukan indikator kualitas informasi
H_1	Ketepatan adalah indikator kualitas informasi
H_0	Kemutakhiran bukan indikator kualitas informasi
H_1	Kemutakhiran adalah indikator kualitas informasi
H_0	Pelatihan bukan indikator pengetahuan dan keterlibatan pengguna
H_1	Pelatihan adalah indikator pengetahuan dan keterlibatan pengguna
H_0	Pemahaman bukan indikator pengetahuan dan keterlibatan pengguna
H_1	Pemahaman adalah indikator pengetahuan dan keterlibatan pengguna
H_0	Partisipasi bukan indikator pengetahuan dan keterlibatan pengguna
H_1	Partisipasi adalah indikator pengetahuan dan keterlibatan pengguna
H_0	Kemudahan pelaksanaan pekerjaan bukan indikator manfaat informasi
H_1	Kemudahan pelaksanaan pekerjaan adalah indikator manfaat informasi
H_0	Peningkatan produktifitas pengguna bukan indikator manfaat informasi
H_1	Peningkatan produktifitas pengguna adalah indikator manfaat informasi
H_0	Kualitas layanan bukan indikator kepuasan pengguna.
H_1	Kualitas layanan adalah indikator kepuasan pengguna.
H_0	Kualitas informasi bukan indikator kepuasan pengguna.
H_1	Kualitas informasi adalah indikator kepuasan pengguna.
H_0	Pengetahuan/keterlibatan pengguna bukan indikator kepuasan pengguna.
H_1	Pengetahuan/keterlibatan pengguna adalah indikator kepuasan pengguna.
H_0	Manfaat informasi bukan indikator kepuasan pengguna.
H_1	Manfaat informasi adalah indikator kepuasan pengguna.

3. Populasi dan Sampel

Syarat jumlah sampel minimum yang dianjurkan oleh Joreskog dan Sorbom (1996), bergantung kepada jumlah variabel yang akan diteliti. Rumusnya adalah sebagai berikut:

$$\frac{k(k+1)}{2}$$

2

di mana k : adalah jumlah variabel

maka kebutuhan sampel paling sedikit atau minimum sampel untuk menghitung model kepuasan pengguna dalam contoh penelitian di atas,

karena jumlah variabel 13 menjadi $13(13+1)/2 = 91$ sampel. Berarti syarat minimal sampel yang harus dimiliki adalah 100.

4. Contoh Questioner

Model kuesioner yang digunakan untuk pengumpulan data model penelitian kepuasan pengguna, salah satu contohnya dapat diadaptasi dari instrumen penelitian model User Information Satisfaction (UIS) Baroundi dan Orlikowski (1988). Mereka menggunakan perbedaan semantik dengan sepasang kata sifat bipolar untuk setiap variabel dan 7 skala likert untuk setiap pasang kata. Skala likert dan posisinya untuk pasangan kata negatif $\Leftarrow \Rightarrow$ positif yang didefinisikan sbb:

negatif positif

Penjelasan untuk setiap kotak dan angka tersebut adalah :

- | | |
|--------------------|------------------------|
| 1 : sangat negatif | 2 : negatif |
| 3 : agak negatif | 4 : netral; tidak tahu |
| 5 : agak positif | 6 : positif |
| 7 : sangat positif | |

Contoh questioner untuk data kualitas Informasi

* **Kelengkapan informasi** atau y_5

Variabel ini ditujukan untuk mengukur persepsi pengguna terhadap kelengkapan informasi yang dikeluarkan oleh sistem. Informasi tentang persepsi pengguna ini diperoleh dengan memberikan pertanyaan kepada responden sebagai berikut:

Kelengkapan informasi ditinjau dari sisi kebutuhan informasi Anda :

Tidak **lengkap**
lengkap

* **Keterkaitan informasi** atau y_6

Variabel ini ditujukan untuk mengukur persepsi pengguna terhadap keterkaitan informasi yang dikeluarkan oleh sistem. Informasi tentang persepsi pengguna ini diperoleh dengan memberikan pertanyaan kepada responden sebagai berikut:

Keterkaitan informasi ditinjau dari sisi kebutuhan informasi Anda :

tidak 1 2 3 4 5 6 7 **relevan**
relevan

* **Ketepatan informasi** atau y_7

Variabel ini ditujukan untuk mengukur persepsi pengguna terhadap ketepatan informasi yang dikeluarkan oleh sistem. Informasi tentang persepsi pengguna ini diperoleh dengan memberikan pertanyaan kepada responden sebagai berikut:

Ketepatan informasi ditinjau dari sisi kebutuhan informasi Anda:

Tidak 1 2 3 4 5 6 7 **akurat**
akurat

* **Kemutakhiran Informasi** atau y_8

Variabel ini ditujukan untuk mengukur persepsi pengguna terhadap kemutakhiran informasi yang dikeluarkan oleh sistem. Informasi tentang persepsi pengguna ini diperoleh dengan memberikan pertanyaan kepada responden sebagai berikut:

Kemutakhiran informasi ditinjau dari sisi kebutuhan informasi Anda :

rendah 1 2 3 4 5 5 6 **tinggi**

5. Metode Pengolahan Data

Dalam kegiatan pengolahan data, kita dapat membagi kegiatan dalam beberapa tahapan. Tahap pertama yang kita lakukan adalah menyiapkan data. Agar dalam penyiapan data ini tidak terdapat kesalahan, maka penyiapan data dilakukan secara sistematis yaitu:

pengkodean, pemasukan data dan pembentukan data siap olah. Pada tahapan pengkodean, semua kuesioner yang dibagikan dan telah dikembalikan oleh responden, diberi kode tertentu sesuai dengan urutan pengembalian.

Kemudian data mentah yang didapat, dilakukan penyiapan dengan matrik korelasi dan matrik kovarian untuk setiap variabel yang memiliki data ordinal yang dijadikan hipotesa. Penghitungan terhadap nilai variabel indikator dapat dilakukan setelah matrik korelasi dan matrik kovarian dilakukan. Nilai variabel indikator berasal dari nilai rata-rata jawaban responden untuk pertanyaan yang terkait pada setiap kasus.

a. Penyiapan matrik korelasi dan matrik kovarian

Matrik korelasi Pearson adalah sarana yang paling sering digunakan untuk menghitung korelasi atau kovarian antara 2 variabel teramati pada analisis multivariat. Pemakaiannya didasarkan pada asumsi bahwa kedua variabel tersebut diukur secara metrik/kontinu (skala interval/rasio). Sedangkan bentuk dalam penelitian-penelitian sosial, banyak menggunakan skala ordinal atau ukuran non-metrik (binary). Sehingga sangat tidak dianjurkan untuk menggunakan matrik korelasi Pearson. Dan sebagai solusinya kita dapat menggunakan SEM.

Agar ukuran non-metrik dapat digunakan dalam model persamaan struktural (SEM) dan LISREL, maka dilakukan dengan pengukuran korelasi Polychoric, Polyserial, Tetrachoric dan Biserial. Misalnya x_1 dan x_2 adalah 2 variabel ordinal dengan variabel kontinu x_1^* dan x_2^* yang mendasarinya, dengan asumsi x_1^* dan x_2^* adalah penyebar normal ganda, maka korelasi antara keduanya dis: koefisien korelasi Polychoric. Apabila x_1 dan x_2 dikotomis maka dis: koefisien korelasi Tetrachoric. Selanjutnya apabila x_3 adalah variabel kontinu pada skala interval maka korelasi antara x_1^* dan x_3 dis: koefisien korelasi Polyserial. Dan jika x_1 dikotomis maka dis: koefisien korelasi biserial. Dari contoh diatas dapat disimpulkan

bahwa korelasi Polychoric dan korelasi Polyserial bukanlah korelasi yang dihitung dari nilai sebenarnya (actual score) melainkan korelasi teoritis dari variabel z^* yang mendasarinya. Korelasi ini diduga dari pasangan-pasangan pengamatan tabel kontingensi dari variabel ordinal (Joreskog & Sorbom, 1996).

b. Identifikasi Model

Identifikasi model perlu dilakukan sebelum model diestimasi untuk menjamin varian-kovarian variabel teramati mempunyai cukup informasi untuk mengestimasi parameter yang tidak diketahui. Dengan perkataan lain, model yang akan diestimasi harus dapat diidentifikasi atau punya status diidentifikasi yang tepat. Untuk menghasilkan model yang dapat diidentifikasi menurut Joreskog;

- ☺ Syarat jumlah sampel harus sesuai dengan jumlah variabel teramati $\frac{k(k+1)}{2}$
- ☺ Setiap variabel laten harus diberi sebuah unit pengukuran. Dengan salah satu cara dibawah ini:
 - Skala sebuah variabel laten ξ_s dispesifikasikan sama dengan skala dari salah satu variabel teramati (indikator) X_j ; hal ini dilakukan dengan menentukan salah satu koefisien struktural λ_{js} dengan nilai 1,0. Koefisien struktural ini ditunjukkan dalam diagram lintasan sebagai panah dari variabel laten ke variabel teramati yang bersangkutan. Variabel teramati tersebut sering disebut sebagai reference variabel (variabel pedoman).
 - Variabel laten distandarisasi ke unit variance, dengan menetapkan varian $\phi_{ss} = \sigma_{\xi_s}^2$ dari variabel laten mempunyai nilai 1,0.
- ☺ Jika hanya ada satu variabel teramati untuk sebuah ξ , maka diasumsikan bahwa muatan faktor atau koefisien struktural yang terkait adalah sempurna atau mempunyai nilai 1,0. Dalam hal ini diasumsikan

variabel teramati secara sempurna mengukur variabel laten, dan berarti varian kesalahan pengukuran sama dengan 0.

c. Estimasi Model

Menurut Joreskog dan Sorbom (1996) metode estimasi yang paling tepat digunakan pada data ordinal dan korelasi polychoric adalah metode *Weighted Least-Squares* (WLS). Karena distribusi data ordinal yang tidak normal, maka metode WLS akan memberikan hasil yang lebih baik. Kelemahan pengukuran WLS adalah harus memiliki jumlah sampel yang relatif besar. Sehingga metode estimasi yang digunakan untuk penelitian yang memiliki sampel di bawah 500 biasanya menggunakan metode estimasi *Maksimum Likelihood* (ML). Data untuk pengukuran menggunakan metode ML, biasanya bersifat continuous namun tidak sedikit pula yang menggunakan data ordinal yang telah dinormalisasikan. Setiap estimasi yang dilakukan, ditinjau dengan berpedoman pada *goodness of fit* (GOF). Pemeriksaan terhadap hasil estimasi dilakukan untuk melihat kemungkinan adanya estimasi yang mengganggu, yaitu nilai-nilai yang tidak masuk akal atau anomali. Yaitu nilai $t < 1,96$ atau nilai standar solusi > 1.00 .

d. Uji Kecocokan Model

Untuk menilai apakah data yang dikumpulkan konsisten dan cocok dengan model maka dilakukan uji kecocokan model. Jika model tidak cocok dengan data maka perlu dicari penyebabnya pada model, dan dicari cara untuk memodifikasi model tersebut agar diperoleh kecocokan data yang lebih baik. Jika model sudah cocok dengan data, berarti model tersebut sudah benar dan baik menurut *goodness of fit*.

e. Kecocokan Model Pengukuran

Evaluasi kecocokan model pengukuran dapat dilakukan apabila uji kecocokan model secara keseluruhan telah selesai. Evaluasi ini dilakukan pada setiap konstruk secara terpisah: evaluasi terhadap validitas dan

reliabilitas dari konstruk. Evaluasi validitas dimulai dengan memeriksa nilai t dari muatan faktor atau koefisien yang ada di dalam model. Jika nilai t tinggi berarti variabel teramati mewakili konstruk yang mendasarinya. Nilai t setiap muatan perlu melebihi nilai kritis yaitu 1,96 untuk tingkat signifikan 0,05. Nilai t suatu muatan faktor yang melebihi nilai kritis, menunjukkan bahwa variabel yang bersangkutan secara signifikan mempunyai hubungan dengan konstruk yang terkait, dan sekaligus merupakan verifikasi hubungan antara variabel dan konstruk yang telah didefinisikan.

Setelah signifikan dari hubungan diperiksa, perlu juga dilakukan pemeriksaan terhadap tingginya muatan faktor untuk melihat kekuatan hubungan antara variabel dan konstruksinya. Muatan faktor pada konstruksinya dikatakan tinggi jika nilainya lebih dari 0,70. Dengan demikian suatu variabel dikatakan mempunyai validitas terhadap konstruk atau variabel laten yang baik, jika nilai t muatan faktornya lebih besar dari nilai kritis (1,96) dan nilai muatan faktornya lebih besar atau sama dengan 0.70.

f. Kecocokan Model Struktural

Pemeriksaan terhadap model struktural mencakup pemeriksaan terhadap signifikansi koefisien yang diestimasi. Pemeriksaan ini dilakukan dengan memeriksa nilai t dari koefisien yang diestimasi. Jika nilai t lebih besar atau sama dengan 1,96 maka koefisien tersebut adalah signifikan. Selain itu nilai maksimum koefisien pada solusi standar tidak boleh lebih dari 1. Demikian juga nilai R^2 perlu dievaluasi untuk memperoleh gambaran ukuran kecocokan relatif dari setiap persamaan struktural.

g. Respesifikasi

Pelaksanaan langkah respesifikasi sangat tergantung pada strategi pemodelan yang akan digunakan. Dalam sebagian besar penelitian akan mengikuti strategi pengembangan model (model generating). Strategi MG ini akan diterapkan pada model studi kasus dalam buku ini.

Pengolahan model penelitian menurut MG dilakukan dalam 2 tahapan: pertama, pengolahan model awal, dan kedua, pengolahan model yang telah dimodifikasi. Pada tahap pertama, model Awal yang dispesifikasikan menurut 2ndCFA yaitu sub 3A (model ACOVS) seperti terlihat pada diagram Path. Kemudian diestimasi dengan menggunakan metode yang tepat dan sesuai dengan data yang diperoleh dari hasil survei. Hasil estimasi diperiksa untuk melihat ada tidaknya estimasi yang mengganggu. Setelah itu, kita dapat melakukan uji kecocokan model yang berpedoman dengan *Goodness of fit*. Tingkat kecocokan model awal yang kurang baik menandakan tahap kedua dari strategi MG perlu dilaksanakan. Pada tahap kedua ini model awal perlu dimodifikasi, diestimasi dengan data empiris yang sama kemudian diuji lagi tingkat kecocokannya. Proses tahap kedua MG ini dapat dilakukan beberapa kali sampai diperoleh satu model yang mempunyai tingkat kecocokan dengan data yang baik serta parameter-parameter dalam model dapat diartikan dengan baik pula.

BAB V.

IMPLEMENTASI MODEL

1. Penyiapan Data

Sebelum melakukan analisis data menggunakan LISREL, ada beberapa langkah yang harus dilakukan untuk penyiapan data. Berdasarkan pada kategori data yang dimiliki, LISREL membagi jenis data menjadi 2, yaitu;

1. Data continuous
2. Data ordinal

Data continuous adalah data yang dapat memiliki nilai apa saja dan tidak memiliki kategori-kategori berurutan. Sedangkan data ordinal adalah data yang memiliki kategori berurutan. Penggunaan skala likert dan dummy merupakan bagian dari data ordinal.

Data ordinal menggunakan data correlation polychoric sebagai input data dan prosedur estimasi *Weighted Least Square*. Di samping itu pula menurut Breckler (1990), beberapa penelitian SEM yang berbasis skala Likert, ternyata banyak pula yang menggunakan estimasi *Maximum Likelihood*.

Setelah metode estimasi ditentukan, maka langkah selanjutnya adalah membuat matriks korelasi dan matriks kovarian. Sesuai dengan anjuran Bollen (1989), bahwa masukan utama untuk mengolah data dalam bentuk model persamaan struktural di LISREL, maka data tersebut harus dibentuk dalam matriks korelasi dan matriks kovarian terlebih dahulu. Matriks kovarian asymptotic yang dihasilkan LISREL tidak dapat dibaca secara langsung dan tersimpan dalam bentuk biner. Penyimpanan dalam bentuk biner ini dimaksudkan agar ukuran file untuk matriks tersebut lebih kecil dan dapat dibaca lebih cepat jika dilakukan pemindahan data dari PRELIS ke LISREL sehingga dapat dilakukan lebih akurat (Joreskog dan Sorbom 1996b).

PRELIS merupakan analisis awal yang dapat digunakan secara efektif untuk memanipulasi dan menyimpan data dan dapat memberikan

deskripsi awal tentang data. PRELIS membantu peneliti melakukan screening data dengan menyediakan program yang mampu mengatasi berbagai masalah yang timbul dalam pengumpulan data mentah. Berikut ini adalah cara pengolahan dan pembentukan matriks korelasi dan kovarian untuk data input pada PRELIS tsb:

1. Menyimpan data mentah yang berasal dari SPSS, Ms.EXCEL, SAS,
2. Menentukan jenis data
3. Membuat matrik Covarian dan Correlation
4. Screening Data
5. Menormalisasi data

2. Memasukan Data Mentah ke PRELIS

Data mentah yang disimpan menggunakan SPSS ataupun Excel harus diimport ke dalam data mentah LISREL yang disebut dengan PRELIS. Karena hanya data yang disimpan menggunakan PRELIS saja yang bisa diolah oleh LISREL. Cara memasukkan data tersebut adalah sebagai berikut:

- a. Buka menu file, kemudian pilih Import Data in Free Format;

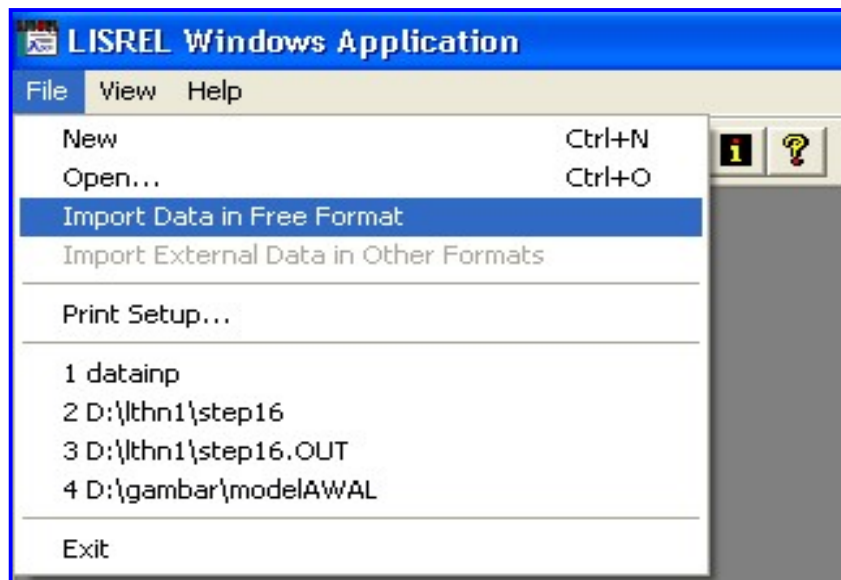

Gambar 5.1. Mengimport Data mentah dari Program lain

b. Setelah tampil menu dialog, pilih tipe file yang ingin dipindahkan ke PRELIS.

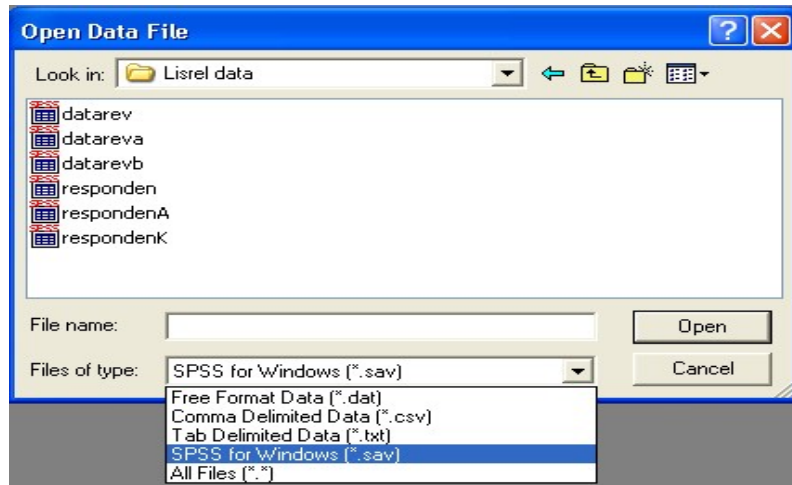

Gambar 5.2. Data mentah yang diambil dari SPSS

c. File yang terbuka akan langsung ditampilkan sebagai data PRELIS;

	Y1	Y2	Y3	Y4	Y5	Y6	Y7	Y8	Y9	Y10	Y11	Y12	Y13
1	1.00	1.00	1.00	2.00	1.00	1.00	1.00	1.00	0.00	1.00	0.00	1.00	1.00
2	2.00	2.00	2.00	1.00	2.00	1.00	2.00	1.00	1.00	2.00	1.00	2.00	1.00
3	2.00	2.00	0.00	1.00	1.00	2.00	2.00	1.00	0.00	0.00	-1.00	0.00	0.00
4	3.00	2.00	2.00	1.00	0.00	-1.00	1.00	0.00	1.00	0.00	3.00	2.00	3.00
5	2.00	1.00	1.00	2.00	1.00	2.00	1.00	2.00	2.00	2.00	2.00	2.00	2.00
6	2.00	2.00	2.00	1.00	-1.00	-1.00	-1.00	-1.00	0.00	1.00	1.00	1.00	1.00
7	2.00	2.00	2.00	3.00	2.00	3.00	2.00	2.00	2.00	2.00	2.00	3.00	2.00
8	2.00	2.00	1.00	1.00	1.00	1.00	1.00	1.00	1.00	2.00	1.00	1.00	2.00
9	1.00	-1.00	-1.00	1.00	-2.00	-1.00	-1.00	-1.00	-2.00	-1.00	-2.00	1.00	1.00
10	2.00	2.00	1.00	2.00	1.00	1.00	1.00	0.00	1.00	0.00	0.00	2.00	1.00
11	2.00	2.00	2.00	1.00	-1.00	1.00	1.00	2.00	2.00	2.00	1.00	1.00	1.00
12	2.00	2.00	2.00	2.00	1.00	1.00	1.00	-1.00	1.00	1.00	1.00	1.00	1.00
13	1.00	1.00	1.00	1.00	1.00	1.00	1.00	1.00	1.00	1.00	2.00	1.00	2.00
14	1.00	1.00	2.00	1.00	-1.00	1.00	1.00	0.00	0.00	1.00	-1.00	1.00	1.00
15	-1.00	-1.00	-2.00	-1.00	-1.00	-1.00	-2.00	-1.00	-1.00	1.00	0.00	-2.00	-2.00
16	2.00	1.00	1.00	1.00	0.00	1.00	1.00	0.00	1.00	1.00	1.00	1.00	1.00
17	2.00	2.00	1.00	1.00	2.00	3.00	3.00	1.00	1.00	2.00	1.00	2.00	3.00
18	2.00	2.00	1.00	2.00	2.00	2.00	2.00	1.00	1.00	1.00	0.00	2.00	2.00
19	2.00	2.00	2.00	2.00	1.00	2.00	1.00	1.00	0.00	1.00	0.00	2.00	2.00
20	2.00	0.00	1.00	1.00	0.00	0.00	0.00	0.00	0.00	-1.00	0.00	1.00	0.00
21	2.00	2.00	2.00	2.00	1.00	1.00	2.00	1.00	1.00	2.00	1.00	2.00	2.00
22	3.00	2.00	2.00	3.00	1.00	1.00	2.00	2.00	0.00	2.00	1.00	1.00	0.00
23	0.00	-2.00	-1.00	1.00	-1.00	1.00	-1.00	0.00	0.00	1.00	1.00	1.00	0.00
24	1.00	1.00	2.00	1.00	0.00	1.00	1.00	0.00	2.00	3.00	1.00	2.00	2.00
25	2.00	1.00	2.00	1.00	2.00	1.00	1.00	1.00	0.00	0.00	0.00	2.00	2.00
26	2.00	1.00	1.00	0.00	0.00	1.00	2.00	1.00	-1.00	-1.00	0.00	1.00	1.00
27	1.00	1.00	1.00	0.00	1.00	1.00	1.00	-1.00	-1.00	-1.00	-1.00	1.00	1.00
28	2.00	2.00	2.00	1.00	1.00	1.00	2.00	1.00	1.00	2.00	2.00	2.00	2.00
29	3.00	3.00	2.00	2.00	1.00	2.00	1.00	2.00	2.00	2.00	1.00	2.00	2.00
30	2.00	2.00	2.00	1.00	2.00	3.00	2.00	2.00	1.00	1.00	1.00	2.00	2.00
31	2.00	2.00	1.00	1.00	1.00	2.00	2.00	2.00	3.00	2.00	1.00	2.00	2.00
32	2.00	1.00	2.00	2.00	1.00	2.00	2.00	1.00	1.00	1.00	1.00	1.00	1.00
33	2.00	1.00	2.00	2.00	1.00	1.00	2.00	2.00	2.00	2.00	1.00	2.00	2.00
34	2.00	1.00	3.00	1.00	1.00	1.00	1.00	1.00	2.00	2.00	2.00	2.00	2.00
35	2.00	2.00	2.00	2.00	2.00	2.00	2.00	2.00	2.00	2.00	2.00	2.00	2.00

Gambar 5.3. Hasil Data mentah yang disimpan di PRELIS pindahan dari SPSS

3. Menentukan Jenis Data

Seperti yang telah dijelaskan sebelumnya bahwa data yang akan diolah oleh LISREL ada 2 kategori yaitu; data ordinal dan data kontinu. Tiap kategori memiliki keunggulan sendiri dan metode estimasi yang berbeda-beda sesuai dengan persyaratan pengolahan data yang telah ditentukan. Jadi sebelum melakukan estimasi, harus ditetapkan terlebih dahulu tipe datanya. Cara menetapkan tipe datanya sebagai berikut;

- a. Buka menu Data, kemudian pilih Define variables.

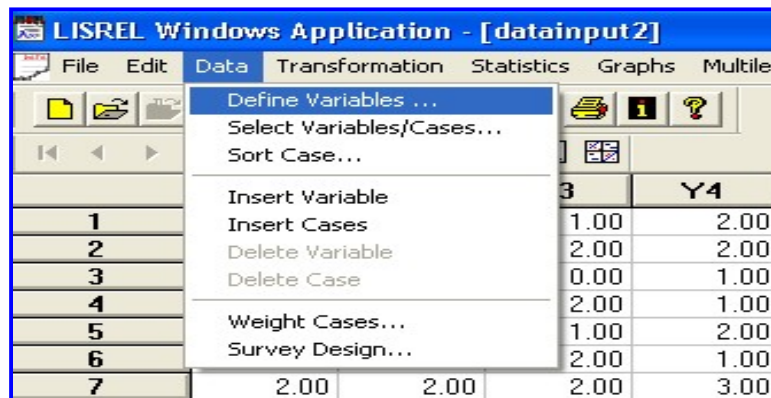

Gambar 5.4. Menu untuk menentukan Tipe Data

- b. Setelah tampil kotak dialog, blok variabel yang akan ditentukan tipe datanya, kemudian pilih variabel types yang sesuai dengan estimasi yang dipilih.

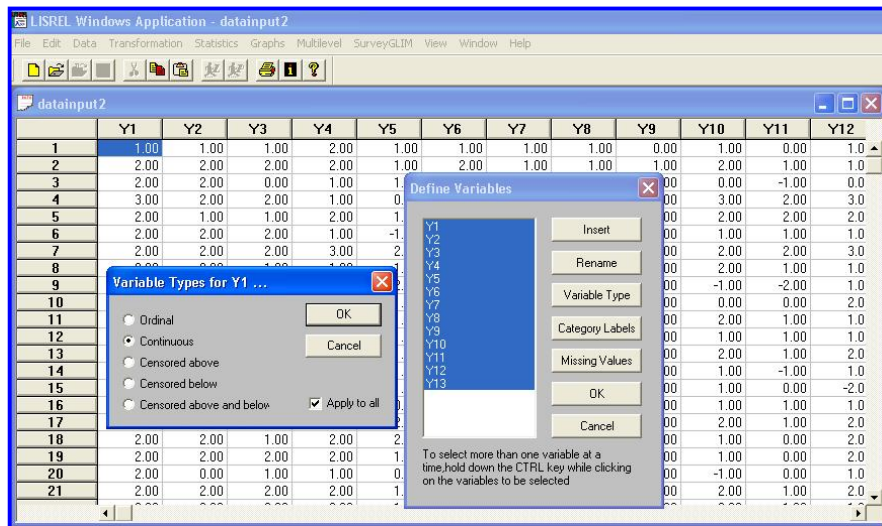

Gambar 5.5. Pilihan Tipe data

4. Membuat Matriks Kovarian dan Matriks Correlation

Seperti dijelaskan sebelumnya bahwa masukan utama untuk mengolah data dalam bentuk model persamaan struktural di LISREL, maka data tersebut harus dibentuk dalam matriks korelasi dan matriks kovarian terlebih dahulu. Matriks kovarian dan matriks korelasi yang dihasilkan tidak dapat dibaca secara langsung dan tersimpan dalam bentuk biner. Penyimpanan dalam bentuk biner ini dimaksudkan agar ukuran file untuk matriks tersebut lebih kecil dan dapat dibaca lebih cepat jika dilakukan pemindahan data dari PRELIS ke LISREL sehingga dapat dilakukan lebih akurat. Berikut ini langkah-langkah yang harus dilakukan dalam membuat matriks.

- a. Buka menu Statistics, kemudian pilih output options

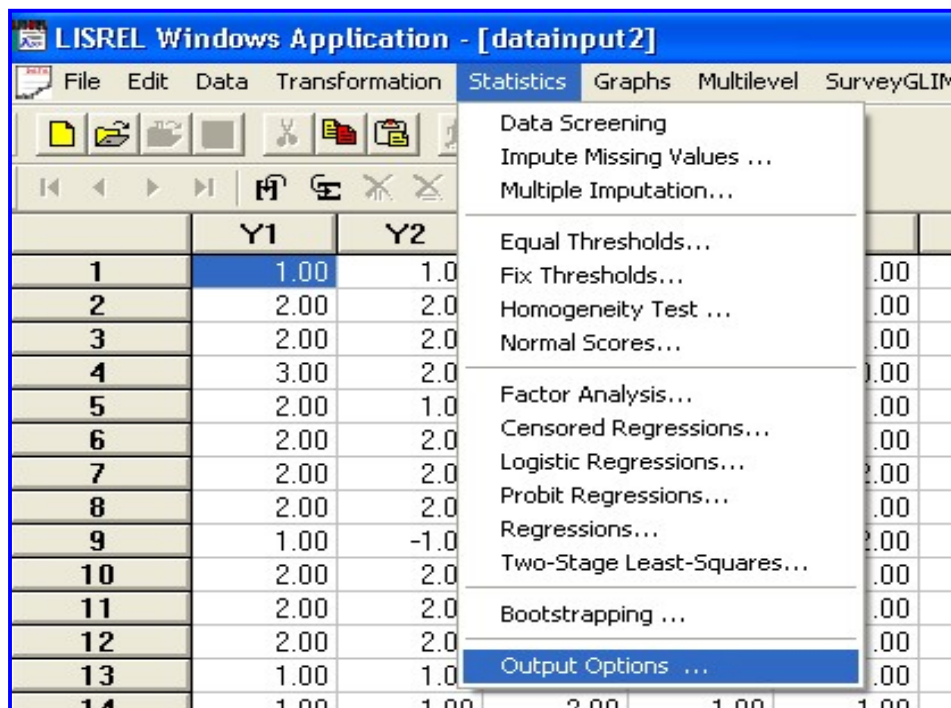

Gambar 5.6. Menu untuk Membuat Matriks Kovarian dan Correlation

- b. Setelah tampil kotak dialog, kita isi dengan perintah serta tempat penyimpanan output yang diinginkan.

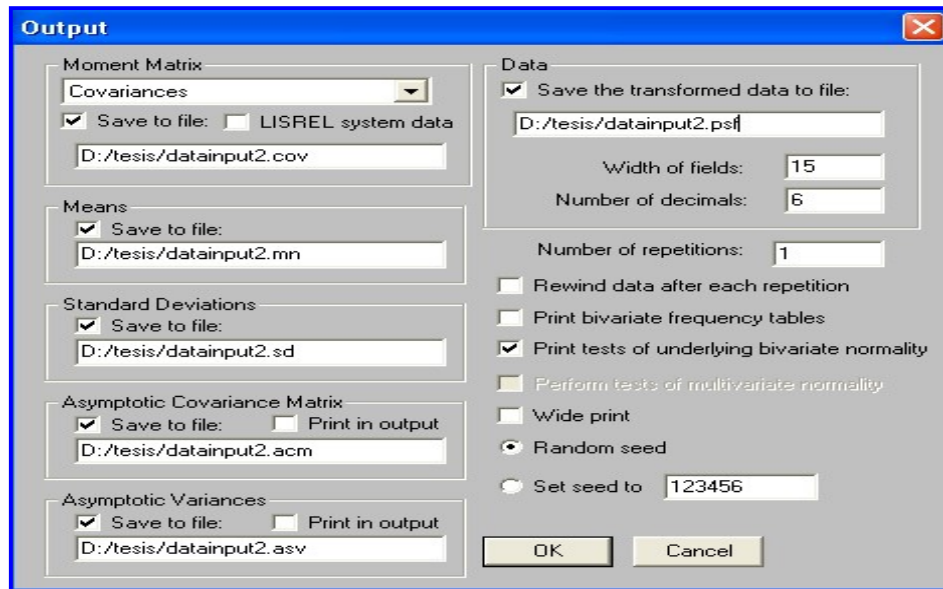

Gambar 5.7. Menyimpan Matriks Covarian dan Correlation

c. Matriks kovarian bisa dibaca menggunakan notepad;

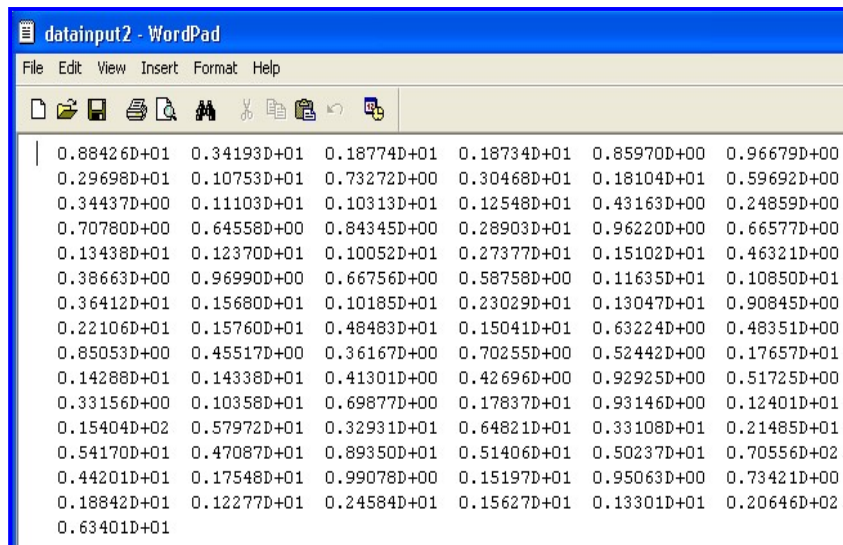

Gambar 5.8. Data Covarian yang bisa dibaca menggunakan notepad

5. Screening Data

Sebelum melakukan analisis Structural Equation Modeling, sangat dianjurkan untuk melakukan screening data untuk memberikan gambaran mengenai deskriptif data (mean, standar deviasi, t value, P value dan normalitas).

Sedangkan informasi lengkap tentang data yang merupakan hasil dari Screening data setelah dijalankan di PRELIS adalah sebagai berikut;

The following lines were read from file D:\gambar\datainput2.PR2:

!PRELIS SYNTAX: Can be edited

!Contents of PSFFILE:

!-----

!DA NI=13 NO=116 MI= -999999 TR=LI

!LA

!Y1 Y2 Y3 Y4 Y5 Y6 Y7 Y8

!Y9 Y10 Y11 Y12 Y13

!CO Y1

!CO Y2

!CO Y3

!CO Y4

!CO Y5

!CO Y6

!CO Y7

!CO Y8

!CO Y9

!CO Y10

!CO Y11

!CO Y12

!CO Y13

!CL Y1 -1 = -1 0 = 0 1 = 1 2 = 2 3 = 3

!CL Y2 -2 = -2 -1 = -1 0 = 0 1 = 1 2 = 2 3 = 3

!CL Y3 -2 = -2 -1 = -1 0 = 0 1 = 1 2 = 2 3 = 3

!CL Y4 -2 = -2 -1 = -1 0 = 0 1 = 1 2 = 2 3 = 3

!CL Y5 -3 = -3 -2 = -2 -1 = -1 0 = 0 1 = 1 2 = 2 3 = 3

!CL Y6 -2 = -2 -1 = -1 0 = 0 1 = 1 2 = 2 3 = 3

!CL Y7 -2 = -2 -1 = -1 0 = 0 1 = 1 2 = 2 3 = 3

!CL Y8 -3 = -3 -2 = -2 -1 = -1 0 = 0 1 = 1 2 = 2 3 = 3

!CL Y9 -3 = -3 -2 = -2 -1 = -1 0 = 0 1 = 1 2 = 2 3 = 3

!CL Y10 -2 = -2 -1 = -1 0 = 0 1 = 1 2 = 2 3 = 3

!CL Y11 -3 = -3 -2 = -2 -1 = -1 0 = 0 1 = 1 2 = 2 3 = 3

!CL Y12 -2 = -2 -1 = -1 0 = 0 1 = 1 2 = 2 3 = 3

!CL Y13 -2 = -2 -1 = -1 0 = 0 1 = 1 2 = 2 3 = 3

!End of Contents

!-----

!PRELIS SYNTAX: Can be edited

SY='D:\gambar\datainput2.PSF'

OU MA=CM SM=D:/gambar/datainput2.cov XT XM

Total Sample Size = 116

Univariate Summary Statistics for Continuous Variables

Variable	Mean	St. Dev.	T-Value	Skewness	Kurtosis	Minimum	Freq.	Maximum	Freq.
Y1	1.552	0.926	18.041	-1.256	1.548	-1.000	7	3.000	8
Y2	1.233	1.122	11.836	-1.000	0.878	-2.000	3	3.000	8
Y3	1.198	1.015	12.717	-0.866	0.410	-2.000	1	3.000	4
Y4	0.862	1.222	7.597	-0.749	0.110	-2.000	7	3.000	5
Y5	0.224	1.384	1.745	-0.372	-0.932	-3.000	2	3.000	1
Y6	0.733	1.233	6.403	-0.495	-0.716	-2.000	4	3.000	3
Y7	0.793	1.241	6.885	-0.820	-0.151	-2.000	8	3.000	2
Y8	0.379	1.323	3.088	-0.227	-0.748	-3.000	1	3.000	3
Y9	0.362	1.334	2.922	-0.491	-0.110	-3.000	4	3.000	2
Y10	0.897	1.254	7.702	-0.690	-0.415	-2.000	5	3.000	4
Y11	0.414	1.187	3.753	-0.473	-0.240	-3.000	1	3.000	1
Y12	1.276	1.198	11.466	-1.291	1.783	-2.000	8	3.000	10
Y13	1.241	1.084	12.329	-1.079	1.402	-2.000	4	3.000	7

Test of Univariate Normality for Continuous Variables

Variable	Skewness		Kurtosis		Skewness and Kurtosis	
	Z-Score	P-Value	Z-Score	P-Value	Chi-Square	P-Value
Y1	-4.694	0.000	2.463	0.014	28.102	0.000
Y2	-3.958	0.000	1.714	0.087	18.604	0.000
Y3	-3.532	0.000	1.007	0.314	13.490	0.001
Y4	-3.131	0.002	0.427	0.669	9.984	0.007
Y5	-1.661	0.097	-3.651	0.000	16.088	0.000
Y6	-2.169	0.030	-2.295	0.022	9.972	0.007

Y7	-3.377	0.001	-0.200	0.842	11.446	0.003
Y8	-1.030	0.303	-2.467	0.014	7.148	0.028
Y9	-2.155	0.031	-0.093	0.926	4.652	0.098
Y10	-2.920	0.004	-1.011	0.312	9.547	0.008
Y11	-2.081	0.037	-0.451	0.652	4.533	0.104
Y12	-4.787	0.000	2.677	0.007	30.088	0.000
Y13	-4.198	0.000	2.319	0.020	22.998	0.000

Histograms for Continuous Variables

Y1

Frequency	Percentage	Lower Class Limit
7	6.0	-1.000
0	0.0	-0.600
6	5.2	-0.200
0	0.0	0.200
0	0.0	0.600
27	23.3	1.000
0	0.0	1.400
68	58.6	1.800
0	0.0	2.200
8	6.9	2.600

Y2

Frequency	Percentage	Lower Class Limit
3	2.6	-2.000
10	8.6	-1.500
0	0.0	-1.000
6	5.2	-0.500
0	0.0	0.000
43	37.1	0.500
0	0.0	1.000
46	39.7	1.500
0	0.0	2.000
8	6.9	2.500

Y3

Frequency	Percentage	Lower Class Limit
1	0.9	-2.000
9	7.8	-1.500
0	0.0	-1.000
13	11.2	-0.500
0	0.0	0.000
40	34.5	0.500
0	0.0	1.000
49	42.2	1.500
0	0.0	2.000
4	3.4	2.500

Y4

Frequency	Percentage	Lower Class Limit
7	6.0	-2.000
12	10.3	-1.500
0	0.0	-1.000
12	10.3	-0.500
0	0.0	0.000
49	42.2	0.500
0	0.0	1.000
31	26.7	1.500
0	0.0	2.000
5	4.3	2.500

Y5

Frequency	Percentage	Lower Class Limit
2	1.7	-3.000
13	11.2	-2.400
0	0.0	-1.800
27	23.3	-1.200
10	8.6	-0.600
0	0.0	0.000
44	37.9	0.600
0	0.0	1.200
19	16.4	1.800
1	0.9	2.400

Y6

Frequency	Percentage	Lower Class Limit
4	3.4	-2.000
23	19.8	-1.500
0	0.0	-1.000
11	9.5	-0.500

0	0.0	0.000
43	37.1	0.500
0	0.0	1.000
32	27.6	1.500
0	0.0	2.000
3	2.6	2.500

Y7

Frequency	Percentage	Lower Class Limit
8	6.9	-2.000
0	0.0	-1.500
14	12.1	-1.000
0	0.0	-0.500
11	9.5	0.000
0	0.0	0.500
46	39.7	1.000
0	0.0	1.500
35	30.2	2.000
2	1.7	2.500

Y8

Frequency	Percentage	Lower Class Limit
1	0.9	-3.000
8	6.9	-2.400
0	0.0	-1.800
26	22.4	-1.200
20	17.2	-0.600
0	0.0	0.000
36	31.0	0.600
0	0.0	1.200
22	19.0	1.800
3	2.6	2.400

Y9

Frequency	Percentage	Lower Class Limit
4	3.4	-3.000
6	5.2	-2.400
0	0.0	-1.800
18	15.5	-1.200
31	26.7	-0.600
0	0.0	0.000
32	27.6	0.600
0	0.0	1.200
23	19.8	1.800
2	1.7	2.400

Y10

Frequency	Percentage	Lower Class Limit
5	4.3	-2.000
17	14.7	-1.500
0	0.0	-1.000
12	10.3	-0.500
0	0.0	0.000
37	31.9	0.500
0	0.0	1.000
41	35.3	1.500
0	0.0	2.000
4	3.4	2.500

Y11

Frequency	Percentage	Lower Class Limit
1	0.9	-3.000
7	6.0	-2.400
0	0.0	-1.800
18	15.5	-1.200
28	24.1	-0.600
0	0.0	0.000
42	36.2	0.600
0	0.0	1.200
19	16.4	1.800
1	0.9	2.400

Y12

Frequency	Percentage	Lower Class Limit
8	6.9	-2.000
2	1.7	-1.500
0	0.0	-1.000
7	6.0	-0.500
0	0.0	0.000
42	36.2	0.500
0	0.0	1.000

47	40.5	1.500
0	0.0	2.000
10	8.6	2.500

Y13

Frequency	Percentage	Lower Class Limit
4	3.4	-2.000
5	4.3	-1.500
0	0.0	-1.000
11	9.5	-0.500
0	0.0	0.000
42	36.2	0.500
0	0.0	1.000
47	40.5	1.500
0	0.0	2.000
7	6.0	2.500

Covariance Matrix

	Y1	Y2	Y3	Y4	Y5	Y6
Y1	0.858					
Y2	0.766	1.258				
Y3	0.551	0.719	1.030			
Y4	0.616	0.676	0.575	1.494		
Y5	0.684	0.652	0.512	0.936	1.915	
Y6	0.497	0.411	0.323	0.624	1.139	1.519
Y7	0.654	0.553	0.546	0.641	1.160	0.944
Y8	0.537	0.441	0.489	0.731	1.079	0.963
Y9	0.607	0.750	0.667	0.920	0.996	0.680
Y10	0.423	0.555	0.542	0.577	0.667	0.485
Y11	0.422	0.355	0.465	0.605	0.706	0.442
Y12	0.638	0.640	0.440	0.551	0.572	0.405
Y13	0.587	0.596	0.421	0.434	0.502	0.396

Covariance Matrix

	Y7	Y8	Y9	Y10	Y11	Y12	Y13
Y7	1.539						
Y8	1.079	1.751					
Y9	0.919	1.096	1.781				
Y10	0.500	0.683	1.073	1.572			
Y11	0.747	0.868	1.084	0.974	1.410		
Y12	0.579	0.807	0.682	0.594	0.650	1.436	
Y13	0.590	0.655	0.581	0.530	0.525	1.194	1.176

Means

	Y1	Y2	Y3	Y4	Y5	Y6
Means	1.552	1.233	1.198	0.862	0.224	0.733

	Y7	Y8	Y9	Y10	Y11	Y12	Y13
Means	0.793	0.379	0.362	0.897	0.414	1.276	1.241

Standard Deviations

Y1	Y2	Y3	Y4	Y5	Y6
0.926	1.122	1.015	1.222	1.384	1.233

Standard Deviations

Y7	Y8	Y9	Y10	Y11	Y12	Y13
1.241	1.323	1.334	1.254	1.187	1.198	1.084

The Problem used 20872 Bytes (= 0.0% of available workspace)

Tahapan yang dilakukan untuk menormalisasi data adalah sbb;

- Klik Statistics dan pilih Normal Scores. Sehingga keluar kotak dialog dengan judul Normal Scores. Blok seluruh variabel yang ingin dinormalkan, tekan add.

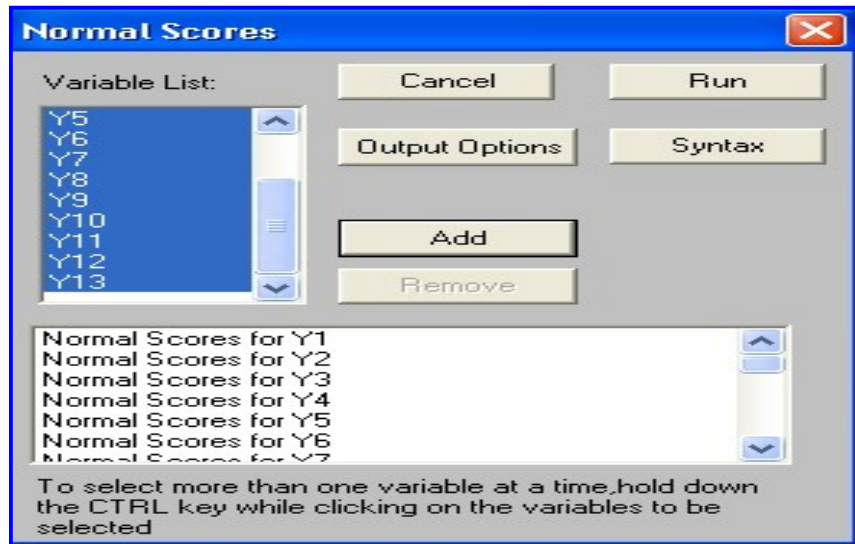

Gambar 5.9. Perintah untuk menormalisasi data

- b. Klik output options dan beri tanda pada save the transformed data to file, kemudian disimpan dengan ekstensi *.psf agar file bisa dibaca dengan menggunakan program PRELIS.

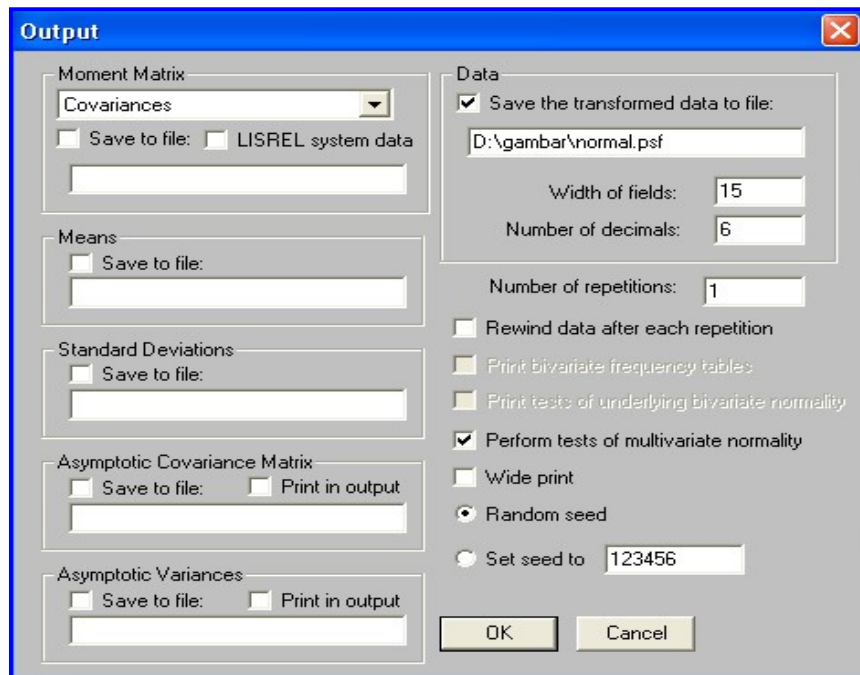

Gambar 5.10. menu Penyimpanan data yang telah dinormalisasi

c. Data yang telah dinormalkan ditampilkan berikut ini:

Gambar 5.11. Tampilan Data Continous yang telah dinormalisasikan

Berikut adalah Output dari Program PRELIS;

The following lines were read from file D:\gambar\datainput2.PR2:

```
!PRELIS SYNTAX: Can be edited
SY='D:\gambar\datainput2.PSF'
NS 1 2 3 4 5 6 7 8 9 10 11 12 13
NS 1 2 3 4 5 6 7 8 9 10 11 12 13
OU MA=CM RA=D:\gambar\normal.psf XT
```

Total Sample Size = 116

Univariate Summary Statistics for Continuous Variables

Variable	Mean	St. Dev.	T-Value	Skewness	Kurtosis	Minimum	Freq.	Maximum	Freq.
Y1	1.552	0.926	18.041	-0.242	0.266	-0.467	7	3.512	8
Y2	1.233	1.122	11.836	-0.128	-0.040	-1.517	3	3.509	8
Y3	1.198	1.015	12.717	-0.208	0.012	-1.730	1	3.586	4
Y4	0.862	1.222	7.597	-0.061	-0.140	-1.667	7	3.571	5
Y5	0.224	1.384	1.745	-0.075	-0.125	-3.326	2	4.119	1
Y6	0.733	1.233	6.403	-0.069	-0.195	-2.117	4	3.726	3
Y7	0.793	1.241	6.885	-0.126	-0.247	-1.717	8	4.021	2
Y8	0.379	1.323	3.088	-0.042	-0.135	-3.314	1	3.542	3
Y9	0.362	1.334	2.922	-0.067	-0.184	-2.672	4	3.755	2
Y10	0.897	1.254	7.702	-0.134	-0.201	-1.889	5	3.800	4
Y11	0.414	1.187	3.753	-0.091	-0.088	-2.918	1	3.746	1
Y12	1.276	1.198	11.466	-0.088	-0.207	-1.163	8	3.587	10
Y13	1.241	1.084	12.329	-0.144	-0.033	-1.291	4	3.510	7

Test of Univariate Normality for Continuous Variables

Variable	Skewness		Kurtosis		Skewness and Kurtosis	
	Z-Score	P-Value	Z-Score	P-Value	Chi-Square	P-Value
Y1	-1.098	0.272	0.744	0.457	1.759	0.415
Y2	-0.583	0.560	0.084	0.933	0.347	0.841
Y3	-0.944	0.345	0.207	0.836	0.934	0.627
Y4	-0.277	0.781	-0.172	0.864	0.107	0.948
Y5	-0.343	0.731	-0.133	0.895	0.135	0.935
Y6	-0.318	0.751	-0.323	0.747	0.205	0.902

Y7	-0.576	0.564	-0.472	0.637	0.555	0.758
Y8	-0.193	0.847	-0.158	0.874	0.063	0.969
Y9	-0.309	0.758	-0.291	0.771	0.180	0.914
Y10	-0.613	0.540	-0.339	0.735	0.490	0.783
Y11	-0.415	0.678	-0.037	0.970	0.173	0.917
Y12	-0.405	0.686	-0.355	0.722	0.290	0.865
Y13	-0.658	0.511	0.100	0.921	0.442	0.802

Relative Multivariate Kurtosis = 1.105

Test of Multivariate Normality for Continuous Variables

Skewness			Kurtosis			Skewness and Kurtosis	
Value	Z-Score	P-Value	Value	Z-Score	P-Value	Chi-Square	P-Value
34.674	6.261	0.000	215.432	4.725	0.000	61.528	0.000

6. Pengolahan Data

SIMPLIS merupakan bahasa perintah yang relative lebih sederhana karena menggunakan bahasa Inggris yang sederhana. Untuk menampilkan format SIMPLIS, klik file dan klik new. Kemudian klik SIMPLIS Project dan tekan OK.

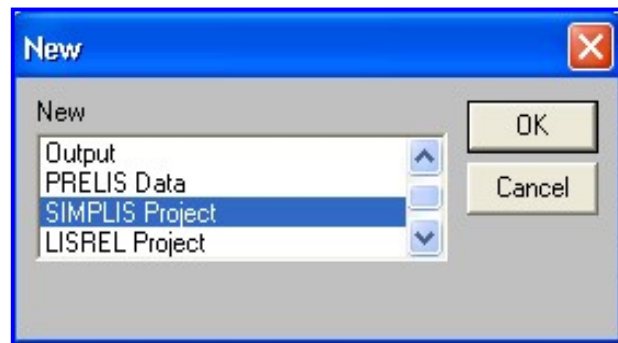

Gambar 5.12. Data siap diolah menggunakan SIMPLIS Project

Setelah matriks korelasi dan matriks kovarian disiapkan maka langkah selanjutnya adalah pengolahan model yang dilakukan dengan memilih metode estimasi ML atau *Maximum Likelihood*.

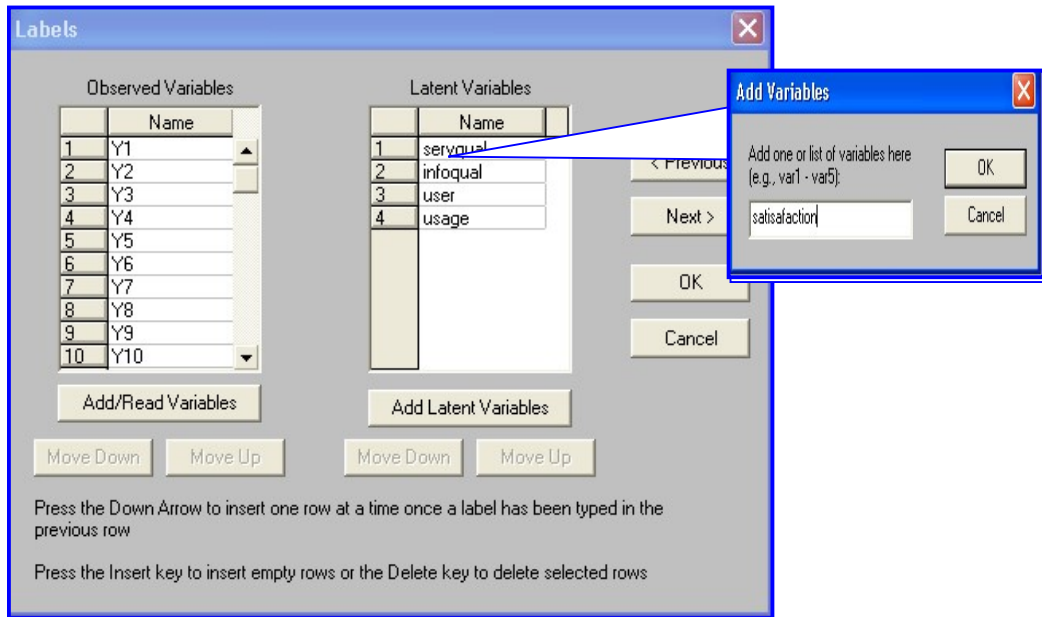

Gambar 5.13. Mendefinisikan Variabel Penelitian

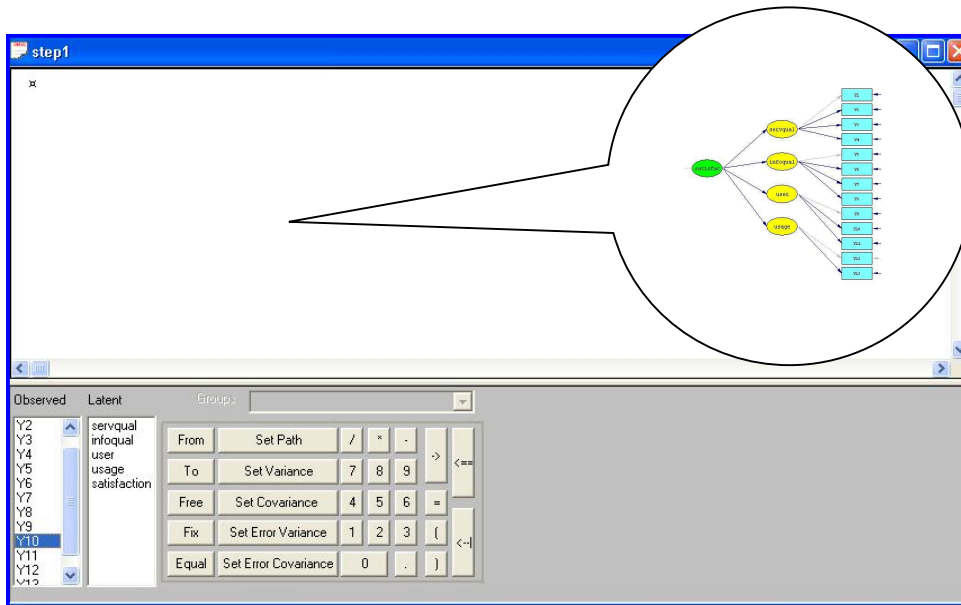

Gambar 5.14. Penyiapan Syntax yang tepat untuk Model yang telah Dibangun

Setelah metode estimasi dipilih maka metode tersebut digunakan untuk mengolah model-model yang telah disiapkan sebelumnya. Secara garis besar pelaksanaan pengolahan model kepuasan pengguna informasi dalam contoh kasus ini adalah sebagai berikut:

1. Melakukan pengukuran model dengan metode estimasi ML.
2. Pengembangan model UIS
3. Penghitungan nilai variabel UIS
4. Pembahasan

7. Estimasi Model Dengan Menggunakan Metode ML

Metode estimasi yang digunakan untuk contoh studi kasus dalam buku ini adalah metode ML (*maximum likelihood*). Estimasi akan dilakukan untuk mendapat nilai uji kecocokan terhadap model UIS yang telah kita bangun pada gambar 4.1. Hasil dari estimasi dan uji kecocokan terhadap model awal dan model akhir kemudian akan kita bandingkan. Terakhir baru menghitung nilai dan rata-rata kepuasan pengguna.

Uji kecocokan model dilakukan agar dapat menilai apakah model yang kita buat cocok dan konsisten dengan data yang dikumpulkan. Maka perlu dicari penyebabnya pada model serta dicari cara untuk memodifikasi model tersebut agar diperoleh kecocokan dengan data yang lebih baik. Jika model cocok dengan data, tidak berarti bahwa model tersebut adalah model yang terbaik sebab jika ditinjau dari berbagai ukuran *goodness of fit* (GOF), banyak model yang mempunyai kecocokan sebaik model tersebut (Joreskog dan Sorbom, 1993). Tidak ada pengujian yang mutlak dalam menilai GOF, sehingga diperlukan pedoman untuk menggunakan ukuran GOF yang cukup banyak dalam LISREL. Hasil pengukuran GOF dalam penelitian ini juga disertai dengan pedoman dan keterangan mengenai batasan diterima atau tidaknya tingkatan GOF. Perbandingan antara ukuran GOF serta tingkat penerimaan kecocokannya diperoleh dari Ridgdon dan Ferguson serta Joreskog dan Sorbom (1993).

Setelah pengukuran kecocokan model secara keseluruhan telah dilakukan maka evaluasi terhadap kecocokan model pengukuran dapat dilakukan lebih rinci. Evaluasi ini dilakukan untuk mengukur validitas dan reliabilitas terhadap konsep model. Evaluasi dimulai dengan memeriksa nilai t dari muatan faktor atau koefisien yang ada di dalam model. Nilai t yang tinggi pada suatu muatan faktor merupakan bukti bahwa faktor

tersebut mewakili beberapa konsep bangunan yang mendasarinya. Nilai t setiap muatan faktor perlu melebihi nilai kritis yaitu 1,96 untuk tingkat signifikan 0.05 atau 2.576 untuk tingkat signifikan 0.01. Sehingga jika nilai $t \geq 1,96$ berarti variabel yang bersangkutan secara signifikan mempunyai hubungan dengan konsep rancangan yang terkait, dan sekaligus merupakan verifikasi hubungan antara variabel dan konstruk yang telah didefinisikan. Setelah nilai t kemudian dilakukan pemeriksaan terhadap tingginya muatan faktor untuk melihat kekuatan hubungan antara variabel dengan konstruksinya. Muatan faktor dikatakan tinggi jika nilainya lebih dari 0.70. Dengan demikian suatu variabel mempunyai validitas yang baik terhadap konstruk atau variabel latennya jika nilai t muatan faktornya ≥ 1.96 dan muatan faktornya ≥ 0.70 .

Sedangkan reliabilitas digunakan untuk melihat kekonsistenan suatu pengukuran. Reliabilitas yang tinggi menunjukkan bahwa indikator-indikator mempunyai konsisten yang tinggi dalam mengukur konstruk latennya. Evaluasi terhadap reliabilitas dapat dilakukan dengan menggunakan dua jenis pengukuran yaitu *composite reliability measure* atau *construct reliability measure* dan *variance extracted measure*. Ukuran reliabilitas sebuah konstruk dapat dikatakan baik jika nilai *construct reliability*-nya ≥ 0.70 dan nilai *variance extracted*-nya ≥ 0.50 .

Pemeriksaan terhadap model struktural dilakukan dengan memeriksa signifikansi dari koefisien yang diestimasi. Pemeriksaan ini dilakukan dengan memeriksa nilai t dari koefisien yang diestimasi. Jika nilai $t \geq 1.96$ maka koefisien tersebut adalah signifikan. Selain itu juga perlu diperiksa nilai maksimum koefisien pada solusi setandar tidak boleh lebih dari 1. Demikian juga nilai R^2 perlu dievaluasi untuk memperoleh gambaran ukuran kecocokan relatif dari setiap persamaan struktural.

8. Model Awal

Model awal rancangan variabel studi kasus kita adalah seperti yang terlihat pada gambar 4.1. dimana variabel latennya terdiri atas 4 variabel laten endogen dan 1 variabel laten eksogen serta 13 variabel teramati.

Model LISREL atau persamaan struktural yang digunakan adalah second confirmatory analysis (2ndCFA) sedangkan metode estimasi yang digunakan adalah metode ML.

Untuk mengolah data model awal ini maka perintah dilakukan pada program komputer dengan menggunakan bahasa SIMPLIS. Namun sebelumnya telah dimasukkan matriks korelasi dan matriks kovarian, baru kemudian program dijalankan pada LISREL8.71. Berikut adalah syntax yang dibangun untuk mengolah model awal tersebut;

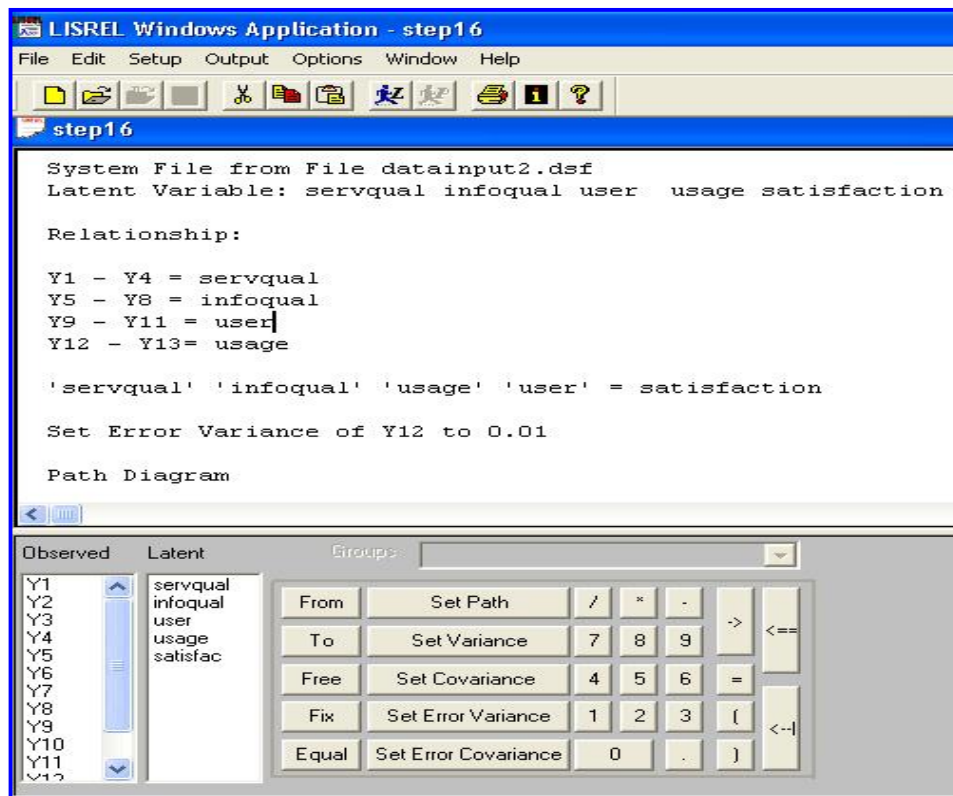

Gambar 5.15. Syntax yang Dibangun untuk Model Awal

Setelah itu akan diperoleh keluaran-keluaran yang berbentuk laporan hasil pengukuran disertai dengan diagram Pathnya. Berikut ini contoh beberapa output yang dihasilkan oleh model yang di bangun;

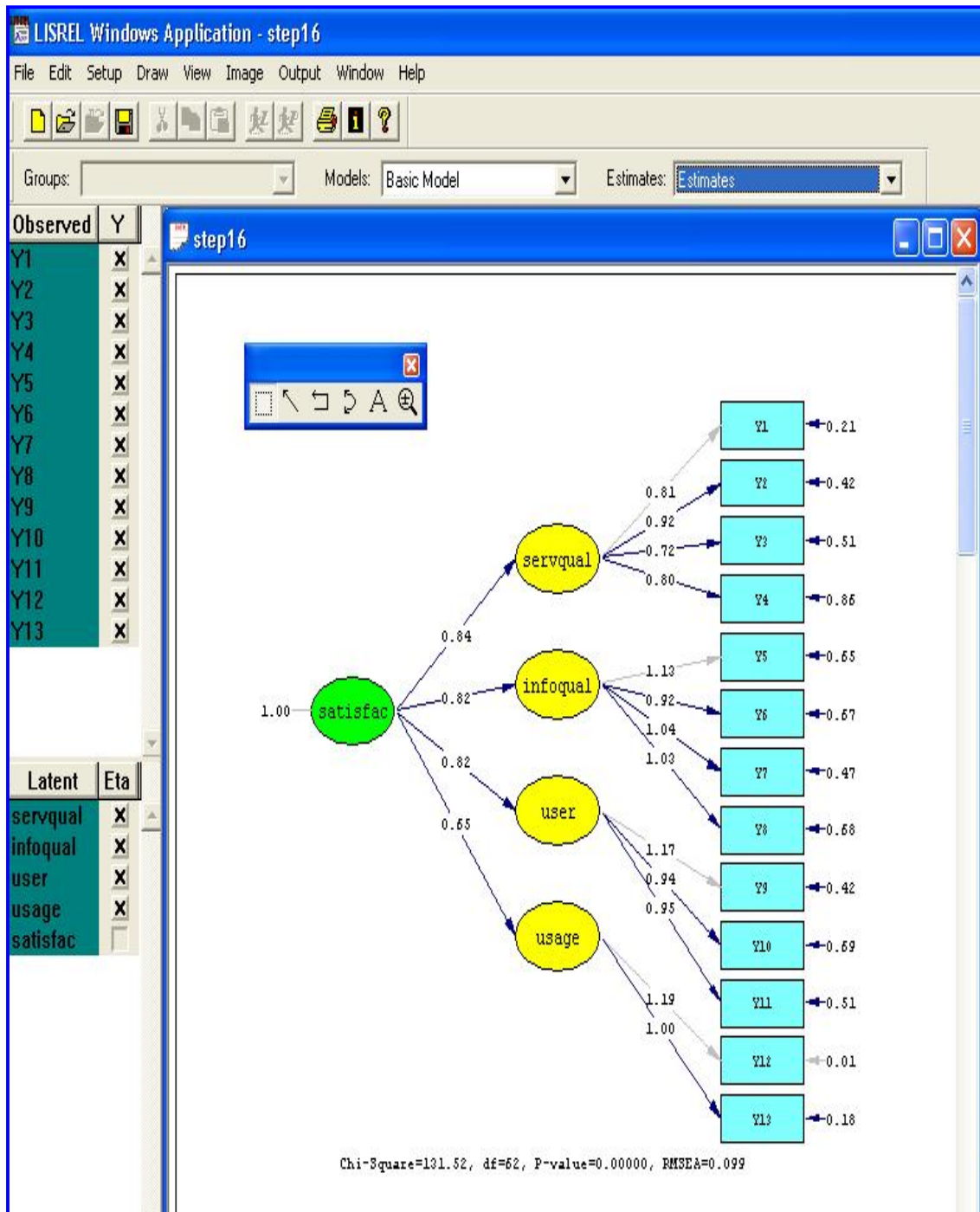

Gambar 5.16. Nilai Estimasi Model Awal

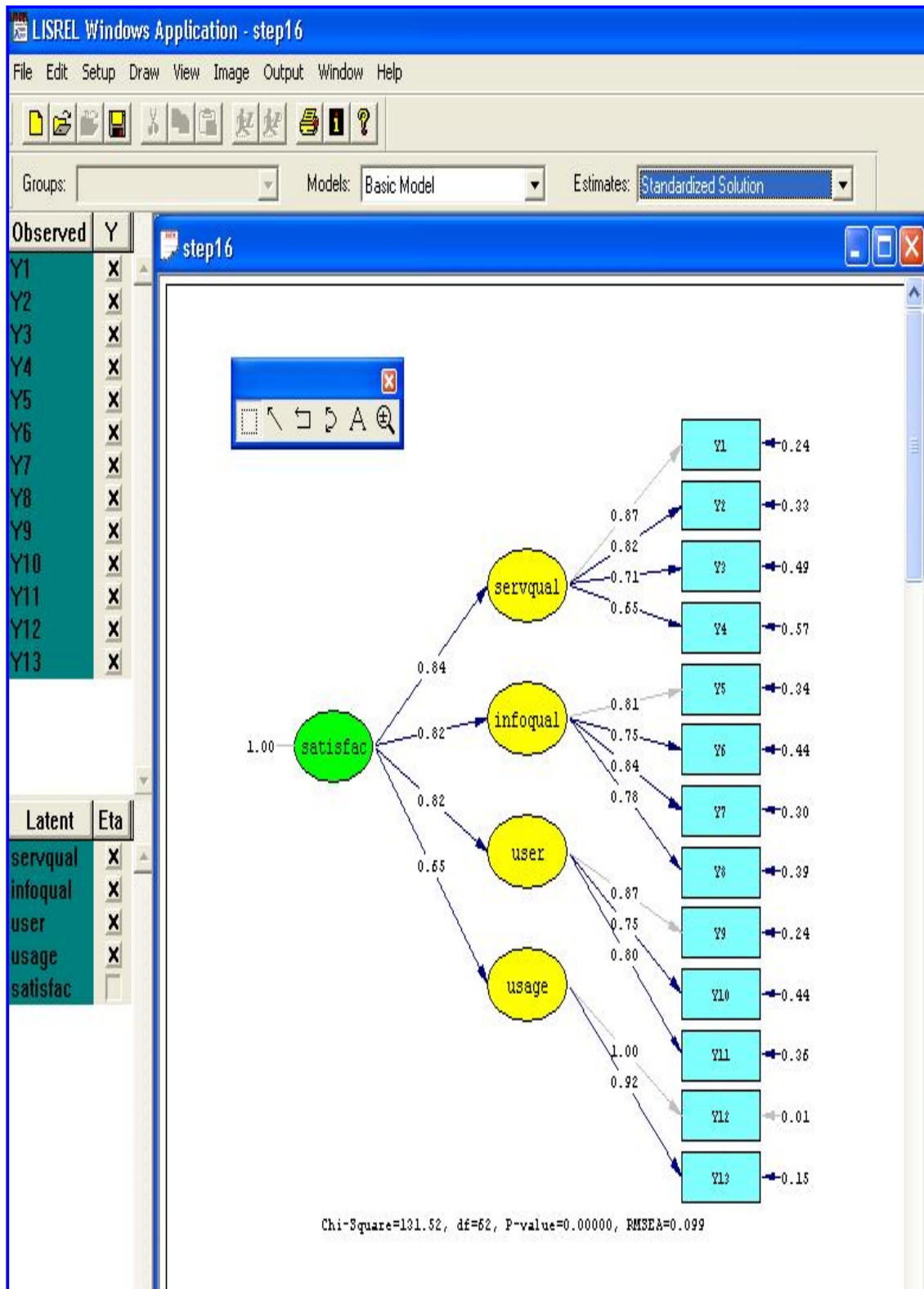

Gambar 5.17. Nilai Standar Solusi Model Awal

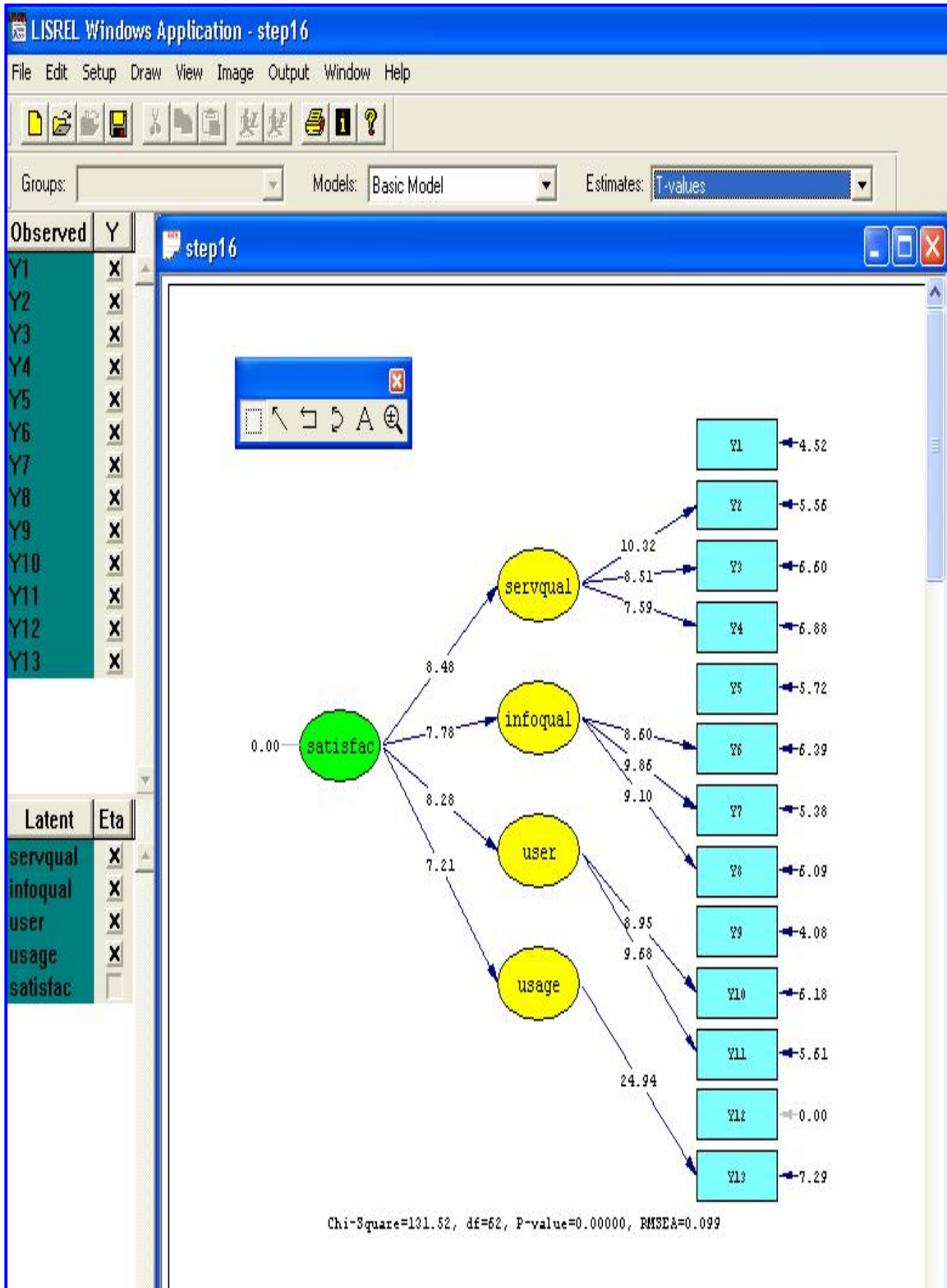

Gambar 5.18. Nilai Uji T Model Awal

Nilai Estimasi Model Awal Dengan Menggunakan Metode ML

=====
 The following lines were read from file D:\lthn1\step16.spj:

System File from File datainput2.dsf
 Latent Variable: servqual infoqual user usage satisfaction

Relationship:

Y1 - Y4 = servqual
 Y5 - Y8 = infoqual
 Y9 - Y11 = user
 Y12 - Y13 = usage
 'servqual' 'infoqual' 'usage' 'user' = satisfaction

Set Error Variance of Y12 to 0.01

Path Diagram

End of Problem

Sample Size = 116

Covariance Matrix

	Y1	Y2	Y3	Y4	Y5	Y6
Y1	0.86					
Y2	0.77	1.26				
Y3	0.55	0.72	1.03			
Y4	0.62	0.68	0.58	1.49		
Y5	0.68	0.65	0.51	0.94	1.91	
Y6	0.50	0.41	0.32	0.62	1.14	1.52
Y7	0.65	0.55	0.55	0.64	1.16	0.94
Y8	0.54	0.44	0.49	0.73	1.08	0.96
Y9	0.61	0.75	0.67	0.92	1.00	0.68
Y10	0.42	0.55	0.54	0.58	0.67	0.49
Y11	0.42	0.36	0.47	0.61	0.71	0.44
Y12	0.64	0.64	0.44	0.55	0.57	0.40
Y13	0.59	0.60	0.42	0.43	0.50	0.40

Covariance Matrix

	Y7	Y8	Y9	Y10	Y11	Y12	Y13
Y7	1.54						
Y8	1.08	1.75					
Y9	0.92	1.10	1.78				
Y10	0.50	0.68	1.07	1.57			
Y11	0.75	0.87	1.08	0.97	1.41		
Y12	0.58	0.81	0.68	0.59	0.65	1.44	
Y13	0.59	0.66	0.58	0.53	0.53	1.19	1.18

Number of Iterations = 81

LISREL Estimates (Maximum Likelihood)

Measurement Equations

Y1 = 0.81*servqual, Errorvar.= 0.21 , R² = 0.76
 (0.046)
 4.52

Y2 = 0.92*servqual, Errorvar.= 0.42 , R² = 0.67
 (0.089) (0.075)
 10.32 5.56

Y3 = 0.72*servqual, Errorvar.= 0.51 , R² = 0.51
 (0.085) (0.077)
 8.51 6.60

Y4 = 0.80*servqual, Errorvar.= 0.86 , R² = 0.43
 (0.11) (0.12)

```

        7.59                      6.88
Y5 = 1.13*infoqual, Errorvar.= 0.65 , R² = 0.66
                        (0.11)
                        5.72

Y6 = 0.92*infoqual, Errorvar.= 0.67 , R² = 0.56
(0.11)                      (0.10)
8.60                        6.39

Y7 = 1.04*infoqual, Errorvar.= 0.47 , R² = 0.70
(0.11)                      (0.086)
9.86                        5.38

Y8 = 1.03*infoqual, Errorvar.= 0.68 , R² = 0.61
(0.11)                      (0.11)
9.10                        6.09

Y9 = 1.17*user, Errorvar.= 0.42 , R² = 0.76
                        (0.10)
                        4.08

Y10 = 0.94*user, Errorvar.= 0.69 , R² = 0.56
(0.11)                     (0.11)
8.95                       6.18

Y11 = 0.95*user, Errorvar.= 0.51 , R² = 0.64
(0.098)                    (0.091)
9.68                       5.61

Y12 = 1.19*usage, Errorvar.= 0.0100, R² = 0.99

Y13 = 1.00*usage, Errorvar.= 0.18 , R² = 0.85
(0.040)                    (0.024)
24.94                      7.29

```

Structural Equations

```

servqual = 0.84*satisfac, Errorvar.= 0.30 , R² = 0.70
            (0.099)                    (0.093)
            8.48                      3.20

infoqual = 0.82*satisfac, Errorvar.= 0.33 , R² = 0.67
(0.11)                    (0.098)
7.78                      3.37

user = 0.82*satisfac, Errorvar.= 0.32 , R² = 0.68
(0.099)                   (0.097)
8.28                      3.32

usage = 0.65*satisfac, Errorvar.= 0.57 , R² = 0.43
(0.090)                   (0.090)
7.21                      6.40

```

Correlation Matrix of Independent Variables

satisfac

1.00

Covariance Matrix of Latent Variables

	servqual	infoqual	user	usage	satisfac
servqual	1.00				
infoqual	0.69	1.00			
user	0.69	0.67	1.00		
usage	0.55	0.53	0.54	1.00	
satisfac	0.84	0.82	0.82	0.65	1.00

Goodness of Fit Statistics

Degrees of Freedom = 62
 Minimum Fit Function Chi-Square = 139.01 (P = 0.00)
 Normal Theory Weighted Least Squares Chi-Square = 131.52 (P = 0.00)
 Estimated Non-centrality Parameter (NCP) = 69.52
 90 Percent Confidence Interval for NCP = (40.35 ; 106.45)
 Minimum Fit Function Value = 1.21
 Population Discrepancy Function Value (F0) = 0.60
 90 Percent Confidence Interval for F0 = (0.35 ; 0.93)
 Root Mean Square Error of Approximation (RMSEA) = 0.099
 90 Percent Confidence Interval for RMSEA = (0.075 ; 0.12)
 P-Value for Test of Close Fit (RMSEA < 0.05) = 0.00073
 Expected Cross-Validation Index (ECVI) = 1.65
 90 Percent Confidence Interval for ECVI = (1.39 ; 1.97)
 ECVI for Saturated Model = 1.58
 ECVI for Independence Model = 18.32
 Chi-Square for Independence Model with 78 Degrees of Freedom = 2081.13
 Independence AIC = 2107.13
 Model AIC = 189.52
 Saturated AIC = 182.00
 Independence CAIC = 2155.93
 Model CAIC = 298.37
 Saturated CAIC = 523.58
 Normed Fit Index (NFI) = 0.93
 Non-Normed Fit Index (NNFI) = 0.95
 Parsimony Normed Fit Index (PNFI) = 0.74
 Comparative Fit Index (CFI) = 0.96
 Incremental Fit Index (IFI) = 0.96
 Relative Fit Index (RFI) = 0.92
 Critical N (CN) = 76.12
 Root Mean Square Residual (RMR) = 0.098
 Standardized RMR = 0.066
 Goodness of Fit Index (GFI) = 0.85
 Adjusted Goodness of Fit Index (AGFI) = 0.78
 Parsimony Goodness of Fit Index (PGFI) = 0.58

The Modification Indices Suggest to Add the

Path to	from	Decrease in Chi-Square	New Estimate
Y2	infoqual	10.5	-0.40
Y4	user	8.5	0.45
Y8	user	8.5	0.42
Y8	usage	8.2	0.30

The Modification Indices Suggest to Add an Error Covariance

Between	and	Decrease in Chi-Square	New Estimate
Y11	Y2	11.7	-0.19
Y12	Y8	9.0	0.12

Time used: 0.140 Seconds

Tabel 5.1. Estimasi parameter dan varian kesalahan model awal

Varb	Estimasi (λ)				Err (\mathcal{E})	Solusi standar (λ)				Err (\mathcal{E})	R^2
	Serv	info	user	usage		serv	info	user	usage		
Y1	0.81				0.21 (0.046) 4.52	0.87				0.24	0.76
Y2	0.92* (0.089)@ 10.32				0.42 (0.075) 5.56	0.82				0.33	0.67
Y3	0.72 (0.085) 8.51				0.51 (0.077) 6.60	0.71				0.49	0.51
Y4	0.80 (0.11) 7.59				0.86 (0.12) 6.88	0.65				0.57	0.43

Varb	Estimasi (λ)				Solusi standar (λ)						
Y5		1.13			0.65 (0.11) 5.72		0.81			0.34	0.66
Y6		0.92 (0.11) 8.60			0.67 (0.10) 6.39		0.75			0.44	0.56
Y7		1.04 (0.11) 9.86			0.47 (0.086) 5.38		0.84			0.30	0.70
Y8		1.03 (0.11) 9.10			0.68 (0.11) 6.09		0.78			0.39	0.61
Y9			1.17		0.42 (0.10) 4.08			0.87		0.24	0.76
Y10			0.94 (0.11) 8.95		0.69 (0.11) 6.18			0.75		0.44	0.56
Y11			0.95 (0.098) 9.68		0.51 (0.091) 5.61			0.80		0.35	0.64
Y12				1.19	0.01				1.00	0.01	0.99
Y13				1.00 (0.04) 24.94	0.18 (0.024) 7.29				0.92	0.15	0.85

* = Muatan faktor @ = Kesalahan standar \mathcal{N} = Nilai t

Tabel 5.2. Variance Extracted dan Construct Reliability Awal

	Construct Reliability	Variance Extracted
Servqual	0.85	0.59
Infoqual	0.87	0.63
User	0.85	0.66
Usage	0.96	0.92
Uis	0.87	0.62

Tabel 5.3. Estimasi Parameter dan Varian Kesalahan model awal

	UIS (Estimasi) (γ)	Err-Var (ζ)	UIS (standar- solution) (γ)	Err-Var (ζ)	R^2
serv	0.84 (0.099) 8.48	0.30 (0.093) 3.20	0.84	0.30	0.70
info	0.82 * (0.11) @ 7.78 \mathcal{N}	0.33 (0.098) 3.37	0.82	0.33	0.67
user	0.82 (0.099) 8.28	0.32 (0.097) 3.32	0.82	0.32	0.68
usage	0.65 (0.090) 7.21	0.57 (0.097) 3.32	0.65	0.57	0.43

* = Muatan faktor @ = Kesalahan standar \mathcal{N} = Nilai t

Tabel 5.4. Hasil Pengujian Hipotesa Model

Var.	Nama	Lambda (λ)	Nilai t	H_0	Hipotesa Penelitian
Y1	Sikap	0.81	*		
Y2	Respon	0.92	10.32	ditolak	H1b diterima (Signifikan)
Y3	Handal	0.72	8.51	ditolak	H1c diterima (Signifikan)
Y4	Fasilitas	0.80	7.59	ditolak	H1d diterima (Signifikan)
Y5	Lengkap	1.13	*		
Y6	Kaitan	0.92	8.50	ditolak	H2b diterima (Signifikan)
Y7	Tepat	1.04	9.85	ditolak	H2c diterima (Signifikan)
Y8	Mutu	1.03	9.10	ditolak	H2d diterima (Signifikan)
Y9	Latpeng	1.17	*		
Y10	Tahpeng	0.94	8.95	ditolak	H3b diterima (Signifikan)
Y11	Parpeng	0.95	9.68	ditolak	H3c diterima (Signifikan)
Y12	Mdhker	1.19	*		
Y13	Prodker	1.00	24.94	ditolak	H4b diterima (Signifikan)

* = tidak dilakukan uji hipotesa, karena nilai λ telah ditetapkan sebelumnya sama dengan 1 dan nilai t tidak diestimasi.

	Gamma (γ)	Nilai t	H_0	Hipotesa Penelitian
Serv	0.84	8.48	ditolak	H5a diterima (Signifikan)
Info	0.82	7.78	ditolak	H5b diterima (Signifikan)
User	0.82	8.28	ditolak	H5c diterima (Signifikan)
Usage	0.65	7.21	ditolak	H5d diterima (Signifikan)

9. Model Akhir

Model Akhir studi kasus kita ini adalah modifikasi dari model awal, dimana variabel laten tetap terdiri atas 4 variabel laten endogen dan 1 variabel laten eksogen serta 12 variabel teramati. Metode estimasi yang digunakan untuk model akhir ini juga menggunakan *Maximum Likelihood*. Perbedaannya terletak pada berkurangnya satu variabel indikator pada variabel laten *servqual*. Karena lemahnya hasil pengukuran variabel *Tangibles* pada beberapa penelitian sebelumnya, sehingga pada model akhir ini variabel *Tangibles* dihilangkan.

Selanjutnya kita bisa melihat perbandingan nilai yang didapat dari hasil pengujian data model akhir yang telah dimodifikasi. Estimasi model pengukuran dan model struktural dilakukan untuk membuktikan tingkat kebaikan model berdasarkan Goodness of Fit Index.

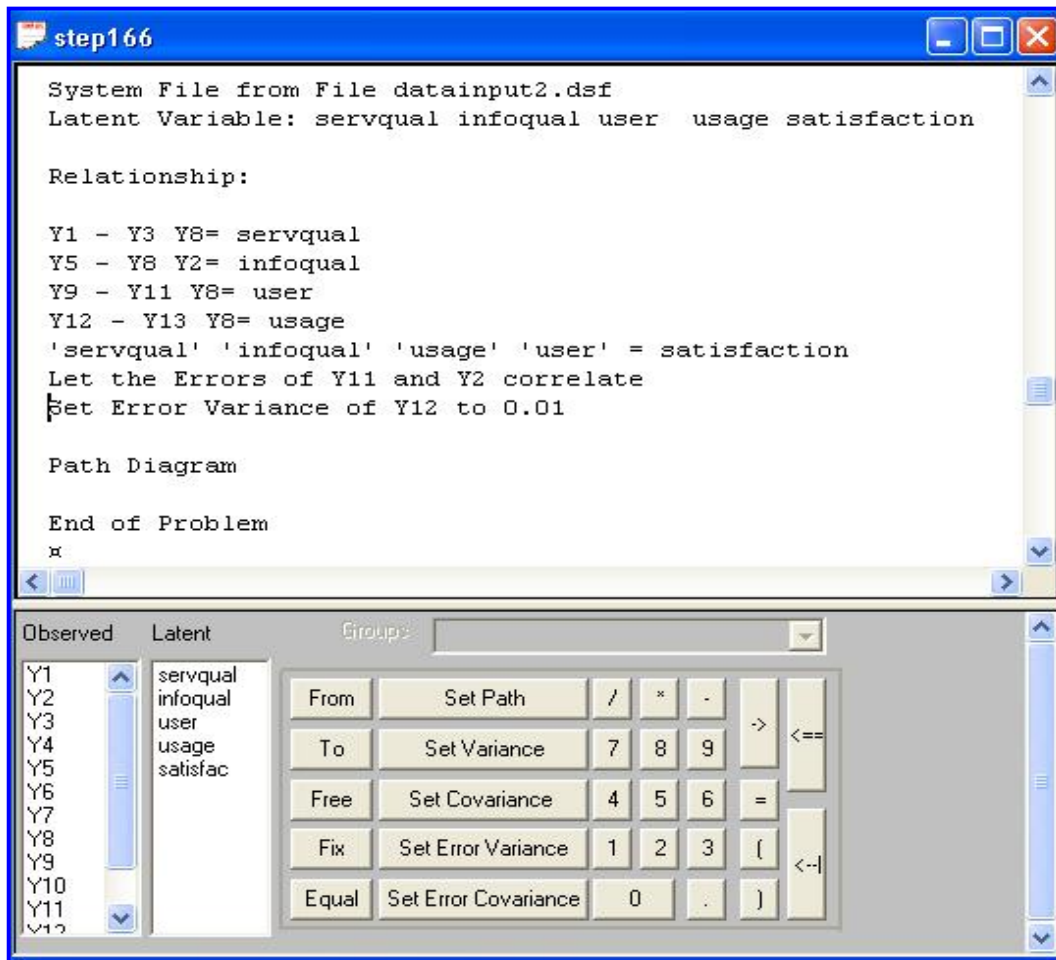

Gambar 5.19. Syntax yang Dibangun untuk Model Akhir

Kemudian akan diperoleh keluaran yang berbentuk laporan hasil pengukuran disertai dengan diagram Pathnya. Berikut ini adalah beberapa contoh output yang dihasilkan oleh model kedua yang telah kita modifikasi:

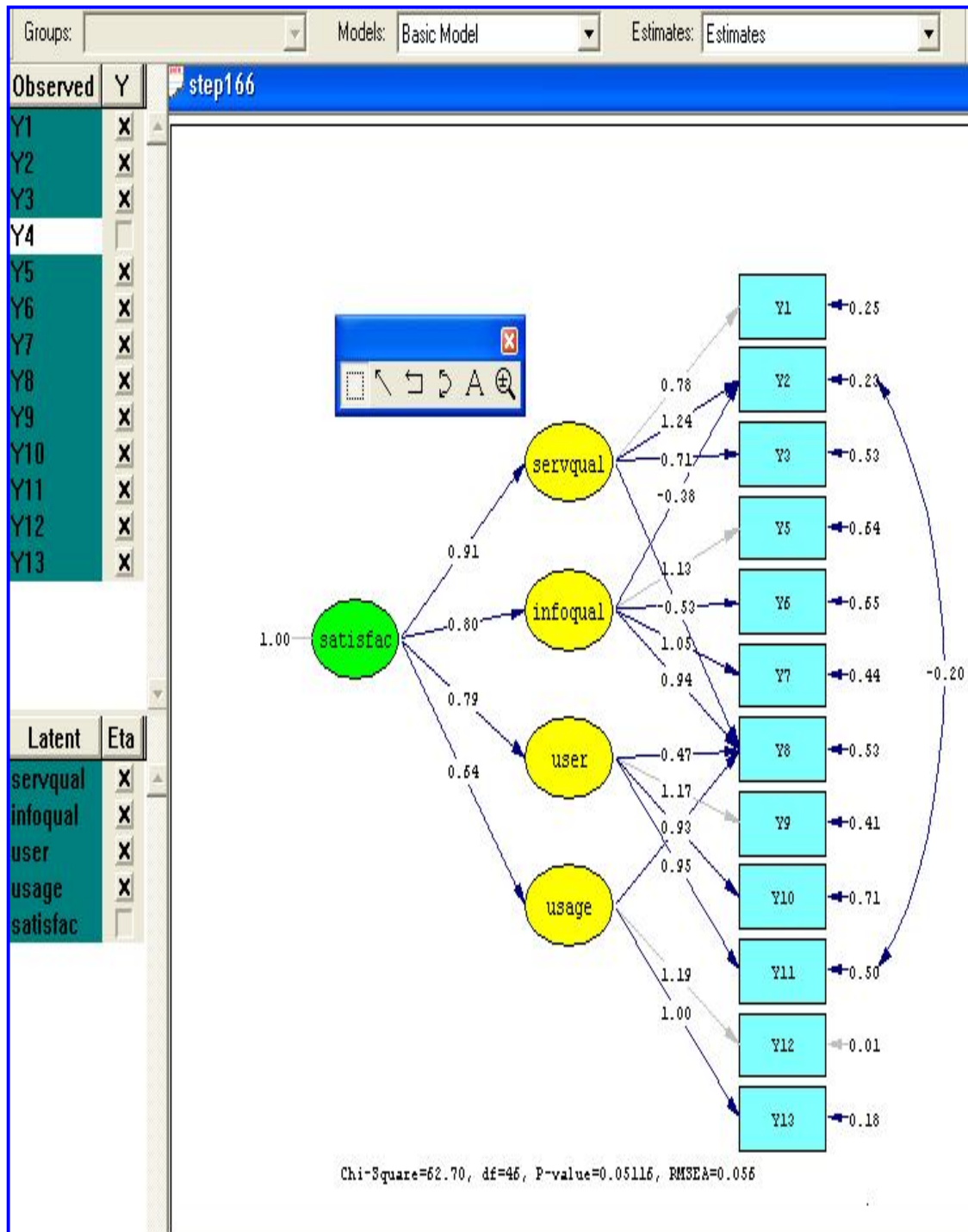

Gambar 5.20. Nilai Estimasi Model Akhir

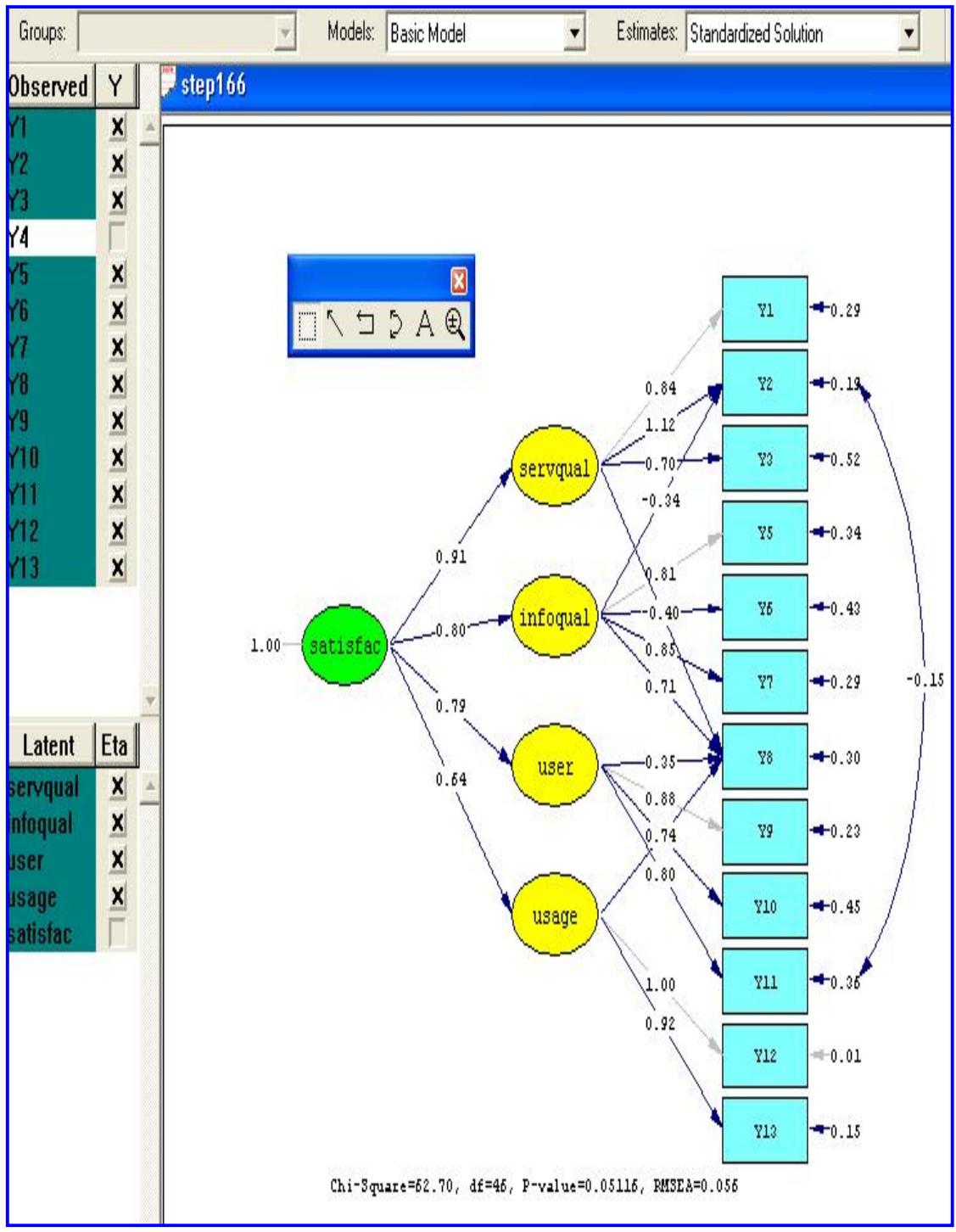

Gambar 5.21. Nilai standar solusi model Akhir

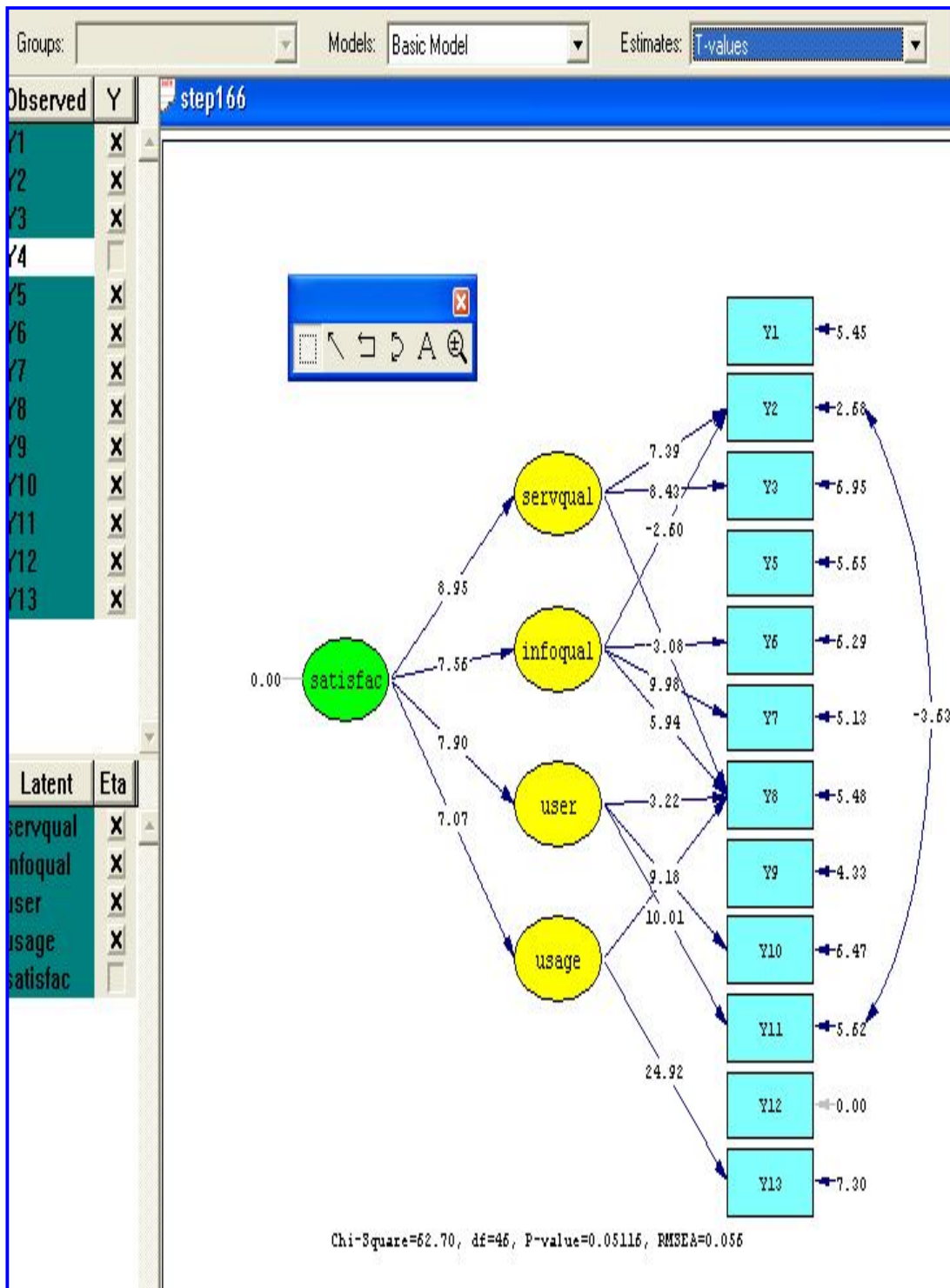

Gambar 5.22. Nilai Uji T model modifikasi

Nilai Estimasi Model Akhir Dengan Menggunakan Metode ML

The following lines were read from file D:\lthn1\step166.spj:

System File from File datainput2.dsf

Latent Variable: servqual infoqual user usage satisfaction

Relationship:

Y1 - Y3 Y8= servqual

Y5 - Y8 Y2= infoqual

Y9 - Y11 Y8= user

Y12 - Y13 Y8= usage

'servqual' 'infoqual' 'usage' 'user' = satisfaction

Let the Errors of Y11 and Y2 correlate

Set Error Variance of Y12 to 0.01

Path Diagram

End of Problem

Sample Size = 116

Covariance Matrix

	Y1	Y2	Y3	Y5	Y6	Y7
Y1	0.86					
Y2	0.77	1.26				
Y3	0.55	0.72	1.03			
Y5	0.68	0.65	0.51	1.91		
Y6	0.50	0.41	0.32	1.14	1.52	
Y7	0.65	0.55	0.55	1.16	0.94	1.54
Y8	0.54	0.44	0.49	1.08	0.96	1.08
Y9	0.61	0.75	0.67	1.00	0.68	0.92
Y10	0.42	0.55	0.54	0.67	0.49	0.50
Y11	0.42	0.36	0.47	0.71	0.44	0.75
Y12	0.64	0.64	0.44	0.57	0.40	0.58
Y13	0.59	0.60	0.42	0.50	0.40	0.59

Covariance Matrix

	Y8	Y9	Y10	Y11	Y12	Y13
Y8	1.75					
Y9	1.10	1.78				
Y10	0.68	1.07	1.57			
Y11	0.87	1.08	0.97	1.41		
Y12	0.81	0.68	0.59	0.65	1.44	
Y13	0.66	0.58	0.53	0.53	1.19	1.18

Number of Iterations = 26

LISREL Estimates (Maximum Likelihood)

Measurement Equations

$$Y1 = 0.78 * \text{servqual}, \text{ Errorvar.} = 0.25, R^2 = 0.71$$

(0.045)
5.45

$$Y2 = 1.24 * \text{servqual} - 0.38 * \text{infoqual}, \text{ Errorvar.} = 0.23, R^2 = 0.81$$

(0.17) (0.15) (0.086)
7.39 -2.60 2.68

$$Y3 = 0.71 * \text{servqual}, \text{ Errorvar.} = 0.53, R^2 = 0.48$$

(0.084) (0.077)
8.43 6.95

$$Y5 = 1.13 * \text{infoqual}, \text{ Errorvar.} = 0.64, R^2 = 0.66$$

(0.11)
5.65

Y6 = 0.93*infoqual, Errorvar.= 0.65 , R² = 0.57
 (0.11) (0.10)
 8.73 6.29

Y7 = 1.05*infoqual, Errorvar.= 0.44 , R² = 0.71
 (0.11) (0.086)
 9.98 5.13

Y8 = - 0.53*servqual + 0.94*infoqual + 0.47*user + 0.32*usage, Errorvar.= 0.53, R²= 0.70
 (0.17) (0.16) (0.15) (0.100) (0.096)
 -3.08 5.94 3.22 3.19 5.48

Y9 = 1.17*user, Errorvar.= 0.41 , R² = 0.77
 (0.095)
 4.33

Y10 = 0.93*user, Errorvar.= 0.71 , R² = 0.55
 (0.10) (0.11)
 9.18 6.47

Y11 = 0.95*user, Errorvar.= 0.50 , R² = 0.64
 (0.095) (0.089)
 10.01 5.62

Y12 = 1.19*usage, Errorvar.= 0.0100, R² = 0.99

Y13 = 1.00*usage, Errorvar.= 0.18 , R² = 0.85
 (0.040) (0.024)
 24.92 7.30

Error Covariance for Y11 and Y2 = -0.20
 (0.054)
 -3.63

Structural Equations

servqual = 0.91*satisfac, Errorvar.= 0.18 , R² = 0.82
 (0.10) (0.088)
 8.95 2.02

infoqual = 0.80*satisfac, Errorvar.= 0.36 , R² = 0.64
 (0.11) (0.10)
 7.56 3.52

user = 0.79*satisfac, Errorvar.= 0.38 , R² = 0.62
 (0.099) (0.10)
 7.90 3.71

usage = 0.64*satisfac, Errorvar.= 0.59 , R² = 0.41
 (0.090) (0.090)
 7.07 6.58

Correlation Matrix of Independent Variables

satisfac

 1.00

Covariance Matrix of Latent Variables

	servqual	infoqual	user	usage	satisfac
	-----	-----	-----	-----	-----
servqual	1.00				
infoqual	0.72	1.00			
user	0.71	0.63	1.00		
usage	0.58	0.51	0.50	1.00	
satisfac	0.91	0.80	0.79	0.64	1.00

Goodness of Fit Statistics

Degrees of Freedom = 46
Minimum Fit Function Chi-Square = 71.85 (P = 0.0087)
Normal Theory Weighted Least Squares Chi-Square = 62.70 (P = 0.051)
Estimated Non-centrality Parameter (NCP) = 16.70
90 Percent Confidence Interval for NCP = (0.0 ; 41.54)

Minimum Fit Function Value = 0.62
Population Discrepancy Function Value (F0) = 0.15
90 Percent Confidence Interval for F0 = (0.0 ; 0.36)
Root Mean Square Error of Approximation (RMSEA) = 0.056
90 Percent Confidence Interval for RMSEA = (0.0 ; 0.089)
P-Value for Test of Close Fit (RMSEA < 0.05) = 0.36

Expected Cross-Validation Index (ECVI) = 1.10
90 Percent Confidence Interval for ECVI = (0.96 ; 1.32)
ECVI for Saturated Model = 1.36
ECVI for Independence Model = 15.81

Chi-Square for Independence Model with 66 Degrees of Freedom = 1793.98
Independence AIC = 1817.98
Model AIC = 126.70
Saturated AIC = 156.00
Independence CAIC = 1863.02
Model CAIC = 246.81
Saturated CAIC = 448.78

Normed Fit Index (NFI) = 0.96
Non-Normed Fit Index (NNFI) = 0.98
Parsimony Normed Fit Index (PNFI) = 0.67
Comparative Fit Index (CFI) = 0.99
Incremental Fit Index (IFI) = 0.99
Relative Fit Index (RFI) = 0.94

Critical N (CN) = 114.96

Root Mean Square Residual (RMR) = 0.067
Standardized RMR = 0.048
Goodness of Fit Index (GFI) = 0.92
Adjusted Goodness of Fit Index (AGFI) = 0.86
Parsimony Goodness of Fit Index (PGFI) = 0.54

Time used: 0.060 Seconds

Rangkuman hasil pengolahan dan estimasi ML terhadap model akhir adalah sebagai berikut:

Tabel 5.5. Estimasi parameter dan varian kesalahan model akhir

Varb	Estimasi (λ)				Err (ε)	Solusi standar (λ)				Err (ε)	R^2
	serv	info	user	usage		serv	info	user	usage		
Y1	0.78				0.25 (0.045) 5.45	0.84				0.29	0.71
Y2	1.24* (0.17)@ 7.39/	-0.38 (0.15) -2.60			0.23 (0.086) 2.68	1.12				0.19	0.81
Y3	0.71 (0.084) 8.43				0.53 (0.077) 6.95	0.70				0.52	0.48
Y5		1.13			0.64 (0.11) 5.65		0.81			0.34	0.66
Y6		0.93 (0.11) 8.73			0.65 (0.10) 6.29		0.76			0.43	0.57
Y7		1.05 (0.11) 9.98			0.44 (0.086) 5.13		0.85			0.29	0.71
Y8	-0.53 (0.17) -3.08	0.94 (0.16) 5.94	0.47 (0.16) 5.94	0.32 (0.100) 3.19	0.53 (0.096) 5.48		0.71			0.30	0.70
Y9			1.17		0.41 (0.095) 4.33			0.88		0.23	0.77
Y10			0.93 (0.10) 9.18		0.71 (0.11) 6.47			0.74		0.45	0.55
Y11			0.95 (0.095) 10.01		0.50 (0.089) 5.62			0.80		0.36	0.64
Y12				1.19	0.01				1.00	0.01	0.99
Y13				1.00 (0.040) 24.92	0.18 (0.024) 7.30				0.92	0.15	0.85

* = Muatan faktor @ = Kesalahan standar / = Nilai t

Tabel 5.6. Penghitungan Variance Extracted dan Construct Reliability

	Construct Reliability	Variance Extracted
servqual	0.88	0.71
infoqual	0.88	0.64
user	0.85	0.65
usage	0.92	0.92
uis	0.87	0.62

Tabel 5.7. Estimasi Parameter dan Varian Kesalahan model akhir

	UIS (Estimasi) (γ)	Err-Var (ζ)	UIS (standar solution) (γ)	Err-Var (ζ)	R^2
serv	0.91 (0.10) 8.95	0.18 (0.88) 2.02	0.91	0.18	0.82
info	0.80 * (0.11) @ 7.56 ↗	0.36 (0.10) 3.52	0.80	0.36	0.64
user	0.79 (0.099) 7.90	0.38 (0.10) 3.71	0.79	0.38	0.62
usage	0.64 (0.090) 7.07	0.59 (0.090) 6.58	0.64	0.59	0.41

* = Muatan faktor @ = Kesalahan standar ↗ = Nilai t

Penghitungan Variance Extracted dan Construct Reliability pada model UISML akhir dilakukan dengan menggunakan rumus dan data yang terdapat dalam table 5.10. dan 5.11 sebagai contoh :

- Construct Reliability Infoqual
 $(\sum \text{Standardized Loading})^2 = (0.84 + 1.12 + 0.70)^2 = 2.66^2 = 7.08$
 $\sum \varepsilon_j = 0.29 + 0.19 + 0.52 = 1.0$
 Construct Reliability Infoqual = $\frac{7.08}{7.08+1.0} = 0.88$
- Variance Extracted Infoqual
 $\sum \text{Standardized Loading}^2 = 0.84^2 + 1.12^2 + 0.70^2 = 2.45$
 $\sum \varepsilon_j = 0.29 + 0.19 + 0.52 = 1.0$
 Variance Extracted Infoqual = $\frac{2.45}{2.45+1.0} = 0.71$

10. Pembahasan

Evaluasi terhadap uji kecocokkan rancangan awal model dimulai dengan memeriksa nilai t dari muatan-muatan faktor yang terdapat dalam model. Nilai t yang tinggi pada semua muatan faktor yang terdapat pada pengukuran model ini membuktikan bahwa faktor-faktor tersebut mewakili konsep bangunan yang mendasarinya. Nilai t telah melebihi nilai kritisnya 1.96 untuk tingkat signifikan 0.05 atau 2.576 untuk tingkat signifikan 0.01. Karena nilai $t \geq 1.96$ berarti variabel yang bersangkutan dalam penelitian ini secara signifikan mempunyai hubungan dengan

konsep rancangan yang terkait, sekaligus merupakan verifikasi hubungan antara variabel dan konstruk yang telah didefinisikan.

Pemeriksaan terhadap tingginya muatan faktor dari setiap variabel dilakukan untuk melihat kekuatan hubungan antara variabel dengan konstraknya. Muatan faktor dikatakan tinggi jika nilainya lebih dari 0.70. Dalam model awal ini dibuktikan bahwa muatan faktor dari setiap ≥ 0.70 . Hasil uji validasi kecocokan model awal dan hasil pengukuran terhadap model struktural membuktikan bahwa koefisien korelasi yang diestimasi dari model awal adalah signifikan. Laporan ini dapat dilihat pada tabel 5.5, tabel 5.6 dan tabel 5.7. Dengan demikian variabel-variabel yang dirancang dalam model awal terbukti memiliki konsep bangunan yang kuat untuk dijadikan model penelitian. Karena variabel tersebut memiliki validitas yang baik terhadap konstruk (variabel laten) karena memiliki nilai $t \geq 1.96$ dan muatan faktor ≥ 0.70 juga nilai R^2 yang membuktikan gambaran kecocokan relatif dari persamaan struktural.

Uji reabilitas dilakukan untuk melihat kekonsistenan suatu pengukuran. Reliabilitas yang tinggi menunjukkan bahwa indikator mempunyai kekonsistenan yang tinggi dalam mengukur konstruk variabel latennya. Evaluasi terhadap reliabilitas dilakukan dengan menggunakan 2 jenis pengukuran yaitu; *composite reliability measure* atau *construct reliability measure* dan *variance extracted measure*. Pada model awal dibuktikan bahwa ukuran reliabilitas konstruk memiliki nilai *construct reliability* ≥ 0.70 dan nilai *variance extracted* ≥ 0.50 (lihat table 5.6).

Setelah dilakukan modifikasi terhadap model awal seperti yang disaran oleh output PRELIS sebelumnya;

The Modification Indices Suggest to Add the			
Path to	from	Decrease in Chi-Square	New Estimate
Y2	infoqual	10.5	-0.40
Y4	user	8.5	0.45
Y8	user	8.5	0.42
Y8	usage	8.2	0.30

The Modification Indices Suggest to Add an Error Covariance			
Between	and	Decrease in Chi-Square	New Estimate
Y11	Y2	11.7	-0.19
Y12	Y8	9.0	0.12

Maka dihasilkan pengukuran model akhir yang juga memiliki muatan faktor ≥ 0.70 . Hasil uji validasi model kecocokan dan model struktural pada model akhir juga membuktikan bahwa koefisien korelasi yang diestimasi dari model akhir juga sangat signifikan. Lapornya dapat dilihat pada tabel 5.5, dan tabel 5.7.

Dengan demikian variabel yang dirancang dalam model akhir telah memperkuat bukti bahwa model kepuasan pengguna (UIS) dapat diterapkan untuk pengukuran keberhasilan sistem informasi. Variabel tersebut memiliki validitas yang baik karena memiliki nilai $t \geq 1.96$, muatan faktor ≥ 0.70 dan juga nilai R^2 yang cukup baik.

Sedangkan hasil uji reliabilitas terhadap model akhir adalah sebagai berikut; variable 'servqual' memiliki CR=0.88 dan VE=0.71, variable 'infoqual' memiliki CR=0.88 dan VE=0.64, variable 'user' memiliki CR=0.85 dan VE=0.65, variable 'usage' memiliki CR=0.92 dan VE=0.92, variable UIS memiliki CR=0.87 dan VE=0.62 (lihat tabel 5.7). Dengan demikian telah dibuktikan bahwa nilai *construct reliability* dan nilai *variance extracted* dalam Model UIS akhir memiliki reliabilitas yang tinggi.

Untuk memudahkan perbandingan, telah dirangkum nilai statistik GOF pada tabel 5.8, yang berkaitan dengan model awal dan model akhir. Perbandingan statistik GOF akan dimulai dengan membahas perbandingan chi-square pada model. Nilai chi-square yang tinggi dibandingkan dengan derajat kebebasannya menandakan bahwa matriks yang diamati dan matriks yang diestimasi berbeda. Sedangkan nilai chi-square yang rendah menandakan kedua matriks tersebut secara statistik tidak berbeda. Estimasi dalam SEM bertujuan untuk mencari perbedaan antara kedua matriks tersebut yang tidak signifikan. Perbedaan yang tidak signifikan menandakan bahwa kedua matriks tersebut serupa atau memiliki kecocokan yang baik.

Berkaitan dengan hal ini, Joreskog dan Sorbom (1996) menyarankan chi-square dipakai sebagai suatu pengukuran kecocokan secara menyeluruh model terhadap data dan bukan sebagai uji statistik. Pengukuran ini bertujuan untuk menunjukkan besar kecilnya perbedaan

(jarak) antara matriks kovarian (korelasi) sampel dengan matriks kovarian (korelasi) model yang telah diestimasi. Dengan demikian, nilai chi-square yang rendah menunjukkan tingkat kecocokan model terhadap data yang baik, sedangkan nilai chi-square yang tinggi menunjukkan tingkat kecocokan yang jelek. Dari tabel 5.8 dapat dilihat bahwa nilai chi-square model akhir memiliki nilai yang lebih rendah.

Sementara itu, ukuran kecocokan lainnya selain chi-square yang ada dalam kelompok ukuran kecocokan absolute adalah NCP, SNCP, RMSR, RMSEA, ECVI. Perbandingan antara nilai model awal dan model akhir menunjukkan bahwa tingkat kecocokan yang diperoleh oleh model akhir lebih baik dibandingkan dengan model awal.

Ukuran kecocokan inkremental yang terdiri dari NNFI, NFI, AGFI, RFI, IFI dan CFI juga secara menyeluruh menunjukkan bahwa tingkat kecocokan yang diperoleh oleh model akhir lebih baik dibandingkan dengan model awal. Pada ukuran kecocokan inkremental, hampir semua menunjukkan kecocokan yang baik, hanya AGFI saja yang menunjukkan tingkat kecocokan yang marjinal.

Terakhir untuk pengukuran kecocokan parsimoni, terdiri atas PGFI, Normed chi-square, PNFI, AIC dan CAIC. Sebagian besar tingkat kecocokan untuk model akhir lebih baik dibandingkan dengan tingkat kecocokan model awal. Kecuali pada dua ukuran berikut, PGFI dan PNFI, dimana model awal memiliki nilai kecocokan yang sedikit lebih baik dibandingkan model akhir. Untuk lebih jelas dan lengkapnya informasi tentang hasil perbandingan GOF antara model awal dan model akhir serta perbandingan hasil pengukuran dapat dilihat pada tabel 5.8.

Tabel 5.8. Perbandingan Statistik GOF model awal dan model akhir.

Ukuran GOF	Target Tingkat Kecocokan	UISML0	UISML1
Absolute Fit Measures			
χ^2	Semakin kecil semakin baik	131.01 (62)	62.70 (46)
NCP	Semakin kecil semakin baik	69.52	16.70
SNCP	Semakin kecil semakin baik	1.21	0.62
GFI	GFI \geq 0.90	0.85	0.92
RMSR	RMSR \leq 0.05	0.098	0.067
RMSEA	RMSEA $<$ 0.08	0.099	0.056
ECVI	Semakin kecil semakin baik	1.65	1.10
Incremental Fit Measures			
TLI/NNFI	NNFI \geq 0.90	0.95	0.98
NFI	NFI \geq 0.90	0.93	0.96
AGFI	AGFI \geq 0.90	0.78	0.86
RFI	RFI \geq 0.90	0.92	0.94
IFI	IFI \geq 0.90	0.96	0.99
CFI	CFI \geq 0.90	0.96	0.99
Parsimonious Fit Measures			
PGFI	Semakin tinggi semakin baik	0.58	0.54
Normed χ^2	Batas bawah: 1.0 Batas atas: 3.0	2.11	1.36
PNFI	Semakin tinggi semakin baik	0.74	0.67
AIC	Semakin kecil (positif) semakin baik	189.52	126.70
CAIC	Semakin kecil (positif) semakin baik	298.37	246.81

11. Penilaian Indikator Statistik GOF pada model Awal dan Model Akhir

Evaluasi suatu model fit pada structural equation modeling merupakan masalah yang sangat sulit dan belum terpecahkan. Beberapa ahli mempunyai pendapat berbeda dalam memberikan pandangan tentang indikator model fit.

A. Chi-Square

Nilai chi-square ini menunjukkan adanya penyimpangan antara sampel covariance matrix dan model (fitted) covariance matrix. Chi-square merupakan ukuran mengenai buruknya fit suatu model. Nilai chi-square sebesar 0 menunjukkan bahwa model memiliki fit yang sempurna (*perfect fit*). Perbandingan model awal dan model akhir yang menghasilkan dua jenis chi-square yaitu;

1. Degrees of Freedom = 62
Minimum Fit Function Chi-Square = 139.01 (P = 0.00)
Normal Theory Weighted Least Squares Chi-Square = 131.52 (P = 0.00)
2. Degrees of Freedom = 46
Minimum Fit Function Chi-Square = 71.85 (P = 0.0087)
Normal Theory Weighted Least Squares Chi-Square = 62.70 (P = 0.051)

B. Goodness of Fit Indices

Goodness of fit indices (GFI) merupakan suatu ukuran mengenai ketepatan model dalam menghasilkan observed matriks kovarians. Nilai GFI harus berkisar antara 0 dan 1. walaupun secara teori GFI mungkin memiliki nilai negative tetapi hal tersebut seharusnya tidak terjadi, karena model yang memiliki nilai GFI negative adalah model yang paling buruk dari seluruh model yang ada (Joreskog dan Sorbom,1996). Model yang memiliki nilai GFI >0,90 menunjukkan fit suatu model yang baik.

1. Goodness of Fit Index (GFI) = 0.85
2. Goodness of Fit Index (GFI) = 0.92

a. Adjusted Goodness of Fit Index

Adjusted Goodness of Fit Index (AGFI) adalah sama seperti GFI, tetapi telah menyesuaikan pengaruh degrees of freedom pada suatu model. Model yang fit adalah yang memiliki nilai AGFI = 0,90.

1. Adjusted Goodness of Fit Index (AGFI) = 0.78
2. Adjusted Goodness of Fit Index (AGFI) = 0.86

b. Root Mean Square Error of Approximation (RMSEA)

RMSEA merupakan indikator model fit yang paling informatif. RMSEA mengukur penyimpangan nilai parameter pada suatu model dengan matriks kovarians populasinya. Nilai RMSEA > 0,05 mengidentifikasi adanya model yang fit dan nilai RMSEA yang berkisar antara 0,08 menyatakan bahwa model memiliki perkiraan kesalahan yang reasonable. Nilai RMSEA yang berkisar antara 0,08–0,1 mengindikasikan model memiliki fit yang cukup, tetapi jika nilai RMSEA >0,1 menyatakan bahwa nilai fit suatu model amat jelek. Berikut perbandingan hasil RMSEA kedua model;

1. Root Mean Square Error of Approximation (RMSEA) = 0.099
90 Percent Confidence Interval for RMSEA = (0.075 ; 0.12)
P-Value for Test of Close Fit (RMSEA < 0.05) = 0.00073
2. Root Mean Square Error of Approximation (RMSEA) = 0.056
90 Percent Confidence Interval for RMSEA = (0.0 ; 0.089)
P-Value for Test of Close Fit (RMSEA < 0.05) = 0.36

c. Expected Cross Validation Index

Expected cross validation index (ECVI) digunakan untuk menilai kecenderungan bahwa model, pada sample tunggal, dapat divalidasi silang pada ukuran sample dan populasi yang sama. ECVI mengukur penyimpangan antara fitted (model) covarian matriks pada sample yang dianalisis dan kovarians matriks yang akan diperoleh pada sample lain tetapi memiliki ukuran sampel yang sama besar. Nilai ECVI model yang lebih rendah daripada ECVI yang diperoleh pada saturated model dan independence model, mengindikasikan bahwa model adalah fit. Berikut ini adalah perbandingan nilai ECVI pada kedua model;

1. Expected Cross-Validation Index (ECVI) = 1.65
 90 Percent Confidence Interval for ECVI = (1.39 ; 1.97)
 ECVI for Saturated Model = 1.58
 ECVI for Independence Model = 18.32
2. Expected Cross-Validation Index (ECVI) = 1.10
 90 Percent Confidence Interval for ECVI = (0.96 ; 1.32)
 ECVI for Saturated Model = 1.36
 ECVI for Independence Model = 15.81

d. Akaike's Information Criterion (AIC) dan CAIC

AIC dan CAIC digunakan untuk menilai mengenai masalah parsimony dalam penilaian model fit. AIC dan CAIC digunakan dalam perbandingan dari dua atau lebih model, dimana nilai AIC dan CAIC yang lebih kecil daripada AIC model saturated dan independence berarti memiliki model fit yang lebih baik. Berikut ini adalah perbandingan nilai AIC dan CAIC pada kedua model;

1. Chi-Square for Independence Model with 78 Degrees of Freedom = 2081.13
 Independence AIC = 2107.13
 Model AIC = 189.52
 Saturated AIC = 182.00
 Independence CAIC = 2155.93
 Model CAIC = 298.37
 Saturated CAIC = 523.58
2. Chi-Square for Independence Model with 66 Degrees of Freedom = 1793.98
 Independence AIC = 1817.98
 Model AIC = 126.70
 Saturated AIC = 156.00
 Independence CAIC = 1863.02
 Model CAIC = 246.81
 Saturated CAIC = 448.78

e. Fit Index

Normed Fit Indeks (NFI) dan Comparative Fit Indeks (CFI) berkisar antara 0 dan 1 yang diturunkan dari perbandingan antara model yang dihipotesiskan dan independence model. Suatu model dikatakan fit apabila memiliki nilai NFI dan CFI > 0,90. Sedangkan Non-Normed Fit Indeks (NNFI), digunakan untuk mengatasi permasalahan yang timbul akibat kompleksitas model. Begitu pula Incremental Fit Indeks (IFI) digunakan untuk mengatasi masalah parsimony dan ukuran sampel yang berhubungan dengan NFI. Sedangkan Relative Fit Indeks (RFI) digunakan

untuk mengukur fit dimana nilainya antara 0 sampai 1. Berikut ini perbandingan ukuran fit dari kedua model;

1. Normed Fit Index (NFI) = 0.96
Non-Normed Fit Index (NNFI) = 0.98
Parsimony Normed Fit Index (PNFI) = 0.67
Comparative Fit Index (CFI) = 0.99
Incremental Fit Index (IFI) = 0.99
Relative Fit Index (RFI) = 0.94

2. Normed Fit Index (NFI) = 0.93
Non-Normed Fit Index (NNFI) = 0.95
Parsimony Normed Fit Index (PNFI) = 0.74
Comparative Fit Index (CFI) = 0.96
Incremental Fit Index (IFI) = 0.96
Relative Fit Index (RFI) = 0.92

12. Penghitungan Nilai Variabel UIS

Modifikasi yang dilakukan pada model UIS telah menghasilkan model UIS seperti yang terlihat dalam bentuk diagram lintasan pada gambar 4.20, 4.21 dan 4.22. Dengan memperhatikan nilai GOF model UIS pada tabel 4.13. validitas variabel-variabel yang ditunjukkan dengan muatan faktor standar pada tabel 4.10 dan tabel 4.12. serta reliabilitas yang ditunjukkan pada tabel 4.11. maka dapat disimpulkan bahwa model UIS akhir yang dikonsepsi dan dihasilkan merupakan model yang baik, reliable dan andal.

Karena melalui model UIS ini dapat dihitung nilai variabel laten UIS dan variabel laten lainnya yaitu Servqual, Infoqual, user dan Usage. Nilai variabel-variabel laten tersebut didapat dengan mengubah nilai variabel teramati yang diperoleh dari hasil kuesioner dari setiap responden ke dalam nilai Z-scorenya, kemudian mengalihkannya dengan nilai faktor dari hubungan antara variabel teramati dan variabel laten terkait. Khusus dalam model 2ndCFA maka untuk memperoleh nilai variabel laten tingkat kedua dapat dilakukan dengan mengalihkan nilai Z variabel laten tingkat pertama untuk setiap responden dengan nilai faktor terkait. Penghitungan

nilai dengan cara ini akan menghasilkan nilai yang relatif, dimana *mean* atau rata-rata dari keseluruhan observasi adalah nol, sedangkan *mean* dari kelompok dalam sampel merupakan nilai relatif terhadap *mean* keseluruhan tersebut (Joreskog dan Sorbom 1993).

Nilai akhir dari masing-masing kelompok di dalam sampel dapat dihitung dengan formula transformasi yang ada pada tabel 4.14. Formula transformasi dibentuk berdasarkan alasan bahwa nilai-nilai teramati merupakan skala likert 7 posisi dengan nilai -3,-2,-1,0,1,2,3 sedangkan konstanta pada formula transformasi didapat dari *mean* keseluruhan dari perhitungan nilai variabel teramati untuk setiap responden dikalikan nilai faktor yang terkait. Nilai faktor untuk setiap hubungan antar variabel yang ada pada model UIS dapat diperoleh melalui program yang dijalankan pada LISREL-8.71. dengan menggunakan rumus perhitungan pada table 5.15. sehingga dapat dihitung nilai variabel UIS, Servqual, Infoqual, user dan Usage untuk setiap responden. Dari nilai variabel untuk setiap responden tersebut dapat dihitung nilai rata-rata (*mean*) dan standar deviasi baik secara keseluruhan maupun menurut kelompok yang telah kita kelompokkan sebelumnya. Misalnya pengkelompokkan berdasarkan usia, pekerjaan, tingkat pendidikan dan sebagainya sesuai dengan tujuan yang hendak kita peroleh.

Tabel 5.9. Penghitungan Nilai UIS

Transformasi dan penghitungan di bawah ini dilakukan pada setiap kasus dari responden.

- ♦ Transformasi nilai teramati Y ke dalam Z-scorenya (ZY)

$$ZY_i = (Y_i - \text{mean}(Y_i)) / \text{simpangan baku}(Y_i)$$
 dimana $i = 1, \dots, 13$
- ♦ Penghitungan nilai variabel laten tingkat pertama

$$\text{Nservqual} = \text{FS} \cdot \text{ZY}_1 + \text{FS} \cdot \text{ZY}_2 + \text{FS} \cdot \text{ZY}_3 + \text{FS} \cdot \text{ZY}_4$$

$$\text{Ninfoqual} = \text{FS} \cdot \text{ZY}_5 + \text{FS} \cdot \text{ZY}_6 + \text{FS} \cdot \text{ZY}_7 + \text{FS} \cdot \text{ZY}_8$$

$$\text{Nuser} = \text{FS} \cdot \text{ZY}_9 + \text{FS} \cdot \text{ZY}_{10} + \text{FS} \cdot \text{ZY}_{11}$$

$$\text{Nusage} = \text{FS} \cdot \text{ZY}_{12} + \text{FS} \cdot \text{ZY}_{13}$$

- ♦ Transformasi nilai variabel laten tingkat pertama ke dalam Z-scorenya

$$ZNservqual = (Nservqual - \text{mean}(Nservqual)) / \text{simpangan baku}(Nservqual)$$

$$ZNinfoqual = (Ninfoqual - \text{mean}(Ninfoqual)) / \text{simpangan baku}(Ninfoqual)$$

$$ZNuser = (Nuser - \text{mean}(Nuser)) / \text{simpangan baku}(Nuser)$$

$$ZNusage = (Nusage - \text{mean}(Nusage)) / \text{simpangan baku}(Nusage)$$
- ♦ Penghitungan nilai KIP

$$NKIP = FS * ZNservqual + FS * ZNinfoqual + FS * ZNuser + FS * ZNusage$$

BAB VI.

PENUTUP

Berikut ini adalah kesimpulan yang bisa kita ambil dari contoh kasus penelitian yang menggunakan LISREL;

- Penilaian terhadap muatan faktor dari setiap variabel harus >0.70 untuk membuktikan bahwa variabel indikator secara signifikan mempunyai hubungan dan dapat mewakili konsep bangunan yang mendasarinya. Dengan kata lain model yang dirancang memiliki validitas yang cukup baik terhadap konstruk.
- Uji reliabilitas dilakukan untuk memperlihatkan kekonsistenan pengukuran yang baik pada model yang kita buat, nilai *construct reliability* dan *variance extracted* harus ≥ 0.70 dan ≥ 0.50 .
- Pengujian terhadap model struktural didasarkan atas pengujian terhadap nilai t dan nilai maksimum koefisien pada solusi standar pada model yang dibangun, serta tingginya nilai R^2 .
- Berdasarkan hasil pengujian secara keseluruhan terhadap model struktural dan model pengukuran, kita bisa menyimpulkan seberapa besar keberhasilan respesifikasi terhadap model modifikasi, penilaian juga didasarkan atas perbandingan nilai estimasi Goodness of Fit –nya.
- Yang perlu diperhatikan dalam penelitian LISREL adalah pentingnya menggunakan data yang kompleks, besar dan melakukan pengujian dengan berbagai macam metode estimasi yang tersedia, untuk mendapatkan nilai dan hasil pengukuran sebuah model penelitian yang lebih sempurna.

DAFTAR PUSTAKA

- Bailey, J. E., & Pearson, S. W. (1983). Development of a tool for measuring and analyzing computer user satisfaction. *Management Science*, 29(5), 530-545.
- Baroundi, J.J. dan W.J. Orlikowski. 1988. A Short-form Measure of User Information Satisfaction: A Psychometric Evaluation and Notes on Use. *Journal of MIS* 4(4): 44-59.
- Bentler, P.M. 1980. Multivariate Analysis With Laten Variables: Causal modeling. *Annualreviewpsychology*.31:419-456.LosAngeles, California.
- Bollen, Kenneth.A. 1989. *Structural Equations With Latent Variables*. A Wiley-Interscience Publication. John Wiley and Sons New York.
- Bollen, Kenneth.A. 1996. An Alternative two stage least squares (2sls) estimator for latent variabel equations. *Psychometrica* 61: 109-121.
- DeLone,W.H.,& McLean,E.R. (1992). Information systems success: The quest for the dependent variable. *Information Systems Research*,3(1),60-95.
- Ghozali. Imam. dan Fuad 2005. *Structural Equation Modeling: Teori, Konsep, dan Aplikasi dengan Program LISREL*. Badan Penerbit Undip, Semarang.
- Hair, JR. Joseph F., Anderson, Rolph E., Tatham, Ronald L. and Black, William. C. 1998. *Multivariat Data Analysis*. Prentice-Hall International, Inc.
- Iivari, J. dan Ervasti, I. 1994. User Information Satisfaction: IS Implementability and Effectiveness. *Information and Management*, 27: 205-220.
- Joreskog, Karl.G. 1977. *Structure Equation models in the Social Sciences: Specification, Estimation and Testing*. North-Holland Publishing Company: 265-287.
- Joreskog, Karl.G. 1981. Analysis of covariance Structures. *Scand J Statist*.8: 65-92.
- Joreskog, Karl.G. dan D. Sorbom. 1993. *LISREL 8. Structural Equation Modeling With the SIMPLIS Command Languages*. Chicago: SSI, Inc.
- Joreskog, K.G. dan D. Sorbom. 1996. *LISREL8: User's Reference Guide*: SSI, Inc.

CURRICULUM VITAE AUTHOR



Ramadiani, S.Pd., M.Sc., M.Kom. Ph.D.

Born in Palembang on November 1, 1972. Work as a Lecturer at the Faculty of Computer Science and Information Technology (FKTI) Mulawarman University.

E-mail: ramadiani@fkti.unmul.ac.id,
ilkom.ramadiani@gmail.com
mami_ugm04@yahoo.com.

Hp: 085250501973. Ramadiani received her PhD in Computer Science and Information System from University Putra Malaysia in 2015. She graduated from Indonesia University in 2000 and graduated from Gadjah Mada University in 2005 for her Computer Master. She currently works at the Department of Computer Science in Computer Science and Information System Faculty, Mulawarman University since December 2001 until now. Ramadiani does her research in Software Engineering, Information Systems (Business Informatics) and Human-computer Interaction. Her current project is 'e-Learning and Decision Support System'.

Scopus ID: 57160272300

SINTA ID: 5974501

Google Scholar ID: 9XnXoJgAAAAJ&hl

<https://scholar.google.co.id/citations?user=9XnXoJgAAAAJ&hl=id>

<http://orcid.org/0000-0003-1564-2260>

https://www.researchgate.net/profile/Ramadiani_Ramadiani/scores

lampiran 1. Contoh Proposal Hibah DIKTI

Kode>Nama Rumpun ilmu: 459/ Ilmu Komputer
Bidang Fokus : Ilmu Komputer

**USULAN
PENELITIAN PASCADOKTOR**



**Pemanfaatan Konten e-Learning
Pada Smartphone**

PENELITI PENGUSUL

Ramadiani, M.Kom., Ph.D

NIDN. 0001117202

PENELITI PENGARAH

Dr. Achmad Nizar Hidayanto, M.Kom

NIDN.0024077601

**FAKULTAS ILMU KOMPUTER DAN TEKNOLOGI INFORMASI
UNIVERSITAS MULAWARMAN
JUNI 2017**

HALAMAN PENGESAHAN
PENELITIAN PASCA DOKTOR

Judul Penelitian : Pemanfaatan Konten e-Learning pada Smartphone
Bidang Fokus : Teknologi Informasi dan Komunikasi
Kode>Nama Rumpun Ilmu : 459/Illmu Komputer
Ketua Peneliti
a. Nama Lengkap : RAMADIANI S.Pd, M.Kom, Ph.D
b. NIDN : 0001117202
c. Jabatan Fungsional : Lektor
d. Program Studi : Ilmu Komputer
e. Nomor HP/Surel : 085250501973/ilkom.ramadiani@gmail.com
Peneliti Pengarah :
a. Nama Lengkap : (Dr ACHMAD NIZAR HIDAYANTOS.Kom, M.Kom)
b. NIDN : 0024077601
c. Jabatan Fungsional : Lektor Kepala
d. Program Studi : Teknologi Informasi
e. Nomor HP/Surel : 08129668282/nizar@cs.ui.ac.id
Lama Penelitian Keseluruhan : 2 tahun
Usulan Penelitian Tahun ke- : 1
Biaya Penelitian Keseluruhan : Rp 218,000,000.00
Biaya Penelitian
- diusulkan ke DRPM : Rp 110,000,000.00
- dana internal PT : Rp 10,000,000.00
- dana institusi lain : Rp 0 /in kind tuliskan:
Biaya Luaran Tambahan : Rp 0.00

Peneliti Pengarah

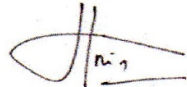

(Dr ACHMAD NIZAR HIDAYANTOS.Kom,
M.Kom)

NIP/NIK 197607242000121001

Kota Samarinda, 18-06-2017

Ketua Peneliti



(RAMADIANIS.Pd, M.Kom, Ph.D)

NIP/NIK 197211012001122001



Menyetujui
Ketua LP2M

(Prof. DR. Susilo, M.Pd)

NIP/NIK 197112052002121002



Menyetujui
Dekan FKEd

(Dr. Nataniel Dengen, M.Si.)

NIP/NIK 196812242000031001

URAIAN UMUM

1. Judul Penelitian : Pemanfaatan Konten e-Learning pada Smartphone

2. Tim Peneliti

No	Nama	Jabatan	Bidang Keahlian	Instansi Asal	Alokasi Waktu (jam/minggu)
1	RAMADIANI S.Pd, M.Kom, Ph.D	Ketua Pengusul	E-Learning/Sistem Informasi/SPK/Teknologi Informasi/Illmu Komputer/	Universitas Mulawarman	16.00
2	Dr ACHMAD NIZAR HIDAYANTO S.Kom, M.Kom	Peneliti Pengarah	Sistem Informasi, Ilmu Komputer	Universitas Indonesia	4.00

3. Objek Penelitian (jenis material yang akan diteliti dan segi penelitian):

Mahasiswa Ilmu Komputer pengguna smartphone dan e-Learning

4. Masa Pelaksanaan

Mulai tahun: 2018

Berakhir tahun: 2019

5. Usulan Biaya DRPM Ditjen Penguatan Risbang

- Tahun ke-1: Rp110,000,000

- Tahun ke-2: Rp108,000,000

6. Lokasi Penelitian (lab/studio/lapangan)

Fakultas Ilmu Komputer Universitas Indonesia dan Fakultas Ilmu Komputer dan Teknologi Informasi Universitas Mulawarman

7. Temuan yang ditargetkan dan kontribusinya dalam pengembangan iptek

Pengujian Model Penerimaan Pengguna eLearning pada Smartphone dan Pengembangan prototype serta konten eLearning sesuai hasil hipotesa model penelitian

8. Luaran

a. Jurnal ilmiah yang menjadi sasaran (tuliskan nama terbitan berkala ilmiah internasional bereputasi):

b. Tuliskan nama seminar/konferensi yang akan diikuti:

ICSITech 2017-2018;

c. Luaran lainnya

- Publikasi Ilmiah Jurnal Internasional, tahun ke-1 Target: accepted/published

- Publikasi Ilmiah Jurnal Nasional Terakreditasi, tahun ke-1 Target: draft

- Pemakalah dalam pertemuan ilmiah Nasional, tahun ke-1 Target: draft

- Pemakalah dalam pertemuan ilmiah Internasional, tahun ke-1 Target: terdaftar

- Hak Cipta, tahun ke-1 Target: draft

- Buku Ajar (ISBN), tahun ke-1 Target: draft

- Tingkat Kesiapan Teknologi (TKT), tahun ke-1 Target: Skala 5

- Publikasi Ilmiah Jurnal Nasional Tidak Terakreditasi, tahun ke-1 Target: draft

- Model, tahun ke-1 Target: produk

- Purwarupa/Prototipe, tahun ke-1 Target: draft

- Keikutsertaan dalam Seminar Internasional, tahun ke-1 Target: terdaftar

IDENTITAS DAN URAIAN UMUM

1. Judul Penelitian : Pemanfaatan Konten e-Learning pada Smartphone
2. Tim Peneliti

No	Nama	Jabatan	Bidang Keahlian	Instansi Asal	Alokasi Waktu (jam/minggu)
1.	Ramadiani, M.Kom., Ph.D	Peneliti Pengusul	E-Learning/Sistem Informasi/ Sistem Pendukung Keputusan	Universitas Mulawarman	16 jam/minggu
2.	Dr. Achmad Nizar Hidayanto, M.Kom	Peneliti Pengarah	Ilmu Komputer/ Sistem Informasi/ Teknologi Informasi /Bisnis & Manajemen	Universitas Indonesia	4 jam/minggu

3. Objek Penelitian: Sampel penelitian adalah Mahasiswa Fak. Ilmu Komputer dan Teknologi Informasi serta Mahasiswa Fak. Keguruan dan Ilmu Pendidikan Universitas Mulawarman. Penetrasi Smartphone menggunakan model User Smartphone Acceptance (Kebiasaan pengguna terdiri dari 3 variabel, Kegunaan Smartphone terdiri dari 6 variabel dan Manfaat bagi Pengguna 3 variabel) yang diasumsikan berpengaruh pada pemilihan dan penggunaan Smartphone beserta aplikasi yang dipilih. Dari hasil hipotesa akan dibangun sebuah konten e-learning yang sesuai.

4. Masa Pelaksanaan

Mulai : bulan : Januari tahun: 2018
Berakhir : bulan : Desember tahun: 2019

5. Usulan Biaya DRPM Ditjen Penguatan Risbang

- Tahun ke-1 (total) : Rp. 98,000,000.00
- Peneliti Pengusul : Rp. 80,000,000.00
- Peneliti Pengarah : Rp. 18,000,000.00
- Tahun ke-2 : Rp. 108,000,000.00
- Peneliti Pengusul : Rp. 90,000,000.00
- Peneliti Pengarah : Rp. 18,000,000.00

6. Lokasi Penelitian: Fakultas Ilmu Komputer Universitas Indonesia dan Fakultas Ilmu Komputer dan Teknologi Informasi Universitas Mulawarman

7. Temuan yang ditargetkan dan kontribusinya dalam pengembangan iptek

- Pemetaan pengguna aplikasi e-Learning pada smartphone dikalangan mahasiswa Ilmu Komputer
- Pengembangan model dan prototype e-Learning pada smartphone menggunakan SEM
- Pengembangan konten e-learning

8. Luaran

a. Wajib :

Jurnal Internasional berindeks scopus

b. Tambahan

- Seminar international berindeks Scopus
- Jurnal Nasional Terakreditasi
- Membangun Model penerimaan pengguna e-Learning pada Smartphone
- Mengembangkan Prototype e-Learning sesuai model Penelitian
- Pengembangan Bahan Ajar ber ISBN

ABSTRAK

Peningkatan Pengguna internet smartphone bisa dijadikan sebagai indikator kemajuan teknologi di suatu daerah. Namun kemajuan penggunaan internet apakah diiringi dengan kemajuan penggunaan konten pembelajaran di dalam penggunaan smartphone masih belum bisa dipastikan. Tujuan Penelitian ini; 1) Memetakan Penggunaan eLearning pada Smartphone di kalangan mahasiswa, 2) Pengujian hipotesa penelitian untuk model penerimaan pengguna eLearning pada smartphone menggunakan Statistik *Structural Equation Model* (SEM) 3) membangun Prototype eLearning sesuai hipotesa penelitian 4) pengembangan konten eLearning. Model penerimaan pengguna eLearning dengan menguji hipotesa yang terdiri dari 3 variabel tidak langsung dan 12 variabel pendukung. Kebiasaan pengguna terdiri dari 3 variabel, fungsi smartphone terdiri dari 6 variabel dan manfaat bagi pengguna terdiri dari 3 variabel. Selanjutnya hasil uji hipotesa akan dibangun sebuah prototype e-learning yang sesuai dengan uji hipotesa model yang dibangun. Responden merupakan mahasiswa di Fakultas Ilmu Komputer Universitas Indonesia dan Fakultas Ilmu Komputer dan Teknologi Informasi di Universitas Mulawarman.

BAB I. PENDAHULUAN

1.1 Latar Belakang

Di era digital sekarang ini, dengan menggunakan smartphone jaraknya terasa lebih dekat, jalur informasi terbuka lebar dan mudah menyebar sehingga tidak ada lagi privasi di suatu daerah atau negara. Semua orang dapat berbagi informasi dengan menggunakan kamera, gambar, suara, teks, atau video, dan semua berjalan sangat cepat. Kejadian di suatu daerah bisa diketahui orang dari daerah lain dalam hitungan detik. Maka tak heran jika smartphone menjadi sesuatu yang harus dimiliki oleh semua orang.













Perilaku pengguna ponsel cerdas juga berkembang menjadi budaya tersendiri termasuk bagaimana mendapatkan informasinya. Berbagi foto diri atau kelompok, berbagi foto makanan, membuka dan mengirim pesan, membuat status dan berbagi berita di media sosial. Perilaku pengguna ponsel cerdas juga mempengaruhi perilaku ekonomi seseorang, pembeli akan memeriksa dan membandingkan harga barang dari satu tempat dan tempat lainnya, memesan barang, membeli tiket dan membayar secara online, transaksi perbankan, serta sarana konsultasi dan bimbingan perjalanan dan kesehatan.

Smartphone digunakan lebih dari sekedar menelepon, mengirim SMS, atau browsing internet dasar. Pengguna beralih ke perangkat mobile ini saat mereka menavigasi berbagai macam acara kehidupan; 62% pemilik smartphone telah menggunakan telepon mereka pada tahun lalu untuk mencari informasi tentang kondisi kesehatan. 57% telah menggunakan telepon mereka untuk melakukan perbankan online. 44% telah menggunakan telepon mereka untuk mencari daftar real estat atau informasi lainnya tentang tempat tinggal. 43% untuk mencari informasi tentang pekerjaan. 40% untuk mencari layanan atau informasi pemerintah. 30% untuk mengambil kelas atau mendapatkan konten pendidikan. 18% untuk mengajukan lamaran pekerjaan (Pew, 2014).

Indonesia berada di peringkat 4 dunia dengan pengguna Facebook paling aktif. Hal ini terungkap dari laporan penelitian We Are Social and Hootsuite yang dirilis di LinkedIn. Facebook diklaim semakin mendominasi dunia media sosial di dunia. Sampai saat ini, Facebook telah mengantongi 1,968 miliar pengguna aktif. Sekitar 89 persen akses via smartphone dan 61 persen mengakses Facebook setiap hari. Indonesia berada di peringkat keempat dengan 111 juta pengguna (Mobile Market, 2017).

Pada Gambar 1.1 adalah daftar negara dengan penetrasi smartphone pada tahun 2017. Angka-angka ini berasal dari Laporan Pasar Global tahunan dan didasarkan pada model yang mempertimbangkan perkembangan ekonomi, demografi, populasi online, dan ketidaksetaraan negara. Laporan ini menampilkan perkiraan pengguna ponsel cerdas yang luas dari tahun 2015 sampai 2020 per negara dan wilayah, bersama dengan merek smartphone dan tablet teratas, dan perkiraan pendapatan aplikasi.

APRIL 2017 ▼

RANK	IMAGE	COUNTRY	TOTAL POPULATION	SMARTPHONE PENETRATION	SMARTPHONE USERS
1		China	1,388,233,000	51.7%	717,310,000
2		India	1,342,513,000	22.4%	300,124,000
3		United States	326,474,000	69.3%	226,289,000
4		Brazil	211,243,000	37.7%	79,578,000
5		Russian Federation	143,375,000	54.7%	78,364,000
6		Japan	126,045,000	50.1%	63,089,000
7		Germany	80,636,000	68.8%	55,492,000
8		Indonesia	263,510,000	20.7%	54,494,000
9		Mexico	130,223,000	40.7%	52,993,000
10		United Kingdom	65,511,000	68.6%	44,953,000
11		France	64,939,000	65.3%	42,399,000
12		Turkey	80,418,000	49.8%	40,010,000

Gambar 1. 1 Ada 50 Negara teratas dalam hal pengguna smartphone di tahun 2017.

E-Learning adalah proses belajar melalui internet bisa dilakukan dengan menggunakan berbagai platform atau aplikasi. E-Learning bisa menyesuaikan tempat, metode, dan media yang ada. Menggunakan e-Learning diharapkan bisa memudahkan transfer ilmu dan berbagi tip pengetahuan kepada pengguna. E-Learning tidak bermaksud mengganti kelas yang ada, ia berfungsi untuk memperkaya dan menjadi alternatif pada waktu dan kondisi yang tepat (Ramadiani, 2015).

Tantangan yang dihadapi pendidik saat ini adalah bagaimana memanfaatkan teknologi smartphone sebagai media pendidikan dan berbagi pengetahuan, baik formal maupun nonformal. Tujuannya adalah untuk memfasilitasi dan memperluas jangkauan pendidikan bagi mereka yang tidak mampu, tidak memiliki guru profesional, tidak dapat masuk ke sekolah favorit, sedang dilanda bencana dan tinggal di daerah terpencil.

Seiring teknologi dan aplikasi terus berkembang, semakin banyak konten video yang digunakan di lingkungan e-Learning. Pada gambar 1.3 penggunaan perangkat mobile untuk pembelajaran akan terus meningkat seiring bertambahnya jumlah orang dengan perangkat mobile, seiring dengan meningkatnya penekanan pada pengoptimalan situs web dan aplikasi untuk mengakomodasi pengguna ponsel (Bryan, 2016). Bagaimana masa depan pembelajaran e-Learning? Dan darimana kita memulai?

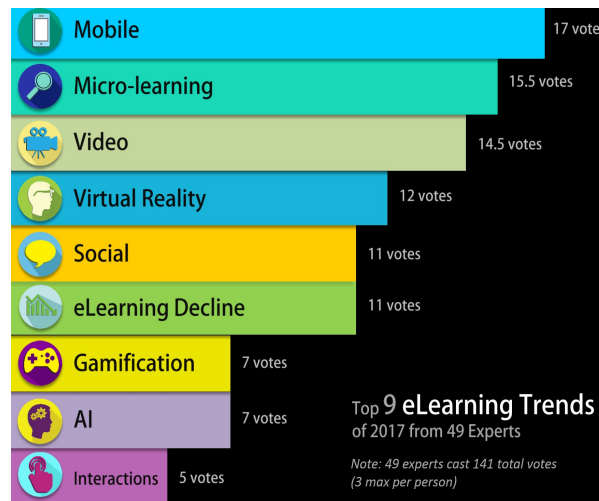

Gambar 1.2. Tren E-Learning Top di tahun 2017 seperti yang dipilih dari 49 Ahli

Asosiasi Penyedia Layanan Internet Indonesia mengungkapkan jumlah pengguna internet di Indonesia mencapai 88 juta orang pada akhir 2014. Berdasarkan jumlah penduduk, jumlah pengguna internet terbanyak ada di Provinsi Jawa Barat sebanyak 16,4 juta, disusul Jawa Timur. 12,1 juta pengguna dan Jawa Tengah 10,7 juta pengguna (APJII, 2015).

Tantangan terbesar dalam penelitian ini adalah bagaimana cara mengevaluasi penggunaan smartphones untuk mengakses e-Learning pada mahasiswa Ilmu Komputer di Universitas Indonesia dan Universitas Mulawarman. Bagaimana membangun aplikasi dan konten e-Learning pada smartphone yang sesuai kebutuhan dunia akademik masa depan.

1.2 Masalah Penelitian

Pengguna internet dan *smartphone* di seluruh dunia terus meningkat, di negara berkembang perlahan mendekati angka 100 persen. Penelitian ini bersifat eksploratif. Adapun yang menjadi fokus dalam penelitian ini adalah

1. Bagaimana memetakan pola penggunaan e-Learning pada smartphone di kalangan mahasiswa Fakultas Ilmu Komputer?

2. Konten pembelajaran apa saja yang mereka akses untuk mendukung aktivitas akademik?
3. Bagaimana membangun model penerimaan pengguna e-Learning pada smartphone?
4. Bagaimana membangun prototype e-Learning pada smartphone sesuai model penelitian?

Adapun komponen-komponen yang akan dievaluasi dalam penelitian ini difokuskan adalah sebagai berikut :

- a) *User Smartphone Profile (User demographic, Spent Time, Education Background)*
- b) *Usability Smartphone (Knowability, Operability, Efficiency, Robustness, Safety, Subjective Satisfaction)*
- c) *User Smartphone Benefit (Media element, Communicativeness, User Expectation)*

1.3 Tujuan Penelitian

Penelitian ini merupakan penelitian yang berkaitan dengan perkembangan dan evaluasi penggunaan aplikasi e-Learning pada smartphone di kalangan mahasiswa ilmu komputer di Universitas Indonesia dan Universitas Mulawarman. Secara khusus penelitian ini bertujuan:

- a) Membangun sebuah model penerimaan pengguna e-Learning pada smartphone mengguna *Structural Equation Model*.
- b) Menghasilkan Model penerimaan pengguna untuk pengembangan content e-Learning
- c) Merancang prototype e-Learning sesuai hasil uji hipotesa penelitian.

1.4 Manfaat Penelitian

- a) Menghasilkan Model penerimaan pengguna e-Learning melalui smartphone sebagai alternatif pengembangan aplikasi e-learning masa depan.
- b) Memberikan informasi tentang pola pemetaan dan pengguna e-Learning pada smartphone
- c) Memberikan prototype e-Learning pada smartphone

1.5 Luaran Penelitian

Adapun luaran yang akan dihasilkan dalam Penelitian Pasca Doktor ini akan menghasilkan jurnal internasional bereputasi sebagai luaran wajib serta konferensi

internasional dan jurnal nasional sebagai luaran tambahan, juga dihasilkan sebuah model penerimaan pengguna dan prototype aplikasi e-Learning menggunakan smartphone.

Tabel 1.1 Rencana Target Capaian Tahunan

No.	Jenis Luaran				Indikator Capaian		
	Kategori	Sub Kategori	Wajib	Tambahan	TS	TS+ 1	TS+ 2
1.	Artikel ilmiah dimuat di jurnal ²⁾	Internasional bereputasi	Accepted			√	√
		Nasional Terakreditasi		Draf			√
2.	Artikel ilmiah dimuat di prosiding ³⁾	Internasional Terindeks		Terdaftar	√	√	
		Nasional		Draft			√
3.	Invited speaker dalam temu ilmiah ⁴⁾	Internasional		Tidak ada			
		Nasional		Tidak ada			
4.	Visiting Lecturer ⁵⁾	Internasional		Tidak ada			
5.	Hak Kekayaan Intelektual (HKI) ⁶⁾	Patent		Tidak ada			
		Patent sederhana		Tidak ada			
		Hak cipta		Tidak ada			
		Merk dagang		Tidak ada			
		Rahasia dagang		Tidak ada			
		Desain produk industri		Tidak ada			
		Indikasi geografis		Tidak ada			
		Perlindungan varietas tanaman		Tidak ada			
7.	Teknologi Tepat Guna ⁷⁾			Penerapan		√	√
				Penerapan		√	√
8.	Model/Purwarupa/Desain/Karya seni/Rekayasa Sosial ⁸⁾			Penerapan		√	√
9.	Bahan Ajar ⁹⁾			Ada		√	√
10.	Tingkat Kesiapan Teknologi (TKT) ¹⁰⁾		5			√	√

BAB II. TINJAUAN PUSTAKA

2.1 Pengertian E-Learning

E-Learning adalah metode pembelajaran di lingkungan virtual berdasarkan kondisi konten pendidikan menggunakan internet dan multimedia. Banyak alat aplikasi dalam konten pendidikan yang akses pelajar bergantung pada kebutuhan dan gaya belajarnya terhadap kebiasaan berjalan. Itu tergantung pada individualisasi pelatihan dan pembelajar mandiri untuk membangun pengetahuan mereka. Lingkungan e-learning adalah penggunaan teknologi informasi modern yang ideal, integrasi yang efektif, dan kurikulum yang harus disadari. Gaya belajar yang baru dapat mereproduksi peran utama siswa untuk benar mereformasi pengajaran dan pengajaran tradisional, untuk melatih sejumlah besar personil berkualitas tinggi (Xirong et.al, 2008).

Ada dua jenis konseptualisasi dan pengukuran sistem manajemen pembelajaran (learning management system/LMS) dalam organisasi pendidikan, seperti: sistem pembelajaran berbasis web untuk e-learning dan sebagai alat pendukung untuk lingkungan pembelajaran campuran. Ozka (2009) mengajukan model penilaian e-learning konseptual, menyarankan pendekatan multi dimensi untuk evaluasi LMS melalui enam dimensi: (1) kualitas sistem, (2) kualitas layanan, (3) kualitas konten, (4) perspektif pelajar, (5) sikap instruktur, dan (6) isu pendukung.

2.2 Model Penerimaan Pengguna

Penerimaan pengguna sangat penting bagi semua pengembang aplikasi untuk mengetahui produk mereka yang telah diluncurkan di depan umum diterima atau ditolak. Pengembang membutuhkan beberapa model evaluasi untuk menyelidiki dan memahami faktor-faktor yang mempengaruhi penerimaan teknologi komputer dan informasi pada masyarakat, begitu juga bagi designer dan programmer. Selain mengikuti standar aplikasi, perancang aplikasi membutuhkan pengetahuan untuk mengenali pengguna dan kebiasaan mereka mencari informasi. Ini adalah salah satu alasan penting untuk mengembangkan model penerimaan dan evaluasi pengguna (Ramadiani, 2013).

2.3 Perkembangan Pengguna Smartphone

Smartphone adalah telepon yang menyediakan fitur yang berada diatas dan di luar kemampuan sederhana untuk membuat panggilan telepon. Ponsel pertama yang harus dipertimbangkan smartphone dirancang oleh IBM pada tahun 1992. Sepanjang akhir tahun 1990-an, berbagai jenis perangkat ponsel canggih muncul di pasaran. Layar sentuh mulai menggantikan keysets pada banyak ponsel pintar. Saat ini, fungsi smartphone dengan kaya fitur perangkat komunikasi. Pengguna dapat berselancar di Internet dengan kemudahan yang sama seperti ketika menggunakan laptop atau desktop.

Banyak produsen smartphone telah bekerja untuk meningkatkan kejelasan dan integritas sinyal audio dasar ponsel, mempertajam foto hasil kamera, kapasitas memori, ram, kecepatan mengakses internet, 4G, *free install* aplikasi internet. Hal ini membantu untuk memastikan penambahan fitur tambahan. Berikut data pengguna smartphone menurut penelitian yang dilakukan oleh Aaron Smith (2015):

- a. Dari 5 miliar pengguna ponsel di dunia, 1,08 miliar adalah pengguna Smartphones
- b. Android platform smartphone memiliki pangsa pasar 46,9%
- c. 89% dari pengguna smartphone menggunakan ponsel pintar mereka sepanjang hari
- d. 92% dari pengguna smartphone menggunakan smartphone mereka untuk mengirim pesan teks ke ponsel lainnya. Sedangkan, 84% pengguna menggunakan smartphone mereka untuk browsing internet
- e. Kelompok usia 25-34 memiliki tingkat penetrasi tertinggi smartphone, sekitar 62%
- f. Pemilik Android Smartphone mengkonsumsi jumlah tertinggi dari data pada 582 Mbs bulan, sementara pemilik iPhone pada mengkonsumsi 492 Mbs data sebulan.
- g. Mendownload aplikasi adalah data yang paling populer penggunaan untuk pengguna smartphone

Sedangkan jumlah pengguna smartphone di Indonesia terus bertambah mencapai 33% dari 2013-2017. Pertumbuhan pesat ini didorong oleh pengguna usia muda di bawah 30 tahun, tepatnya usia 18-24 tahun, dengan porsi 61 persen dari seluruh pengguna. Adapun jumlah pengguna *smartphone* di Indonesia tahun 2015, menurut data dari eMarketer (2017), diperkirakan mencapai 52 juta. Angka ini akan terus bertambah menjadi 69 juta pada 2016 dan 87 juta pada 2017. Laporan ini dirancang berdasarkan pada pengumpulan data penggunaan otomatis dari lebih dari 1.600 pengguna *smartphone* di Indonesia.

2.4 Model Persamaan Struktural

SEM adalah singkatan dari model persamaan struktural (structural equation model) yang merupakan generasi kedua teknik analisis multivariate yang memungkinkan peneliti untuk menguji hubungan antara variabel yang kompleks baik recursive maupun nonrecursive untuk memperoleh gambaran menyeluruh mengenai suatu model. Tidak seperti analisis multivariate biasa (regresi berganda dan analisis faktor). SEM dapat melakukan pengujian secara bersama-sama (Bollen, 1989), yaitu: model struktural yang mengukur hubungan antara independent dan dependent construct, serta model measurement yang mengukur hubungan (nilai loading) antara variabel indikator dengan konstruk.

Namun, dalam pekerjaan terapan, model persamaan struktural paling sering digambarkan secara grafis. Berikut adalah contoh grafis dari model persamaan struktural:

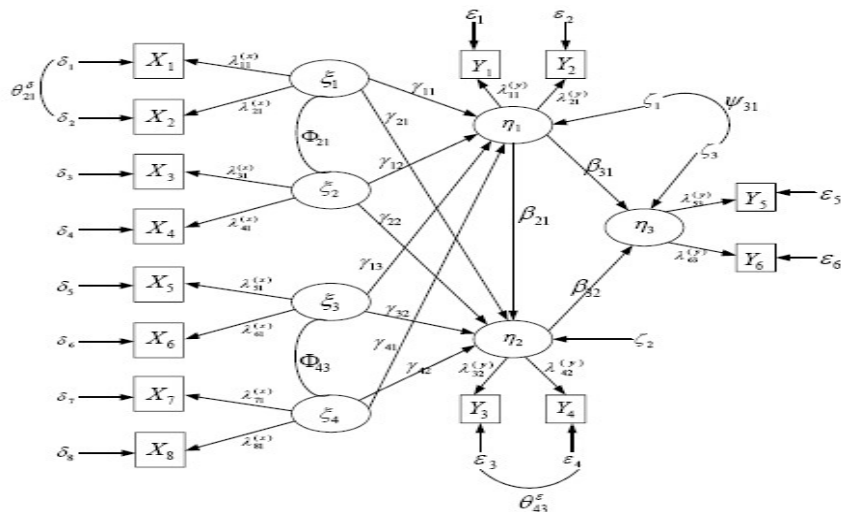

Gambar 2.1 Grafik dari Structural Equation Model

Adapun langkah dalam prosedur model persamaan struktural dalam Lisrel secara umum menurut Bollen (1993) adalah bersifat: Spesifikasi model, Identifikasi, Estimasi, Uji kecocokan, Respesifikasi

Table 2.1 General Model of SEM

No.	Structural Model	Measurement Model	Assumption
1.	$\eta = \beta\eta + \Gamma\xi + \zeta$	Measurement Model y $y = \Lambda_y \eta + \varepsilon$	ζ no correlation with ξ
2.		Measurement Model x $x = \Lambda_x \xi + \delta$	ε no correlation with η
3.			δ no correlation with ξ
4.			$\zeta, \varepsilon, \delta$ no correlation with
5.			I-B non-singular

BAB III. METODE PENELITIAN

3.1. Penggunaan e-Learning pada Smartphone

Banyak faktor yang mempengaruhi seseorang untuk memilih dan menggunakan aplikasi yang ditanam pada smartphone termasuk e-Learning. Pengaruh karakteristik dan psikologi pengguna, latar belakang Pendidikan, lingkungan, harapan, promosi dan rekomendasi, sampai pada kemampuan dan keyakinan pengguna terhadap kehandalan smartphone. Variable tersebut akan menjadi hipotesa dalam penelitian ini untuk membangun model penerimaan pengguna e-learning pada smartphone. Variable lain yang juga penting untuk diamati adalah waktu browsing, alamat browsing, alokasi waktu, kebiasaan pengguna dan biaya yang mereka keluarkan per bulan menggunakan pertanyaan terbuka (Ramadiani, 2013). Sedangkan untuk variable kegunaan e-Learning pada smartphone dan manfaat yang didapat oleh user menggunakan pertanyaan dengan skala likert (1, 2, 3, 4, 5, 6, 7).

Sangat tidak setuju (1)	Agak tidak setuju (2)	Kurang setuju (3)	Cukup (4)	Setuju (5)	Agak setuju (6)	Sangat setuju (7)
----------------------------	--------------------------	----------------------	--------------	---------------	--------------------	----------------------

4.2 Sampel dan Lokasi Penelitian

Studi literature review dan pra riset akan dilakukan pada universitas pengarah yaitu Universitas Indonesia untuk membangun dan menguji hipotesa penelitian. Sehingga didapatkan model penerimaan pengguna smartphone dan pemetaan aplikasi yang sering dipakai. Setelah itu penelitian akan dilanjutkan di Universitas Indonesia dan Universitas Mulawarman dengan sampel penelitian adalah mahasiswa Fakultas Ilmu Komputer dan Teknologi Informasi. Menurut Joreskog (1996) untuk sampel dalam penelitian ini diperlukan sampel yang sesuai dengan jumlah variable yang diujikan. Rumuskan adalah sebagai berikut: $k(k+1) / 2$, dimana k adalah jumlah variable.

Table 3.1 Variabel yang Mempengaruhi Penerimaan Pengguna

<i>Variable</i>	<i>Tujuan</i>	<i>Indikator Penilaian</i>
$X1...Xn$	Profil pengguna	Usia, jenis kelamin, Pendidikan, keuangan, motivasi
$Y1$	Lama penggunaan Internet/hari	0 – 5 hours 5 – 10 hours ≥ 20 hours 10 – 15 hours 15 – 20 hours
$Y2$	Kebiasaan pengguna	Aplikasi yang digunakan (alokasi waktu)
$Y3$	Pengetahuan	Mudah dipelajari; Mudah dimengerti; Mudah diingat
$Y4$	System operasi	Mudah digunakan; Efektif ; Flexible
$Y5$	Efisiensi	Multi tasking; Efisien waktu; Produktif
$Y6$	Kehandalan	Terdapat panduan; Terpercaya; Terdapat Peringatan

<i>Variable</i>	<i>Tujuan</i>	<i>Indikator Penilaian</i>
Y7	Keamanan	Aman; Selamat; Tenang
Y9	Tingkat kepuasan	Menarik; Lengkap; Memuaskan
Y8	Multimedia	Sangat Mendukung; Lengkap; Terbaru
Y9	Komunikasi	Sederhana; Lengkap; Terbaru
Y10	Harapan pengguna	Sesuai kebutuhan; Sesuai kemampuan; Sesuai keinginan

3.3 Road Map Penelitian

Untuk memberikan gambaran yang detail tentang proses dan tahapan apa saja yang akan dilakukan dalam penelitian pasca doktor ini, maka kami buat diagram *fish bone* untuk mempertajam masalah yang akan diteliti pada Gambar. 2.2

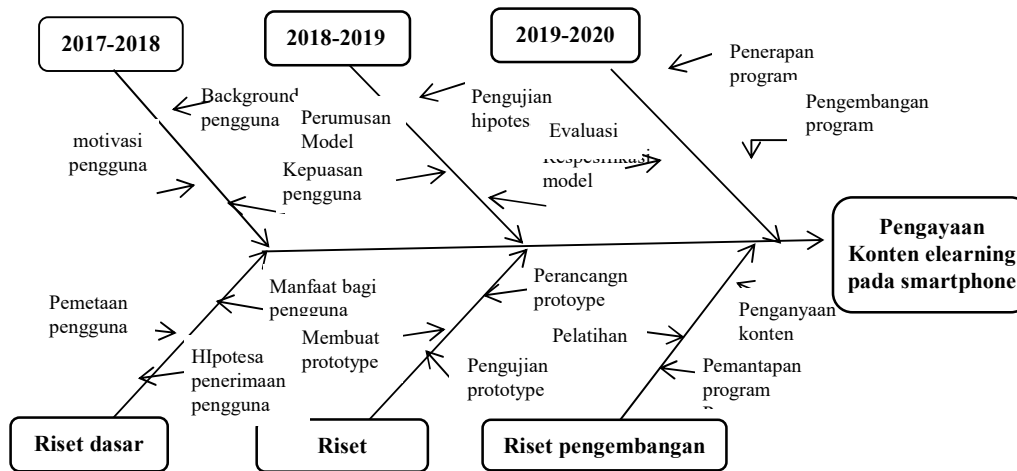

Gambar 3.2 Fish bone Diagram untuk Kegiatan Penelitian Secara Detail

3.4 Tonggak Pencapaian Penelitian (milestone)

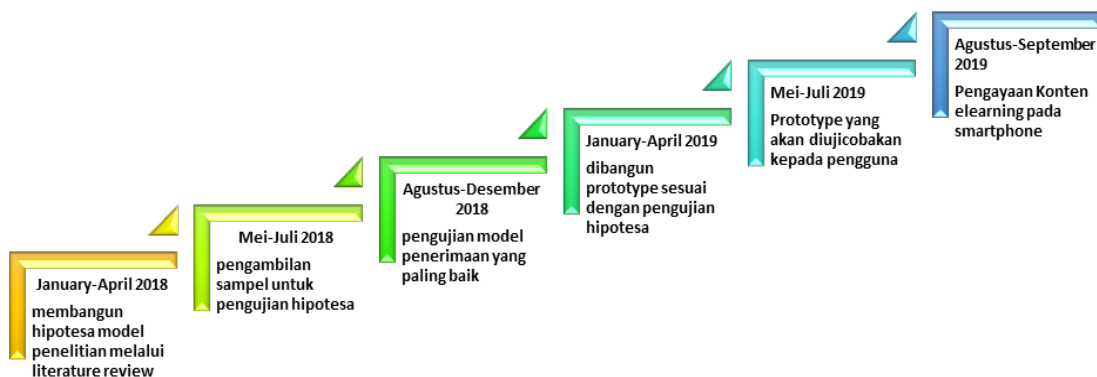

Gambar 3.3 Tahapan Penelitian Pasca Doktor 2018-2019

BAB IV. PELAKSANAAN PENELITIAN

4.1. Universitas Indonesia

Ada beberapa alasan mengapa Peneliti Pengusul memilih Universitas Indonesia sebagai tempat melakukan riset PPD, karena:

1. UI memiliki fasilitas Laboratorium Komputer yang mendukung Riset Program Pasca Doktor yang Peneliti Pengusul lakukan.

Fasilkom UI memiliki sarana laboratorium komputer, baik untuk pengajaran maupun penelitian. Laboratorium tersebut dipergunakan oleh dosen dan mahasiswa untuk kegiatan praktikum, penelitian maupun kegiatan mandiri siswa. Fasilkom UI memiliki 7 laboratorium penelitian. Ada 2 laboratorium yang relevan dengan kegiatan penelitian ini yaitu Lab Digital Library & Distance Learning, serta Lab Manajemen Informasi terkait dengan topik adopsi teknologi informasi.

2. UI menyediakan sarana server yang digunakan untuk penelitian.

Setiap komputer di laboratorium pengajaran dan penelitian, ruang dosen maupun ruang kelas seluruhnya terhubung ke server tersebut. Setiap pemakai akan diberikan akses sesuai dengan hak yang dimilikinya. Server paling penting yang dipergunakan untuk pembelajaran sehari-hari adalah server SCeLE sebagai sarana untuk pembelajaran di dunia maya. Layanan SCeLE tersebut merupakan layanan yang akan mendukung penelitian Program Pasca Doktor ini, terutama sebagai obyek penelitian.

3. UI memiliki akses Jurnal Riset Komputer terlengkap di Indonesia

Untuk memberikan kemudahan dalam mengakses publikasi yang berkualitas, UI telah menyediakan sarana akses ke jurnal online kepada seluruh civitas akademika. Beberapa jurnal dan database yang dilanggan online oleh UI diantaranya:

- Wiley Online (Medicine, Nursing, Dentistry & Health Care)
- SAGE Research Methods
- Taylor & Francis
- Westlaw
- Springer Protocols
- Oxford Journals (new platform Fall 2016)
- Emerald Insight
- American Chemical Society
- ebrary
- American Institute of Physics
- SpringerLink

- Alexander Street Press
- American Library Association (ALA) - Ebooks
- American Physical Society (APS)
- American Society of Civil Engineering (ASCE)
- American Society of Mechanical Engineers (ASME)
- Annual reviews
- EBSCOhost
- ClinicalKey
- JSTOR
- LexisNexis
- ProQuest
- Royal Society of Chemistry
- ScienceDirect
- Scopus
- IEEE Communication Society
- IEEE Xplore
- IEEE Communication Society
- IEEE Computer Society
- RefWorks
- Kluwer Arbitration
- Micromedex
- Annual Reviews
- American Chemical Society
- Royal Society of Chemistry
- ACM Digital Library
- Sage Publications
- SciVal

4. UI memiliki akses penulisan jurnal terakreditasi

UI memiliki beberapa jurnal yang terakreditasi oleh DIKTI, diantaranya:

- Makara Journal of Science
- Makara Journal of Health Research
- Makara Journal of Technology
- Jurnal Ilmu Komputer dan Informasi

Selain itu, staf UI (termasuk Fasilkom UI) juga menjadi editor di beberapa jurnal internasional, sehingga memudahkan dalam proses publikasi di jurnal internasional yang bereputasi.

5. UI memiliki akses aplikasi e-Learning

Setiap dosen dan mahasiswa didorong untuk menggunakan metode terbaru dan aktif menggunakan teknologi e-Learning dalam proses pembelajarannya melalui Student Center E-learning Environment (SCeLE- <http://scele.cs.ui.ac.id>). Komunikasi interaktif antara dosen dengan mahasiswa tidak hanya dilakukan dalam kelas, namun juga dilakukan online melalui

SCeLE. Hal ini dinilai cukup berhasil dengan terlihat bahwa banyaknya posting diskusi yang dibuat oleh mahasiswa di forum SCeLE tersebut. Aplikasi tersebut bisa menjadi salah satu obyek yang mendukung penelitian yang diajukan. Sebagai system yang sudah cukup lama dibangun, SCeLE merupakan obyek yang cukup menarik karena telah melewati berbagai fase pengembangan.

4.2. Profil Peneliti Pengusul

Sebelum masuk ke profil calon peneliti pengarah, kami memperkenalkan diri sebagai bagaimana peneliti pengusul akan melakukan penelitian di institusi peneliti pengarah.

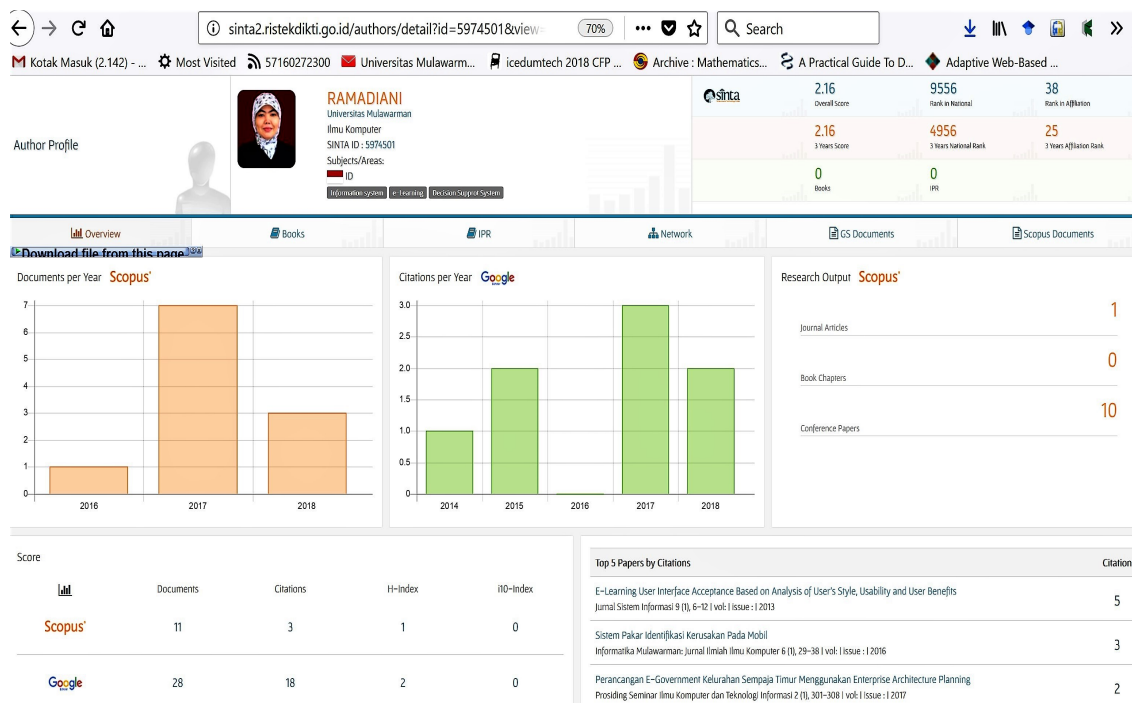

Gambar 4.1 Profil Peneliti Pengusul di Sinta, Science and Technology Index

Peneliti pengusul merupakan lulusan Doctor of Philosophy dari Faculty Computer Science and Information Science di Universiti Putra Malaysia pada tahun 2015. Peneliti pengusul menyelesaikan Pendidikan Doctor selama 3 tahun 6 bulan dan mendapat penghargaan sebagai Doctor lulusan tepat waktu. Riset Doctor yang dilakukan berjudul “*Integrated User Interface Acceptance Model for E-Learning System*” dibawah bimbingan 4 promotor dari UPM, Malaysia dan diuji oleh 4 penguji gabungan dari UPM dan Monash University, Australia. Adapun penelitian yang pernah dilakukan rata-rata terfokus pada pengembangan pembelajaran e-Learning dan Decision Support System.

Peneliti pengusul merupakan orang baru dalam ranah publikasi ilmiah, sehingga peneliti bermaksud untuk belajar lebih banyak pada perguruan tinggi lain yang sudah senior dan lama berprestasi di dunia penelitian dan publikasi Ilmiah. Universitas Indonesia dipilih karena memiliki fasilitas riset lengkap yang sesuai dengan penelitian yang akan peneliti pengusul lakukan, yaitu fasilitas akses jurnal ilmiah dan penerapan aplikasi e-Learning yang sudah berjalan lama dan sukses. Sebagai pendatang baru, publikasi yang dimiliki oleh peneliti pengusul masih sangat terbatas, yaitu; 2 artikel jurnal scopus, 3 international conference scopus, dan 9 jurnal google scholar dengan h-indeks 1. Berikut profil peneliti pengusul yang ada di Sinta, Science and Technology Index.

4.3. Profil Calon Peneliti Pengarah

Calon peneliti pengarah adalah Doktor lulusan UI yang sangat berkompeten dibidang riset dan publikasi ilmiah. Beliau telah meluluskan +/- 400 mahasiswa Sarjana dan Magister Komputer. Memiliki h-indeks 5 di Scopus dan Shinta Score mencapai 24, serta h-indeks 8 di Google Scholar. Rata-rata penelitian beliau merupakan riset penelitian terapan aplikasi teknologi informasi, seperti penelitian yang diusulkan pada PPD tahun ini. Beliau memiliki 107 publikasi di Google Scholar yang sudah disitasi sebanyak 254 juga memiliki 67 artikel publikasi di Scopus dan telah disitir sebanyak 70 kali. Bidang Keahlian beliau adalah Ilmu Komputer/ Sistem Informasi/ Teknologi Informasi /Bisnis & Manajemen. Berikut profil calon peneliti pengarah yang bias diakses melalui Sinta, Science and Technology Index.

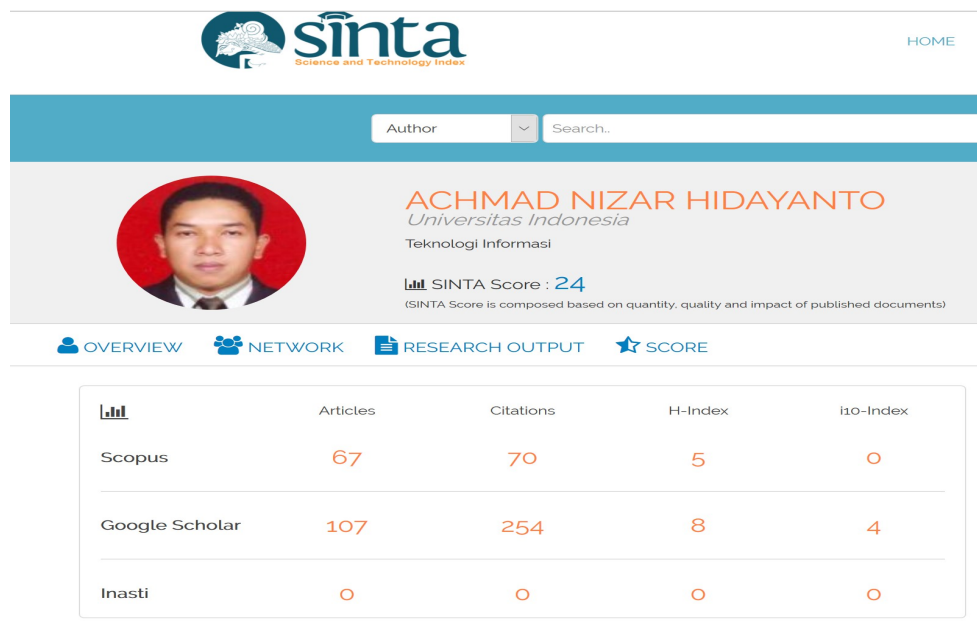

Gambar 4.2. Profil Peneliti Pengarah di Sinta, Science and Technology Index

BAB V. BIAYA DAN JADWAL PENELITIAN

5.1 Anggaran Biaya

Anggaran penelitian mengacu pada PMK tentang SBK Sub Keluaran Penelitian yang berlaku. Besarnya anggaran yang diusulkan tergantung pada kategori penelitian dan bidang focus penelitian yang diusulkan. Sebagaimana dijelaskan pada sub bab 2.9, rincian biaya dalam proposal harus memuat SBK penelitian, biaya ini sudah termasuk biaya pencapaian luaran wajib dan biaya luaran tambahan yang akan dicapai.

Tabel 5.1 Rencana Anggaran Biaya Penelitian PascaDoktor 2018

Rencana Anggaran PPD 1 Tahun (2018)		Rincian Perhitungan	vol.	Harga Satuan	Jumlah Biaya
I. Honorarium Pelaksana dan Biaya Hidup Peneliti.					38,000,000
1	Honor pelaksana	20 mng x 20 jam	400 jam	50,000	20,000,000
2	Rapat	1 pkt x 1 thn	12 bln	300,000	3,600,000
3	Akomodasi di UI	1 org x 1 thn	4 bln	3,600,000	14,400,000
II. Perjalanan Dinas					21,000,000
1	Transportasi PP Bpn-Jkt	3 org x 1 thn	3 ok	3,000,000	9,000,000
2	Uang Harian/uang saku	3 org x 3 hari	9 hari	430,000	3,870,000
3	Penginapan/akomodasi	3 org x 3 hari	9 hari	670,000	6,030,000
4	Transportasi PP Smd-Bpn	3 org x 1 thn	3 ok	700,000	2,100,000
III. Biaya Peralatan					21,600,000
1	Bahan habis pakai	1 pkt x 1 thn	12 bln	500,000	8,400,000
2	Peralatan penelitian	1 pkt x 1 thn	12 bln	500,000	6,000,000
3	ATK	1 pkt x 1 thn	12 bln	600,000	7,200,000
IV. Biaya Publikasi					17,400,000
1	Pembuatan buku dan Laporan	2 keg x 4 dok	8 dok	800,000	6,400,000
2	Jurnal International	2 org x 1 thn	1 ok	5,000,000	5,000,000
3	International conference	2 org x 1 thn	1 ok	4,000,000	4,000,000
4	Seminar Nasional	2 org x 1 thn	1 ok	2,000,000	2,000,000
Total Rencana Pembiayaan berasal dari DRPM 2018					98,000,000

5.2 Sumber Dana Penelitian

Sumber dana Penelitian Pascadoktor dapat berasal dari:

- a. Dana dari DRPM Ditjen Penguatan Risbang sebesar Rp. 108,000,000,00 untuk tahun 2019, yang akan dibagi menjadi beberapa item pengeluaran sebagai berikut;

Tabel 5.2 Rencana Anggaran Biaya Penelitian PascaDoktor 2018 dan 2019

No.	Jenis Pengeluaran	Tahun Pertama (2018)	Tahun ke dua (2019)
1	Honorarium pelaksana dan biaya hidup peneliti	Rp. 38,000,000,00	Rp. 36,000,000,00
2	Bahan barang habis pakai dan peralatan	Rp. 21,000,000,00	Rp. 25,200,000,00
3	Perjalanan dan akomodasi	Rp. 21,600,000,00	Rp. 22,062,000,00
4	Biaya Laporan dan Publikasi	Rp. 17,400,000,00	Rp. 24,738,000,00
Total dana dari DRPM		Rp. 98,000,000,00	Rp. 108,000,000,00

5.3 Jadwal Penelitian

Rencana Jadwal penelitian untuk Penelitian PascaDoktor pada Tahun Pertama dan Tahun Kedua yang dilakukan sesuai tahapan perencanaan penelitian.

Tabel 5.3 Jadwal Penelitian Program Pasca Doktor di Universitas Indonesia

No	Jenis Kegiatan	Tahun 2018												Tahun 2019											
		1	2	3	4	5	6	7	8	9	10	11	12	1	2	3	4	5	6	7	8	9	10	11	12
1	studi literatur	■	■	■	■																				
2	membangun hipotesis		■	■	■	■																			
3	pembuatan questioner			■	■	■	■																		
4	membangun model				■	■	■	■																	
3	Pembagian quesioner					■	■	■	■																
5	mengklarisifikasi data						■	■	■	■															
6	menguji hipotesa							■	■	■	■														
7	membuat laporan								■	■	■														
8	mempublikasi Jurnal ke 1									■	■	■	■	■	■										
9	menganalisa kebutuhan										■	■	■	■	■	■									
10	memilih model terbaik											■	■	■	■	■									
11	mendesain prototype														■	■	■	■							
12	membangun prototype															■	■	■	■	■					
13	menginstalasi protodata																■	■	■	■	■				
14	menguji prototype																	■	■	■	■	■			
15	membuat bk panduan																		■	■	■	■	■		
16	membuat laporan																				■	■	■	■	
17	mempublikasi Jurnal ke 2																					■	■	■	

REFERENSI

- Aaron Smith, 2015. U.S. Smartphone Use in 2015. Pew Research Center.
- Bollen, Kenneth.A. 1996. An Alternative two stage least squares (2sls) estimator for latent variabel equations. *Psychometrica* 61: 109-121.
- Bryan Jones, 2016. Top 9 E-Learning Trend in 2017 as Picked from 49 Expert. eLearningArt,
- Fernandez, Abrahão and Insfran (2009) Towards a Usability Evaluation Process for Model-Driven Web Development, USED '09, August 24, 2009, Upssala, Sweeden.
- Global Mobile Market Report, Markets. 2017. Top countries by smartphone users and penetration Trends & Projections.
- Inaya Rakhmani and Samuel A. Pangerapan. 2015. Profil Pengguna Internet di Indonesia 2014. APJII and PusKaKom UI.
- Joreskog, Karl.G.dan D.Sorbom.1996. LISREL 8: User's Reference Guide. Chicago: Scientific Software International, Inc.
- Lina Wu, Mincheol Kang and Sung-Byung Yang, 2015. What Makes Users Buy Paid Smartphone Applications? Examining App, Personal, and Social Influences. *Journal Internet and Banking (JIBC)* August 2015, Vol. 20, No.1
- Ma X, Wang R. and Liang J, 2008. The e-Learning System Model Based on Affective Computing, Seventh International Conference on Web-based Learning
- Ramadiani, R. Atan, A. Rusli, *M.H. Selamat*, and Noeraini. 2015. "Integrated Model Acceptance for E-Learning", International Conference on Engineering and Technology for Sustainable Development (ICET4SD) 11–12 Nov, Yogyakarta, Indonesia [IOP Conference Series: Materials Science and Engineering, Volume 105, Number 1](#)
- Ramadiani, R. Atan, M.H. Selamat, C. P. Noraini, A. Rusli, "E-Learning User Acceptance based on Analysis of User's Style, Usability, adn User Benefits", [Vol 9, No 1](#): page 6-12, 2013.*
- Simon Kemp, 2016. Future Social How Social Media Marketing. We are social connet via hootsuite, 7 Sept are released on LinkedIn..

Lampiran 2. Proposal Pengabdian Pada Masyarakat

Di era digital sekarang ini, dengan menggunakan smartphone jaraknya terasa lebih dekat, jalur informasi terbuka lebar dan mudah menyebar sehingga tidak ada lagi privasi di suatu daerah atau negara. Semua orang dapat berbagi informasi dengan menggunakan kamera, gambar, suara, teks, atau video, dan semua berjalan sangat cepat. Kejadian di suatu daerah bisa diketahui orang dari daerah lain dalam hitungan detik. Maka tak heran jika smartphone menjadi sesuatu yang harus dimiliki oleh semua orang [1].

Jika harga ponsel cerdas dan tablet terus menurun, kemungkinan sekolah akan lebih tertarik menggunakan teknologi seluler ini untuk menciptakan lingkungan pembelajaran bagi siswa. Semakin banyak siswa yang memiliki perangkat seluler canggih dapat menyebabkan lebih banyak sekolah ke *e-learning* dan *mobile learning*, dimana siswa membawa ponsel, tablet, atau laptop mereka sendiri ke sekolah [2]. Kebijakan nasional mengharuskan sekolah untuk menyediakan akses internet nirkabel di semua ruang kelas pada tahun 2014 agar siswa dapat menggunakan perangkat tersebut untuk kegiatan belajar sepanjang hari. Bukti menunjukkan bahwa dengan jaringan Wi-Fi terbuka di beberapa sekolah sebagai strategi praktis untuk menciptakan lingkungan pembelajaran [3].

Namun hambatan untuk pembelajaran *mobile learning* adalah sikap sosial negatif yang dipegang oleh pembuat kebijakan, orang tua dan guru tentang penggunaan ponsel di sekolah. Ponsel secara luas dianggap mengganggu pendidikan dan penggunaannya di sekolah dibatasi di banyak negara. Orang tua dan guru melihat siswa bermain game dan mengirim pesan di ponsel dan sering beranggapan bahwa perangkat tersebut tidak lebih dari sekadar mainan yang mengganggu nilai Pendidikan [4].

Banyak orang tua dan pendidik khawatir bahwa ponsel memungkinkan perilaku yang tidak pantas seperti kecurangan dan *cyber-bullying*. Eurydice mengumpulkan data tentang pendidikan dan pelatihan, menuliskan laporan pada tahun 2009 tentang penggunaan ponsel yang aman. Laporan tersebut menyatakan bahwa *cyber-bullying* di sekolah telah menjadi topik yang semakin mengkhawatirkan dalam beberapa tahun terakhir [5].

Karena sikap sosial ini, pembuat kebijakan mungkin enggan untuk memberlakukan kebijakan yang mempromosikan *mobile learning*, dan sebagian pemerintah mungkin benar-benar menentang upaya *mobile learning* [3].

Sehingga perlu dilakukan penyuluhan dan pendidikan mengenai konten-konten positif smartphone dalam hal ini pembelajaran dan sosialisasi konten e-learning dan m-learning yang positif. Karena e-learning dan m-learning akan memudahkan mereka mengakses materi pembelajaran, mentranslate bahasa, mengerjakan soal-soal latihan dan ujian, mengerti cara penghitungan cepat matematika dan rumus-rumus pelajaran lainnya, kapanpun dan dimanapun mereka membutuhkan.

Mengingat hambatan dan tantangan untuk kebijakan *e-learning* dan *mobile learning* yang dijelaskan pada bagian di atas, Masa depan *e-learning* dan *mobile learning* sangat tergantung pada tingkat penerimaan sosial yang diterimanya. Dalam skenario terburuk, pembuat kebijakan dan sekolah tidak mau beradaptasi dengan pola pembelajaran baru dan interaksi sosial di luar kelas, sementara anak muda melihat apa yang mereka pelajari di sekolah semakin tidak relevan dengan keterampilan dan minat mereka. Sekolah melarang peralatan seluler untuk pembelajaran pribadi dan jejaring sosial, pada saat yang sama mereka berjuang untuk menyediakan komputer untuk memberikan bentuk pengajaran alternative (Sharples, 2009).

Diharapkan pembuat kebijakan dan sekolah dapat merangkul peluang baru yang dikembangkan oleh pengembangan teknologi. Dalam hal ini, teknologi seluler dapat digunakan untuk membangun kontinuitas dalam pengalaman belajar lintas konteks pedagogis yang berbeda, membantu siswa menyelaraskan pembelajaran yang mereka lakukan di luar sekolah dengan pembelajaran yang mereka lakukan di dalam sekolah.

Solusi yang ditawarkan dalam Pengabdian pada masyarakat ini adalah;

- Melakukan penyuluhan dan sosialisasi konten-konten positif dalam smartphone yang bisa mendukung keberhasilan pembelajaran di sekolah-skolah.
- *E-Learning* dan *Mobile Learning* harus mengikuti rekomendasi yang sama yang dikeluarkan untuk integrasi TIK ke dalam pendidikan, yaitu:
- Mengizinkan penggunaan teknologi di sekolah - dalam hal ini, telepon seluler dan perangkat genggam lainnya
- Mengembangkan pedoman pedagogis untuk guru
- Mengembangkan standar teknis untuk bahan pembelajaran sehingga dapat digunakan pada beberapa platform, seperti komputer, papan tulis interaktif, dan perangkat seluler

- Mendukung pengembangan materi pembelajaran digital dan membuat platform dan saluran yang efisien untuk distribusinya
- Evaluasi program dan sebarakan informasi tentang praktik terbaik

Untuk menanggapi permasalahan tentang mindset orang tua dan guru yang menganggap smartphone hanya berisi konten negatif, tempat membullying, sebagai hiburan, bermain game, dan menurunkan nilai sekolah maka langkah-langkah yang akan diambil dalam pengabdian dan penyuluhan pada masyarakat ini adalah:

- 1) mengenalkan konten-konten postif berupa aplikasi e-learning dan m-learning pada smartphone yang berisi materi-materi pendukung pembelajaran, latihan dan ujian soal di sekolah
- 2) mengenalkan fitur-fitur dan melatih cara penggunaanya (aplikasi-aplikasi) yang efektif sesuai kebutuhan pengguna dan kebijakan sekolah.
- 3) melatih cara login, menggunakan aplikasi, mengerjakan soal, melihat score nilai, mereview pelajaran, melihat kemajuan atau peningkatan capaian nilai dalam pembelajaran, cara berinteraksi dengan tutor, keamanan pengguna serta hal-hal penting lainnya.
- 4) mengenalkan aplikasi pembatasan dan aplikasi keamanan yang bisa diterapkan untuk memudahkan memonitoring dan mengawasi kegiatan para siswa oleh guru dan orang tua mereka.
- 5) Pengabdian dan Penyuluhan masyarakat ini akan dilakukan di sekolah-sekolah mitra di kota Samarinda SMTN 1 Samarinda, SMAN 2 Samarinda, dan SMAN 3 Samarinda.

Jumlah pengguna internet di Indonesia mencapai 88 juta orang pada akhir 2014. Berdasarkan jumlah penduduk, jumlah pengguna internet terbanyak ada di Provinsi Jawa Barat sebanyak 16,4 juta, disusul Jawa Timur. 12,1 juta pengguna dan Jawa Tengah 10,7 juta pengguna (APJII, 2015).

E-Learning adalah metode pembelajaran di lingkungan virtual berdasarkan kondisi konten pendidikan menggunakan internet dan multimedia. Ozka (2009) mengajukan model penilaian e-learning konseptual, menyarankan pendekatan multi dimensi untuk evaluasi LMS melalui enam dimensi: (1) kualitas sistem, (2) kualitas layanan, (3) kualitas konten, (4) perspektif pelajar, (5) sikap instruktur, dan (6) isu pendukung.

E-learning adalah sistem yang menyediakan berbagai layanan untuk menangani semua aspek dari proses pembelajaran, melalui antarmuka web yang intuitif dan konsisten (Ramadiani, et al., 2016). Sistem e-learning mulai mengubah

orientasi pembelajaran, yang sebelumnya bergantung pada guru, kemudian menjadi proses belajar mandiri oleh siswa, sehingga memungkinkan siswa untuk memainkan peran aktif dan bertanggung jawab untuk dirinya sendiri (Ramadiani, et al., 2013). E-learning diharapkan dapat memfasilitasi kelemahan yang ditemukan dalam pendidikan konvensional. Melalui e-learning diharapkan pendidikan menjadi lebih mudah diakses, lebih murah, lebih menyenangkan dan lebih mudah untuk dibagikan dan dipelajari. E-learning memberikan keleluasaan bagi siswa untuk dapat belajar kapan saja dan di mana saja (Ramadiani, et al., 2017).

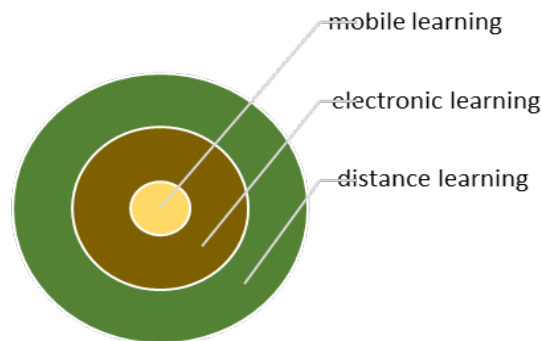

Gambar 1. Skema dari bentuk *m-Learning*

Sedangkan jumlah pengguna *smartphone* di Indonesia terus bertambah mencapai 33% dari 2013-2017. Pertumbuhan pesat ini didorong oleh pengguna usia muda di bawah 30 tahun, tepatnya usia 18-24 tahun, dengan porsi 61 persen dari seluruh pengguna. Adapun jumlah pengguna *smartphone* di Indonesia tahun 2015, menurut data dari eMarketer (2017), diperkirakan mencapai 52 juta. Angka ini akan terus bertambah menjadi 69 juta pada 2016 dan 87 juta pada 2017. Laporan ini dirancang berdasarkan pada pengumpulan data penggunaan otomatis dari lebih dari 1.600 pengguna *smartphone* di Indonesia.

Istilah *mobile learning* (*m-Learning*) mengacu kepada penggunaan perangkat teknologi genggam dan bergerak, seperti PDA, telepon genggam, Laptop dan tablet PC, dalam pengajaran dan pembelajaran. *Mobile Learning* (*m-Learning*) merupakan bagian dari *electronic learning* (*e-Learning*) sehingga, dengan sendirinya, juga merupakan bagian dari *distance learning* (*d-Learning*) [10].

Mobile learning merupakan irisan dari *mobile computing* dan *e-learning* yang menyediakan sumber daya yang dapat diakses dari manapun, kemampuan sistem pencarian yang tangguh, interaksi yang kaya, dukungan yang penuh

terhadap pembelajaran yang efektif dan penilaian berdasarkan kinerja. Alternatif model pembelajaran yang memiliki karakteristik, tidak tergantung lokasi dan waktu. Selain hal tersebut, model alternatif tersebut juga diharapkan mampu menyediakan fasilitas knowledge sharing dan visualisasi pengetahuan sehingga pengetahuan menjadi lebih menarik dan mudah dipahami [2][3][4][10]. Konsep tersebut diharapkan dapat mendorong terwujudnya suasana pembelajaran yang baru dan dapat memotivasi semangat belajar siswa dan guru.

Referensi

- [1]. Ramadiani, et al, 2017. *User Satisfaction Model for e-Learning Using Smartphone*. [ProcediaComputer Science](https://doi.org/10.1016/j.procs.2017.10.070). **116**, pp.373-380. <https://doi.org/10.1016/j.procs.2017.10.070>
- [2]. Aaron Smith, 2015. U.S. Smartphone Use in 2015. Pew Research Center.
- [2]. Ramadiani, et al, 2015. Integrated Acceptance Model for E-Learning. International Conference on Engineering and Technology for Sustainable Development (ICET4SD) 11-12 Nov, Indonesia. *IOP Conference Series: Materials Science and Engineering*, **105**(1): pp. 1-9.
- [3]. Ramadiani, et al., 2013. E-Learning User Acceptance based on Analysis of User's Style, Usability, and User Benefits, *Jurnal Sistem Informasi (JSI)*, **9**(1): pp. 6-12
- [4]. Rhonda Christensen, Gerald Knezek, 2017. Readiness for integrating mobile learning in the class room; challenges, preferences and possibilities. *Computers in Human Behavior* 76 (2017) 112-121
- [5]. Ozlem Ozan, Gonca Telli Yamamoto, Uğur Demiray, 2015. Mobile learning technologies and educational applications, *Highlight* pp: 97-109
- [6]. UNESCO, 2012. Turning on mobile learning, Illustrative Initiatives and Policy Implications, *the Working Paper Series on Mobile Learning*, ISSN 2227-5029.
- [7]. Iin Karmila Yusri, Robert Goodwin and Carl Mooneya, 2015. Teachers and mobile learning perception: towards a conceptual model of mobile learning for training. *Procedia - Social and Behavioral Sciences* 176. 425 - 430

- [8]. Ramadiani, R. Atan, M. H. Selamat, R. Abdullah, N. C. Pa and Azainil, 2016. User difficulties in e-learning system. *2nd International Conference on Science in Information Technology (ICSITech)*, Balikpapan, pp. 158-162.
- [9]. Sharples Mike, Taylor Josie, Vavoula Giasemi, 2005. Towards a Theory of Mobile Learning. 4th World conference on mLearning, Cape Town, South Africa, Tshwane University of Technology
- [10]. <https://alisadikinwear.wordpress.com/2012/07/07/mobile-learning-m-learning-solusi-cerdas-pembelajaran-terkini/> diakses pada tanggal 8 Agustus 2018.
- [11]. Ally Mohamed (Ed.), 2009. Mobile Learning: Transforming the delivery of education and training, Edmonton, AU Press, Athabasca University http://www.aupress.ca/books/120155/ebook/99Z_Mohamed_Ally_2009-MobileLearning.pdf

An integrated model of e-learning continuance intention in Indonesia

Ramadiani*, Azainil

Faculty of Computer Science and Information Technology,
Mulawarman University, Indonesia

Email: ramadiani@fkti.unmul.ac.id

Faculty of Teacher Training and Education,
Mulawarman University, Indonesia

Email: nil_smd@yahoo.com

Frisca, Achmad Nizar Hidayanto

Faculty of Computer Science,
Universitas Indonesia, Indonesia

Email: frisca@cs.ui.ac.id, nizar@cs.ui.ac.id

*Corresponding author

Abstract: There had been some research concerning behaviour in using e-learning system. Most of the analysis focuses on the students' behavioural intention to use the system, without doing further analysis to find out their continuance intention to use it again. Therefore, this research aims to develop a model that describes the influencing factors on e-learning continuance intention of Indonesian students. Analysis in this research is focused on the investigations of the e-learning satisfaction, e-learning usefulness, and e-learning effectiveness, from the four main aspects: e-learning materials/multimedia, service quality, interaction, and learner's characteristics. By using Structural Equation Modelling approach, several analyses were conducted to 635 respondents' data, obtained from various university in Indonesia. This research found that almost all of the factors analysed in this research have a significant influence on continuance intention of Indonesian students, with e-learning satisfaction and e-learning usefulness as the main factors that influence directly, and navigation, reliability, tangibles, self-efficacy, and learner-content interaction as the main factors that influence indirectly.

Keywords: E-learning; continuance intention; Structural Equation Modeling; satisfaction; benefits; effectiveness; service quality; interaction; user characteristics. information technology;

Reference to this paper should be made as follows: Ramadiani et al. (2018) '.....', *Int. J. Innovation and Learning*, Vol. xx, No. xx, xxx-xxx.

Biographical notes: Ramadiani currently works as Chairman of the Computer Science Department in Mulawarman University. Lecturer at

Faculty of Computer Science and Information Technology in Mulawarman University since December 2001. She does research in Software Engineering, Information Systems (Business Informatics) and Human-computer Interaction. Her current project is 'e-Learning'. She graduated from Computer Doctor of Universiti Putra Malaysia in 2015.

Azainil is a Lecturer in Mulawarman University Samarinda since 1991. He teaches in Master of Management and Education Technology with expertise in Higher Education, e-Learning, Teaching Methods, TQM and Educational Technology.

Frisca was a Magister student of information system department in Indonesia University with main research interests within problems in Information System, User behavior, Multivaried Analysis and communication technology.

Achmad Nizar Hidayanto is Vice Dean for Resources, Ventura, and General Administration of University of Indonesia. Lecturer at Faculty of Computer Science University of Indonesia since December 2000. He graduated from Computer Doctor of Indonesian University in 2008. His research Interest is Information Systems and Information Technology (Adoption of Technology, E-Government, E-Commerce, Knowledge Management, Human Behavior in Information Systems, Innovation Management).

1 Introduction

As good as any technology, certainly will not escape the shortcomings, as well as e-learning system. Although web-based environments can provide students with flexibility in learning, some research suggests that students who are accustomed to traditional learning will find it hard to adapt to web-based learning systems (Katherine et al, 2016).

To overcome this, it is essential to examine the factors that affect the intention of students in using e-learning system. The students' intention to accept the e-learning system means that they are confident it will give benefit to their learning performance (Ramadiani et al., 2016). Previous research suggests the importance of users' attitude variables such as perceived ease use, perceived usefulness, and utility as good predictors of e-learning acceptance (Ramadiani, et al., 2015). Furthermore, it is also necessary to trace the factors that can sustain the students' intention to continue to use e-learning system, because a system can be said to succeed if users choose to persist in using the system on an ongoing basis, not only use it temporarily (Ramadiani, et al., 2013).

Web-based applications with Internet utilization have been introduced to meet today's educational needs, namely to minimize the gap between traditional learning systems and technology-based learning systems. The Internet also creates a need for learning innovation in the university environment, using a more modern, effective and efficient alternative with e-learning systems (Hamzah et al., 2017).

E-learning is a system that provides various services to handle all aspects of the learning process, through an intuitive and consistent web interface (Manal, 2017). The e-learning system begins to change the learning orientation, from which it relies on the teacher to become an independent learning process by the

students, thus enabling a student to play an active and responsible role for himself (Ramadiani, et al., 2013). E-learning is expected to facilitate the weakness that existed or found in the conventional education. Through e-learning is hoped education become more accessible, cheaper, more fun and easier to share and to learn. E-learning provides flexibility for students to be able to study anytime and anywhere (Wong, 2015).

Although web-based environments can provide students with flexibility in learning, some research suggests that students who are accustomed to traditional learning will find it difficult to adapt to web-based learning systems (Seters et al., 2012). In reality, the e-learning was not entirely successful as expected. Some students are not interested to use it then try to retrieve their references from others websites. There are many causes why the students rarely use e-learning: first it is not in accordance with the user need, the second it is not to answer the difficulties were faced by students, third the user interface is still weak and does not the user interface expect (Ramadiani et al, 2013). This can lead to the loss of student motivation to continue using the e-learning system. The results of previous research, indicating the tendency of students to stop using e-learning because it is not in accordance with their need (Ramadiani, et al., 2015).

To overcome this, it is necessary to trace the factors that can maintain the intention of students to continue using the e-learning system (continuance usage intention), because a system can be said to succeed if the user chooses to persist in using the system in a sustainable manner, on a temporary basis (Shiau, 2012; Paul, 2017).

A number of studies have produced several theories in analyzing the behavior of users of an information system, including Technology Acceptance Model (TAM), Theory of Planned Behavior (TPB), Social Cognitive Theory (SCT), and Innovation Diffusion Theory (IDT) to these basic theories such as Three-Tier Technology Use Model (3-TUM), Decomposed Expectation Disconfirmation Theory (D-EDT), and Unified Theory of Acceptance and Use of Technology (UTAUT). Similarly, in the context of e-learning, various models have also been proposed *to predict the behavior of re-use of e-learning* such as (EDT theory). However, in general the study also still only sees from one or two perspectives only, such as from the perspective of user characteristics or from system quality (Chiu et al., 2005). The results of Chiu et al. (2005) shows that the three factors have a great correlation to satisfaction, and satisfaction also has a great correlation to e-learning continuance intention. This indicates that benefits, quality, and value are important factors for the fulfillment of user desire of e-learning system. Though e-learning is a complex ecosystem, involving teachers, students, content, and systems used for interaction that determine the attitude and behavior of students in using e-learning.

Unfortunately, a holistic understanding of the reuse of e-learning systems is still not widely found in the literature. In this study, we developed an integral model from which focused on investigating the level of *satisfaction*, *benefits*, and *effectiveness* of the use of e-learning systems in the long term, looking at the

four main aspects of material / multimedia, service quality, and user characteristics. By adopting several theories related to the acceptance of e-learning, the models in this study are grouped into three tiers: tier 1 in this research model describes the characteristics of learner and quality attributes, especially related to the quality of e-learning materials, service quality, and interaction, tier 2 that describes the affective and cognitive aspects which cover satisfaction, perceived usefulness, and perceived effectiveness (Liaw, 2008) and tier 3 as the main focus in this study, which is e-learning continuance intention (Shiau, 2012)

2 E-Learning Effectiveness

As explained earlier, e-learning today is a trend in the development of teaching and learning process. This resulted in the emergence of various theories and practices in the field of information systems and engineering related to the development of effective e-learning (Lee, 2008). One popular theory says that there are four factors that must be considered when developing an e-learning system, namely *environmental characteristics*, *environmental satisfaction*, *learning activities*, and *learners characteristic* (Liaw, 2008).

In the development of e-learning, *a high level of communication development* can be created by *environmental characteristics*, such as by creating a synchronous interaction. This allows learners to not only share information, but also to determine how to retrieve other useful information for it. Furthermore, *environmental satisfaction* factors will increase students' perceptions of technology that can support their participation in teaching and learning. While the factors of learning activities need to be considered so that learners and teachers can share their experiences and knowledge whenever and wherever, by using e-learning. Things that may be the lack of interest to use the internet media for teaching and learning process, thus causing e-learning to be not very effective in its development. Because that is the last factor that learners' characteristics also need to be considered in the development of e-learning.

Liaw (2008) also mentioned that another important factor to influence one's willingness in using internet media to support teaching and learning process is *personal attitude*. Development of e-learning will work well if there is *a clear understanding of personal attitude*. Understanding of personal attitude can be divided into three categories of measurement, namely *affective*, *cognitive*, and *behavioral*. Affective measures (such as perceived enjoyment) and cognitive measures (such as perceived self-efficacy and perceived usefulness) have a positive correlation with behavioral measurements or behavioral intention (*Liaw, 2008*). According to Chow (2015) how to effectively use the e-learning system in order to maximize user confirmation of expectation, and further to increase user satisfaction. Among the four factors of PAE, students' perception

of learning process has the most significant impact on satisfaction and continuance intention.

In this study, affective dimension is assessed from three factors: *e-learning satisfaction, perceived usefulness and effectiveness*. Satisfaction and perceived usefulness are the two main constructs of expectation-confirmation theory that have been shown to influence the user's intention to continue using the information system. It has been widely used to model the behavior of the use of information systems emphasis on usability, quality, and value factor. While e-learning effectiveness also proved as one of the important predictors in information system return.

Furthermore, *Liaw (2008)* also stated that there are three main factors that can build the effectiveness of e-learning, namely learner's *self-efficacy, multimedia formats, and interaction environment*. *Learner's self-efficacy* is needed because the e-learning system will be useful when users have the confidence to use the system. Therefore, e-learning users should have confidence in themselves to use the system. *Multimedia formats* are needed because the e-learning system uses multimedia display in operation, so the multimedia format is good and easy to use will facilitate the process of teaching and learning through the internet media itself. Therefore, good multimedia formats are necessary in establishing an effective e-learning system. *Interaction environment* is needed because the e-learning system is held in an academic environment, so there needs to be good socialization to e-learning users related to the use of the system. The process and activity of participatory engagement has been conceptualized by key participatory components are explored 1) interactions of learners 2) interaction of educators and learners 3) Interaction with content 4) self-reflection and 5) collaborative learning in e- allarning community (*Haryani et al, 2017*).

In addition to the above three aspects, the effectiveness of e-learning is also influenced by *the quality of service* from e-learning as a medium for online learning process. Service quality is used to know and understand the user's expectations and perceptions of a product or service (*Parasuraman et al, 1988*). In the context of e-learning, users will assess the quality of services according to their perceptions, which can be seen from the technical or non-technical factors given to them (*Carol, 2015*). Service quality has five dimensions that can be assessed, namely; responsiveness, assurance, reliability, tangibles, and empathy (*Parasuraman et al 1988; Udo et al, 2011*). Some studies have suggested that student satisfaction and motivation is higher in courses that use multimedia materials (*Gilakjani,2012*).

Considering the above, this research will evaluate the factors that encourage the *effectiveness, satisfaction and perception of e-learning benefits* from 4 aspects:

Table 1. E-learning effectiveness model

Variables	Description	Indicators	References
<i>e-learning materials,</i>	to assess multimedia content in an e-learning system	Attention, Deliverable, Media use, Navigation,	Keller & Suzuki (2004); Hassan & Li (2005); Liaw (2008); Chow (2015); Ramadiani (2015);
<i>service quality,</i>	to measure the level of satisfaction of users (knowing the user's expectations and perceptions of e-learning)	responsiveness, assurance, reliability, tangibles, empathy	Parasuraman, Zeithaml, & Berry (1988); Lee (2008); Udo, Bagchi, & Kirs (2011); Carol (2015); Suryanto (2016)
<i>interaction</i>	to measure the level of e-learning satisfaction and e-learning usefulness.	learner-content, learner-instructor, learner-learner	Burnett (2007); Sher (2009); Zhang & Zigurs (2009); Shiao (2012); Chow (2015);
<i>learner characteristics</i>	User confidence and awareness that arise to use the e-learning system	self-efficacy, self-directedness	Huang, (2008); Liaw (2008); Yu, (2007); Hsu, (2012). Ramadiani, (2015)
<i>continuance intention,</i>	the user's desire to use e-learning system in a sustainable and continuous manner	e-learning satisfaction, e-learning usefulness, e-learning effectiveness	Davis, (1989); Chiu et al. (2005); Liaw, (2008); Sanam, (2009); Wang & Liu, (2009); Wu & Huang (2010); Tanakinjal et al., (2012); Chow (2015);

3 Hypotheses Development

The proposed integrative model for e-learning continuance usage intention in this research is consists of three tiers. As mentioned, the first tier in this research model consists of four groups: e-learning materials, service quality, interaction, and learner's characteristics, each of which has several variables to assess the level of satisfaction, perceived usefulness, and effectiveness in the use of e-learning systems.

The four groups in tier 1 will be used to evaluate how the characteristics of users and the quality of a system can affect the affective and cognitive aspects of the second tier, which comprise of satisfactions, perceived usefulness, and perceived effectiveness of e-learning system. These three variables were shown to be strong predictors of a system acceptance, including 3-TUM and D-EDT (Liaw, 2008).

Furthermore, the second tier will be used to investigate how the affective and cognitive components can influence the continuance intention of e-learning system, which in our case is placed as the third tier. Continuance intention describes the user's desire to use e-learning system continuously. The third tier illustrates the behavioral intention used to understand the intention of users in using technology for a particular purpose (Liaw, 2008).

3.1 Impact of e-learning materials on e-learning satisfaction, usefulness, and effectiveness

The hypotheses in this study were based on theories in some previous studies. To facilitate in viewing the hypothesis representation in the above research model, the model is divided into four sub models. The first sub-model illustrates the correlation between the variables in the e-learning materials group in tier 1 with the variables in tier 2, and the correlation between the variables in tier 2 and the continuance intention variables in tier 3. Hassan & Li (2005) in his research mentioned that the representation of material or multimedia in a system will affect the benefits (usefulness) and satisfaction of the user (satisfaction) to the system. There are several categories of material on the website that are considered to affect the benefits and user satisfaction, including navigation, screen appearance, media use, attention, and accessibility. Some studies have suggested that student satisfaction and motivation is higher in courses that use multimedia materials (Gilakjani, 2012). Ramadiani (2016) found that good navigation on e-learning systems provides a positive perceived usefulness or benefits derived from the system. The navigation system is one aspect of multimedia material that is important and affect the effectiveness of the system. The way a system in presenting the material (information presentation) will affect the benefits and effectiveness of the system. Hassan et al. (2012) in his research related to the evaluation of e-learning materials mathematics found the fact that attention has an influence on satisfaction and is the most important factor that can affect the value of learners. Keller & Suzuki (2004) says that attention can affect the benefits of e-learning systems, and can improve learners' effectiveness through the system, thereby increasing their value. Ramadiani (2016) concluded that the use of good multimedia content (media use) on e-learning systems contributes to the user's satisfaction, benefits, and effectiveness of the system. Two factors of learning process and course design significantly influence satisfaction and continuance intention also was mention (Chow2015).

The first sub-model has 12 hypotheses that aim to know the correlation between the variables in the e-learning materials in tier 1 to the variables in tier 2, which can be formulated as follows:

Table 2 Sub-model one has 12 hypotheses

<i>No.</i>	<i>Hypothesis</i>	<i>Description</i>
1	H1a	Attention positively affects e-learning satisfaction
2	H1b	Attention positively affects e-learning usefulness
3	H1c	Attention positively affects e-learning effectiveness
4	H2a	Deliverable positively affects e-learning satisfaction
5	H2b	Deliverable positively affects e-learning usefulness
6	H2c	Deliverable positively affects e-learning effectiveness
7	H3a	Media use positively affects e-learning satisfaction
8	H3b	Media use positively affects e-learning usefulness
9	H3c	Media use positively affects e-learning effectiveness
10	H4a	Navigation positively affects e-learning satisfaction
11	H4b	Navigation positively affects e-learning usefulness
12	H4c	Navigation positively affects e-learning effectiveness

3.2 Impact of service quality on e-learning satisfaction, usefulness, and effectiveness

Parasuraman, Zeithaml, & Berry (1988) one of the previous studies that analyzed the dimensions of service quality (responsiveness, assurance, reliability, tangibles, empathy) to measure the level of satisfaction of users. Another study by Udo, Bagchi, & Kirs (2011) also revealed a positive and significant correlation between service quality and e-learning system effectiveness. The dimensions of service quality also affect the effectiveness of information system, research on the measurement of system effectiveness using the service quality principle. Based on research conducted by Lee (2008) with case studies in Korea and America, it can be concluded that service quality has a significant positive effect on the usefulness of e-learning systems.

Sub model two has 15 hypotheses that aims to determine the correlation between the variables in the service quality group in tier 1 with the variables in tier 2, which can be formulated as follows:

Table 3 5 hypotheses service quality on e-learning satisfaction, usefulness, and effectiveness

No.	Hypothesis	Description
13	H5a	Responsiveness positively affects e-learning satisfaction
14	H5b	Responsiveness positively affects e-learning usefulness
15	H5c	Responsiveness positively affects e-learning effectiveness
16	H6a	Assurance positively affects e-learning satisfaction
17	H6b	Assurance positively affects e-learning usefulness
18	H6c	Assurance positively affects e-learning effectiveness
19	H7a	Reliability positively affects e-learning satisfaction
20	H7b	Reliability positively affects e-learning usefulness
21	H7c	Reliability positively affects e-learning effectiveness
22	H8a	Tangibles positively affects e-learning satisfaction
23	H8b	Tangibles positively affects e-learning usefulness
24	H8c	Tangibles positively affects e-learning effectiveness
25	H9a	Empathy positively affects e-learning satisfaction
26	H9b	Empathy positively affects e-learning usefulness
27	H9c	Empathy positively affects e-learning effectiveness

3.3 Impact of interactions on e-learning satisfaction, usefulness, and effectiveness

Burnett et al. (2007) in research related e-learning states that interaction is an element that has an important influence in the success and effectiveness of an e-learning system. In the context of e-learning, assessment of interaction can be done by looking at different types of points of view, namely learner-content, learner-instructor, and learner-learner. In his research stated that there is a positive correlation of learner-content interaction to e-learning satisfaction and e-learning usefulness. The Chow (2015) study show that students' confirmation of expectation is significant in predicting user e- learning PAE in terms of learning process, tutor interaction, peer interaction, and course design. two PAE factors (learning process and course design) significantly influence satisfaction

and continuance intention. In Fresen research (2007) produces a positive correlation of learner-content interaction to e-learning effectiveness. Sher (2009) in his research says that there is a positive correlation of learner-instructor interaction to e-learning usefulness and e-learning satisfaction. While Zhang & Zigurs (2009) said that the learner-learner interaction has a positive influence on e-learning satisfaction and e-learning effectiveness. Therefore, we posit nine hypotheses as can be seen in Table 4.

Table 4.9 Hypotheses interactions on e-learning satisfaction, usefulness, and effectiveness

<i>No.</i>	<i>Hypothesis</i>	<i>Description</i>
28	H10a	Learner-content interaction positively affects e-learning satisfaction
29	H10b	Learner-content interaction positively affects e-learning usefulness
30	H10c	Learner-content interaction positively affects e-learning effectiveness
31	H11a	Learner-instructor interaction positively affects e-learning satisfaction
32	H11b	Learner-instructor interaction positively affects e-learning usefulness
33	H11c	Learner-instructor interaction positively affects e-learning effectiveness
34	H12a	Learner-learner interaction positively affects e-learning satisfaction
35	H12b	Learner-learner interaction positively affects e-learning usefulness
36	H12c	Learner-learner interaction positively affects e-learning effectiveness

3.4 Impact of learner's characteristics on e-learning satisfaction, usefulness, and effectiveness

Liaw (2008) that self-efficacy positively affects perceived satisfaction. In his research, Liaw also found that self-efficacy positively affects perceived usefulness. In addition to self-efficacy, other characteristics that also affect the satisfaction, benefits, and effectiveness of the e-learning system is self-directedness (Huang, 2008). Sub-model four has 6 hypotheses that aims to determine the correlation between the variables in the learner's characteristics group in tier 1 with the variables in tier 2, which can be formulated as follows.

The fourth sub-model aims to find out the correlation between the variables in the learner's characteristics group in tier 1 with the variables in tier 2, and the correlation between the variables in tier 2 and the continuance intention variables in tier 3. Liaw (2008) that self-efficacy positively affects perceived satisfaction. In his research, Liaw also found that self-efficacy positively affects perceived usefulness. In addition to self-efficacy, other characteristics that also affect the satisfaction, benefits, and effectiveness of the e-learning system is self-directedness (Huang, 2008).

Table 5 Hypotheses learner's characteristics on e-learning satisfaction, usefulness, and effectiveness

<i>No.</i>	<i>Hypothesis</i>	<i>Description</i>
37	H13a	Self-efficacy positively affects e-learning satisfaction
38	H13b	Self-efficacy positively affects e-learning usefulness
39	H13c	Self-efficacy positively affects e-learning effectiveness
40	H14a	Self-directedness positively affects e-learning satisfaction
41	H14b	Self-directedness positively affects e-learning usefulness
42	H14c	Self-directedness positively affects e-learning effectiveness

3.5 Impact of e-learning satisfaction, usefulness, and effectiveness on continuance usage intention

Chow (2015) said that user satisfaction is an important element and as a strong predictor of the factor continuance intention. She also concluded that improvements to user satisfaction have a positive effect on students' desire to use e-learning system in a sustainable manner. Davis (1989) says that perceived usefulness has a positive effect on behavioral intention. Ramadiani et al. (2016) which concludes that the usability of the e-learning system positively affects the students' desire to use the system. Liaw (2008) that e-learning effectiveness positively influence toward behavioral intention of using e-learning. A high level for degree's usefulness has a positive effect on retention. Further, cognitive gains and supportive environment positively impact degree's usefulness. Negative feelings (personal values) are found to reduce student retention. The correlation between the variables in tier 2 and the continuance intention variable can be formulated in the following three hypotheses:

Table 6 Hypotheses e-learning satisfaction, usefulness, and effectiveness on continuance usage intention

No.	Hypothesis	Description
43	H15a	e-learning satisfaction positively affects <i>continuance intention</i>
44	H15b	e-learning usefulness positively affects <i>continuance intention</i>
45	H15c	e-learning satisfaction positively affects <i>continuance intention</i>

The proposed research model can be seen in Figure 1.

Figure 1 Research hypothesis model

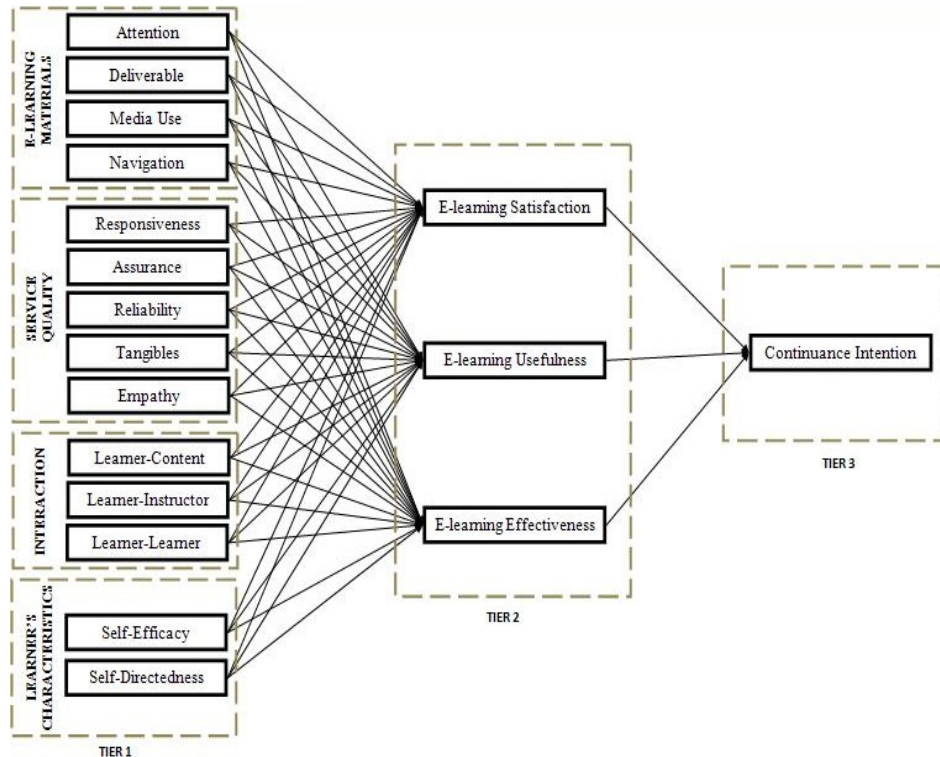

4 Research Methodology

4.1 Research Instrument

This instrument used in this research is in form of a questionnaire that was made using a Likert scale of 1 to 5, 1 for 'Very Disagree', 2 for 'No Agree', 3 for 'Neutral', 4 for 'Agree', and value 5 for 'Strongly Agree' answer. Likert scale is used because it is considered effective in measuring behavior that is subjective, as in research related to the measurement of perceptions or expectations of someone (Göb et al., 2007).

The questionnaire is divided into 6 sections:

Section A: Personal data of respondents

Section B: Statements relating to E-learning Materials

Section C: Statements related to Service Quality factors

Section D: Statement related to Learners Characteristics factor

Section E: Interaction Factor-related Statements

Section F: Statements related to Affective, Cognitive, and Continuance Intention factors

Table 7 shows the variables and indicators used in the questionnaire, particularly for section B - section F.

Table 7 Research variables and indicators

<i>No</i>	<i>Variable</i>	<i>Indicator Variables</i>	<i>Reference</i>
1.	Attention (AT)	<p><i>AT1.</i> The materials in the e-learning system drew my attention to study it.</p> <p><i>AT2.</i> The materials in the e-learning system are displayed through various types of media (video, audio, and text) with great interest</p> <p><i>AT3.</i> The materials that exist in the e-learning system can arouse my interest to stay focused on learning it.</p>	Carr & Carr, (2000); Keller, (2004);
2.	Deliverable (DE)	<p><i>DE1.</i> The materials that exist in the e-learning system use easy-to-understand grammar.</p> <p><i>DE2.</i> The materials on the e-learning system are packaged in a file that allows me to access them (eg: .pdf, .doc, .ppt, etc.).</p> <p><i>DE3.</i> The materials in the e-learning system convey the object of lecture purpose clearly, making it easier for me to understand it.</p>	Parasuraman et al, (1998); Kim & Lee, (2002);
3.	Media Use (MU)	<p><i>MU1.</i> The e-learning system already has good sound media for displaying information or course material.</p> <p><i>MU2.</i> The e-learning system already has good video media to display information or course material.</p> <p><i>MU3.</i> The e-learning system already has good text media to display information or course material.</p>	Timmerman & Kruepke, (2006); Sun & Cheng, (2007); Ramadiani, (2015);
4.	Navigation (NA)	<p><i>NA1.</i> The materials on the e-learning system have user-friendly navigation, making it easier for me to move from one material to another.</p> <p><i>NA2.</i> The materials that exist in the e-learning system require simple steps (simple) to be able to access.</p> <p><i>NA3.</i> The material and information I want can be easily</p>	Parasuraman et al, (1998); Kim & Lee, (2002); Ramadiani, (2015);

No	Variable	Indicator Variables	Reference
		found with the help of search feature in the system e-learning	
5.	Responsiveness (RS)	<p><i>RS1.</i> The e-learning system does not require long loading time, so I am easy to access it when internet connection is available.</p> <p><i>RS2.</i> Accessing material on an e-learning system does not require long loading time, so I can access it quickly.</p> <p><i>RS3.</i> The process of uploading or downloading material on an e-learning system does not require long loading time so I can upload or download material quickly</p>	Parasuraman et al, (1998); Daniel & Berinyuy, (2010); Ramadiani, (2015);
6.	Assurance (AS)	<p><i>AS1.</i> In my opinion, experts (eg helpdesk) provided for e-learning systems have good experience in their field.</p> <p><i>AS2.</i> The e-learning system is supported by experts (eg helpdesk) which can be a place to ask if I have difficulty using it.</p> <p><i>AS3.</i> My personal data contained in the e-learning system is secure and never misused by the system administrator</p>	White, (1998); Daniel & Berinyuy, (2010); Hossein, (2015); Ramadiani, (2015);
7.	Reliability (RE)	<p><i>RE1.</i> The e-learning system has provided a complete and accurate service for students' learning needs at my university.</p> <p><i>RE2.</i> I feel the functionality of e-learning system that I use is in accordance with the needs of the lecture process.</p> <p><i>RE3.</i> I feel the e-learning system has helped a lot in the process of finding the information I need.</p>	Parasuraman et al, (1998); Daniel & Berinyuy, (2010); Ramadiani, (2015);
8.	Tangibles (TA)	<p><i>TA1.</i> I feel the selection of LMS types (eg Moodle, Atutor, Claroline, Saki Project, Blackboard, etc.) on e-learning system at my university is appropriate compared to other LMS types.</p> <p><i>TA2.</i> I feel the LMS used in my university's e-learning system is up-to-date (not old-fashioned)</p> <p><i>TA3.</i> Experts for e-learning systems (eg helpdesk) are friendly and friendly when I ask questions.</p>	Parasuraman et al, (1998); White, (1998); Daniel & Berinyuy, (2010); Ramadiani, (2015);
9.	Empathy (EM)	<p><i>EM1.</i> The system manager always gives good responses every time I do complain or give input related to e-learning system.</p> <p><i>EM2.</i> Experts (eg helpdesk) often ask users of e-learning systems about problems they encounter in using e-learning systems.</p> <p><i>EM3.</i> The e-learning system gives me the freedom to change the look of the system according to my needs (eg changing the default display color of the system, choosing the list of courses who wants to be displayed, etc.)</p>	White, [1998] Daniel & Berinyuy, (2010); Ramadiani, (2015);
10.	Self-Efficacy {SE}	<p><i>SE1.</i> I feel confident to use the e-learning system as a media sharing or discussion in the learning process</p> <p><i>SE2.</i> I feel confident to use e-learning system as an online exam / quiz media</p>	Burnett (2007); Fresen (2007); Sher (2009); Zhang & Zigurs (2009);

No	Variable	Indicator Variables	Reference
		<i>SE3</i> . I feel confident to operate the menus/features of the e-learning system I use	Haryani et al, 2017
11.	Self-Directedness (SD)	<i>SD1</i> . I use an e-learning system on my own initiative, without invitation or coercion from others <i>SD2</i> . I feel able to adapt well to using e-learning system, without need of help from other party <i>SD3</i> . I find it easier to learn on my own with e-learning systems, without much involvement of faculty	Burnett (2007); Fresen (2007); Sher (2009); Zhang & Zigungs (2009); Haryani et al, 2017
12.	Learner-Content Interaction (LC)	<i>LC1</i> . I feel the material and information that exist in the e-learning system is easy to understand. <i>LC2</i> . I feel the material and information that exist in the e-learning system can help improve the quality of my learning. <i>LC3</i> . I do not feel any technical problems while accessing the material or information that is in the e-learning system.	Kelsey & Souza, (2004); Sharp & Huett, (2006); Chow (2015); Haryani et al, (2017)
13.	Learner-Instructor interaction (LI)	<i>LI1</i> . I feel my learning interaction with the teacher through the e-learning system really helps me in the learning process. <i>LI2</i> . I am easy to conduct discussions and provide input or criticism related learning materials to teachers through e-learning system <i>LI3</i> . Teachers are always responding to questions related to the learning materials I am proposing to the e-learning system.	Kelsey & Souza, (2004); Sharp & Huett, (2006); Chow (2015); Haryani et al, (2017)
14.	Learner-Learner Interaction (LL)	<i>LL1</i> . I feel my learning interaction with other students through e-learning system really helps me in the learning process. <i>LL2</i> . I am easy to conduct discussion related learning materials with other students through e-learning system <i>LL3</i> . Other students are always responding to questions related to the learning materials I am proposing to the e-learning system.	Kelsey & Souza, (2004); Sharp & Huett, (2006); Chow (2015); Haryani et al, (2017)
15.	E-learning Satisfaction (ES)	<i>ES1</i> . I am satisfied with the quality of the e-learning system service I use. <i>ES2</i> . I feel confident to use e-learning system as an online exam / quiz media <i>ES3</i> . I feel my decision to use e-learning system is the right decision.	Zhu et al., (2002); Liaw, (2007); Ramadiani, (2015);
16.	E-learning Usefulness (EU)	<i>EU1</i> . The e-learning system has helped me to get additional new learning materials every day. <i>EU2</i> . I find it easier to learn on my own with e-learning systems, without much involvement of faculty. <i>EU3</i> . The e-learning system has helped me to get better grades	Davis, (1991); Liaw, (2007); Wang & Liu, (2009); Ramadiani, (2015);
17.	E-learning Effectiveness (EF)	<i>EF1</i> . The e-learning system has helped improve my learning performance. <i>EF2</i> . The e-learning system has helped improve my learning motivation. <i>EF3</i> The e-learning system has helped me in the process of completing my task The e-learning system	Liaw, (2007); Sanam, (2009); Ramadiani, (2015);

No	Variable	Indicator Variables	Reference
18.	Continuance Intention (CI)	has helped me in the process of completing tasks, <i>CI1.</i> For the future, I want to continue to use e-learning system to help my learning process. <i>CI2.</i> For the future, I plan to increase the intensity of using e-learning system to help my learning process <i>CI3.</i> For the future, I plan to use the e-learning system as my top priority in helping the learning process.	Davis, (1989); Venkatesh & Davis, (2000); Liaw, (2007); Chow (2015); Hossein, (2015)

4.2 Data collection procedures

The population in this study is the user of e-learning system at universities in Indonesia. Respondents cover all students who are actively using e-learning system, which comes from various regions, all over Indonesia. The total number of respondents in this study is as many as 635 respondents who came from various universities in Indonesia. Although there is an opinion that the ideal number of samples is about five times the number of indicators/questions (Ramadiani, 2010), but researchers have a target sample size of 500 respondents. This target is based on several considerations, one of which is the consideration that the sample can actually represent the condition of the entire population of e-learning system users from various islands in Indonesia, considering that each region may have different infrastructure.

Before the questionnaires were distributed to all respondents, the researcher tested the legibility to 20 people who had been or were using e-learning system and pretest to 100 respondents to test the reliability and validity of the questionnaire. After doing the pretest, the questionnaire distributed to respondents amounted to the respondents. The process of distributing questionnaires was done in a longtime span from February 25th until May 5th. The spread of the questionnaire was conducted online, through providing a questionnaire link to several known students, by contacting several lecturers from various universities, spreading links to several mailing lists, as well as by emailing to prospective respondents through known relatives or lecturers.

4.3 Data analysis

Data analysis is done by covariance-based SEM technique, that is by using LISREL application. Before performing further analysis, the SEM-based covariance technique in this study begins by entering the primary data obtained from the questionnaire into an excel file. This research uses Microsoft Excel 2007 application to enter data into excel format. This application is also used to perform data processing of respondent's profile.

Once entered into the excel file, the primary data is then imported into the SPSS application to pre-test the pilot study and test the normality of the entire data. After that LISREL is used to create a model and test it, by creating a SIMPLIS Syntax File that is filled with commands. If the test results prove that the model does not fit, then modification will be made to find the best possible model. The SEM analysis comprises of two main steps: measurement model evaluation and structural model evaluation (Ramadiani, 2010).

The measurement model evaluation is done using Confirmatory Factor Analysis (CFA) by looking at the values of standardized loading factor of indicators (λ) (≥ 0.50), Construct Reliability (CR) (≥ 0.70) and Variance Extracted (VE) (≥ 0.50) values (Ramadiani, 2010). The structural model is evaluated by looking at the goodness of fit values which comprise of the chi-square and its p-values, Comparative Fit Index (CFI), Goodness of Fit Index (GFI), Normed Fit Index (NFI), Non-Normed Fit Index (NNFI), Root Mean Square Error of Approximation (RMSEA), Adjusted Goodness of Fit Index (AGFI), as well as some other goodness of fit index, whether it meets the criteria of a good match size or not. Although there are many methods of measurement, there are only a few commonly-used goodness of fit indexes, including CFI, GFI, NFI, and NNFI (Hooper et al., 2008; Ramadiani. 2010).

5. Results and Discussions

5.1 Demography of respondents

Respondents who participated in the study consisted of 405 male respondents or 64%, and 230 female respondents or 36%. The majority of respondents came from undergraduate level that is a number of 607 respondents or about 96%. While the respondents in post-graduate only amounted to 28 respondents or about 4%. Based on frequency of use, frequent respondents (about 4-6 times a week) constitute the majority using e-learning system that is equal to 222 respondents or 35%. Students of this research respondents come from various regions, the majority of respondents came from Java Island which amounted to 338 respondents or by 53%. The majority of these research respondents are students from the Institute of Technology Sepuluh Nopember, which amounted to 251 respondents or 40%. and the majority are students who come from Information Systems department amounting to 285 respondents or by 45% (Table. 8).

Table 8: The demographic characteristics of Respondents

Respondents	No. of respondents	Percentage of respondents	Total
male	405	64%	635
female	230	36%	
level of education			
bachelor	607	96%	
postgraduate	28	4%	
frequency of e-learning use			
everyday	167	26%	
4-6 per week	222	35%	
2-3 per week	170	27%	
rarely	76	12%	
Respondent's Island of residence			
Jawa	338	53%	
Bali	138	22%	
Nusa Tenggara	109	17%	

Respondents	No. of respondents	Percentage of respondents	Total
Sulawesi	32	5%	
Sumatera	18	3%	
University of Respondents			
ITS	251	40%	
STMIK Bumigora Mataram	108	17%	
Universitas Indonesia	59	9%	
Universitas Sam Ratulangi	26	4%	
Universitas Udayana	14	2%	
Other universities	55	15%	
courses			
Infomatiom system	285	45%	
Informatics Engineering	149	23%	
Informatics Management	106	17%	
Computer science	45	7%	
Others courses	50	8%	

5.2 Results

From Table 9 we can see all t value of reseach indicators have greater value than 1.96, that means the research hypothesis are accepted. The modification of the model is commonly done with the aim of getting a more fit and appropriate model compared to the previous model, since a model that has been tested and proven valid is not the only fit model with existing data. Modification of the model is usually done by adding the relationship between constructs which can later decrease the value of chi-square, because if the chi-square value of a research model is smaller, then it indicates that the model is more in line with existing data (Ramadiani, 2010).

Reliability analysis is done by calculating Construct Reliability (CR) and Variance Extracted (VE) values of standardized loading factors and error variances. In this study, all variables have a value of $CR \geq 0.70$ and have a value of $VE \geq 0.50$, so it can be concluded that all variables in this study reliable value (Table 9) .

Table 9. Variance Extracted and Construct Reliability of variables

<i>Indicators</i>	<i>Loading factor (>0.70)</i>	<i>T value (≥ 1.96)</i>	<i>Means</i>	<i>Construct Reliability (>0.70)</i>	<i>Variance Extracted (>0.50)</i>
Attention (AT)				0.806	0.58
AT1	0.76	19.67	3.62		
AT2	0.66	16.80	3.53		
AT2	0.86	28.28	3.52		
Deliverable (DE)				0.830	0.620
DE1	0.78	21.13	3.81		
DE2	0.78	21.17	4.25		
DE3	0.80	21.79	3.83		
Media Use (MU)				0.856	0.667
MU1	0.79	14.0	3.14		
MU2	0.92	18.00	3.21		
MU3	0.70	13.28	3.94		
Navigation (NA)				0.816	0.600
N41	0.83	22.05	3.74		
N42	0.84	22.21	3.88		
N43	0.64	16.49	3.58		
Responsiveness (RS)				0.824	0.612

<i>Indicators</i>	<i>Loading factor (>0.70)</i>	<i>T value (≥ 1.96)</i>	<i>Means</i>	<i>Construct Reliability (>0.70)</i>	<i>Variance Extracted (>0.50)</i>
RS1	0.83	22.15	3.64		
RS2	0.85	22.94	3.34		
RS3	0.64	17.10	3.53		
Assurance (AS)				0.798	0.575
AS1	0.85	21.33	3.53		
AS2	0.83	20.60	3.45		
AS3	0.58	14.51	3.76		
Reliability (RE)				0.877	0.704
RE1	0.84	25.54	3.68		
RE2	0.88	26.01	3.75		
RE3	0.80	23.32	3.68		
Tangibles (TA)				0.794	0.565
TA1	0.80	20.17	3.56		
TA2	0.80	20.23	3.53		
TA3	0.65	16.41	3.46		
Empathy (EM)				0.814	0.59
EM1	0.69	17.58	3.48		
EM2	0.93	24.22	3.23		
EM3	0.68	17.37	3.07		
Self-Efficacy (SE)				0.838	0.634
SE1	0.79	21.59	3.62		
SE2	0.76	20.66	3.58		
SE3	0.84	23.18	3.78		
Self-Directedness (SD)				0.751	0.504
SD1	0.75	17.49	3.58		
SD2	0.76	17.67	3.73		
SD3	0.61	14.68	3.44		
Learner-Content Interaction (LC)				0.797	0.573
LC1	0.86	21.83	3.68		
LC2	0.81	29.59	3.72		
LC3	0.57	14.36	3.49		
Learner-Instructor Interaction (LI)				0.835	0.631
LI1	0.66	17.61	3.62		
LI2	0.90	24.84	3.35		
LI3	0.81	21.29	3.40		
Learner-Learner Interaction (LL)				0.901	0.752
LL1	0.86	26.00	3.36		
LL2	0.90	28.05	3.29		
LL3	0.83	24.96	3.23		
E-Learning Satisfaction (ES)				0.871	0.693
ES1	0.90	26.68	3.59		
ES2	0.79	22.50	3.48		
ES3	0.80	22.59	3.74		
E-Learning Usefulness (EU)				0.866	0.685
EU1	0.83	24.02	3.73		
EU2	0.90	26.69	3.70		
EU3	0.74	20.62	3.57		
E-Learning Effectiveness (EF)				0.866	0.685
EF1	0.90	36.45	3.60		
EF2	0.84	24.24	3.48		
EF3	0.73	20.35	3.72		
Continuance Intention (CI)				0.875	0.701
CI1	0.82	23.59	3.83		
CI2	0.90	27.01	3.72		
CI3	0.79	22.62	3.63		

The result of matching test which generally has a match value with good criterion, except GFI, AGFI, and Normed Chi-Square with marginal fit criteria. However, there is a theory that the value of $GFI \geq 0.8$ can actually be considered

good fit (Ramadiani, 2010). Therefore, it can be concluded that the results of this research model as a whole have a good match value (Table 10).

Table 10. Goodness of fit evaluation model

Goodness of Fit	Statistics Measurement Target	First model	Final model
Absolute Fit Measures			
χ^2	Smaller grades is better	4235.87	4166.82
NCP	Smaller grades is better	3751.63	4357.72
SNCP	Smaller grades is better	3537.93	4129.06
GFI	GFI \geq 0.90	0.76	0.80
RMSR	RMSR \leq 0.05	0.065	0.058
RMSEA	RMSR \leq 0.05	0.070	0.074
ECVI	Smaller grades is better	8.67	9.58
Incremental Fit Measures			
TLI or NNFI	NNFI \geq 0.90	0.98	0.98
NFI	NFI \geq 0.90	0.98	0.98
AGFI	AGFI \geq 0.90	0.72	0.73
RFI	RFI \geq 0.90	0.97	0.97
IFI	IFI \geq 0.90	0.98	0.98
CFI	CFI \geq 0.90	0.98	0.98
Parsimonious Fit Measures			
PGFI	Higher grades is better	0.64	0.64
Normed χ^2	Minimum grades: 1.0 Maximum grades: 3.0	3.299	3.334
PNFI	Higher grades is better	0.84	0.85
AIC	Smaller grades (positive) is better	5497.63	6074.72
CAIC	Smaller grades (positive) is better	6921.02	7339.96

After goodness of fit values were examined, the last step it to evaluate the causal relationship between variables as stated in the hypotheses. Table 10 summarizes the results of causal correlation test (t-value) based on structural model test on LISREL. This causal relationship test is done to know the significance of the influence of a variable to another variable to conclude whether a hypothesis is accepted or rejected. As can be seen in Table 11, all hypotheses are accepted.

Table 11. Research hypothesis results

No.	Hypothesis	Path	Path Coefficient	T-value	Decision
1	H1a	AT \rightarrow ES	0.23	-0.17	Rejected
2	H1b	AT \rightarrow EU	0.41	1.13	Rejected
3	H1c	AT \rightarrow EF	0.58	2.99	Accepted
4	H1d	AT \rightarrow LC	9.43	9.43	Accepted
5	H2a	DE \rightarrow ES	0.07	1.28	Rejected
6	H2b	DE \rightarrow EU	-0.02	1.97	Accepted
7	H2c	DE \rightarrow EF	-0.28	0.19	Rejected
8	H3a	MU \rightarrow ES	-0.08	2.53	Accepted
9	H3b	MU \rightarrow EU	0.01	-0.05	Rejected
10	H3c	MU \rightarrow EF	-0.02	-0.31	Rejected
11	H4a	NA \rightarrow ES	-0.03	-1.30	Rejected
12	H4b	NA \rightarrow EU	0.05	2.71	Accepted
13	H4c	NA \rightarrow EF	-0.07	2.01	Accepted
14	H5a	RS \rightarrow ES	-0.02	-0.12	Rejected
15	H5b	RS \rightarrow EU	0.02	0.32	Rejected
16	H5c	RS \rightarrow EF	-0.08	2.32	Accepted

No.	Hypothesis	Path	Path Coefficient	T-value	Decision
17	H6a	AS → ES	0.05	2.37	Accepted
18	H6b	AS → EU	-0.02	-0.21	Rejected
19	H6c	AS → EF	0.04	-1.59	Rejected
20	H7a	RE → ES	0.14	2.53	Accepted
21	H7b	RE → EU	0.03	3.68	Accepted
22	H7c	RE → EF	0.05	-1.14	Rejected
23	H8a	TA → ES	0.18	3.52	Accepted
24	H8b	TA → EU	0.14	-1.28	Rejected
25	H8c	TA → EF	0.03	1.99	Accepted
26	H9a	EM → ES	0.17	-1.36	Rejected
27	H9b	EM → EU	0.01	-0.89	Rejected
28	H9c	EM → EF	-0.02	-0.13	Rejected
29	H10a	LC → ES	0.05	1.77	Rejected
30	H10b	LC → EU	0.19	2.96	Accepted
31	H10c	LC → EF	0.11	3.34	Accepted
32	H11a	LI → ES	-0.05	-0.01	Rejected
33	H11b	LI → EU	0.01	2.72	Accepted
34	H11c	LI → EF	0.25	-1.34	Rejected
35	H12a	LL → ES	0.14	2.04	Accepted
36	H12b	LL → EU	-0.11	-1.81	Rejected
37	H12c	LL → EF	0.27	1.70	Rejected
38	H13a	SE → ES	0.16	2.66	Accepted
39	H13b	SE → EU	0.45	1.98	Accepted
40	H13c	SE → EF	0.20	1.64	Rejected
41	H14a	SD → ES	-0.52	-0.89	Rejected
42	H14b	SD → EU	-0.24	-0.90	Rejected
43	H14c	SD → EF	-0.13	2.53	Accepted
44	H15a	ES → CI	0.13	4.53	Accepted
45	H15b	EU → CI	1.07	4.34	Accepted
46	H15c	EF → CI	0.24	2.33	Accepted
47	H15d	EU → ES	0.34	3.95	Accepted

Figure 5 below is the final model result that is formed as a representation of factors affecting the desire of students in Indonesia to use e-learning system in a sustainable manner.

Figure 5 Final Model of Research

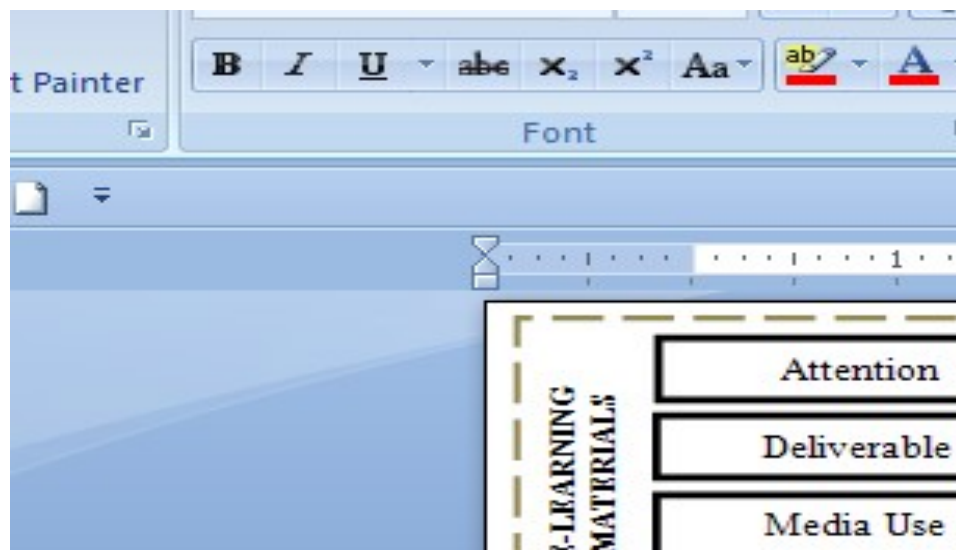

5.3 Discussion

The main objective of this research is to develop a model of acceptance of e-learning system on a continuous basis, focused on investigating the level of satisfaction, benefits, and effectiveness of system use by looking at the four main aspects, ie material/multimedia, service quality, interaction in system, and the characteristics of user. It is intended to provide comprehensive input on the factors that shape the desire of students in Indonesia to use e-learning system in a sustainable way to assist their lectures.

Based on the results of study that has been done, it can be seen that all the factors in tier 2; e-learning satisfaction, e-learning usefulness, and e-learning effectiveness have a positive effect on continuance intention. This indicates that the level of satisfaction, benefits, and effectiveness of the use of e-learning system has a strong correlation with the desire of students in Indonesia to use the system in a sustainable manner. As for the three factors, e-learning satisfaction factor has the greatest influence to continuance intention. This illustrates the importance of satisfaction factors for e-learning system students in Indonesia, so the fulfillment of these factors should be a top priority in developing e-learning systems that can attract students to use them sustainably. E-learning usefulness is the second most important factor to be considered in the development of e-learning system, followed by e-learning effectiveness factor.

This study has the same results with the previous research before, that show continuance intention of blog use was predicted collectively by user involvement, satisfaction and perceived enjoyment (Shiau, 2012). Chow (2015) expanded the ECM by using four quality assurance factors (learning process, tutor interaction, peer interaction, and course design) to measure students' post-adoption expectation (PAE) of e-learning, also confirm that confirmation is positively related to both PAE factors and satisfaction in using e-learning. Two PAE factors (learning process and course design) significantly influence satisfaction and continuance intention.

But according to Shiau (2012) users' satisfaction with blog use was predicted primarily by perceived enjoyment, followed by users' confirmation of expectation and user involvement. Perceived enjoyment was predicted by users' involvement and users' confirmation of expectation. Blogging time significantly moderates the effect of habit on perceived enjoyment, not on satisfaction and continuance intention. e-learning practitioners should focus on maximizing students' confirmation of expectations, as well as facilitating their PAE by improving the design of learning process and e-learning courses (Chow,2015). Chiao (2013) found that the web quality has significantly positive influences on perceived value and user satisfaction. Perceived value and satisfaction determines users' continuance intentions of e-learning systems in academic libraries. Other research found that the perceived ease of use, information quality and social influence were found to play important roles in predicting the continuance intention. System quality played an important role in affecting the perceived ease of use and unexpectedly, social motivations had no significant effect on attitude (Bing, 2013).

Not much different from e-learning satisfaction, e-learning usefulness is also most influenced by factors that come from service quality, that is reliability. This indicates that the ability of e-learning system in providing services consistently and accurately is the most important thing that can improve the assessment of the benefits of the system in Indonesia. While the factor of e-learning effectiveness is most influenced by factors derived from the interaction group, namely learner-content interaction. This indicates that the effectiveness of an e-learning system is strongly influenced by the fulfillment of good interaction between students with content in the system.

The four groups in tier 1 (e-learning materials, service quality, interaction, and learner's characteristics) have a positive influence on continuance intention. The four groups on the tier 1 indirectly influence the continuance of intention, through mediation with the factors on tier 2. The analysis on tier 1 is done by looking at the correlation of each variable of each group with the factors. Results analysis shows all main factors in tier 1 that have the most significant influence on continuance intention.

The navigation factor as a variable of the e-learning materials group illustrates the ease of navigation in the e-learning system. This factor has a significant correlation to e-learning usefulness and e-learning effectiveness, thus indicating that this factor also indirectly affects the continuance intention. Based on this, it can be concluded that ease of navigation in the e-learning system can affect the user's desire to use the system in a sustainable manner.

Reliability and tangibles are two factors of the service quality group that have the most significant influence on continuance intention. This is evident from the significant positive correlation between reliability with e-learning satisfaction and e-learning usefulness, as well as between tangibles with e-learning usefulness and e-learning effectiveness. This indicates that the ability to deliver a service consistently and accurately, and the appearance of the features available in the e-learning system are factors that indirectly affect the continuance intention. The next factor that has a great influence on continuance intention comes from the interaction group, namely the learner-content interaction. This indicates that improving the interaction between students and lecture materials contained in the e-learning system is an important thing to note in the development of e-learning system, in order to attract student interest in Indonesia to use it in a sustainable. The last factor on tier 1 which has the most significant influence on continuance intention is self-efficacy, derived from the learner's characteristic group. This is evident from the significant correlation between self-efficacy with e-learning satisfaction and e-learning usefulness. Based on this, it can be concluded that all condition of e-learning users' self-confidence can also increase them to continue to use the system in a sustainable manner.

5.4 Implications

This study provides the implications that can be seen from several points of view, namely:

5.4.1 For e-learning Developers

There are several factors that should be prioritized by e-learning system developers as an effort to develop the system in order to attract student interest in Indonesia. The main priority factor is the understanding of how to improve the benefits of e-learning system and how to improve student's satisfaction with the system (e-learning satisfaction and e-learning usefulness). To improve the benefits of the system is to optimize the reliability factor, to provide a consistent, update and accurate service in e-learning system. The improvements to the fulfillment of system satisfaction can be done by optimizing all research indicators, such as by providing an interesting view on the features of e-learning system.

5.4.2 For Teachers and Tutors

The effectiveness of an e-learning system is an important factor that teachers need to prioritize to create an effective learning through the system. This effectiveness can be improved by focusing on interaction factors in the system, for example in learner-content interaction, by providing the easily understood materials and easily accessible by students, to improve the quality and performance of their learning. Another factor that should also be considered by the teachers is the interaction between the teacher and his students. The example of a simple thing that can be done by the teacher is by responding to questions related to learning materials. Another thing that can be done is to trigger a discussion material in the e-learning system, so that students can actively participate in the online discussion.

5.4.3 For University Management

As one of the parties providing e-learning services, university management should pay particular attention to the implementation of this system. One of the important aspects that university management needs to consider is how to increase student awareness to be active in using university e-learning system. To achieve this, the university management actively organizing socialization related to the importance of e-learning system and e-learning process. Socialization the e-learning system how to use it also needs to be done by the university. By doing so, students' confidence in using e-learning systems (self-efficacy) will increase, so that the benefits and effectiveness of the system can also increase.

5.4.4 For Research and Sciences

The results of this study can provide input for research purposes or further research related to the acceptance of e-learning, especially in research that focuses on the analysis of user desire to use e-learning system in a sustainable

manner. For further research purposes, the researcher can perform the analysis by conducting further exploration of several main factors affecting the sustainability of e-learning usage. Based on the results of this study, the main factor that has the most significant impact directly to continuance intention is e-learning satisfaction, followed by e-learning usefulness factor. In addition to these two factors, there are five main factors that have the most significant influence on continuance intention indirectly, namely navigation, reliability, tangibles, self-efficacy, and learner-content interaction. By exploring these aspects, the analysis of continuance intention is expected to contribute more to the development of e-learning systems for the future.

6. Conclusion

The results of this study indicate that the material or multimedia aspects, service quality, interaction, and characteristics of e-learning system users generally have a significant influence on the assessment of the satisfaction, benefit, and effectiveness of the system in Indonesia. Satisfaction, benefits, and effectiveness of the e-learning system also has a significant influence on the desire of students in Indonesia to continue to use the system in a sustainable manner. It can be concluded that almost all factors analyzed in this study have a significant influence on the desire of students in Indonesia to use e-learning system in a sustainable manner. Factors that have a direct influence of e-learning satisfaction, e-learning usefulness, and e-learning effectiveness, while the factors that have an indirect effect of attention, deliverable, media use, navigation, responsiveness, assurance, reliability, tangibles, empathy, learner-content interaction, learner-instructor interaction, learner-learner interaction, self-efficacy, and self-directedness. There are two main factors that influence continuance intention directly, e-learning satisfaction and e-learning usefulness. In addition, there are five main factors affecting continuance intention directly, navigation, reliability, tangibles, self-efficacy, and learner-content interaction.

Acknowledgements

The research was funded by the Directorate of Research and Community Service of the Directorate General of Research and Development of the Ministry of Research, Technology and Higher Education of the Republic of Indonesia in accordance with the Research Contract No.146 / UN17.41 / KL.2018

References

- Abdullah, M. S. & Toycan, M. (2018) Analysis of the factors for the successful e-learning services adoption from education providers' and students' perspectives: A case study of private universities in Northern Iraq. *Eurasia J. Math. Sci. Technol. Educ.* **14**, pp. 1097–1109
- Almahamid, S. & Rub, F. F. A. (2011) Factors that determine continuance intention to use e-learning system: an empirical investigation. *Int. Conf. Telecommun. Technol. Appl. Proc. CSIT* **5**, pp. 242–246
- Almarabeh, T. (2014) Students' Perceptions of E-Learning at the University of Jordan. *Int. J. Emerg. Technol. Learn.* **9**, pp. 31–35
- AP Gilakjani, (2012) The Significant Role of Multimedia in Motivating EFL Learners' Interest in English Language Learning, *I.J.Modern Education and Computer Science*, **4**, pp. 57-66 DOI: 10.5815/ijmeecs.2012.04.08
- A Thananchana, T Chandarasupsang and N Chakpitak, (2017) An alternative IT investment framework based on university learning model in asset management, *Int. J. Innovation and Learning*, **2**(1): pp. 69-97
- Basak, S. K., Wotto, M. & Bélanger, P. (2017) Factors Affecting to learning in Continuing Education in Africa: a review of literature. *International Journal OF Engineering Sciences & Management Research.* **4**, pp. 86–97
- Bing Wu & Chenyan Zhang (2014) Empirical study on continuance intentions towards E-Learning 2.0 systems, *Behaviour & Information Technology*, **33**(10): pp.1027-1038.
- Bubel, D. & Cichoń, S. (2017) Role of information in the process of effective management of the university. *Int. J. Innov. Learn.* **21**, pp. 114–125
- Burnett, K et al., (2007) *Frequency, Intensity and topicality in online learning: an exploration of the interaction dimensions that contribute to student satisfaction in online learning.* *Journal of Education for Library and Information Science*, **48**(1): pp. 21-35.
- [Carol L](#), [Celine B](#), [Michael W. Marek](#), [Brendan C](#), (2015) "Service quality and customer satisfaction: qualitative research implications for luxury hotels", *International Journal of Culture, Tourism and Hospitality Research*, **9**(2): pp. 168-182,
- Chiu, C et al. (2005). *Usability, quality, value and e-learning continuance decisios.* *Computers and Education*, **45**, pp. 399-416.
- [Chiao-Chen Chang](#), (2013) Exploring the determinants of e-learning systems continuance intention in academic libraries, *Library Management*, **34**(1/2): pp.40-55,
- Chow, W. S. & Shi, S. (2014) Investigating Students' Satisfaction and Continuance Intention toward E-learning: An Extension of the Expectation – Confirmation Model. *Procedia - Soc. Behav. Sci.* **141**, pp. 1145–1149
- Daniel, C., & Berinyuy, L. (2010) *Using the SERVQUAL model to assess service quality and customer satisfaction* [Master thesis]. UMEA University.
- Davis, F.D. (1989) *Percieved Usefulness, Percieved Ease of Use, and User Acceptance of Information Technology.* *MIS Quarterly*, **13**. pp. 318-340.
- DeLone, W. H., and McLean, R. (1992) Information systems success: The quest for the dependent variable. *Information Systems Research*, **(3)**1: pp. 60-95.
- Ervi C and AN Hidayanto, (2013) [The relationship among organizations' factors, information technology, innovation and performance: an Indonesian SMEs study.](#) *Int. J. of Innovation and Learning*, **(14)**3/4: pp. 422 - 443 DOI: [10.1504/IJIL.2013.056236](#)
- Ebaa Fayyoumi, Sahar Idwan, Khalid AL-Sarayreh, Randa Obeidallah (2015) [E-learning: challenges and ambitions at Hashemite University](#), *Int. J. of Innovation and Learning*, Vol.17, No.4, pp.470 – 485, DOI: [10.1504/IJIL.2015.069632](#)
- Giannakos, M.N., Pappas, I.O., Jaccheri, L. et al. (2017) Understanding student retention in computer science education: The role of environment, gains, barriers and usefulness. *Educ Inf Technology* **(22)**5: pp. 2365–2382.
- Hair J.F., Black W.C., Babin B.J., Anderson R.E., and Tatham R.L. (2006). *Multivariate data analysis 6th Edition*. Pearson Prentice Hall. New Jersey.
- Han, S., Seppanen, M., Mustonen, P. & Kallio, M. (2004) Physicians' Behavior Intentions Regarding a Mobile Medical Information System: An Exploratory Study. *International Journal of Mobile Communications*, **4**(2): <https://doi.org/10.1504/IJMC.2006.008610>

- Haron, H., Natrah Aziz, N. H. & Harun, A. (2017) A Conceptual Model Participatory Engagement Within E-learning Community. *Procedia Comput. Sci.* **116**, pp. 242–250
- Hassan M. Selim; Ananth Chiravuri (2015). [Identification of factors affecting university instructors' adoption of hybrid e-learning](#), *Int. J. of Innovation and Learning*, 2015 Vol.17, No.4, pp.486 – 515, DOI: [10.1504/IJIL.2015.069633](#)
- Hossein Mohammadi, (2015) Investigating users' perspectives on e-learning: An integration of TAM and IS success model. *Computers, in Human Behavior* **45**, pp. 359–374
- Hsu, M. H., Yen, C. H., Chiu, C. M., and Chang, C. M., (2006) A longitudinal investigation of continued online shopping behavior: An extension of the theory of planned behavior. *International Journal of Human-Computer Studies*, **64**(9): pp. 889-904.
- Hsu, P.S. (2012) Learner Characteristic Based Learning Effort Curve Mode: The Core Mechanism on Developing Personalized Adaptive E-Learning Platform. *Turkish Online Journal of Educational Technology - TOJET*, **11**(4): pp. 210-220.
- Huang, M. (2008) *Factors influencing Self-directed Learning Readiness amongst Taiwanese nursing students*. Queensland University of technology. School of Nursing. Institute of health and Biomedical Innovation.
- H Fitriani; AN Hidayanto; EK. Budiardjo; Meyliana; K Phusavat (2016) [Factors influencing the intention to share knowledge in citizen media with stimulus-organismic-response framework](#). *Int. J. of Web Based Communities*, **12**(4): pp.419–438 DOI: [10.1504/IJWBC.2016.10001833](#)
- J.R.van Seters, M.A.Ossevoort, J.Tramper, M.J.Goedhart, (2012) The influence of student characteristics on the use of adaptive e-learning material, *Computers & Education* **58**(3) April, pp. 942-952.
- Katherine M, Kimberly O, Roxanne R, Maria K.H, John J.F & Katherine B (2016) Teaching in a Digital Age: How Educators Use Technology to Improve Student Learning, *Journal of Research on Technology in Education*, **48**(3): pp. 194-211.
- Keller, J. M., & Suzuki, K. (2004). *Learner motivation and e-Learning design: A mutationally validated process*. *Journal of Educational Media*, **29**(3): pp. 229-239.
- Kenneth Wong; Reggie Kwan; Fu Lee Wang; Louise Luk, (2015) A pilot study on students' learning experience on the e-learning using social networking. *Int. J. of Innovation and Learning*, **18**(3): pp. 299–312. DOI: [10.1504/IJIL.2015.071501](#)
- Lee, J. & Lee, W. (2008) The relationship of e-learner's self-regulatory efficacy and perception of e-learning environmental quality. *Computers in human Behavior*, **24**(1): pp. 32-47.
- Liaw, S. S. (2008) Investigating students' perceived satisfaction, behavioral intention, and effectiveness of e-learning: A case study of the Blackboard system. *Comput. Educ.* **51**, pp. 864–873
- Liaw, S.S & Huang, H.M. (2007). *Developing a Collaborative e-learning system based on user's Perceptions*. Lecture Notes in Computer Science (4402): pp. 751-759
- Liu, Y., & Wang, H. (2009). *A comparative study on e-learning technologies and products: from the East to the West*. *Systems Research & Behavioral Science*, **26**(2): pp.191–209.
- MS Abdullah I, Mehmet Toyacan, (2018) Analysis of the Factors for the Successful E-Learning Services Adoption from Education Providers' and Students' Perspectives: A case study of Private Universities in Northern Iraq, *EURASIA J. Math., Sci Tech. Ed*; **14**(3): pp.1097–1109.
- N Hamzah et al., (2017) Web-Based Learning Environment Based on Students' Needs. *IOP Conf. Ser.: Mater. Sci. Eng.* 226 012196
- Najmul Islam, A.K.M. (2011) "Understanding Continued Usage Intention in e-Learning Context". *BLED Proceedings*. **28**. <http://aisel.aisnet.org/bled2011/28>. pp. 546-557.
- Parasuraman, A., Zeithaml V. A., Berry L. L., (1988) *A conceptual model of services quality and its implication for future research*, *Journal of Marketing*, **49**(4): pp. 41-50.
- Ramadiani (2010) Structural Equation Model Untuk Analisis Multivariate Menggunakan LISREL. *Jurnal Informatika Mulawarman*, **5**(1): pp.14-18 DOI: <http://dx.doi.org/10.30872/jim.v5i1.48>
- Ramadiani, et al. (2013) E-Learning User Acceptance based on Analysis of User's Style, Usability, and User Benefits, *Jurnal Sistem Informasi (JSI)*, **9**(1): pp. 6-12
- Ramadiani, et al, (2015) *Integrated Acceptance Model for E-Learning*. International Conference on Engineering and Technology for Sustainable Development (ICET4SD) 11-12 Nov, Indonesia. *IOP Conference Series: Materials Science and Engineering*, **105**(1): pp. 1-9.

- Ramadiani, R. Atan, M. H. Selamat, R. Abdullah, N. C. Pa and Azainil, (2016) *User difficulties in e-learning system*, 2nd International Conference on Science in Information Technology (ICSITech), Balikpapan, pp. 158-162.
- Ramadiani, et al (2017). *User Satisfaction Model for e-Learning Using Smartphone. Procedia Computer Science*. **116**, pp. 373-380. <https://doi.org/10.1016/j.procs.2017.10.070>
- Sanam, A. (2009) *Learners intention to continue use of E-learning Technology case of Iranian universities*, Master Thesis, Lulea University of Technology, Iran.
- Sharp, J., & Huett, J. (2006) Importance of learner-learner interaction in distance education. *Information Systems. Education Journal*. **4**(46).
- Shu-Sheng Liaw, (2008) Investigating students' perceived satisfaction, behavioral intention, and effectiveness of e-learning: A case study of the Blackboard system. *Computers & Education* **51**(2): pp. 864-873
- Sun, P. C., & Cheng, H. K. (2007). The design of instructional multimedia in e-learning: A media richness theory-based approach. *Computers and Education*, **49**, pp. 662–676.
- Thananchana, A., Chandarasupsang, T. and Chakpitak, N. (2017) 'An alternative IT investment framework based on university learning model in asset management', *Int. J. Innovation and Learning*, **21**(1): pp.69–97.
- Thomas John Paul; Jayanth Jacob, (2017) [Information system continuance usage: moderating role of habit](#). *Int. J. of Business Information Systems*, **26**(2): pp.166–184
- Triyanto, RD Handayani, (2018) [Comparing learning motivation and learning style between natural science and social science students in higher education](#). *Int. J. of Innovation and Learning* **23**(3): pp. 304 - 317
- Udo, G. J., Bagchi, K. K., & Kirs, P. J. (2011). Using SERVQUAL to assess the quality of e-learning experience. *Computers in Human Behavior*, **27**, pp. 1272—1283.
- Venkatesh, V., Morris, M.G., Davis, G.B., and Davis, F.D (2003). *User Acceptance of Information Technology: Toward a Unified View. MIS Quarterly* **27**(3): pp. 425-478.
- Wen-Lung Shiau & Margaret Meiling Luo (2012) Continuance intention of blog users: the impact of perceived enjoyment, habit, user involvement and blogging time, *Behaviour & Information Technology*, **32**(6): pp.570-583.
- Wing S. Chow and Si Shi (2014) Investigating Students' Satisfaction and Continuance Intention Toward E-Learning: An Extension of The Expectation–Confirmation Model. *Procedia – Social and Behavioral Sciences* **141**: 1145 – 1149
- Yang, M., Shao, Z., Liu, Q. et al. (2017) Understanding the quality factors that influence the continuance intention of students toward participation in MOOCs, *Education Tech Research Dev* **65**: 1195.

Lampiran 4. Paper International Conference Elsevier

2nd International Conference on Computer Science and Computational Intelligence 2017, ICCSCI 2017, 13-14 October 2017, Bali, Indonesia

User Satisfaction Model for e-Learning Using Smartphone

Ramadiani^a, Azainil^b, Fahrul Agus^a, Zainal Arifin^a

^aFaculty of Computer Science and Information Technology, Mulawarman University, Indonesia

^bFaculty of Teacher Training and Education, Mulawarman University, Indonesia

^cInformation System, Computer Science and Information Technology Faculty, Putra Malaysia University, Malaysia

Abstract

Level of smartphone usage can be used as an indicator of technological progress of a region. This study aims to explore and make user satisfaction model for e-learning using smartphone applications in Mulawarman University. Total of respondent are 178 students which are consist of 83 females and 95 males. The research method used Path Diagram, Structural Equation Model, Lisrel and Manova Analysis. The purpose of the research is to make user satisfaction model for e-learning using smartphone, and to produce and to recommend e-learning content for research and e-learning. The components that would be evaluated in this research are focused on the following matters: User satisfaction for e-Learning using Smartphone; Service quality, Information quality, User participation, and Benefit. Where service quality consists of demeanor, responsiveness, competence and tangible. Information quality consist of completeness, relevancy, accuracy, and currency. User participation consist of training provider, user understanding and participation. Benefit consist of easier to the job and increase productivity. This model can be considered in developing an e-learning application in the future.

© 2017 The Authors. Published by Elsevier B.V.

Peer-review under responsibility of the scientific committee of the 2nd International Conference on Computer Science and Computational Intelligence 2017.

Keywords: e-Learning; User Satisfaction; SEM; Smartphone;

1. Introduction

E-Learning process on the internet can be done using a variety of platform or applications. It is expected to facilitate to transfer and to share the knowledge to the user. It does not mean to replace the existing class, it serves to enrich and be an alternative at the right time and needed. Many applications tools in educational content which the learner can access depending on its needs and learning style. A new learning style can reproduce the main role of the student to properly reform the traditional teaching and education, to train a large number of high-quality personnel [1].

But e-learning has limited in body language and social excuse also face to face learning session. We should be creative in multimedia learning. Planning and facilitating frequent and the relevant interaction is probably the single important that we can do to interactive virtual

learning. We must be careful to designing e-learning interface interaction; it is not adding interaction in interactive activities seeks. This interaction must be had intends; engaged, paying attention, retaining the material that we are covering. It must be support leaning objectives and the same time supporting user attention.

2. Literature Review

2.1. E-Learning

People are involved in e-learning developers helping to make the course look good, make sure the student learn better and make the learning meaningful. However, we need to make sure that we were getting the performance of each individual who involved. We need to capture how the courses design, how the instructors have deliver the course to the learner, as we know many of e-learning courses design by someone else but taught by someone different, so comprehensive performance records of each individual should be noted. We can do comprehensive team evaluation how this course been taught, where is the students problems, if the problem is a content was miss represented, maybe we must to do updating. How to help learners feel engaged and encourage in active participation.

The interaction between user and system could be divided on several steps: the user should set a goal, determine what actions he should make to achieve this goal, make these actions, interpret a new system state and evaluate the result. It follows from this that duration of the user's work with system consists of the following components: duration of source information perception, duration of user's mental work, duration of user's physical work, during interaction with the computer the user enters data by means of different devices for information input and duration of system response. The criterion of user's mistakes such as mistakes caused insufficient data domain knowledge, these mistakes could be solved by user education. Misprints, it happens when the user for some reason does not attend to action that he makes in the present moment, paying no attention to system indication and motor mistakes [2].

The successful features of the program and its interface included; the interface actions supported the tasks the learner needed to perform, the screen layout drew the learner's eye to the right things, less-crucial actions were hidden rather than cluttering the screen, a tutoring component was always available to the learner, the entire program emphasized in-context, general information, the feedback and guidance were designed and written to aid generalization, the program design cut off learner paths so the learner stayed goal-focused; yet taught error recovery where it would be needed in real life and the learners did not need to click the mouse more than twice to complete an action [3].

2.2. Smartphone for e-Learning

Smartphone is a communication tool whose ability is getting closer to the use of notebook. Although now the most popular activities performed on smartphones is accessing social media, but one day the smartphone can replace the function of the notebook in processing files and other important data. The most frequent activities of smartphone users are social media, group discussion, youtube, browsing, games, download, e-commerce, and entertainment news.

However, e-learning and other learning applications are the shortest activities of all activities, whether through smartphones or notebooks. Social learning concepts, micro-content, and informal learning are a result of the mobile learning surge. This research is the preliminary research of three stages of research. For the future research will be developed smartphone content that can be used for e-learning.

According to Pew Research Center [4] as many as 54 percent of adults in 21 developing countries are already using the internet. There are 21 percent of adults who use

smartphones and will rise to 37 percent in 2014. In developed countries, 87 percent of adults are internet users and 68 percent already have smartphones. Smartphones are used for much more than calling, texting, or basic internet browsing. Users are turning to these mobile devices as they navigate a wide range of life events; 62% of smartphone owners have used their phone. Only 30% to take a class or get educational content and 18% to submit a job application.

The challenge facing educators today is how to utilize smartphone technology as a medium of education and knowledge sharing, whether formal or non-formal. The goal is to facilitate and expand the reach of education for those who cannot afford, not paying for professional teachers, unable to attend favorite places, disaster-stricken areas and remote provincial towns. As technology and applications continue to improve, more video content being utilized in eLearning environments [5]. The use of mobile devices for learning will continue to rise as the number of people with mobile devices increases, along with the increased emphasis on optimizing websites and applications to accommodate mobile users.

2.3. User Acceptance and Satisfaction Model

Acceptance has been conceptualized as an outcome variable in a psychological process that users go through in making decisions about technology. Some researchers have been done to understand the human decision making in the context of accepting technology. According to the research, an individual's behavior is determined by one's intention to perform the behavior, and this intention is influenced jointly by the individual's attitude and subjective norm.

User acceptance is very important for all application developers to know their product which has been launched in public are accepted or rejected. Developer needs several evaluation models to investigate and to understand the factors affecting the acceptance of computer technology in organizations, as also designer and programmer. Besides following the application standard, the developers, programmer and application designer need knowledge to recognize their user and information seeking habitual. It is one of important reason to develop user acceptance model and evaluation standard. Among the models include Technology Acceptance Model (TAM), Theory of Reasoned Action (TRA) and Theory of Planned Behavior (TPB) [6].

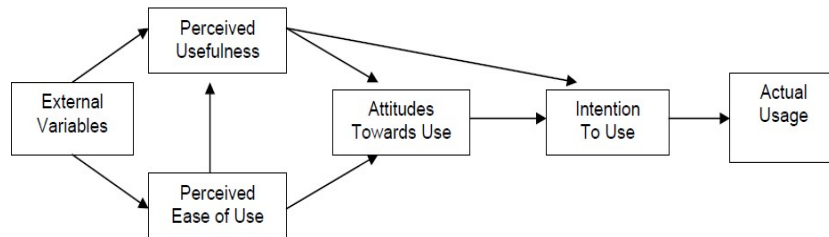

Fig 1. Technology Acceptance Model

The intention to accept or reject a particular technology is based on a series of tradeoffs between the perceived benefits of the system to the user and the complexity of learning or using the system. According to the TRA model, two major factors determine behavioral intentions namely: the person's attitude towards the behavior, and subjective norms. Attitude towards the behavior refers to the person's judgment that performing the behavior is good or bad. The TAM advances the TRA by postulating that perceived usefulness (PU) and perceived ease of use (PEU) are key determinants that predictably lead to the actual usage of a particular technology or system. The research found that there is a

relationship between users' beliefs about a technology's usefulness and the attitude and the intention to use the technology [6].

The success of an information system according to this theory comes from the measurement of the quality of the system implemented by the information center in collecting and processing information, the measurement of the suitability between the quality of information content available to the needs of users, as well as measurement of the quality of its services. The success of these three predecessor factors may affect the user to frequently or frequently use the facilities provided by the information services. Increased use of facilities provided by information services is an indicator for the satisfaction of information perceived by users. In the end, it all impacts on user behavior and also impact on the success of information systems. The point is that the service is useful for users in making decisions and facilitate users in carrying out their work and improve productivity and work efficiency [6][7][8].

The model developed by DeLone and McLean is one model of measuring the success of information systems seen from the point of non-economic output. This means that the success of the information system is measured by indirect measure or surrogate measure, in the form of user's perception, attitude and behavior. This is very appropriate with the way of measuring the success of information service systems in libraries that are not fully profit-oriented in the form of cost benefit analysis (Fig.3).

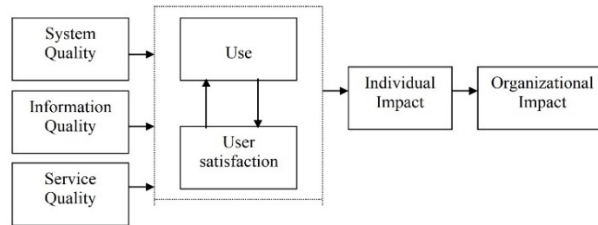

Fig. 2 Information System Success Model

Ozka proposed a conceptual e-learning assessment model, suggesting a multi-dimensional approach for LMS evaluation via six dimensions: (1) system quality, (2) service quality, (3) content quality, (4) learner perspective, (5) instructor attitudes, and (6) supportive issues. User satisfaction is a product of information satisfaction, system satisfaction and support satisfaction. Information satisfaction is affected by the quality of information which is attributed by availability, accuracy, timeliness, precision, reliability, currency, completeness. The user's expectation on quality of information is demonstrated by his or her preferred information demand characteristic [9].

The components that would be evaluated in this research are focused on the following matters: User acceptance and satisfaction for e-Learning using Smartphone; Service quality, Information quality, User participation, and Benefit. Where service quality consists of demeanor, responsiveness, competence and tangible. Information quality consist of completeness, relevancy, accuracy, and currency. User participation consist of training provider, user understanding and participation. Benefit consist of easier to the job and increase productivity.

3. Research Method

3.1. Research Questions

User Information Satisfaction: Satisfaction is the summing up of a person's feelings or attitudes toward some of the circumstances affecting him while user satisfaction is a subjective judgment of the user against the information they find in comparison to the

information they expect that exceeds their internal standard judgment [10]. Internet users and smartphones worldwide are on the rise. The number of internet and smartphone users in developing countries close to 100 percent [12][13][14]. Based on the background and focus of the research above, then the biggest challenge in this study is how to evaluate the smartphones usage among students in University. How to make user acceptance model and user satisfaction factors for e-learning using smartphone? and how to produce and to recommend e-learning content that suits the needs of students?

3.2. Structural Equation Model

Structural Equation Modeling (SEM) is a powerful collection of multivariate analysis techniques, which specifies the relationships between variables through the use of two main sets of equations: Measurement equations and structural equations. Measurement equations test the accuracy of proposed measurements by assessing relationships between latent variables and their respective indicators. The structural equations drive the assessment of the hypothesized relationships between the latent variables, which allow testing the statistical hypotheses for the study [1][15].

The general structural equation model can be expressed as follows: for example: $\eta' = (\eta_1, \eta_2, \dots, \eta_m)$ and $\xi' = (\xi_1, \xi_2, \dots, \xi_n)$ respectively are independent latent variable vectors and dependent latent variables. The structural linear relationship is as follows:

$$\eta = B \eta + \Gamma \xi + \zeta \quad (1)$$

Which B is a matrix of size $m \times m$ and Γ is a matrix of size $m \times n$, both of which are coefficient matrices. Whereas $\zeta' = (\zeta_1, \zeta_2, \dots, \zeta_m)$ the random vector remains. Without prejudice to the general nature of the model, it can be assumed that $E(\eta) = E(\xi) = 0$ and $E(\zeta) = 0$. It is further assumed that ζ it is not correlated with ξ and $(I - B)$ is not singular. Vectors η and ξ cannot be directly observed, but instead are vectors $y' = (y_1, y_2, \dots, y_p)$ and $x' = (x_1, x_2, \dots, x_q)$ are directly observed, so that:

$$y = \Lambda_y \eta + \varepsilon \quad (2)$$

Where ε and δ is the measurement error vector for y and x . Taken y and x as corrected observation vectors against the mean. Matrices Λ_y of $p \times m$ and Λ_x sized $q \times n$ are, respectively, regression matrices y at η and x on ξ . This corresponds to y and x as the observed variable η and ξ as a latent variable. The measurement error vectors ε and δ are considered uncorrelated to each other, they are not correlated with the latent variables.

4. Result and Discussion

The method used here is taking samples by spreading questionnaires to students of Mulawarman University. Produced sample data from 178 respondents with ages between 18 to 24 years whose average age range of 20 years. Fig. 3 we can see that still a few smartphone users access e-learning application. E-Learning applications used with smartphones are also limited compared to notebooks. Gnomia and Edmodo 34%, Group 7%, Moodle and journal 6%, Academia and article 5 %, Library 4%. Moodle is a well-known open-source Course Management System, with a large user community. The functionality is thus continuously being enhanced and the code is well maintained. Gnomio is a few moodle fans enjoying an unexpected success while offering free tools for the e-learning community. Edmodo takes learning beyond the classroom by providing a free, safe place for teachers

and students to connect and collaborate—anytime, anywhere. Unlike an LMS, Edmodo lets us integrate and manage e-learning

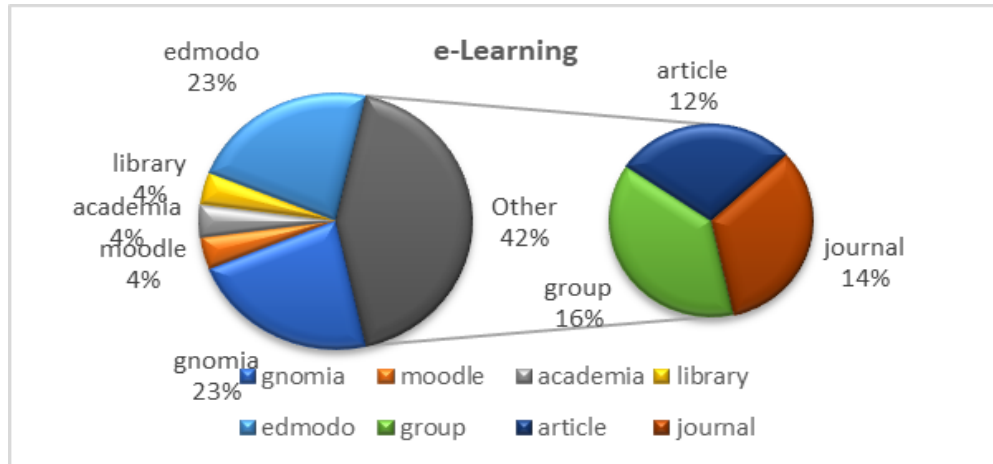

Fig 4. E-Learning Using Student Smartphone

This study has successfully developed an user acceptance model for e-Learning via smartphone, which is based on Sevqual, Infoqual, User participation and Benefit. Infoqual is consisted of four attributes; completeness, relevancy, accuracy, and currency. User participation consisted of three attributes; training provider, user understanding and participation. Benefit were consisted of easier to the job and increase productivity. The data collected is ordinal data and the estimation method used was the method of maximum likelihood. The data was processed by using Structural Equation Model (SEM) and Linear Structural Relation (LISREL) v8.80.

Table 1. Parameter and Variant Estimates user satisfaction model

	Satisfaction (Estimasi) (γ)	Err-Var (ζ)	Satisfaction (standar solution) (γ)	Err-Var (ζ)	R^2
Serqual	1.00	0.01	0.99	0.01	0.99
Infoqual	0.86 (0.036) 23.70	0.15 (0.028) 5.50	0.90	0.19	0.81
User	0.89 (0.031) 28.58	0.24 (0.026) 9.34	0.86	0.27	0.73
Benefit	1.05 (0.028) 37.12	0.01	0.99	0.01	0.99

The research statistics used Structural Equation Model using LISREL v8.80 and MANOVA while analysis of the data was performed using SPSS v21. SEM determines the suitability of model. Meanwhile, its validity and reliability was measured by composite construct reliability and variance extracted measure. MANOVA analysis was used to compare the difference level of user acceptance.

Based on the statistical value in the model of e-learning user interface has a highly significant correlation values and strong construction between variables, which is evidenced by the size of the construct reliability values above 0.70 and the value of its variance extracted 0.50 (Table 2). According to the research questioner analysis and Goodness of Fit measurement, it is shown that the high reliability in this study indicates that an indicator variable is consistently high in measuring latent constructs. Test reliability used two types of measurements composite construct reliability and variance extracted measure.

Table 2. Calculation of Variance Extracted and Construct Reliability of user satisfaction Model

	Construct Reliability	Variance Extracted
Service quality	0.95	0.87
Information quality	0.95	0.83
User	0.98	0.93
Benefit	0.99	0.98
User Satisfaction	0.97	0.89

Calculation of Variance Extracted and Construct Reliability in user satisfaction model is done by using the formula and data contained in the research as an example:

- Construct Reliability Service quality

$$(\sum \text{Standardized Loading})^2 = (0.94 + 0.99 + 0.86)^2 = 2.79^2 = 7.78$$

$$\sum \varepsilon_j = 0.13 + 0.01 + 0.26 = 0.4$$

$$\text{Construct Reliability Service quality} = \frac{7.78}{7.78 + 0.4} = 0.95$$

- Variance Extracted Service quality

$$\sum \text{Standardized Loading}^2 = 0.94^2 + 0.99^2 + 0.86^2 = 2.6$$

$$\sum \varepsilon_j = 0.13 + 0.01 + 0.26 = 0.4$$

$$\text{Variance Extracted Service quality} = \frac{2.6}{2.6 + 0.4} = 0.87$$

According to the t-value, loading factors, and the relative suitability value of each Structural Equation Model, we can conclude that the user satisfaction model for E-learning using smartphone in this study can be accepted. The measurement modal and structural model has very significant correlation between variables. This study has become one alternative model to predict the user satisfaction model for E-learning using smartphone. Hopefully, this model can be considered in developing an e-learning application in the future.

References

- [1] Ramadiani, R. Atan, A. Rusli, M.H. Selamat, and Noeraini. (2015) "Integrated Model Acceptance for E-Learning", International Conference on Engineering and Technology for Sustainable Development (ICET4SD) 11-12 Nov, Yogyakarta, Indonesia IOP Conference Series: Materials Science and Engineering, Volume 105, Number 1
- [2] Belaya O. A. (2004) "The metrics for quantitative evaluation of user interface usability construction methodology". *SPECOM: 9th Conference Speech and Computer* St. Petersburg, Russia September 20-22.
- [3] Guralnick, D. (2006). "How to Design Effective, Motivating User Interfaces." *American Society for Training & Development TechKnowledge Conference*, Denver, CO.
- [4] Aaron Smith. (2015) "U.S. Smartphone Use in". Pew Research Center.

- [5] Ghazal Bargshady et al. (2015) "The Effective Factors on User Acceptance in Mobile Business Intelligence". *Jurnal Teknologi (Sciences & Engineering)* **72**:4 (2015) 49-54
- [6] Coleman V., Xiao, Y. Bair, L. and Chollet, B. (1997) "Toward a TQM Paradigm: Using SERVQUAL to Measure Library Service Quality". *College and Research Libraries* (May) 237-251.
- [7] Lee, Mathew K.O. dan Pow, Jacky. (1996) "Information Accessing Behaviour and Expectation of Quality: Two Factor Affecting the Satisfaction of Users of Clinical Hospital Information Systems}. *Journal of Information Science* **22**(3): 171-179
- [8] Gelderman, Marteen. (1998) "The Relationship Between User Satisfaction, Usage of Information Systems and Performance". *Information and Management* **34**:11-18.
- [9] Lee, Mathew K.O. dan Pow, Jacky. (1996) "Information Accessing Behaviour and Expectation of Quality: Two Factor Affecting the Satisfaction of Users of Clinical Hospital Information Systems". *Journal of Information Science* **22**(3): 171-179
- [10] Iivari J. and Ervasti, I. (1994) "User Information Satisfaction: IS Implement, ability and Effectiveness". *Information and Management*, **27**: 205-220.
- [11] Bruce, Harry. (1997) "User Satisfaction with Information Seeking on the Internet". *Journal of American Society for Information Science* **49**(6): 541-556
- [12] Bryan Jones. (2016) "Top 9 E-Learning Trend in 2017 as Picked from 49 Expert". *eLearning Art*,
- [13] Harris, Donald E. (1994) "Reassessing User Needs". *Journal of American Society for Information Science* **45**(5): 331-334.
- [14] Lina Wu, Mincheol Kang and Sung-Byung Yang. (2015) "What Makes Users Buy Paid Smartphone Applications? Examining App, Personal, and Social Influences". *Journal Internet and Banking (JIBC)* August, Vol. **20**, No.1
- [15] Ramadiani, R. Atan, M.H. Selamat, C. P. Noraini, A. Rusli. (2013) "E-Learning User Acceptance based on Analysis of User's Style, Usability, and User Benefits", *JSI* Vol **9**, No 1: page 6-12.

Lampiran 5. Laporan Penelitian

SmartPhone E-Learning Penetration On Computer Science Department Students

Ramadiani,

Faculty of Computer Science and Information
Technology Mulawarman University
Samarinda, Indonesia
mmi_ugm04@yahoo.com

Azainil

Faculty of Teacher Training and Education
Mulawarman University
Samarinda, Indonesia
nil_unmul@yahoo.com

Abstract— Level of smartphone usage can be used as an indicator of technological progress of a region. This study aims to explore the background of the selection of smartphones and applications used, as well as the level of internet consumption in students of Computer Science Department, Faculty of Computer Science and Information Technology, and Education of Computer Science students at Faculty of Teacher Training and Education in Mulawarman University as respondents. Total of respondent are 78 student which are consist of 33 females and 45 males. The research method used survey and descriptive analysis about User smartphone behavior and penetration. The purpose of the research is to development and to selection of Internet content according to the needs of students in computer science and in computer science education and to recommend supporting the lecture content, research and e-learning.

Keywords---smartphone penetration; smartphone app.

I. Introduction

In today's digital age, the distance can be closer, the information path is wide open and easily spread so there is no more privacy in a country or household. Everyone can share information using cameras, pictures, sounds, text, and videos without bothering, and all goes very fast. Events in an area can be known to people from other areas in a

matter of seconds. So do not be surprised if the smartphone into something that must be owned by everyone.

Smartphone user behavior also evolved into its own culture. Sharing selfie or group photos, snapping food before eating, opening and sending messages while walking or driving, creating status and sharing news in social media. Smartphone user behavior also affects a person's economic behavior, buyers will check and compare prices of goods from one place and another, order goods, buy tickets and pay online, online banking, traveling and health counseling [1].

According to Pew Research Center (2015) as many as 54 percent of adults in 21 developing countries are already using the internet. This figure is up from 43 percent in 2013. In addition to internet use, in developing countries also seen an increase in the use of smartphones. In 2013, there are 21 percent of adults who use smartphones. This figure rose to 37 percent in 2014. While in developed countries, as many as 87 percent of adults are internet users and 68

percent already have smartphones. In Indonesia, the rate of new smartphone users reached 21 percent with the internet user rate reached 30 percent [2].

Smartphones are used for much more than calling, texting, or basic internet browsing. Users are turning to these mobile devices as they navigate a wide range of life events: 62% of smartphone owners have used their phone in the past year to look up information about a health condition. 57% have used their phone to do online banking. 44% have used their phone to look up real estate listings or other information about a place to live. 43% to look up information about a job. 40% to look up government services or information. 30% to take a class or get educational content. 18% to submit a job application [2].

Research TNS Australia states about 50 percent of smartphone owners in Indonesia to make the device as the main telecommunications equipment, including to access the internet. The penetration rate is the highest in Asia. However, from eight countries that became research sites in June 2015, penetration of smartphones in Indonesia by percentage is in the second lowest position. Only India whose mobile device penetration is lower than Indonesia [3].

Many people use mobile phones as the primary means of communication. The people who have a relatively high education or have a relatively high income have a higher tendency to use the internet or own a smartphone. Most internet or smartphone

users use it to access social media. In countries where the price of internet access is relatively low, the number of social media users is more. For example, the Middle East and Latin America have social media users of 86 percent and 82 percent. While social media users in the US and Europe only reached 71 percent and 65 percent [2].

This is a list of countries by smartphone penetration in 2017. These numbers come from the annual *Global Mobile Market Report* and are based on a model which takes into account a country's economic progression, demography, online population, and inequality. These estimates are benchmarked with the clients in the industry along with third party reports and institutions. The Report features an extensive smartphone user forecast from 2015 to 2020 per country and region, along with the top smartphone and tablet brands, and app revenue forecasts [5].

RANK	IMAGE	COUNTRY	TOTAL POPULATION	SMARTPHONE PENETRATION	SMARTPHONE USERS
1		China	1,388,233,000	53.7%	717,310,000
2		India	1,342,513,000	22.4%	300,124,000
3		United States	326,474,000	69.3%	226,289,000
4		Brazil	211,243,000	37.7%	79,578,000
5		Russian Federation	143,375,000	54.7%	78,364,000
6		Japan	126,045,000	50.1%	63,089,000
7		Germany	80,636,000	68.8%	55,492,000
8		Indonesia	263,510,000	20.7%	54,494,000
9		Mexico	130,223,000	40.7%	52,993,000
10		United Kingdom	65,571,000	68.6%	44,953,000
11		France	64,939,000	65.3%	42,399,000
12		Turkey	80,418,000	49.8%	40,010,000

Fig. 1. The top 50 countries in terms of smartphone users in 2017.

The biggest challenge in this study is how to evaluate the use of smartphones at Computer Science Department students FKTI UNMUL with Computer Science Education students at Mulawarman University who can produce and recommend new innovations for applications and content that suits the needs of students of a region. Based on existing research, in the Asian market are only three applications that sell, namely instant messaging, whatsapp or line, social media, and search engines.

The Association of Internet Service Providers Indonesia (APJII) revealed the number of internet users in Indonesia reached 88 million people by the end of 2014. Based on population, the largest number of Internet users is in West Java province as many as 16.4 million, followed by East Java 12.1 million users and Central Java 10.7 million users. Fig.2 is the Number of Internet Users by region in Indonesia [4].

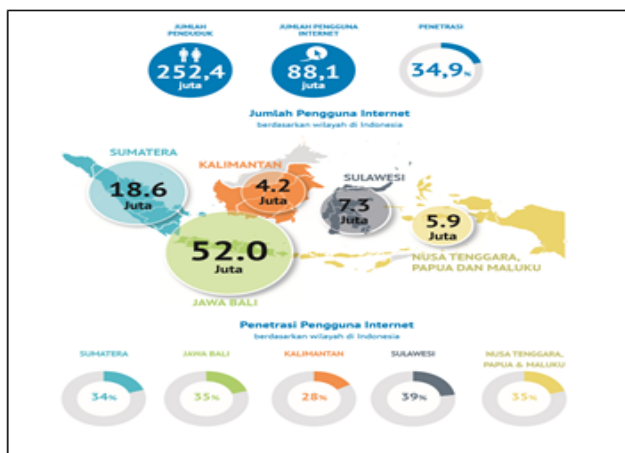

Fig. 2. Internet User Penetration in Indonesia

II. Research Methods

Research Focus

Internet users and smartphones worldwide are on the rise. The number of internet and smartphone users in developing countries is slowly but surely close to 100 percent [6]. Based on the background and focus of the research above, then the problems of this research are formulated as follows;

- 1) How to mapping the students consumption pattern according to smartphone usage?
- 2) What kind of content do they access to support their academic and learning activities?

The components that will be evaluated in this research are focused on the following matters: User Smartphone Profile (user style, spent time, education background, age, sex, income) [7],[8]. The Smartphone usability such as knowability, operability, efficiency, robustness, safety, subjective satisfaction and smartphone user benefit is media element, communicativeness, user expectation [1],[11].

Structural Equation Model

Structural Equation model (SEM) is an abbreviation of the structural equation model which is the second generation of multivariate analysis technique that allows researchers to examine the relationship between complex variables both recursive and nonrecursive to obtain a comprehensive picture of a model. Unlike regular multivariate analysis (multiple regression and factor analysis). SEM can perform testing together, namely: structural model that measures the relationship between

independent and dependent construct, and measurement model that measures the relation (loading value) between the indicator variable and the construct (latent variable) [1], [11]. With the incorporation of structural model testing and the measurement allows researchers to;

- 1) Testing measurement errors as an integral part of the structural equation model.
- 2) Conducting factor analysis simultaneously with hypothesis testing.

$$\eta_{(m \times 1)} = B_{(m \times m)} * \eta$$

Fig. 3. General Structural Equation Model

User Smartphone Behaviour

The research aimed to identification students penetration of smartphone. This is the first step of three phases experiment was conducted in this research to get more information about user requirements to select smartphone. In this case, the researcher should build some questioner for evaluation user acceptance [6],[8],[9]. Based on the previous evaluations and theories about the user technology acceptance, we developed hypotheses and some questioners to collect, to prove and to support our research objectives.

Data Collection Technique

Respondents used Smartphone for over three months. We shared the questioners to identify their acceptance using the Smartphone. The questioners contain three types question; open answer, Lickert scales

and demographic. Besides that, the questioner also consisted of user behavior; smartphone usability and smartphone benefit questions [1], [11].

1) Research Respondents

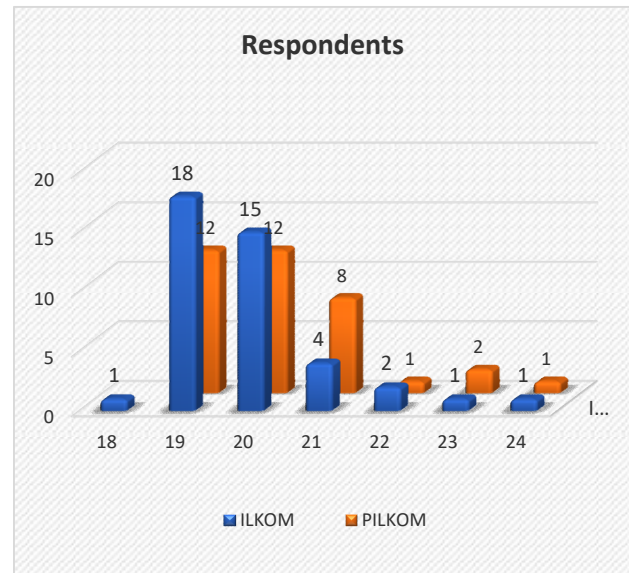

Fig. 4. Researchwnt- Participants

This research involved seventy-eight students as respondents (forty-five males and thirty-three females) from the students of Computer Science Department and students from Communication and Information Technology Department of Teacher Training and Education Faculty in Mulawarman University (Fig. 4).

2)Evaluation Setup

All the evaluation process was conducted during the class meeting in the in Mulawarman University, East Kalimantan. The observation was done in two months before the data research was collected by using questioners to identify the student

behavior in searching materi by using smartphone and laptop penetration.

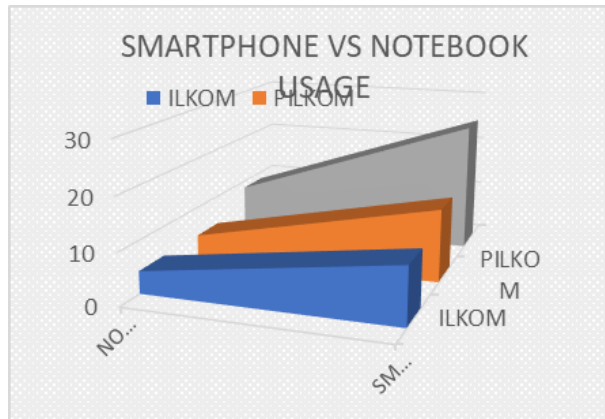

Fig. 5. the use of smartphones is higher than the use of notebooks

The use of smartphones is higher than the use of notebooks in accessing the internet. It is eight point five for notebook and fourteen point one for smartphone (Fig. 5). In Ilkom students are four point thirty three for the notebook and eleven for smartphone. In the other hand, Pilkom students are four point nineteen for the notebook and fourteen point one for smartphone.

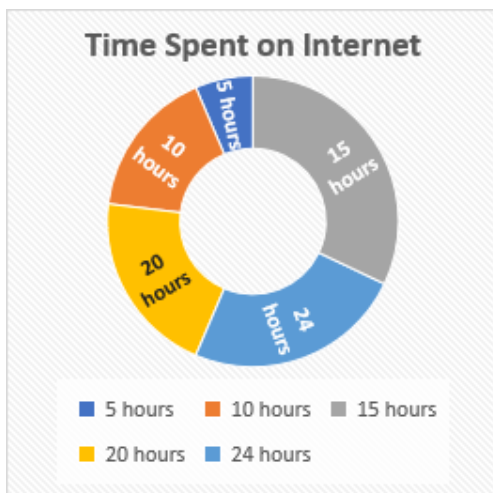

Fig. 6. The studenrs spent time for internet accesss

Fig. 6 almost all students spend a lot of time accessing the internet. They get an average of about 15.6 a day to spent on Internet usage. Five students use internet less than five hours, thirteen students use it less than ten hours, twenty-five students use fifteen hours, sixteen students use less than twenty hours and the last, nineteen students almost use internet for twenty hours a day.

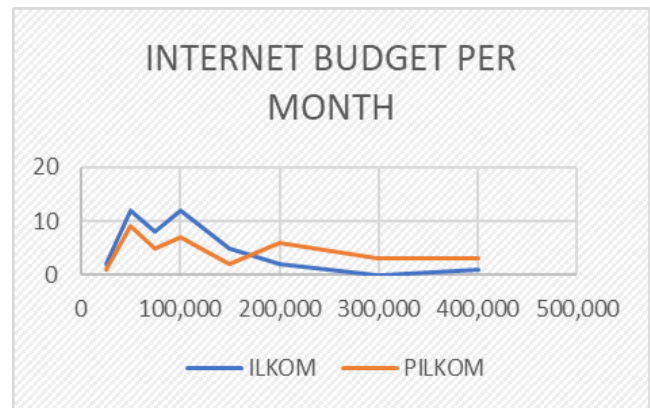

Fig. 7. Internet budget per month

Students spent variative budget for internet cost per month (Fig.7). Three students spent Rp.25.000,-/month, twenty-one students spent Rp.50.000,-/month, thirteen students spent Rp.75.000,-/month, nineteen students spent Rp.100.000,-/month, seven students spent Rp.150.000,-/month, eight students spent Rp.200.000,-/month, three students spent Rp.300.000,-/month, and four students spent more than Rp.400.000,-/month.

III. Research Results

4. User Smartphone E-Learning Penetration

This is the research result 23 about student internet penetration using smartphone. The

smartphones that students used in this research are variative to help them from any mindkind. The research was taken in February until April 2017. Most of them are teenagers are dominant using social media such as Line, Instagram, Whatsapp, and so forth as a means of communication and updates Information. Fig. 8 is the variative social media for the students network and communication.

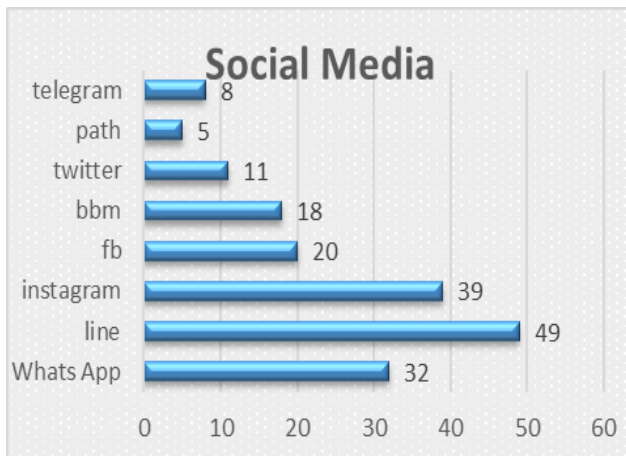

Fig. 8. The Ranks of Social Media that the students used

The method used here is taking samples by spreading questionnaires to students of Computer Science Faculty of Computer Science and Information Technology and Computer Science Education Student Faculty of Teacher Training and Education Mulawarman University. Produced sample data from 78 respondents with ages between 18 to 24 years whose average age range of 20 years. Fig. 9 shows the students use smartphones to surf the Internet. Browsing news, playing games, using social media for communication, youtube, entertainment, news, email, E-commerce, E-learning applications, and so forth.

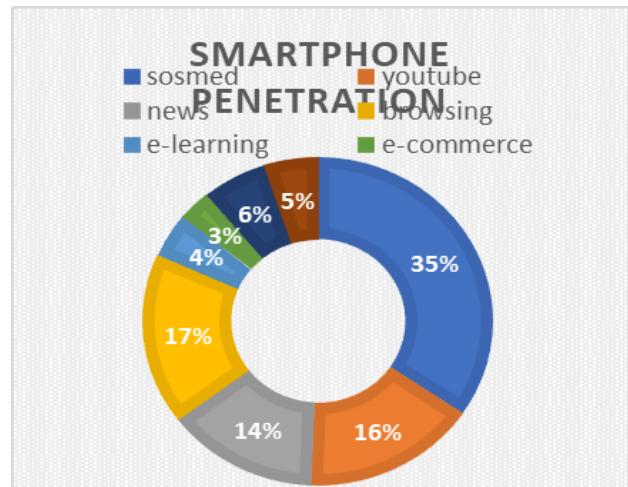

Fig. 9. Students Smartphone Penetration

The users of these providers not only entrust internet access to one provider, the reasons vary such as; Three is chosen because it is cheap but the network is not found in some places and this will hinder the activity of surfing on the internet when they travel out, so they chose the ISP with Telkomsel is the strongest and the most users college student. Therefore we classify the data back into several parts with pegged to the provider who has the most service users are Telkomsel as many as 49 users. After that, we classify data into loyal Telkomsel users and who do "infidelity" in quotes against ISP Telkomsel. And the data can be displayed as follows:

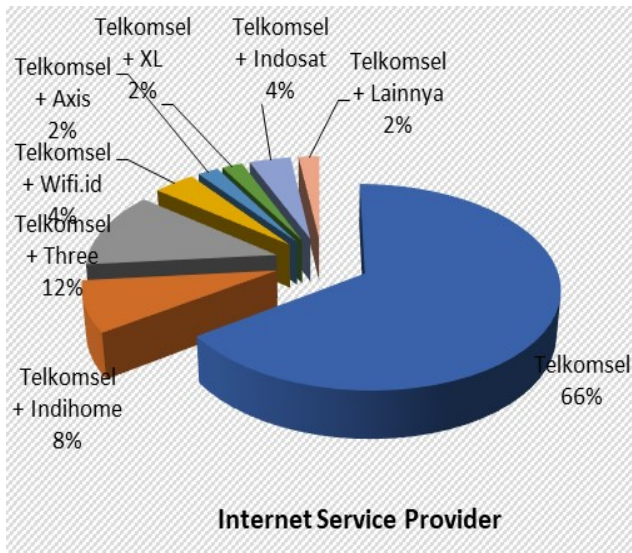

Fig. 10. Internet Service Provider

In Fig. 10 from 78 Respondents, there are 49 Students Telkomsel users. 32 Faithful users with Telkomsel and 17 Students using Telkomsel with other ISPs.

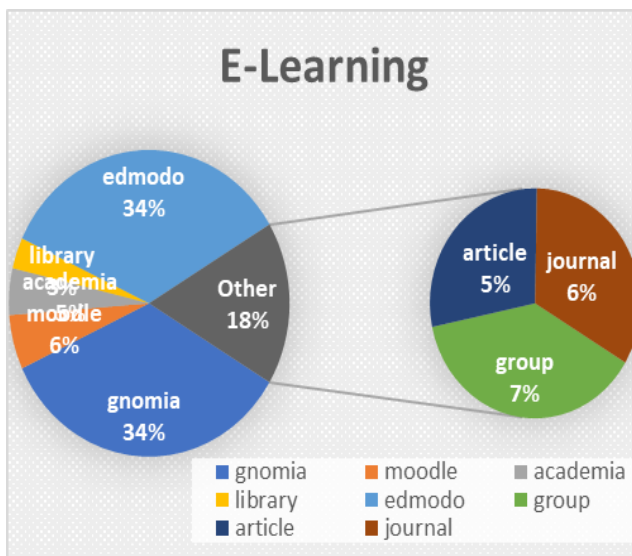

Fig. 11. E-Learning Using Student Smartphone

Fig. 11 shows that the Social media is the first rank were used by 35% students per day, the second level is browsing 17%, the

third level is youtube were visited by 16% students, news are the fourth level in 14%, then the fifth level is game 6%, the email 5%, e-learning 4% and e-commerce 3%.

TABLE I. AVERAGE USE OF SMARTPHONE AND NOTEBOOK

Type of Activities	The average use of Smartphone (hours)	The average of notebook (hours)
Social media	4.882290641	1.834880769
browsing	2.303769231	2.181461538
entertainment	2.505355844	1.974124359
gaming	0.910615385	0.905432051
e-learning	0.084415584	0.179487179
TOTAL	10.68644668	7.075385897

From Table 1 it can be seen that smartphone usage is longer time than notebook usage. This is because the smartphone is a small-sized technology that functions almost equivalent to the notebook and easy to carry anywhere. On smartphone usage, the most popular activity is accessing social media. This is because the smartphone is a most advanced communication tool that can make conversations very easily. While the use of notebooks, the most widely performed is browsing. Browsing using a laptop is more effective than using a smartphone, because all websites can be accessed through the notebook perfectly. However, e-learning activities are the shortest activities of all activities, either through smartphones or notebooks (Fig. 12).

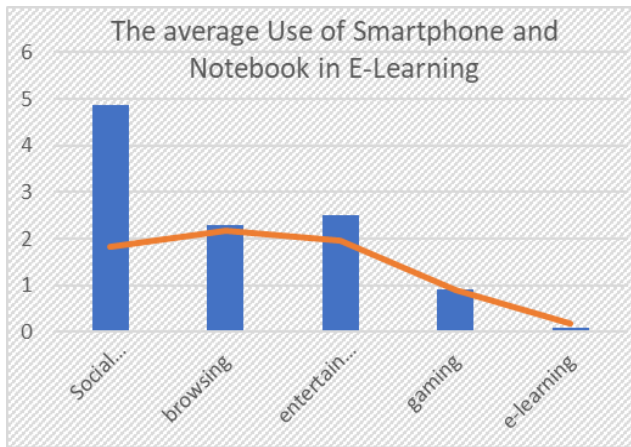

Fig. 12. The Average use of E-Learning in Smartphone and Notebook

IV. CONCLUSIONS

Smartphone is a communication tool whose ability is getting closer to the use of notebook. Although now the most popular activities performed on smartphones is accessing social media, but one day the smartphone can replace the function of the notebook in processing files and other important data. The most frequent activities of smartphone users are social media, group discussion, youtube, browsing, games, download, e-commerce, and entertainment news. However, e-learning and other learning applications are the shortest activities of all activities, whether through smartphones or notebooks. This research is the preliminary research of three stages of research. Future research will test usability and user benefit to develop smartphone content that can be used for e-learning templates and other college tasks.

V. References

- [1] Ramadiani, R. Atan, A. Rusli, M.H. Selamat, and Noeraini, "Integrated Model Acceptance for E-

Learning", International Conference on Engineering and Technology for Sustainable Development (ICET4SD) 11-12 Nov 2015, Yogyakarta, Indonesia [IOP Conference Series: Materials Science and Engineering, Volume 105, Number 1](#)

- [2] Aaron Smith, 2015. U.S. Smartphone Use in 2015. Pew Research Center.
- [3] Ghazal Bargshady et al. 2015. The Effective Factors on User Acceptance in Mobile Business Intelligence. *Jurnal Teknologi (Sciences & Engineering)* 72:4 (2015) 49-54 .
- [4] Inaya Rakhmani and Semuel A. Pangerapan. 2015. Profil Pengguna Internet di Indonesia 2014. APJII and PusKaKom UI.
- [5] Global Mobile Market Report, Markets. 2017. Top countries by smartphone users and penetration Trends & Projections, <https://newzoo.com/insights/rankings/top-50-countries-by-smartphone-penetration-and-users/>
- [6] Talwar YK, Karthikeyan S, Bindra N, Medhi B. 2016. Smartphone' - A User-friendly Device to Deliver Affordable Healthcare - A Practical Paradigm. *J Health Med Informat* 7: 232.
- [7] Shannon Greenwood, Andrew Perrin and Maeve Duggan. 2016. "Social Media Update 2016". Pew Research Center, November 11.
- [8] Lina Wu, Mincheol Kang and Sung-Byung Yang, 2015. What Makes Users Buy Paid Smartphone Applications? Examining App, Personal, and Social Influences. *Journal Internet and Banking (JIBC)* August 2015, Vol. 20, No.1
- [9] A Study on the Factors Affecting the Intention to Use Smartphone Banking: The Differences between the Jin Baek Kim and Sungmin Kan. 2012. *Transactions of Account Check and Account Transfer. International Journal of Multimedia and Ubiquitous Engineering* Vol. 7, No. 3, July, 2012
- [10] D. Guralnick, "How to Design Effective, Motivating User Interfaces", American Society for Training & Development TechKnowledge Conference, Denver, 2006.
- [11] Ramadiani, R. Atan, M.H. Selamat, C. P. Noraini, A. Rusli, "E-Learning User Acceptance based on Analysis of User's Style, Usability, and User Benefits", *Jurnal Sistem Informasi*, [Vol 9, No 1](#): page 6-12, 2013.

CURRICULUM VITAE AUTHOR



Ramadiani, S.Pd., M.Sc., M.Kom. Ph.D.

Born in Palembang on November 1, 1972.

Work as a Lecturer at the Faculty of Computer Science and Information Technology (FKTI) Mulawarman University.

E-mail: ramadiani@fkti.unmul.ac.id,

ilkom.ramadiani@gmail.com

mami_ugm04@yahoo.com.

Hp: 085250501973. Ramadiani received her PhD in Computer Science and Information System from University Putra Malaysia in 2015. She graduated from Indonesia University in 2000 and graduated from Gadjah Mada University in 2005 for her Computer Master. She currently works at the Department of Computer Science in Computer Science and Information System Faculty, Mulawarman University since December 2001 until now. Ramadiani does her research in Software Engineering, Information Systems (Business Informatics) and Human-computer Interaction. Her current project is 'e-Learning and Decision Support System'.

Scopus ID: 57160272300

SINTA ID: 5974501

Google Scholar ID: 9XnXoJgAAAAJ&hl

https://www.researchgate.net/profile/Ramadiani_Ramadiani

MODEL DAN BENTUK PENELITIAN E-LEARNING MENGUNAKAN **STRUCTURAL EQUATION MODEL**

Buku ini mengajarkan dan menjelaskan bagaimana membangun model penelitian e-learning maupun mobile learning sebelum direkomendasikan untuk pengembangan prototype dan konten e-learning.



Ramadiani, S.Pd., M.Si., M.Kom., Ph.D.

Born in Palembang on November 1, 1972. Work as a Lecturer at the Faculty of Computer Science and Information Technology (FKTI) Mulawarman University.

E-mail: ramadiani@fkti.unmul.ac.id, ilkom.ramadiani@gmail.com, mmi_ugm04@yahoo.com.

Hp: 085250501973.

Ramadiani received her PhD in Computer Science and Information System from University Putra Malaysia in 2015. She graduated from Indonesia University in 2000 and graduated from Gadjah Mada University in 2005 for her Computer Master. She currently works at the Department of Computer Science in Computer Science and Information System Faculty, Mulawarman University since December 2001 until now. Ramadiani does her research in Software Engineering, Information Systems (Business Informatics) and Human-computer Interaction. Her current project is 'e-Learning and Decision Support System'.

Scopus ID: 57160272300

SINTA ID: 5974501

Google Scholar ID: 9XnXoJgAAAAJ&hl

https://www.researchgate.net/profile/Ramadiani_Ramadiani



**Mulawarman
University PRESS**

Penerbit

Mulawarman University PRESS

Gedung LP2M Universitas Mulawarman

Jl. Krayan, Kampus Gunung Kelua

Samarinda-Kalimantan Timur – INDONESIA 75123

Telp/Fax (0541) 747432, Email : mup.unmul@gmail.com

ISBN 978-602-6834-64-5



9 786026 834645