

ISSN-0971-720X (Print) • ISSN-0973-1283 (Electronic)

Volume 21 Number 1 January-March 2021



# Medico-Legal Update

An International Journal

[www.medicolegalupdate.org](http://www.medicolegalupdate.org)

# Medico-Legal Update

Editor-in Chief

**Prof. (Dr) R K Sharma**

Former Head, Department of Forensic Medicine & Toxicology  
All-India Institute of Medical Sciences, New Delhi-110029  
E-mail: medicolegalupdate@gmail.com

## ASSOCIATE EDITOR

1. **S.K. Dhatarwal** (*Professor*)  
Forensic Medicine, PGIMS, Rohtak, Haryana
2. **Dr. Adarsh Kumar** (*Additional Professor*)  
Forensic Medicine, AIIMS, New Delhi
3. **Dr. Vijaynath V** (*Associate Professor*)  
Forensic Medicine, Vinayaka Mission Medical college, Tamil Nadu
4. **Ms. Roma Khan**, Forensic Sciences, INSAAF Mumbai
5. **Dr. Imran Sabri** (*Assistant Professor*)  
Department of Bio-Medical Sciences, College of Medicine, King Faisal University, Saudi Arabia

## INTERNATIONAL EDITORIAL ADVISORY BOARD

1. **B. N. Yadav** (*Professor*)  
Forensic Medicine, BP Koirala Institute of Medical Sciences, Nepal
2. **Dr. Vasudeva Murthy Challakere Ramaswam** (*Senior Lecturer*)  
Department of Pathology, International Medical University, Bukit Jalil, Kuala Lumpur, Malaysia
3. **Babak Mostafazadeh** (*Associate Professor*)  
Department of Forensic Medicine & Toxicology, Shahid Beheshti University of Medical Sciences, Tehran-Iran
4. **Dr. Sarathchandra Kodikara** (*Lecturer*)  
Forensic Medicine Department of Forensic Medicine, Faculty of Medicine, University of Peradeniya, Sri Lanka

## NATIONAL EDITORIAL ADVISORY BOARD

1. **Prof. N.K. Agarwal** (*Professor*) Forensic Medicine, UCMS, Delhi
2. **P.K. Chattopadhyay**, (*Professor*)  
Forensic Sciences, Amity University, Noida
3. **Dalbir Singh** (*Professor*) Forensic Medicine, PGIMER, Chandigarh
4. **Dr. Harish Pathak**, Mumbai
5. **J. Gargi** (*Professor*) GGS Medical College, Faridkot
6. **P.C. Dikshit** (*Professor*)  
Forensic Medicine, Jamia Hamdard Medical College, New Delhi
7. **Anil Mittal** (*Professor*)  
Forensic Medicine, Vardhman Mahavir Medical college, New Delhi
8. **Balbir Kaur** (*Professor*)  
Forensic Medicine, MM institute of Medical Sciences, Ambala
9. **Mukesh Yadav** (*Professor*) Forensic Medicine, School of Medical Sciences and research, Greater Noida
10. **T.K.K. Naidu** (*Professor*) Forensic Medicine, Prathima Institute of Medical Sciences Andhra Pradesh
11. **S. Das** (*Professor*) Forensic Medicine, Himalayan Institute of Medical Sciences Dehradun
12. **Col Ravi Rautji**, Forensic Medicine, Armed Forces Medical College, Pune
13. **Dr. Manish Nigam** (*Professor and Head*)  
Department of Forensic Medicine & Toxicology Sri Aurobindo Institute of Medical Sciences, INDORE (M.P.)
14. **Dr. Shailesh Kudva** (*Principal*)  
Rajasthan Dental College and Hospital Jaipur-302026
15. **Usmanganishah Makandar** (*Associate Professor*)  
Anatomy, AIMS, Bhatinda
16. **Dr. Pratik Patel** (*Professor and Head*) Forensic Medicine, Smt NHL Municipal Medical College Ahmedabad
17. **Basappa S. Hugur** (*Associate Professor*)  
Forensic Medicine, Ramaiah Medical College, Bangalore

## NATIONAL EDITORIAL ADVISORY BOARD

18. **Dr. Vandana Mudda** (*Awati*) (*Associate Prof*)  
Dept of FMT, M.R. Medical College, Gulbarga, Karnataka, India
19. **Dr. Harish Kumar. N.** (*Associate Professor*)  
Dept. of Forensic Medicine, Sri Siddhartha Medical College, Tumkur
20. **Dr. Gowri Shankar** (*Associate Professor*)  
Forensic Medicine, SNMC, Bagalkot
21. **Dr. Manjunath Badni** (*Reader*) Dept of Oral pathology Maharana Pratap college of Dentistry and Research Centre, Gwalior
22. **Dr. L. Ananda Kumar** (*Associate Professor*) Forensic Medicine, Rajiv Gandhi Institute of Medical Sciences, (RIMS), Kadapa
23. **Dr. Ramesh Nanaji Wasnik** (*Associate Professor and Head*)  
Forensic Medicine Late B.R.K.M. Govt. Medical college, Jagdalpur
24. **Dr. Sachin Sinha** (*Reader*), Dept. of Oral Pathology & Microbiology Daswani Dental College & Research Centre, Rajasthan
25. **Dr. Sasi Kanth**, Asst. Professor, A.C.S.R Government Medical College, Nellore, Andhra Pradesh.

**Medico Legal Update** is a scientific journal which brings latest knowledge regarding changing medico legal scenario to its readers. The journal caters to specialties of Forensic Medicine, Forensic Science, DNA fingerprinting, Toxicology, Environmental hazards, Sexual Medicine etc. The journal has been assigned international standard serial number (ISSN) 0971-720X. The journal is registered with Registrar of Newspaper for India vide registration numbers 63757/96 under Press and Registration of Books act, 1867. The journal is also covered by EMBASE (Excerpta Medica Database) from 1997 and by INDEX COPERNICUS, POLAND. Medico legal update is a half yearly peer reviewed journal. The journal has also been assigned E-ISSN 0973-1283 (Electronic version). The first issue of the journal was published in 1996.

**Website: [www.medicolegalupdate.org](http://www.medicolegalupdate.org)**

© All Rights reserved The views and opinions expressed are of the authors and not of the Medico Legal Update. The Medico Legal Update does not guarantee directly or indirectly the quality or efficacy of any products or service featured in the advertisement in the journal, which are purely commercial.

## Editor

**Dr. R.K. Sharma**  
Institute of Medico-legal Publications  
Logix Office Tower, Unit No. 1704, Logix City Centre Mall,  
Sector- 32, Noida - 201 301 (Uttar Pradesh)

## Printed, published and owned by

**Dr. R.K. Sharma**  
Institute of Medico-legal Publications  
Logix Office Tower, Unit No. 1704, Logix City Centre Mall,  
Sector- 32, Noida - 201 301 (Uttar Pradesh)

## Published at

**Institute of Medico-legal Publications**  
Logix Office Tower, Unit No. 1704, Logix City Centre Mall,  
Sector- 32, Noida - 201 301 (Uttar Pradesh)



# Medico-Legal Update

---



---



---

## CONTENTS

---



---



---

**Volume 21, Number 1**

**January-March 2021**

1. Psychometric Validation of the Maslach Burnout Inventory (MBI) Adapted to Moroccan Teachers.....1  
*Abdeslam Amri, Zakaria Abidli, Mounir Bouzaaboul, Ziri Rabea, Ahmed Omar Touhami Ahami, Abdelmajid Soulaymani*
2. COVID 19: Evaluate of Liver and Renal Function Tests in Iraqi Patients .....7  
*Abdullah Ali Mohammed, Mahmood Nazar Mustafa, Sura A. Abdulsattar, Ahmed Salam Al-zaidi*
3. Assess the Level of Perception Regarding Instructor Caring Behaviour among Nursing Students at SRM College of Nursing .....11  
*Abirami P.*
4. Medical, Human Rights and Legal Analysis of the Existence of Lesbian, Gay, Bisexual, and Transgender in Indonesia.....16  
*Aditya Yuli Sulistyawan, Tri Rahayu Utami*
5. The Role of Kinship and the Effectiveness of Traditional Customary Law on Inheritance System in Berbah, Sleman Regency .....20  
*Agung Basuki Prasetyo*
6. Does Education Level Matter in Women’s Risk of Early Marriage?: Case Study in Rural Area in Indonesia .....24  
*Agung Dwi Laksono, Ratna Dwi Wulandari, Ratu Matahari*
7. The Border–Non-Border Areas Disparities in Hospital Utilization in Kalimantan Island, Indonesia .....29  
*Agung Dwi Laksono, Ratna Dwi Wulandari*
8. Case-Control Analysis of Malaria Incidence in Sukamerindu Health Center Bengkulu City, Indonesia.....35  
*Agung Sutriyawan, Tenike G. Miranda, Ucu W. Somantri, Hairil Akbar*
9. Descriptive Online Survey: Knowledge, Attitudes, and Anxiety During the Period of Pandemic COVID-19 in Indonesia.....42  
*Agung Sutriyawan, Hairil Akbar, Fibrianti, Intan Pertiwi, Ucu W. Somantri, Lezi Y. Sari*
10. Phacoemulsification Under Topical Anaesthesia Combined with Anxiolytic .....49  
*Ahmed Mohammed Al-Samak*
11. The Influences of Antenatal Care, Postnatal Care and Early Initiation of Breastfeeding on an Exclusive Breastfeeding Pattern in the Working Area of Manukan Kulon Public Health Center at Surabaya City .....53  
*Azizi Pridasari, Lutfi Agus Salim*

## II

12. Applying Strict Liability for Environmental Offenses: Indonesian Perspective .....59  
*Al Halim*
13. Investigation of Cutaneous Leishmaniasis Cases in Baghdad Province, Iraq .....65  
*Aliaa F.A. Al-Naimy, Ali B.M. Al-Waaly*
14. Forensic Autopsy Study of Abdominal and Pelvic Trauma Due to Road Traffic Injuries .....70  
*Alok Kandpal, Ashok Chanana, Jaspinder Pratap Singh*
15. To Compare the Effects of Footwear in Young Female's Postural Balance in Prolonged Standing and Sitting Job .  
77  
*Anandita Sharma, Yamini Sharma, Megha Yadav, Mangalam Kumari, Jyoti Sharma, Sakshi Arora, Akshay Anand*
16. Prospective Studies on Pattern of Two Wheeler Injuries in Road Traffic Accidents.....82  
*Arun Prakash K.S., Sanjeev K., Gambhir Singh O.*
17. A Review of Studies Assessing Cannabidiol's (CBD) Therapeutic Action and Potentials in Respiratory Diseases .  
87  
*Arwa Fairaq, Sahar El-Ashmony, Yosra AL-Hindi*
18. Evaluation the Door-to-Balloon Time in Patient with ST-Elevation Myocardial Infraction (STEMI) in King Abdullah Medical City (KAMC) in Makkah AlMukarramah: A Retrospective Single Center Study .....92  
*Arwa Fairaq, Dunia Alfi, Halah Bahakeem, SehamMalki, Raheeq Algarrash, Shroug Allehyani, Yosra Al-Hindi*
19. The Adsorption Effect of Pine Resin (*Pinus Merkusii*) in Reducing Hardness (CaCO<sub>3</sub>) in Clean Water .....100  
*Ashari Rasjid, Syamsuddin S.*
20. Assessment of the Knowledge and Attitude of Eligible Couples towards Tubectomy and Vasectomy .....107  
*Ashish Dass, Jaspreet Kaur Dullat, Maninder Singh, Aanchal, Balpreet Kaur, Chandresh, Jahangir*
21. Nursing Intervention for Caregivers of Post Autologous Bone Marrow Transplantation Patients at Home .....112  
*Asmaa Farouk Mohamed, Nawal Soliman, Hemat Abd-El-Moneem El-Sayied, Asmaa Talaat*
22. Psychological Problems among the Health Workers During Pandemic Covid-19 .....118  
*Astabrak A. N. Al-Hamoodi, Burhan Hadi, Kafi Mohammad Nasir Al Asadi*
23. Helicobacter Pylori-Associated Iron-Deficiency Anemia and Interleukins Effect.....125  
*AthraaRazaq Mohammed Hindi, Oday MitibHadi*
24. The Influences of Antenatal Care, Postnatal Care and Early Initiation of Breastfeeding on an Exclusive Breastfeeding Pattern in the Working Area of Manukan Kulon Public Health Center at Surabaya City ..... 129  
*Azizi Pridasari, Lutfi Agus Salim*
25. Medico-Legal Updates of the Adverse Threat of Cigarette Advertisements on Children .....135  
*Bambang Eko Turisno, IGA Gangga Santi Dewi, Suharto, Ery Agus Priyono*
26. Term Lowbirth Weight Neonate: Maternal Factors .....140  
*Bashar Mukhlif Khalaf, Zuhair Idreas Mohammed, Nada Hasan Ali*
27. Detection of Heavy Elements and Pathogenic Microorganisms in the Water and Sediments of Domestic Water Tanks in the Center of AL-Nasiriyah .....147  
*Basim Y. Al-khafaji, Hassan Abd Ali Namaa*

28. Appraisal the Quality of Drinking Tap Water in Different Regions of Kirkuk City.....152  
*Batool Kh. Mohammad, Kameran Sh. Husien, Israa Zainal*
29. Strategies Adopted by Women of Rural and Urban Areas for Weight Loss post-Pregnancy .....161  
*Blessy Mohandass, Amanpreet Kaur; Timsy; Nitika Choudhary, Shivani Rana, Sonaly Robinson*
30. Assess the Knowledge, Practice and Attitude Regarding Nosocomial Infections and their Preventive among Health Care Staff .....168  
*Blessy Mohandass, Amanpreet Kaur, Timsy, Harmeet Kour, Navneet Kaur, Pema Choden, Aishwarya Thakur*
31. Oncology Research Productivity of Iraqi Authors: A Bibliometric Analysis During 1955–2019.....174  
*Bushra H Shnawa, Shireen M Al-Majmaie*
32. A Study to Assess the Nursing Students Experience Regarding Online Classes During Covid-19 Lock Down Periods in SRM College of Nursing, Kattankulathur, Kancheepuram District-603203, Tamil Nadu, India .....183  
*C. Kanniammal, T. Suseelal, P. Malarvizhi, P. Vijay Daniel Raj*
33. Study of Anxiety Levels among Occupational Therapy Students During Various Academic Assessments .....187  
*Chirag Pincha, A.V. Anuja, A. Sangeetha, M. Karthika, Samuel Sundar Doss*
34. Plasma CD4 Count and Duration ARV as a Predictor of Virological Failure Amongst AIDS Patients.....192  
*Choirina Windradi, Erwin Astha Triyono, Musofa Rusli*
35. Physiotherapy Students Willingness to Report Misconduct to Protect the Patient’s Interests in Chennai .....198  
*D. Malarvizhi, Bhagya Lakshmi K., Hariharan S.*
36. Effect of Phase 1 Cardiac Rehabilitation to Non-Invasive Hemodynamics in Acute Myocardial Infarction Patients.....202  
*Desi Natalia Trijayanti Idris, Dian Taviyanda, Srinalesti Mahanani*
37. Awareness among MBBS Students About Rise of Violence Against Doctors .....211  
*Divya Reddy Pannala, S.M. Krishna Sagar, Hemantha Rao Amara, Harshini Deshapathi*
38. Study of Production and Characterization of Laccase Enzyme from *Klebsiella pneumoniae* K7 Isolate .....216  
*Doaa Khalid Mezaal, Essam Fadel Al-Jumaili, Ahmed Majeed Al-Shammari*
39. Transformation of the Social Insurance Management Agency on Health.....223  
*Endang Sulistyarningsih, Hartiwarningsih, Is Haryanto*
40. Bio-Nanocomposites: Preparation Technology and Applications.....228  
*Fadhil K. Farhan, Nura Anwer Abdulzahara, Muhammad AL-Jobori*
41. Knowledge and Attitudes of Vaccination among Iraqi Pharmacy Students.....235  
*Fadia Thamir Ahmed*
42. Trend of Implementation Foster Family Toddlers (FFT) Program in East Java Province at 2015-2019.....242  
*Fadilatul Fahmiyah, Lutfi Agus Salim*
43. Assessment Knowledge of the Patients’ with Acute Renal Failure Concerning Dietary Pattern in Dialysis Unit of AL-Zahraa Teaching Hospital at AL-Kut City.....249  
*Faisal Younus Sameen, Qassim Jawell Odah Abed, Tareq Al-Qassab, Ashwaq Yas Khudhair*

## IV

44. Assessment of Women's Knowledge and Practices toward Family Planning at Maternity Hospitals in Baghdad City .....253  
*Fatima Fadel Benyian*
45. Regulation of Law Enforcement in Prevention and Handling of Fire Forests in Environmental Hazards .....259  
*Fatma Ulfatun Najicha, I Gusti Ayu Ketut Rachmi Handayani, Lego Karjoko*
46. Study on Effectiveness of Staff Welfare Program Regarding Occupational Stress During COVID 19 Pandemic among Nursing Officers.....263  
*Franny Joel Emmanuel, Yugmi Vala, Tapan Dodia*
47. Nomophobia: An Assessment of No Phone Phobia among Adolescents.....269  
*Gaurav Kohli, Manu Kohli, Poonam Joshi*
48. Production of Bioemulsifiers from Bacteria Grown on Hydrocarbons .....275  
*Ghassan M. Ahmed*
49. Prevalence of Head Lice (*Pediculus humanus capitis*) among Primary School Children in Baghdad Suburbs .280  
*Hadeel T. Al-Barrak*
50. Estimating the Concentration of Lead and Cadmium for Some Areas of Najaf Governorate .....285  
*Hakeem J. I.*
51. Socio-demographic Predictors of Perceived Health among Syrian Refugees in Jordan .....287  
*Hamza Alduraidi, Zyad Saleh, Ayman Hamdan-Mansour*
52. Predictors of Psychosocial Burden among Workers During the COVID-19 Pandemic Period in Indonesia .....292  
*Hario Megatsari, Agung Dwi Laksono, Mursyidul Ibad, Yeni Tri Herwanto, Kinanty Putri Sarweni, Rachmad Ardiansyah Pua Geno, Estiningtyas Nugraheni*
53. Relationship of Family Support with Anxiety Levels in Preschool Children Hospitalized in Pediatric Ward Syech Yusuf Hospital Gowa Regency, Indonesia .....298  
*Hartati, St. Aminah, Muh. Yusuf M.*
54. The Effect of Quorum Sensing genes (*lasI*, *rhlI*) in Some Virulence Factors of *Pseudomonas aeruginosa* Isolated from Different Clinical Sources.....303  
*Hasan Falah Lahij, Abdulla H. Alkhater, Muthanna Hamid Hassan, Luma Amer Yassir*
55. Total Matrix Metalloproteinase-2 and Prostaglandin E2 as Potential Biomarkers in Iraqi AML Patients .....309  
*Hassnien S. AL- Hashemi Sabah A. Hameid A. Rahman, Zeyad A. Shabeeb*
56. Molecular Profile of Integrase gene *intI* and Carbapenem gene in *Aeromonas sobria* Isolates.....316  
*Hawraa Natiq Kabroot AL-Fatlawy, Taghreed Abdul Al-Kareem Al-Makhzoomy, Mohammed Abdulaali Al-Hakeem*
57. Comparative Study of Children with/without Iron Deficiency Anemia Based on Parents' Knowledge, Attitude and Practice in Basra/Al-Madinah City.....321  
*Haydar Mohsin Abdulhussein, Jabbar Tareh Ahmed, Abbas Ali AL-Kinani, Faiz hussien ali, Rasha Mohammed Jumaah*
58. Effect of Allogenic Omental Graft on Esophagectomy Incision in Dogs Models .....328  
*Hayder Hussein Abd, Montaser Mohammede Hellal, Ammar Maatoq Hashim*

59. The *ITGB3* Genevariant among Sample of Glanzmannthrombasthenia Iraqi Patients .....333  
*Hayderkareemkataa AL-Aidy, Ehab Dawood Salman, Safa A Faraj, Zaid Jamal Mahmood*
60. The Role of P53 Serine 46, Burkitt Cell Lymphoma 2 (BCL-2), and Cysteinyl Aspartate Specific Proteinase 3 (Caspase 3) Proteins as Risk Factors in Abortion .....340  
*Herlambang Herlambang, Firman F. Wirakusumah, Jusuf S. Effendi, Ida Parwati, Leri Septiani, Ahmad Faried, Hiroyuki Kuwano*
61. Healthy Home Concept According to Javanese Ethnic Panaragan Society: An Etnolinguistic Study .....346  
*Hujaefa Hi Muhamad, Titi Rapini, Sri Sugiharti, Alip Sugianto, Siska Diana Sari*
62. Strengthen the Authoritative Function of the Regional Representative Councils in Legislation.....351  
*I Gusti Bagus Suryawan*
63. Knowledge, Attitude and Quality of Life among Type 2 Diabetic Patients in Palestine .....355  
*Imad Thultheen, Ayman M. Hamdan Mansour, Ward Zandeeq, Maysam Ewesat, Saleem Razek, Diana Jabareen*
64. Education as Predictor of Low Birth Weight among Female Worker in Indonesia.....360  
*Ina Kusriani, Noviati Fuada, Sri Supadmi, Agung Dwi Laksono*
65. Dental Care Interventions as Efforts to Reduce PUFA Index and Improve Nutritional Status in Children aged 9-12 Years in Orphanages.....366  
*Indrayati Fadjeri, Rahaju Budiarti, Tedi Purnama*
66. Psychological and Personality Development Supports to the Prisoners in Correctional Institution in Indonesia 372  
*Irma Cahyaningtyas, Nur Rochaeti*
67. Dispute Resolution through Mediation in Endowments Cases in the Legal Effectiveness Theoretical Perspective .. 376  
*Islamiyati, Rofah Setyowati, Dewi Hendrawati, Aisyah Ayu Musyafah, Ahmad Rofiq*
68. An Observational Study to Compare the Effect of Two Different Doses of Dexmedetomidine on Hemodynamic Response to Laryngoscopy and Endotracheal Intubation.....381  
*Jatin B. Patel, Riddhi Agrawal, Malini Mehta*
69. Favipiravir, will it be the Answer for the Specific Management of COVID-19?: A Review .....389  
*Jayant Patharkar, Maulin Mehta, Janhavi Patharkar*
70. Glycemic Control of Non-Hodgkin Lymphoma (NHL) Non-Diabetes Mellitus (DM) Patient in the First CHOP Chemotherapy.....393  
*Jualita Heidy Saputri, Hermina Novida, Ami Ashariati*
71. Reformulation of Medical Rehabilitation against Victims of Narcotics Abuse in Indonesia .....401  
*Jumriani Nawawi, Slamet Sampurno, M. Syukri Akub, Nur Azisa*
72. Impact of COVID-19 Pandemic and National Lockdown on Mental Health among General Urban Indian Population: An Online based Cross-Sectional Survey.....406  
*Jyoti Sharma, Irshad Ahmad, Shahin Naz Jamali, Yamini Sharma, Megha Yadav, Sakhshi Arora, Mangalam Kumari*
73. Information Disclosure and Control on Online Social Network Sites among Medical Undergraduates .....414  
*K. Sudha, Sangeetha A., Kumaresan M., Paarthasarathy B.*

## VI

74. Factors Related to Deaths Due to Suicides in Females Aged 12-24 Years .....417  
*Kandagatla Krishnamurthy, Shruthi Reddy Jillella, Abhijith Subedhar*
75. Method of Ventral Hernia Repair: Our Experience.....422  
*Ketul Shah, Ankur Jain, Vipul Gurjar, Anant Shah*
76. Molecular Characterization of Sewage Bacteriophage and Their Efficiency in Treatment of Antibiotic Resistant Bacteria .....427  
*Khalid Ibrahim Mahmood, Ahmed Mohammed Turki*
77. Assessment of Awareness on COVID-19 among Adults by Using an Online Platform: 26 Countries View .....434  
*Kogila Palanimuthu, Birhanu Gutu, Leta Tesfaye, BuliYohannis Tasisa, Yoseph Shiferaw Belayneh, Melkamu Tamiru, Desalegn Shiferaw*
78. Assessment of Stress, Fear, Anxiety and Depression on COVID-19 Outbreak among Adults in South-Western Ethiopia.....440  
*Kogila Palanimuthu, Hamba Yigazu, Eshetu Fikadu, Gemechu Gelalcha, Yirgalem Bekele, Getachew Birhanu, Birhanu Gutu*
79. Prevalence of Overweight and Obesity among School Going Adolescent in Patna .....446  
*Kumari Mangalam, Chauhan Muneesh, Anand Akshay, Fatima Ambreen, Saho Pramod*
80. Relationship between Coronavirus (COVID-19) and Social Factors: Evidence from 24 Countries Over the World During 88-Day Period from Jan 31 to April 27, 2020.....451  
*Lien Nguyen-Phuong, Hang Thu Thi Dang, Nhung Phuong Thi Nguyen*
81. Satisfaction and Complaints of Patients with Removable Partial Dentures: In Sample at Baghdad City, Iraq ....456  
*Luma Musa Ibrahim*
82. Deep Learning Classification Method to Detect and Diagnose the Cancer Regions in Oral MRI Images .....462  
*M. Praveena Kirubabai, G. Arumugam*
83. Chalk and Talk Versus Powerpoint: Perception among Medical Students .....469  
*Mahanta Putul, Lahkar Babita, Borah Pollov, Das D.K., Choudhury Manoj Kumar*
- 84. *In-vitro* Cytotoxic Activity of E. coli Outer Membrane Vesicles (OMVs) Against Breast Cancer (MCF-7) Cell Line .....474**  
*Mahmood Abed Hamzah, Ali Husain Alwan, Suzan Saadi Hussain*
85. The Predictive Value of Serum Progesterone and Estrogen Receptors as Diagnostic Tool for Premature Ovarian Failure.....481  
*Mahmood Khalil Ibraheem, Mutazsabahahmied, Firas Shawqi Algburi, Amina Hamed Alobaidi*
86. The Predictive Value of Osteocalcin, Granulin, Cathepsin K and Some Other Biomarkers in Women with Premature Ovarian Failure .....486  
*Mahmood Khalil Ibraheem, Mutazsabahahmied, Firas Shawqi Algburi, Amina Hamed Alobaidi*
87. Relation of Human Papilloma Virus Infection with Pre Malignant and Malignant Endometrial Lesions.....490  
*Mahmoud Mohammed Mahmoud, Aseel Ghazi Rifat*
88. Differences between Bribery and Gratification: A Review of Anti-Corruption Act of Indonesia .....497  
*Mahrus Ali, Al Halim, WahyuPriyanka Nata Permana*



89. Study to Assess the Level of Stress among Nursing Students .....503  
*Mandeep Kaur, Kanika Guleria, Anisha*
90. Methodical Learning on Organ Donation: Effect on Students Knowledge and Attitude .....508  
*Maninder Singh, Manpreet Kaur Grewal, Amanpreet Kaur, Yamini Chopra, Aarti Bhatt, Tenzin Choden Manisha Sharma*
91. Variation in Sleep Pattern Due to Lockdown among Collegiate Students.....513  
*Manisha Bhandari, Rabab Kaur*
92. Patient’s Knowledge and Satisfaction with health Care of a Tertiary Care Hospital Situated in Rural area of Northern India (Haryana) .....520  
*Manisha Rani, Jyoti Phougat, Manpreet Kaur*
93. Stress in Working Women Due to Lockdown: A Cross Sectional Survey .....527  
*Manjeet Singh, Rabab Kaur*
94. Integration of Health Education and Cultural Value of Bimanesse Called “Maja Labo Dahu” toward the Intention to Stop Smoking of Smoker Student at Bima District-Indonesia .....532  
*Martiningsih, Nurul Inayati, Rini Hendari, Ade Wulandari*
95. Application of Poskestren as Health Promotion Strategy for Improving Clean and Healthy Behavior of Pesantren in East Java Province .....537  
*Maygi Restu Yang Esa, Muhammad Baharuddin Wisudawan Putra, Diyah Werdiningtyas, S.Gz*
96. Perception of Successful Aging in Nursing Students .....543  
*Mihyeon Seong*
97. Inhibition Activity of Water Hyacinth Leaf Extract (Eichornia Crassipes) to the Growth of Subgingival Plaque Bacteria Colony .....552  
*Ayu Arismawati, Noer Ulfah, Lambang Bargowo*
98. Study to Compare Progrid Mesh vs Conventional Mesh in Lichtenstein’s Open Inguinal Hernia Repair .....557  
*Mohammad Farooque Dudhwala, Chiraag Hiran S., Vipul Gurjar, Honeypalsinh H. Maharaul, Vipul Shory*
99. TMEM121 Protein Is a Regulation Factor in the Proliferation Activity of the Adrenocortical stem/Progenitor Cells .....562  
*Mohammed Abdalmalek Ali Al-Bedhawi*
100. Impact of Broken Family upon Adolescents’ Behavior at Secondary Schools in AL- Najaf AL-Ashraf City.....568  
*Mohammed Baqer Hassan, Khetam Mutashar Hatab*
101. The Safety and Efficacy of Sacral Neuromodulation on Refractory Urgency Urinary and Fecal Incontinence in Iraqi Patients .....575  
*Mohammed Bassil Ismail, Wameedh Qays Abdullhussein*
102. Glycodeline-A, sFlt-1, PlGF Combined as Predictor Markers of First Trimester Pregnancy Loss in Iraqi Women.. 580  
*Mohammed H. Dawood, Halla G. Mahmood, Afraa M. Nedawi*

## VIII

103. The Effect of Using Panicum Mombasa Hay and Millet Hay in the diet on the Production Performance of Awassi Lambs .....587  
*Mohammed H. Fannos, Husam H. Nafea, Ahmed A. Al-Ani*
104. Effect of Combined Antibiotics and Biofilm Formation in Some Bacterial Pathogens from Otitis Media among Children in Baghdad, Iraq .....592  
*Mohammed Khudhair Alwan, Kais Kassim Ghaima, Zainab Shaban Khalaf*
105. The Role of Religion and Spirituality in Alcohol Use Treatment and Recovery: An Integrative Review .....599  
*Mohannad A. Aldiqs, Ayman M. Hamdan-Mansour*
106. Quality of Life After Bariatric Surgery .....606  
*Moly K.T.*
107. Socio-Legal Updates of Children's Rights on the Protection and Shared Assets in Divorce Cases in Indonesian Family Law .....613  
*Muhyidin*
108. New Treatment for Regular Astigmatism Using Physical Exercises .....618  
*Mundher Sameen Shuker*
109. Patterns of Paediatric Maxillofacial Fractures: A Twelve-Year Retrospective Study .....624  
*Musaev Shamshodbek Shuxratovich, Shomurodov Kahramon Erkinovich, Abduxalikov Sirojiddin Faxriddin O'g'li, Narzieva Mahliyo Isrofil Qizi*
110. Effect of Blood Groups and Complications on Orofacial Measurements of B Thalassemia Adult Patients.....627  
*Nada Hashim Mohammed, Nawal Mustafa Abdullah, Riad Altaee*
111. Prevalence of Oral Maxillary and Mandibular Tori among Outpatients Attending Dental Collage in Basra Governorate Southern of Iraq .....635  
*Nadia Azzam Al-Shareeda, Majed Mohamed Refaat, Abdullah M. Hussain*
112. Appraisal of Genotoxicity and Cytotoxicity of Depakine® and/or Epanutin® in Bone Marrow Erythrocytes and Hepatocytes of Male Albino Mice by Comet and Micronucleus Assays.....638  
*Nagla Zaky Ibrahim El -Alfy, Amany Ibrahim Alqosaibi, Mahmoud Fathy Mahmoud, Ayman Mohammad Abdullah*
113. Assessment of Neutrophil-to-Lymphocyte Ratio, Platelet-to-Lymphocyte Ratio, Oxidative Stress and Anti Oxidants levels in Polycystic Ovary Syndrome Patients with Low-Grade Chronic Inflammation .....644  
*Najlaa Abdulameer Ali AL-Dahhan, Aseel Jassim Albdairi, Ammar Jabbar Hamad*
114. Impact of Breakfast Habits on Physical Parameters and Academic Performance of Nursing Students .....653  
*Nalini M., Sukesh, Joyce Fernandes*
115. Self Medication Practices among Youngsters: A Global Health Concern.....658  
*Navdeep Kaur, Bandana Bisht, Manmeet Kaur*
116. Service Quality Assessment of Higher Education by Gray Approach (The Case of Kerbala University) .....664  
*Nawal Mousa Almeyali, Ali Al Mousawi*
117. Effectiveness of Breathing as a Non-Pharmacological Method to Reduce Pain Severity among Woman During Labor.....674  
*Nawras Monim Alzurfi, Shukriyia Shadhan Al-Ogaili*

118. Vitik Detection of Aerobic Spore-Forming Bacteria Isolated from Raw Milk, Skim Milk Powder and UHT Milk.. 678  
*Nawres N. Jaber, Nada Salih Hadi, Abeer Laily Mohammed, Marwa Idan, Adyan Niama*
119. Counseling with Tooth Brushing Demonstration Method as an Effort to Improve Tooth Brushing Skills and the Status of Dental and Oral Hygiene in Early Childhood at School .....684  
*Ngatemi, Tedi Purnama*
120. Smoking Behavior among Female Worker in Indonesia Does Education Matter?.....688  
*Nikmatur Rohmah, Anita Dewi Prahastuti Sujoso, Masruroh, Ilyas Ibrahim, Qurnia Andayani, Irfansyah Baharuddin Pakki, Agung Dwi Laksono*
121. Biostatistics Evaluation of Women Breast Lesions in Baghdad/Iraq.....694  
*Noor F.M. Ali, Hiba A. Abdul Sattar, Mervet Abd-alhassan, Fathaa Abdullah Mahmoud, Munya H. Sabri*
122. Strategies of Carious Tissue Removal in Deep Carious Lesions among Dentists in Iraq: Online Based Survey Study.....698  
*Noor H. Fadhil, Anas F. Mahdee, Ahmed H. Ali*
123. Antibiofilm Activity of Nystatin, Aspirin and EDTA Against *Candida albicans* Isolated from Iraqi Women with Vulvovaginitis .....703  
*Noor Naser Raheem, Kais Kassim Ghaima\**
124. Radiographic Evaluation of Five Variables in Iraqi Young Subjects among Impacted and Erupted Lower Wisdom Teeth Groups .....712  
*Nuhad A. Hassan, Amal R.S. Mohammed*
125. Information Seeking Problems that May Occur Against Covid-19 Vaccine When it is Ready.....718  
*Olowo Emmanuel Opeyemi, Hamisah Hasan, Abdul Mua'ti, Julia Wirza Mohd Zawawi*
126. Newly Emerged Online Educational Framework in Nursing Major During the Pandemic of COVID-19.....722  
*Omar M. Khraisat, Ahmad M. Al-Bashaireh, Mohammad O. Khraisat, Fatima H. Khraisat, HD Eman Nazly, PhD, RN Mohammad A. Aldiqs, MSN, RN*
127. Factors Contributing to Emotional Distress among Postpartum Mothers with Newborns at Newborn Unit Kenyatta National Hospital, Kenya .....728  
*Omulo O. Wycliffe, Cheptum Jebet Joyce, Mageto G. Irene Mageto*
128. Assessment of Satisfaction Level and Quality of Life among Haemodialysis Patient's on Dialysis Therapy .....734  
*Parimala L., Mary Sofia*
129. Exogenous Cushing's Syndrome with Subsequent Secondary Adrenal Insufficiency in Patients with Long Term Steroid Usage.....738  
*Cynthia Ayu Permatasari, Ferdy Royland Marpaung*
130. Influence of Exercise Classics on the Ability to Switch the Attention of Schoolchildren Aged 9-10 Years.....744  
*Polevoy G.G.*
131. Effectiveness of Teaching and Text Message Based Intervention on Dietary Habits among Overweight Adolescents in Selected Schools of Ambala, Haryana .....749  
*Pooja, Kanika, Srinivasan P.*

132. Changing Trends Inpoisoning at a Tertiary Healthcare Centre in North Karnataka, India .....755  
*Pratibha R. Kulkarni, Ranganath R. Kulkarni, R.B. Kotabagi*
133. Approach to Patients with Hemorrhoids at Our Tertiary Care Centre .....760  
*Pratik Shaparia, Brijesh Bharodiya, Vipul Gurjar, Honeyalsinh H. Maharaul*
134. Behaviours (Cognitive, Affective and Psychomotor) among Patients with Gout Arthritis in Elderly.....763  
*Chilyatiz Zahroh, Asmaul Faujiyah, Ima Nadatien, Yasi Anggasari, Nur Ainiyah, Siti Nurjanah*
135. Clinical Study of Functional Outcome of External Fixator Device as a Primary Definitive Treatment of Open Tibia Fracture.....768  
*Praveen Garg, Rajvirsinh Sodha, Fahad Bin Hamid, T. Somashekarappa*
136. To Study Preloading and Relative Efficacy of Ringer's Lactate and Pentastarch 6% Prior to Spinal Anaesthesia in Lower Abdominal and Lower Limb Surgeries.....772  
*Priya Kishnani, Ishaan Batra, Tejash Sharma, Malini Mehta*
137. Human Liver Morphology: Anatomical Study about the External Aspects.....780  
*Priyanka N. Sharma, Nirali Chavda, Hetal V. Vaishnani, K.M. Parmar, Kinjal Jethva, Manoj Kulkarni, A.R. Gandotra*
138. Informed Consent to Patients in Root Canal Treatment (Case Study: Melati Dental Clinic Jakarta, Indonesia).786  
*Pudentiana Rr RE, Tedi Purnama, Syifa Yulia Lestari, Yulianti*
139. Assess Knowledge and Attitudes on First-Aid Measures for Selected Domestic Accidents among Caretakers of Under-Five Children.....790  
*Pushplata Manta, Kanu Mahajan, Kanika Guleria*
140. Anthropometric Assessment of Canthal Distances and Canthal Index of South Indian Region: A Cross-Sectional Study.....794  
*Radha K., Srinivasan K.R.*
141. Tuberculosis of the Breast: A Challenging Component of Benign Breast Diseases.....798  
*Rajbangshi M.C., Deka Sumi, Mahanta Bandana, Mahanta Putul*
142. Iron Content as an Indicator for *Legionella* Species in Artificial Water Systems .....803  
*Rajeshwari Vittal, Juliet Roshini Mohan Raj, Ballamoole Krishna Kumar, Indrani Karunasagar*
143. Deleted
144. Practice of Documentation at Casualty of Tertiary Care Hospital: An Interventional Study .....816  
*Ramasamy R., Ganesh Rajendiran, Kagne R.N.*
145. Risk Factors for Neonatal Death in Female Workers Mothers in Indonesia.....822  
*Ratna Dwi Wulandari, Agung Dwi Laksono, Astridya Paramita, Pramita Andarwati, Naillul Izza*
146. Barriers to Antenatal Care Utilization in Indonesia .....828  
*Ratna Dwi Wulandari, Agung Dwi Laksono, Tety Rachmawati, Rukmini Rukmini*
147. A Questionnaire Based Study Evaluating Awareness for Organ and Body Donation and Cadaveric Dissection among the General Population Attending Medical and Dental Hospital .....835  
*K.M. Parmar, Hetal Vaisnani, Nirali Chavda, Priyanka Sharma, Kinjal Jethava*

148. Assessment of Scapula Muscle Strength in Housemaids .....840  
*Riddhi Shroff, Ankita Jain*
149. Effectiveness of Piriformis Stretching and Intermittent Lumbar Traction along with Spinal Extension Exercises in Lumbar Disc Herniation: Comparative Study .....844  
*Rituraj Verma, Taruna Verma, Vikas Sharma, Yash Pratap, Sanghamitra Jena, Sajjad Alam*
150. Cassava Leaves Extract (*Manihot esculenta*) Prevents the Decrease of Albumin Serum Level in Mice with Gentamicin-Induced Hepatotoxicity.....848  
*Rosita Dewi, Rena Normasari*
151. Common Warts Treatment by Intralesional (60,000 Versus 120,000) IU of Vitamin D3, Comparative Study...853  
*Ruya Thamer Ihsan Mahmoud, Mazin Hamid Ayyash*
152. Using of Glycated Albumin Rather than Glycated Hemoglobin for assessing Glycaemic Control in Hemodialysis Patients with Type II Diabetes Mellitus .....860  
*Salahaldin M. Fahad, Rashied M. Rashied, Waleed N. Jaffal*
153. Pattern of Head Injuries in Deaths Due to Two-Wheeler Road Traffic Accidents.....866  
*S.M. Krishna Sagar, Divya Reddy Pannala, K.V. Ramanamurthy, K. Rajender Kumar*
154. Maxillofacial Trauma and Alcohol Abuse: A Descriptive Cross Sectional Study.....871  
*S. Devakumari, T. Vijhayapriya, Nandini Biradar, P. Amudha, D.S. Dinesh, S. Devameena*
155. Histopathological Grading and Enzyme Histochemical Study of the Placenta in Gestational Diabetes Mellitus Pregnant Women .....878  
*Sahar A.H. AL-Sharqi, Amal Kadhem Chaloob, Ilham Abd Allah Ali Al-Saleem*
156. Subjective Assessment of Satisfaction Degree and Psychosocial Status of Patients with Highly Atrophic Mandible Treated by Implant-retained Over-denture .....886  
*Salah A. Al Omoush, Wijdan R. El Manaseer, Firas Al Soleihat, Kifah D Jamani*
157. Valuable Dental Materials from *Salvadora Persica* Plants .....893  
*Salah A. Jassim, Kafa K. Hammud, Bassam Alsheekhly*
158. Serological Tests Assessment in Patients Suspected to have Celiac Disease Attending the Gastroenterology and Hepatology Teaching Hospital in Baghdad.....904  
*Samer Nema Yassen Alkemawy, Shymaa Nema Hamed Alsaltani*
159. Evaluating the Sensitivity of (miR-378) as a Circulatory Screening Biomarker for Diabetic Cardiomyopathy: Comparative Study .....912  
*Sana Abdul-Jabbar Ali, Hyder Hashim Al-Shlah, Mais Mazin Al-Hamdani, Oday Jasim Al-salihi*
160. Using the Digital Occlusal Analysis (T-Scan NOVUS) in Diagnosis the MFDS in Iraqi Patients During Lateral Excursion Movements .....919  
*Sanaa Abdul Hameed Hussein, Jamal N. Ahmed*
161. Awareness on Nutritional Anemia and its Prevention among Adolescent Girls.....925  
*Santhi P., G. Ambujam*
162. Incidence and Predictors of Postoperative Acute Kidney Injury in Non-Cardiac Surgery .....930  
*Sara Mary Thomas, Bhavika Sangada, Sanam Vasava, Lokesh Akkineni, Chaitri Shah*

## XII

163. Gender Differences in Life Satisfaction: The Moderation Role of Social Support among Older Persons .....935  
*Sarah Al-ja 'freh, Rabia Allari, Ayman M. Hamdan-Mansour*
164. Effects of Emotional Intelligence on Multi-cultural Cognition and Multi-cultural Attitude in Undergraduate Nursing Students in Korea.....941  
*Seong Mihyeon, Chung Soojin, Hong Hyonjoo, Song Jihyun, Hwang Wonju*
165. Characteristic of CD4+CD25+ T Cells in Chronic Myeloid Leukemia Patients Treated with Imatinib Mesylate with Different BCR-ABL Transcripts Levels Response .....949  
*Shahla'a Fadhil Sabir, Wifaq Mahmood Ali Alwatar, Bassam Francis Matti*
166. Effect of Segmented Sleeping on the Academic Performance of Medical Students. A Questionnaire Survey ....956  
*Shalini S.P., Balaji K., Yuvaraj Maria Francis, Gunapriya Raghunath, Vijayalakshmi S.*
167. Study *ndvB* gene Expression in *Pseudomonas aeruginosa* Producing Biofilm.....961  
*Shamam Tahseen Ismail, Mohammed Ibraheem Nader Altaai*
168. Prevalence of Child Physical Abuse among School Children in Mosul City\North of Iraq .....966  
*Shatha Abdul-Rahman H. Al-Ghurairi, Eman Al- Khafaf, Hana A. Al seed*
169. Quintessential Conceptualization of Bone Graft .....973  
*Shipra Jaiswal, Amit Wadhawan, Mehvish Saleem*
170. Role of Mental Health in Understanding and Preventing Suicide.....979  
*Smita Satapathy, Madhubrata Mohanty*
171. Awareness of Adverse Effects of Lead-containing Cosmetics among the Adolescence and Young Adult Population in Chennai: A Survey .....984  
*Sneha A., Balaji K., Yuvaraj Maria Francis, Gunapriya Raghunath*
172. Medical and Legal Constraints for Organizing 2020 Regional Head Election in the Covid-19 Pandemic in Indonesia.....990  
*Sri Wahyu Ananingsih, Ratna Dewi Pettalolo*
173. Correlation between Disability and Stigma on Leprosy Patient at General Public Hospital of Daha Husada Kediri 995  
*Srinalesti Mahanani, Desi Natalia Trijayanti Idris*
174. Recurrence Rate of Surgical Resection with Reconstruction of Plate Osteosynthesis in the Ameloblastoma Treatment.....1000  
*Suha Mohammad Sami*
175. Older People with Urinary Incontinence: A Nurse Practitioner' Role in the Assessment and Management .....1006  
*Supichaya Wangpitipanit*
176. Infliximab-Associated Hepatic Injury in Crohn's Disease .....1012  
*Sura A. Abdulsattar, Raghd A.Y. Alkhader, Haider Ridha Mohammed Saeed, Fatin F. AlKazazz*
177. COVID 19: Evaluate of Liver and Renal Function Tests in Iraqi Patients .....1018  
*Sura A. Abdulsattar, Mahmood Nazar Mustafa, Abdullah Ali Mohammed, Ahmed Salam Al-zaidi*

178. Implementation of Cross-Sectoral Collaboration in the Leptospirosis Control in Jenepono Regency: A Qualitative Approach .....1022  
*Syamsuar Manyullei, Muh. Fajaruddin Natsir, Wirdayanti*
179. Impact of Quality of Healthcare Services on Consumer's Satisfaction at Primary Healthcare Centers .....1029  
*Tariq Yassen Taha, Wissam Jabbar Qassim*
180. **The Relationship between Adolescent Risk Behavior in Drug Abuse: A Literature Review.....1037**  
*Ahmad Yani, Sukri Palutturi, Ridwan Amiruddin, Sudirman Nasir, Aminuddin Syam, Rajindra, Anto J. Hadi*
181. The Effect of Environmental Factors on the Enzyme Production of *Aeromonas Hydrophila* Isolates .....1043  
*Hawraa Natiq Kabroot AL-Fatlawy*
182. Sleep Patterns in Overweight/Obese Adults in Baghdad City .....1051  
*Maha Sabah Ahmed Al-Jumaili*
183. Analysis of Prothrombin Time (PT) and Activated Partial Thromboplastin Time (aPTT) in Patients with Acute Myocardial Infarction on Anticoagulation Therapy to Assess the Thrombogenic Potential .....1058  
*Shubhi Saxena, Nishant Saxena, Richa Jain, Jasmin Jasani*
184. Correlation of the Stature to Forearm Length in the Young Adults of Western Indian Population.....1062  
*Suryabhan S. Dongre, Ravindra B. Deokar, Sachin S. Patil*
185. Assessment of Nursing Students' Knowledge toward Preventive Measures of Urinary Tract Infections in Mosul Teaching Hospitals .....1070  
*Tahsein Muhsin Hussein, Munther Nather Al-Fattah, Tameem Thamir, Radhwan Hussein Ibrahim*
186. Impact of Educational Program on Nurses' Knowledge toward Coronary Artery Bypass Graft Surgery in Mosul Teaching Hospitals .....1075  
*Tahsein Muhsin Hussein, Myasar Mohsin Azeez, Radhwan Hussein Ibrahim*
187. Quality of Health Care System and Structure at Primary Health Care in Baghdad City .....1081  
*Tariq Yassen Taha, Wissam Jabbar Qassim*
188. Relationship of IL-6 Level and Lipid Profile as Predictor Ventilator-Associated Pneumonia .....1088  
*Taufiq Gemawan, Arie Utariani, Kuntaman*
189. Saliva of Tobacco Smokers a Profile of C3, IgA, Amylase and Total Protein .....1093  
*Zahraa Hussein M. Kadri, Hazima Mossa Alabassi, Ahlam Jassim Taher*
190. Anti-Islet Cell Antibody and Anti-ovarian Antibody Levels in Iraqi Women with Polycystic Ovary Syndrome.....1098  
*Zainab Ali Hlail, Ahmed Sahib Abd-ulamir, Khalil Ismail Abd-Mohammed, Mohammed Odah Salman*
191. The Effect of Serum Estradiol Level at the Time of HCG Injection on the ICSE Outcome.....1102  
*Zainab Abd Alkathem Fatnan, Zainab Alkhafajy, Aseel Abdulameer Mohammed*
192. The Satisfaction of Patient with Respect to the Aesthetic and Phonetic of Removable Partial Denture Therapy for Iraqi Patient.....1108  
*Zainab Mahmood Al-Jammali, Anas Al-Yasiry, Zahra S. Abed Karkosh, Azad Almuthaffer*
193. The Accumulative Effect of Heavy Metals on Liver and Kidney Functions .....1114  
*Zeyad Gattea Koshan Al-Rikabi, Montaha Abulkareem Al-Saffar, Adnan H. Abbas*

## XIV

*Lecturer, Prof., Ministry of Science and Technology/Environment and Water Directorate/Baghdad, Iraq, Lecture, Department of community health, Medical technical Institute, Middle Technical University, Baghdad, Iraq*

194. Assess the Knowledge of Married Women in Reproductive Age Group Regarding the Contraceptive Method ..... 1120  
*Timsy, Amanpreet Kaur, Nirlep Kaur, Sandeep Kaur, Shiwani, Nikhil*
195. An Analytical Prospective Study of Plasma Pseudo–Cholinesterase Level & its Co-Relation to Mortality in Acute Organo Phosphate Poisoning ..... 1124  
*Tejas J., Siva Kumar V., Shruthi K., Vishwanathan K.G.*
196. Perception of Nursing Care among Patients at SRM General Hospital, Kattankulathur, Kancheepuram District ..... 1130  
*Keerthana S., Deepika M., C. Kanniammal, Ushapriya Mathiazhakan*
197. Spectrum of Clinical and Hematological Changes in Patients of Malaria: A Tertiary Care Hospital Experience in Gujarat ..... 1134  
*Trupti R. Jansari, Jigna P. Patel, Amit Chauhan, Jasmin Jasani*
198. Relationship of Knowledge and Attitudes with Male Participation in Vasectomy in Indonesia ..... 1139  
*Tjahja Bintoro, Bhisma Murti, Endang Sutisna, Suwanto*
199. Premarital Sex Behaviour of Adolescents in Makassar, Indonesia ..... 1143  
*Theresia Limbong, Made Sukarta*
200. Health Literacy Associated with Raw Cyprinoid Fish Consumption in Northeastern Thailand ..... 1149  
*Tiwakron Prachaiboon, Pannee Banchonhattakit, Nathkapach Kaewpitoon Rattanapitoon, Surachai Phimha*
201. Nutrient and Cost Optimization in Menu Planning at an Apex Tertiary Care Hospital Using Operational Research Techniques ..... 1155  
*Vijay Kumar Tadia, Mahesh R., Sidhartha Satpathy*
202. Picture Archiving and Communication Systems (PACS): A Pre-Post Comparative Analysis ..... 1162  
*Vijay Kumar Tadia*
203. Medico Legal Documentation in a Public Hospital in India: An Analysis of 100 Cases ..... 1168  
*Vijay Kumar Tadia, Paresh Shekhar Jangale*
204. Evaluation of Radiology Information Systems including PACS at Two Tertiary Hospitals in India from User's Perspective ..... 1171  
*Vijay Kumar Tadia*
205. Spinal Region Segmentation for Intervertebral Distance of X-Ray Images Using Spectral Analysis ..... 1178  
*Virendra Singh, Vineeta Saxena Nigam*
206. Assessment of the Knowledge and Attitude Regarding Plastic Use and its Health Effects among Nursing Students of Selected Nursing Colleges of Ambala, Haryana ..... 1186  
*Vijyeta Bhasin, Shalini, Kirandeep Kaur Dhaliwal, Anamika Gautam*
207. Socio-Demographic Profile of Suicidal Cases Autopsied at Tertiary Care Centre in Uttarakhand: A Retrospective Study ..... 1191  
*Vikas Vaibhav, Pawan Kumar Shukla, Sanchit Jain, Raviprakash Meshram*



208. Study of the Balance System between Some Enzymatic and Non-enzymatic Antioxidants in Blood Serum of Patients with Rheumatoid Arthritis in Mosul City, Iraq.....1197  
*Walaa A. Al-Jawadi Muna H. Jankeer*
209. The Concentration of Lead and Cadmium in the Gill and Muscle of Common Carp Fish (*Cyprinus carpio*) in Three Fish Farms in DhiQar City–South Iraq.....1202  
*Wesan Fadhel Khalef, Zainab Mohsen Ibrahim, Bushra Ali Ghyadh*
210. Characteristics, Effective Reproduction Number (Rt), and Prediction SIR Model of Covid-19 at Banyumas District, Central Java, Indonesia.....1206  
*Yudhi Wibowo, Nendyah Roestijawati, Siti Munfiah, Sadiyanto, Arif Burhanudin, Misti Rahayu*
211. Medico-Legal Outlooks in Preventing Traffic Violations and Accidents by Enforcing the Structure and Function of the Police Unit .....1213  
*Yusriyadi*
212. Knowledge and Practice of Pregnant Iraqi Women about COVID-19 Preventive Measures .....1217  
*Thikra N. Abdulla, Weqar Akram, Taghreed MardanAbullah*
213. The Study Effects of *Quercus infectoria* on the Oral Environment in Gingivitis Patients.....1224  
*Ali Hasanain Alhamadani, Rana Talib Al-Muswie, Sameerah Jameel Tarfa*
214. Relations between Interlukin-6 and Some Biochemical Parameters in Diabetic Foot Syndrome .....1230  
*Raid M.H. Al-Salih, Zeena M. Ali*
215. Prevalence of Work from Home on Female-it Workers, on Neck Pain and its Psycho-Social Effects During Epidemic Period .....1240  
*Taruna Verma, Rituraj Verma, Diksha Bameta, Vikas Sharma, Sonia Saroha, Ashu Taneja*
216. Comparison between the Classical Symphony and Self Selected Music on Muscle Endurance in Young Obese Males .....1247  
*V. Mahammad Rafi, A. Sangeetha, Adlin K. Kazia, S. Prem Kumar, B. Arun Kumar, B. Vijayalakshmi*
217. Factors Affecting Romantic Relationship Satisfaction of University Students.....1252  
*Kyu Eun Lee, Hae Kyung Chang*
218. Non-Invasive Monitoring of Blood Glucose Concentration Based on Insulin Secretion Level Using NIR Spectroscopy for Diabetes Detection .....1259  
*D. Arul Kumar, T. Jayanthi*
219. Effects of Multidrug-Resistant Organism Infection Control Simulation Program on the Infection Control Fatigue, Job Stress, and Performance of Nurses .....1267  
*Mi Hyang Lee*
220. Assessment of Breast Cancer Risk by Gail Model in Women of Thi-Qar.....1273  
*Sara OmranIssa, Zainab H. Farhood, Zaman Subhi Madlool*
221. *In Silico* Study Chitosan Snail Shell as Antioxidant Through Interesting NRF2-KEAP1 in Hypercholesterolemia. 1277  
*Umarudin, Dewi Ratih Tirto Sari, Fatchiyah Fatchiyah, Sri Rahayu, Sri Widyarti, Warsito*

222. Synthesized Gold Nanoparticles Using *Pseudomonas* Supernatant and Study the Physical Characterization–Antiproliferative Activity of Breast Cancer Cells (MCF-7).....1281  
*Karrar Nadhim, Nibras Nazar Mahmood, Aseel Mustafa*
223. Molecular Detection of Tumor Necrosis Factor-Alpha (TNF- a) Gene in Mycotic aborted Placenta of Ewes Using RT-PCR .....1287  
*Bushra Hamza Fares, Hameed Abdul Hussain Al-tememy, Ban Abbas Abdulmajeed, Mohammed M. Dakheel*
224. Detection of *Legionella pneumophila* and *Legionella dumoffii* Biochemically in Water Samples in Baghdad City, Iraq.....1292  
*Jundi Alak Mahdi Al-Buhilal, Taghreed Khudhur Mohammed*
225. The Relationship between Some Blood Components and Wool Production and Some of its Physical Traits in the Local Arabian Sheep .....1297  
*Hafetd Musa Ali AL-Taee, Rahman Hussein Hamza Al-Qasimi, Azhar Abdulabbas Jaffar Shareef*
226. Evaluating the Sensitivity of (miR-378) as a Circulatory Screening Biomarker for Diabetic Cardiomyopathy: Comparative Study .....1301  
*Sana Abdul-Jabbar Ali, Hyder Hashim Al-Shlah, Mais Mazin Al-Hamdani, Oday Jasim Al-salihi*
227. Effects of Duration of Diabetes and Diabetes Therapy (Metformin) on Fbxw7 Levels in Iraqi Type II Diabetic Patients.....1308  
*Suhayla K. Mohammed, Hayyan I. Al-Taweil, NouraKaram M. Salih, Samer Abdulhasan Muhi, Ekhllass M. Taha*
228. Color Change of Two Different Nano-Hybrid Resin Composite Materials after Staining and Bleaching. (An *in vitro* Study) .....1314  
*Zahraa Sabah Abdul Wahhab, Emad Farhan Alkhalidi*
229. The Effect of Interfering Waves Strategy in Developing Some Basic Volleyball Skills for Intermediate First Graders.....1320  
*Aujeed Madlool Abbas, Sattar Jaber Ashour, Bashar Akram Mohammed, Jabbar Ali Kathim*
230. Diagnostic Study of Some Microbiological Dacryocystitis with in Baghdad City Patients .....1326  
*Zena K. Khalil, Ala'a K. Husain, Saif S. Al-Kamil*
231. The Effect of the Physical and Artistic Education Lesson Through Play and Art in Developing Some Motor Abilities and Reducing Mobility for Pupils in the Fifth Grade of Primary School of the Primary Stage.....1332  
*Aujeed Madlool Abbas, Nawfal Shamkhi Naji, Haider Sami Muhammad, Jabbar Ali Kathim*
232. Molecular Study of Genetic Diversity in *Escherichia coli* Isolated from Tap Water in Baquba .....1338  
*Noor Jameel Allhaby, Hadi Rahman Rasheed Al-Taai*
233. Asprosin Role for Obese Male Patients with Diabetic Mellitus Type II.....1345  
*Dina A.M. Al-Khafajy, Maysaa J. Majeed, Omar F. Al-Azzawi; Ayad Ismael Khaleel*
234. The Effect of the Advanced Organizations 'Strategy on Attentional Control and Learning Some Offensive Skills Installed with Basketball for Students .....1350  
*Ahmedkhalid Awad*
235. The Effect of Rehabilitative Physical Exercises to Develop Some Aspects of Muscle Strength and Range of Motion in Rehabilitating the Deltoid Muscle of the Shoulder Joint of Badminton Players .....1356  
*Mustafa Muhammad Ali Farhan, Salman Dawood Tuaimah*

236. Human Folate Receptor-1 Gene Expression and Correlation with Physiological Leptin hormone in Obese and Non-obese Subjects.....1363  
*Areej GH Al-Charak, Hawraa H. Naji, Hamzah H. Kzar*
237. EV Targeting MCF-7 Breast Cancer Cell Lines Inhibit Both mTOR and HIF-1A: Molecular Docking Study.1367  
*Haider O. Mossa Al-Gazali, Hamzah H. Kzar, Moshtak A. Wtw, Moad E. Al-Gazally*
238. Road Traffic Accidents and the Traumatic Brain Injuries: A Cross- Sectional Study. ....1374  
*Ali Abbas Hashim Al musawi, Hasan Alwan Baiee*
239. Frequency of Left Ventricle Dysfunction in non-Alcoholic Fatty Liver Disease (NAFLD) Patients Detected by Global Longitudinal Strain and Tissue Doppler Imaging in Babylon Province in Iraq.....1380  
*Haitham Shaalan Sewan, Hassan Salim Aljumaily*
240. Levels of Some Biomarkers in Ischemic Heart Disease Patients.....1387  
*Majida Sulaiman Aadai , Mayada Noori Iqbal, Nahlah Ghanim Abdul Majeed*
241. Brain Hydatidosis Surgical Outcome .....1395  
*Mohammed Z. Shaker, Nashwan Y. Sallama, Mohammed I. Ramadhan*
242. Evaluation the Role of Malondialdehyde in Occurrence and Development of Diabetic Retinopathy Patients ..1400  
*Marwa Riyadh Khalaf, Mutaz Sabah Ahmeid, Osamah Jihad Abdulqader Hashim Abdulsattar Jabar*
243. Psoriasis Beyond Local Skin Disease.....1409  
*Amina Hamed Ahmed Alobaidi, Abdulghani Mohamed Alsamarai, Muhib Ahmed Salih*
244. IL-6, IL-0, IFN Gamma and CRP in Newly Diagnosed COVID 19 Patients .....1418  
*Mazin Jabbar Kathim; Tamara Amer Taha, Suzan Saadi Hussain, Nihad Khalawe Tektook*
245. The Value of Measurment of Bilirubin in Pleural Fluid in the Differentiation between Exudative and Transudative Pleual Effusion.....1423  
*Bint Al huda A. Jaber, Khalid Abd Alstar Hussein, Zahrah Salih*
246. Serum Leptin Level and Thyroid Hormone in Type 2 Diabetes Patients.....1428  
*Hamza Mustaffa Khuder, Khudair Abbas Khudair, Ammar Lateef Hussein*
247. Comparison between Using Bupivacaine 0.5% and Bupivacaine with Sodium Bicarbonate 8.4 % in Thoracic Epidural Anesthesia for Laparoscopic Cholecystectomy .....1435  
*Ayman G. Saeed, Khaled Ali Khaleel, Mohammed Asi Jabbar*
248. Prevalence of Direct Peer Bullying among Primary Schools' Children in Holly Karbala Center.....1442  
*Ali Abdulrazzaq, Noor Fadhil Abass, Shaima' Nasir Mohammed*
249. Types of Cancer Prevalence in Al Muthanna Province for Two Years' Duration (2018-2019).....1448  
*Sarah Ali Abed, Rana Dakhil Nafea, Suha Suhiel Hussein, Dergham Majeed Hameed, Ihab Abbas Taher*
250. Histomorphometric and Histochemical Finding of the Proventricular and Ventricular Stomach between the African Grey Parrot (*Psittacus erithacus*) and Black Francolin (*francolinus*) in South Iraq .....1457  
*Eyhab R.M. Al-Samawy, Shaima Khazaal Waad, Wissam Sajid Hashim Al-Uboody, Mustafa Salah Hasan*
251. Salivary Sialic Acid Level and Oral Health Statues in Sample of Iraqi Children.....1466  
*Lamia I. Sood, Ameena Ryhan Diajil*

## XVIII

252. Hypolipidemic and Antioxidant Efficacy of Apigenin in Hydrogen Peroxide induced Oxidative Stress in Adult Male Rats .....1473  
*Mohammed I. Al-Rawi, Aous Kahtan Almzaian, Kahtan A. Almzaian*
253. Detection of *Propionibacterium* in Samples by Metagenomic Analysis that Collected from Patients Suffering Acne Vulgaris in Babylon Province .....1481  
*Rabab J H AL-Hasseny, Lamees A. Abdul-Lateef, Hussein Abbas AL-Sultany*
254. Expression Levels of Efflux Pump *mexR* and *norA* Genes in Multi-Drug Resistant in Some Bacteria by Using Quantitative RT-PCR Under Stress of Effect Efflux Pump Inhibitors .....1486  
*Baidaa Adel Ibrahim, Mayadaa Abdullah Shehan*
255. Distinguish between Two Species of *streptococcus* by *sk* gene .....1493  
*Rawaa Kh. Mohammed, Harith K. Buinya*
256. Impact of Vitamin D Elements in Insulin Sensitivity in Type 2 Diabetes Mellitus (DM2).....1499  
*Wafaa Raji Alfatlawi, Zainab Majid Ali, Muhammed Abdul-Gabar Aldabagh*
257. Angina and Sudden Fatal (Arrhythmia) Cardiac Disorders that affect People with the Presence of Risk Factors that Show a Change in the Electrical Conductivity of the ECG.....1505  
*Salah Abd-Al Kader Omran*
258. Effectiveness of an Educational Program on Nurses' Knowledge about Communicable Diseases Control in Al-Nassiriyah City Hospitals .....1514  
*Talal Mohammed Yousef, Wissam Jabbar Qassim, Zahid Jassim Mohammed*
259. Evaluation Follicular Fluid Cytokines in Patients with Risk Factor for Development of Ovarian Hyper Stimulation Syndrome.....1521  
*Alaa K. Hameed, Alaa S. AL-Atabbi, Muna K. Mahmood*
260. Methicillin-Resistance *Staphylococcus Aureus* (MRSA) in Hospitals: The Unwanted Guest .....1530  
*Nadhim N. Tahir, Saad S. Hamim*
261. Assessment of Health Workers Knowledge toward Occupational Health and Safety Program in Alkut City's Primary Health Care Centers .....1536  
*Duaa Malik Dhahir, Naji Yasser Al Mayahi*
262. A Comparative Study of Arch Width, Overjet and Overbite between Bilateral Congenital Missing Lateral Incisor and Normal Class I Occlusion .....1542  
*Zena Hekmat Altaee, Laith Hamood Aswad AL-Salmany, Maha Mishaal Turki*
263. Application of Fractional Co2 Laser Modification of PEEK in Dental Implants, *In vivo* Study.....1548  
*Nahida Zahir Kamil, Basima Mohammed Ali Hussein*
264. Study of Verbal Bullying in Early Adolescents (Case Study of Pallangga 5 Junior High School and Sungguminasa 3 Junior High School).....1553  
*Muh. Asrul Taufiq Arifuddin, Suriah, Sudirman Nasir, Muhammad Syafar, Lalu Muhammad Saleh, Nurhaedar Jafar*
265. The Effect of Massage Therapy Method, Therapy Duration and Injuries on the Reduction of Pain in Knee Ijuries . 1560  
*Arif Setiawan, Soegiyanto, Tri Rustiadi, Rumini*

266. Familial Phenotype of Waardenburg Syndrome in One Family: A Case Series.....1569  
*Eka Savitri, Indra Irawan, Habibah S. Muhiddin, Fadly*
267. Test Instrument Model Talk Athletes for Martial Branch Sports of Tarung Derajat.....1577  
*Ipang Setiawan, Soegiyanto, Mugiyo Hartono, Tri Rustiadi*
268. The Effect of Health Services, Supervisory and Team Orientation, Personnel Development and Tolerance of Error on Job Satisfaction Head of Health Centre in South Sulawesi Province.....1586  
*Wardiah Hamzah, Suryanto, Oedojo, Sukri Palutturi, Nasruddin Syam*
269. Basic Movement Standardization of the Pathol Sarang Martial Sport.....1591  
*Putra Budi Kutniawan, Tandiyo Rahayu, Heny Setyawati, Mugiyo Hartono*
270. Legal Constraints on the Enforcement of Covid-19 Health Protocol in Indonesia .....1601  
*Husni, Mahdi Syahbandir, Muhammad Ya'kub Aiyub Kadir, Teuku Ahmad Dadek*
271. Multipurpose Training Tool Development Branch of Artistic Gymnastics.....1612  
*Tubagus Herlambang, Tandiyo Rahayu, Sulaiman, Tri Rustiadi*
272. Management of Occupational Hygiene Therapy on the Ability to Perform Self-Care on Deficient Self-Care Patients Who are Cared for in RSKD, South Sulawesi Province.....1621  
*Syahrir, Fatmawati*
273. The Effect of Massage Therapy Method, Inventory Levels and Stress Levels on Kinase Creatine Levels.....1627  
*Zainul Aziz, Soegiyanto, OktiaWoro K. Handayani, Mugiyo Hartono*
274. Detection of Anti-GAD65 Antibodies in Sera of Diabetic Patients Using a Home-Made Latex Agglutination Kit.. 1636  
*Alaa S. Alattabi, Dhamiaa M. Hamza, Khalid Khalil Alaaraji, Sawsan M. Jabbar, Abeer Thaher Naji AL-Hasnawi, Ali Mansoor Jasim*
275. Effect of Polycythemia on Serum Lipid Profile and Oxidative Stress.....1640  
*Zainab Qasim, Muhammad Al-Yasiri*
276. The Significance of Serum Albumin Level as an Indicator for Severity of Hypertensive Disorders in Pregnancy in Samawa City.....1650  
*Wurood Mahdi Sale, Ryam Falih, Ayat Mohammad*
277. Real-Time-PCR Assay Based on Phosphoglycerate Kinase Gene for Detection of *Entamoeba histolytica* Trophozoites in Stool Samples in Holy Karbala, Iraq.....1656  
*Dhamiaa Maki Hamza, Saba Fadhil Ali Malaa, Khalid Khalil Alaaraji*
278. Determining the Endpoint of Sediment Titrations by Smartphones.....1665  
*Muhaned Mohammed Eteya*
279. Deleted
280. Mammogenesis Effect of Hot Aqueous Extract of *Mentha spicata* Leaves on Mammary Tissue of Ovariectomized Rabbits.....1677  
*Sinaa Jaboury Al-Bazii, Ashwaq Kadhem Obeid, Rana Majeed Hameed*

281. Treatment of Postpartum Metritis in Dairy Cattle .....1686  
*Audaisabah Asker, Ammar Rahem Mansoor, A.A. Omar, A.F. Majeed*
282. Human Rights and Legal Protection of Persons with Disabilities in Aviation Industry in Indonesia .....1689  
*Adya Paramita Prabandari, Elfia Farida, Rahayu*
283. Preparation and Identification of Metal Ions Complexes for 4-(P-Phenyl azo sulfonic acid)-1-Naphthol Dye..1694  
*Haider S. Mohammed, Shaimaa H. Mallah*
284. The Effectiveness of 7 Counselor Contacts in Health Facility at the First Level to Increase Exclusive Breastfeeding Coverage in Tangerang.....1700  
*Marthia Ikhlasiah, Atnesia Ajeng, Ika Oktaviani*
285. Survey of Registered Nurses Working in the Metropolitan Hospitals on Bullying Experiences at Workplace in South Korea .....1706  
*Kwang Ok Lee*
286. Right to Life of a Child in India: An Overview .....1711  
*Arunima Mishra, Smita Satapathy*
287. Influences of Mothers' Parenting Attitude, Parenting Efficacy, and Stress Levels on Children's Social Skills.1716  
*Kwang Ok Lee, Hyun Ju Chae*
288. Relationships between Body Image Perception and Body Esteem and Sexual Assertiveness of Female College Students: Comparison of Nursing Students and Non-nursing Students.....1721  
*Hyun Ju Chae, Kwang Ok Lee*
289. Study of Multiple Genotypes in the *XPD* gene for A/C Lys751Gln and Lung Cancer in Samples from Baghdad–Iraq.....1727  
*Maiss Adnan Al-Ward, Mohammed Mahdi Jawad*
290. Assessment of Risk Factors of Asthma in Health Institutions in Maysan Governorate, Iraq .....1732  
*Ali Abdulwahed AbdulJabbar, Buthaina Ateyah Rashid*
291. Application of Care Bundle Approach for Preventing Device Associated Infections: A Training Program for Pediatric and Neonatal Nurses.....1744  
*Amal M. Ibrahim, Safy S. Al-Rafay, Hyam R. Tantawi*
292. Effects of Modified-Continuous Ambulatory Peritoneal Dialysis (CAPD) Patient's Handling Process on Nurse's Knowledge, Perceived Benefits and Performance in CAPD Care .....1752  
*Prichavijy Promjak, Samlee Plianbangchan, Ratana Somrongthong, Wongs Laohasiriwong*
293. Harmonization Over the Regulations of Electronic Medical Records and its Potential to be Abused .....1760  
*Maskun, Rian Nugraha, Hasbi Assidiq, Muhammad Tayyib, Armelia Syafira*

# Psychometric Validation of the Maslach Burnout Inventory (MBI) Adapted to Moroccan Teachers

Abdeslam Amri<sup>1</sup>, Zakaria Abidli<sup>2</sup>, Mounir Bouzaaboul<sup>1</sup>,  
Ziri Rabea<sup>1</sup>, Ahmed Omar Touhami Ahami<sup>1</sup>, Abdelmajid Soulaymani<sup>2</sup>

<sup>1</sup>Laboratory of Cognitive Behavioral Neuroscience and Applied Nutrition, Faculty of Science. Faculty of Sciences, Ibn Tofail University, Kenitra, Morocco, <sup>2</sup>Laboratory of Genetics and Biometrics, Faculty of Sciences, Ibn Tofail University, Kenitra, Morocco

## Abstract

**Introduction:** The literature on burnout research shows that more than 90% have used the Maslach Burnout Inventory (MBI).

**Objective:** The aim is to establish the psychometric properties in terms of reliability, sensitivity and validity of the Maslach Burnout Inventory (MBI) and to adapt it to the context of Moroccan teachers.

**Method:** This work was carried out through a process of translation and reverse translation of the original instrument by adapting the elements to the teaching profession. To determine the psychometric characteristics, we used Cronbach's alpha to determine reliability, exploratory factor analysis to extract factors and determine dimensionality, and confirmatory factor analysis to test the validity of the statistical model. Validation of the instrument was carried out on a sample of 170 teachers working in public schools in Ouezzane region (Morocco).

**Results:** Items 4, 5, 7, 9, 12, and 22 were relatively incoherent with respect to the other items, they were eliminated. The factorial analysis made appear three factors whose are explain 58.22% of the total variance. Cronbach's  $\alpha$  for the whole questionnaire (0.761), for emotional exhaustion (0.819), depersonalization (0.850) and sense of personal accomplishment (0.785). The confirmatory factor analysis (CFA) showed satisfactory adjustment indices ( $\chi^2 = 164,938$  -  $df = 101$  -  $CFI = .937$  -  $TLI = .915$  -  $RMSEA = .037$  -  $P$  close = .984).

**Conclusion:** We propose to use Maslach's Theoretical Model for the Moroccan Sample in Future Research on the burnout of Moroccan teachers.

**Keywords:** Psychometric, Validation, Maslach Burnout Inventory, Moroccan, Teachers.

## Introduction

Burnout is a chronic response to emotional and interpersonal stressors in work that is exhausting,

cynical and ineffective<sup>1</sup>. It manifests itself in three forms: emotional exhaustion, depersonalization and the loss of the sense of personal accomplishment<sup>2</sup>. These three components are represented in the Maslach Burnout Inventory (MBI), whose success of his versions increases<sup>3</sup>. However, psychometric comparisons of MBI note both similarities and differences between several cultures<sup>4,5</sup> and cross-cultural comparisons of teacher burnout have yielded mixed results. For this reason, it is interesting to produce a diagnostic tool for professional burnout that is valid and specific to the cultural context of teachers in order to manage the risk that threatens the

---

### Corresponding Author:

**Abdeslam Amri**

Laboratory of Cognitive Behavioral Neuroscience and Applied Nutrition. Faculty of Science. Faculty of Sciences, Ibn Tofail University, Kenitra, Morocco  
e-mail: abdeslam.amri@uit.ac.ma

psychological health of these resources, which play a main role in the development of society<sup>6</sup>.

In Morocco, there is no tool for assessing burnout valid and adapted to the context of teachers. For this reason, the objective of this research is to establish the psychometric validity of an Arabic translation of MBI based on empirical research and to provide a validated translation of the MBI specific to Moroccan teachers.

## Material and Method

### A. Measuring Instrument: Maslach Burnout Inventory MBI Questionnaire:

The MBI is composed of 22 questions that explore three scales: emotional exhaustion (9 items), depersonalization (5 items), and the sense of personal accomplishment (8 items)<sup>7</sup>.

#### 1. Response modalities and quotation:

The answers are given on a 7-point scale from “never” to “every day”.

- **Emotional Exhaustion (EE)** is assessed by adding items: 1, 2, 3, 6, 8, 13, 14, 16 and 20 (result between 0 and 54),
- **Depersonalization (DP)** by adding items 5, 10, 11, 15 and 22 (result between 0 and 30).
- **Personal Accomplishment (PA)** by adding the items: 4, 7, 9, 12, 17, 18, 19 and 21 (result between 0 and 48)<sup>7</sup>.

#### 2. Translation of the questionnaire:

The translation of the MBI was done by two bilingual individuals working in the field of education, in collaboration with colleagues and specialists in the field of education to make the questionnaire specific to teachers. A review was conducted following the comment analysis after the administration of the questionnaire to a pilot group of 20 teachers working in the public education sector.

### B. Sample:

The validation of the instrument was carried out with a sample of 170 teachers working in public educational institutions belonging to the management of Ouezzane (Morocco). 37.6% (n = 64) female and 62.3 % (n = 106) male. The mean age is 38.3 ± 8.9 years.

### C. Statistical analyses:

The approach recommended by Anderson and Gerbing (Anderson J, 1988)<sup>8</sup> to do a sequential analysis was adopted. The reliability of the instrument was examined by calculating the

Cronbach’s  $\alpha$  coefficient for the three dimensions of the inventory. Then the data were subjected to an Exploratory Factor Analysis (EFA) to extract the factors and test the dimensionality of the questionnaire. The factor structure was studied by performing a principal component analysis (PCA) and varimax rotation. The Kaiser - Meyer - Olkin (KMO) measurement was calculated to assess the adequacy of the sampling. Ideally, the KMO should be greater than 0.60. The internal coherence of the global scale and the dimensions retained after rotation were evaluated using the Cronbach  $\alpha$ .

For the adequacy of the model, we used different adjustment indices: the index square root approximation error of Steiger Lind (RMSEA), the normalized adjustment index (NFI), the Tucker - Lewis index (TLI), the comparative adjustment index (CFI) and P close. These indices are interpreted according to critical thresholds<sup>9</sup>.

In general, values below 0.05 and 0.08 for the RMSEA are considered to indicate good and acceptable data adequacy respectively. The CFI and TLI should be greater than 0.9. The Pclose must be close to 1; the fit of the model is considered good when critical thresholds and listed standards are met. The statistical analyses were performed under SPSS 21 and AMOS 20.

## Results

### 1. Internal consistency of theoretical dimensions and deletion of items:

Using Nunnally’s classification, which normally accepts Cronbach’s  $\alpha$  index above 0.70<sup>10</sup>, the removal of items 4 and 12 from the entire scale increased this index from 0.68 to 0.75.

For depersonalization, the deletion of items 22 and 5 allowed Cronbach’s  $\alpha$  to increase from 0.67 to 0.76. For the sense of personal accomplishment, the elimination of items 9 and 7 allowed Cronbach’s  $\alpha$  to increase from 0.63 to 0.77. Items 4, 5, 7, 7, 9, 12, and 22 were therefore relatively incoherent with respect to the other items, so we decided to eliminate them from further analysis.

### 2. Exploratory Factor Analysis (EFA):

The factorial analysis in principal axes with varimax rotation made appear three factors whose eigen values are greater than 1 and explain 58.22% of the total variance. The three dimensions are well defined and distinct on their respective factors; Thus, the first factor, which includes six items (1, 2, 3, 3, 6, 8, 14) constituting the emotional exhaustion dimension,



explains 37.05% of the total variance. the second, with six items (10,11,13,13,15,16,20) constituting the depersonalization dimension explains 13.79% of the total variance and the third with four items (17,18,19,21) constituting the personal achievement dimension, explains 7.37% of the total variance (Table 1).

**Table 1: Matrix of components after rotation, percentages of explained variance and Cronbach's  $\alpha$  of the three dimensions of the Maslach Burnout Inventory specific to Moroccan Teachers.**

	Dimensions		
	EE	DP	AP
QI1	,72		
QI2	,79		
QI3	,57		
QI6	,72		
QI8	,65		
QI14	,66		
QI10		,71	
QI11		,69	
QI13		,71	
QI20		,59	
QI15		,80	
QI16		,55	
QI17			,75
QI18			,79
QI19			,73
QI21			,75
Cronbach's $\alpha$ .	0,81	0,85	0,79
% of the explained variance	37,05	13,79	7,38
% of total variance explained	58,22		
Precision measurement of Kaiser-Meyer-Olkin sampling (KMO)	0,88		
<b>Bartlett sphericity test:</b>			
Chi-square approximate	1096,95		
Df	120		
Significance of Bartlett	<b>0.000</b>		

EE: Emotional exhaustion, DP: Depersonalization, PA: Sense of personal accomplishment

In view of these results, the translation and application of the MBI in Arabic to a sample of Moroccan teachers

keeps the dimensionality of the original construct. Cronbach's  $\alpha$  on the global scale (0.761) as well as those for emotional exhaustion (0.819), depersonalization (0.850) and sense of personal achievement (0.785) are acceptable (Table 1).

**3. Analysis of the structure of the dimensions and sensitivity of the Maslach Burnout Inventory specific to Moroccan Teachers:** In order to clarify the existing relationships between the dimensions of the Maslach Burnout Inventory specific to Moroccan Teachers, the score for each dimension was calculated. Depersonalization (DP) and emotional exhaustion (EE) scores are positively correlated with each other, and negatively correlated with personal achievement (PA) scores, confirming the results of the MBI theoretical model. Similarly, to test the sensitivity gender and age variance analyses were conducted. The matrix of correlations between the three sub-dimensions and the age and gender variables shows the sensitivity of this 16-item questionnaire (Table 2)

**Table 2: Means, standard deviations, correlations between the dimensions of the Maslach Burnout Inventory specific to Moroccan Teachers and between these dimensions and age and gender variables.**

Variables	Means	Standard deviation	EE	DP	AP
EE	21,73	9,18			
DP	13,62	10,01	,61**		
AP	15,05	6,51	-,21**	-,445**	
Age	38,30	8,92	,16*	,04	,01
Gender			-,21**	-,28*	,05

\*\* The correlation is significant at level 0.01 (bilateral).\* The correlation is significant at level 0.05 (bilateral).

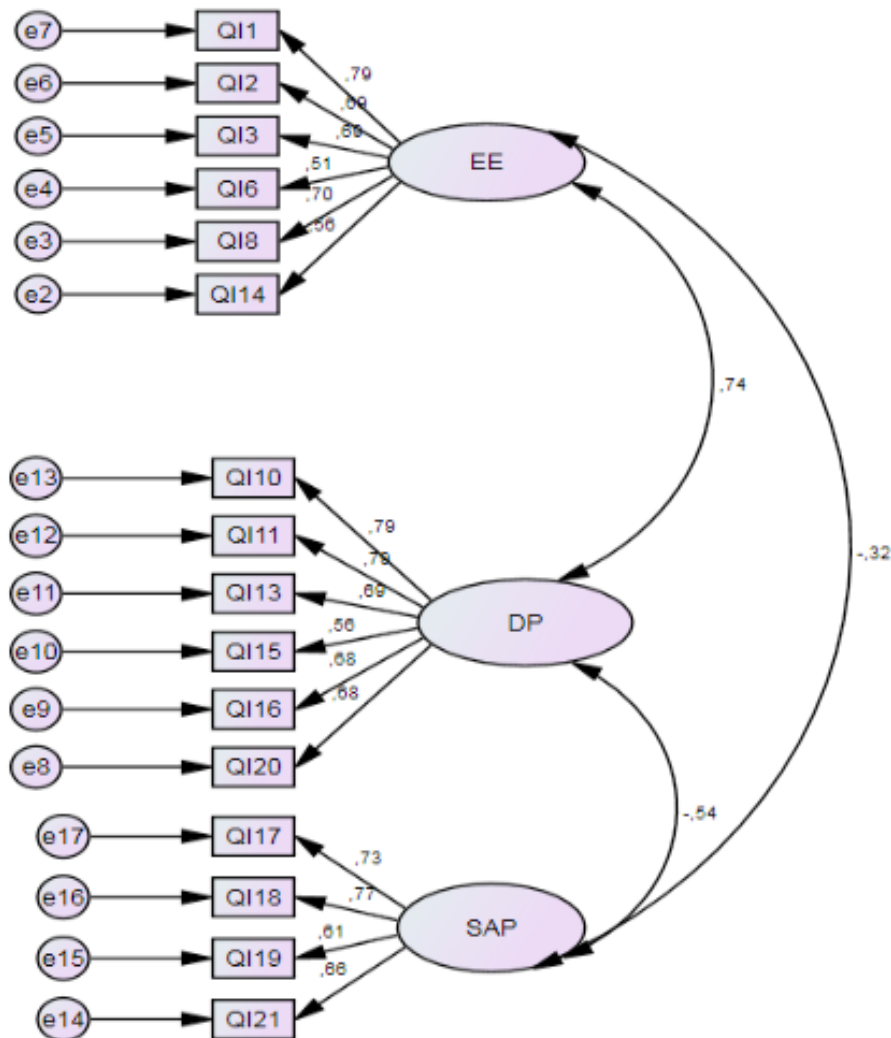
**4. Confirmatory Factor Analysis:** Finally, by respecting the quality of the adequacy indices of the Schermelleh-Engel, Moosbrugger & Muller model (Schermelleh-Engel K, 2003)<sup>9</sup>, the Confirmatory Factor Analysis (CFA) carried out on the data of our sample showed that our tested three-dimensional model presents satisfactory adjustment indices.  $\chi^2 = 164.94$ ;  $DF = 101$ ;  $0 \leq \chi^2 \leq 2df$ ;  $RMSEA = 0.03$ ;  $CFI = 0.93$  above the critical threshold of 0.9 and the P close of 0.98 is very close to 1 (Table 3).

**Table 3: Quality thresholds of the model’s adequacy indices According to Schermelleh, Engel, Moosbrugger & Muller 9**

Indices	Model	Thresholds of acceptability	
		Good adequacy	Acceptable adequacy
X2	164,93	$0 \leq X2 \leq 2df$	$2df < X2 \leq 3df$
Df	101	$0 \leq 164,938 \leq 202$	
CFI	0,93	CFI $\geq 0,90$	
RMSEA	0,03	$0 \leq RMSEA \leq 0,05$ $0 \leq 0,037 \leq 0,05$	$0,05 < RMSEA \leq 0,08$
P close	0,98	$0,10 < p \leq 1$ $0,10 < 0,984 \leq 1$	$0,05 \leq p \leq 0,10$

In view of this table, our model shows a good adequacy with the observed data, which allows us to formulate the validation of the three-dimensional character of the MBI translated into Arabic specific to

Moroccan teachers. The 16-item Moroccan version specific to MBI teachers proposed by this research is therefore a validated structure.



**Figure 1: Confirmatory Factorial Analysis (CFA) performed by the maximum likelihood estimation method. MBI-ESM three-factor model (16 items). (X2 = 164,938 - df = 101- CFI = .937 - TLI = .915 - RMSEA = .037- P close = .984.**

## Discussion

The objective of this study was to construct and test the factor structure, internal reliability, sensitivity and validity of a scale of measurement translated into Arabic of professional burnout for Moroccan teachers, designed according to Maslach's three-dimensional theoretical model. The 16-item tool was validated on a representative sample of teachers from the Ouezzane exercising in northern Morocco, using a sequential analysis (internal coherence, EFA and CFA). Several validation tests have shown the inconsistency of some theoretical items of the 22-item MBI with the characteristics of the samples studied, which forced the researchers to exclude certain items to improve their model. Ellenge Denton and al, in the United States of America and Jamaica, had excluded 10 items, the teacher-specific version was validated at 12 items<sup>11</sup>. Aluja and al, in Spain, had excluded five items; the teacher-specific version for them was validated at 17 point<sup>12</sup>. Concerning our study, we excluded the items 4, 5, 7, 9, 12, and 22, and we kept a 16-item model. This inconsistency of these items could be explained by the characteristics of the teaching profession, the Moroccan language and culture. This confirms Wheeler's idea that further studies are needed on item-level analyses to explain the divergent results across occupations, languages and cultures<sup>13</sup>. The exploratory factorial analysis has retained the three dimensions for the 16-item MBI-ESM, which is consistent with several studies

like those of Byrne and al in Canada<sup>14</sup>, Yadama GN and Drake B in China<sup>15</sup>, and Boles JS and al in the United States<sup>16</sup>. This study reveals a deviation from items 13, 16 and 20, which are theoretically associated with emotional exhaustion in the initial version, towards depersonalization. This deviation of theoretical items from one dimension to another has been observed in Abu-Hilal's study in 2018<sup>17</sup>. Confirmatory Factor Analysis (CFA) confirmed the validity of the 16-item MBI specific to Moroccan teachers with very satisfactory data adjustment indices ( $X^2 = 164.938$  -  $df = 101$  -  $CFI = 0,937$  -  $TLI = 0.915$  -  $RMSEA = 0.037$  and  $P \text{ close} = 0.984$ ). This valid instrument is proposed for the evaluation of burnout among Moroccan teachers in future research. Concerning internal consistency, MBI-ES reliability analyses through studies systematically give Cronbach's alphas that vary between 0.8 and 0.9 for emotional exhaustion (EE), between 0.50 and 0.79 for depersonalization (DP), and between 0.69 and 0.82 for personal achievement (AP)<sup>12</sup>. For this study, Cronbach's alphas on the global scale (0.761) as well as those of emotional exhaustion (0.819), depersonalization (0.850) and sense of personal accomplishment (0.785) are satisfactory and comparable to those reported in several versions, indeed, the Cronbach alpha value of emotional exhaustion (0.819) is goobut remains lower than that of several studies. On the contrary, the depersonalization rate (0.850) is higher (Table 4).

**Table 4: Cronbach's Alpha of the different dimensions of MBI-ES according to different studies. DPS: Depersonalization towards students. DPJ: Depersonalization towards work**

Studies	Teaching cycle	Cronbach's Alphas of the different dimensions of MBI-ES			
		EE	DP	AP	
Maslach & Jackson (1986) <sup>7</sup>	Primary school	0,90	0,79	0,76	
Fernando & Perez (1996) <sup>18</sup>	Primary and secondary	0,88	0,61	0,82	
Won sunchen & al (2014) <sup>19</sup>	-	0,91	0,78	0,78	
Abu hilal & al (2018) <sup>17</sup>	Primary and secondary	0,87	DPS 0,47	DPJ 0,79	0,76
Our study (2019)	Primary and secondary	0,81	0,85	0,78	

## Conclusion

The results of the factors analysis of our study corroborate of Maslach's theoretical model, and a 16-item MBI model with better adjustment indices, demonstrating high conceptual validity, was proposed for use in the research of the psychological assessment of Moroccan teachers' burnout.

**Conflict of Interest:** The authors declare that there are no conflicts of interest.

**Ethical Approval:** The procedures were carried out in accordance with the recommendations of the internal Ethics Committee of the Ibn Tofail University Kenitra. This procedure were examined and approved by the Committee.

**Source of Funding:** This work is not financial.

### Reference

1. Maslach C, Schaufeli WB, Leiter MP. Job Burnout. *Annu Rev Psychol.* 2001;52(1):397422.
2. Maslach, C., & Jackson, S. E. Burnout in organizational settings. *Applied Social Psychology Annual*, 1984: 5, 133-153.
3. Antoniou A-S, Ploumpi A, Ntalla M. Occupational Stress and Professional Burnout in Teachers of Primary and Secondary Education: The Role of Coping Strategies. *Psychology.* 28 mars 2013;04:349.
4. Abu-Hilal MM, el-Emadi AA. Factor structure and reliability of burnout among Emirati and Palestinian teachers. *Psychol Rep.* oct 2000;87(2):597610.
5. Richardsen AM, Martinussen M. Factorial validity and consistency of the MBI-GS across occupational groups in Norway. *Int J Stress Manag.* 2005;12(3):28997.
6. FannyMollard and Morgana Vecchia . Bachelor's thesis in pre-school and primary education. - PDF [Internet]. [cited May 26, 2019]. Available on: <https://docplayer.fr/116230681-Bachelor-professional-membrance-in-school-primary-and-primary-fanny-mollard-and-organic-vecchia.html>
7. Maslach, C., & Jackson, S. E. Burnout in organizational settings. *Applied Social Psychology Annual*, 1984: 5, 133-153.
8. Anderson J, Gerbing DW. Structural Equation Modeling in Practice: A Review and Recommended Two-Step Approach. *Psychol Bull.* 1 janv 1988;103(3):41123.
9. Schermelleh-Engel K, Moosbrugger H, Müller H. Evaluating the Fit of Structural Equation Models: Tests of Significance and Descriptive Goodness-of-Fit Measures. *Method Psychol Res.* 2003;8(2):2374.
10. Nunnally JC (1978). *Théoriepsychométrique*, 2nd Edn. New York, NY: McGraw-Hill.
11. Denton E, Chaplin WF, Wall M. Teacher Burnout: A Comparison of Two Cultures Using Confirmatory Factor and Item Response Models. *Int J Quant Res Educ.* 2013;1(2):14766.
12. Aluja A, Blanch A, García LF. Dimensionality of the Maslach Burnout Inventory in School Teachers: A Study of Several Proposals. *Eur J Psychol Assess.* 2005;21(1):6776.
13. Wheeler DL, Vassar M, Worley JA, Barnes LLB. A Reliability Generalization Meta-Analysis of Coefficient Alpha for the Maslach Burnout Inventory. *EducPsychol Meas.* 1 févr 2011; 71(1):23144.
14. Byrne BM. The Maslach Burnout Inventory: Testing for factorial validity and invariance across elementary, intermediate and secondary teachers. *J Occup Organ Psychol.* 1 sept 1993;66(3):197212.
15. Yadama GN, Drake B. Confirmatory factor analysis of the Maslach Burnout Inventory. *Soc Work Res.* sept 1995; 19(3):18492.
- 16] :Boles JS, Dean DH, Ricks JM, Short JC, Wang G. The Dimensionality of the Maslach Burnout Inventory across Small Business Owners and Educators. *J VocatBehav.* 1 janv 2000;56(1):1234.
17. Maher Abu-Hilal, Said Al dafri, Hashem Kilani, Ali Kazem, Ibrahim Qaryouti, & Hussein AlKharusi. Structure of Burnout among Omani Male and Female Teachers: Invariance of Structure across Gender. *Journal of Educational and Psychological Studies - Sultan Qaboos University.* 2018. 12; 739-749
18. Fernando, J., & Perez, J. Un instrumento para medir que mazon profesional en los Docentes : Adaptation Catalonia del Maslach Burnout Inventory (MBI) an instrument to evaluate professional burnout in teachers: Catalanian adaptation of the MBI .*Rivista de Ppsiatria de la facultad de medecine de la universidad de Barcelona.* 1996.23;11-18.
19. Won Sun Chen .Translation, Cross-cultural Adaptation and Validation of the Malay Version of the Maslach Burnout Inventory (MBI) in Malaysia; *International Journal of Social Science Studies.* 2014;2:2324-8041.

# COVID 19: Evaluate of Liver and Renal Function Tests in Iraqi Patients

Abdullah Ali Mohammed<sup>1</sup>, Mahmood Nazar Mustafa<sup>2</sup>, Sura A. Abdulsattar<sup>3</sup>, Ahmed Salam Al-zaidi<sup>4</sup>

<sup>1</sup>Assistant Lecturer (M.Sc.) Department of Chemistry and Biochemistry, <sup>2</sup>Assistant Lecturer (M.Sc.) Department of Pathology and Forensic Medicine, University of Fallujah, College of Medicine, Iraq, <sup>3</sup>Prof. Dr. (PHD) Department of Chemistry and Biochemistry, Mustansiriyah University, College of Medicine, Iraq, <sup>4</sup>(M.Sc.) Department of Medical Analysis, Al-Furat General Hospital, Iraq

## Abstract

The clinical features of COVID-19 are varied, ranging from asymptomatic state to acute respiratory distress syndrome and multi organ dysfunction. We aim to evaluate renal and liver functions of patients with COVID 19. Laboratory results were obtained from 107 patients with laboratory-confirmed COVID-19 who were admitted to the only Al-Furat General Hospital in Baghdad, Iraq from March 3 to June 9, 2020 and followed up until recovery. Normal levels of renal functions were presented. Meanwhile elevated levels of alanine aminotransferase (ALT) was observed in 10% and of aspartate aminotransferase (AST) was observed in 40% of patients with COVID 19, yet on comparison of the results at entering with at recovery it was observed significant differences ( $p < 0.01$ ) of all patients. From these findings we conclude that the virus might be responsible for systemic inflammation.

**Keyword:** COVID 19; liver enzyme; urea; creatinine; AST, ALT.

## Introduction

On 7 January 2020, a novel coronavirus was identified in the throat swab sample of one patient by the Chinese Center for Disease Control and Prevention (CDC), and was subsequently named as 2019nCoV by World Health Organization (WHO)<sup>1,2</sup>. The virus was identified as a coronavirus that had >95% homology with the bat coronavirus and > 70% similarity with the SARS- CoV. Environmental samples from the Huanan sea food market also tested positive, signifying that the virus originated from there<sup>3</sup>. The number of cases started increasing exponentially, some of which did not have exposure to the live animal market, suggestive of the fact that human-to-human transmission was

occurring (2020)<sup>4</sup>. All ages are susceptible. Infection is transmitted through large droplets generated during coughing and sneezing by symptomatic patients but can also occur from asymptomatic people and before onset of symptoms<sup>5</sup>. The clinical features of COVID-19 are varied, ranging from asymptomatic state to acute respiratory distress syndrome and multi organ dysfunction. The common clinical features include fever (not in all), cough, sore throat, headache, fatigue, headache, myalgia and breathlessness<sup>6</sup>. Some patients with COVID-19 pneumonia also present with kidney injury, and autopsy findings of patients who died from the illness sometimes show renal damage. However, little is known about the clinical characteristics of kidney-related complications, including hematuria, proteinuria, and AKI<sup>7</sup>. Recently, there has been some insight into the impact of COVID-19 on other organs, as a number of reports have indicated that more than half of patients with COVID-19 showed varying levels of liver disease<sup>8</sup>. The median time from onset of symptoms to dyspnea was five day, hospitalization seven day and acute respiratory distress syndrome (ARDS) eight day. The need for intensive care admission was in 25–30%

---

### Corresponding Author:

**Abdullah Ali Mohammed**

Assistant Lecturer (M.Sc.) Department of Chemistry and Biochemistry, University of Fallujah, College of Medicine  
abdullah

e-mail: medical@yahoo.com

of affected patients in published series. Complications witnessed included acute lung injury, acute cardiac injury, shock and acute kidney injury. Recovery started in the 2nd or 3rd wk<sup>9</sup>. The various diagnosis method such as serological, molecular, and radiological can help the health centers in the detection of SARS-CoV-2; radiological and serological techniques are the best method among the others and the radiological method is the most preferred one, able to diagnose the infection quickly and accurately with fewer false-negatives<sup>10</sup>. Liver impairment has been reported as a common clinical manifestation in patients with SARS-CoV infection, even if not a prominent feature of the illness<sup>11,12</sup>.

### Material and Method

This was a cross-sectional study, we analyzed biochemical data from electronic medical records of 107 hospitalized patients of Al-Furat General Hospital from Baghdad with COVID-19 (65 male and 42 female) for period (march 3 to June 9,2020). The data analysis included urea, creatinine, ALT, AST, and ALP twice: first at entering the hospital (group A) and second at recovery (group B).

**Statistical Analysis:** Continuous data were expressed as mean and standard deviation (SD). For the variables, paired test was employed to analyse the difference. All statistical analyses were performed using the SPSS 20.0 (SPSS Inc) software package. A (P value of < 0.05) was considered statistically significant.

### Results and Discussion

The current evidence indicates that infection rates of COVID 19 are higher in male than in female (Figure 1), where 61 % (65 among 107) was male and 39 % (42 among 107) was female.

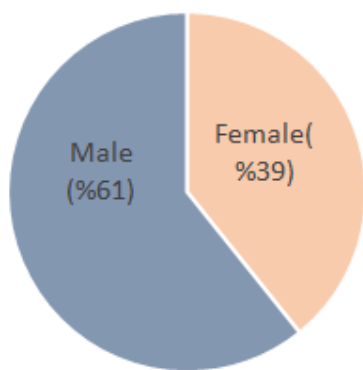


Figure 1: Covid 19 distribution among gender

The current results of COVID 19 distribution among age as shown in Figure 2 indicated that the most affected ages are between (20-40 year). The lowest affected ages was less than 20 year.

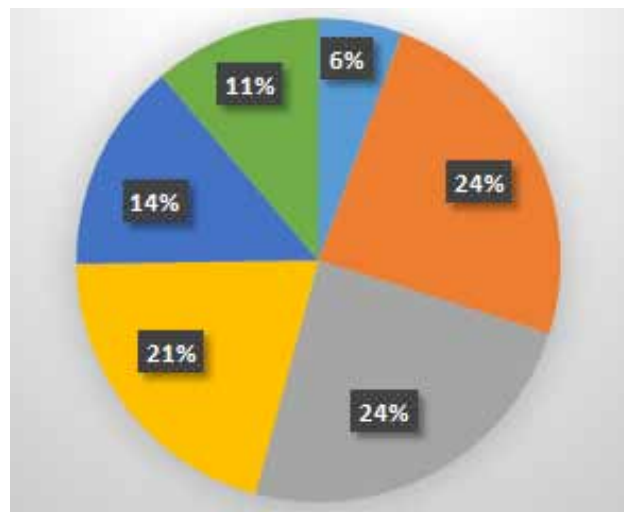


Figure 2: Covid 19 distribution among age where 6% : patients with age <20 year, 24% : patients with age range (21-30 year) & (31-40 year) respectively, 21%: patients with age range(41-50 year), 14%:: patients with age range (51-60year), and 11% : patients with age (61-70 year).

The results presented in Table 1 shows the levels of urea, creatinine, AST, ALT and ALP in sera of COVID 19 patients over two periods: the first when entering the hospital (group A) and the second when recovery (group B). Levels of urea, creatinine, AST, ALT and ALP were showed within normal level, however there were a highly significant differences (p<0.01) between groups in urea, creatinine, AST in both male and female patients .While the results of ALT indicated highly significant differences (p<0.01) only in male patients. For ALP the results of male indicated highly significant differences (p<0.01) and for female the result showed significant differences (p<0.05). In more detail the results indicted elevated levels of AST in 40% patients and of ALT in 10% patients, while no elevated levels of ALP was observed.

**Table 1: The levels of urea, creatinine, AST, ALT and ALP in sera of COVID 19 patients**

Parameter	Gender	Mean $\pm$ SD Group A	Mean $\pm$ SD Group B	P value
Urea (mmol/L)	Male	4.29	3.48	0.00
	Female	4.33	3.21	0.00
Creatinine (mmol/L)	Male	74.58	69.67	0.00
	Female	72.78	68.47	0.00
AST (U/L)	Male	45.96	36.26	0.00
	Female	45.7857	36.1429	0.00
ALT (U/L)	Male	36.41	28.83	0.00
	Female	26.2381	24.2143	0.106
ALP ( $\mu$ kat/L)	Male	81.63	76.10	0.00
	Female	84.6667	76.7143	0.015

Although available sex-disaggregated data for COVID-19 show equal numbers of cases between sexes, current study indicates that infectious rates are higher in male than in female, and that may be due to sex hormone that contribute to different immunologic responses in men and women: As a general rule, estrogens promote both innate and adaptive immune responses, which result in faster clearance of pathogens and greater vaccine efficacy<sup>13</sup>. Conversely, testosterone has largely suppressive effects on immune function, which may explain the greater susceptibility to infectious diseases observed in men<sup>14</sup>. Notably, changes in sex hormone may further shape the immune response to pathogens<sup>14</sup>. Sex-related biological data may also be critical to investigate the contribution of sex hormones in inflammatory response. In particular, reduction in testosterone levels in aging men has been associated with increased proinflammatory cytokine levels<sup>14</sup> which may contribute to worse COVID-19 progression in older men. Sex differences in disease progression may also be linked to estrogen-induced decreased expression of angiotensin-converting enzyme 2<sup>15</sup>. Pre-print studies are conflicting as to whether ACE2 expression in lung tissue is different between sexes<sup>16,17</sup>. Some patients with COVID-19 pneumonia also present with kidney injury, and autopsy findings of patients who died from the illness sometimes show renal damage<sup>7</sup>. In meta-analysis study of Zhu j et al indicated that some patients with COVID 19 (25.5%) presented elevated levels of renal functions<sup>18</sup>. The results of current study indicated that all patients presented normal levels of renal functions. However on comparison of the results at entering with at recovery it was observed significant differences ( $p < 0.01$ ).

Patients with abnormal liver tests were at increased risk of progressing to severe disease. The detrimental effects on liver injury mainly related to certain medications used during hospitalization, and should be monitored and evaluated frequently<sup>18</sup>.

### Conclusion

Elevated levels of alanine aminotransferase (ALT) was observed in 10% and of aspartate aminotransferase (AST) was observed in 40% of patients with COVID 19, yet on comparison of the results at entering with at recovery it was observed significant differences ( $p < 0.01$ ) of all patients. As AST is not specific for liver damage, which indicated that the systemic inflammation induced by the virus might be responsible for these findings not related to certain medication.

**Conflict of Interest Statement:** All authors declare that they have no conflict of interest.

**Source of Funding:** Self

**Ethical Clearance:** Taken from Al-Furat general hospital-Iraq.

### References

1. Huang C, Wang Y, Li X, Ren L, Zhao J, Hu Y, Zhang L, Fan G, Xu J, Gu X, Cheng Z, Yu T, Xia J, Wei Y, Wu W, Xie X, Yin W, Li H, Liu M, Xiao Y, Gao H, Guo L, Xie J, Wang G, Jiang R, Gao Z, Jin Q, Wang J, Cao B. Clinical features of patients infected with 2019 novel coronavirus in Wuhan, China. *Lancet*. 2020; 395:497–506.

2. Chen N, Zhou M, Dong X, Qu J, Gong F, Han Y, et al. (2019), Epidemiological and clinical characteristics of 99 cases of novel coronavirus pneumonia in Wuhan, China: a descriptive study. *Lancet*. 2020;395:507–513.
3. Xinhua. China's CDC detects a large number of new coronaviruses in the South China seafood market in Wuhan.2020; Available at: [https://www.xinhuanet.com/2020-01/27/c\\_1125504355.htm](https://www.xinhuanet.com/2020-01/27/c_1125504355.htm).
4. Liu J, Shu YL, and Zhou XN. Transmission patterns and control of COVID-19 epidemic. *Indian Journal of plant physiology* .2020; 9:112.
5. Rothe Camilla, Schunk Mirjam, Sothmann Peter, Bretzel Gisela, Froeschl Guenter, Wallrauch Claudia, Zimmer Thorbjörn, Thiel Verena, Janke Christian, Guggemos Wolfgang, Seilmaier Michael, Drosten Christian, Vollmar Patrick, Zwirgmaier Katrin, Zange Sabine, Wölfel Roman, Hoelscher Michael. Transmission of 2019-nCoV Infection from an Asymptomatic Contact in Germany. *New England Journal of Medicine*. 2020;(10):970–971.
6. Singhal T..A Review of Coronavirus Disease-2019 (COVID-19). *Indian J Pediatr*.2020; 87(4): 281–286.
7. Guangchang Pei, Zhiguo Zhang, Jing Peng, Liu Liu, Chunxiu Zhang, Chong Yu, Zufu Ma, Yi Huang, Wei Liu, Ying Yao, Rui Zeng, Gang Xu. (2020 Apr 28),Renal Involvement and Early Prognosis in Patients with COVID-19 Pneumonia. *J Am Soc Nephrol*. 2020;31(6):1157-1165
8. Cai Q, Huang D, Yu H, Zhu Z, Xia Z, Su Y, Li Z, Zhou G, Gou J, Qu J, Sun Y, Liu Y, He Q, Chen J, Liu L, Xu L, Characteristics of Liver Tests in COVID-19 Patients, *Journal of Hepatology*.2020;April.
9. Chau TN, Lee KC, Yao H, Tsang TY, Chow TC, Yeung YC, et al. . SARS-associated viral hepatitis caused by a novel coronavirus: report of three cases. *Hepatology*. 2004; 39:302–310.
10. Ozma MA, Maroufi P, Khodadadi E, Köse Ş, Esposito I, Ganbarov K, Dao S, Esposito S, Dal T, Zeinalzadeh E, Kafil HS. Clinical manifestation, diagnosis, prevention and control of SARS-CoV-2 (COVID-19) during the outbreak period. *Infez Med*. 2020;28(2):153-165.
11. Humar A, McGilvray I, Phillips MJ, Levy GA. Severe acute respiratory syndrome and the liver. *Hepatology*.2004; 39: 291- 294.
12. Chan HLY, Leung W-K, To K-F, et al. Retrospective analysis of liver function derangement in severe acute respiratory syndrome. *Am J Med*.2004; 116: 566- 567.
13. Bartz D, Chitnis T, Kaiser UB, et al. (2020), Clinical advances in sex- and gender-informed medicine to improve the health of all: a review. *JAMA Intern Med*. [PMID: 32040165] doi:10.1001/jamainternmed.2019.7194GOOGLE SCHOLAR.
14. Bianchi VE. . The anti-inflammatory effects of testosterone. *J Endocr Soc*.2019;3:91-107.
15. La Vignera S, Cannarella R, Condorelli RA, et al. Sex-specific SARS-CoV-2 mortality: among hormone-modulated ACE2 expression, risk of venous thromboembolism and hypovitaminosis d. *Int J Mol Sci*.2020;21.
16. Cai G. Bulk and single-cell transcriptomics identify tobacco-use disparity in lung gene expression of ACE2, the receptor of 2019-nCov. *MedRxiv*, published online .2020; February 02.
17. Zhao Y, Zhao Z, Wang Y, Zhou Y, Ma Y, Zuo W. Single-cell RNA expression profiling of ACE2, the putative receptor of Wuhan 2019-nCov. *BioRxiv*, 2020; 26
18. Jieyun Zhu, Pan Ji, Jielong Pang, Zhimei Zhong, Hongyuan Li, Cuiying He, Jianfeng Zhang, Chunling Zhao. Clinical Characteristics of 3062 COVID-19 Patients: A Meta-Analysis. *J Med Virol*. 2020; Apr 15 : 10.1002/jmv.25884.



# Assess the Level of Perception Regarding Instructor Caring Behaviour among Nursing Students at SRM College of Nursing

**Abirami P.**

*Ph.D. (N), Professor, Dept. of Obstetrics and Gynaecology Nursing, SRM College of Nursing, Kattankulathur, Tamil Nadu*

## Abstract

**Introduction:** Caring is actually fundamental concept in nursing and manifests openness and honesty in the humanitarian area and the core of nursing science. Caring is the heart and soul of nursing, and people expect caring more than any other from nurses. Caring in nursing consist of two key dimensions, namely physical and mental. The psychological caring behaviors results in building confidence the feeling, faith and honesty of nursing: is caring a science.

**Aim:** A study to assess the level of perception regarding instructor caring behavior among nursing students at SRM College of Nursing, SRM Institute of Science and Technology, Kattankulathur.

**Methodology:** Non experimental descriptive research design was used to assess the level of perception regarding instructor caring behavior among nursing students. The study was conducted at SRM college of nursing, Kattankulathur, Kancheepuram district. 200 students who were studying at SRM college of nursing were selected by Non – probability convenient sampling technique. Research design was descriptive design. The data collection consisted two parts. Part A Demographic variables, Part B The structured questionnaire to assess the level of perception regarding instructor caring behavior among nursing students. It was validated and found to be feasible.

**Results and Conclusion:** The following conclusions were drawn and the basis of the findings of the study. 121 (54.3%) Students have perceived that their was a moderate level of caring behavior by the instructor, 90 (40.4%) students have perceived that their was a high level of caring behavior by the instructor.

**Keywords:** *Caring Behaviour, Instructor, Nursing students.*

## Introduction

Caring is actually fundamental concept in nursing, and manifests openness and honesty in the humanitarian area and the core of nursing science.<sup>1</sup> Caring is the heart and soul of nursing, and people expect caring more than any other from nurses.<sup>2</sup> Caring in nursing consists of two key dimensions, namely physical and mental. The psychosocial caring behaviors result in building confidence, accepting the feelings, faith and honesty.<sup>3</sup>

It is decades since Florence Nightingale' time that scientists have been studying the nature, definition and assessment of nursing: is caring a science? And how can "caring" be taught?<sup>4</sup>

Having perceived the importance of caring in nursing teaching, students can learn professionalism.<sup>5</sup> A major

part of nursing students' courses are taught in hospitals under the supervision of various clinical instructors.<sup>6</sup> Clinical instructors are the fundamental important agents in programming and acquiring clinical experiences,<sup>7</sup> because they can also establish the discipline and be a supportive agent for building students' effective communication, students' accountability and effective acquisition of scientific and clinical skill, and reducing their fear and anxiety through providing students with suitable corrective feedback and active presence as a source of reassurance and confidence.<sup>8</sup>

The nursing instructors are responsible for developing nursing curricula and using active learning strategies that will help students to learn caring behavior.<sup>9</sup> It is obvious that the clinical instructors preparing their students for entering clinical work places must meet the caring behavior.<sup>10</sup>

Previous studies showed that caring behavior played an important role in dynamism of instructor-student relationship.<sup>11,12</sup> In 2006, Wade and Kasper found that when instructors were taken as caring individuals, students also develop their own abilities. According to Wade, five special caring factor were effective in nursing students' perception of instructors caring, including instill confidence through caring, supportive learning climate, appreciation of life meaning, control versus flexibility, and respectful sharing. Based on Watson's theory of care, caring was represented by instructors and perceived by students in order to facilitate the acquisition of professional role, caring attitude, clinical self-confidence, clinical competency and interpersonal caring interactions in students.<sup>13</sup> Students learn caring through copying instructors' caring behaviors and experiencing caring with their interactions with instructors and other students.

Moreover, students perceive the presence or absence of support according to the type of contacts feedbacks receiving from their instructors,<sup>14</sup> to student instructors are individuals encouraging them, helping them to express their feelings, and inspiring them the self-confidence.<sup>15</sup> Furthermore, students make the flexibility. Kindness, respectfulness and being encouraging as the characteristic of instructor caring behaviors and they take the humiliation, rudeness, negligence and unavailability as instructor non-caring behavior. The instructor non-caring behavior arouses negative feelings in students, including ostracism, dissuasion, lost confidence, hopelessness, emotional turmoil<sup>16</sup> and increasing anxiety.<sup>17</sup> Wangletzkus believed that instructors could influence student learning positively and reduce the anxiety and loss interest in learning through increasing self-confidence, improving interpersonal relationships and help better understanding of role of education and becoming interested in education and therefore, students felts more freely to ask for help from instructors.<sup>18</sup>

Moreover, students took instructors' behavior "awkward and hostile",<sup>19</sup> as the instructors did not only reduce students' stress in the clinical environment but also increasing students stress and anxiety<sup>20,21</sup> Furthermore, inappropriate reaction to students' errors and unfair assessment made nursing students disappointed and unmotivated.<sup>22</sup> The absence of interest and motivation in student are of important barriers to the clinical education.<sup>23</sup>

Since caring behavior of clinical teacher is one of

the most important and influential factors in the process of clinical instruction, so far has not been paid enough attention. In other words, there has been so little research couldn't present the clear image of caring dimension, therefore, the present study was conducted to determine the level of perception regarding instructor caring among nursing students' at SRM College of Nursing.

## Methodology

A non experimental descriptive research design was used to assess the level of perception regarding instructor caring behavior among nursing students. The study was conducted at SRM College of nursing, Kattankulathur, Kancheepuram district. 200 students were studying in the SRM College of nursing were selected by Non-probability convenient sampling technique inclusion and exclusion criteria

**Tools for Data Collection:** The tool was consists of two sections. Section A deals with demographic details of students such as age, sex, year of study, prior education, religion, siblings, family, father or mother occupation, monthly family income, socio economic class and residence and section B consist of 30 questions to assess the level of perception regarding instructor caring behavior among nursing students. Each question was given 6 options.

- a. Strongly disagree -1
- b. Moderately disagree - 2
- c. Slightly disagree – 3
- d. Slightly agree – 4
- e. Moderately agree- 5
- f. Strongly agree – 6

### Scoring Interpretation:

- a. 1 to 60 – low level of instructor caring behavior (1 to 33 %)
- b. 61 to 120 – moderate level of instructor caring behavior (34 to 67%)
- 121 to 180 – high level of instructor caring behavior (68 to 100%)

**Ethical Consideration:** Formal approval was obtained from the institution review board and institutional ethical committee of SRM Institute of Science and Technology, Kattankulathur, Kancheepuram district, Tamil Nadu, India.

**Statistical Analysis:** Descriptive and inferential statistics were used to assess and to associate the level of perception regarding instructor caring behavior among nursing students.

## Results

**Table 1: Frequency and percentage distribution of level of perception regarding instructor caring behavior among nursing students. N=200**

S.No.	Level of perception regarding Instructor caring behavior	No. of Students	Percentage
1	Low	12	5.4%
2	Moderate	121	54.3%
3	High	90	40.4%

## Discussion

The study finding was the among 200 selected samples regarding assess the level of perception regarding instructor caring behavior among nursing students at SRM college of nursing, SRM Institute of Science and Technology, Kattankulathur.

**The first objective was to assess the level of perception regarding instructor caring behavior among nursing students:** The finding were 12(5.4%) student have perceived that their was a low level of caring behavior by the instructor, 121(54.3%) student have perceived that their was a moderate level of caring behavior by the instructor, 90(40.4%) student have perceived that their was a high level of caring behavior by the instructor regarding instructor caring.

**The second objective of the study was to associate the perception of instructor caring behavior among nursing students with their demographic variables:** Considering the association of the perception of instructor caring behavior among nursing students with their demographic variables, elder and senior had more perception score than others. The level of perception with demographic variables was assessed using chi-square test. The level of perception of instructor caring behavior was associated with the variables such as sex ( $X^2= 0.945$  P- 0.623), and age ( $X^2= 4.379$  P- 0.625), and course ( $X^2= 16.560$  P- 0.011\*), and year of study ( $X^2= 12.672$  P- 0.049\*), and religion ( $X^2=8.970$  P- 0.175), and numbers of siblings ( $X^2= 3.998$  P- 0.406), and types of family ( $X^2= 5.551$  P- 0.475), and fathers occupation ( $X^2= 10.738$  P- 0.552), and family monthly

income ( $X^2= 3.415$  P- 0.970), and socio economic class ( $X^2= 17.808$  P- 0.023\*) and residence ( $X^2= 7.391$  P – 0.117). Hence the hypothesis stated ‘there is significant association of level of perception regarding instructor caring behavior among nursing students with their demographic variables are “ course, year of study and socio economic status” and no significant association of level of perception regarding instructor caring behavior nursing students with their demographic variables are “ course, year of study, and socio economic status.

Similar study conducted by Wade and kasperin Pennsylvania on 88 nursing student of the last year and 43 nursing student of the third year with the mean age of 23 (4.79) years and female percentage of 92.2% showed the total mean of 224.75(49.6) for the clinical instructor caring behaviors. The above total mean was higher and wade’s study did not provide results for each dimension. Similar study done by Wang Letzkus in California on 138 nursing student of the third year and 101 nursing students of the last year from five academic semesters with the mean age of 24.51 (4.72) years and female percentage of 91.2% from three large nursing schools revealed the total mean for the clinical instructor caring behavior as 4.96 (0.69). The maximum and minimum mean was respectively related to instill confidence through caring and appreciation of life meanings <sup>24</sup>

## Conclusion

The present study assed the level of perception of instructor caring behavior among the nursing students in SRM college of nursing, Kattankulathur. The results of the study concluded that the maximum students were 121(54.3%) perceived that there was a moderate level of caring behavior by the instructor 90 (40.4%) student have perceived that there was a high level of caring behavior by the instructor 12(5.4%) student have perceived that there was a low level of caring behavior by the instructor. Hence the perception of instructor caring behavior among the nursing students can be enhanced through compassion, competence, conscience, confidence and commitment among instructors working in the clinical area.

**Acknowledgement:** The author acknowledges Dr. C.kanniammal Dean, SRM College of Nursing for constant guidance, We would like to thank study participants for their constant support.

**Conflict of Interest:** No conflict of interest. In addition, this study was not funded

**Statement of Human and Animal Rights:** All procedures followed were in accordance with the ethical standards of the responsible committee on human experimentation (institutional and national) and with the Helsinki Declaration of 1975, as revised in 2008

**Statement of Informed Consent:** Informed consent was obtained from all the study participants for being included in the study.

### Reference

1. Watson J. Assessing and measuring caring in nursing and health science. New York: Springer Publishin; 2002.
2. Nelson N. Beginning nursing students' perceptions of the effective characteristics and caring behaviors of their cli[nical instructor [dissertation]. New York: Capella; 2011.
3. Woodward VM. Professional caring: a contradiction in terms? *Journal of Advanced Nursing*. 1997;26(5):999–1004.
4. Cook PR, Cullen JA. Caring as an imperative for nursing education. *Nursing Education Perspectives* . 2003; 24 (4):192–7.
5. Wade GH, Kasper N. Nursing students' perceptions of instructor caring: an instrument based on Watson's theory of transpersonal caring. *Journal of Nursing Education* . 2006; 45 (5):162–8.
6. Najafipour S, Raofi R, Abdi MH, Mosalanejad L. The nursing students' viewpoints on influential clinical instructor in Jahrom University of Medical Sciences. *ournal of Jahrom University of Medical Sciences* . 2011;9:39–46. (Persian)
7. Pazandeh F, Abedian K, Jan-Nesari S, Alavi-Majd H. Opinions of nursing and midwifery students regarding an effective clinical tutor at Medical Universities in Tehran. *ournal of Shahid Beheshti school of Nursing & midwifery*. 2006;55(16):46–54. (Persian)
8. Alavi M, Abedi H. Nursing students' experiences and perceptions of effective instructor in clinical education. *Iranian Journal of Medical Education*. 2008;7(2):325–334. (Persian)
9. Karaöz S. Turkish nursing students' perception of caring. *Nurse Education Today* . 2005; 25 (1):31–40.
10. Wafaa GA. Caring and effective teaching behavior of clinical nursing instructors in clinical area as perceived by their students. *Journal of Education and Practice* . 2012; 3 (7):15–26.
11. Wang Letzkus M. Nursing students' perceptions of a caring clinical instructor [dissertation]. California: Pepperdine; 2005.
12. Clawson Roe D. The relationship between pre-licensure baccalaureate nursing students' stress and their perceptions of clinical nurse educator caring [dissertation]. New Orleans: Louisiana; 2009.
13. Beck C. Caring within nursing education: a metasynthesis. *Journal of Nursing Education* . 2001; 40 (3):101–9.
14. Salmani N, Amirian H. Comparison between nursing students and trainers viewpoints about clinical educator environment in Islamic Azad university of Yazd. *Strides in Development of Medical Education*. 2006;1(3):11–8. (Persian)
15. Nahas VL, Nour V, Al-Nobani M. Jordanian undergraduate nursing students' perceptions of effective clinical teachers. *Nurse Educ Today* . 1999; 19 (8):639–48.
16. Hanson L, Smith M. Nursing students' perspectives: experiences of caring and not-so-caring interactions with faculty. *Journal of Nursing Education* . 1996; 35 (3):105–12.
17. Cook L. Inviting teaching behaviors of clinical faculty and nursing students' anxiety. *Journal of Nursing Education* . 2005; 44 (4):156–62.
18. Heydari M, Shahbazi S, Sheykhi RA, Heydari K. Nursing students' viewpoints about Problems of clinical education. *Iranian Journal of Health & Care*. 2011;1(13):18–23. (Persian)
19. Alavi M, Irajpour AR, Nasiri A, Abedi HA. Barriers to clinical education: student nurses' experiences. *Scientific Quarterly of Birjand Nursing and Midwifery Faculty*. 2009;1-4(6):5–11. (Persian)
20. Delaram M, Raeisi Z, Alidousti M. Strengths and weaknesses of clinical education from the viewpoints of nursing and midwifery students in Shahrekord University of Medical Sciences. *Qom University of Medical Sciences Journal*. 2012;6(2):76–81. (Persian)
21. Abedini S, Agha Mullahei T, Jomehzadeh A, Kamjo A. Clinical education problems from the viewpoint of nursing and midwifery students of Hormozgan University of Medical Sciences. *Hormozgan Medical Journal*. 2009;12(4):249–53. (Persian)

22. Salehian M, Armat MR.. Qualitative study of nursing student experiences in clinical education. *Journal of North Khorasan University of Medical Sciences*. 2009; 23(1):57–63. (Persian)
23. Rahimi A, Ahmadi F. The obstacles and improving strategies of clinical education from the viewpoints of clinical instructors in Tehran's Nursing Schools. *Iranian Journal of Medical Education*. 2006;5(2):77–84.(Persian)
24. Vahid Zamanzadeh, Masoumeh Shohani,Tina Palmeh, Nursing Students' Perception of Instructors' Caring Behaviors in Tabriz University of Medical Sciences, *Journal of Caring Sciences*, 2015 Mar; 4(1): 55–62.

# Medical, Human Rights and Legal Analysis of the Existence of Lesbian, Gay, Bisexual, and Transgender in Indonesia

Aditya Yuli Sulistyawan<sup>1</sup>, Tri Rahayu Utami<sup>1</sup>

<sup>1</sup>Lecturer at Faculty of Law, Diponegoro University, Semarang, Indonesia

## Abstract

Globalization, which has now crossed the line, has had many impacts on all countries in the world including Indonesia. One of the impacts of globalization is the impact of deviant associations such as LGBT and it affects various countries. The emergence of the LGBT phenomenon, which is currently a hot topic of discussion by various parties in Indonesia, has raised pros and cons views on the legality of LGBT in society. LGBT legalization in various countries is currently encouraging LGBT survivors in Indonesia to urge the government to legalize LGBT. Therefore, this article will discuss the reality of LGBT and its legal arrangements in Indonesia and how to analyze the philosophy of law on the reality of LGBT in Indonesia. The results of the study show that according to the constructivism paradigm in the contextual review of legal philosophy in Indonesia, LGBT is not in accordance with the values of Pancasila as the nation's life guide.

**Keywords:** *LGBT, philosophy of law, Indonesia.*

## Introduction

Globalization has a great impact on situations and conditions related to social relations, and cooperation between nations takes place quickly so that there is a mutual transfer of lifestyles, cultural values, thinking method, adopted systems, science and others, through relative contact fast too. It is in such an atmosphere and contacts that global political issues, global economy, global culture, and global defense and security develop.<sup>1</sup> Among the many impacts brought about by globalization, it cannot be denied that there is an impact on social deviations in terms of sexual behavior. The deviant behavior currently being discussed is the emergence of Lesbian, Gay, Bisexual and Transgender (LGBT) groups in society and is still being debated from all sides by various parties.

The history of the emergence of LGBT groups in Indonesian civilization, both documented in scientific and popular works, can be said to have begun to develop since the 1960s and boom in the 2000s.<sup>2</sup> In fact, organizations or advocacy organizations for this group grew in the 1980s, such as: Hiwad (Himpunan Wadam Jakarta); Lambda, Perselin (Indonesian Lesbian Association), all of which serve as a means of communication between perpetrators, observers and supporters of this group. The

number of LGBT perpetrators in Indonesia reaches 3 percent of the total population of Indonesia or around 7.5 million people.<sup>3</sup>

The behavior of LGBT survivors, which is currently still hotly discussed, has received special attention from academics abroad as well as the study of feminism. But unfortunately, LGBT people still get an inappropriate position in Indonesian society. This rejection can be seen, among others, by the Islamic Defenders Front (FPI), which was recorded and explicitly restricted the movement of LGBT groups in the public sphere, as well as carrying out physical attacks against this group in various regions in Indonesia. The issue of LGBT is also a concern of domestic academics. This topic is discussed in almost all fields of study of science: law, religion, psychology, education, and sociology, even media and communication. Domestic scientific studies tend to analyze LGBT in particular in relation to its legitimacy in the eyes of law, social, culture, and religion. Humans as one of the contents of the universe are made the object of philosophy which examines it from various aspects. One of them is regarding his behavior. Some of these behaviors are then thoroughly investigated by the philosophy of law. Therefore, this article will discuss in depth the study of Legal Philosophy of the reality of

Lesbian, Gay, Bisexual and Transgender (LGBT) in Indonesia in order to understand the reality of LGBT from the point of view of legal philosophy. The purpose of writing this paper is to determine the reality of LGBT in Indonesia today so that we can understand the patterns and impacts of LGBT in society which is currently very troubling. In addition, it is also to understand the legal arrangements in Indonesia regarding the reality of LGBT so that it can be seen how the state's attitude towards the existence and reality of LGBT which is currently increasing in number. To achieve this goal, the problems that the authors discuss are the reality of LGBT and the legal arrangement in Indonesia and the analysis of legal philosophy on the reality of LGBT in Indonesia.

**The Reality of LGBT and Its Legal Regulations in Indonesia:** The definition of LGBT, in general, is associated with the term homosexual, which is the tendency to make someone of the same sex as a sexual partner and/or other emotional relationship. The rise of the LGBT phenomenon in Indonesia is closely related to the trend of liberal countries that provide recognition and a place for the LGBT community in society. LGBT is considered a part of modern society's life style which considers views of heterosexuality as conservative and does not apply to everyone. Social legitimacy arises with a priori scientific and theological defenses to strengthen claims about their existence and social purpose. This situation then made the LGBT movement spread so rapidly as a social epidemic.

In terms of quantity, there is no definite data on the number of LGBT people in Indonesia, but it is certain that it is increasing every year. According to a report from the Ministry of Health quoted from the National AIDS Commission, the number of men who have sex with men, aka gay, has reached millions. Based on the Ministry of Health's estimate in 2012, there were 1,095,970 MSM both visible and not. More than five percent (66,180 people) have HIV. Meanwhile, the UN predicts that the number of LGBT people will be much higher, namely three million people in 2011. In fact, in 2009 the gay population was only around 800,000 people. They take refuge behind hundreds of community organizations that support the tendency to have same-sex orientation.

In the perspective of Human Rights, pro-LGBT groups acknowledge that they have the right to vote for LGBT people. Because it is a human right, they demand protection. Human rights are a fundamental

right inherent in human beings, universal and eternal, and therefore, must be protected, respected, protected, and not to be ignored, diminished, or deprived of anyone. In the Preamble of the Universal Declaration of Human Rights it is stated that "human rights must be protected by law, so that people will not have to choose the path of rebellion as a last resort to oppose tyranny and colonization".

The implementation of human rights without considering sexual orientation and gender and individual gender identity is not an easy matter. However, non-governmental organizations (NGOs), human rights and LGBT activists have consistently fought for LGBT recognition and rights, both at the national and international levels. Their endeavors have resulted in new developments on LGBT issues in Indonesia. The political reforms and democratization that have taken place in Indonesia have brought LGBT issues into the spotlight, leading to developments in LGBT organizations. Liberalism that upholds individual freedom has triggered the emergence of LGBT people who, although we think it is not normal, they think are normal and free to do as long as they do not harm others. Individual rights deserve protection, but individual rights are also limited by other individual rights.

Liberalism is one of the philosophical products of the Enlightenment in Europe which is very influential in the development of industrial society today. Liberalism believes that political legitimacy is influenced by the state's respect for the human rights of its citizens. We can see the close connection between liberalism and LGBT with the events of 26 June 2015, which became a historic day for LGBT people. On that day, the US Supreme Court's decision is believed to influence the decisions of many countries to participate in making similar decisions. In addition, there are already 22 countries from 204 countries that have been de facto recognized by the United Nations which fully legalize same-sex marriage in all regions of their country.<sup>1</sup> Most of these countries are countries with liberal ideologies.

In the legal system in Indonesia, as contained in the 1945 Constitution states "the right to life, the right not to be tortured, the right to freedom of thought and conscience, the right to religion, the right not to be enslaved, the right to be recognized as a person before the law, and the right not to be prosecuted based on retroactive law is a human right that cannot be reduced under any circumstances". This is in accordance with the provisions of Article 2,7 and 22 of the UDHR.

The state has the obligation to protect the people of Indonesian citizens regardless of their type, ethnicity, religion, race, ethnicity, or minorities and vulnerable groups (meaning that they are vulnerable to violence). The state has an obligation to fulfill the human rights needs of all Indonesian citizens regardless of ethnicity, religion, including minorities and vulnerable groups including LGBT people. In terms of protection, what must be guaranteed and provided in the context of LGBT from a human rights perspective is the protection of their human rights in the form of health insurance to be able to recover from their illness, as stipulated in Article 25 of the Universal Declaration of Human Rights, namely “everyone has the right to an adequate standard of life for health, and the welfare of himself and his family, including the right to food, clothing, housing and health care as well as necessary social services, and the right to security when he is unemployed, suffering from illness, disability, being a widow/widower, reaching old age or other conditions that cause him to be deprived. a living, which is beyond his control”.

Based on applicable law in Indonesia, it is possible for people who have undergone sex change surgery to file a gender change in court. This is based on the jurisprudence of court decisions in cases of legal gender change for a male transsexual into a woman, namely Vivian Rubianti (born Iwan Rubianto) in 1973.<sup>11</sup> There are several rules that indirectly regulate LGBT. Article 292 of the Criminal Code explains that LGBT acts can be punished if the partner is an immature person under the criminal law. Even though the act was carried out without coercion or threat of violence, it is still an act that violates the contents of Article 292 of this Criminal Code. So far, what is prohibited by the Criminal Code is only homosexuals committed against minors. Article 292 of the Criminal Code does not explicitly prohibit homosexuals that are committed between adults. Therefore, it is necessary to emphasize the prohibition of homosexuality and adultery.<sup>12</sup> On the other hand, the Pornography Law (Law Number 44 of 2008) includes the term “deviant intercourse” as an element of pornography. In the explanation the meaning of this term includes, among other things, “intercourse or other sexual activity with corpses, animals, oral sex, anal sex, lesbian, and homosexuals”. Although prohibitions apply to the production and distribution of pornography, these laws are understood by many gay men and lesbian women to criminalize homosexual sex. This is something interesting to discuss because in the regulation there is

no prohibition for transgender people regarding deviant sexual relations.

In addition, Government Regulation Number 54 of 2007 concerning Adoption explicitly stipulates that adopting parents cannot be a homosexual couple. Adoption by an unmarried person is not permitted. These various regulations were further reinforced by other regulations, namely the Marriage Law (Law Number 1 of 1974) which explicitly defines marriage as the union between a man and a woman. Therefore, if the marriage occurs, the marriage is only considered never to have existed and no criminal sanctions are given to the perpetrator of the LGBT marriage.

## Conclusion

The exposure of the LGBT phenomenon in Indonesia has become a hot polemic that is discussed from various sides by many parties. The reality of LGBT which is the basis of LGBT legality in Indonesia by pro LGBT people who base the Universal Declaration of Human Rights as its legalization must be reviewed based on the applicable law in Indonesia. Based on Pancasila in the name of Almighty Godhead, then LGBT in Indonesia cannot be legalized because every creature has its own nature, so that the protection of human rights referred to in the Universal Declaration of Human Rights must be adjusted again based on the 1945 Constitution which guarantees the protection of the Indonesian nation, however, protection for the healing of LGBT survivors is not about legalizing them to be accepted as a legally correct group. There are still many pros and cons related to LGBT in Indonesia which is also a moment for every party who is pro or contra to straighten up and present their arguments for the existence of LGBT. This can be initiated by bringing together various parties in a discussion/dialogue to present the arguments of each party in order to find a solution and solution to the LGBT problems that exist in Indonesia today. So it is hoped that with these discussion rooms, LGBT problems in Indonesia can be easily resolved and provide legal certainty whether it is legalized or just a mere hegemony.

**Ethical Clearance:** This research was ethically approved by Faculty of Law, Universitas Diponegoro, Semarang, Indonesia.

**Funding:** This research receives external funding from Faculty of Law, Universitas Diponegoro, Semarang, Indonesia.



**Conflict of Interests:** There are no conflict of interests.

### References

1. Lubis MS. Serba-serbi politik & hukum. Sofmedia; 2011..
2. Agung R. Menelisik Perjalanan LGBT di Indonesia. Jakarta: Republika.co.id; 2016.
3. Hasnah H, Alang S. Lesbian, gay, biseksual dan transgender (lgbt) versus kesehata: studi etnografi. *Jurnal Kesehatan*. 2019 Jun 27;12(1):63-72.
4. Perdana PP. Cari Kaum LGBT, FPI Sweeping Rumah Kos di Bandung. Jakarta: Tempo.co; 2016.
5. Muttaqin I. Membaca strategi eksistensi LGBT di Indonesia. *Raheema: Jurnal Studi Gender Dan Anak*. 2016;3.
6. Sidabutar H. Mewaspada 'Virus' LGBT. *Republika*; 2016.
7. Hartanto HD. Studi Kasus Advokasi Legalisasi Lesbian, Gay, Biseksual, dan Transgender (LGBT) Di Indonesia. *Jurnal Indonesian Perspective*. 2016 Jul;1(2).
8. Muthmainnah Y. LGBT Human Rights in Indonesian Policies1. *Queering Indonesia: Self, Subjectivity & Crisis*. 2016;13.
9. Burchill S. Liberalism. *Theories of international relations*. New York: Palgrave Macmillan; 2005.
10. House F. Freedom in the world 2014: The annual survey of political rights and civil liberties. *Rowman & Littlefield*; 2014 Dec 11.
11. Boellstorff TD. The perfect path: Gay men, marriage, Indonesia. *GLQ: A Journal of Gay and Lesbian Studies*. 1999;5(4).
12. Pramesti TJA. Prosedur Hukum Jika Ingin Berganti Jenis Kelamin. *Hukum Online. Com*; 2015.

# The Role of Kinship and the Effectiveness of Traditional Customary Law on Inheritance System in Berbah, Sleman Regency

Agung Basuki Prasetyo

*Lecturer at Faculty of Law, Diponegoro University, Semarang, Indonesia*

## Abstract

Indigenous peoples in Indonesia have a diverse family system, this leads to diversity in the devolution system. This form of parental kinship applies to the people of Berbah Sub-District of Sleman Regency. And whoath is in the heavens and the earth, and who is in the heavens and the earth, and who is in the heavens and the earth, and who is in the heavens and the earth, and whoth in the heavens and the earth, and currently, the people in Berbah Sub-District of Sleman Regency are predominantly Muslim, which could potentially influence the pattern of setting inheritance distribution in Islamic Law. There is still a strong principle of togetherness, the principle of deliberation, and the principle of benefit in the order of life of the people of Berbah District of Sleman Regency. Most importantly, they can accept the results of deliberation while upholding the principle of harmony.

**Keywords:** *Effectiveness, customary system, kinship, inheritance law.*

## Introduction

Customary law communities in Indonesia, who have a variety of religions, beliefs, ethnicities, of course, have an effect on the different forms of kinship. This will lead to a diversity of patterns in the marriage system and inheritance in the life order of the Indonesian customary law community<sup>1</sup>.

In Central Java which adheres to the parental kinship system, the kinship law is based on drawing maternal lines. In such a society, there are usually ways of mentas and seek or free marriages, namely, the usual form of marriage, husband and wife who are already married are free to determine their place of residence. Have left their home environment, or have been independent apart from their original family.

The formation of the national inheritance law, it is impossible to change the existing legal system, but still pay attention to the laws that live in the community, so that it can regulate the distribution of inheritance in Berbah District, Sleman Regency. Berbah District, Sleman Regency, is the study area. This is motivated by the life of the people who still uphold togetherness or communalism, more prominently social elements

to help fellow citizens. So that relatively it can be said that they still have customs rules that are used as legal provisions that apply in social relations. In a community where customary rules apply, of course, they will be in conditions that are in harmony or do not face each other. So that the rules of inheritance customary law that have been obeyed for a long time should have a stronger influence on the life patterns of the people of Berbah District, Sleman Regency, which will become the legal provisions that are obeyed. This study aims to analyze the effectiveness of the inheritance customary law to be effective in Berbah District, Sleman Regency.

## Research Method

This study is an empirical legal research using an empirical juridical approach. Empirical legal research is that law is identified as patterned behavior or understanding social meaning. The juridical approach, because this research stems from the principles and principles contained in a certain legal rule, it is used to see and analyze the problems to be examined. This empirical juridical approach is carried out to describe the real facts about the effectiveness of the Adat Adat Law in Berbah District, Sleman Regency. Primary data were

obtained from informants who were directly related to the problem being studied. Data analysis was carried out using qualitative analysis.

**Inheritance Value and Kinship System:** The inheritance system is also inseparable from the kinship system adhered to by customary law communities in Indonesia. Patrilineal system draws on the lineage of the male ancestors, the position and influence of men in the inheritance law is very prominent, while the matrilineal system which draws the lineage of the female ancestors, the position and influence of women in the inheritance law is very prominent. In addition, parental/bilateral system, which draws lineages from two sides, both from the father's side and from the mother's side, the position of sons and daughters in the law of inheritance is equal and equal, meaning that both boys and girls are heirs of the assets the legacy of their parents<sup>2,3</sup>. Inheritance in the customary inheritance law contains regulations governing the process of forwarding and transferring property and intangible items (immaterial goederen) from a human force (generatie) to their descendants<sup>4</sup>.

The parental kinship system adopted by the indigenous peoples of Central Java both influences and determines inheritance. It is evident that boys and girls are considered heirs in the view of Central Javanese customary law. This fact is in line with the view of Wirjono Prodjodikoro which states that the nature of inheritance in a particular society is closely related to the kinship nature of that society<sup>5</sup>. This has the consequence that sons and daughters are seen as heirs, because they are equally entitled to inherit the inheritance left by the heir.

This is in line with the post modern era (globalization era) and technological advances in urban areas, where women are equal and equal to men. Another role for a woman is to position herself as part of her community. The development of gender perspective studies also encourages changes and developments in the position of girls' rights in law, especially in terms of customary law<sup>6</sup>.

Changes, especially in terms of inheritance, experience the effects of developments around them, which in general the rules of inheritance experience effects such<sup>7</sup> associal change/development, due to the tighter family ties, the loosening of clan and ethnic ties, inheritance rules from a foreign law which due to a certain relationship with religion get the authority

that comes from religion, such rules for example from religious judges are applied to concrete events, even though the influence in inheritance law is smaller than in law marriage, depending on the strength of the inheritance law whether the law can survive or will there be a deep change.

Changes or developments will be made possible by the modernization of the way of thinking of members of indigenous peoples and law enforcers. In principle, customary law is people's law. As the people's law that regulates life that is constantly changing and developing, the maker is the people themselves. Therefore customary law undergoes continuous changes through decisions or settlements issued by the community as a result of consensus and deliberation through deliberation. Every development that occurs is always endeavored to have a place in the customary law system.

**The effectiveness of traditional inheritance law in Berbah District, Sleman Regency:** Berbah Subdistrict, Sleman Regency, is one of the government areas located on the outskirts of the Sleman Regency government, precisely on the border with Klaten Regency. In general, the people are effective in recognizing parental forms of kinship. Namely the kinship system, where there is a balance of position between husband and wife or withdrawing from the maternal line.

Based on the data above, after discussion with competent parties, it turns out that in accordance with Hilman Hadikusuma<sup>8</sup> opinion, that the parental kinship system, the blood relationship system is no different from the father's and mother's descent system and generally applies the custom of free marriage, where after the husband's marriage wife live independently. Then if you do not have children, the adoption of a male or female child may apply. So it can be understood that the parental/bilateral kinship system is a kinship system that draws lineages from two sides, both from the father's side and from the mother's side.

Further data obtained that in general in the people of Berbah District, there is an equal inheritance position between boys and girls, or in other words there is an equal right to the acquisition of inheritance from the heir, namely his parents. This is in accordance with the provisions that apply to the parental or bilateral system which draws lineage from two sides, both from the father's side and from the mother's side, the position of boys and girls in the law of inheritance is equal and

equal, meaning that both boys, as well as daughters are heirs of their parents' inheritance<sup>2</sup>.

However, data is obtained, there are a small number of families who when dividing the inheritance, only boys get more inheritance assets with daughters, namely 2 to 1 in accordance with the provisions of Islamic Inheritance Law.

As understood, the inheritance customary law is the rules of customary law that govern how the inheritance or inheritance is passed on or shared from heirs to experts from generation to generation<sup>9</sup>.

Of course, there is an atmosphere of mysticism for each family in dividing the inheritance for their children or generations of descendants. Because customary law is a dynamic law, it can adapt to certain situations and conditions. So when the provisions of the customary inheritance law are not implemented by certain families, it does not mean that the community must make a problem. The most important thing is that the principles of sharing his customary heritage are fulfilled.

**Factors of traditional inheritance law in Berbah sub-district, Sleman regency:** In connection with the factors that cause Adat Waris Law to be effective in Berbah District, Sleman Regency, data is obtained that the people of Berbah Subdistrict have a high level of compliance in carrying out the distribution of inheritance according to their customary provisions, because so far there have been relatively no internal conflicts between the heirs in a family who carry out the distribution of inheritance from their parents. The existence of a magical religious basis of thought in the people of Berbah District, Sleman Regency, on the implementation of inheritance distribution pays more attention to the heirs, parents and ancestors who have died calm in their graves. Mean while, the process of distributing inheritance by using the principle of cumunal or togetherness, the principle of deliberation and the principle of benefit in accordance with the provisions of customary law. So the most important thing is to be able to receive the results of the deliberations while still upholding the principle of harmony.

Furthermore, the results of the above research, conducted discussions with competent parties, so it can be understood that the customary inheritance law in the Berbah District generally shows a distinctive feature of the traditional Indonesian mindset, which is based on the principles that arise from a mind that is imbued

with communal traits (togetherness), kinship, unity and oneness.

Some of the legal principles underlying the inheritance customary law are that according to the customary law system, inheritance property is not an entity that can be valued in money but is a unit that is not divided or can be divided according to types and kinds and based on the interests of the inheritors<sup>10</sup>. According to the customary law system, inheritance is based on equal rights, meaning that the rights of each heir are required to be the same in the process of passing on and passing on assets, and are placed on the basis of harmony in the process of distribution. Customary inheritance law adheres to the principle of open inheritance, which can be carried out while the heir is still alive and after he dies. So, customary inheritance law does not recognize any time when experts demand the opening of an inheritance. Settlement of inheritance using divine law principles, self-control, deliberation and consensus, harmony and kinship, and mutual rights.

Inheritance customary law is a form of the legal system that applies to the Indonesian people, especially those who are subject to customary law. Customary inheritance law is based or based on the principles of the characteristics of the traditional Indonesian school of thought, which have distinctive features, namely communal, religious magic, concrete, and cash (cash). Hazairin said that customary inheritance law has its own characteristics, namely that which originates from the minds of traditional communities with the form of kinship whose descent systems are based on patrilineal, matrilineal, and parental/bilateral<sup>9</sup>. Based on this distinctive feature, customary inheritance law is different from Islamic and western inheritance law. These differences stem from the way of thinking and way of life, such as customary inheritance law based on collective-communal rationalism, while western inheritance law is based on individualism.

## Conclusion

In general, people in the Berbah District of Sleman Regency recognize parental forms of kinship. Namely the kinship system, where there is a balance of position between husband and wife or withdrawing from the father and mother line. There is an equal inheritance between boys and girls, or there is an equal right to the acquisition of inheritance from the heir, namely his parents.

The factors causing the inheritance customary law are still effective in Berbah District, Sleman Regency, namely: a). The people of Berbah District have a high level of compliance in carrying out the distribution of inheritance in accordance with their customary provisions, because so far there has never been an internal conflict between the heirs in a family that distributes inheritance from their parents. b). The existence of a magical religious basis of thought in the people of Berbah District, on the implementation of the distribution of inheritance, pays more attention to the heirs, parents and ancestors who have died calm in their grave. c). The process of distributing inheritance by more using the principle of cumunal or togetherness, the principle of deliberation and the principle of benefit in accordance with the provisions of customary law. So the most important thing is to be able to receive the results of the deliberations while still upholding the principle of harmony.

**Suggestion:** Village apparatus, especially in the Berbah sub-district, Sleman Regency, as well as related officials, so that they can better understand the substance of the distribution of inheritance carried out by their residents. So that there is certainty to provide legal protection for parties related to the distribution of inheritance.

Village apparatus in the Berbah Subdistrict, Sleman Regency, should be able to act as mediators in resolving disputes that may arise as a result of the distribution of inheritance carried out based on local customary law, in a fair manner.

**Ethical Clearance:** This research was ethically approved by Faculty of Law, Universitas Diponegoro, Semarang, Indonesia

**Funding:** This research receives funding from Faculty of Law, Universitas Diponegoro, Semarang, Indonesia.

**Conflict of Interests:** There are no conflict of interests

## References

1. Sismarwoto E. Islamic ethical value of customary basis of marriage proposal application in Indonesia. *Indian Journal of Forensic Medicine and Toxicology*. 2020;14(3): 1843-1846.
2. Suparman E. *Intisari Hukum Waris Indonesia*. Armico; 1985
3. Mulyadi L. Interpretation of judges in representing the dynamics of religion of indigenous legal inheritance of Bali. *Jurnal Hukum dan Peradilan*. 2019 Jul 31;8(2):214-27.
4. Soepomo, R. *Bab-bab Hukum Adat*. Jakarta: Pradnya Paramita;1981
5. Prodjudikoro, W. *Hukum warisan di Indonesia*. Sumur Bandung; 1966.
6. Sendratari, LP. *Perempuan Bali: Wajah Sejuta Warna (Kajian tentang Reproduksi dan Resistensi terhadap Patriarki)*. Media Komunikasi Singaraja; 2002.
7. Sudiyat I. *Hukum adat: sketsa asas*. Liberty Yogyakarta; 1981.
8. Hadikusuma H.. *Pokok-pokok pengertian hukum adat*. Alumni; 1980.
9. Hilman H. *Pengantar Ilmu Hukum Adat Indonesia*. Mandar Maju, Bandung; 1992
10. Samosir D. *Hukum adat: eksistensi dalam dinamika perkembangan hukum di Indonesia*. Nuansa Aulia; 2013.

# Does Education Level Matter in Women's Risk of Early Marriage?: Case Study in Rural Area in Indonesia

Agung Dwi Laksono<sup>1</sup>, Ratna Dwi Wulandari<sup>2</sup>, Ratu Matahari<sup>3</sup>

<sup>1</sup>Researcher, National Institute of Health Research and Development, the Indonesia Ministry of Health, Jakarta, Indonesia, <sup>2</sup>Researcher, Faculty of Public Health, Universitas Airlangga, Surabaya, Indonesia, <sup>3</sup>Researcher, Faculty of Public Health, Universitas Ahmad Dahlan, Yogyakarta, Indonesia

## Abstract

Several studies inform that early marriage is correlated with several situations, including socioeconomic status, cultural wisdom, religious values, education, and internet access. The study was aimed at analyzing the effect of education level on women's risk of early marriage in rural areas in Indonesia. The study used data from the 2017 Indonesian Demographic and Health Survey. There were 2,252 women aged 19-24 years in a rural area in Indonesia who was taken as a sample. The variables analyzed included early marriage, education level, wealth status, and employment status. The final stage was used as a binary logistic regression test to determine the risk factors. The result found that women who have secondary education have a risk of 0.396 times compared to women who have primary education to experience an early marriage (OR 0.396; 95% CI 0.309-0.506). Women who have a higher education have a risk of 0.091 times compared to women who have primary education to experience an early marriage (OR 0.091; 95% CI 0.059-0.140). This finding informs that the education level was a determinant of the incidence of early marriage among women in rural Indonesia. The lower the education of a woman in a rural area, the higher the risk of experiencing an early marriage. It could be concluded that a low level of education is a risk factor for women's early marriage in rural areas in Indonesia.

**Keywords:** *Education level, early marriage, maternal health, reproductive health.*

## Introduction

Early marriage is a phenomenon related to socio-economic conditions in developing countries. Early marriage can also be interpreted as child marriage. This phenomenon is increasing in number from year to year so that it becomes the focus of the target of the 5th point of the Sustainable Development Goals<sup>1</sup>. The prevalence rate of early marriage in Indonesia is high. The 2018 National Economic Survey (Susenas) noted that there were around 1.2 million adolescents who married before the age of 18<sup>2</sup>. The Indonesia Demographic and Health Survey 2002-2017 reported that 10% of Indonesian women became pregnant before the age of 18<sup>3</sup>. Moreover, the Indonesian government is also targeting a reduction in the prevalence of early marriage from 11.2% in 2018 to 8.74% in 2024 through the 2020-2024 National Medium Term Development Plan (RPJMN) so that by 2030 it can be targeted that the rate of early marriage is at 6.94%<sup>2</sup>.

Early marriage in Indonesia is a common thing, given that marriage in traditional culture is part of the family's responsibility, not an individual desire, so that the family plays an important role in determining a marriage compared to the wishes of the child<sup>4</sup>. Globally, Indonesia is a country with the largest Muslim majority population, so that socio-cultural conditions are closely related to religious values held by a person<sup>4,5</sup>. The social construction in Muslim societies makes early marriage defined as the act of preventing unlawful sexual acts among adolescents<sup>6,7</sup>. Besides, the concept of maintaining virginity until marriage takes place also underlies the occurrence of early marriage in Indonesia<sup>7</sup>.

Several studies have shown that early marriage is positively correlated with several situations, including socioeconomic status, cultural wisdom, religious values, education, and internet access<sup>8-10</sup>. In several regions in Indonesia, it has cultural values that support early marriage<sup>11,12</sup>. The social construction that is formed in

this community is a shame if in a family there are teenage girls who do not get married, there is still a strong opinion that the education of boys is more important than girls, and marrying children in adolescence can help ease the economic burden family<sup>13-15</sup>

Early marriage is a complex social problem that can have physical and psychological consequences. Teenage girls are very vulnerable to maternal mortality, child mortality, miscarriage, and giving birth to babies with low birth weight because knowledge related to motherhood is still very minimal, and reproductive organs are not ready to get pregnant and give birth<sup>5</sup>. Another impact is young women faced with conditions of dropping out of school, anxiety, victims of domestic violence, to the trauma of living life<sup>10</sup>. Seeing the wide impact of early marriage on young women, it is very important to equip adolescents with knowledge about reproductive health, including the long-term consequences of early marriage. Young women are still allowed to go to school as an alternative to improve the quality of life of young women so that they can compete for jobs and better livelihoods<sup>6</sup>.

Based on the background description, this study was aimed at analyzing the effect of education level on women's risk of early marriage in rural areas in Indonesia. The results of this study are considered important for population policymakers to provide clear policy targets to reduce the rate of early marriage in Indonesia.

## Materials and Method

**Data Source:** The study uses data sourced from the 2017 Indonesia Demographic and Health Survey (IDHS). The 2017 IDHS sample was taken using the stratification and multistage random sampling method. The unit of analysis for women aged 19-24 in rural Indonesia. Selection of the unit of analysis for women at  $\leq 19$  years of age because they had passed the age limit for early marriage. While the age limit is less than  $\leq 24$  years old, assuming there is no significant change in the demographic characteristics of the respondents to be tested to be a determinant of the incidence of early marriage. With the analysis unit, a sample size of 2,252 women in rural areas of Indonesia was obtained.

**Data Analysis:** In this study, the definition of early marriage is a marriage that is done before the age of 19 years old. This age limit refers to Law 16 of 2019 concerning Amendments to Law 1 of 1974 concerning Marriage. The independent variables analyzed in this study were education level, wealth status, and employment status.

Analysis at the initial stage was carried out using chi-square to determine the relationship between variables. Determination of risk factors is carried out using a binary logistic regression test because of the nature of the dependent variable. All statistical tests were carried out with the help of SPSS type 22.

## Results and Discussion

**Table 1. Descriptive statistics of education level and individual characteristics of the respondent (n=2,252)**

Characteristics	Education Level						p
	Primary		Secondary		Higher		
	n	%	n	%	n	%	
<b>Early marriage</b>							<b>***&lt;0.001</b>
No	96	15.7%	516	34.4%	101	70.6%	
Yes	514	84.3%	983	65.6%	42	29.4%	
<b>Wealth status</b>							<b>***&lt;0.001</b>
Poorest	406	66.6%	687	45.8%	48	33.6%	
Poorer	119	19.5%	394	26.3%	26	18.2%	
Middle	59	9.7%	252	16.8%	27	18.9%	
Richer	19	3.1%	115	7.7%	21	14.7%	
Richest	7	1.1%	51	3.4%	21	14.7%	
<b>Employment status</b>							<b>**0.002</b>
Unemployed	387	63.4%	1055	70.4%	88	61.5%	
Employed	223	36.6%	444	29.6%	55	38.5%	

**Note:** \*p <0.05; \*\*p <0.01; \*\*\*p <0.001.

Table 1 provides descriptive statistics of the education level and individual characteristics of the respondent. It can be seen that early marriage is more dominant in women who have primary and secondary education. Based on wealth status, it can be seen that all categories of education level are dominated by the poorest women. Meanwhile base on employment status, it can be seen that all categories of education level are dominated by unemployed women.

Table 2 shows the results of binary logistic regression of early marriage among women in rural areas in Indonesia. Women who have secondary education have a risk of 0.396 times compared to women who have primary education to experience an early marriage (OR 0.396; 95% CI 0.309-0.506). Women who have a higher education have a risk of 0.091 times compared to women who have primary education to experience an

early marriage (OR 0.091; 95% CI 0.059-0.140). These findings inform that education level is a determinant of early marriage among women in rural areas in Indonesia. The lower the education of a woman in a rural area, the higher the risk of experiencing an early marriage. Low education is probably closely related to an understanding of the risks of early marriage which is also low<sup>16,17</sup>.

A study in Iran found that apart from the level of education, there are other factors related to education that are also a determinant of early marriage, namely the level of knowledge about the impacts of child marriage<sup>18</sup>. Several previous studies have informed that education is a positive determinant of performance output in the health sector<sup>19-21</sup>. Furthermore, low education is informed as a barrier to performance output in the health sector<sup>22,23</sup>.

**Table 2. The result of binary logistic regression of early marriage among women in rural area Indonesia (n=2,252)**

Predictors	Early Marriage			
	Sig.	OR	Lower Bound	Upper Bound
Education level: Primary	-	-	-	-
Education level: Secondary	***<0.001	0.396	0.309	0.506
Education level: Higher	***<0.001	0.091	0.059	0.140
Wealth status: Poorest	-	-	-	-
Wealth status: Poorer	*0.032	0.776	0.615	0.978
Wealth status: Middle	**0.001	0.639	0.489	0.834
Wealth status: Richer	***<0.001	0.434	0.303	0.620
Wealth status: Richest	*0.045	0.603	0.368	0.988
Employment status: Unemployed	-	-	-	-
Employment status: Employed	*0.014	1.294	1.054	1.588

**Note:** \*p <0.05; \*\*p <0.01; \*\*\*p <0.001.

Women who have the wealth status of the poorer category have a risk of 0.776 times compared to the poorest women to experience an early marriage (OR 0.776; 95% CI 0.615-0.978). Women who have wealth status in the middle category have a risk of 0.639 times compared to the poorest women to experience an early marriage (OR 639; 95% CI 0.489-0.834). Women who have wealth status in the richer category have a risk of 0.434 times compared to the poorest women to experience an early marriage incident (OR 0.434; 95%

CI 0.303-0.620). The richest women had a risk of 0.603 times compared to the poorest women to experience an early marriage incident (OR 0.603; 95% CI 0.368-0.988). This finding informs that poverty is a risk factor for early marriage among women in rural Indonesia.

Previous studies in various developing countries have found similar results that poverty is a risk factor for early marriage. Some of these countries are in South Sudan, Bangladesh, and India<sup>24-27</sup>. In the context in Indonesia, the phenomenon of early marriage tends to



occur in poor families of women. Early marriage is one practical way for poor families to get out of poverty. Marrying a girl from a poor family to a rich male family is a shortcut to a better life<sup>28,29</sup> with girls constituting the majority (76 per cent).

Finally, employed women have 1.294 times the risk of unemployed women experiencing an early marriage (OR 1.294; 95% CI 1.054-1.588). The results of this analysis inform that employed is a risk factor for early marriage among women in rural Indonesia. The employment status of women is closely related to the wealth status of the family. In developing countries, women tend to be responsible for domestic affairs. If women take part in earning a living, especially in non-formal manual labor, they often come from poor families<sup>30-32</sup>.

### Conclusions

Based on the results of the analysis, it was found that low-level education is a risk factor for women's early marriage in rural areas in Indonesia. Two other variables that were also found as risk factors were low wealth status (poor) and employed.

These findings provide clear information on targets for the government to reduce the incidence of early marriage in Indonesia. It is recommended that the government set targets that focus on those with low levels of education and the poor for policies to reduce the incidence of early marriage in Indonesia.

**Source of Funding:** Self-funding

**Conflict of Interest:** The authors declare no conflict of interest, financial or otherwise.

**Ethical Clearance:** The 2017 IDHS has received ethical approval from the National Ethics Committee. All respondent identities have been deleted from the dataset. Respondents have signed and agreed to their involvement in the 2017 IDHS. Utilization of 2017 IDHS data for this research has received permission from ICF through the website: <https://dhsprogram.com/data/new-user-registration.cfm>.

### References

1. Unicef Indonesia. *Saying No to Child Marriage in Indonesia*. 2020.
2. UNFPA. *Government of Indonesia Commits to End Child Marriage*. 2020. p. 5-7.
3. BKKBN. *Survei Demografi dan Kesehatan Indonesia*. 2017.
4. Widyastari DA, Isarabhakdi P, Shaluhyah Z. Intergenerational patterns of early marriage and childbearing in Rural Central Java, Indonesia. *J Popul Soc Stud*. 2020;28(3):254-60.
5. Rahman RTA, Yuandari E. Early Marriage in Banjarmasin: The Impact on Reproductive Health and Prevention Strategy. *Int J Clin Invent Med Sci*. 2020;2(1):15-9.
6. Widyastari DA. Revisiting the New Indonesia's Marriage Act 2019 : will it be effective to prevent adolescent marriage? *INSIGHTS Public Heal J*. 2019;1(1).
7. Martin-Anatias N. On Being a "Good" Indonesian Muslim Woman: An Autoethnography. *Humanity Soc*. 2019;43(4):351-74.
8. Ningsih AP, Muis M, Syafar M, Abdullah MT. Adolescent 's Perception and Severity Related to Early Marriage, in Selayar Island. *Int J Multicult Multireligious Underst*. 2020;7(4):132-9.
9. Rahayu WD, Wahyuni, Ph.D. H. the Influence of Early Marriage on Monetary Poverty in Indonesia. *J Indones Econ Bus*. 2020;35(1):30-43.
10. Velentza C. Early Marriage and Education Drop Out in Traditional Roma Communities in Transylvania. *J Gypsy Stud*. 2020;2(1):39-54.
11. Pratiwi NL, Fitrianti Y, Nuraini S, Rachmawati T, Laksono AD, Afreni M, et al. Concealed Pregnant Women or Kemel of Gayo Ethnic in Blang Pegayon District, Gayo Lues District, Aceh. *Bull Heal Syst Res*. 2019;22(2):81-90.
12. Laksono AD, Faizin K, Raunsay EM, Soerachman R. *Muyu women in exile (Perempuan Muyu dalam Pengasingan)* [Internet]. Jakarta: Lembaga Penerbitan Balitbangkes; 2014. Available from: <https://www.scribd.com/doc/261673624/Perempuan-Muyu-dalam-Pengasingan-Riset-Etnografi-Kesehatan-2014-Boven-Digoel>
13. Laksono AD, Wulandari RD. "Children are Assets": Meta Synthesis of Child Values in the Lani and Acehnese ("Anak adalah Aset": Meta Sintesis Nilai Anak pada Suku Lani dan Suku Aceh). *J Kesehat Reproduksi*. 2019;10(1):11-20.
14. Jones GW. Which Indonesian women marry youngest, and why? *J Southeast Asian Stud*. 2001;32(1):67-78.

15. Grijns M, Horii H. Child Marriage in a Village in West Java (Indonesia): Compromises between Legal Obligations and Religious Concerns. *Asian J Law Soc.* 2018;5(2):453–66.
16. Trommlerová SK. When children have children: The effects of child marriages and teenage pregnancies on early childhood mortality in Bangladesh. *Econ Hum Biol.* 2020;39:Article number 100904.
17. Chauhan S, Sekher TV, Kumar P, Srivastava S, Patel R. Prevalence, determinants and socio-economic inequality of early marriage among men in India. *Child Youth Serv Rev.* 2020;116:Article number 105273.
18. Heidari F, Dastgiri S. The prevalence and predicting factors of female child marriage in north-west of iran: A case-control multi-center study. *Gazi Med J.* 2020;31(3):387–92.
19. Wulandari RD, Laksono AD. Education as predictor of the knowledge of pregnancy danger signs in Rural Indonesia. *Int J Innov Creat Chang.* 2020;13(1):1037–51.
20. Wulandari RD, Laksono AD. Determinants of knowledge of pregnancy danger signs in Indonesia. *PLoS One.* 2020;15(5):Article number e0232550.
21. Ipa M, Widawati M, Laksono AD, Kusri I, Dhewantara PW. Variation of preventive practices and its association with malaria infection in eastern Indonesia: Findings from community-based survey. *PLoS One.* 2020;15(5):e0232909.
22. Laksono AD, Wulandari RD. The Barrier to Maternity Care in Rural Indonesia. *J Public Heal From Theory to Pract.* 2020;Online First.
23. Rohmah N, Yusuf A, Hargono R, Laksono AD, Masruroh, Ibrahim I, et al. Determinants of teenage pregnancy in Indonesia. *Indian J Forensic Med Toxicol.* 2020;14(3):2080–5.
24. Madut KK. Determinants of Early Marriage and Construction of Gender Roles in South Sudan. *SAGE Open.* 10(2).
25. Razu SR. Determinants of early marriage among women: An experience from rural Bangladesh. *Gend Stud.* 2018;17(1):127–36.
26. Talukder A, Hasan MM, Razu SR, Hossain MZ. Early marriage in Bangladesh: A cross-sectional study exploring the associated factors. *J Int Womens Stud.* 2020;21(1):68–78.
27. Paul P. Effects of education and poverty on the prevalence of girl child marriage in India: A district-level analysis. *Child Youth Serv Rev.* 2019;100:16–21.
28. Singh R, Vennam U. Factors Shaping Trajectories to Early marriage : Evidence from Young Lives, India. *Young Lives Working Paper 149.* 2016.
29. Muharry A, Hakimi M, Wahyuni B. Family Structure and Early Marriage on Women in Indramayu Regency. *J Kesehatan Masy.* 2018;13(3):314–22.
30. Kohno A, Dahlui M, Nik Farid ND, Ali SH, Nakayama T. In-depth examination of issues surrounding the reasons for child marriage in Kelantan, Malaysia: A qualitative study. *BMJ Open.* 2019;9(9):Article number e27377.
31. Kohno A, Dahlui M, Nik Farid ND, Safii R, Nakayama T. Why girls get married early in Sarawak, Malaysia - An exploratory qualitative study. *BMC Womens Health.* 2020;20(1):Article number 46.
32. Keskiner E. Marriage decisions of Turkish second-generation women in Strasbourg: not a fate but a refuge. *Ethn Racial Stud.* 2020;43(16):231–48.

# The Border–Non-Border Areas Disparities in Hospital Utilization in Kalimantan Island, Indonesia

Agung Dwi Laksono<sup>1</sup>, Ratna Dwi Wulandari<sup>2</sup>

<sup>1</sup>Researcher, National Institute of Health Research and Development, Indonesian Ministry of Health, Jakarta, Indonesia, <sup>2</sup>Lecturer, Faculty of Public Health, Universitas Airlangga, Surabaya, Indonesia

## Abstract

The border area is one area that needs government attention. The study was aimed at analyzing disparities in hospital use in Kalimantan based on the border-non-border area category. The study was conducted using data from the 2013 Indonesian Basic Health Survey. With the multi-stage cluster random sampling method, 69,043 respondents were obtained. In the final stage, a Multinomial Logistic Regression test was performed to determine any disparities. The study results found that the utilization of inpatient at the hospital for those living in the border area has a probability of utilization of 0.653 times compared to those who live in non-border areas. Those who live in the border have a lower chance than those who live in non-border areas of using inpatient hospital. The results of the study also found 8 other predictors that influence hospital utilization among adults in Kalimantan Island, Indonesia. The eight predictors are the type of place of residence, marital, education, work type, socioeconomic, health insurance, travel time, and transportation cost. It could be concluded that there was a disparity in hospital utilization in the border–non-border areas in Kalimantan Island, Indonesia. Those living in border areas have a lower likelihood of inpatient utilization than those living in non-border areas.

**Keywords:** Disparities, hospital utilization, border areas, inpatient-outpatient, Kalimantan.

## Introduction

The government should guarantee access to the same health services for the people in its territory<sup>1</sup>. Every individual must have the same opportunity to access health services based on their needs<sup>2</sup>. Unlinking or devalue disparities utilization of health services is the concentration of health planners and policy makers<sup>3</sup>. This must be done as one of the efforts to improve the health care system performance indicator on a state.

As a referral facility, hospitals are often not built in border areas. This situation took place for reasons of transportation accessibility. The government builds hospitals in areas with better transportation availability. This condition is to ensure easier public access<sup>4</sup>.

One of the areas that have a direct border with neighboring countries is Kalimantan Island. Kalimantan is an area that has the widest border with neighboring countries (Malaysia and Brunei Darussalam). Topographically, Kalimantan Island is dominated by forest areas.

Based on the background description, the study is aimed at analyzing disparities in hospital utilization in Kalimantan based on the category border areas - non-border areas. The results of this study can be used as input for health policymakers in determining policies that can have an impact on reducing disparities in border areas.

## Materials and Method

The study was conducted by analyzing hospital utilization data from the 2013 Indonesian Basic Health Survey data. The 2013 Indonesian Basic Health Survey is a national scale survey conducted by the National Institute of Health Research and Development. The use of hospitals includes public and private hospitals. The unit of analysis in this study was the Indonesian population on Kalimantan Island, aged 15 years and over. At that age, it was assumed that the respondent is an adult, could make his own decision whether to use the hospital or not. Globally, Riskesdas was conducted with a sample size of 1,027,763 individuals. The sample

analyzed based on the unit of analysis was 69,043 respondents.

The category of hospital utilization was public access to the hospital, whether it was outpatient or inpatient. Based on the data received, outpatient variables were those carried out by the respondent in the past month. Being hospitalized was what the respondent did in the past year. The decision to use this time limit assumes that the respondent could remember both the outpatient and inpatient events well. The border area category was the regency/city on Kalimantan Island which was directly adjacent to neighboring countries (Malaysia and Brunei Darussalam). There were 7 border districts out of 55 regencies/cities, namely Sambas, Bengkayang, Sanggau, Sintang, Kapuas Hulu, Malinau, and Nunukan.

In the early stages of statistical analysis, Chi-Square was used for dichotomous variables and t-test for continuous variables. This test was used to assess whether there was a statistically significant difference in border-non-border areas. Based on the dependent variable (ordinal) category, the estimation was carried out using the binomial logistic regression test to study the disparities between border-non-border areas in

hospital utilization and to check ORs and their statistical significance.

## Results and Discussion

Based on Table 1, it can be seen that there is a statistically significant difference in hospital utilization between border-non-border areas observed in all characteristics, except age characteristics. Table 1 shows that both regions have greater utilization of inpatient care than outpatient care.

The population in Kalimantan predominantly lives in urban areas, both those categorized as border areas and non-border areas. Meanwhile, based on their gender, those on the border were more dominant by men, while those living outside the border were dominated by women. In general, those who were divorced mostly lived in non-border areas.

Table 1 shows that both the border area and the non-border area are dominated by people with primary school education and below. Meanwhile, the type of work in the border areas is dominated by those who work as farmers/fishermen/labor, while those who live in non-border areas are dominated by those who do not have a job.

**Table 1. Descriptive statistic(n=69,043)**

Characteristic	Area		All	P
	Border	Non-Border		
<b>Hospital Utility</b>				0.000
• Outpatient	59 (0.6%)	516 (0.9%)	575 (0.8%)	
• Inpatient	78 (0.8%)	897 (1.5%)	975 (1.4%)	
• Outpatient + inpatient	26 (0.3%)	139 (0.2%)	165 (0.2%)	
• No utilization	9458 (98.3%)	57870 (97.4%)	67328 (97.5%)	
<b>Type place of residence</b>				0.000
• Urban	3076 (32.0%)	26972 (45.4%)	30048 (43.5%)	
• Rural	6545 (68.0%)	32450 (54.6%)	38995 (56.5%)	
Age (mean)	9621 (38.40)	59422 (38.69)	69043 (38.65)	0.083
<b>Gender</b>				
• Male	4890 (50.8%)	29010 (48.8%)	33900 (49.1%)	
• Female (Ref.)	4731 (49.2%)	30412 (51.2%)	35143 (50.9%)	
<b>Marital status</b>				0.000
• Single	2372 (24.7%)	12500 (21.0%)	14872 (21.5%)	
• Married	6722 (69.9%)	42558 (71.6%)	49280 (71.4%)	
• Divorce (Ref.)	527 (5.5%)	4364 (7.3%)	4891 (7.1%)	

Characteristic	Area		All	P
	Border	Non-Border		
<b>Education level</b>				0.000
• Primary school & under	5361 (55.7%)	29038 (48.9%)	34399 (49.8%)	
• Junior high school	1952 (20.3%)	12184 (20.5%)	14136 (20.5%)	
• Senior high school	1749 (18.2%)	14117 (23.8%)	15866 (23.0%)	
• College (Ref.)	559 (5.8%)	4083 (6.9%)	4642 (6.7%)	
<b>Work type</b>				0.000
• No work	3257 (33.9%)	23677 (39.8%)	26934 (39.0%)	
• Public servant/army/police	481 (5.0%)	3361 (5.7%)	3842 (5.6%)	
• Employee	443 (4.6%)	5489 (9.2%)	5932 (8.6%)	
• Entrepreneur	1305 (13.6%)	9079 (15.3%)	10384 (15.0%)	
• Farmer/Fisherman/Labor	3644 (37.9%)	15312 (25.8%)	18956 (27.5%)	
• Others (Ref.)	491 (5.1%)	2504 (4.2%)	2995 (4.3%)	
<b>Socioeconomic status</b>				0.000
• Quintile 1	2264 (23.5%)	9707 (16.3%)	11971 (17.3%)	
• Quintile 2	1796 (18.7%)	10701 (18.0%)	12497 (18.1%)	
• Quintile 3	1796 (18.7%)	11697 (19.7%)	13493 (19.5%)	
• Quintile 4	1636 (17.0%)	11989 (20.2%)	13625 (19.7%)	
• Quintile 5 (Ref.)	2129 (22.1%)	15328 (25.8%)	17457 (25.3%)	
<b>Insurance</b>				0.000
• No insurance	4644 (48.3%)	28518 (48.0%)	33162 (48.0%)	
• Askes, Jamkesmas, Jamkesda, Jamsostek	4913 (51.1%)	29115 (49.0%)	34028 (49.3%)	
• Others (Ref.)	64 (0.7%)	1789 (3.0%)	1853 (2.7%)	
<b>Travel time</b>				0.000
• ≤15 Minutes	2136 (22.2%)	23065 (38.8%)	25201 (36.5%)	
• >15 Minutes (Ref.)	7485 (77.8%)	36357 (61.2%)	43842 (63.5%)	
<b>Transportation Cost</b>				0.000
• ≤IDR 15,000	2140 (22.2%)	25928 (43.6%)	28068 (40.7%)	
• >IDR 15,000	7481 (77.8%)	33494 (56.4%)	40975 (59.3%)	

**Note:** Chi-Square test was used for dichotomous variables and a T-test for continuous variables.

Based on socioeconomic status, the border areas are dominated by those in quintile 1 (the poorest), while those in non-border areas are dominated by those in quintile 5 (the richest). Based on the ownership of insurance in the two regions, it is dominated by those who have insurance managed by the government (Askes, Jamkesmas, Jamkesda, Jamsostek), although with a slightly higher proportion who do not have insurance at all.

Based on the travel time it takes for the community to get to the hospital, table 1 shows that in the two dominant regions the travel time is over 15 minutes. But with a bigger proportion in the border area. This condition is in line with the transportation costs required to get to the hospital. In the border area, people who need transportation costs more than IDR 15,000 have a larger proportion.

**Table 2. The results of multinomial logistic regression (n=69,043)**

Predictor	Outpatient			Inpatient			Outpatient + Inpatient		
	OR	Lower Bound	Upper Bound	OR	Lower Bound	Lower Bound	OR	Lower Bound	Upper Bound
Region: Border	0.936	0.711	1.232	0.653*	0.516	0.826	1.510	0.983	2.319
Type of place of residency: Urban	1.250*	1.007	1.553	0.980	0.834	1.151	1.138	0.770	1.682
Gender: Male	1.111	0.914	1.351	1.097	0.944	1.275	1.141	0.793	1.643
Marital Status: single	0.244*	0.167	0.357	0.351*	0.264	0.466	0.324*	0.156	0.673
Marital Status: married	0.631*	0.477	0.835	0.741*	0.597	0.921	0.883	0.510	1.530
Education: under primary school	0.846	0.601	1.192	1.001	0.755	1.326	0.698	0.382	1.276
Education: junior high school	0.776	0.544	1.109	0.766	0.569	1.030	0.471*	0.245	0.905
Education: senior high school	0.894	0.660	1.210	0.786	0.603	1.023	0.469*	0.261	0.843
Work: No work	2.109*	1.245	3.573	1.311	0.949	1.813	0.833	0.457	1.518
Work: Public servant/army/police	1.578	0.876	2.841	0.839	0.557	1.264	0.267*	0.111	0.645
Work: Employee	1.362	0.763	2.430	0.869	0.596	1.267	0.277*	0.118	0.646
Work: Entrepreneur	1.350	0.775	2.351	0.816	0.573	1.160	0.396*	0.195	0.803
Work: Farmer/fisherman/labor	1.253	0.711	2.207	0.703*	0.495	0.999	0.407*	0.202	0.821
Socioeconomic: quintile 1	0.326*	0.214	0.498	0.453*	0.342	0.599	0.352*	0.171	0.727
Socioeconomic: quintile 2	0.494*	0.358	0.683	0.712*	0.571	0.888	0.575	0.330	1.002
Socioeconomic: quintile 3	0.629*	0.484	0.817	0.686*	0.561	0.839	0.641	0.395	1.041
Socioeconomic: quintile 4	0.785*	0.633	0.975	0.855	0.718	1.018	0.864	0.575	1.300
Insurance: No insurance	0.252*	0.176	0.362	0.348*	0.259	0.467	0.210*	0.113	0.391
Insurance: Askes, Jamkesmas, Jamkesda, Jamsostek	0.606*	0.434	0.846	0.621*	0.468	0.824	0.392*	0.219	0.704
Travel time: ≤30 Minutes	1.514*	1.193	1.923	1.319*	1.098	1.586	0.995	0.650	1.523
Transportation cost: ≤IDR 15,000	1.189	0.938	1.508	1.243*	1.037	1.492	1.875*	1.210	2.906

**Note:** The reference category is “No Utilization”; 95% Confidence Interval for OR; \*Significant at level 95%.

Table 2 presents the results of the multinomial logistic regression test to describe the differences in hospital utilization in border areas - non-border areas in Kalimantan. As a reference, the category “no utilization” was selected. Table 2 shows that in inpatient utilization in the hospital, those living in border areas had 0.653 times the probability of utilization compared to those living in non-border areas (OR 0.653; 95% CI 0.516-0.826). This means that those who live in border areas have a lower chance than those who live in non-border areas to use inpatient care at the hospital. Meanwhile, both outpatient and outpatient and inpatient utilization did not show a statistically significant difference between the two regions.

To overcome disparities in hospital utilization in border areas, the Government of Indonesia has issued a special policy on disadvantaged areas, borders, and islands. This policy was released to reduce inequality in health services in these special areas, including border areas<sup>5,6</sup>.

Table 2 also shows the differences in hospital utilization based on the type of place of residence. Those who live in urban areas are 1.250 times more likely to benefit from outpatient hospital care than those who live in rural areas (OR 1.250; 95% CI 1.007-1.553). Based on their marital status, those who are single and married have a lower chance of utilization than those who are divorced. This condition applies to both outpatient and inpatient utilization.

Disparities of hospital utilization related to rurality do not only happen in Indonesia. The research results with the focus of disparities in many countries reporting the disparities existing, among others in China, Canada, and Ethiopia.<sup>7-9</sup>

Based on the education level, Table 2 shows that the categories of utilization, as well as outpatient and inpatient in the junior high school and senior high school, are likely to be lower than those with a college education. Meanwhile, in the category of work type, those who do not work have the possibility of using outpatient at the hospital 2.109 times those who work in other categories (OR 2.109; 95% CI 1.245-3.573). Higher education levels are often found to be positive predictors of health performance<sup>10,11</sup>. Otherwise, a low education level is a barrier to performance in the health sector<sup>12,13</sup>.

Meanwhile, in outpatient utilization, the better the socioeconomic level, the better the possibility of outpatient utilization. This condition also applies to the use of inpatient. The same condition can be seen in the category of insurance ownership. Those with government-managed insurance had a better chance of using hospitals than those without, and those with privately-managed insurance had better utilization rates than those with government-managed insurance. Similar information is also found in previous studies<sup>14,15</sup>

Table 2 shows that those with a travel time of less than or equal to 30 minutes had a chance of using outpatient hospitals 1.514 times than those with a travel time of more than 30 minutes (OR 1.514; 95% CI 1.193-1.923). Meanwhile, those with transportation costs of less than IDR 15,000 were more likely to use inpatient care 1.243 times than those who had transportation costs of more than IDR 15,000 (OR 1.243; 95% CI 1.037-1.492). On a broader national scale, travel time and transportation costs are also found to be determinants of hospital utilization<sup>16-18</sup>.

## Conclusions

Based on the research results, it can be concluded that there is a disparity of hospital utilization in the border - non-border areas in Kalimantan Island, Indonesia. Those living in border areas have a lower likelihood of inpatient utilization than those living in non-border areas.

The results also found 8 other predictors that affect hospital utilization among adults in Kalimantan Island, Indonesia. The eight predictors are the type of place of

residence, marital status, education level, work type, socioeconomic status, health insurance, travel time, and transportation cost.

**Acknowledgments:** The author would like to thank the NIHRD for allowing the use of the 2013 Indonesian Basic Health Survey.

**Source of Funding:** Self-funding

**Conflict of Interest:** The authors declare no conflict of interest, financial or otherwise.

**Ethical Clearance:** The 2013 Indonesian Basic Health Survey had ethical clearance that was approved by the national ethical committee in the NIHRD (ethic number: 01.1206.207). Informed consent was used during data collection, which considered aspects of data collection procedure, voluntary, and confidentiality.

## References

1. Tzeng H-M, Okpalauwaekwe U, Yin C-Y, Jansen SL, Feng C, Barker A. Do patients' demographic characteristics affect their perceptions of self-care actions to find safe and decent care? *Appl Nurs Res.* 2018;43:24-9.
2. Mubasyiroh R, Nurhotimah E, Laksono AD. Health Service Accessibility Index in Indonesia (Indeks Aksesibilitas Pelayanan Kesehatan di Indonesia). In: Supriyanto S, Chalidyanto D, Wulandari RD, editors. *Accessibility of Health Services in Indonesia (Aksesibilitas Pelayanan Kesehatan di Indonesia)*. Jogjakarta: PT Kanisius; 2016. p. 21-58.
3. Li J, Shi L, Liang H, Ding G, Xu L. Urban-rural disparities in health care utilization among Chinese adults from 1993 to 2011. *BMC Health Serv Res.* 2018;18(102):1-9.
4. Song Y, Tan Y, Song Y, Wu P, Cheng JCP, Kim MJ, et al. Spatial and temporal variations of spatial population accessibility to public hospitals: a case study of rural-urban comparison. *GIScience Remote Sens.* 2018;55(5):718-44.
5. Senewe FP, Elsi E. Descriptive Analysis to Environment Health in Less Development, Borderlands, Archipelagoes and Remote Areas (DTPK-T). *Media Litbangkes.* 2014;24(3):153-60.
6. Suharmiati, Laksono AD, Astuti WD. Policy Review on Health Services in Primary Health Center in the Border and Remote Area (Review

- Kebijakan tentang Pelayanan Kesehatan Puskesmas di Daerah Terpencil Perbatasan). *Bull Heal Syst Res.* 2013;16(2):109–16.
7. Li C, Yao NA, Yin A. Disparities in dental healthcare utilization in China. *Community Dent Oral Epidemiol.* 2018;
  8. Loree JM, Javaheri KR, Lefresne SV, Speers CH, Ruan JY, Chang JT, et al. Impact of Travel Distance and Urban-Rural Status on the Multidisciplinary Management of Rectal Cancer. *J Rural Heal.* 2017;33(4).
  9. Bobo FT, Yesuf EA, Woldie M. Inequities in utilization of reproductive and maternal health services in Ethiopia. *Int J Equity Health.* 2017;16(9).
  10. Wulandari RD, Laksono AD. Education as predictor of the knowledge of pregnancy danger signs in Rural Indonesia. *Int J Innov Creat Chang.* 2020;13(1):1037–51.
  11. Ipa M, Widawati M, Laksono AD, Kusriani I, Dhewantara PW. Variation of preventive practices and its association with malaria infection in eastern Indonesia: Findings from community-based survey. *PLoS One.* 2020;15(5):e0232909.
  12. Rohmah N, Yusuf A, Hargono R, Laksono AD, Masruroh, Ibrahim I, et al. Determinants of teenage pregnancy in Indonesia. *Indian J Forensic Med Toxicol.* 2020;14(3):2080–5.
  13. Laksono AD, Wulandari RD. The Barrier to Maternity Care in Rural Indonesia. *J Public Heal From Theory to Pract.* 2020;Online First.
  14. Wulandari RD, Qomarrudin MB, Supriyanto S, Laksono AD. Socioeconomic Disparities in Hospital Utilization among Elderly People in Indonesia. *Indian J Public Heal Res Dev.* 2019; 10(11):1800-4.
  15. Nasution SK, Mahendradhata Y, Trisnantoro L. Can a National Health Insurance Policy Increase Equity in the Utilization of Skilled Birth Attendants in Indonesia? A Secondary Analysis of the 2012 to 2016 National Socio-Economic Survey of Indonesia. *Asia-Pacific J Public Heal.* 2020;32(1):19–26.
  16. Laksono AD, Wulandari RD, Soedirham O. Urban and Rural Disparities in Hospital Utilization among Indonesian Adults. *Iran J Public Health [Internet].* 2019;48(2):247–55. Available from: <http://ijph.tums.ac.ir/index.php/ijph/article/view/16143>
  17. Laksono AD, Wulandari RD, Soedirham O. Regional Disparities of Health Center Utilization in Rural Indonesia. *Malaysian J Public Heal Med.* 2019;19(1).
  18. Laksono AD, Wulandari RD, Efendi F. Determinants of hospital utilisation among urban poor societies in Indonesia. *Int J Innov Creat Chang.* 2020; 12(9):375–87.



# Case-Control Analysis of Malaria Incidence in Sukamerindu Health Center Bengkulu City, Indonesia

Agung Sutriyawan<sup>1</sup>, Tenike G. Miranda<sup>2</sup>, Ucu W. Somantri<sup>3</sup>, Hairil Akbar<sup>4</sup>

<sup>1</sup>Research Scholar, Bachelor Programme Public Health, Bhakti Kencana University, <sup>2</sup>Research Scholar, Graduate Program Public Health, University Respati of Indonesia, <sup>3</sup>Research Scholar, Bachelor Programme Public Health, Mathla ul Anwar University, <sup>4</sup>Research Scholar, Graha Medika Institute of Health Science

## Abstract

**Background:** Malaria is still one of the public health problems that can cause death primarily in high-risk groups. High incidence of malaria caused by unhealthy environment and patterns of Society behavior.

**Objectives:** Assessing the relationship between environmental factors and the society behavior factors with malaria incidence.

**Method:** This is a case-control study. Samples were taken using sampling purposive with criteria: Age 7-50 years and case groups were noted as clinical malaria patients. Data is collected by observing and filling out questionnaires. Risk factors are analyzed using the Chi-Square test, knowing the risks with the odds ratio. The dominant risk factors were analyzed using binary logistic regression.

**Results:** The variable associated with the malaria incident is ventilation (0,000), 2.5 (1.6-4.1), ceiling (0,015), 1.7 (1.1-2.7), puddles around the house (0,005), 1.9 (1.2-3.0), using of mosquito nets (0,000), 4.1 (2.4-6.4) and using mosquito repellent (0.001), 2,2 (1,4-3,5).

**Conclusion:** The proven environmental factors associated with malaria incidents are ventilation, ceilings, and puddles around the house. The Society behavior factor associated with malaria incidents is using mosquito nets and using mosquito repellent. Proves that the use of mosquito nets is a major risk factor for malaria incidents, with a risk of 4.3 times greater in those who when sleeping at night do not use mosquito nets.

**Keywords:** Malaria, environment, society behavior, mosquito nets.

## Introduction

Malaria is still one of the public health problems. The World Health Organization (WHO) has called for an ambitious commitment to eliminate malaria in 35 countries by the year 2030. All heads of state in the Asia-Pacific region have been committed to eradicating national malaria. Malaria programs are faced with the

challenge of malaria epidemiology changes. In this phase, an increase in the proportion of malaria imported and high-risk groups is often no longer children and pregnant women, but more associated with demographic risk factors and specific occupations for local arrangements. The transmission also becomes more geographically focused and is more likely to be reproduced through asymptomatic infections and non-falciparum.<sup>1</sup>

Each year more than 500 million people are infected with malaria and more than 1 million individuals die. Most cases in Africa and some Asian countries, Latin America, the Middle East, and some parts of Europe. The number of cases and deaths from malaria recorded in 2000 to 50% or more at the end of the year 2010 and

---

### Corresponding Author:

Agung Sutriyawan

Research Scholar, Bachelor Programme Public Health,  
Bhakti Kencana University  
e-mail: agung.epid@gmail.com

75% or more at the end of the year 2015.<sup>2</sup> Conditions in Indonesia tend to decline, but from 34 provinces in Indonesia, there are 8 provinces with Annual Parasite Incidence (API) numbers exceeding nationwide. The highest API took place in Papua (31.93) and West Papua (31.29) then East Nusa Tenggara, Maluku, North Maluku, Bengkulu, Bangka Belitung, and North Sulawesi.

Active and timely identification of related risk factors is crucial to target interventions to optimize malaria control.<sup>3</sup> Environmental risk factors affecting mosquito density *Anopheles* are divided into two, which are outdoor environment consisting of air temperature, humidity, rain, wind, sunlight, water currents, water puddle, ditch, paddy field, bushes, and large animal livestock cage. While the risk factors inside the house consist of gauze wire on ventilation, wall density, ceiling and clothes hanging.<sup>4</sup>

Bengkulu is one of the provinces whose API numbers still exceed national figures. Based on the health profile of Bengkulu Province in 2016 the number of malaria sufferers without blood supply is as much as 33,814, while with a blood supply test of 28,333 sufferers and test results there is 2,631 positive malaria. The highest case in North Bengkulu Regency was 1097 cases and the lowest in Heroiang district amounted to 4 cases, while in the city of Bengkulu amounted to 96 cases and 1 of them died. The city of Bengkulu kept the position to 6 highest in 10 regencies in Bengkulu Province whereas the city of Bengkulu is an urban area and Regency/city with the most advanced economy in 10 districts/cities and is mostly urban areas. Three health centers in Bengkulu with sufferers of the highest suspect malaria is Puskesmas Sukamerindu (1208 cases). There were increased cases of malaria in Pukesmas Sukamerindu in 2015 amounted to 926 sufferers, and increased in the year 2016 to 1,208 cases.

## Material and Method

The design used in this study is quantitative case-control. Case population, all people who were declared clinical malaria based on data at the Sukamerindu Public Health Center. While control is taken from the case of neighbors who are free of malaria. The total sample of cases is 150 cases and 150 controls. Samples were taken using purposive sampling with the following criteria: Ages 7-50 years and case groups were recorded as clinical malaria patients. Data collection is done by two method, namely: first, interviews with the use of

questionnaires, made as much as possible in a familiar atmosphere so that the interview can run smoothly and managed to get the information expected. Secondly, the observation method is conducted by researchers formally and informally to observe the activities in the field.

Data were collected by observing environmental variables: ventilation, walls, ceilings, standing water around the house, trenches around the house, and bushes around the house. While society behavior factors are taken by filling out questionnaires and interviews with respondents. Risk factors were analyzed using the chi-square test, to determine the magnitude of the risk using the Odds ratio (OR). After that, a multivariate analysis was performed using multiple logistic regression.

## Findings:

**Tabel 1. Characteristics of Respondents in the Study**

Characteristics	n = 350	Percentage (%)
<b>Age (years)</b>		
< 10	14	4,7
10-19	55	18,3
20-29	97	32,3
30-39	60	20,0
40-50	74	24,7
<b>Sex</b>		
Men	178	59,3
Women	122	40,7
<b>Education</b>		
No school	58	19,3
Elementary school	62	20,7
Middle School	77	25,7
High school	52	17,3
College	51	17,0
<b>Job</b>		
Labor	43	14,3
Farmers	46	15,3
Traders	50	16,7
General employees	51	17,0
Government employees	16	5,3
Other	94	31,3

The results showed most of the participants aged between 20-29 years (32.3%) and men (59.3%). Most of the participants were low education and as workers.

**Table 2. Chi-Square Test of Environmental Factors Related To Malaria Incidence**

Environmental Factor	Malaria Incidence				P-value	OR(95% CI)	
	Case		Control			Lower	Upper
	n=150	%	n=150	%			
<b>Ventilation</b>					0,000*	2,588 1,625-4,122	
Not Qualify	92	61,3	57	38,0			
Qualify	58	38,7	93	62,0			
<b>Wall</b>					0,105	1,456 0,923-2,295	
Not Qualify	78	52,0	64	42,7			
Qualify	72	48,0	86	57,3			
<b>Ceiling</b>					0,015*	1,763 1,114-2,788	
Not Qualify	80	53,3	59	39,7			
Qualify	70	46,7	91	60,7			
<b>There are puddles around the house</b>					0,015*	1,758 1,113-2,778	
Yes	88	58,7	67	44,7			
Not	62	41,3	83	55,3			
<b>There are trenches around the house</b>					0,005*	1,930 1,215-3,068	
Yes	97	64,7	73	48,7			
Not	53	35,4	77	41,3			
<b>There are bushes around the house</b>					0,406	1,218 0,64-1,942	
Yes	61	40,7	54	36,0			
Not	89	59,3	96	64,0			

\* Significant < 0,05

The study showed that environmental factors that were significantly related to the malaria incident were kolowa ventilation (p = 0,000), OR = 2, 5 (1, 6-4.1), ceiling (p = 0,015), OR = 1.7 (1, 7-2.7), and puddles

around the house (P = 0,005), OR = 1.9 (1, 2-3.0). While the wall, life around the house, bushes around the house are not proven to be a risk factor for malaria incidents.

**Tabel 3. Chi-Square Test of Society Behavior Factors Related To Malaria Incidence**

Society Behavior Factors	Malaria Incidence				P-value	OR(95% CI)	
	Case		Control			Lower	Upper
	n=150	%	n=150	%			
<b>Knowledge</b>					0,354	1,240 0,787-1,956	
High	86	57,3	78	52,0			
Low	64	42,7	72	48,0			
<b>Attitude</b>					0,907	1,028 0,649-1,627	
Positive	63	42,0	62	41,3			
Negative	78	58,0	88	58,7			
<b>Using mosquito nets</b>					0,000*	4,011 2,480-6,487	
Yes	103	68,7	53	35,3			
Not	47	31,3	97	64,7			

Society Behavior Factors	Malaria Incidence				P-value	OR(95% CI)	
	Case		Control			Lower	Upper
	n=150	%	n=150	%			
<b>Using mosquito repellent</b>						0,001*	2,250 1,418-3,572
Yes	91	60,7	61	40,7			
Not	59	39,4	89	59,3			
<b>Using long sleeves when out of the house at night</b>						0,130	1,424 0,900-2,251
Yes	91	60,7	78	52,0			
Not	59	39,3	72	48,0			
<b>The habit of hanging dirty clothes</b>						0,296	1,276 0,808-2,014
Yes	88	58,7	79	52,7			
Not	62	41,3	71	47,3			

\* Significant < 0,05

The study showed that the society’s behavior factors that were significantly related to the malaria incident were using mosquito nets (P = 0,000), OR = 4.1 (2, 4-6.4), and using mosquito repellent (p = 0.001), OR

= 2.2 (1.4-3.5). While knowledge, attitude, using long sleeves when out of the house at night, and habit of hanging dirty clothes are not proven to be a risk factor for malaria incidents.

**Table 4. Multiple Logistic Regression Test Results For The Final Risk Factor Related of Malaria Incidence**

Risk Factor	r <sup>2</sup>	P-value	OR	95% CI for EXP (B)	
				Lower	Upper
Ventilation	0,071	0,000*	2,892	1,692	4,755
Trenches around the house	0,034	0,005*	2,097	1,250	3,517
Using of mosquito nets	0,143	0,000*	4,362	2,594	7,335
Using mosquito repellent	0,053	0,008*	1,981	1.191	3,296

\* Significant< 0,05

Multivariate analyses were conducted to view several risk factors that were jointly associated with malaria incidents. The dominant risk factors for malaria incidents are using mosquito nets.

### Discussion

**Environmental Factors:** The study was conducted to assess the physical environmental factors of the home consisting of ventilation, Wall, and Ceiling. In the population, studies proved that ventilation is a risk factor for malaria events. Their risk of suffering from malaria if not attaching a gauze wire to the ventilation is doubling. The results of the survey have mostly used

gauze on home ventilation. But in some houses that have been installed wire gauze, researchers found damaged wire gauze such as perforated and torn Karna has long been not replaced. But there is still also a house that does not use a gauze wire in ventilation, although it uses only partially ventilation as it is installed only in the room only. A study in Banjarnegara, Indonesia suggests that people who do not put mosquito nets in their home vents have significantly higher chances of having malaria. Wire netting is a barrier against mosquitoes entering the house.<sup>5</sup>

This study proves that the ceiling is a risk factor for malaria events. With a risk of 1.7 times greater in those

who live at home do not have a ceiling. Another study in Indonesia proved the same, in-house environmental factors that do not have a significant risk of malaria incidence is the condition of the wall.<sup>6,7</sup>

Environmental factors outside the home are proving to be a risk factor for malaria events are puddles around the house and life around the house. Studies in Uganda suggest that malaria-repellent mosquitoes breed in puddles and are often found near homes especially in rural communities in endemic countries. This is an indication that conditions that support the breeding of mosquitoes are allowed in the community.<sup>8</sup> Another study in Africa showed that the productivity of the highest *Anopheles* larva was observed in paddy fields, agricultural moats, and irrigation wells.<sup>9</sup>

The results of observation, some puddle of water such as the former Fish pond and the former pit around the respondent's house there is a mosquito larva, but this study is not done further to identify whether the larva found is a mosquito repellent *Anopheles* or not. Observation results are also obtained in almost every house adjacent to the ditch/ditch. When the trenches observation does not flow well so there are a lot of inundated trenches that could potentially be a place for mosquitoes to be missed.

This study cannot prove that a tightly-wall can prevent the occurrence of malaria. The results of the survey, in general, the wall condition of many respondents house made of concrete or cement. In some homes based on boards, some respondents closed the holes with tape or paper pasted between the boards so that mosquitoes did not go through the holes. The study also could not prove the bush around the house was a risk factor for malaria events.

The Gordon model known by a Trias epidemiology of infectious diseases is influenced by three main factors namely the host, agent, and environment.<sup>10</sup> The intended environment includes sanitation, the physical environment of the home, and the environment around the house. Poor sanitation is not only directly related to infectious diseases but can also affect the health of children.<sup>11</sup> The physical environment of the home such as ventilation and ceilings, as well as the environment that exists outside the home is closely related to the incidence of infectious diseases such as malaria.

**Society Behavior Factors:** The study also assessed the relationship of community behavior factors. The

study reported that knowledge and attitudes were not proven significantly with the incidence of malaria. The study was conducted in urban areas, with most of the respondents well-educated, so that society has a good knowledge of malaria. Knowledge of taking medication, malaria test, and vector control by spraying at home. It is important to keep a clean trench around the house so that people are protected from illness.<sup>12</sup> The study in South Africa stated differently, that knowledge and attitudes were significantly related to the incidence of infectious diseases, one of which was malaria.<sup>13</sup>

This study proved that the use of mosquito nets was significantly related to malaria events. Some previous studies have expressed the use of mosquito nets associated with malaria events.<sup>14,15</sup> A double logistic regression test proves that the use of mosquito nets is a major risk factor of malaria. Chances of suffering from malaria in those who sleep at night do not use a mosquito net of 4.3 times larger. A previous study in Central Java province, Indonesia expressed sleep under mosquito nets is a technique to protect from mosquito bites. In this study, people who slept under the mosquito net had a lower chance (4.6 times) suffering from malaria than those who did not.<sup>16</sup> Another study conducted in China-Vietnam suggested that the effect of the control-based prevention measures vector. Those who do not sleep under the mosquito nets have more than 5 times higher chances of experiencing asymptomatic infections compared to those sleeping under the mosquito nets.<sup>17</sup>

The study also proved that Using mosquito repellent is a risk factor for malaria. The respondent did not use mosquito repellent because it does not like the smell of mosquito repellent. Studies in India have said that the use of mosquito repellent is effective in preventing mosquito bites. This study can not prove Using long sleeves when out of the house at night and the Habit of hanging dirty clothes is significantly related to malaria.

## Conclusion

The proven environmental factors related to malaria incidents are ventilation, ceiling, and puddles around the house. The Society's proven behavior factors related to malaria incidents are using mosquito nets and using mosquito repellent. This study proves that using mosquito nets is a major risk factor for malaria incidents, with a risk magnitude of 4.3 times greater in those who do not use mosquito nets during nighttime sleep.

**Conflict of Interest:** All authors do not have a conflict of interest to declare related to research and work.

**Source of Funding:** The source of this research costs from self.

**Ethical Clearance:** The study was approved by the institutional Ethical Board of Bhakti Kencana University.

## References

- Herdiana H, Cotter C, Coutrier FN, Zarlinda I, Zelman BW, Tirta YK, et al. Malaria risk factor assessment using active and passive surveillance data from Aceh Besar, Indonesia, a low endemic, malaria elimination setting with *Plasmodium knowlesi*, *Plasmodium vivax*, and *Plasmodium falciparum*. *Malar J* [Internet]. 2016;15(1):468. Available from: <https://link.springer.com/article/10.1186/s12936-016-1523-z>
- Organization WH. World malaria report 2015. World Health Organization; 2016.
- Rulisa S, Kateera F, Bizimana JP, Agaba S, Dukuzumuremyi J, Baas L, et al. Malaria prevalence, spatial clustering and risk factors in a low endemic area of Eastern Rwanda: a cross sectional study. *PLoS One* [Internet]. 2013;8(7):e69443. Available from: <https://journals.plos.org/plosone/article?id=10.1371/journal.pone.0069443>
- Arsin AA. Malaria in Indonesia reviews epidemiological aspects. Makassar, masagenapress. 2012;
- Sulistiyawati, Rokhmayanti, Fajar. Malaria Risk Factors in Banjarnegara, Indonesia: A Matched Case-Control Study. *J UOEH* [Internet]. 2020;42(2):161–6. Available from: <https://pubmed.ncbi.nlm.nih.gov/32507839/>
- Irawati I, Ishak H, Arsin A. Environmental Characteristics of Malaria Patients in Bulukumba Regency. *Afiasi J Kesehat Masy* [Internet]. 2019;2(3):73–7. Available from: <http://afiasi.unwir.ac.id/index.php/afiasi/article/view/47>
- Wiwoho FH, Hadisaputro S, Suwondo A. Risk Factors for Malaria Incidence in Cluwak Health Center and Dukuhseti Health Center Pati. *J Epidemiol Kesehat Komunitas* [Internet]. 2018;1(1):1–8. Available from: <https://www.neliti.com/publications/301965/faktor-risiko-kejadian-malaria-di-puskesmas-cluwak-dan-puskesmas-dukuhseti-kabup>
- Musoke D, Miir G, Ndejjo R, Karani G, Morris K, Kasasa S, et al. Malaria prevention practices and associated environmental risk factors in a rural community in Wakiso district, Uganda. *PLoS One* [Internet]. 2018;13(10):e0205210. Available from: <https://pubmed.ncbi.nlm.nih.gov/30300396/>
- Matthys B, N’Goran EK, Koné M, Koudou BG, Vounatsou P, Cissé G, et al. Urban agricultural land use and characterization of mosquito larval habitats in a medium-sized town of Côte d’Ivoire. *J Vector Ecol* [Internet]. 2006 Dec;31(2):319–33. Available from: <https://pubmed.ncbi.nlm.nih.gov/17249350/>
- Sumampouw OJ. Eradication of Infectious Diseases [Internet]. Deepublish; 2017. Available from: [https://books.google.co.id/books?hl=id&lr=&id=UkZHDwAAQBAJ&oi=fnd&pg=PR6&dq=faktor+risiko+penyakit+menular&ots=Oqw1Yp9QES&sig=OtaC4kXKDFxc5-rBWMGUY3OCehg&redir\\_esc=y#v=onepage&q=faktor+risiko+penyakit+menular&f=false](https://books.google.co.id/books?hl=id&lr=&id=UkZHDwAAQBAJ&oi=fnd&pg=PR6&dq=faktor+risiko+penyakit+menular&ots=Oqw1Yp9QES&sig=OtaC4kXKDFxc5-rBWMGUY3OCehg&redir_esc=y#v=onepage&q=faktor+risiko+penyakit+menular&f=false)
- Sutriyawan A, Nadhira CC. Kejadian Stunting Pada Balita Di Upt Puskesmas Citarip Kota Bandung. *J Kesmas (Kesehatan Masyarakat) Khatulistiwa* [Internet]. 2020;7(2):79–88. Available from: <http://openjurnal.unmuhpnk.ac.id/index.php/JKMK/article/view/2072>
- Moliner-Gallón LF, Hernández-Carrillo M, Castro-Espinosa J, Trujillo de Cisneros E. [Knowledge, attitudes, perceptions and community practices for urban malaria. Tumaco, Colombia]. *Rev Salud Publica (Bogota)* [Internet]. 2018 ;20(1):82–8. Available from: <https://pubmed.ncbi.nlm.nih.gov/30183889/>
- Govere J, Durrheim D, la Grange K, Mabuza A, Booman M. Community knowledge and perceptions about malaria and practices influencing malaria control in Mpumalanga Province, South Africa. *S Afr Med J* [Internet]. 2000 Jun;90(6):611–6. Available from: <https://pubmed.ncbi.nlm.nih.gov/10918892/>
- Durnez L, Pareyn M, Mean V, Kim S, Khim N, Menard D, et al. Identification and characterization of areas of high and low risk for asymptomatic malaria infections at sub-village level in Ratanakiri, Cambodia. *Malar J* [Internet]. 2018;17(1):27. Available from: <https://pubmed.ncbi.nlm.nih.gov/29334956/>

15. Belete EM, Roro AB. Malaria prevalence and its associated risk factors among patients attending Chichu and Wonago Health Centres, South Ethiopia. *J Res Health Sci* [Internet]. 2016;16(4):185. Available from: <https://pubmed.ncbi.nlm.nih.gov/28087849/>
16. Cahyaningrum P, Sulistyawati S. Malaria risk factors in Kaligesing, Purworejo district, central Java province, Indonesia: a case-control study. *J Prev Med Public Heal* [Internet]. 2018;51(3):148. Available from: <https://pubmed.ncbi.nlm.nih.gov/29886710/>
17. Zhao Y, Zeng J, Zhao Y, Liu Q, He Y, Zhang J, et al. Risk factors for asymptomatic malaria infections from seasonal cross-sectional surveys along the China–Myanmar border. *Malar J* [Internet]. 2018;17(1):247. Available from: <https://pubmed.ncbi.nlm.nih.gov/29973194/>

# Descriptive Online Survey: Knowledge, Attitudes, and Anxiety During the Period of Pandemic COVID-19 in Indonesia

Agung Sutriyawan<sup>1</sup>, Hairil Akbar<sup>2</sup>, Fibrianti<sup>3</sup>, Intan Pertiwi<sup>4</sup>, Ucu W. Somantri<sup>5</sup>, Lezi Y. Sari<sup>6</sup>

<sup>1</sup>Research Scholar, Bachelor Programme Public Health, Bhakti Kencana University, <sup>2</sup>Research Scholar, Graha Medika Institute of Health Science, <sup>3</sup>Research Scholar, Hamzar Institute of Health Science, <sup>4</sup>Research Scholar, Infectious Disease Hospital Prof. Dr. Sulianti Saroso, <sup>5</sup>Research Scholar, Mathla ul Anwar University, <sup>6</sup>Research Scholar, Dehasen University of Bengkulu

## Abstract

**Background:** The Government provides directives related to the prevention of cases spread, but the number of cases still shows improvement. Community knowledge and attitudes influence the level of compliance with the Government's recommended COVID-19 deployment precautions.

**Objectives:** Assess knowledge, attitudes, and anxiety during the COVID-19 period.

**Method:** This is a quantitative descriptive study, sampling techniques using Snowball. Questionnaires have four parts, social-demographic, knowledge, attitude, and anxiety during the pandemic. Online questionnaires were developed using Google forms. Questionnaire link sent via email, Whats App, Facebook. Variables are summarized into frequencies and percentages using SPSS version 25.

**Results:** Total (61.3%) The respondent knows how to spread COVID-19, (97.4%) and (95.3%) Know COVID-19 is more dangerous for elderly and people have chronic diseases, (95.1%) Know the handwashing is a preventive effort, almost all of the participants agreed on hand washing, hand sanitizer, using a mask, (92%) Participants agreed to the screening COVID-19, (93%) Participants are willing to follow the Government's recommendation, (60%) Participants felt paranoid, (83%) Participants are always worried for themselves and those closest to you.

**Conclusion:** This study resulted in respondents having demonstrated good knowledge, positive attitudes, and feeling anxious during the COVID-19 pandemic

**Keywords:** COVID-19, knowledge, attitude, anxiety.

## Introduction

Coronavirus disease Pandemic 2019 (COVID-19) is a problem that is happening in more than 200 countries in the world. COVID-19 has been identified as the cause of infectious respiratory disease outbreak in Wuhan,

China.<sup>1</sup> The COVID-19 is highly contagious as most people do not have immunity against this new virus. Currently, COVID-19 attempts are performed only on the treatment of symptoms, treatment, and prevention of complications, but there have not been any medications that can cure this disease. Therefore, the best strategies to keep prevention such as keeping social distances or wearing masks may help us to prevent infections.<sup>2</sup> The governmental action of closing public services causes the collapse of the industry to negatively impact the economy.<sup>3</sup>

The spread of COVID-19 caused confusion, anxiety, and fear among the general public. A variety of research

---

### Corresponding Author:

**Agung Sutriyawan**

Research Scholar, Bachelor Programme Public Health,  
Bhakti Kencana University  
e-mail: agung.epid@gmail.com



on COVID-19, many facts are constantly changing and many myths are not prevalent in the general population regarding the prevention and management of infections. This is sometimes very annoying for certain individuals.<sup>4</sup> The absence of appropriate protective measures is the main cause of concern among common society. At the community level, there is distrust of others in the spread of disease and the role of government in tackling the plague. Especially in countries like Indonesia which is a populated country without strong health infrastructure, it is the cause of concern. Some levels of panic also appear in public due to the unavailability of basic protective measures.

COVID-19 was first reported in Indonesia on February 2, 2020, until today it continues to increase. Governments, media, physicians, researchers, celebrities, police and other community stakeholders urge communities to avoid public gatherings such as sports, religious ceremonies, family events, meetings and classes in schools, this is done to prevent the spread of Coronavirus infections.<sup>4</sup> Disbelief in the spread of disease and the role of the government in tackling the plague so that the spread of COVID-19 in Indonesia is difficult to overcome. To comply with the Government's recommendation, the public requires knowledge of the spread, the title, prevention of COVID-19. Facts in the field still many people ignore the importance of social distance due to attitude problems. Anxiety and community concerns generally affect every individual. Recent evidence suggests that individuals who are in isolation and quarantine experience anxiety, anger, confusion.<sup>5</sup> The knowledge and attitude of society largely affect the level of adherence to the prevention of disease spread that has been recommended by the Government. Therefore, it is important to study these domains in the Indonesian population. Based on the relevance of all of the above factors, researchers aim to assess the perceived knowledge, attitudes, and anxieties during the COVID-19 pandemic in Indonesia.

### Material and Method

The type of research used is quantitative descriptive. This approach was done to see a clear and accurate picture of the knowledge, attitudes, and anxieties during the pandemic COVID-19 period in the Indonesian population. Sampling techniques using Snowball. A semi-structured online questionnaire was developed using the Google form, with the consent form also available. Questionnaire links are sent via email, Whats App,

Facebook, or any other social media to the respondent. The questionnaire contains the characteristics of social-demographic, knowledge, attitudes, and anxiety in sequence, which the respondents must answer. This study is an online study, participants who can participate in this research if they have a social media account and have access to the Internet. The age of participants in this study is more than 18 years old, able to understand Bahasa Indonesia, and willing to approve respondents. Data collection started on 16 June 2020 hours 13.00 WIB and closed on 23 June 2020 at 12.00 WIB.

The questionnaire consists of 9 questions about knowledge covering the way of transmission, symptoms, prevention, and treatment of COVID-19. The questionnaire attitude during the pandemic contains 15 question items that are graded with a scale Likert 5 points, namely: very disagree, disagree, hesitate, agree, and strongly agree. Anxiety during a pandemic associated with a COVID-19 infection has 17 question items, rated using a Likert scale of 4 points, namely: never, sometimes, often and always. The analysis in this study uses descriptive statistics using SPSS version 25. Variables are summarized into frequency and percentage distribution based on the question item given to the respondent

### Findings:

**Table 1. Socio-Demographic of the Participants (n = 1051)**

Socio-demographic Characteristics	Frequency	%
<b>Age (years)</b>		
≤ 20	163	15,5
21 - 30	511	48,6
31 - 40	277	26,4
41 - 50	67	6,4
51 - 60	28	2,7
> 60	5	0,5
<b>Gender</b>		
Male	319	30,4
Women	732	69,6
<b>Education</b>		
No school	2	0,2
Elementary school	2	0,2
Middle School	3	0,3
High school	262	24,9
College	782	74,4

Socio-demographic Characteristics	Frequency	%
<b>Profession</b>		
Government employees	174	16,6
General employees	383	36,4
Entrepreneur	95	9,0
Housewives	54	5,1
Student	310	29,5
Labor	21	2,0
Not working	14	1,3
<b>Agama</b>		
Islam	894	85,1
Christian	136	12,9
Hindu	17	1,6
Buddhist	3	0,3
Confucius	1	0,1

Source: Primary Data, 2020

The characteristics of socio-demographic participants are shown in table 1. Among the participants who responded, 511 (48.6%) 21 – 30 years of age group, 732 (69.6%) Female gender, 782 (74.4%) College, 383 (36.4%) Working as a private employee, 894 (85.1%) Islamic faith.

**Table 2. Knowledge of COVID-19 among Research Participants (n = 1051)**

Knowledge Items	Frekuensi	%
<b>1. COVID-19 spreads through</b>		
a. Touch	116	11,0
b. Sneezing	287	27,3
c. Kissing	4	0,4
d. answered everything (touch, sneezing, kissing)	644	61,3
<b>2. COVID-19 can be transmitted from people without symptoms</b>		
a. Yes	983	93,5
b. Not	41	3,9
c. Do not know	27	2,6
<b>3. Pets in the House can transmit COVID-19</b>		
a. Yes	422	40,2
b. Not	365	34,7
c. Do not know	264	25,1
<b>4. COVID-19 more dangerous for elderly</b>		
a. Yes	1024	97,4
b. Not	12	1,1
c. Do not know	15	1,4

Knowledge Items	Frekuensi	%
<b>5. COVID-19 is more dangerous in people who have chronic diseases</b>		
a. Yes	1002	95,3
b. Not	12	1,1
c. Do not know	37	3,5
<b>6. Symptoms</b>		
Fever		
a. Yes	836	79,5
b. Not	215	20,5
<b>Headaches</b>		
a. Yes	325	30,9
b. Not	726	69,1
<b>Cough</b>		
a. Yes	708	67,4
b. Not	343	32,6
<b>Sore throat</b>		
a. Yes	665	63,3
b. Not	386	36,7
<b>Fatigue</b>		
a. Yes	299	28,4
b. Not	752	71,6
<b>Difficulty breathing</b>		
a. Yes	784	74,6
b. Not	267	25,4
<b>Chest Pain</b>		
a. Yes	177	16,8
b. Not	874	83,2
<b>7. Isolation of a person who has symptoms COVID-19 can stop the spread of COVID-19?</b>		
a. Yes	1000	95,1
b. Not	24	2,3
c. Do not know	27	2,6
<b>8. Frequent hand washing can stop the spread of COVID-19?</b>		
a. Yes	999	95,1
b. Not	30	2,9
c. Do not know	22	2,1
<b>9. Antibiotics can treat COVID-19</b>		
a. Yes	251	23,9
b. Not	499	47,5
c. Do not know	301	28,6

Source: Primary Data, 2020

Knowledge among study participants on COVID-19 is described in Table 2. The majority is 644 (61.3%) Virus

COVID-19 spreads through touch, sneezing and kissing, 983 (93.5%), 1024 (97.4%) Know COVID-19 more dangerous for elderly, 1002 (95.3%) Know COVID-19 is more dangerous in people who have chronic diseases,

1000 (95.1%) Know the isolation of a person who has symptoms COVID-19 can stop the spread of COVID-19, and 999 (95.1%) Know often hand washing can stop the spread of COVID-19.

**Table 3. Attitudes About COVID-19 among Participants Research (n = 1051)**

Attitude Items		Responses that answered agree and strongly agree (N = 1051)	
		F	%
1	When I meet friends, I always greet them without shaking hands	908	86,4
2	When I meet my friends and colleagues, I always welcome them without hugging	956	91,0
3	I wash my hands using soap or hand sanitizer regularly	986	93,8
4	I usually use masks to protect myself from the risk of contracting COVID-19	1027	97,7
5	If I have any of the symptoms associated with COVID-19, I will tell the health worker	957	91,1
6	If I make a contact or interaction with the infected COVID-19, I am willing to be in isolation at home within a certain period until it proves that I am not infected with COVID-19	1014	96,5
7	If I make a contact or interaction with the infected COVID-19, I was willing to be isolated in the hospital within a certain period until it proved that I was not infected with COVID-19	947	90,1
8	If there is a laboratory test available to detect the COVID-19, I am willing to do so	972	92,5
9	If there is a vaccine available for COVID-19, I am willing to be vaccinated	902	85,8
10	I usually follow the latest updates or news about the spread of COVID-19 in my country	902	85,8
11	I usually follow the latest updates or news about the spread of Covid-19 around the world	752	71,6
12	If the counseling is held about the COVID-19 in the region where I live, I will follow him	634	60,3
13	If it is as smooth or a brochure that includes information about COVID-19, I will read it and follow the instructions described therein	912	86,8
14	I am willing to follow the Government’s recommendation regarding the prevention of COVID-19 transmission	987	93,9
15	I am willing to buy COVID-19 preventive equipment such as masks and hand sanitizer	983	93,5

Source: Primary Data, 2020

Preventive measures to limit the spread of COVID-19 and their responses are presented in table 3. The majority of participants agreed when meeting friends or colleagues did not shake hands or embraced. Almost all of the participants said they agreed to wash their hands using soap or hand sanitizer regularly and use masks to protect themselves from the transmission of COVID-19. Most study participants agreed in isolation at home or

in the hospital if they made contact with the COVID-19 or infected people. Approximately 92% of participants agreed to the screening for COVID-19. The results of the study were obtained about 93% of the participants were willing to follow the Government’s recommendation regarding the prevention of COVID-19 transmission and willing to purchase COVID-19 preventive equipment such as masks and hand sanitizers.

**Table 4: Anxiety about COVID-19 among Participants Research (n = 1051)**

During the COVID-19 Pandemic		Responses that feel anxious (often and always) (N = 1051)	
		F	%
1	How often do you think about COVID-19	855	81,4
2	How often do you feel paranoid/scared about COVID-19	618	58,8
3	How often do you avoid partying	939	89,3
4	How often you avoid direct social contact	882	83,9
5	How often you avoid large meetings directly such as worship, meetings, and more	873	83,1
6	How often you order food online	384	36,5
7	How often do you talk to your friends about the COVID-19 pandemic	778	74,0
8	How often you have trouble sleeping due to worry about the spread and transmission of COVID-19	273	26,0
9	How often you feel affected by news coverage in newspapers and TV	540	51,4
10	How often you feel the need to buy and store all the needs at home	569	54,1
11	How often do you feel scared if anyone in your neighborhood is reported to be infected with COVID-19	635	60,4
12	How often you feel you need to use a hand cleanser	970	92,3
13	How often you feel you need to constantly wash your hands using soap or hand sanitizer	958	91,2
14	How often do you feel worried about yourself, and the people closest to the spread and transmission of the COVID-19?	874	83,2
15	How often you use masks even without any obvious symptoms of infection	972	92,5
16	How often the story of COVID-19 makes you feel frightened so that it leads to unnatural behavior towards others	318	30,3
17	How often are the stories of COVID-19 that make you panic on social media	321	30,5

**Source:** Primary Data, 2020

Anxiety among study participants on COVID-19 was presented in table 4. More than 85% of the participants were busy with a COVID-19 pandemic, around 60% of the paranoid participants with a mind contracted COVID-19 during a pandemic. About 85% of participants avoided party, social contact, and avoided meetings such as worship, meetings, and others for fear of being displaced by COVID-19. About 83% of participants reported worrying for themselves and their closest people during the ongoing pandemic. About 92% of participants always use masks even without any obvious symptoms of infection.

### Discussion

Indonesia is still not able to suppress the transmission of COVID-19 effectively. The population of Indonesia participates in this study, most of the

community has a good knowledge of the spread of COVID-19, which is evident from some of the questions we ask. Respondents to this study who have higher knowledge are also due to most of the respondents over the age of 20. The results of the study were conducted in three countries (Jordan, Saudi Arabia, and Kuwait), that the higher COVID-19 knowledge scores proved to be significantly related to the age and achievement of education.<sup>6</sup> Knowledge is considered important in the prevention efforts of COVID-19 if society has good knowledge, hopefully, the community is more obedient in the prevention efforts of COVID-19 recommended by the Indonesian Government. The study in China obtained 89% demonstrated sufficient knowledge about COVID-19. Knowledge is a prerequisite for building preventative beliefs, shaping positive attitudes, and promoting positive behaviors, and individual cognition

and attitudes towards the disease affect the effectiveness of certain strategies and behaviors.<sup>7</sup>

Participants of this study were optimistic about the prevention of COVID-19, most of the participants took the precaution of spreading the infection by COVID-19, such as: not shaking hands and hug when meeting friends or colleagues, always use masks when exiting the house and wash hands using soap or hand sanitizer regularly. Previous research showed that most of the population took the COVID-19 precautions, i.e. not traveling in crowded places,<sup>8</sup> and using masks.<sup>9</sup> Study in Vietnam stated that the prevention of the transmission of COVID-19 was by hand washing and using face masks.<sup>10</sup>

Most of the study participants agreed to be isolated at home if they made a contact or interaction with the COVID-19 infected person. Disconnecting the suggested transmission chain is to implement social distance as well as isolation and quarantine to the general public who have symptoms of COVID-19. The patient's isolation is very effective in stopping the transmission if early detection is possible before a clear virus release.<sup>11</sup>

Findings from this study, often the respondents wash their hands using soap, sanitizer, and mask. This shows the respondent's concern for the action to maintain personal hygiene to avoid the COVID-19 infection. Respondents' awareness of the COVID-19 was seen in their behavior, as the frequent avoidance of going to the party, avoiding meetings, and also avoid going to the place of worship. Anxiety was also reflected by their fears that there was a COVID-19 transmission, even a quarter of respondents were struggling to sleep because of a COVID-19 spread. The level of anxiety in respondents can cause unnatural behavior such as anxiety, worry, or anger.

Excessive anxiety in society will have an impact on mental life. Therefore, it is important to address the difficulties of mental health in a pandemic situation. Study in India states that when anxiety occurs a broad population, it can lead to panic for the community, which causes the resources to quickly run out. Research in Iraq states that social media has a significant impact on the spread of fear and panic related to the COVID-19 outbreak, with a potential negative influence on mental health and psychological wellbeing of society.<sup>12</sup>

## Conclusion

Our study showed that respondents had a good knowledge of the way the transmission and prevention of COVID-19 had a positive attitude during the pandemic and some respondents felt anxiety during the COVID-19 pandemic. There need to be mental health consulting facilities for the community throughout Indonesia to reduce the level of public anxiety.

**Conflict of Interest:** Nil.

**Source of Funding:** Nil.

**Ethical Clearance:** The study was approved by the institutional Ethical Board of Immanuel School of Health Sciences Bandung.

## References

1. Setiati S, Azwar MK. COVID-19 and Indonesia. *Acta Med Indones* [Internet]. 2020;52(1):84–9. Available from: <https://pubmed.ncbi.nlm.nih.gov/32291377/>
2. Kim S-W, Su K-P. Using psychoneuroimmunity against COVID-19. *Brain Behav Immun* [Internet]. 2020; Available from: <https://www.sciencedirect.com/science/article/pii/S0889159120303913>
3. Ho CSH, Chee CY, Ho RC. Mental health strategies to combat the psychological impact of COVID-19 beyond paranoia and panic. *Ann Acad Med Singapore* [Internet]. 2020;49(1):1–3. Available from: <https://pubmed.ncbi.nlm.nih.gov/32200399/>
4. Roy D, Tripathy S, Kar SK, Sharma N, Verma SK, Kaushal V. Study of knowledge, attitude, anxiety & perceived mental healthcare need in Indian population during COVID-19 pandemic. *Asian J Psychiatr* [Internet]. 2020;102083. Available from: <https://www.sciencedirect.com/science/article/pii/S1876201820301945>
5. Brooks SK, Webster RK, Smith LE, Woodland L, Wessely S, Greenberg N, et al. The psychological impact of quarantine and how to reduce it: rapid review of the evidence. *Lancet* [Internet]. 2020; Available from: <https://www.sciencedirect.com/science/article/pii/S0140673620304608>
6. Naser AY, Dahmash EZ, Alwafi H, Alsairafi ZK, Al Rajeh AM, Alhartani YJ, et al. Knowledge and practices towards COVID-19 during its outbreak:

- a multinational cross-sectional study. medRxiv [Internet]. 2020; Available from: <https://www.medrxiv.org/content/10.1101/2020.04.13.20063560v1>
7. Zhou M, Tang F, Wang Y, Nie H, Zhang L, You G, et al. Knowledge, attitude and practice regarding COVID-19 among health care workers in Henan, China. *J Hosp Infect* [Internet]. 2020; Available from: <https://www.sciencedirect.com/science/article/pii/S0195670120301870>
  8. Zhong B-L, Luo W, Li H-M, Zhang Q-Q, Liu X-G, Li W-T, et al. Knowledge, attitudes, and practices towards COVID-19 among Chinese residents during the rapid rise period of the COVID-19 outbreak: a quick online cross-sectional survey. *Int J Biol Sci* [Internet]. 2020;16(10):1745. Available from: <https://www.ncbi.nlm.nih.gov/pmc/articles/PMC7098034/>
  9. Dkhar SA, Quansar R, Saleem SM, Khan SMS. Knowledge, attitude, and practices related to COVID-19 pandemic among social media users in J & K, India. *Indian J Public Health* [Internet]. 2020;64(6):205. Available from: <http://www.ijph.in/article.asp?issn=0019-557X;year=2020;volume=64;issue=6;spage=205;epage=210;aulast=Dkhar>
  10. Huynh G, Nguyen TNH, Vo KN, Pham LA. Knowledge and attitude toward COVID-19 among healthcare workers at District 2 Hospital, Ho Chi Minh City. *Asian Pac J Trop Med* [Internet]. 2020;13(6):260. Available from: <http://www.apjtm.org/article.asp?issn=1995-7645;year=2020;volume=13;issue=6;spage=260;epage=265;aulast=Huynh>
  11. Wilder-Smith A, Freedman DO. Isolation, quarantine, social distancing and community containment: pivotal role for old-style public health measures in the novel coronavirus (2019-nCoV) outbreak. *J Travel Med* [Internet]. 2020;27(2):taaa020. Available from: <https://academic.oup.com/jtm/article/27/2/taaa020/5735321>
  12. Ahmad AR, Murad HR. The impact of social media on panic during the COVID-19 pandemic in Iraqi Kurdistan: online questionnaire study. *J Med Internet Res* [Internet]. 2020;22(5):e19556. Available from: <https://www.jmir.org/2020/5/e19556/>

# Phacoemulsification Under Topical Anaesthesia Combined with Anxiolytic

Ahmed Mohammed Al-Samak

Lecturer of Ophthalmology at Al-Zahraa College of Medicine, University of Basrah, Basrah, Iraq

## Abstract

**Background:** Local anesthesia in ocular surgery is a technique that mostly used now. Many type of procedures were applied including retrobulbar, peribulbar, subconjunctival and topical anesthesia.

**Aim:** To study the efficacy of tetracaine topical anesthesia technique combined with anxiolytic midazolam in cataract surgery, and to test patient's and surgeon's conviction by this method.

**Patients and Method:** Prospective study of one hundred three patients with dense cataract in Al-Basira eye center with mean age of 60.32 years (range: 50-70). Patients were 57 male and 46 female. Topical anesthesia was encouraged by intravenous anxiolytic, midazolam 0.1 mg/kg weight given in the beginning of surgery. We used a special patient's pain scoring and intraoperative surgeon's conviction score to analyze the reliability of this method. The study period lasted from October 2019 to March 2020.

**Result:** All patients had peaceful success phacoemulsification with an average surgery time of 15-20 minutes. Minimal or no movement noticed during surgery. No need for more anesthesia as there were no intolerable pain.

**Conclusion:** Cataract surgery can be safely and effectively done by topical anesthesia using this method.

**Keywords:** Local anesthesia, phacoemulsification, anxiolytic.

## Introduction

Topical anaesthesia for cataract surgery is used after development of phacoemulsification as there is a closed system ignoring the squeezing of patient. In topical anesthesia, there is no risk of ocular perforation, muscle injury, or central nervous system effect and relatively short convalescent period as that may occur in other types of local anesthesia like retrobulbar and peribulbar<sup>1</sup>. By this method there is a blockage of trigeminal nerve

supply of the cornea and the conjunctiva only, and there is no effect on the intraocular structures of the anterior segment<sup>2</sup>. There are many types and drugs used, the main two types are eye drops and viscous gel and drugs are lidocaine and tetracaine. Patient comfort, and history of allergy to local anesthetic agents decide the type of drug used<sup>2</sup>. Different sedatives or analgesics are used combined with topical anaesthesia including; midazolam, diazepam, propofol, fentanyl and ketamine<sup>3</sup>. We want to assess the effectiveness of tetracaine eye drops topical anesthesia technique combined with anxiolytic, midazolam in cataract cases, and to test patient's and surgeon's satisfaction with this method.

---

## Corresponding Author:

Ahmed M. Alsamak

Lecturer of Ophthalmology at Al-Zahraa College of Medicine, University of Basrah, Basrah, Iraq

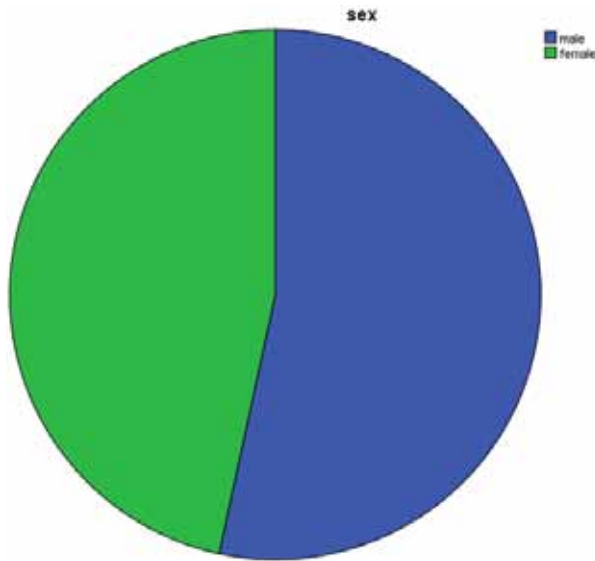
Mobile No.: +9647822114665

e-mail: ahmed.abood@uobasrah.edu.iq

## Patients and Method

Prospective study of one hundred three patients with dense cataract in Al-Basira eye center with mean age of 60.32 years (range 50-70), were set for phacoemulsification cataract extraction under topical

anaesthesia combined with anxiolytic. Patients were 57(53.4%) male and 46(46.6%) female.



**Table 1. Patient’s pain scoring**

Score	Patient condition
0	No pain or discomfort
1	Some discomfort
2	Mild tolerable pain
3	Moderate pain
4	Severe pain

**Table 2. Intraoperative surgeon’s conviction score**

Score	Surgeon conviction
0	Poor
1	Fair
2	Good
3	Excellent

At the beginning, we talk with our patients to illustrate what we will to do. The topical anesthetic tetracaine eye drops was used. Two drops of tetracaine were put in the conjunctival sac. Another 2 drops of tetracaine was put in the conjunctival sac of the other eye to conceal blinking reflex of the contralateral eye. The topical anaesthesia was combined with intravenous anxiolytic, midazolam 0.1 mg/kg weight. Patients were observed, in addition to the vital signs, for pain and sensitivity to light and touch. A reconnaissance method (Tables 1 and 2) used for both the patients and the surgeon that had been done in recovery room postoperatively, a subjective pain score for the patient was obtained. Surgeon conviction were reported intraoperatively.

**Inclusion Criteria:** Patients from 50-70 years old with dense cataract, no other ocular pathology, no previous ophthalmic surgery and controlled systemic diseases if they had (ASA class II and III).

**Exclusion Criteria:** Patients with early cataract, had any ocular pathology like glaucoma, had any uncontrolled systemic diseases, and uncooperative patients.

**Results**

All patients had peaceful success phacoemulsification surgery with an average surgery time of 15-20 minutes. Minimal or no movement notice during surgery. The analysis was performed using the Statistical Package for the Social Sciences (SPSS) version 23 software.

Table 3 showed that 89 patients (86.4%) had no pain noticed intraoperatively and 9 patients (8.7%) had some discomfort especially to light and 5 patients (4.9%) had mild tolerable pain from the speculum with statistically significant association (P- value = .000).

**Table 3. Subjective pain scoring**

Pain Score	No. of Patients	Percentage	p-value
No pain	89	86.4	.000
Some discomfort	9	8.7	.000
Mild pain	5	4.9	.000
Moderate pain	0	0	
Severe pain	0	0	
<b>Total</b>	<b>103</b>	<b>100%</b>	



Surgeon conviction was excellent in 93 patients (90.3%), good in 7 patients (6.8%) as there was some blinking and fair in only 3 patients (2.9 %) of the patients where there was blinking and eye movement

as demonstrated in (table 4) with statistically significant association (P-value = .000). No patient was converted to another way of anesthesia. There were no any serious complications postoperatively.

**Table 4. Surgeon's conviction score.**

Surgeon conviction	No. of Patient	Percentage	p-value
Excellent	93	90.3	.000
Good	7	6.8	.000
Fair	3	2.9	.000
Poor	0	0	
<b>Total</b>	<b>103</b>	<b>100</b>	

## Discussion and Conclusion

This study offers the use of a safe anesthetic technique with least intervention. It provided acceptable analgesia and surgery can be performed without akinesia or sort of ocular movement. Topical anesthesia is justified as a means of improving safety without causing discomfort to the patient even in complicated cases of cataract surgery<sup>4</sup> and has negligible complication as compared with other ways of local anesthesia using in ophthalmic surgery that increases intraocular pressures like retrobulbar and peribulbar<sup>5</sup>. Potentially life-threatening complications exist with all techniques except topical/intracameral local anesthesia<sup>6</sup>. In addition, significant pain during anesthetic administration, intraoperative surgery, or after the cataract procedure, is the major reasons for low patient satisfaction<sup>7</sup>. Many surgeons do not consider akinesia an important requirement for cataract surgery, but some prefer to operate under conditions in which eye movements are blunted if not completely paralyzed<sup>8</sup>. Many types of drugs have been tried as a supplement to local anesthesia<sup>9</sup>, but here we choose midazolam.

Midazolam is benzodiazepine medication used for anesthesia 0.1 mg per kg weight. Midazolam is commonly utilized for conscious sedation/anxiolysis/amnesia<sup>9</sup> that means it can prevent physical and psychological discomfort, and it provides good cooperation of the patient, and it arrests patients' recall of intraoperative events. The patient is awakened and cooperative and obeys commands. Midazolam alone may produce optimal block conditions for the patient and it is satisfactory during the procedure<sup>10</sup>. The choice of sedatives is

highly variable and opioids may be added for better pain relief and higher patient satisfaction. Any side-effects delaying the discharge after sedation are undesirable<sup>11</sup>. Also, it is undesirable for patients with ocular surgery to get postoperative nausea and vomiting with strain on the eye<sup>12</sup>. All these undesired effects did not occur with our patients using this way of anesthesia.

We noticed previously on using diazepam for example, the patients went into deep sleep and awakened suddenly with abnormal reaction that affects the cooperation of the patients. Although there were patient squeezing and eye movement, they were neither a trouble to the surgeon nor to the patient. No additional supply of anaesthesia was required. We as surgeons were satisfied with this method, patients accepted this type of anaesthesia for the surgery of other eye in the future.

**Ethical Clearance:** Taken from Alzahraa Medical College committee

**Source of Funding:** Self

**Conflict of Interest:** Nil

## References

1. Boulton JE, Lopatzidis A, Luck J, Baer RM. A randomized controlled trial of intracameral lidocaine during phacoemulsification under topical anesthesia. *Ophthalmology*. 2000 Jan 1; 107(1):68-71. <https://www.aao.org/bcscsnippetdetail.aspx?id=c6bba5fc-cfa7-4c0f-a879-b184f4cf7f4d>

2. Malik A. Efficacy and performance of various local anesthesia modalities for cataract surgery. *J Clinic Experiment Ophthalmol S.* 2013; 1:2. <https://www.longdom.org/abstract/efficacy-and-performance-of-various-local-anesthesia-modalities-for-cataract-surgery-48614.html>
3. Eke T, Thompson JR. The national survey of local anaesthesia for ocular surgery. I. Survey methodology and current practice. *Eye.* 1999 Mar; 13(2):189-95. <https://pubmed.ncbi.nlm.nih.gov/10450380/>
4. Jacobi PC, Dietlein TS, Jacobi FK. A comparative study of topical vs retrobulbar anesthesia in complicated cataract surgery. *Archives of Ophthalmology.* 2000 Aug 1; 118(8):1037-43. <https://jamanetwork.com/journals/jamaophthalmology/fullarticle/413464>
5. Lanini PG, Simona FS. Change in intraocular pressure after peribulbar and retrobulbar injection: practical sequelae. *Klinische Monatsblätter für Augenheilkunde.* 1998 May; 212(5):28. <https://pubmed.ncbi.nlm.nih.gov/9677555/>
6. Eke T, Thompson JR. Serious complications of local anaesthesia for cataract surgery: a 1 year national survey in the United Kingdom. *British Journal of Ophthalmology.* 2007 Apr 1; 91(4):470-5. <https://www.ncbi.nlm.nih.gov/pmc/articles/PMC1994745/>
7. Fung D, Cohen MM, Stewart S, Davies A. What determines patient satisfaction with cataract care under topical local anesthesia and monitored sedation in a community hospital setting? *Anesthesia & Analgesia.* 2005 Jun 1; 100(6):1644-50. <https://europepmc.org/article/med/15920189>
8. Friedman DS, Bass EB, Lubomski LH, Fleisher LA, Kempen JH, Magaziner J, Sprintz M, Robinson K, Schein OD. Synthesis of the literature on the effectiveness of regional anesthesia for cataract surgery. *Ophthalmology.* 2001 Mar 1; 108(3):519-29. <https://pubmed.ncbi.nlm.nih.gov/11237906/>
9. Pérez-Castanedo J, Planell J, Barrachina V, Colilles C, Lazaro A, Moral V. Effectiveness of topical anesthesia enhanced by sedation and analgesia for cataract surgery. *Revista española de anestesiología y reanimación.* 1998 Oct; 45(8):312-6. <https://pubmed.ncbi.nlm.nih.gov/9847641/>
10. Cok OY, Ertan A, Bahadir M. Comparison of midazolam sedation with or without fentanyl in cataract surgery. *Acta Anaesthesiologica Belgica.* 2008 Jan 1; 59(1):27. [https://www.sarb.be/site/assets/files/1142/05-cok\\_et\\_al\\_1.pdf](https://www.sarb.be/site/assets/files/1142/05-cok_et_al_1.pdf)
11. Katz J, Feldman MA, Bass EB, Lubomski LH, Tielsch JM, Petty BG, Fleisher LA, Schein OD. Adverse intraoperative medical events and their association with anesthesia management strategies in cataract surgery. *Ophthalmology.* 2001 Oct 1; 108(10):1721-6. <https://pubmed.ncbi.nlm.nih.gov/11581040/>
12. Nimmo WS. *A Practice of Anaesthesia (5th Edn).* Edited by Churchill-Davidson HC Published (1984) by Lloyd-Luke (Medical Books) Ltd. Pp 1200; indexed; illustrated. Price £ 50.00. *British Journal of Anaesthesia.* 1985 Sep 1; 57(9):941.

# The Influences of Antenatal Care, Postnatal Care and Early Initiation of Breastfeeding on an Exclusive Breastfeeding Pattern in the Working Area of Manukan Kulon Public Health Center at Surabaya City

Azizi Pridasari<sup>1</sup>, Lutfi Agus Salim<sup>2</sup>

<sup>1</sup>Bachelor Student in Department Biostatistics and Demography, Faculty of Public Health, Universitas Airlangga, Surabaya, Indonesia, <sup>2</sup>Associate Professor in Department Biostatistics and Demography, Faculty of Public Health, Universitas Airlangga, Surabaya, Indonesia

## Abstract

Exclusive breastfeeding is very important for babies to maintain their immune system, brain intelligence, emotion stability and to protect babies from various diseases that are causes of death. Breastfeeding will also benefit the mother, which will reduce blood loss during menstruation, restore maternal weight as before pregnancy, reduce the risk of breast cancer, and uterine cancer. The purpose of this study was to determine the influences of antenatal care, postnatal care and early initiation of breastfeeding on an exclusive breastfeeding pattern. The samples used in this study were mothers who had babies aged 7-12 months in June to August 2018 as many as 48 respondents in the working area of Manukan Kulon Health Center in Surabaya. This study used the descriptive and bivariate analyses. The obtained results were antenatal care ( $p = 0.001$ ), postnatal care ( $p = 0.002$ ) and early initiation of breastfeeding ( $p = 0,000$ ). During pregnancy the majority of mothers make complete antenatal care visits with a frequency of 10 times, antenatal care is very important for mothers, especially the pattern of breastfeeding. In addition to the importance of antenatal care visits, mothers who have given birth and are entering the postnatal care phase are required to make postnatal care visits. Socialization from health workers and the support of closest people are required in order to achieve the exclusive breastfeeding.

**Keywords:** *Exclusive Breastfeeding, Early Initiation of Breastfeeding, Antenatal Care, Postnatal Care.*

## Introduction

Exclusive breastfeeding is the provision of breast milk that is given to infants without giving any additional food and drinks to the baby until the age of 6 months and given the breastfeeding as early as possible<sup>(1)</sup>. Breast milk as the main food of babies is

very important because breast milk contains 60% of the nutritional needs of babies. Breast milk has several benefits including the intelligence of baby's brain, the baby's emotion stability and can protect the baby from various diseases that are causes of death. Breastfeeding will also benefit the mother, which will reduce blood loss during menstruation, restore maternal weight as before pre-pregnancy and reduce the risk of breast cancer and uterine cancer. Although breastfeeding and breast milk are very beneficial, it is estimated that 85% of mothers in the world do not give an exclusive breastfeeding as recommended by WHO (2002). Many mothers in many countries do not provide exclusive breastfeeding due to various factors such as social, cultural, economic and political<sup>(2)</sup>.

---

### Corresponding Author:

**Lutfi Agus Salim**

Associate Professor in Department Biostatistics and Demography, Faculty of Public Health, Universitas Airlangga, Surabaya, Indonesia  
e-mail: lutfi.as@fkm.unair.ac.id

Breastfeeding can affect the reduction in newborn mortality from the first day of birth by 16% and will reduce death possibility by 22% if the newborn is given breast milk within the first hour after birth. In 2012, the 0-5 month's infants received exclusive breastfeeding with the percentage of 41.5%. In 2013, infants who received exclusive breastfeeding were 38%. In 2014, the coverage of exclusive breastfeeding in Indonesia did not meet the strategic plan target of 52.3% while the target to be achieved was 80%. However, in 2015, the national target of exclusive breastfeeding was reduced to the amount of 39% so that the national target was able to be reached.

In 2016, the results of nutrition monitoring in Indonesia showed that newborns received early initiation of breastfeeding with the percentage of 51.9%. The infants who were aged 0-5 months received an exclusive breastfeeding with the percentage of 54%, while infants who were aged 0-6 months get exclusive breastfeeding by 29.5%. On these results, it can be concluded that babies received a complementary food of breastfeeding at the age of 5 months on average.

According to the Isrono study in 2013, mothers who gave exclusive breastfeeding in the working area of Serpong Public Health Center were as much as 14.6%<sup>(3)</sup>. In conclusion, the information that has been given and obtained were not necessarily going to be implemented properly.

## Methodology

The samples used in this study were mothers who had babies aged 7-12 months in June to August 2018 as many as 48 respondents. The technique used in this study was by carrying out the data retrieval in the working area of Manukan Kulon Public Health Center at Surabaya City by using the simple random sampling formula.

The dependent variable in this study was the pattern of exclusive breastfeeding. Meanwhile, the independent variables in this study were the influence of antenatal care, postnatal care and early initiation of breastfeeding.

Data analyses in this study were using descriptive and bivariate analyses. Descriptive analysis was used to describe the characteristics of each independent and dependent variables. Meanwhile, bivariate analysis was used to see the relationship between each independent and

dependent variables using a logistic regression analysis. Through the logistic regression test, the value of  $p$  would be obtained, which in this study used a significance level of 0.05. Research between the two variables was said to be meaningful if it had a value of  $p < 0,05$  which meant  $H_0$  was rejected and  $H_1$  was accepted. It was said to be meaningless if it had  $p \geq 0,05$  which meant that  $H_0$  was accepted and  $H_1$  was rejected. Bivariate analysis was carried out to select candidates for influential factors.

## Results

Antenatal care is a midwifery service for pregnant women that aims to maintain the health of pregnant women and ensure normal birth can be carried out at least four times during pregnancy to confinement. Antenatal care visits are grouped into 2 groups, namely complete and incomplete antenatal care visits. Research result shows that the majority of respondents made a complete antenatal visit from the beginning of the pregnancy to giving birth with a total of 44 people (91.6%). Respondents who had an incomplete antenatal care visit were as many as 4 people (8.4%) with a frequency of 4 time visits.

Postnatal Care (PNC) is the period after the placenta is born and the period ends when the uterus organs returns to its pre-pregnancy state. At this time, the body is making both physical and psychosocial adjustments to the birth process that starts immediately after the placenta is born until the body can adjust to perfection and ends when the uterine organs return to their pre-pregnancy state which lasts for 6 weeks. Research result shows that all respondents take the postnatal care visit after giving birth, although with different frequency of visits. The most postnatal care visit was 2 times with a percentage of 60.4%, followed by postnatal care visits as much as 3 times by 31.3% and the least was one time postnatal care visit with a percentage of 8.3%. The percentage was very good because postnatal care visits were suggested to be done at least once after giving a birth.

The coverage of early initiation of breastfeeding among respondents in the working area of ManukanKulon Public Health Center at Surabaya can be categorized as good, because most respondents initiated early breastfeeding immediately after the baby was born with the percentage of 91.7% and 8.3 % did not initiate early breastfeeding.

**Table 1. Distribution of Breastfeeding Pattern Based on Ante Natal Care (ANC) Visits**

ANC Visit	Breastfeeding Pattern				Total	
	Exclusive		Non-Exclusive			
	n	%	n	%	N	%
Complete	4	9,1	40	90,9	44	100,0
Incomplete	0	0,0	4	100,0	4	100,0
Total	4	8,3	44	91,7	48	100,0

Distribution results on the pattern of breastfeeding based on Antenatal Care visit in the table 1 shows that most respondents with complete ANC visits gave breastfeeding with a non-exclusive pattern with a

percentage of 90.9% while respondents who did not routinely make ANC visits gave breastfeeding with a non-exclusively pattern by 100%.

**Table 2 Distribution of Breastfeeding Pattern Based on Post Natal Care (PNC) Visit**

PNC Visit	Breastfeeding Pattern				Total	
	Exclusive		Non-Exclusive			
	n	%	n	%	n	%
1 time	0	0,0	4	100,0	4	100,0
2 time	4	3,18	25	86,2	29	100,0
3 time	0	0,0	15	100,0	15	100,0
Total	4	8,3	44	91,7	48	100,0

Based on the results in table 2, the majority of respondents visited Postnatal Care twice with a frequency of 29 respondents. The respondents who visited PNC twice and determined the pattern of non-exclusive breastfeeding had a lower percentage with a

total of 86.2%. Meanwhile, the respondents who visited PNC once and three times and determined the pattern of non-exclusive breastfeeding to their babies had a greater percentage by 100% respectively.

**Table 3 Distribution of Breastfeeding Pattern Based on the Early Initiation of Breastfeeding (EIB)**

EIB	Breastfeeding Pattern				Total	
	Exclusive		Non-Exclusive			
	n	%	n	%	n	%
Yes	4	9,1	40	90,9	44	100,0
No	0	0,0	4	100,0	4	100,0
Total	4	8,3	44	91,7	48	100,0

The pattern of breastfeeding based on Early Initiation of Breastfeeding in table 3 shows that there were more respondents who did the EIB than those who did not. Respondents who did EIB mostly gave non-exclusive breastfeeding to their babies with the percentage of

90.9%. Meanwhile, the respondents who did not give an EIB tended to give a non-exclusive breastfeeding to their babies with a percentage of 100%. The analysis of the independent and dependent variables by using logistic regression analysis ( $\alpha = 0,05$ ) are as follows.

**Table 4 Bivariate Analysis of Antenatal Care, Postnatal Care and Early Initiation of Breastfeeding**

Variable	Sig	Explanation
Antenatal Care	0,001	Significant
Postnatal Care	0,002	Significant
Early Initiation of Breastfeeding	0,000	Significant

Based on table 4, the logistic regression analysis obtained, there were 3 variables that influenced the pattern of breastfeeding to mothers, namely antenatal care ( $p = 0,001$ ), postnatal care ( $p = 0,002$ ) and early initiation of breastfeeding ( $p = 0,000$ ).

### Discussion

**Antenatal Care Factor:** Antenatal care is a health service for a mother during her pregnancy which carried out in accordance with established antenatal care standards. The visit of pregnant women to health services is recommended as follows; once in the first quarter, once in the second quarter and at least 2 times in the third quarter <sup>(4)</sup>. Ideally, every woman who is pregnant wants to have a pregnancy check in order to detect abnormalities that exist or will arise in the pregnancy are quickly identified and can be addressed immediately before affecting the pregnancy by conducting antenatal care checks <sup>(5)</sup>.

The results show that the respondents who did a complete antenatal care visit were as much as 91.6% while the respondents who did not make a complete antenatal visit were 8.4%. The results of the study show that most respondents were aware of the importance of maintaining pregnancy <sup>(6)</sup>.

According to the Indonesian Ministry of Health (2012), ANC visits of pregnant women are influenced by several factors <sup>(7)</sup>. The factors are including internal factors such as parity, mother's age and also external factors such as mother's knowledge, attitudes, socioeconomic conditions, socio-cultural, geographical, information and also the support from both staff and family<sup>(8)</sup>.

The results show that the majority of respondents with a percentage of 91.6% made a complete ANC visit, the respondents who gave exclusive breastfeeding by 9.1% and while the respondents who gave non-exclusive breastfeeding were at 90.9%. This study was in line with a research conducted by Suparmi and Ika (2012) which

stated that ANC visits affect the increase in the scope of exclusive breastfeeding <sup>(9)</sup>.

### Postnatal Care Factor on Breastfeeding Pattern:

Postnatal care is a series of treatments performed for postpartum mothers including massages, breast care, oxytocin massage, postpartum spa and so on. Postnatal care is done so that the puerperal mother can pass through the puerperium phase well without any complications <sup>(10)</sup>

The purpose of the postnatal care visit is to take care of the health of both mother and baby, both physical and psychological, to treat the patient if any complications occur, provide health education regarding self-health care, nutrition, breastfeeding, provide information to the baby and care for healthy babies and providing family planning services <sup>(11)</sup>.

The results show that the respondents who routinely visited postnatal care once were 8.3%, while those who did postnatal care visit twice were 60.4% and the respondents who visited postnatal care three times amounted to 31.3%. The distribution of PNC visits is positively related to the pattern of breastfeeding. Most respondents with a total of 86.2% with the frequency of PNC visits as much as twice decided to do the breastfeeding with a non-exclusive pattern.

The results show that postnatal care visits affect the pattern of breastfeeding. This study was in line with the research conducted by Seid et.al (2013) in Bahir Dar City Administration, Northwest Ethiopia which stated that there was a relationship between the amount of PNC visits with the exclusive pattern of breastfeeding <sup>(12)</sup>

### Early Initiation of Breastfeeding (EIB) Factor on Breastfeeding Pattern:

Early Initiation of Breastfeeding (EIB) which stands for early initiation of breastfeeding, is the baby's active effort to suckle within the first hour of birth, both normal and cesarean deliveries. The baby is placed on the mother's abdomen and chest immediately after birth and given the opportunity to start breastfeeding herself or himself by crawling for breasts and letting the baby's skin contact with her mother for an hour. On the first hour, the baby finds his mother's breasts in the beginning of a "life-sustaining between mother and child." The World Health Organization (WHO) recommended early breastfeeding to be initiated within the first hour after the baby is born by placing the baby in the mother's chest as soon as the baby is out of the birth canal<sup>(13)</sup>.

The results of this study indicate that respondents who did an EIB were as many as 91.7%, while the respondents who did not do the EIB were 8.3%. In conclusion, most mothers have understood the importance of EIB for babies. The analysis shows that EIB has a big influence on the pattern of breastfeeding. This study was in line with the study of Pongtuluran, et.al (2017) who stated that there is a relationship between EIB and exclusive breastfeeding patterns <sup>(14)</sup>.

### Conclusion

During their pregnancy, majority of mothers make complete antenatal care visits with a frequency of 10 times, antenatal care is very important for mothers, especially the pattern of breastfeeding. In addition to the importance of antenatal care visits, mothers who have given birth and are entering the postnatal care phase are required to make postnatal care visits. Most of the mothers did a two times postnatal care visit and the postnatal care visit in this study had a major influence on the pattern of breastfeeding.

The coverage of mothers who initiate breastfeeding early in their babies after birth (EIB) can also be categorized as good. Therefore, the early initiation of breastfeeding has an influence on the pattern of breastfeeding.

**Suggestion:** For couples who are going to get married are required to take counseling at a public health center or a hospital to educate themselves regarding the preparation that will be done after marriage and after they have children. Counseling can also increase the mother's knowledge, one of which is the importance of breastfeeding for infants. In addition, health workers also provide education on how to treat breast nipples and injured breasts during breastfeeding.

**Conflict of Interest:** The authors have no conflict of interest with the material presented in this paper

**Sources of Funding:** None

**Ethical Clearance:** None.

### References

- Lindawati R. Hubungan Pengetahuan, Pendidikan dan Dukungan Keluarga dengan Pemberian ASI Eksklusif. *Faletehan Health Journal*. 2019;6(1):30–6.
- Laksono W. ASI, Menyusui, dan Sadari. Nuha Medika: Yogyakarta. 2010;
- Anggraeni MF, Herawati S, Mustika DN. Pemberian Asi Eksklusif Berdasarkan Status Bekerja Ibu Yang Memiliki Bayi Usia 6-11 Bulan Di Wilayah Kerja Puskesmas Karangawen 1 Kabupaten Demak. *Jurnal Kebidanan [Internet]*. 2015;4(1). Available from: [https://jurnal.unimus.ac.id/index.php/jur\\_bid/article/view/1389](https://jurnal.unimus.ac.id/index.php/jur_bid/article/view/1389)
- Ministry of Health Republic of Indonesia. Profil Kesehatan Indonesia tahun 2014. Jakarta: Kementerian Kesehatan RI. 2015. 1–382 p.
- Ministry of Health Republic of Indonesia. InfoDATIN : pusat data dan informasi kementerian kesehatan RI: mother's day. Jakarta: Jakarta: Pusat Data dan Informasi Kementerian Kesehatan RI; 2014.
- Ningsih P. Hubungan Umur, Pengetahuan Dan Dukungan Keluarga Dengan Kunjungan Antenatal Care (Anc)(K4) Ibu Hamil Di Puskesmas Pariaman Tahun 2018. *Jurnal Ilmu Keperawatan dan Kebidanan*. 2020;11(1):62–9.
- Direktur Jenderal Bina Kesehatan Masyarakat. Pedoman pelayanan antenatal terpadu. Kementerian Kesehatan. Jakarta; 2012.
- Kurniawan B. Determinan keberhasilan pemberian air susu ibu eksklusif. *Jurnal Kedokteran Brawijaya*. 2013;27(4):236–40.
- Suparmi S, Saptarini I. Determinan Pemberian Asi Eksklusif: Analisis Data Sekunder Survei Demografi Dan Kesehatan Indonesia 2012. *Indonesian Journal of Reproductive Health*. 2014;5(1):15–21.
- Mirzaei K, Ghadikolaee S, Mousavi Bazzaz M, Ziaee M. Mother's satisfaction of postpartum care and its relationship with midwifery care at Urban Health Centers, Mashhad, Iran. *journal of midwifery and reproductive health*. 2016 Oct 21;
- Manuaba IBG. Ilmu kebidanan, penyakit kandungan dan keluarga berencana. Jakarta: EGC. 2010;15:157.
- Seid AM, Yesuf ME, Koye DN. Prevalence of Exclusive Breastfeeding Practices and associated factors among mothers in Bahir Dar city, Northwest Ethiopia: a community based cross-sectional study. *International Breastfeeding Journal [Internet]*. 2013;8(1):14. Available from: <https://doi.org/10.1186/1746-4358-8-14>

13. Djamil A, Hermawan NSA, Setiarini N. Hubungan Pelaksanaan Manajemen Laktasi oleh Petugas Kesehatan terhadap ASI Eksklusif pada Ibu Menyusui. *Jurnal Kesehatan*. 2018;9(1):113–6.
14. Ekaristi P, Kandou GD, Mayulu N. Hubungan Inisiasi Menyusui Dini (Imd) Dengan Pemberian Asi Eksklusif Di Kota Manado. *KESMAS*. 2017;6(3).



# Applying Strict Liability for Environmental Offenses: Indonesian Perspective

Al Halim

*Student of Law Doctorat Program Diponegoro University, Indonesia.*

## Abstract

This study aims to analyze the rationality and application of strict liability for environmental offenses in the Environmental Protection and Management Act of Indonesia. The strict liability set out in this law expressly applies only to civil cases and covers the possibility that it may be used in criminal matters. Normative legal research complemented by a statutory and conceptual approach was used. The results showed that it generally applies to regulatory offenses aimed at protecting the public interest. This doctrine is necessary to improve the long-term and prevents harm to people or the environment. The absence of mental element proof should be limited to offenses that are characterized by the administrative dependence of criminal law, which is reflected in the abstract and concrete endangerment models. Generally, prohibited behavior related to waste/emissions disposed into the environment without approval causes damage. The offense is formulated as formal offense by eliminating the element of the perpetrator's culpability, and it is therefore not necessary to prove it.

**Keywords:** *Strict liability, Regulatory offenses, Administrative dependent of criminal law, Environmental harm.*

## Introduction

Generally, a crime consists of both physical and mental elements. The first is characterized by active (commission) or passive actions (omission), the way they are performed, the consequences that cause damage, and the circumstances associated with the execution of prohibited actions.<sup>1</sup> The second refers to culpability of the actors that take various forms in an offense formula such as intentionally, with intent, knowingly, willfully, recklessly, or with criminal negligence.<sup>2</sup> This mental element can only be directed towards actions and their consequences which is obtained in most Modern Criminal Code. In its development, mental elements are not required in imposing criminal sanctions. In certain cases based on the concept of strict liability, the defendant can even be held liable and convicted of an act committed without the need of proving guilty.<sup>3</sup>

Furthermore, it is often associated with public welfare offense (regulatory offenses) which eliminates the element of perpetrators' fault to protect the public from avoiding danger. However, this concept is characterized by mild criminal threats, low community

stigma, and generally includes arrangements related to industry activities.<sup>4</sup> Precisely, there are eight types of criminal activities including regulatory offenses, such as a) illegal sales of intoxicating liquor, b) sales of impure or adulterated food or drugs c) sales of misbranded articles, d) violations of anti-narcotics acts, e) criminal nuisances (consisting of annoyances or injuries to public health, safety, repose or comfort, obstructions of highways), f) violations of traffic regulations, g) violations of motor-vehicle laws, and h) violations of general police regulations, passed for the safety, health, or well-being of the community.<sup>5</sup> This study analyzes the application of strict liability in environmental crime. This is important because its provision in Law Number 32 Year 2009 concerning Environmental Protection and Management Act (EPMA) only applies to civil cases as formulated in Article 88. Meanwhile, most of the offenses against this law are essentially an administrative violation which in the formulation does not include a mental element of crime.<sup>6</sup>

The first part of this study explores the theoretical concept of strict liability in criminal law. However, not

all experts agree to apply it but can still be used for certain criminal acts. The second part explains the reasons for its application in environmental offenses, which requires intertwining between administrative and criminal law.<sup>7</sup> Most of them are also related to administrative violations such as permits.

The last part analyzes the application of strict liability to environmental offenses. The research argues that the concept of *res ipsa loquitur* (the thing speaks for itself) is inadequate to serve as a basis for applying it to environmental offenses. However, the EPMA includes an intentional element that was formulated materially. Therefore, the study offers a strict liability implementation in the context of the criminalization models based on environmental harms, especially abstract and concrete endangerment. In both models, violations threatened by criminal sanctions are generally related to administrative infringements since it does not require damages.

## Method

This study is a normative legal study that focuses on the application of strict liability for environmental offenses in EPMA. The offense formulation in the Act is reviewed and selected following its regulatory character since the mental element has the potential not to be proven. Therefore, this study is complemented by the use of a statutory and conceptual approach, of which the first shows legal norms that contain the offense formulation. However, to know which offenses do not require proof of perpetrators, the strict liability doctrine and criminalization-based environmental loss models should be examined, especially abstract and concrete endangerment. Furthermore, legal issues in studies are analyzed qualitatively through data reduction, presentation, and conclusions used simultaneously.

## Results and Discussion

**The Nature of Strict Liability:** Strict liability does not need to prove the perpetrator's culpability against one or more of the *actus reus*<sup>8</sup> since it is no longer considered as partial or total crimes. However, the fact that a commission or an omission offense has been committed needs to be proven. Within the criminal law, it is used for crimes that do not require the perpetrator's fault or a mental element following its occurrence.<sup>9</sup>

L.B. Curzon argues that there are several reasons why this element should not be proven since ensuring

respect for the rules guiding the good of the community is important. Therefore, proving the existence of criminal action (*mens rea*) will be difficult for violations related to social welfare due to the high level of danger posed by the act in question.<sup>10</sup> There are many factors of the legislators which determine the use of strict liability in criminal law, because of, (1) characteristics of a crime, (2) threatened punishment, (3) the absence of social sanctions (*obloquy*) (4) certain damage caused, (5) scope of activities performed, and (6) the formulation of certain verses and their context in law.<sup>11</sup> These six factors demonstrate the importance of public concern in behaviors that need to be avoided by applying strict liability to public safety, the environment, and economic interests, including consumer protection.

Strict liability is most often used for public welfare offenses where criminal sanctions are generally mild such as fines and short imprisonment.<sup>12</sup> It is applied when the court concludes that the evidence of the action element leads to a definitive conclusion of finding it hard to prove the perpetrator's culpability. However, in cases related to violations of public welfare or regulatory offenses, the difficulty in proving is the basis for justifying the application of strict liability, in addition to the fact that the violated act is under public rules that have serious threats to health and safety.<sup>13</sup>

The doctrine of the public welfare offense was formed during the industrial revolution to impose tougher obligations on industry, commerce, property, or other activities that have an impact on public health, safety, and welfare. Strict liability requires two driving factors to improve the implementation of regulatory offenses. First, individual fault-proof requirements will weaken the burden of the criminal justice system. Second, in many violations of regulatory offenses, the fault-proof is quite difficult. Since the existence of some new types of criminal acts is not intentionally required, legislators begin to criminalize regulatory offenses although limited to certain areas.<sup>14</sup>

Strict liability is based on three objectives. First, social objectives such as healthy and clean food and drinks, surviving fires, workplace safety as well as in traffic orientation. Second, they can be better achieved through the types of criminal acts that do not require to prove the perpetrator's culpability to maximize social prevention. Third, strict liability is assumed only based on utilitarianism, when the criminal threat for a corresponding crime is low.<sup>15</sup>

One of the goals of criminal law is to prevent loss in society. The criminal justice system seeks to convict perpetrators that socially violate the 'normal' behavior.<sup>16</sup> In this context, strict liability is primarily based on the utilitarianism argument of promoting effective regulation of activities in various public and important places.<sup>17</sup> Furthermore, it causes people to be more careful in their behavior to prevent the effect of (one's) actions in the future. It also creates a high standard of public behavior in the hope that the public will show increased responsibility and behave more cautiously in certain areas. Therefore, it can prevent harm to others or property.<sup>18</sup>

Not all experts agree that strict liability is used in criminal cases with the reason that they do not require the perpetrators' mistakes proof since they cause controversy.<sup>19</sup> In addition, it violates the fundamental principles of criminal law, where the imposition of its sanctions is only valid when the defendant's mistake has been proven.<sup>20</sup> Therefore, even though strict liability will be applied in criminal cases, it should be limited only to offenses in the *malum prohibitum* category, because the evil nature of an act is not inherent, solely because the law prohibits.<sup>21</sup>

**Rationale for Stict Liability:** Strict liability is regularly used in the environmental offense, and this is justified by several reasons. This offense can lead to long term dangers and they are difficult to repair directly or indirectly. This danger shifts the focus from protecting individual to public interests. However, the use of strict liability in this context only transfer full responsibility of the hazard to people that can prevent the loss.<sup>22</sup>

Hazardous and toxic waste (B3) discharged into the environment without authorization can potentially have uncontrolled effects with B3 migration below the surface. It harms human health and the environment. The application of strict liability is justified because unauthorized storage and disposal of B3 waste, regardless of the precautions taken, can lead to enormous environmental losses in the form of water pollution.<sup>23</sup> The absolute responsibility to think and have knowledge of these actions can potentially harm others or the environment, such as damage and degradation of ecosystems, species extinction, climate change, and global warming, environmental pollution, as well as the increased mortality rate in animals.<sup>24</sup> B3 waste discharged into the environment through safety procedures and processes also increases the incidence of

respiratory illnesses and reduces the overall quality of the earth's atmosphere. The impact can be felt long after the perpetrators dispose these materials.<sup>25</sup>

Strict liability on environmental offenses is also based on the argument that the legal interests to be protected are not only humans and the environment but also future generations. The current generation does have full control over all the natural resources on earth. However, the right of future generations to have equal rights and access to healthy environmental quality should not be compromised.<sup>26</sup> Meanwhile, the environment is also considered as an independent legal interest since it is a victim of crime,<sup>27</sup> therefore, humans need to obey nature (the environment).<sup>28</sup>

The offenses in the EPMA are mostly related to violations of administrative obligations such as authorization. Therefore, it depends on fulfilling the conditions set by or the provisions contained in administrative regulations set out in Articles 100, 101, 102, 103, 104, 109, 110, 111, and 114. The offenses are categorized as administrative dependent crimes for three reasons. First, it is a formal offense that focuses on the prohibited acts, and not the consequences. Second, the prohibited actions are not shameful, but because they are prohibited by law (legally wrong). Third, the essence of offense in this study relates to violation permits for authorization. Therefore, the administrative nuance is thicker since some requirements need to be fulfilled prior to performing certain actions. Violations of these requirements are categorized as criminal offenses.<sup>29</sup>

Mental/mistakes elements were not explicitly stated in the offenses formulation, and they are considered to be proven by the prohibited acts. Therefore, there is no obligation for the public prosecutor to prove the mental element. Its absence in the strict liability context requires everyone including corporations to be more careful in performing actions that can endanger the environment.<sup>30</sup>

**Applying Strict Liability for Environmental Offenses:** Environmental offenses stipulated in the EPMA consist of formal and material kinds. Formal offenses are regulated from Articles 100 to 111 and from Articles 113 to 115, and they are mostly administrative-dependent. On the contrary, material offenses are regulated in Articles 98, 99, and 112. The criminal law in the first two articles has been separated from the administrative independence of environmental criminal law. When the perpetrator's actions have caused

environmental damage or pollution, criminal sanctions can be imposed immediately even though they are not against the law.

Strict liability can be applied to formal offenses with substance in the form of administrative's violation requirements such as a permit/license. However, its implementation in material offenses will cause some problems. In many cases, environmental damage or pollution only occurs long after the prohibited acts have been committed. It is very difficult to prove the causal relationship (causality) in environmental cases because they are varied, chained, and complex as well as involving many variables especially in pollution.<sup>31</sup> The criminal threat in material offenses at the EPMA is also very severe in the form of imprisonment years of at least 5 and at most 15 as well as fines of at least 5 billion and a maximum of 15 billion. The severity of this criminal threat contradicts the strict liability character that mostly related to regulatory offenses.

According to the study, its implementation needs to pay attention to the criminalization models-based on environmental harm, especially the abstract and concrete endangerment models since they do not require to prove culpability of the actors. The prohibited actions on both models are all formulated as formal offenses, while the substance is in the form of administrative requirements' violation. The first model criminalizes offenses towards administrative obligations. The criminal law is enforced immediately after violating an administrative law sequel to the occurrence of a real loss or threat of violation. This model restricts criminal acts without involving direct contact between contaminated material and the environment.<sup>32</sup>

Environmental offenses of the first model include 'conducting business activities (UKL-UPL) without having an environmental permit in Article 109', 'preparing EIA without having a competency certificate of its compiler in Article 110', and 'issuing an environmental permit without being equipped with UKL-UPL (Environmental Management Efforts (UKL) and Environmental Monitoring Efforts (UPL)) or issuing a business authorization without being equipped with an environmental permit in Article 111'. However, the offenses without involving direct contact between contaminated material and the environment do not require proof of loss threat.

The second model does not require proof of actual loss, but sufficient in proving the threat of loss and

actions performed unlawfully.<sup>33</sup> Criminalization in this model is performed to prevent the loss of both humans and the environment.<sup>34</sup> Therefore, this model emphasizes that emissions or pollution can cause damage and need to be proven since they are performed unlawfully. As long as the administrative regulations are followed, the law is not considered a criminal offense when it is legally enforced. In contrast, it is qualified as a crime when committed illegally.<sup>35</sup> Furthermore, it directly protects ecological values, but its existence depends on administrative regulations.<sup>36</sup>

The offenses in the second model criteria include 'releasing and distributing genetic engineering products to environmental media that contradict the permit in Article 101', 'violating the wastewater and emission-quality standard in Article 100', 'conducts B3 waste management without permission in Article 102', 'produces B3 waste and does not conduct management in Article 103', and dumps waste material into the environmental media without permission in Article 104'. These offenses relate to direct contact between the contaminated material and the environment. Furthermore, there is evidence that actions are performed against the law and threaten environmental damage/pollution.

Strict liability can be applied to these offenses considering that they have been formulated as formal offense that do not require the causation. The absence of a criminal offense also depends on administrative requirements. Therefore, the administrative nuance is very thick with regulatory offenses, and it does not include mental elements such as intention or negligence. In addition, the defendant can be convicted when proven guilty of prohibited acts without authorization. The method of formulating prohibited acts also shows that the intentions of the perpetrators already exist when they commit them. Although, it does not need to be proven, such as managing B3 waste, and dumping it to environmental media without permission. These actions are generally performed by corporations since they have the potential to harm both humans and the environment.

## Conclusion

Strict liability is often used in offenses aimed at protecting public interests which endanger human safety/health and the environment. The use of this doctrine on environmental offenses correlates with its position as an independent legal interest that prioritizes the prevention of hazards. Also, the implementation of

strict liability needs to be limited in the EPMA only to offenses dependent on the criminal law as in the abstract and concrete endangerment models. Their offenses are generally related to waste/emissions discharged into the environmental media without permission. They are also formulated as formal offenses, where the perpetrators' mental element is not included in the formula. Therefore, it does not need to be proven.

**Conflict of Interest:** Nil

**Source of Funding:** Faculty of Law Diponegoro University

**Ethical Clearance:** Taken from Ethical Committee, Doctorat Program in Law Diponegoro University

### References

- Richard Sanders, "The Knowledge Element in Drug Cases: Some Final thoughts on Shelton and Adkins", *Florida bar Journal*, 2014; 88: 42.
- Michael Bohan, "Complicity Strict Liability: A Logical Inconsistency?" *University of Colorado Law Review*, 2015; 86: 634-635.
- Golan Luzon, "Challenges Shared by Restorative Justice and Strict Liability in the Absence of Mens Rea", *New Criminal Law Review*. 2016; 19: 583.
- Geraldine SzottMoohr, "Playing with the Rules: An Effort to Strengthen the Mens Rea Standards of Federal Criminal Laws", *Journal of Law, Economics & Policy*, 2011; 7: 696-697.
- Rick Libman, "Is Presuming Guilt for Regulatory Offences still Constitutional but Wrong? R v Wholesale Travel Group Inc and Section 1 of the Charter of Rights and Freedoms 20 Years After", *Ottawa Law Review*, 2012-2013; 43: 459.
- Hanafi Amrani & Mahrus Ali: *Theory of Criminal Liability Its Development and Application*. Rajawali Press, Jakarta: Rajawali Press, 2015: 52-55.
- Michael G. Faure et al., "Imposing Criminal Liability on Government Officials under Environmental Law: A Legal and Economic Analysis", *Loyola of Los Angeles International and Comparative Law Journal*, 1996; 18: 558.
- Russel Heaton: *Criminal Law Textbook*. London: Oxford University Press, London, 2006: 403.
- W. Robert Thomas, "On Strict Liability Crimes: Preserving a Moral Framework for Criminal Intent in an Intent-Free Moral World", *Michigan Law Review*, 2012; 110: 650
- L.B. Curzon: *Criminal Law*. London: Mac Donald & Evans Limited, 1973: 41.
- Yusuf Shofie: *Corporate Criminal Liability in Indonesia Consumer Protection Law*. Bandung: Citra Aditya Bakti, 2011: 362-363.
- Golan Luzon, "Challenges Shared by Restorative Justice and Strict Liability in the Absence of Mens Rea", *New Criminal Law Review*, 2016; 19: 583
- Darryl K Brown, "Strict Liability in the Shadow of Juries", *SMU Law Review*, 2014; 67: 535-536.
- Rachel A Lyons, "Florida's Disregard of Due Process Rights for Nearly a Decade: Treating Drug Possession as a Strict Liability Crime", *Saint Thomas Law Review*, 2012; 24: 359-360.
- Michael S Moore, "The Strictness of Strict Liability", *Criminal Law and Philosophy*, 2018; 12: 521.
- Kimberly Bolte, "Shot through the Heart: The FDA Give all Health Care Company Executives a Bad Name under the Controversial Strict Liability Misdemeanor Provision of the Federal Food, Drug, and Cosmetic Act", *Brooklyn Journal of Corporate, Financial & Commercial Law*, 2012; 6: 602.
- Golan Luzon, "Challenges Shared by Restorative Justice and Strict Liability in the Absence of Mens Rea", *New Criminal Law Review*, 2016; 19: 583
- Joshua Fershee, "Choosing a Better Path: The Misguided Appeal of Increased Criminal Liability after Deepwater Horizon", *William and Mary Environmental Law and Policy Review*, 2011; 36: 5.
- Michael Bohan, "Complicity Strict Liability: A Logical Inconsistency?" *University of Colorado Law Review*, 2015; 86: 634-635.
- Vera Bergelson, "A Fair Punishment for Humbert: Strict Liability and Affirmative Defenses", *New Criminal Law Review*, 2011; 14: 60-61.
- Kalyani Robbins, "Paved with Good Intentions: The Fate of Strict Liability under the Migratory Bird Treaty Act", *Environmental Law*, 2012; 42: 594
- James R MacAyeal, "The Comprehensive Environmental Response, Compensation, and Liability Act: The Correct Paradigm of Strict Liability and the Problem of Individual Causation", *UCLA Journal of Environmental Law & Policy*, 2000/2001; 18: 243.

23. Jan G Laitos, "Standing and Environmental Harm: The Double Paradox", *Virginia Environmental Law Journal*, 2013; 31: 67-71.
24. Neal Shover & Aaron S Routhe, "Environmental Crime", *Crime and Justice*, 2005; 32: 323-324.
25. Rowena Maguire, "Incorporating International Environmental Legal Principle into Future Climate Change", *Carbon & Climate Law Review*, 2012; 6: 105
26. Mary Christina Wood: *Nature's Trust Environmental Law for a New Ecological Age*, New York: Cambridge University Press, 2014: 6.
27. Matthew Hall, "Environmental Harm and Environmental Victims Scoping out a Green Victimology", *International Review of Victimology*, 2014; 20: 129-143
28. Federico Picinali, "The Denial of Procedural Safeguards in Trials for Regulatory Offences: A Justification", *Criminal Law and Philosophy*, 2017; 11: 685
29. Susan F. Mandiberg & Michael G Faure, "A Graduated Punishment Approach to Environmental Crimes: Beyond Vindication of Administrative Authority in the United States and Europe", *Columbia Journal of Environmental Law*, 2009; 34: 478.
30. James R MacAyeal, "The Comprehensive Environmental Response, Compensation, and Liability Act: The Correct Paradigm of Strict Liability and the Problem of Individual Causation", *UCLA Journal of Environmental Law & Policy*, 2000/2001; 18: 243.
31. M. Faure & M Nisser, "How to Punish Environmental Pollution- Some Reflections on the Various Models of Criminalization of Environmental Harm", *European Journal of Crime, Criminal Law and Criminal Justice*, 1995; 3: 319.
32. Susan F. Mandiberg & Michael G Faure, "A Graduated Punishment Approach to Environmental Crimes: Beyond Vindication of Administrative Authority in the United States and Europe", *Columbia Journal of Environmental Law*, 2009; 34: 478.
33. Michael Faure, "Towards a New Model of Criminalization of Environmental Pollution: The Case of Indonesia. In Faure, Michael & Niessen, Nicola (Editor): *Environmental Law in Development Lesson from the Indonesia Experience*, UK: Edward Elgar Publishing Limited, 2006: 197.
34. Zachary Hoskins, "Criminalization and the Collateral Consequences of Conviction", *Criminal Law and Philosophy*, 2018; 12: 634.
35. Michael Faure, "The Revolution in Environmental Criminal Law in Europe", *Virginia Environmental Law Journal*, 2017; 35: 335.
36. Byung-Sun Cho, "Emergence of an International Environmental Criminal Law?" *UCLA Journal of Environmental Law and Policy*, 2000/2001; 19: 22-23.

# Investigation of Cutaneous Leishmaniasis Cases in Baghdad Province, Iraq

Aliaa F.A. Al-Naimy<sup>1</sup>, Ali B.M. Al-Waaly<sup>1</sup>

<sup>1</sup>Scholar Researchers, Department of Biology, College of Science, University of Al Qadisiyah, Iraq

## Abstract

444 cases were recorded of cutaneous leishmaniasis in Baghdad General Hospitals and some private clinics in Baghdad city and reviewed during the period from 1/10/2019 until 5/2020. The lesions were clinically diagnosed by dermatologists. Where the highest incidence was among males compared to females, it was found that the age group of (1-10) and (10-20) is the highest injury and that the rest of the age groups showed a decline. It was clear that the lowest percentage was among (50-60 yrs) patients, and the highest injury among the youth category. The rate of infection was higher in rural and agricultural areas compared to the city center. The infection rates in relation to different body sites are the highest in the upper extremities compared to the lower extremities. And according to the ulcer number, the multiple types were more than the single ulcers, and regarding the time of infection the highest rates of infection appear in December and February compared to the rest of the year.

**Keywords:** *Cutaneous Leishmaniasis, Leishmania tropica, major, Leishmania epidemiology.*

## Introduction

Cutaneous leishmaniasis is a transmitted disease caused by multiple types of leishmania, and it represents a public health problem in society and a danger to people who travel or live in endemic areas<sup>(1)</sup>. About 12 million people are infected in 98 countries with these diseases, with 350 million people are at risk of infection<sup>(2)</sup>. Parasites are transmitted through the bite of the sand fly female, of the genus *Phlebotomus* in the Old World or the genus *Lutzomyia*<sup>(3)</sup>. Approximately 100-1000 promastigotes are infected into the skin as they are invaded by the neutrophils that spread rapidly at the site of the sting<sup>(4)</sup>. The total number of reported cases of leishmaniasis in the period from 2008 to 2015 in Iraq reached 17001 cases ranging between 2.9-10.5/100,000

people<sup>(5)</sup>. Aim of this study to determine investigation of cutaneous Leishmaniasis cases in Baghdad province, Iraq.

## Materials and Method

**Study Area:** Baghdad is the capital of the Republic of Iraq, and it is in the Tigris Plain Valley in central Iraq, about 39 meters above sea level, between latitudes 33 north and 44 east. Its climate is generally hot. The rainfall rate is 100-175 each year, 58 between November and March. Average temperatures reach 50° C during the summer, and according to<sup>(6)</sup> the average high temperature is 15.5 ° C (January) to 44°C (July), and the average low temperature is 3.8°C (January) to 25.5°C (July).

**Sample Collection:** The epidemiological study was conducted on 444 patients suffering from skin lesions of different ages and genders that were diagnosed by dermatologists as leishmaniasis for the people who came to the hospitals of Baghdad, which were included in the study and for the period from 1<sup>st</sup> October 2019 until May 2020.

---

### Corresponding Author:

Aliaa F.A. Al-Naimy

Scholar Researchers, Department of Biology, College of Science, University of Al Qadisiyah, Iraq

e-mail: aliafaiq542@gmail.com

**Diagnosis of Samples:**

**Clinical Diagnosis:** Clinical diagnosis was made by a dermatologist.

**Laboratory Diagnosis:** Used direct smear method prepared from the edge of the ulcer and stained using Giemsa then checked for amastigotes by high-power microscope with oil immersion.

**Statistical Analysis:** The data was analyzed using SPSS statistic software version 25. Chi-square test was used for the assessment of association among the variables studied. The p-value of less than 0.05 was statistically significant, and highly significant for p-value of less than 0.001<sup>(7)</sup>.

**Results**

**1. Percentage of people with cutaneous leishmaniasis, by sex:** The highest infection rate for males was 55.6% compared to females at 44.4%, as shown in Table (1). The results of the statistical analysis using Chi-square were used, and there was a significant difference between the infection of cutaneous leishmaniasis and its relationship to gender under the probability level 0.05.

**Table (1): Shows percentages of people with cutaneous leishmaniasis by gender.**

Sex	No. of infection	Percentage
Male	247	55.6
Female	197	44.4
X <sup>2</sup>	11.26	
P value	P 0.001(HS)	

**HS:** Highly significant difference (P < 0.01)

**2. Percentage of patients with cutaneous leishmaniasis, by age:**

The proportions of infection with cutaneous leishmaniasis parasite were calculated based on the age groups, where it was found that the age group of (1-10) and (10-20) have the highest infection rate, reaching (32.0%) and (36.0 %), respectively, and that the rest of the age groups showed a clear decline, and the lowest percentage among (50-60 yrs) was (1.0%), as shown in table (2). The results of the statistical analysis using the Chi-square showed that there were significant differences without infection with cutaneous leishmaniasis and age groups below the probability level 0.05.

**Table (2) Shows the percentages of people with cutaneous leishmaniasis by age**

Age group	No. of infected	Percentage
10 >	142	32.00
10 – 20	160	36.00
20 – 30	67	15.00
30 – 40	62	14.00
40 – 50	9	2.00
< 50	5	1.00
Total	444	100
X <sup>2</sup>	344.41	
P value	P < 0.0001(HS)	

**HS:** Highly significant difference (P < 0.01)

**3. Percentage of patients with cutaneous leishmaniasis, according to the location of the residence:** The rates of infection with cutaneous leishmaniasis parasite, according to the location of housing during the current study period showed that the rates of infection increased in Rural areas by (39.0%), followed by agricultural areas in the city by (27.0%) while the remaining infection rate was in the center of the city urban areas and has shown a decline in injury rates, as shown in Table 3. The results of the statistical analysis using the Chi-square showed significant differences. The prevalence of cutaneous leishmaniasis in the districts, poor areas, and the city center is below the probability level 0.05.

**Table (3) Shows the percentage of people with cutaneous leishmaniasis, according to the location of the residence.**

Region	No. of Infected p. ts	Percentage
Assadr	174	39.00
Mahmudiyah	120	27.00
Hosseiniech	59	13.00
Alkaramah	63	14.00
Adhamiya	28	7.00
Total	444	100.0
X <sup>2</sup>	189.79	
P value	P < 0.0001(HS)	

**HS:** Highly significant difference (P < 0.01)

**4. Parasitic infection percentages according to the site of infection from the body:** The rates



of infection in the hands and feet sites are among the areas most affected by parasitic ulcers (60.0%) compared to the face (25.0%). The lowest incidence of ulcer was the back site (2.0%), as shown in Table 4. The results of the statistical analysis using the Chi-square showed significant differences. Infection with cutaneous leishmaniasis and its distribution to different areas of the body under the probability level of 0.05.

**Table (4): Shows the percentage of parasitic infection according to the site of infection from the body.**

Infection site	Number	Percentage
Face	210	25.00
Neck	81	10.00
Chest	26	3.00
Back	22	2.00
Hand	299	36.00
Foot	198	24.00
Total	836	100.0
X <sup>2</sup>	550.7	
P value	P < 0.0001(HS)	

HS: Highly significant difference (P < 0.01)

### Discussion

**Distribution of cutaneous leishmaniasis by gender:** The results of the statistical analysis of the relationship between cutaneous leishmaniasis and the host's sex showed that males had a higher rate of infection than females with a rate of 55.6% and 44.4%, respectively. It may be attributed to the fact that males are more exposed to infected vectors than females. Arroub *et al*<sup>(8)</sup> stated that males who work or sleep in the open and rooftop areas with less body coverage are more susceptible than others. Some studies have assumed that the sex difference observed in some parasitic diseases can be attributed to hormonal influences, but the role of sex hormones in the immune response remains controversial<sup>(9,10,11)</sup>. The current study agreed with Mohammad & Al-Khaliq<sup>(12)</sup> in Baghdad governorate, where it recorded the highest rates of infection in males with a rate of (65%) compared to (35%) of females. The study also agreed with Salman *et al.*<sup>(13)</sup>, where the highest percentage of males was recorded at 56 and (82.35%) more than females whose number of injuries exceeded 12 and by (17.64%). It agrees with Al-Khayyat *et al.*,

<sup>(14)</sup> in the governorate of Baghdad, where it recorded the highest rates of infection in males by (60.3%) compared to females by (39.6%). The study differed with Kattoof,<sup>(15)</sup> in Baghdad Governorate, where it recorded the highest rate of infection among females, as it reached (24%) in comparison with males (21%). It also differed with what Alawieh *et al*<sup>(16)</sup> in his studies in Syria, where he recorded the highest percentage of females (52%) compared to females (48.9%).

### Distribution of cutaneous leishmaniasis by age:

The current study showed that the highest incidence of cutaneous leishmaniasis is between (10-20) years, with a rate of (36%), and the lowest in the age group (5-60) years with a rate of (2%). Significantly due to the external activities of young people more than other age groups where young people are often ill<sup>(17)</sup>. The low incidence of cutaneous leishmaniasis for older adults may be related to the fact that they were infected during the early ages and acquired long-term immunity during Childhood<sup>(9,10,18)</sup>. The current study agrees with<sup>(12)</sup>, which recorded the highest incidence of cutaneous leishmaniasis in the age groups between 5-24 years more than others (67.5%). The current study differs with Al-Mafraji *et al.*,<sup>(19)</sup> in Baghdad governorate, where the highest rates of infection were recorded for ages under 30 years of age from the youth category (42.6%). The study differed with Al-Mayali & Al-Hassani,<sup>(3)</sup> in Diwaniyah governorate, where the highest incidence of cutaneous leishmaniasis was recorded for less than 5 years of age group 34.7%.

### Distribution of cutaneous leishmaniasis according to residence:

The obtained results showed that the rates of infection increased in the agricultural areas, districts, and poor neighborhoods, where they increased in Sadr City by 39%, followed by the Mahmudiyah District by 27% and the lowest in the Adhamiya region by 7%, attributed to the increase in the highest rates of infection in the agricultural and districts And slum areas due to the abundance of poor hosts that store the disease, which leads to an increase in the chances of infection with the parasite throughout the year, and it increases especially in agricultural areas due to the continuous cultivation of it in all seasons of the year, while this percentage decreases in urban areas.<sup>(9,20)</sup>. The study agreed with Kashkool,<sup>(21)</sup> reported the highest infection rates in rural and agricultural areas, reaching 317 (92.4%), and the lowest injury was recorded in urban areas, reaching 26 (7.6%). The current study also agreed with Al-Mashhadany,<sup>(22)</sup>; Al-Mayali & Al-Hassani,<sup>(3)</sup>; Khudhur,<sup>(23)</sup> they recorded

the highest rates of infection in agricultural and rural areas and the lowest infection in urban areas. They also agree with Reda,<sup>(12)</sup> in Babel governorate, where the highest rates of infection were recorded in agricultural regions with a rate of (55%) followed by the districts with (25%) and the lowest percentage in the city center with a rate of (20%). The study differed with Kattoof,<sup>(15)</sup> in Baghdad governorate, where the highest rate of infection was recorded in urban areas, at a rate of (28%), compared to rural areas and poor neighborhoods, at a rate of (18%). The study also came different with what Luma<sup>(24)</sup> found In the city of Babel, where the highest incidence of cutaneous leishmaniasis in urban areas was 32 (53.3%) more than in rural areas 28 (46.7%).

### Conclusions

The Leishmania parasite infects both sexes and all ages without exception and the highest incidence was for young people, and infection were also recorded that the highest incidence was in January and February, while multiple ulcers occupied the largest proportion of ulcers and the most affected sites were the hand and face compared to different body sites. The city of Baghdad is one of the cities where cutaneous leishmaniasis is endemic, as infection varies according to the difference in regions.

**Conflict of Interest:** None

**Funding:** Self

**Ethical Clearance:** Not required

### References

1. Youssef NG. Black Fever. Scientific bulletin. Najaf Health Department, Primary Care Department. Ministry of Health, 2002. p. 119.
2. Khazaei S, Hafshejani AM, Saatchi M, Salehiniya H and Nematollahi S. Epidemiological aspects of cutaneous leishmaniasis in Iran. Archives of Clinical Infectious Diseases, 2015. 10(3), 218-222.
3. Al-Mayali HMH and Al-Hassani MKK. Morphological Descriptive Study of Phlebotominae Species (Diptera: Psychodidae) in Eastern Al-Hamza District, Al-Diwaniya City. Int. J. Curr. Microbiol. App. Sci, 2016. 5(9), 667-674.
4. Al-Hassani MKK and Al-Mayali HMH. Evaluation of some biochemical levels in patients with Cutaneous leishmaniasis serum and their relationship with antioxidant enzymes. Eurasian Journal of Biosciences, 2020. 14(1), 1999-2006.
5. Al-Obaidi JM, Abd Al-Hussein MY and Al-Saqur IM. Survey Study on the Prevalence of Cutaneous Leishmaniasis in Iraq. Iraqi Journal of Science, 2016. 57(3), 2181-2187
6. Ncci NGO. Coordination Committee for IRAQ. Sulaymaniyah Governorate Profile. 2015.
7. Sheskin DJ. Handbook of parametric and nonparametric statistical procedures. 3rd ed. Boca Raton: Chapman & Hall/CRC, 2004, 1-77.
8. Arroub H, Alaoui A and Habbari K. Etude Eco-Epidemiologique de la Leishmaniose Cutanée dans la Région de Foum Jamâa (Azilal, Maroc). In Le Premier Colloque International sur les Changements Climatiques et Environnement. Faculté des Sciences, Rabat, Maroc. 2010.
9. Al-Waaly ABM and Shubber HWK. Epidemiological study of Cutaneous leishmaniasis in Al-Diwaniyah province, Iraq. EurAsian Journal of BioSciences, 2020. 14(1), 269-273.
10. Al-Myahy FS, Al-waaly ABM and Shubber HW. Laboratory diagnosed for some diseases in Al-Diwaniya province. Journal of Al-Qadisiyah for Pure Science (Quarterly), 2009, 14(1), 44-57.
11. Bailey M and Lockwood D. Cutaneous leishmaniasis. Dermatol. 2007; 25:203–211. College of Science, University of Baghdad: 2007, 116 pages.
12. Mohamed Reda AZ. Epidemiological and immunological study of cutaneous leishmaniasis in Al-Kifel, Babylon governorate Iraq. Msc thesis, University of Kufa, Iraq. 2018.
13. Salman IS, Vural A, Unver A and Sacar S. Cutaneous leishmaniasis cases in Nizip, Turkey after the Syrian civil war. Mikrobiyol Bul, 2014. 48(1), 106-13.
14. Al-Khayat H, Gurganus C, Newcomb DE and Sakhaeifar MS. Developing Specification Limits for Hot Mix Asphalt Properties and Impact on Pay Factors. Journal of Transportation Engineering, Part B: Pavements, 2020. 146(3), 502-507.
15. Kattoof WM. Intralesional streptomycin: New, safe, and effective therapeutic option for cutaneous leishmaniasis. Mustansiriya Medical Journal, 2018. 17(1), 42-46
16. Alawieh H, Tehrani KA, Azzouz Y and Dakyo B. A new active common-mode voltage elimination

- method for three-level neutral-point clamped inverters. In IECON 2014-40th Annual Conference of the IEEE Industrial Electronics Society, 2014. 1060-1066.
17. Akcali C, Çulha G, İnalöz HS, Savaş N, Önlen Y, Savaş L and Kirtak N. Cutaneous Leishmaniasis in Hatay. Turkey Published: J Turk Acad Dermatol 2007. 1(1),1-16.
  18. Zaph C, Uzonna J, Beverley SM and Scott P. Central memory T cells mediate long-term immunity to *Leishmania major* in the absence of persistent parasites. *Nature medicine*, 2004, 10(10), 1104-1110.
  19. AL-Mafraji KH, Al-Rubaey MG and Alkaisy KK. Clinico-epidemiological Study of cutaneous leishmaniasis in AL-Yarmouk Teaching Hospital. *Iraq Journal Community*, 2008. 21(3), 194-197.
  20. Kassiri H, Mortazawi H and Kazimi SH. The epidemiological study of cutaneous leishmaniasis in Khorramshahr city, Khouzestan Province, South-west of Iran. *Jundishapur J. Health Sci*, 2011. 3, 11-20.
  21. Kashkool AH. Some ecological and biological aspects of phlebotominae (Diptera; Psychodidae) and the epidemiology of cutaneous leishmaniasis in Diwaniya Governorate". M.Sc. thesis, college of sciences, University of Al-Qadisiya, Iraq. 2009.
  22. Al-Mashhadany W. Present status of cutaneous Leishmaniasis and its vectors in Baghdad area. M.SC. Thesis, College of science, University of Baghdad, Iraq. 2002.
  23. Khudhur HR and Alomashi GB. Effect of NRAMP1 gene polymorphism on levels of (TNF- $\alpha$  and IL-1 $\beta$ ) cytokines in cutaneous Leishmaniasis patients in Iraq. *Journal of Immunology and Clinical Microbiology*, 2018. 3(2), 15-22.
  24. Luma AH. Molecular study for cutaneous leishmaniasis and its relation parameters in patients of Al-Najaf Al-Ashraf province. PhD. Thesis, Al-Qadisiya University, Iraq. 2019.

















# To Compare the Effects of Footwear in Young Female's Postural Balance in Prolonged Standing and Sitting Job

Anandita Sharma<sup>1</sup>, Yamini Sharma<sup>2</sup>, Megha Yadav<sup>2</sup>,  
Mangalam Kumari<sup>2</sup>, Jyoti Sharma<sup>2</sup>, Sakshi Arora<sup>2</sup>, Akshay Anand<sup>3</sup>

<sup>1</sup>Student Researcher, BPT Galgotias University, Greater Noida, India, <sup>2</sup>Assistant Professor, Galgotias University, Greater Noida, India, <sup>3</sup>Assistant Professor, Manav Rachna International University, Faridabad, India

## Abstract

**Background:** Footwear has an essential role in raising well-being of any person. Many females have wear heel or flat footwear on their daily basis as if they are working or not. Footwear creates discomfort which leads to pain in foot, and results in alteration of balance. Most of the working places requires prolonged period of standing which is possibly associated with musculoskeletal disorders, likely affects our health and acute trauma from the working places. Prolonged sitting and standing can directly affect the weight-bearing joints majorly the hip, knee and ankle joint which in turn leads to deformities and effects balance. Changes in this composite system results in the risk of falls and loss of stability.

**Objective:** The objective of the study was to identify the effects of footwear in young female's postural balance in prolonged standing and sitting job.

**Materials and Method:** 100 healthy females were taken for the study age 18-35 years but only 60 were selected for the study. The subject had to perform Rhomberg test and tandem walk for balance assessment.

**Result:** On analysis, it was found that in rhomberg balance test, 73.33% population were positive with the test. 8.33% population were positive with the eyes opened and 65% population were positive with the eyes closed and in tandem walk, 31.66% population is positive who were unable to complete the test.

**Conclusion:** In conclusion, the balance tests shows that, wearing footwear for prolonged hours of standing and sitting job, states that the balance and postural control worsening which is associated with decrease in postural stability and increase in the risk of falls.. According to the study balance is more effected in prolonged sitting than in prolonged standing.

**Keywords:** Balance, postural control.

## Introduction

There are many different professions in our country in which females are working. Some have sitting jobs (co-operative jobs,) and other have standing jobs (female

guards, CRPF females, female traffic police job etc). During long hours of job, women prefer footwear which are more comfortable in standing as well as in sitting. Footwear are considered by the women as an essential part of their regular outfit. There are different types of fancy footwear females have wear to appear good and this also enhances their personality.

---

### Corresponding Author:

**Akshay Anand**

Assistant Professor, Manav Rachna International  
University, Faridabad

e-mail: akshayaanad.anand25@gmail.com

With generality of 39% noticed in institutional settings and 78% of generality noticed in clinical settings which showed a massive ratio of female population and with this usage of different heels and flat footwear leading to alterations in the person postural balance.

There was a survey conducted by the hotter shoes which suggested that to look attractive women goes to such extent that they wear different heels which extremely very high which are leading to problems such as sore foot and tired foot because of wearing them whole day.<sup>1</sup> Murphy et al. had recommended that footwear were the key component in the building of human posture.<sup>2</sup>

Footwear has an essential role in raising well-being of any person.<sup>3</sup> As footwear passes the sensory information to the foot, and a person can control the postural stability through the touch and proprioception.<sup>4,5</sup> Footwear creates discomfort which leads to pain in foot, and results in alteration of balance.

Balance can be defined as a situation in which one's body dynamics are proportionate just to prevent the person's body from falling and also the ability to uphold, attain and reinstate the person's body center of mass (COM) respective to the base of support (BOS). Maintaining balance is acknowledged as keeping the center of gravity (COG) in BOS defined by the feet.<sup>7</sup> Balance is sustained through dynamic combination of internal and external.<sup>8</sup> Functional activity and motion is necessary for balance. Functional balance is capability of an individual to maintain a position and posture during any functional motion.<sup>2</sup>

Postural control or balance can be defined statically as the ability to maintain a base of support with minimal movement and dynamically as the ability to perform a task while maintaining a stable position.<sup>10</sup>

The aim of the study is to determine the effects of footwear on young female's postural balance in prolonged standing and sitting job. Many researches have been done on effects of footwear on balance but this research will leads to explain the how footwear effects the balance in prolonged standing and sitting job. For static balance test, rhomberg berg test has been done and for dynamic balance test, tandem walk has been done.

Prolonged period of working is defined as standing and sitting for 50 percent of the working day or more of it.<sup>11</sup> Most of the working places requires prolonged period of standing which is possibly associated with musculoskeletal disorders, likely affects our health and acute trauma from the working places. Most of the interviews disclosed excessive proportion of musculoskeletal discomfort and environmental demands and other chronic problems.<sup>12</sup> Neck and trunk flexion in prolonged standing in day to day life is the threat which

causing skeletal disorders and it can lead to various problems in legs and feet such as discomfort, fatigue and pain in neck, lower back, hip, spinal compression, chronic venous insufficiency. It also increases risk of heart attack, swelling due to impaired circulation and decreases the oxygenation and nutrients supply leads to muscle fatigue.<sup>1</sup>

Static postures such as prolonged sitting and prolonged standing increase physical and mental exertion on the body and these exertions increases the force on the musculoskeletal system.<sup>13</sup> Disuse of muscles by prolonged sitting can cause weakness of muscles. Prolonged sitting can lead to ischemia, apoptosis (programmed cell death), it may directly affect the musculoskeletal system<sup>13</sup> like pain in legs,<sup>16</sup> chronic venous insufficiency,<sup>18</sup> spinal compression,<sup>15</sup> and impaired circulation which in result causes swelling of the lower extremities.<sup>13,14</sup> During standing in one position or maintaining the erect posture without an ease of walking rhythmically, affects the blood circulation and compromised body fluids.<sup>13</sup> This causes swelling and pooling in lower extremities.<sup>13,14</sup>

Prolonged sitting and standing can directly affect the weight-bearing joints majorly the hip, knee and the ankle joint which in turn leads to deformities and effects balance. Changes in this composite system results in the risk of falls and loss of stability.<sup>3</sup> In maintaining the balance of the body which may be deformed both by intrinsic forces (body movement), and by the extrinsic forces (the forces which is acting on the body in a certain environment).<sup>3</sup>

There are many more researches based on balance but there is no research had been done on the effects of footwear on young female's postural balance in prolonged standing and sitting job. This research will provide the intra subject reliability of balance measurements in young females.

## Material and Method

**Study Area:** This study was carried out from the various working places.

**Study Design:** This was an observational study.

**Study Population:** The study population consisted of 100 young females.

**Study criteria:**

**Inclusion:** Healthy female’s (18-35years).

**Exclusion:** Any diagnosed history of recent musculoskeletal trauma, congenital anomalies, joint pain, neurological disorders.

**Procedure:**

1. **Rhomberg test:** In this test, the subject was asked to stand with the feet together and arms hanging alongside . The subject is instructed to stand for 30 seconds with eyes open and the postural sway was observed. Then we asked the subject to close her eyes The test is positive if sway or imbalance was there.
2. **Tandem walk:** The subject is instructed to fold their arms across their chest walk by placing one foot directly in front of the other, like heel-to-toe walking. Walking as fast as they could for 30 steps.<sup>17</sup> The test is positive if the subject cannot walk in heel

to toe position or if the subject is disbalanced during the test.

**Result**

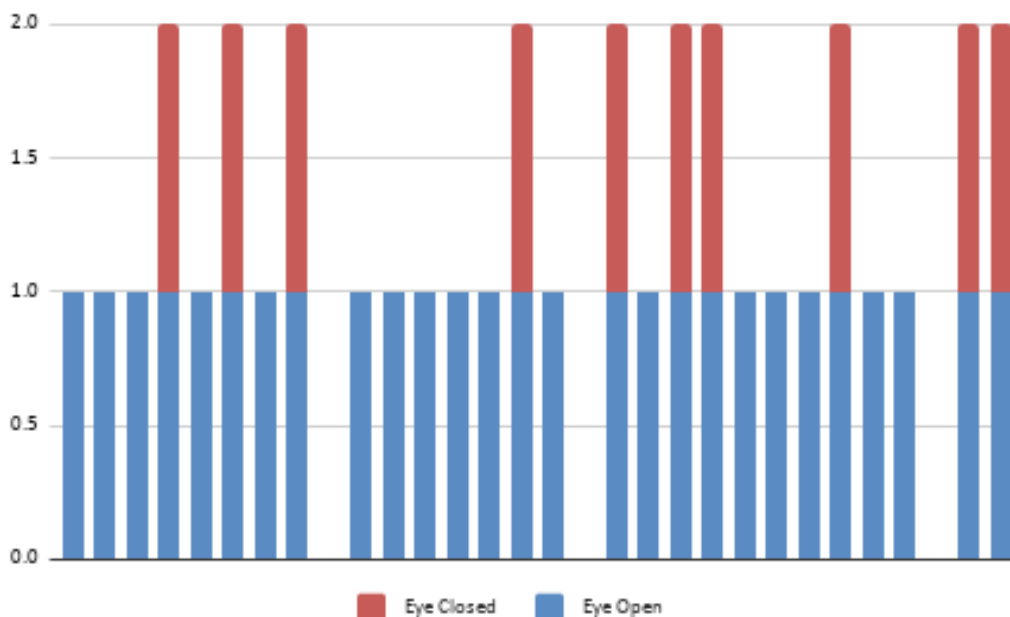
The total subjects taken for this study were 100 but only 60 were fit for the study and 40 subjects were excluded on the basis of exclusion criteria.

This is an observational study and there is some inclusion and exclusion criteria for the accuracy of the data which was collected from the subjects. The Balance tests which have been done to identify the static and the dynamic balance. Rhomberg test have been done with eyes open and close to identify the static balance. In Rhomberg test, 73.33% population were positive with the test. 8.33% population were positive with the eyes opened and 65% population were positive with the eyes closed. (Table 1). Tandem walk were used to observe the dynamic balance, 31.66% population is positive who were unable to complete the test. (Table 2).

**Data:**

**Table 1: Rhomberg Test**

Parameters	No. of subjects	Percentage (%)	Mean±Standard Deviation
<b>1a. Eyes open</b>			
No Sway	55	91.66%	0.9166 ± 0.2763
Sway	5	8.33%	
<b>1b. Eyes closed</b>			
No Sway	21	35%	0.35 ± 0.4769
Sway	39	65%	



**Graph 1: Showing data of eye closed and eye open subjects.**

The graph showed the percentage of the subjects sway or no sway during Rhomberg's eyes open and close test.

**Table 2: Tandem walk**

Parameters	No. of subjects	Percentage (%)	Mean±Standard Deviation
Positive test	19	31.66%	0.6833 ± 0.4561
Negative test	41	68.33%	

Table 2 This graphs showed the relation between the age and the test performed by the subjects.

## Discussion

In this research, we have examined the effects of footwear on young female's postural balance in prolonged standing and sitting job by the balance test examination.

The static and dynamic balance is affected by the property of footwear which includes their materials, stiffness, and soles thickness, collar height and the coefficient of friction of the outer sole of the footwear.<sup>19</sup> Several earlier studies have been studied about relation of balance and The ability of static and dynamic balance due to wearing high heels and causes muscle fatigue.<sup>20</sup> Heterogeneity of footwear in young females and the females in their 20s prefer to wear low heeled casual footwear in spite of any motive or wants..<sup>21</sup> Another study examined that duration of wearing high heels in young adults revealed that the muscles such as rectus femoris and tibialis anterior did not indicate any such significant differences in lower extremities muscle activity and in static balance.<sup>6</sup>

Most of the studies have accomplished the effects of footwear on balance. Thus, the basis of this research was to the examined the effects of footwear in a specifically young aged female's postural balance. For prolonged standing and sitting causes musculoskeletal problems and other related problems like pain in legs, spinal compression, venous insufficiency, swelling.<sup>1,13,14,15,16</sup> People should deliberate in their daily life about the types of shoes and the heel height.<sup>2</sup> The balance tests which have been done in this research studies states that the alteration in balance of females due to footwear is affected. The subjects when performing the tests were more dis-balanced in eyes closed task as compared in eyes open. And if we compare the test between the tandem walk and rhomberg's eyes open and close tests, the subjects having more difficulty in performing the rhomberg's eyes closed test. According to the results,

females have to wear footwear according to their comfort ability and during prolonged hours of jobs in sitting and standing dynamics, they need to relax her foot in every hour in order to keep their foot relaxed and it will prevent from swelling, leg pain and other causes which we have discussed in our research study.

### Limitation of Study:

- Less number of subjects.
- Less number of tests is used to assess balance.
- Heel height.
- Type of heels.
- We do not know that the subjects involve in any sports activities.
- We did not compare the subject's arches whether they are flat foot, pes cavus or normal.

### Future Scope:

- It will help in the prevention, evaluation and treatment of primary and secondary structural damage in foot, and other musculoskeletal conditions.
- We only took the young women but with the inclusion of women of middle and old age, the generalisability will increase and we can have a better result.
- We had only compare the result between females, for further studies use comparative effects in males and females in prolonged working hours.

## Conclusion

In conclusion, this study examined the effects of footwear in young females postural balance in prolonged standing and sitting job. The result showed the significant differences in rhomberg test. The subjects having difficulty during eyes closed test than in eyes open and in tandem walk test showed that the subjects

having difficulty in heel to toe walking because of having trouble in maintaining balance.

In the study the balance tests shows that, wearing footwear for prolonged hours of job, states that the balance and postural control worsening which is associated with decreases in the postural stability and increases in the risk of falls. According to the study, balance is more effected in prolonged sitting than in prolonged standing.

Conflict of Interest: None

**Ethical Clearance:** Institutional ethical committee

**Sources of Funding:** Self

### References

1. Sema Ozandaç Polat, Ahmet Hilmi Yücel “the negative effects of high heels on the biomechanics and somatometry on the lower extrimities.” 2018
2. Mi-Kyoung Kim, Byung-Sun Kong, Kyung-Tae Yoo “The effect of shoe type on static and dynamic balance during treadmill walking in young healthy women”2017
3. Barton CJ, Bonanno D, Menz HB. “Development and evaluation of a tool for the assessment of footwear characteristics”2009.
4. Hijmans JM, Geertzen JH, Dijkstra PU, Postema K. “ A systematic review of the effects of shoes and other ankle or foot appliances on balance in older people and people with peripheral nervous system disorders” 2007
5. Perry SD, Radtke A, Goodwin CR “Influence of footwear midsole material hardness on dynamic balance control during unexpected gait termination”2007
6. Lee MH, Chang JS, Lee SY, et al.: The effects of high-heeled shoes on static balance and EMG activity of lower extremity muscles for young women”2009
7. Peterka RJ. “ Sensorimotor integration in human postural control. Journal of neurophysiology” 2002
8. Yaggie JA, McGregor SJ. “Effects of isokinetic ankle fatigue on the maintenance of balance and postural limits”Arch Phys Med Rehabil, 2002.
9. Kisner C, Colby LA, Borstad J. Therapeutic exercise: foundations and techniques. Fa Davis; 2017
10. Winter DA, Patla AE, Frank JS. Assessment of balance control in humans. Med Prog Technol. 1990
11. Tomei F, Baccolo TP, Tomao E, Palmi S, Rosati MV. “Chronic venous disorders and occupation”1999
12. Jennifer Anderson, Anita E. Williams & Christopher Nester “ An explorative qualitative study to determine the footwear needs of workers in standing environments”2016
13. Nancy L. Hughes, Audrey Nelson, Mary W. Matz, John Lloyd.“ Solutions for prolonged standing in perioperative setting” 2011
14. Canadian Centre for Occupational Health & Safety “Working in a standing position—basic information”2010.
15. Beynon C, Reilly T.“Spinal shrinkage during a seated break and standing break during simulated nursing tasks”2001
16. Cook J, Branch TP, Baranowski TJ, Hutton WC.“The effect of surgical floor mats in prolonged standing: an EMG study of the lumbar paraspinal and anterior tibialis muscles”1993
17. Chantanachai T, Pichaiyongwongdee S, Jalayondeja C Journal of the Medical Association of Thailand=Chotmaiht Thangphaet “Fall prediction in thaielderly with timed up and go and tandem walk test: a cross sectional study” 2014
18. Redfern MS. Cham R.“The influence of flooring on standing comfort and fatigue” 2000.
19. Boyas S, McGown C, Lajoie Y, et al. “Changes in posture associated with postural control impairment induced by ankle plantarflexor fatigue during unipedal quiet standing”2013
20. Kim YJ,Koo JW, Oh DW “Influence of shoe heel height and muscle fatigue on static and dynamic balance in healthy young women”.2013
21. Kim SN: (A) Survey on shoes wearing and a proposal regarding shoes size and shape improvement: focused on women in their teens and twenties. Ewha Womans University Graduate School, Master’s thesis, 2001.

# Prospective Studies on Pattern of Two Wheeler Injuries in Road Traffic Accidents

Arun Prakash K.S.<sup>1</sup>, Sanjeev K.<sup>2</sup>, Gambhir Singh O.<sup>3</sup>

<sup>1</sup>Assistant Professor, <sup>2</sup>Associate Professor, <sup>3</sup>Professor & HOD, Department of Forensic Medicine, SRM Medical College Hospital and Research Centre, Kattankulathur, Chennai-603 203

## Abstract

It is a prospective study of fatal two wheelers accident cases brought at Indira Gandhi Government General Hospital & Post Graduate Institute, Puducherry. Amongst 118 cases, 79.66% were male whereas 20.33% were female. Highest numbers of victims were in the age group of 36-55 years, accounting for 45 (38.13%). There was a higher rate of head and neck injuries in the present study followed by head, neck & lower limb and head, neck & upper limb. Numbers of people who succumb to two wheeler accidents are on an increasing trend in India. Fatality rates among the people involved in RTA shows an alarming increase. It was observed that violating the traffic rules is found to be the major contributory factor and men and teenagers are the most common people involved in these accidents. Measures to prevent these accidents and decrease the mortality rates in these situations includes strict adherence to traffic rules.

**Keywords:** *Two wheelers, Road Traffic Accidents, Drunken Drive, Mechanical injuries.*

## Introduction

Road traffic accidents are the only public health problem for which society and decision makers still accept death and disability among young people on a large scale<sup>1</sup>. India ranks 1st in the number of road accident deaths among 199 countries reported in the World Road Statistics, 2018 followed by China and the US. As per the WHO Global Report on Road Safety 2018, India accounts for almost 11% of the accident-related deaths in the World<sup>2</sup>.

According to the National Crime Records Bureau (2010), the number of vehicular accidents was 430600 resulting in 133938 deaths and 470600 injuries, thereby accounting for 37.2% of all accidental deaths (3). A

study was conducted for five years from 2000 -2004 to draw the pattern between the age, sex of the victim, type of injury, and their association with the road traffic accidents. As per the results a majority of 77% were in the age group from 18-44 years accounted for nearly 69.6 percent of road accident victims, the accident ratio was 83% in male whereas for the female it was 17%. They have also mentioned that 81% of the geared vehicles have been a part of the accidents that occurred (4). Tamil Nadu and Uttar Pradesh accounted for the highest number of road accidents and death in road accidents respectively in 2018, the report revealed (2).

Because, most of the national highways in India are made by tar and the fact is that the national highway is 24 hrs busiest roads with vehicles travelling at high speeds, the roads being less wider multiple intersections and divider cuts are present at every kilometre for changing the side.<sup>3,4,5</sup>.

Though the facts of the motorcycle accidents are obvious no much attention is paid to it. The accidents by a motorbike is 27 times fatal than a car by the source<sup>5</sup>. This does not imply that car accidents are less damaging but the impact and the numbers are greater on the comparison.

---

### Corresponding Author:

**Dr. Arun Ks Prakash MD., LL.B.**

Assistant Professor, Department of Forensic Medicine, SRM Medical College Hospital and Research Centre, Kattankulathur-603 203

Mobile Number: 9842292308

e-mail: drarunksprakash@gmail.com



## Method and Materials

The study is a prospective analysis of cases of fatal two wheelers accident autopsied at Indira Gandhi Government General Hospital & Post Graduate Institute, Puducherry during the period November 2013 through April 2015 after obtaining ethical clearance. Out of the total 159 cases of RTA we have chosen 118 cases where two wheelers were involved. External and internal postpartum findings were observed and recorded in the performa. History about the accident, the time, day, month, type of road, type of vehicle, were obtained from investigating officer and relatives of the deceased and were recorded in the Performa. The cases with incomplete details were not taken into consideration.

The data were analyzed with SPSS-20 software and the results were interpreted in terms of percentage, mean, chi-square, and z-test. Then we compared our findings with the works of other authors.

**Observation:** There were 118 fatal two wheelers accident cases out of the total 159 fatal road traffic accident dead cases. Age-wise, Sex-wise and other findings are displayed in Table No.1. Amongst 118 patients, 79.66% were male whereas 20.33% were female. Highest numbers of victims were in the age group of 36-55 years, accounting for 45 (38.13%) patients. On applying, Chi-square test, it is shown that the age group 36-55 years and above 55 years is statistically significant. Male are more vulnerable to two wheeler accidents than female. 98.30% of the patients got accident in Tar road than cement & Mud road.

**Table No. 1: Age-Sex-Type of Road Involved**

Age Group (Years)	Total	Sex		Type of Road		
		Male	Female	Tar Road	Cement Road	Mud Road
1-18 Years	4(3.38%)	4(3.38%)	0	3(2.54%)	1(0.84%)	0
19-35 Years	31(26.27%)	25(21.18%)	6(5.08%)	30(25.42%)	0	1(0.84%)
36-55 years	45(38.13%)*	35(29.66%)	10(8.47%)	45(38.13%)	0	0
Above 55 years	38(32.20%)*	30(25.42%)	8(6.77%)	38(32.20%)	0	0
<b>Total</b>	<b>118(100%)</b>	<b>94(79.66%)</b>	<b>24(20.33%)</b>	<b>116(98.30%)</b>	<b>1(0.84%)</b>	<b>1(0.84%)</b>

\*Indicates P<0.01, that is significant

Table No. 2 shows distribution of cases according to manner of accident. In 36 cases, (30.50%) it was due to hitting against the pedestrian. In 25 cases, (21.23%) death were by collision with heavy passenger vehicle.

**Table No. 2: Distribution of Cases According to Manner of Collision**

History of Accident	Frequency	Percentage
2 wheeler hitting against the fixed object	12	10.16%
Fall from 2 wheeler	20	16.94%
2 wheeler hitting against the pedestrian	36	30.50%
2 wheeler vs 2 wheeler	9	7.62%
2 wheeler vs Heavy passenger vehicle	14	11.86%
2 wheeler vs Bicycle	4	3.38%
2 wheeler vs Heavy vehicle	11	9.32%
2 wheeler vs 4 wheeler	12	10.16%
<b>Total</b>	<b>118</b>	<b>100%</b>

Analysis of various injuries in the body of the victims revealed that the maximum number of patients got injured in the head & neck region (25.42%) shown in Table No.3. Head & Neck and upper limb (9.32%), head & Neck and lower limb (11.01%), Head & neck and thorax (7.62%), head & Neck and upper limb (8.47%), Head & neck, abdomen and upper limb (8.47%), head &

neck, abdomen and lower limb (10.16%), head & neck, thorax, pelvis and lower limb (6.77%), Head & Neck, Abdomen, Groin, Spine and Back (9.32%) and Head & Neck, Abdomen, Groin, Spine, Lower limb and Back (11.86%) were more predominantly injured area in the accident.

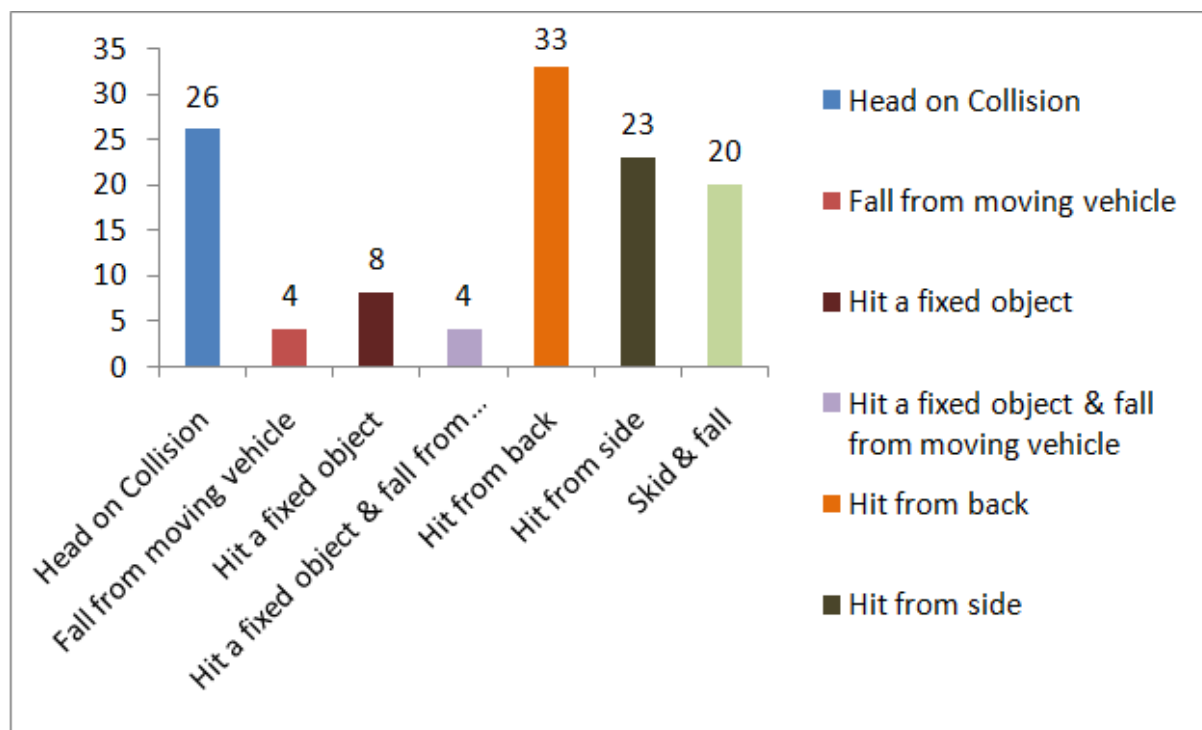


Figure 1: Bar Chart shows the distribution of type of accidents

Table No. 3: Distribution of Injured Body Surface

Site of Injury	Frequency	Percentage
Head & Neck	30	25.42%
Head & Neck and Upper limb	11	9.32%
Head & Neck and Lower limb	13	11.01%
Head & Neck and Thorax	9	7.62%
Head & Neck, Abdomen and Upper limb	10	8.47%
Head & Neck, Abdomen and Lower limb	12	10.16%
Head & Neck, Thorax, Pelvis and Lower limb	8	6.77%
Head & Neck, Abdomen, Groin, Spine and Back	11	9.32%
Head & Neck, Abdomen, Groin, Spine, Lower limb and Back	14	11.86%
<b>Total</b>	<b>118</b>	<b>100%</b>

Most common injuries observed were abrasion, laceration, sutured wound and contusion observed in all 118 cases. In that combination of abrasion & laceration (26.27%) is the most common type of injuries observed

in the patients and followed by Abrasion, Abrasion & Sutured wound, Abrasion, Laceration, Sutured wound & Contusion were 19.49%, 16.94%, 14.40% respectively shown in Table No. 4.

**Table No. 4: Cases Distribution According to Injury Type**

Type of Injury	Frequency	Percentage
Contusion	6	5.08%
Abrasion	23	19.49%
Laceration	14	11.86%
Abrasion & Contusion	7	5.93%
Abrasion & Laceration	31	26.27%
Abrasion & Sutured wound	20	16.94%
Abrasion, Laceration, Sutured wound & Contusion	17	14.40%
<b>Total</b>	<b>118</b>	<b>100%</b>

As shown in figure 2, the injuries were commonly seen on the the face & lower limb 27(22.88%), followed by cerebral Lobes (21.18%), lobes, upper limb, lower limb & face (16.94%), cerebral lobes & lower limb (16.10%), upper limb & lower limb (16.10%). The less common area are lobes & upper limb (6.77%).

**Discussion**

Road traffic accidents are more common in a developing country like India. In this study, the majority of motor cyclist and pillion riders were adults and in their most productive ages and showed a male preponderance. Present study is in consistent with the works of other authors<sup>1,2,3,4</sup>.

The results of the present study revealed that 94 (79.66%) of the patients were males and the rest 24 (20.33%) were females. The highest number of patients 45 (38.13%) were from 36-55 years of age group. Among males, the maximum number of cases were seen in the age group of 36-55 years 35 (29.66%) and above 55 years 30(25.42%). The mean age of the RTA victim came out to be 30.12yrs. However, other studies observed that mean age of the male victimized in road traffic accidents is 33 years.<sup>6-11</sup>.

Due to high activity levels, participation in high-risk activities, reckless driving/riding, over-speeding and drunken driving, driving without wearing helmet etc are main reason for high incidence rate among males. Similar observations were also reported by different authors<sup>6-9</sup>. On the other hand females due to social & cultural practice are less expose to road traffic accidents. Moreover, extra precautions taken by family members to keep them safe women have lesser possible to encounter road traffic accidents than male partners. Majority

of these accidents occurred on the paved roads 116 (98.30%).

There was a higher rate of head and neck injuries in the present study followed by head, neck & lower limb and head, neck & upper limb. A possible explanation might be that two wheeler inhabitants did not use seat belts, resulting in forward jerk during a collision and higher rate of injury. Abrasions, lacerations, sutured wound and contusion were the commonest types of injuries among the external injuries noted in this study. Similar results were also observed by others researchers<sup>12-16</sup>. Common sites for injuries were the lower and upper limbs and face<sup>6,7</sup>.

Face & lower limb injury is more frequent in motor vehicle occupant 27(22.88%) followed by Lobes (21.18%), lobes, upper limb, lower limb & face (16.94%), lobes & lower limb (16.10%), upper limb & lower limb (16.10%). The less common area are lobes & upper limb (6.77%). It therefore, appears that motor vehicle occupant and motor cyclist were more vulnerable to the different type of injuries than other categories of the victims possibly due to a greater force of impact in the former and a longer distance of the fall in the latter<sup>16,17</sup> whereas the study conducted by Clark DW reported that more number of fractures appeared in the area of upper limbs, lower limbs and facial bones<sup>18</sup>. In line with our study Wong TW showed that commonest injury was fracture of bones particularly of the head and face and closely followed by the lower extremity<sup>18,19</sup>.

**Conclusion**

The study highlights the pattern of injuries among the motor cyclists. By analyzing the various data that were published on RTAs and their major contributing factors, accidents are happening usually due to irresponsibility of the drivers. Hence, we recommend strict enforcement of the traffic rules and safety law for the motor cyclist like wearing the helmet, maintaining the speed limit etc. Moreover, advancement in technology of the wheelers has brought great advantages to the human but on the other hand the mishandling of these two-wheelers can even cause fatal death or injury. India has recorded the maximum number of deaths in two-wheeler accidents with a greater ratio of men being affected than the women because of not following the traffic laws Understanding the speed limit and obeying traffic laws could reduce the number of people affected by the accidents. It is high time that the policy makers should take a look at these

types of studies and do concerned modifications in the years to come.

**Ethical Clearance** is taken from Departmental Research Committee to Amity Law School, Amity University, Noida, U.P.

**Source of Funding:** Self

**Conflict of Interest:** Nil

### References

- Mohan D. Road traffic injuries-a neglected pandemic. *Bulletin World Health Organisation* 2003; 81(9):684-5
- The Economic Times. Road Accidents Claimed over 1.5 lakhs in 2018. 2018
- National Crime Record Bureau. Annual Report on Road Accidents. 2010
- Jain A, Manazes RG, Kanchan T, Gagan S. Two wheeler accidents on Indian roads – a study from Mangalore. *J Forensic and Legal Medicine*. 2009; 16(3): 130-3.
- Dolman Law Group. Five facts you should know about motor cycle accidents. 2018
- Mehta SP. An epidemiological study of road traffic accident cases admitted in Safdarjang Hospital, New Delhi. *Indian J Med Res*. 1968;56:456–66.
- Sathiyasekaran BW. Study of the injured and the pattern in road traffic accidents. *Indian J Forensic Sci*. 1991;5:63–8.
- Ghosh PK. Epidemiological study of the victims of vehicular accidents in Delhi. *J Indian Med Assoc*. 1992;90:309–12.
- Varghese M, Mohan D. New Delhi: Proceedings of the International Conference on Traffic Safety; 1991. Jan 27-30, Transportation injuries in rural Haryana, North India 1991.
- Clark DW, Morton JH. The motorcycle accident: A growing problem. *J Trauma*. 1971;11:230–7.
- Akang EE, Kuti MA, Osunkoya AO, Komolafe EO, Malomo AO, Shokunbi MT, et al. Pattern of fatal head injuries in Ibadan - A 10 year review. *Med Sci Law*. 2002;42:160–6.
- Kual A, Sinha US, Pathak YK, Singh A, Kapoor AK, Sharma S, et al. Fatal road traffic accidents, study of distribution, nature and type of injury. *J Indian Acad Forensic Med*. 2005;27:71–6.
- Dhillon S, Kapila P, Sekhon HS. Pattern of injuries in road traffic accidents in Shimla hills. *J Punjab Acad Forensic Med Toxicol*. 2007;7:50–3.
- Kumar PM, Ziya A, Prashant A, Yadav S, Chaturvedi R, Tripathi SK. Fatality due to chest injury in Road traffic accident victims of Varanasi and adjoining districts, U.P. *Medico-Legal Update*. 2006;6:7–9.
- Singh H, Dhatarwal SK. Pattern and distribution of injuries in fatal road traffic accidents in Rohtak (Haryana) *J Indian Acad Forensic Med*. 2004;26:20–3.
- Sharma BR, Harish D, Singh G, Vijay K. Patterns a Head Injury in Road Traffic Accidents, Bahrain *Medical Bulletin* 2003;25(1):22-25. 12.
- Kumar S, Suresh B, Kanchan T, Ritesh G, Shankar M, Bakkannavar, Vinod C, Nayak K, Yoganarasimha. Victim Profile and Pattern of Thoraco-Abdominal Injuries Sustained in Fatal Road Traffic Accident. *JIAFM* 2012; 34(1):16-19
- Clark DW, Morton JH. The motorcycle accident: A growing problem. *J Trauma*. 1971;11:230–7
- Wong TW, Phoon WO, Lee J, Yiu PC, Fung KP, Smith G, et al. Non-fatal injuries among motorcyclists treated as in-patients in a general hospital. *Ann Acad Med Singapore*. 1989; 18:672-4.

# A Review of Studies Assessing Cannabidiol's (CBD) Therapeutic Action and Potentials in Respiratory Diseases

Arwa Fairaq<sup>1</sup>, Sahar El-Ashmony<sup>1,2</sup>, Yosra AL-Hindi<sup>1</sup>

<sup>1</sup>Assistant Professor in Clinical Pharmacy, Faculty of Pharmacy, University of Umm Al-Qura, Makkah, KSA,

<sup>2</sup>Faculty of Medicine, Medical Pharmacology Department, Cairo University, Cairo, Egypt

## Abstract

Cannabidiol (CBD) is the major non-mind-altering section of the hairy glands of hemp plant that can be named 'cannabinoids' (CBs). Cannabinoid in the pharmacology field is becoming an extensive subject specifically towards the therapeutic characteristics of cannabinoid receptor agonists. Examples such as analgesia, muscle relaxation, immunosuppressive, antiinflammatory and anti-allergic effects, mood improvement, appetite stimulation, antiemesis, lowering of intraocular pressure, bronchodilatation, neuroprotection, and anti-neoplastic effects. Although this vast knowledge about the therapeutic properties of CBs, their clinical uses remains a controversy and very limited. However, the focus now has been on CBD that constitutes up to 40% of the extract of the Cannabis and represents one of the most attractive prospects for therapeutic use owing to its extraordinary lack of both perceptual and psychoactive behavior. Finally, CBD is regarded as an important putative lead compound to produce cannabinomimetic drugs because of its excellent tolerability in humans.

**Keywords:** CBD, Respiratory, pharmacology, review.

## Introduction

**Cannabidiol:** The terms *cannabis* and *marijuana* are frequently used interchangeably, but Cannabis is a generic term that includes cannabinoids, marijuana, and hemp-derived from the plant *Cannabis sativa*. The documented use of cannabis dates to several centuries BC<sup>1</sup>. The cannabis plant and its derivatives have been exploited for centuries for recreational and medicinal purposes, with millions of regular users around the world. Legislation around these purposes is increasingly considered by local, regional, and national governments<sup>1</sup>. Non-psychotropic Phyto-cannabinoid CBD is considered

one of the most interesting emerging molecules in the field of pharmacology since it exerts a wide range of therapeutic effects, ranging from anticonvulsive, sedative, hypnotic, antipsychotic, anti-cancer, anti-inflammatory and neuroprotective activities<sup>2</sup>.

More than 100 different cannabinoids have been identified, but delta-9-tetrahydrocannabinol (THC) is the most responsible for the psychoactive effects of euphoria and relaxation. Cannabinoid 1 (CB1) receptors in the brain correlate with the psychoactive effects<sup>3</sup>. CBD is suggested to have therapeutic potential in many disorders, including inflammation, oxidative stress, cancer, diabetes, gastrointestinal disturbances, neurodegenerative disorders, and nociception<sup>4,5</sup>. Evidence is also now accumulating that there are beneficial effects of CBD in the vasculature. A review of the safety and side effects of CBD concluded that CBD appears to be well tolerated at high doses and with chronic use in humans, and thus has the potential to be taken safely into the clinic. Indeed, CBD is one of the active ingredients of the currently licensed medication, Sativex®<sup>6</sup>.

---

### Corresponding Author:

**Dr. Yosra Alhindi**

Assistant Professor in Clinical Pharmacy Department,  
Umm Alqura University, Makkah, Saudi Arabia

Mobile No.: 00966504530609

e-mail: yzhindi@uqu.edu.sa

**CBD in some respiratory diseases:**

**Asthma and COPD:** Asthma is a chronic inflammatory disorder of the airways with an increase in the bronchial hyperresponsiveness to different stimuli. Characterized by wheezing, breathlessness, chest tightness, cough, and reversible airflow obstruction<sup>7</sup>. Chronic obstructive pulmonary disease (COPD) is another respiratory disease that can be overlapped with asthma. COPD characterized by chronic airflow limitation, usually caused by significant exposure to noxious particles<sup>7</sup>. COPD, including Chronic Bronchitis and Emphysema, are Cause of death rank 4 with an expectation to increase in coming decades due to continued exposure to different COPD risk factors such as smoking, aging, and inactivity<sup>8</sup>. Treatments include bronchodilators, antimuscarinic agents, corticosteroids, and antiinflammatory medications are available. However, there is no cure for Asthma or COPD until now<sup>9</sup>.

In the last decays, Cannabis, with its different content including Cannabidiol (CBD), draws attention as some studies show its variable pharmacological properties, including anti-inflammatory<sup>10</sup> immunomodulatory, and analgesic properties. Mechanistically via activation of cannabinoid-1 and -2 (CB1 and CB2) receptors presented predominantly in the central nervous system (CNS) and immune cells, respectively<sup>10</sup>. In immune cells, cannabinoids dysregulate cytokine leading to disruption of the immune system through<sup>11</sup>. Most studies explored the properties of Cannabis, but we're not focusing specifically on CBD. Therefore, further studies were conducted to explore the specific effect of CBD in lung disease. Studying genes related to respiratory disease COPD, Cannabis affected the expression of pro-inflammatory genes in human small airway epithelial cells (HSAEpC), *in vitro*<sup>12</sup>.

*In vivo*, CBD (20 mg/kg) administration in lipopolysaccharide (LPS) induced lung injury murine and mice model decreased the migration of leukocyte into the lungs, albumin concentration in the bronchoalveolar lavage fluid, as well as production of pro-inflammatory cytokines (TNF and IL-6) and chemokines (MCP-1 and MIP-2) via adenosine A<sub>2A</sub> receptor<sup>13</sup>. In an asthmatic rat model, CBD at the dose of 5mg/kg intraperitoneally (i.p) once daily significantly decreased inflammatory response by decreasing the level of both Th1 including TNF- $\alpha$  and IL-6 as well as Th2 cytokines including IL-3, IL-4, IL-5, IL-13 and IL-10<sup>13</sup>. Furthermore, CBD

treatment improved remodeling processes and reduced airway inflammation and fibrosis. Specifically, CBD decreased the collagen fiber content (CBD 5 or 10 mg/kg i.p.) and lung elastance (CBD 10 mg/kg i.p.) through CB1/CB2 signaling<sup>14</sup>. In addition, CBD improves pulmonary function as its administration associated with an increase in tidal volume, inspiratory flow rate, and respiration rate in the African Green Monkey model with induced pulmonary fibrosis<sup>15</sup>.

**The potential therapeutic effects of CBD in lung cancer:** The searching to ameliorate the prognosis of lung cancer has led to the development and evaluation of new drugs with mechanisms of action that vary from those of conventional chemotherapeutics used for many years worldwide. A major attempt is now being placed in developing and assessing the potential of targeted therapies and immunotherapy in lung cancer that cause improvement in the clinical outcomes<sup>16</sup>. Thus, targeted therapy is replacing conventional chemotherapy as a standard treatment for patients with targetable oncogenic drivers<sup>16</sup>. However, it has to be recognized that responses to these agents are still partial, with tumors recurring during follow-up. In fact, due to tumors' genetic heterogeneity, a complete response in lung cancer patients is very difficult to attain<sup>17</sup>. The challenge to proceed with the outcome of patients with lung cancer is leading to the assessment of alternative drugs, which, alone or in combination, may lead to improved response and survival in patients. CBD is one possible example as it could be a potential drug in the treatment of cancer. CBD has been shown to have anti-neoplastic effects *in vitro* and/or *in vivo* in lung cancer and other types of cancer<sup>17,18</sup>. Newly, the therapeutic potential of the cannabis plant in the area of cancer treatment has been discovered, and the use of Cannabis by cancer patients has increased significantly<sup>19</sup>. The beneficial effects of Cannabis are related to symptoms of the disease: pain, nausea and vomiting, loss of appetite, weight loss, mood swings, and sleep disorders<sup>19</sup>. Also, Cannabis was found to have immunomodulatory properties. Researches assaying the effects of cannabinoid-based drugs on immunity have shown that various cellular and cytokine mechanisms are suppressed by these agents, mainly by four mechanisms: induction of apoptosis (of T cells, macrophages, splenocytes, and thymocytes), inhibition of cell proliferation, inhibition of production of chemokines and cytokines, and induction of T-regs<sup>19</sup>. Possible clinical use of cannabinoids for the treatment of extremely invasive cancer types is highly supported

by studies proving a decrease of tumor cell invasion by them<sup>19</sup>. Moreover, the lack of severe adverse effects of cannabinoids as compared to the generalized toxicity of conventional chemotherapies. Furthermore, several major side effects of chemotherapeutics, such as emesis and inherent toxicity on noncancerous tissues, have been demonstrated to be even reduced on treatment with cannabinoids<sup>17</sup>. Within cannabinoid-based substances, the Phytocannabinoid CBD has protruded as a particularly interesting drug due to its lack of adverse psychoactive effects, as well as its considerable antitumorogenic properties<sup>17,18,19</sup>.

It is postulated that CBD could act on tumor cells, directly or indirectly, through different pathways that may vary in different tumor cells. CBD is an inverse agonist for the CB2 receptor and an antagonist for the CB1 receptor<sup>18, 19</sup>. In addition, CBD has anti-cancer effects acting as an agonist for the transient receptor potential vanilloid (TRPV) 1 and 2, leading to changes in intracellular Ca<sup>2+</sup> levels<sup>19</sup>. It is also reported that CBD can induce apoptosis in cancer cells via the production of reactive oxygen species (ROS), caspase activation and activation of p53 dependent apoptotic pathways in cancer cells and down-regulation of mammalian target of rapamycin (mTOR) and cyclin D1<sup>19</sup>. CBD can also upregulate TNF/TNFR1 and TRAIL/TRAIL-R2 signaling by modulation of both ligand and receptor levels, followed by apoptosis. Furthermore, CBD inhibits human umbilical vein endothelial cells (HUVEC) migration, invasion and sprouting in vitro, and angiogenesis in vivo through down-modulation of several angiogenesis-related molecules. From the immunological point of view, CBD significantly inhibits the recruitment of tumor-associated macrophages (TAM) in primary tumor stroma and secondary lung metastases. CBD promotes the susceptibility of cancer cells to adhere to and subsequently be lysed by Lymphokine Activated Killer (LAK) cells, with both effects being reversed by a neutralizing ICAM-1 antibody<sup>19</sup>.

A study used different human lung cancer cell lines, primary tumor cells, and an in vivo intravenous metastasis model, to analyze the contribution of ICAM-1 to the anti-invasive action of CBD. This has been previously described to be mediated via cannabinoid receptor-, TRPV1-, and MAPK-dependent up-regulation of TIMP-1 in human cervical and lung cancer cells. Accumulating evidence highly supported the role of ICAM-1 as a functional link between cannabinoid receptor- and TRPV1-elicited p42/44 MAPK activation

and downstream TIMP-1-dependent inhibition of invasion. First, antagonists to CB1 and CB2, as well as an antagonist to TRPV1, were shown to inhibit CBD induced ICAM-1 expression, which is in line with CBD's established cannabinoid- and TRPV1-dependent up-regulation of TIMP-1 expression and subsequent anti-invasive action. Second, CBD induced ICAM-1 expression was found to occur via a receptor-dependent activation of p42/44 MAPK—a pathway likewise shared by the published TIMP-1-dependent anti-invasive action by this cannabinoid. Third, in all cell lines, as well as primary tumor cells from a brain metastasis of a patient with non-small cell lung cancer (NSCLC), CBD elicited a sequential up-regulation of both anti-invasive mediators, ICAM-1 and TIMP-1<sup>19</sup>.

### **Cannabidiol as a potential antiinflammatory treatment in SARS-CoV-2 infection**

SARS-CoV-2 is a novel beta coronavirus first reported in China with a 14-day incubation period<sup>20</sup>. In a proportion of individuals, critical illness develops and is characterized by respiratory failure, shock, and multi-organ dysfunction<sup>20</sup>. Mortality ratings alter based on the study population examined, with the death rate among persons requiring mechanical ventilation as high as 88%<sup>20</sup>. SARS-CoV-2 infects types I and II pneumocytes via its receptor angiotensin-converting enzyme (ACE)2, which is also them a in receptor for SARS-CoV-2<sup>20</sup>. Under healthy circumstances, bronchoalveolar lavage fluid is made up of predominantly alveolar macrophages (<80%) and lymphocytes (~10–20%). Alveolar macrophages control the lungs for pathogens, clear senescent cells, share in reparation of -damaged tissue, and enhance T-cell specific responses<sup>20</sup>. Importantly, SARS-CoV-2 infection causes hyper-activation of lung macrophages as well as marked infiltration of pro-inflammatory monocyte-derived macrophages (MDMs) into small airways. Acute macrophage stimulation initiates a massive pro-inflammatory response, including IL-6 and IL-1 $\beta$ , which enhance the recruitment of neutrophils and cytotoxic CD8T-cells into the lung's mucosal tissues<sup>21</sup>.

Cannabinoids can suppress immune activation and inflammatory cytokine production, suggesting their potential for alleviating excessive inflammation. Endocannabinoid receptors include CB1 and CB2. CB1 has higher expression in the central nervous system and a lesser expression on peripheral tissues, including the lungs<sup>22</sup>. CB2 is expressed by lungs as well as varieties

of immune cells, including circulating lymphocytes, monocytes, and tissue mast cells and in lymphoid tissues. Activation of the CB2 receptor can inhibit the release of inflammatory IL-1, IL-6, IL-12, and TNF- $\alpha$ . Constitutive production of endocannabinoids occurs by human lung resident macrophages, which is protective in acute and chronic inflammation, mostly via CB2 receptors<sup>21</sup>. Agonists of CB2 have been shown to inhibit TNF- $\alpha$  from CD14+ monocytes and M1 macrophages and increase expression of antiinflammatory cytokine IL-10. CB2 agonists also induce antiinflammatory FoxP3+ regulatory T-cells (Tregs), which produce TGF- $\beta$  and IL-10. In addition, CBD has been shown to induce the differentiation of functional immunosuppressive Tregs<sup>22</sup>.

In humans, CBD has been tested across a wide dosage range, varying from <1 up to 50 mg pro kg/die depending on the trials and on the explored pathological condition, with both in vitro and in vivo studies suggesting an immunosuppressive action at higher concentrations or doses<sup>22</sup>. CBD should be given orally starting at 100 mg/day titrating up to 300 mg/day (2.5 mg/kg/die) since this dosage did not produce relevant adverse effects even for prolonged administrations (up to 18 weeks) in clinical trials in humans. CBD acts as an in vitro inhibitor of several CYP450 isoforms. Since drug-drug interaction studies between CBD and anti-COVID-19 treatments are lacking; therefore, monitoring of patients for potential drug interactions would be required<sup>22</sup>. It is concluded that SARS-CoV2 causes severe damage through the cytokine storm that causes inflammation by macrophages and other immune cells. Since the CBD has broad antiinflammatory properties, it may represent a potential antiinflammatory therapeutic approach against SARS-CoV2, and it is indeed a therapeutic agent used in clinical medicine and has a favorable safety profile.

### Conclusion

Cannabidiol elucidates an impressive plethora of actions, specifically as an anti-inflammatory agent. Many of which could have medicinal significance as well as the lead in the production of pharmaceuticals. CBD is a compound well tolerated in humans with a very low toxicity profile and devoid of psychoactive and cognitive effects. However, more clinical trials are needed to be able to validate its beneficial properties as the possible results that can be discovered by these trials can give a lot of progress from the present preclinical evidence to a practical therapeutic application.

**Conflict of Interest:** None

**Ethical Clearance:** Taken from IRB committee of umm Alqura university, Makkah, KSA.

**Source of Support:** Nill

### References

1. Long T, Wagner M, Demske D, Leipe C, Tarasov PE. Cannabis in Eurasia: origin of human use and Bronze Age trans-continental connections. *Vegetation History and Archaeobotany*. 2017 Mar;26(2):245-58..
2. Machado Bergamaschi M, Helena Costa Queiroz R, Waldo Zuardi A, Crippa AS. Safety and side effects of cannabidiol, a Cannabis sativa constituent. *Current drug safety*. 2011 Sep 1;6(4):237-49.
3. Jett J, Stone E, Warren G, Cummings KM. Cannabis use, lung cancer, and related issues. *Journal of Thoracic Oncology*. 2018 Apr 1;13(4):480-7.
4. Ladin DA, Soliman E, Griffin L, Van Dross R. Preclinical and clinical assessment of cannabinoids as anti-cancer agents. *Frontiers in pharmacology*. 2016 Oct 7;7:361.
5. Pertwee RG. The diverse CB1 and CB2 receptor pharmacology of three plant cannabinoids:  $\Delta$ 9-tetrahydrocannabinol, cannabidiol and  $\Delta$ 9-tetrahydrocannabivarin. *British journal of pharmacology*. 2008 Jan;153(2):199-215.
6. Esposito G, Scuderi C, Valenza M, Togna GI, Latina V, De Filippis D, Cipriano M, Carratù MR, Iuvone T, Steardo L. Cannabidiol reduces A $\beta$ -induced neuroinflammation and promotes hippocampal neurogenesis through PPAR $\gamma$  involvement. *PLoS one*. 2011 Dec 5;6(12):e28668..
7. Tat TS, Cilli A. Evaluation of long-term safety and efficacy of omalizumab in elderly patients with uncontrolled allergic asthma. *Annals of Allergy, Asthma & Immunology*. 2016 Nov 1;117(5):546-9.
8. Zeind CS, Carvalho MG, editors. *Applied Therapeutics: The Clinical Use of Drugs*. Wolters Kluwer; 2018.
9. Singh D, Agusti A, Anzueto A, Barnes PJ, Bourbeau J, Celli BR, Criner GJ, Frith P, Halpin DM, Han M, Varela MV. Global strategy for the diagnosis, management, and prevention of chronic obstructive lung disease: the GOLD science committee report 2019. *European Respiratory Journal*. 2019 May 1;53(5).



10. Centers for Disease Control and Prevention. Leading Causes of Death. <https://www.cdc.gov/nchs/fastats/leading-causes-of-death.htm>. (Accessed on July 05, 2020).
11. Mathers CD, Loncar D. Projections of global mortality and burden of disease from 2002 to 2030. *PLoS medicine*. 2006 Nov 28;3(11):e442.
12. Król A, Palmér R, Rondeau V, Rennard S, Eriksson UG, Jauhiainen A. Improving the evaluation of COPD exacerbation treatment effects by accounting for early treatment discontinuations: a post-hoc analysis of randomized clinical trials. *Respiratory research*. 2020 Dec;21(1):1-1.
13. de Freitas Cuba L, Salum FG, Guimarães FS, Cherubini K, Borghetti RL, de Figueiredo MA. Cannabidiol on 5-FU-induced oral mucositis in mice. *Oral Diseases*. 2020 May 13.
14. Barrington-Trimis JL, Cho J, Ewusi-Boisvert E, Hasin D, Unger JB, Miech RA, Leventhal AM. Risk of persistence and progression of use of 5 cannabis products after experimentation among adolescents. *JAMA network open*. 2020 Jan 3;3(1):e1919792.
15. Martínez V, Iriondo De-Hond A, Borrelli F, Capasso R, del Castillo MD, Abalo R. Cannabidiol and Other Non-Psychoactive Cannabinoids for Prevention and Treatment of Gastrointestinal Disorders: Useful Nutraceuticals?. *International Journal of Molecular Sciences*. 2020 Jan;21(9):3067.
16. Almogi-Hazan O, Or R. Cannabis, the Endocannabinoid System and Immunity—the Journey from the Bedside to the Bench and Back. *International Journal of Molecular Sciences*. 2020 Jan;21(12):4448.
17. Klein TW. Cannabinoid-based drugs as anti-inflammatory therapeutics. *Nature Reviews Immunology*. 2005 May;5(5):400-11.
18. Pacher P, Bátkai S, Kunos G. The endocannabinoid system as an emerging target of pharmacotherapy. *Pharmacological reviews*. 2006 Sep 1;58(3):389-462.
19. Nagarkatti P, Pandey R, Rieder SA, Hegde VL, Nagarkatti M. Cannabinoids as novel anti-inflammatory drugs. *Future medicinal chemistry*. 2009 Oct;1(7):1333-49.
20. Klein TW, Newton CA, Nakachi N, Friedman H.  $\Delta^9$ -tetrahydrocannabinol treatment suppresses immunity and early IFN- $\gamma$ , IL-12, and IL-12 receptor  $\beta$ 2 responses to *Legionella pneumophila* infection. *The Journal of Immunology*. 2000 Jun 15;164(12):6461-6.
21. Lynn RS, Galinkin JL. Cannabis, e-cigarettes and anesthesia. *Current Opinion in Anesthesiology*. 2020 Jun 1;33(3):318-26.
22. Richardson S, Hirsch JS, Narasimhan M, Crawford JM, McGinn T, Davidson KW, Barnaby DP, Becker LB, Chelico JD, Cohen SL, Cookingham J. Presenting characteristics, comorbidities, and outcomes among 5700 patients hospitalized with COVID-19 in the New York City area. *Jama*. 2020 Apr 22.

# Evaluation the Door-to-Balloon Time in Patient with ST-Elevation Myocardial Infraction (STEMI) in King Abdullah Medical City (KAMC) in Makkah Almukarramah: A Retrospective Single Center Study

Arwa Fairaq<sup>1</sup>, Dunia Alfi<sup>2</sup>, Halah Bahakeem<sup>2</sup>, Seham Malki<sup>3</sup>,  
Raheeq Algarrash<sup>3</sup>, Shroug Allehyani<sup>2</sup>, Yosra Al-Hindi<sup>1</sup>

<sup>1</sup>Assistant Professor; <sup>2</sup>Pharm. D Graduate, <sup>3</sup>B. Pharm Graduate, Department of Clinical Pharmacy, Faculty of Pharmacy, University of Umm Al-Qura, Makkah, Saudi Arabia

## Abstract

**Background:** ST-Elevation Myocardial Infarction is a time-sensitive emergency condition. Thus, guidelines recommended 90 minutes or less for door-to-balloon time at a percutaneous coronary intervention-capable hospital and within 120 minutes or less if transferred from percutaneous coronary intervention-uncapable hospital. The main objective was to evaluate the recommended time needed for reperfusion therapy particularly percutaneous coronary intervention in patients with ST-Elevation Myocardial Infarction at King Abdullah Medical City.

**Method and Results:** A retrospective single center study. Data were obtained from 47 patients records diagnosed with ST-Elevation Myocardial Infarction and treated with percutaneous coronary intervention at King Abdullah Medical City from Jan 2018 through March 2019. About 36.4% of patients received percutaneous coronary intervention in more than 90 minutes even though they arrived directly at King Abdullah Medical City. For patients who were transferred to King Abdullah Medical City, 63.9% of those patients did not achieve the recommended door-to-balloon time.

**Conclusion:** High percentage of patients with ST-Elevation Myocardial Infarction at King Abdullah Medical City did not receive percutaneous coronary intervention within the recommended timeline.

**Keywords:** *Ischemic heart disease, ST-Elevation Myocardial Infarction, percutaneous coronary intervention, Door-to balloon time, door-to-needle time.*

## Introduction

Ischemic heart disease (IHD) is the number one cause of death worldwide.<sup>(1)</sup> During the last 15 years, IHD remained one of the leading causes of death. Myocardial

Infarction is a type of IHD, and ST-Elevation Myocardial Infarction (STEMI) incorporate about 25% to 40% of Myocardial Infarction cases, leading to approximately 5% to 6% in hospital mortality.<sup>(2-6)</sup> STEMI is a life threatening condition that must be diagnosed and treated immediately via coronary reperfusion.<sup>(7)</sup> Recent guidelines recommend urgent reperfusion with primary percutaneous coronary intervention (PCI) or full-dose fibrinolytic therapy for patients with acute STEMI.<sup>(8)</sup> Among these patients, a significant improvement in the short-term and long-term cardiovascular outcomes such as the mortality and morbidity have been marked due to the quality care guidelines with the emphasis on the time to reperfusion that initiatives by the American

---

### Corresponding Author:

#### Dr. Arwa Fairaq

Assistant Professor, Department of Clinical Pharmacy,  
Faculty of Pharmacy, University of Umm Al-Qura,  
Makkah, Saudi Arabia  
e-mail: amfairaq@uqu.edu.sa

Heart Association and other organizations.<sup>(9)</sup> The early reperfusion can reduce mortality and morbidity inpatient with STEMI.<sup>(7)</sup> Particularly every 10-min delay in STEMI treatment cause additional 3.3% deaths in PCI patients.<sup>(10)</sup> Furthermore, primary PCI improve the outcomes and lowering the recurrent of myocardial infarction and stroke compared with fibrinolytic therapy.<sup>(11)</sup> Two definitions have been used to measure the time to reperfusion; Door-to-balloon time which describes the time from hospital arrival to the time of balloon intervention or using a stent. Likewise, door-to-needle time measures the time from hospital arrival to reperfusion with fibrinolytic administration.<sup>(12)</sup> The American Heart Association/American College of Cardiology (AHA/ACC) 2013 guidelines recommended 90 minutes or less for door-to-balloon time at a PCI-capable hospital for patients with STEMI and within 120 minutes or less if the first arrival was to non-PCI-capable hospital. On the other hand, if fibrinolytic therapy is chosen, the recommended door-to-needle time should be within 30 minutes from hospital arrival.<sup>(8)</sup>

Previously, some studies investigated the possible reasons of delaying in reperfusion times. Focusing on the arrival time, it has been reported that patients arrived during off-hour e.g. weekend, night and holidays had longer door-to-balloon time compared to patients arrived on regular working hours with an increase in mortality.<sup>(13,14)</sup> Another factor that could delay reperfusion times is gender. Women with STEMI had longer time to receive reperfusion therapy and higher mortality rates than men.<sup>(15)</sup> It has been reported that cultural factors can affect the delay in reperfusion therapy in women such as an ability of some women to travel to hospital without male relative.<sup>(16,17)</sup> Comorbidities factors such as diabetic or hypertension can be associated with delay in door-to-needle time.<sup>(18)</sup>

In Saudi Arabia, limited studies have been conducted to investigate time to reperfusion in STEMI. Most patients with STEMI had reported to have a delay in fibrinolytic therapy.<sup>(18,19)</sup> A single center study at King Faisal Cardiac Center (KFCC) reported door-to-balloon time of < 90 minutes in 62% only. So, door-to-balloon time still behind the recommended time.<sup>(20)</sup> In addition, a standardized Code-STEMI program in King Khalid University Hospital's (KKUH) have been established and code-STEMI implementation significantly improved door-to-balloon time.<sup>(21)</sup>

To the best of our knowledge, no data available on

the assessment of reperfusion time in the emergency centers in Makkah. Early reperfusion in STEMI cases is critical. Therefore, we aimed in this study to evaluate time needed for reperfusion therapy particularly percutaneous coronary intervention (PCI) in patients with STEMI and assess different factors that may delay reperfusion at King Abdullah Medical City (KAMC).

## Methodology

**Study design and setting:** We conducted a retrospective study. Data for 47 patients were obtained from Jan 2018 through March 2019 based on patient medication records obtained from an electronic medical record (EMRs) from KAMC in Makkah, Saudi Arabia.

**Data collection and assessment:** Data were collected from the electronic medical records in KAMC in Makkah. A data collection form was filled with patient demographics (patient name, age, diagnosis and drug therapy for the respective diagnosis), Arrival time (off hours versus regular hours. Regular hours is defined as 08 am to 17 pm during the weekdays, and off hours is defined as weekends, holidays or time between 17 pm and 08 am during the weekdays) and reperfusion time. Then time from arrival until reperfusion was calculated and patient demographics and reasons for delays in reperfusion therapy were analyzed.

**Inclusion and exclusion criteria:** Patients who were above 18 years old and presented to KAMC and diagnosed with ST-segment elevation myocardial infarction (STEMI) and had PIC between Jan 2018 and March 2019 were enrolled. While exclusion criteria included: receiving thrombolytic therapy before arrival or thrombolytic therapy for conditions other than myocardial infarction, starting myocardial infarction attacks at hospital, unknown arrival time or unknown reperfusion time.

**Outcomes and measurement:** Our primary outcome was to evaluate the door-to-balloon time for patients with ST-segment elevation myocardial infarction (STEMI) undergoing primary percutaneous coronary intervention (PCI) in King Abdulla Medical Center (KAMC) under different circumstances such as arrival time, ECG receiving time and direct/indirect presentation.

**Statistical analysis:** All the variables were analyzed using SPSS Var 23.0 software 2015. Descriptive statistics were calculated and presented as means and standard deviations. For continuous variables such as door to

balloon time in minutes, median was calculated. While other variables reported in percentages such as gender, hypertension, diabetes mellitus, dyslipidemia, previous myocardial infarction, renal failure and smoking.

## Results

**Demographic Characteristic:** Patients included in this study were predominantly male (87.2%, no=41). The mean age was 57 (SD  $\pm$  14.2). Majority live in Makkah (87.2%, no=41). History of hypertension and diabetes was present in 42.6% (no=20). Demographic characteristic of patients who were involved in this study are summarized in table 1.

**Assessment of Door-to-balloon time:** After reviewing patients' profiles, data represent around 63.6% of patients (n=7) who were arrived directly at KAMC received PCI within 90 minutes (Door-to-balloon time). The median door to balloon time was 42 minutes (IQR: 29– 67 minutes) for those patients. However, 36.4% of patients (n=4) received PCI in more than 90 Minutes (Figure. 1).

For patients transfer to KAMC from another hospital, data report 63.9% (n=23) of patients received PCI (door-to-balloon therapy) within more than 120 minutes and only 36.1% (n=13) met the guidelines recommended time for the PCI; within 120 Minutes (Figure. 1) with median door to balloon time of 61 minutes (IQR: 27 – 74 minutes).

**Assessment of Door-to-balloon time according to arrival time:** All patients included in this study who arrived directly to KAMC arrived on regular hours. Around 64% of those patients received PCI within 90 minutes while 36% of these patients received PCI in more than 90 Minutes (Figure. 2).

For patients who were transferred from non-PCI-capable hospital about 60% of patients received PCI in more than 120 minutes even though they arrived within regular hours compared to 40% received PCI within 120 minutes. While around 80% of patients who were transferred from non-PCI-capable hospital and arrived during off hours time, had delayed in receiving PCI in more than 120 minutes (Figure. 3).

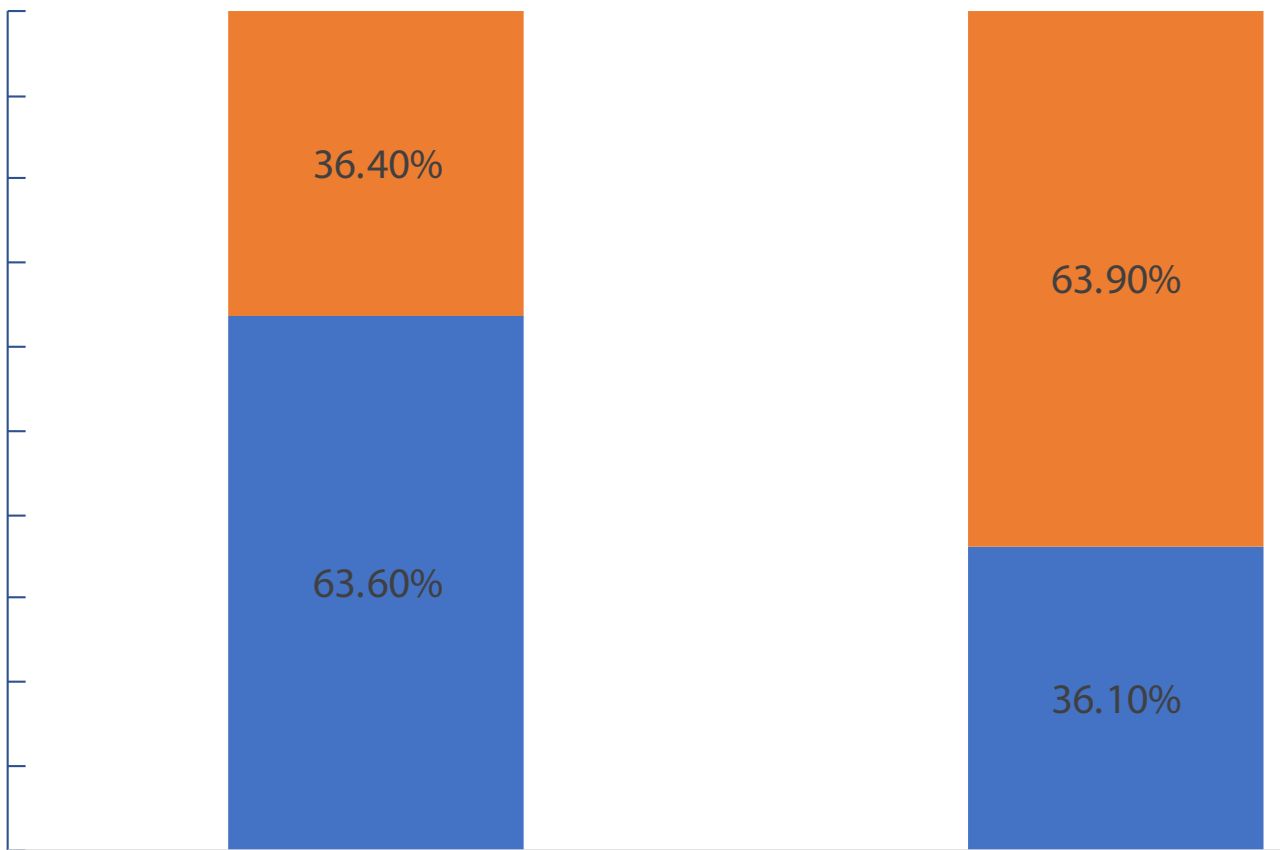
**Assessment of door-to-balloon time according to ECG:** Majority of patients (83%) who received ECG within 10 minutes received PCI within 90 minutes. However, from patients who received ECG after 10 minutes, 60% had a delay in receiving PCI in more than 90 minutes (Figure. 4).

For patients who were transferred from non-PCI-capable hospital, 43% received PCI in more than 120 minutes even though they received ECG within 10 Minutes. Importantly, 77% of patients who were transferred from non-PCI-capable hospital received ECG after 10 minutes with a delay in receiving PCI in more than 120 minutes (Figure. 5).

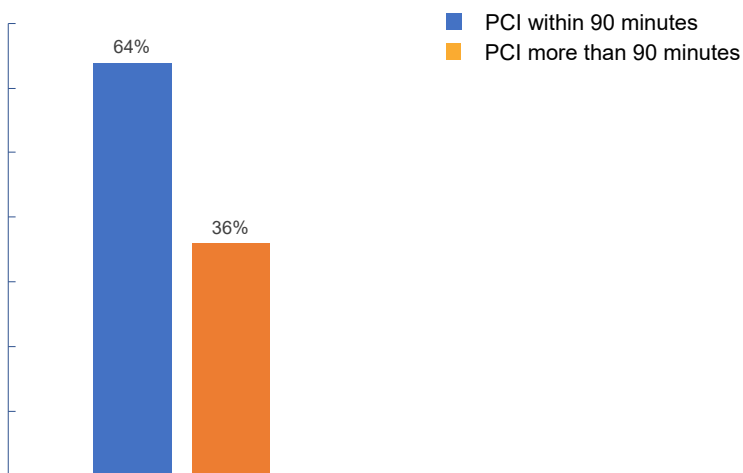
**Table 1: Demographic characteristic. Table represents demographic characteristics of the study population; data presented in actual patient's numbers and percentage (%).**

Demographic characteristic	Actual patients' numbers (Percentage %)	
Age (Years)	30-49	15(32.9%)
	50-69	23(48.9%)
	70-89	8(17.0%)
	>90	1(2.1%)
Gender	Male	41(87.2%)
	Female	6(12.8%)
Area of residence	Makkah	41(87.2%)
	Outside Makkah	6(12.8%)
Nationality	Saudi	21(44.7%)
	Others	26(55.3%)

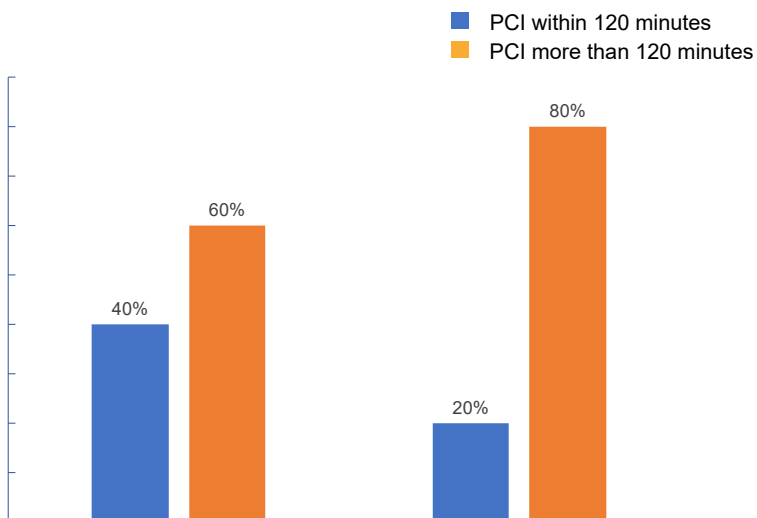
Demographic characteristic	Actual patients' numbers (Percentage %)	
Medical history	Hypertension	4 (8.5%)
	Diabetes	4 (8.5%)
	Dyslipidemia and smoking	2 (4.3%)
	Diabetes and smoking	2 (4.3%)
	Hypertension and diabetes	20 (42.6%)
	Previous myocardial infarction	2 (4.3%)
	Hypertension and previous myocardial infarction	2 (4.3%)
	Renal failure	1 (2.1%)
	Smoking and hypertension	2 (4.3%)
	Smoking	2 (4.3%)
	NON	6 (12.8)



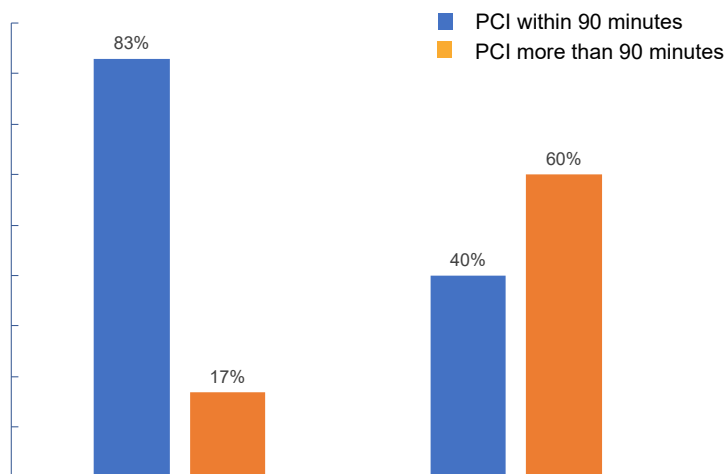
**Figure 1. Door-to-balloon time for patients directly arrived or transferred to KAMC. based on direct/ transferred arrival (x-axis across the page) and patient percentage % (y-axis going into the page).**



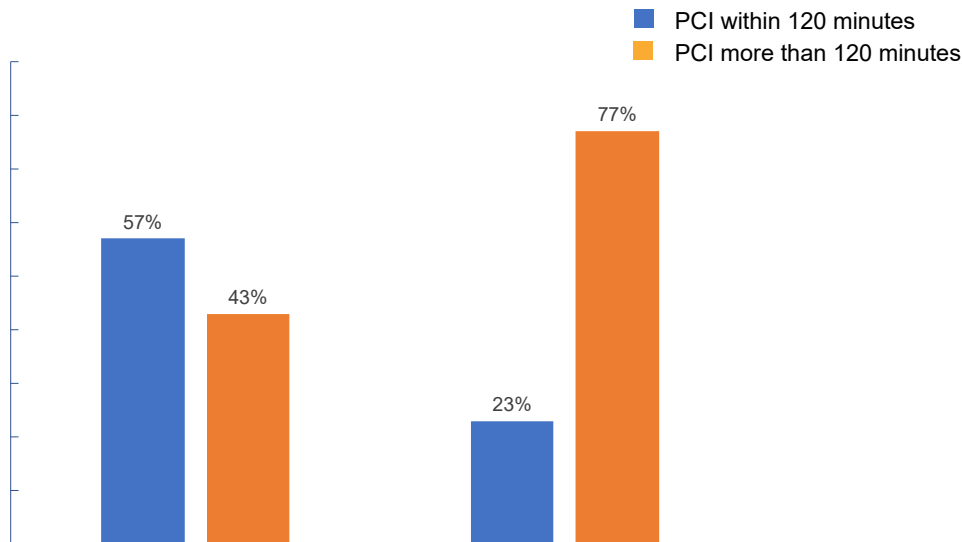
**Figure 2. Door-to-balloon time for patients directly arrived at KAMC based on arrival time (x-axis across the page) and patient percentage % (y-axis going into the page).**



**Figure 3. Door-to-balloon time for patients transferred from non-PCI capable hospital based on arrival time either regular hours or off hours (x-axis across the page) and patient percentage % (y-axis going into the page).**



**Figure 4. Door-to-balloon time for patients directly arrived at KAMC according to time needed to have ECG either within 10 minutes of arrival or more than 10 minutes of arrival (x-axis across the page) and patient percentage % (y-axis going into the page).**



**Figure 5. Door-to-balloon time for patients transferred from non-PCI capable hospital according to time needed to have ECG either within 10 minutes of arrival or more than 10 minutes of arrival (x-axis across the page) and patient percentage % (y-axis going into the page).**

## Discussion

According to recent guidelines, patients with STEMI should have time-to-needle within 90 minutes if arrived directly to PCI capable hospital or within 120 minutes if transferred from non-PCI capable hospital.<sup>(8)</sup> However, our study shows high percentage of patients with STEMI had a delay in receiving PCI. Unfortunately, 36.3% of patients with STEMI received PCI in more than 90 Minutes even though they arrived directly to KAMC. Receiving. For patients transferred from non-PCI capable Hospital such as: Al-Noor Specialist Hospital, Heraa General Hospital, East Jeddah General Hospital, King Faisal Hospital in Makkah or King Faisal Hospital in Taif, higher percentage around 63.8% of patients did not meet the guidelines recommended time for the PCI which is within 120 Minutes.

The delay in the PCI may be due to arriving at off working hours such as weekends, holidays or after 5:00 pm. Our data shows around 20% increase in patients percentage who have a delay in PCI when they arrived off hours. Another factor that may affect the delay in PCI, the delay in the ECG performing as the recommended time for having ECG is within 10 minutes of hospital arrival.<sup>(8)</sup>

Small Number of patients is the main limitation of this study. In addition, the effect of delaying time-to-needle in patients with STEMI patients on mortality remains unclear.

At last, hospitals should consider better strategies to ensure that patients with STEMI able to have reperfusion therapy within the recommended timeline. Easier system that accelerate patients access and simplify procedures for their entry as well as transferring between hospitals and universal healthcare system are needed to be implemented in Saudi Arabia in order to meet the international standards and guidelines.

## Conclusion

High percentage of patients with STEMI at KAMC did not receive PCI within the guidelines recommended time-line. More strategies have to be applied to ensure recommended door-to balloon time achievement.

**Conflict of Interest:** The authors have not declared any conflict of interests.

**Ethical Clearance:** Ethical approval was obtained from King Abdullah Medical City IRB committee, IRB #18-487.

**Source of Funding:** No funding available for this study.

## References

1. World health organization. The top 10 causes of death 2018, Msy 24 [Available from: <http://www.who.int/news-room/fact-sheets/detail/the-top-10-causes-of-death>].

2. Yeh RW, Sidney S, Chandra M, Sorel M, Selby JV, Go AS. Population trends in the incidence and outcomes of acute myocardial infarction. *New England Journal of Medicine*. 2010;362(23):2155-65.
3. Roe MT, Messenger JC, Weintraub WS, Cannon CP, Fonarow GC, Dai D, et al. Treatments, trends, and outcomes of acute myocardial infarction and percutaneous coronary intervention. *Journal of the American College of Cardiology*. 2010;56(4):254-63.
4. Mehta RH, Parsons L, Rao SV, Peterson ED. Association of Bleeding and In-Hospital Mortality in Black and White Patients With ST-Segment–Elevation Myocardial Infarction Receiving Reperfusion Clinical Perspective. *Circulation*. 2012;125(14):1727-34.
5. Mandelzweig L, Battler A, Boyko V, Bueno H, Danchin N, Filippatos G, et al. The second Euro Heart Survey on acute coronary syndromes: characteristics, treatment, and outcome of patients with ACS in Europe and the Mediterranean Basin in 2004. *European heart journal*. 2006;27(19):2285-93.
6. Subherwal S, Bach RG, Chen AY, Gage BF, Rao SV, Newby LK, et al. Baseline risk of major bleeding in non-ST-segment-elevation myocardial infarction: the CRUSADE (Can Rapid risk stratification of Unstable angina patients Suppress ADverse outcomes with Early implementation of the ACC/AHA Guidelines) Bleeding Score. *Circulation*. 2009;119(14):1873-82.
7. Peter Bogaty M, Armstrong P, Bogaty P, Buller C, Dorian P, O'Neill B. The 2004 ACC/AHA guidelines: a perspective and adaptation for Canada by the Canadian Cardiovascular Society Working Group. *Can J Cardiol*. 2004;20(11):1075.
8. O'gara PT, Kushner FG, Ascheim DD, Casey DE, Chung MK, De Lemos JA, et al. 2013 ACCF/AHA guideline for the management of ST-elevation myocardial infarction: executive summary: a report of the American College of Cardiology Foundation/American Heart Association Task Force on Practice Guidelines. *Journal of the American College of Cardiology*. 2013;61(4):485-510.
9. Berger PB, Ellis SG, Holmes Jr DR, Granger CB, Criger DA, Betriu A, et al. Relationship between delay in performing direct coronary angioplasty and early clinical outcome in patients with acute myocardial infarction: results from the global use of strategies to open occluded arteries in Acute Coronary Syndromes (GUSTO-IIb) trial. *Circulation*. 1999;100(1):14-20.
10. Scholz KH, Maier SK, Maier LS, Lengenfelder B, Jacobshagen C, Jung J, et al. Impact of treatment delay on mortality in ST-segment elevation myocardial infarction (STEMI) patients presenting with and without haemodynamic instability: results from the German prospective, multicentre FITT-STEMI trial. *European heart journal*. 2018;39(13):1065-74.
11. Boersma E. Does time matter? A pooled analysis of randomized clinical trials comparing primary percutaneous coronary intervention and in-hospital fibrinolysis in acute myocardial infarction patients. *European heart journal*. 2006;27(7):779-88.
12. Kruyt ND, Nederkoorn PJ, Dennis M, Leys D, Ringleb PA, Rudd AG, et al. Door-to-needle time and the proportion of patients receiving intravenous thrombolysis in acute ischemic stroke: uniform interpretation and reporting. *Stroke*. 2013;44(11):3249-53.
13. Houghland JE. Impact of Time of Presentation on the Care and Outcomes of Acute Myocardial Infarction: Jneid H, Fonarow GC, Cannon CP, et al. *Circulation* 2008; 117; 2502–9. *Journal of Emergency Medicine*. 2008;35(4):465.
14. Dasari TW, Roe MT, Chen AY, Peterson ED, Giugliano RP, Fonarow GC, et al. Impact of Time of Presentation on Process Performance and Outcomes in ST-Segment–Elevation Myocardial Infarction: A Report From the American Heart Association: Mission Lifeline Program. *Circulation: Cardiovascular Quality and Outcomes*. 2014:CIRCOUTCOMES. 113.000740.
15. Jneid H, Fonarow GC, Cannon CP, Hernandez AF, Palacios IF, Maree AO, et al. Sex differences in medical care and early death after acute myocardial infarction. *Circulation*. 2008;118(25):2803-10.
16. Gupta A, Barrabes JA, Strait K, Bueno H, Porta-Sánchez A, Acosta-Vélez JG, et al. Sex Differences in Timeliness of Reperfusion in Young Patients With ST-Segment–Elevation Myocardial Infarction by Initial Electrocardiographic Characteristics. *Journal of the American Heart Association*. 2018;7(6):e007021.
17. Alshahrani H, McConkey R, Wilson J, Youssef M, Fitzsimons D. Female gender doubles pre-hospital



- delay times for patients experiencing ST segment elevation myocardial infarction in Saudi Arabia. *European Journal of Cardiovascular Nursing*. 2014;13(5):399-407.
18. AlHabib KF, Hersi A, AlFaleh H, Kurdi M, Arafah M, Youssef M, et al. The Saudi Project for Assessment of Coronary Events (SPACE) registry: design and results of a phase I pilot study. *Canadian Journal of Cardiology*. 2009;25(7):e255-e8.
  19. AlHabib KF, Hersi A, AlFaleh H, AlNemer K, AlSaif S, Taraben A, et al. Baseline characteristics, management practices, and in-hospital outcomes of patients with acute coronary syndromes: results of the Saudi project for assessment of coronary events (SPACE) registry. *Journal of the Saudi Heart Association*. 2011;23(4):233-9.
  20. Bugami S, Neyaz A, Alabbadi M. In hospital outcomes of primary percutaneous intervention in patients presenting with acute myocardial infarction in Saudi Arabia—A single center study. *Chest*.75:97.
  21. Alyahya AA, Alghamass MA, Aldhahri FS, Alsebti AA, Alfulaj AY, Alrashed SH, et al. The impact of introduction of Code-STEMI program on the reduction of door-to-balloon time in acute ST-elevation myocardial infarction patients undergoing primary percutaneous coronary intervention: A single-center study in Saudi Arabia. *Journal of the Saudi Heart Association*. 2018;30(3):172-9.

# The Adsorption Effect of Pine Resin (*Pinus Merkusii*) in Reducing Hardness (CaCO<sub>3</sub>) in Clean Water

Ashari Rasjid<sup>1</sup>, Syamsuddin S.<sup>2</sup>

<sup>1</sup>Associate Professor, <sup>2</sup>Assistant Professor, Department of Environmental Health, Researcher in the Center of Excellent of Urban Health, in Health Polytechnic of Ministry of Health in Makassar, Indonesia

## Abstract

Globally, the quantity of land and water resources on earth is relatively fixed, while the quality progressively decreased. One of the problems with clean water quality is the hardness level caused by valence cation ions of two metals such as Ca<sup>2+</sup>, Mg<sup>2+</sup>, Fe<sup>2+</sup> and Mn<sup>2+</sup>. The purpose of this study is to determine the effect of pine resin (*Pinus merkusii*) in reducing hardness (CaCO<sub>3</sub>) in clean water. This type of research is a quasi-experimental study by testing the treatment of hard water using pine resin media (*Pinus merkusii*) measuring ± 5 cm with variations in the thickness of the media that is 20 cm, 40 cm, and 60 cm by replicating 3 times. The results of this study found that the reduction in hardness at 20 cm media thickness by 42.14%, at 40 cm thickness by 51.58%, and a thickness of 60 cm 73.78%. And the one way ANOVA test results showed the value of the comparison between hardness after filtration was  $\text{sig}.0.00 \leq 0.05$  so that there was a significant difference between the thickness of the pine resin (*Pinus merkusii*) 20 cm, 40 cm, 60 cm. The conclusion from the study of water management through filtration using pine resin media (*Pinus merkusii*) meets the requirements according to the Health Ministry of Indonesia Regulation Number 32 of 2017. Water treatment with pine resin if used for the community should use a thickness of 60 cm. As for researchers, it can further use other variations such as the thickness of the pine resin used.

**Keywords:** Adsorption, Pine Resin, Hardness, and Clean Water.

## Introduction

Water is the essence of life. With the presence of water, all living things on this earth can grow and develop properly. Water covers 75% of the earth's surface. The presence of water on this earth covers 97% in the ocean, 2% in ice sheets or glaciers, 0.6% in the soil, 0.3 is water vapor, 0.1 is in the soil surface. In living cells, 70% or more consists of water, including the human body. In the bones, there is water as much as 22% of the bone weight and 83% in the blood and kidneys.

The importance of water for health can be seen from

the percent of the amount of water in the body's organs, which is 80% in the blood, 25% in the bones, 75% in the nerves, 80% in the kidneys, 70% in the liver, and 75% in the muscles.<sup>1</sup>

Reducing 4% to 5% of the water in our body will be able to affect the decline in workability by 20% to 30% and greater water loss can be fatal for us.<sup>2</sup>

In addition to quantity, decreasing water quality is also very influential in human health, one of which is high hardness in some areas, especially in South Sulawesi.

Some areas surveyed by researchers regarding hardness levels in several areas in South Sulawesi showed that the level of hardness in clean water taken from community dug wells was 626 mg/L.<sup>3</sup> A survey in 2015 in Tonasa 1, Pangkep Subdistrict, the level of hardness obtained was 380.9 mg/L.<sup>4</sup> Another survey by in 2016 in Citta Subdistrict, Soppeng District, the level of hardness obtained was 323.83 mg/L.<sup>5</sup>

---

### Corresponding Author:

**M. Askar**

Researcher in the Center of Excellent on Urban Health of Health Polytechnic of Makassar, Jl. Banta-Bantaeng No. 46, Makassar, South Sulawesi, Indonesia-90222

Mobile No.: 085299947722

e-mail: askar@poltekkes-mks.ac.id

The hardness standard is 500 mg/L,<sup>6</sup> while other references stated that the hardness level > 300 mg/L is classified in very hard water.<sup>7</sup> To overcome this problem, it needs treatment efforts before the water is used so it will not interfere with health such as blockage of heart arteries and kidney stones or damage household cookware and household or industrial piping networks.

Hardness can be reduced by several ways such as heating to temporary hardness, adding chemicals to reduce pH in raw water such as the addition of lime soda (Na<sub>2</sub>CO<sub>3</sub>) or the addition of caustic soda (NaOH), the recarbonation process for pH stabilization, ion exchange using zeolites, or the use of resins both natural and synthetic resins.<sup>8</sup>

Resin is a hydrocarbon compound that can exchange ions so that the ions are often in drinking water treatment or wastewater treatment.<sup>9</sup> Natural resins can be obtained from plant sap such as pine trees (*Pine merkusii*) which are processed through the distillation process. This pine sap contains abietic acid (C<sub>20</sub>H<sub>30</sub>O<sub>2</sub>) and terpene acid (C<sub>5</sub>H<sub>8</sub>).<sup>10</sup> The use of this media only requires a relatively low cost, and is widely available in South Sulawesi and can be used many times.

Based on the description above, the authors are interested in examining how much the ability of pine resin adsorption in reducing hardness levels in clean water.

## Materials and Method

This type of research is a quasi-experimental study by testing the treatment of hard water using pine resin media (*Pinus merkusii*) measuring ± 5 cm with a variation of media thickness of 20 cm, 40 cm, and 60 cm by replicating 3 times.

In this study, the sample used was clean water from residents' dug wells in the Citta Subdistrict, Soppeng Regency which had a high level of hardness. This research was conducted at the Makassar Health Polytechnic College precisely at the College Workshop on Environmental Health and laboratory analysis testing was conducted at the Chemical Laboratory majoring in environmental health Makassar Health Polytechnic.

The time of this study was divided into two stages, namely the preparatory stage, which includes the collection of secondary data that took place from February to March 2019, and the implementation phase, including research activities that took place from May to August 2019.

The sample in the study was clean water from a community dug well in Citta Subdistrict, Soppeng Regency which had a high level of hardness. Primary data using data obtained based on the results of processing with pine resin (*Pine merkusii*) in reducing hardness in clean water. Secondary data was data obtained from various references both articles, books, and other literature that were considered to be able to support existing theories, and were considered to have a relationship with this research.

The data analysis technique was carried out with the ANOVA test from observations obtained at the time of the implementation of the experiment and described in tabular form. The results of the study were accompanied by descriptions based on supporting theories.

## Results

Large Decreased Hardness in Thickness of Pine Resin Media (*Pinus merkusii*) 20 cm. Based on research activities and examination of clean water samples in the laboratory, the average results can be described in Table 1:

**Table 1: Average Hardness After Through Pine Resin Media Filtration Thickness of 20 cm in the 2019 Dug Well Water Sample**

Before Treatment	Repetition	Hardness Level (mg/l)		Effectiveness of Decrease (%)
		After Treatment		
		Control	The thickness of 20 cm	
660.96	1	579,36	380.26	42.47
	2	628.32	391.68	40.74
	3	595.68	375.36	43.21
Average		601.12	382.43	42,14

Based on Table 1. above was the average yield of hardness before and after treatment with pine resin media thickness of 20 cm used in water samples from the first repetition to the third repetition. The results for hardness before treatment were 660.96 mg/l with three times repetition to control the average yield of 601.12 mg/l, after treatment on pine resin media thickness of 20

cm obtained an average result of 382.43 mg/l with the effectiveness of 42.14%.

Large Decreased Hardness in Thickness of Pine Resin Media (*Pinus merkusii*) 40cm. Based on research activities and examination of clean water samples in the laboratory, the average results can be described in Table 2:

**Table 2: Average Hardness After Filtration Through Pine Resin Media Thickness of 40 cm in 2019 Dug Well Water Samples**

Before Treatment	Repetition	Hardness Level (mg/l)		Effectiveness of Decrease (%)
		After Treatment		
		Control	The thickness of 40 cm	
660.96	1	652.80	328.03	50.37
	2	612.00	313.75	52.53
	3	542.64	318.24	51.85
Average		602.48	320.01	51.58

Based on Table 2 above was the average yield of hardness before and after treatment with pine resin media thickness of 40 cm used in water samples from the first repetition to the third repetition. The results for hardness before treatment were 660.96 mg/L with three times repetition to control the average yield of 602.48 mg/L, after treatment on pine resin media thickness of 40 cm obtained an average result of 320.01 mg/l with the effectiveness of 51.58%.

Large Decreased Hardness in Thickness of Pine Resin media (*Pinus merkusii*) 60cm. Based on research activities and examination of clean water samples in the laboratory, the average results can be described in Table 3:

**Table 3: Average Hardness After Filtration of Pine Resin Media Thickness of 60 cm in 2019 Dug Well Water Samples**

Before Treatment	Repetition	Hardness Level (mg/l)		Effectiveness of Decrease (%)
		After Treatment		
		Control	The thickness of 60 cm	
660.96	1	652.80	181.97	72.46
	2	530.40	178.70	72.96
	3	593.64	159.12	75.93
Average		592.28	173.26	73.78

Based on Table 3 above was the average yield of hardness before and after treatment with pine resin media thickness of 60 cm used in water samples from the first repetition to the third repetition. The results for hardness before treatment were 660.96 mg/L with three

times repetition to control the average yield of 592.28 mg/L, after treatment on pine resin media thickness of 60 cm obtained an average result of 173.26 mg/L with the effectiveness of 73.78%.

The following are the results of data analysis using one way ANOVA statistical tests to determine whether there are differences in filter media used as interventions/treatments:

**Table 4: Statistical Analysis Results Using One Way Anova Test Difference in Decreased Hardness Levels After Filtration Using Pine Resin Media with Thicknesses of 20 cm, 40 cm, and 60 cm in 2019**

	Sum of Squares	df	Mean Square	F	Sig.
Between Groups	492731,292	5	98546.258	76,328	0.00
Within Groups	15493,054	12	1291,088		
<b>Total</b>	<b>508224,346</b>	<b>17</b>			

One way ANOVA test results based on Table 4 showed the comparison value between hardness levels after going through filtration where filtration results at thicknesses of 20 cm, 40 cm, and 60 cm were obtained from the One Way ANOVA statistical test results using SPSS results of Sig. if  $\leq 0.05$  then it showed that there was a difference but if the Sig.  $\geq 0.05$ , it is showed that there was no difference.

The results above indicated a difference because of the Sig. 0.00. Or  $0.00 \leq 0.05$  so the hypothesis was accepted this showed that for the decrease in hardness there was a significant difference between the thickness of the pine resin media 20 cm, 40 cm, and 60 cm.

## Discussion

Water is one of the natural resources that have a very important function for human life and life, as well as to advance public welfare so that it is the basic capital and the main factor of development. Water is also an environmental component that is important for the survival of humans and other living things. That can be seen from the fact that 70 percent of the earth's surface is covered with water and two-thirds of the human body consists of water.<sup>11</sup>

Groundwater is a part of the water in nature that is below the surface of the land. The formation of groundwater follows the cycle of water circulation on earth called the hydrological cycle, which is a natural process that takes place in water in nature that undergoes a sequential and continuous displacement.<sup>12</sup>

The hardness standard in Indonesia Regulation is 500 mg/L<sup>6</sup> but another literature<sup>7</sup> stated that the hardness level >300 mg/L is classified in very hard water. To overcome this problem, it needs treatment efforts before the water is used so it will not interfere with health such

as blockage of heart arteries and kidney stones or damage household cookware and household or industrial piping networks.

Hardness can be reduced by several ways such as heating to temporary hardness, adding chemicals to reduce pH in raw water such as the addition of lime soda ( $\text{Na}_2\text{CO}_3$ ) or the addition of caustic soda ( $\text{NaOH}$ ), the recarbonation process for pH stabilization, ion exchange using zeolites, or the use of resins both natural and synthetic resins.<sup>8</sup>

Hardness is classified in two ways, namely based on metal ions and based on anions associated with metal ions. Based on metal ions, hardness is divided into calcium hardness and magnesium hardness. Based on anions associated with metal ions, hardness is divided into carbonate hardness and non-carbonate hardness.<sup>5</sup>

Hardness is caused by excessive amounts of mineral-containing metal cations with two-dimensional cations. Usually what often causes hardness is the  $\text{Ca}^{++}$  and  $\text{Mg}^{++}$  cations. Total hardness is hardness caused by  $\text{Ca}^{++}$  and  $\text{Mg}^{++}$  together.<sup>5</sup>

Resin is a hydrocarbon compound that can exchange ions so that the ions are often in drinking water treatment or wastewater treatment.<sup>9</sup> Natural resins can be obtained from plant sap such as pine trees (*Pine merkusii*) which are processed through the distillation process. This pine sap contains abietic acid ( $\text{C}_{20}\text{H}_{30}\text{O}_2$ ) and terpene acid ( $\text{C}_5\text{H}_8$ ).<sup>10</sup> The use of this media only requires a relatively low cost, and is widely available in South Sulawesi and can be used many times.

The hardness of water is different from the acidity of water, even though the two are closely related. Both can be easily distinguished. Acidic water usually shows a soft reaction. Therefore, the hardness of water is often

called the hardness of the water.<sup>13</sup> Hardness is the nature of water caused by the presence of valence metal ions. Such ions can react with soap to form lumps. The main cause of hardness is cation  $\text{Ca}^{2+}$ ,  $\text{Mg}^{2+}$ ,  $\text{Fe}^{2+}$  and  $\text{Mn}^{2+}$ .<sup>14</sup>

Hardness in groundwater is caused by contact between groundwater and the layers of rocks. Rainwater that falls to earth cannot dissolve the large amounts of solid material contained in water. That ability can only be achieved if it has reached the soil where  $\text{CO}_2$  is released by the reaction of bacteria, this  $\text{CO}_2$  in the soil is in equilibrium with carbonic acid.

Water that contains high hardness will result in high use of soap, due to the chemical relationship between hardness ions and soap molecules, causing detergent properties of soap to disappear. Excess  $\text{Ca}^{2+}$  ions and  $\text{CO}_3$  ions (one of the alkalinity ions) result in the formation of scale on the pipe and pan walls caused by the deposition of calcium carbonate  $\text{CaCO}_3$ .

The processing used in this research was processing with filtration which has a basis as physical, chemical, and biological filtering to separate/filter out particles that were not deposited in the sedimentation process through porous media. The filtering process was needed to separate the small/fine-sized flocks that cannot be deposited by the deposition process.<sup>11</sup>

One effort to overcome hardness is by softening hard water. Softening is the removal of certain ions that are in water and can react with other substances until the water distribution and use are disrupted. Theoretically, the reduction or softening of water hardness consists of various processes that exist in the process of softening hard water, namely using an ion-exchange system where water treatment uses resin or zeolite to replace unwanted ions in water such as  $\text{Ca}^{2+}$  and  $\text{Mg}^{2+}$  and replace them with  $\text{Na}^+$  ions and  $\text{K}^+$ .<sup>15</sup>

This process is very fast (20-30 minutes), cannot take place with other reactions and raw water must not be turbid, installation and operation are complicated, high efficiency, price is relatively expensive (suitable for the industry). This process can be used for processing permanent and temporary hardness by separating unwanted ions contained in hard water. The material used in this process is in the form of activated carbon and or synthetic resin which is put into a column where water can already flow through the compounds.<sup>16</sup>

Adsorption is the capture or binding of free ions in water by adsorbents. Examples of substances used for the adsorption process are zeolites and resins which are the polymerization of polyhydric phenols with formaldehyde. For example, the binding of  $\text{Ca}^{2+}$  and  $\text{Na}^+$  ions. Each gram of resin can adsorb 4-9 MeV (milliequivalent). The amount of adsorbent needed depends on the concentration of the solution. The higher the concentration of the solution, the greater the adsorbent needed to purify water.<sup>9</sup>

Pine resin has been through the distillation process produced by the merkusii pine tree classified as oleoresin which is a liquid resinous acid in turpentine that trickles out when the resin channel on wood or needle bark is cut or broken. The name oleoresin is used to differentiate pine resin from natural resin that appears on the skin or is contained in cavities in wood tissue as a genus of members of the *Dipterocarpaceae*, *Leguminosae*, and *Caesalpinaceae* families.<sup>10</sup>

The sap that comes from the pine tree is dark yellow and sticky, which consists of a complex mixture of chemicals. The most important elements that makeup pine resin are terpene acids and abietic acids. The mixture is dissolved in alcohol, gasoline, ether, and some other organic solvents, but it is not soluble in water. Besides, from the results of the distillation of *Pinus merkusii* sap produced an average of 64% gondorukem, 22.5% turpentine, and 12.5% impurities. The resin canal is not a part of the wood, but a cavity surrounded by parenchymal cells or epithelial cells. All layers surrounding the resin channel are called epitellium.<sup>10</sup>

Distilled pine sap will produce gondorukem (gum rosin) and turpentine (gum turpentine). The color is pale, clear, and sticky and when evaporated becomes brittle, it states that pine resin is composed of 66% resinous acid (resin), 25% turpentine (monoterpene), 7% neutral non-volatile material, and 2% water.<sup>17</sup>

Gondorukem or resin is a hydrocarbon compound that can exchange ions so that it is often used in drinking water treatment or wastewater treatment. At present, there are two types of resins, natural resins, and synthetic resins. Natural resins are processed from pine wood sap taken specifically, usually in the industry used for lacquer. Synthetic resins are made from hydrocarbons through chemical processes. This synthesis resin is widely used in the plastics industry, household appliances, toys, and decoration.<sup>9</sup>

The use of resin is one method to treat water by passing water to the resin media. Water treatment with this resin is one method of separation according to chemical changes by exchanging ions. The principle of water treatment with resins is to replace or exchange ions bound to the polymer filling resin with the ions that are passed. There are two kinds of ion exchange resins.

Cation exchange resin is a resin that will exchange or take cations from the solution. For example, if the water contains Fe (iron) ions the Fe ions will be bound by resin into R-Fe ions. However, the bond is not permanent so when it is saturated, the resin used for water filters can be washed with warm water that is given salt (NaCl). Furthermore, the resin will be pure again and can be reused. The resin takes the role of taking cations from the solution. Cation exchange resins take cations from the solution. Cation exchange resins contain carboxylic, sulfonic, phenolate or other groups and several equivalent cations.<sup>9</sup>

Anion exchange resins are used using separation based on the charge held by the solute. One example is the ion group containing sodium.<sup>9</sup> Ion exchange that occurs in the filtration process is also influenced by the thickness and height of the water sample when jetting thicker the pine resin media used, the higher the decrease in hardness levels in water through the filtration process with pine resin media.

The basic principle of filtration is physical, chemical, and biological particle filtering to separate/filter out particles that are not deposited in the sedimentation process through porous media.<sup>18</sup> The most influential filtration principle in this research is the deposition process that occurs on slow filters or filters with flow direction from the bottom up. The space between the grains of sand media functions as small sedimentation. Even small particles, as well as colloids and some bacteria, will settle in the space between the grains and adhere to the physical effect (adsorption) grains.

Filtration in a clean water treatment system is the process of removing fine particles/flocks that pass through the sedimentation unit, where the particles/flocks will be retained on the filtering media as long as the water passes through the media. The design of the research that has been made by using a filtering device from PVC pipe that is designed so that it becomes a simple filtering device using media, the filtration process used is in the direction of up-flow which is a water

treatment system by passing through a media filter with direction flow from the bottom up so that if the media used is dirty the washing process will be very easy.

Upstream flow direction requires a lot of water samples because water samples will be flowed gravity and also use pressure so that water samples will flow through the media that has been prepared.

When viewed from the effectiveness of the thickness of the filter media, filtration with a thickness of pine resin 60 cm is the most effective in reducing hardness in water samples, from 660.96 mg/L down to an average of 173.26 mg/L with the effectiveness of 73.78% compared to the thickness of pine resin 20 cm which dropped to an average of 382.43 mg/L with the effectiveness of 42.14%, and the thickness of a 40 cm pine resin dropped to an average of 320.01 mg/L with the effectiveness of 51.58%.

Based on the results of statistical tests using one way ANOVA test to determine the differences in more than two interventions with replication. On the results of hardness inspection using variations in the thickness of the pine resin media 20 cm, 40 cm, and 60 cm, the Sig. the value was obtained.  $0.00 < 0.05$  so that the hypothesis was accepted, this showed that for hardness there was a significant difference in the intervention by using variations in the thickness of the pine resin media 20 cm, 40 cm, and 60 cm.

However, if compared with Health Ministry of Health Regulation Number 32 in 2017 concerning Environmental Health Standard Quality and Water Health Requirements for Sanitary Hygiene, Swimming Pools, Solus Per Aqua and Public Baths, especially on water health requirements for sanitary hygiene requirements from total samples for hardness levels (CaCO<sub>3</sub>) nothing has passed the established quality standard of 500 mg/L, on the results of sample water that has been through filtration treatment.

## Conclusion

Based on the results of research that has been done can be concluded that there was a decrease in hardness of an average of 42.14% and qualify for water through filtration treatment with the media at a thickness of pine resin (*Pinus merkusii*) 20 cm. The average hardness reduction of 51.58% and qualify for water through filtration treatment with media at a thickness of pine resin (*Pinus merkusii*) media of 40 cm. This research

found a significant decrease in hardness of an average of 73.78%, the most effective and eligible for water through filtration treatment with media at a thickness of pine resin (*Pinus merkusii*) 60 cm. The significant value between the difference in thickness of the pine resin media 20 cm, 40 cm, 60 cm is sig.  $0.00 < 0.05$ .

Based on the conclusions above, the authors suggest for the Community that people who want to use this processing, preferably using a thickness of 60 cm or more so that the results of more optimal processing. Besides, if the processing is used continuously for household needs, then the filter media should be cleaned for a certain period. Other researchers can then try to do filtration by comparing variations by adding different thicknesses.

**Conflict of Interest:** Nil

**Source of Funding:** Self

**Ethical Clearance:** Taken from National Health Research and Development Ethical Committee Ministry of the Health Republic of Indonesia.

### References

1. Fakhurroja H. Making Water Wells in Various Lands. Depok: Griya Kreasi. 2010.
2. Halim A, et al. Pesantren Management. Yogyakarta: PT LKIS Pelangi Aksara. 2005.
3. Mauluddin M. Study of Water Quality in the Area of the Surrounding the Tallo River Estuary and its Potential Use as a Source of Community Water. Thesis Published, Undergraduate Program in Civil Engineering, Hasanuddin University, Makassar; 2013. <http://repository.unhas.ac.id/handle/123456789/18789> (accessed).
4. Indriani, Andi S. The Ability of Eggshells in Reducing the Hardness of Dug Well Water. Scientific Paper, Unpublished, 3yrs Diploma Programme of Environmental Health Department, Health Polytechnic of Ministry of Health, Makassar; 2015.
5. Effendi H. Study of Water Quality for Water Resources and Environmental Management. Yogyakarta: Canisius. 2003.
6. Ministry of the Health Republic of Indonesia. Ministry of Health Regulation Number 32 about Gold Standard Quality of Environmental Health and Requirements Water Health for Hygiene Sanitation, Swimming Pool, Solus per Aqua, and Public bath. Jakarta; Law and Organization Bureau. 2017.
7. Sugiharto. Provision of Clean Water for the Community. Tanjungkarang: Tanjungkarang Hygiene Support School. 1983.
8. Ruliasih, Nusa IS. Elimination of Hardness in Drinking Water. 2001. <https://docplayer.info/213306-Bab-9-penghahan-desadah-in-in-air-minum-by-nusaidaman-said-and-ruliasih-9-1-hardness.html> (accessed).
9. Kusnaedi. Processing Dirty Water for Drinking Water. Bogor: Self-help Spreaders. 2010.
10. Bambang W, Sanro T, Djaban T. Chemical Composition of Indonesian Pinus merkusii Turpentine Oils, Gum Oleoresins and Rosins from Sumatra and Java. Pakistan Journal of Biological Sciences. 2006;9(1):7-14. DOI:10.3923/pjbs.2006.7.14.
11. Asmadi, Khayan, Kasjono. Drinking water treatment technology. Yogyakarta: Gosyen Publishing. 2011.
12. Kodoatie RJ, Sarief R. Integrated water resources management. Yogyakarta: Andi Publishing. 2012.
13. Ghufran M, Kordi K. 2010. Management of water quality in aquaculture. Jakarta: Rineka Cipta. 2010.
14. Margono et al. Teacher's Guide to Environmental Chemistry Teaching. Jakarta: Ministry of Health. 1991.
15. Sebayang P, et al. Dirty and Brackish Water Treatment Technology Into Clean and Drinkable Water. Jakarta: The Indonesia Institute of Sciences (LIPI). 2015.
16. Arifin MZ. Effect of Active Carbon Contact Duration as Filter Media on Percentage of Decreased CaCO<sub>3</sub> Artesis Water. Thesis Published, Undergraduated Program in Faculty of Public Health, University of Muhammadiyah Semarang; 2010. [eprints.ums.ac.id/27239/16/02.\\_JURNAL\\_PUBLIKASI.pdf](http://eprints.ums.ac.id/27239/16/02._JURNAL_PUBLIKASI.pdf) (accessed).
17. Supriyo H. Daryono P. Nutrient Content of Pine Leaves Merkusii Jungh. et de Vriese And Soil Properties Are Made With Varied Latex Production. Journal of Forestry Science. 2017;7(2):71-80. <https://journal.ugm.ac.id/jikfkt/article/view/7514> (accessed).
18. Joko T. Production unit in drinking water supply system. Yogyakarta: Graha Ilmu, 2010.



# Assessment of the Knowledge and Attitude of Eligible Couples towards Tubectomy and Vasectomy

Ashish Dass<sup>1</sup>, Jaspreet Kaur Dullat<sup>2</sup>, Maninder Singh<sup>3</sup>, Aanchal<sup>4</sup>, Balpreet Kaur<sup>4</sup>, Chandresh<sup>4</sup>, Jahangir<sup>4</sup>

<sup>1</sup>Nursing Tutor, <sup>2</sup>Associate Professor, <sup>3</sup>Assistant Professor, Chitkara School of Health Sciences, Chitkara University, Punjab, India, <sup>4</sup>B.Sc. Nursing 4<sup>th</sup> Year Students

## Abstract

**Background:** The populace is quickly expanding and has become a significant issue with the populace developing at a yearly pace of 1.2%. India will have more than 1.53 billion people before the completion of 2030 with the masses improvement rate at 1.58%.

**Materials and Method:** A Non-Experimental Descriptive Survey Research Design was used. A sample was comprised of 50 males and 50 females belongs to peer group of 20-45 years. Purposive sampling technique was utilized to gather sample for additional investigation. The data was aggregated by applying selected variables, Structured Knowledge Questionnaire and Attitude Rating Scale.

**Results:** The result showed a significant association of knowledge of males with their selected variables. The calculated p value of males and females with selected variables of knowledge and attitude was nonsignificant which showed that there was no association between the level of knowledge and attitude of males and females towards tubectomy and vasectomy.

**Conclusion:** It was concluded that Knowledge of the males and females regarding tubectomy and vasectomy was in average and Attitude was moderately favourable. There was not any relationship between knowledge and attitude of males and females regarding tubectomy and vasectomy.

**Keywords:** Knowledge, attitude, males, females.

## Introduction

India is a second largest country because of its population that is 1,311,559,168(1.31 billion), on the other hand China is the top largest country because of its population 1,380,914,176(1.38 billion). These figures show that India came to for all intents and purposes 17.74 of the all out populace, which shows that every person out of six social orders is has a spot with India. Be that as it may, the crown of the world's most prominent

nation is China's obligation from a long time. India is additionally expected to take a similar circumstance by 2030. With the people advancement rate by 1.58%, India is typical for over than 1.53 billion people before the completion of 2030<sup>1</sup> (Taneja, 2014).

According to the world health organization, 1 million conceptions takes place every day and about 50% of these contraceptions are unplanned and 25% of them are unwanted (ladipo, 1999). Everyday about 150,000 unwanted pregnancies are terminated. (Etuk, 2003).

In India, The national Family Planning Programme was started in 1952 to making it the first country in the world to do so. In spite of this about 56% eligible couples in India are still unprotected against contraception<sup>3</sup>. (Reddy, 2003).

---

### Corresponding Author:

Mr. Ashish Dass

Nursing Tutor, Chitkara school of Health Sciences,  
Chitkara University, Rajpura  
e-mail: ashishdass852@gmail.com

The contraception alludes to the avoidance of the origination by the utilization of different sexual practices, surgeries, synthetic compounds and medications. The main purpose of seeking contraception is to prevent the women from becoming unwanted pregnancy. That's why it is considered as a contraceptive. Its main aim is to attain privacy and comfort in the physical or sexual relationship. In the society, the couples are allowed to enjoy and fulfill their sexual desires without fear of unwanted pregnancies<sup>4</sup>. (Jain R, 2011).

So couples now a days confronting clashes with objectives of accomplishing fulfilling sexual coexistence and keeping their little family. In the event that individuals neglects to keeping their family little outcomes in undesirable pregnancies and unsafe premature births. On the off chance that the premature birth looking for is late or in unhygienic conditions or in the hands of hazardous suppliers, it can prompt conceptive horribleness just as maternal mortality. (Jain r, 2011).

### Methodology

This study was done in the month of February, 2019 in the Panjab state of India. A sample of 100 (50 Males and 50 Females) participated in this study with the prior permission from the sarpanches of Respective Villages. A Non Experimental Descriptive survey research design in which Males and females aged 20-45 years having one or more children with alertness, oriented and comprehend to respond, speak and understand Hindi, willing to participate and residing in selected rural villages of Rajpura, Punjab were included. Males and Females who were not accessible at the hour of information assortment were prohibited. A Non-Probability Purposive Sampling Technique was owned for data collection from the participants through the medium of Structured Knowledge Questionnaire and Attitude Scale.

#### Description of Tool:

- 1. Selected variables:** The selected variables include Gender, Age, Religion, Type of family, Educational status, Occupation, socio economic class, Number of children, Age at marriage, Married life, Have you ever heard about tubectomy and vasectomy, Source of information about tubectomy and vasectomy.
- 2. Structured Knowledge Questionnaire:** This questionnaire was adopted to assess the level of knowledge of males and females toward stubectomy and vasectomy. It contains 20 multiple choice items

regarding tubectomy and vasectomy covering the content area of:

- Concept and types
- Procedural knowledge
- Assessment
- Post care

Each correct answer was graded with one point score and every incorrect answer was graded as no point. Consequently least score was 00 and greatest score was 20. The calculated Cronbach's Alpha Internal consistency was 0.78 (Adequate range is 0.7-0.9).

- 3. Structured Attitude Rating Scale:** This scale was used to measure the attitude of participants with regard to tubectomy and vasectomy. It consist of total 28 items used to measure the attitude of participants in terms of Strongly Agree, Agree, Uncertain, Disagree and Strongly Disagree and were graded from 1-5.

Out of 28 items, 11 items were positive statements scored as 5,4,3,2,1 while 17 items were negative scored as 1,2,3,4,5.

**Procedure:** In the wake of getting the formal regulatory endorsement, the last investigation was led in the period of April 2018 at chose villages of Rajpura, Punjab. Participants were selected by purposive sampling and information was gathered by utilizing tools of the study. A prior consent was taken from the participants. Earlier data was given to the subjects about the motivation behind the investigation.

#### Data Analysis:

- **Descriptive statistics:** Frequency distribution was issued to show the selected variables.

Correlation Coefficient test was utilized to find out the relationship between knowledge and attitude number score of Males & females towards tubectomy and vasectomy.

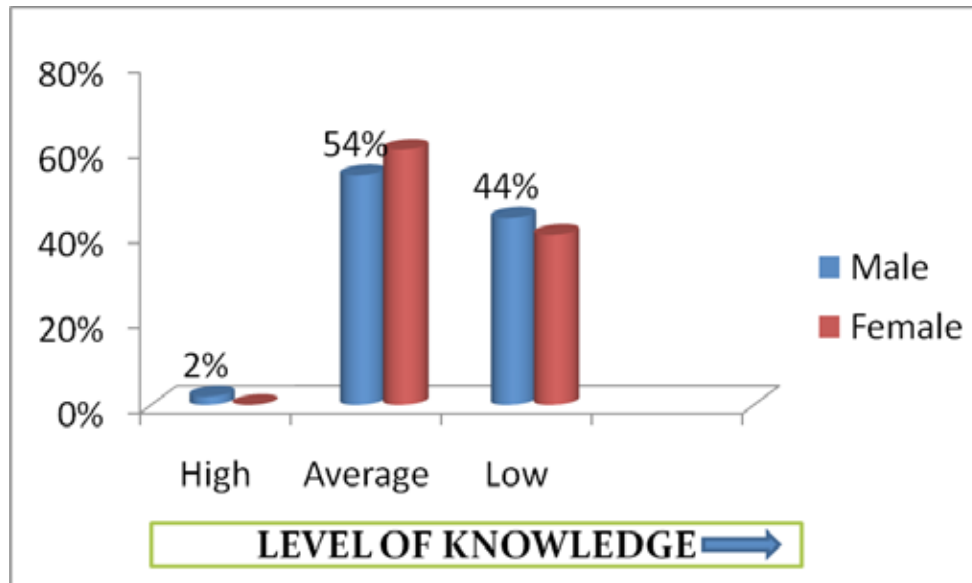
Chi square Test was used to find out the Association of knowledge and attitude score of males and Females towards tubectomy and vasectomy with their selected variables.

### Results

Frequency distribution in terms of level of knowledge score and Attitude scores of participants in

figure 1 and Figure 2 illustrates that further more half of the males 27(54%) had an moderate level of knowledge while 22(44%) of the males had low level of knowledge and only 1(2%) of male had high level of knowledge.

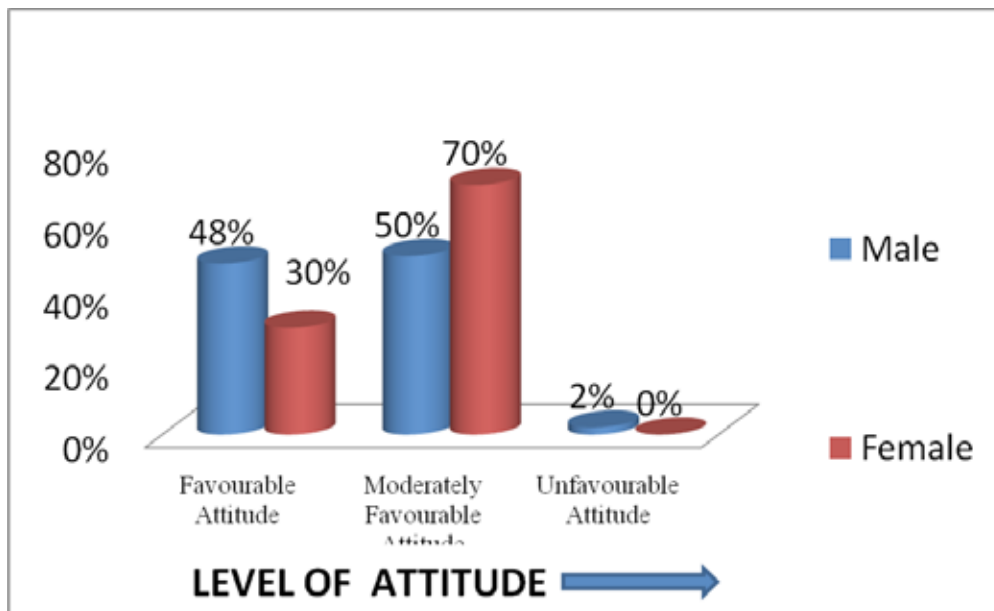
Out of the 50 females, Majority of them 30(60%) had average level of knowledge while 20(40%) had low level of knowledge as shown in figure 1.



**Figure 1: Percentage distribution in terms of level of knowledge among eligible couples towards tubectomy and vasectomy.**

Frequency and percentage distribution in terms of level of attitude of eligible couples towards tubectomy and vasectomy. Out of 50 males, Half of the males 25(50%) had moderately favourable attitude and 24(48%) of the males had favourable attitude while only 1(2%) of the

males had unfavourable attitude towards tubectomy and vasectomy. Out of 50 females, majority of the females 35(70%) had moderately favourable attitude while only 15(30%) of the females had favourable attitude towards tubectomy and vasectomy as shown in figure 2.



**Figure 2: Percentage distribution in terms of level of attitude among males and females towards tubectomy and vasectomy.**

Relationship between the knowledge and attitude scores of participants towards tubectomy and vasectomy in table 5 which shows that r value of males and females were 0.10 and 0.66 respectively which were non

significant at 0.05 level of significance calculated by Co-relational Co-efficient. So there was no relationship between knowledge and attitude of participants towards tubectomy and vasectomy as shown in table 2.

**Table 1: Correlation between the knowledge and attitude of males and females towards tubectomy and vasectomy. N = 100**

Group		Knowledge score r(P value)	Attitude score R(P value)
Knowledge	Males	---	0.10(0.23)
	Females	---	0.66(0.06)

Chi square showing association between level of knowledge and attitude of males and females towards tubectomy and vasectomy. The findings reveals that computed p value of males and females with selected variables of knowledge and attitude found to be not

significant at 0.05 level of significance. This shows there is no association between the level of knowledge and attitude of males and females towards tubectomy and vasectomy as shown in table 3.

**Table 2: Chi square showing association in terms of level of knowledge and attitude of males and females towards tubectomy and vadectomy. N=100**

S.No.	Variables	Males	Females	Chi square (x <sup>2</sup> )	Df	P value
1	Knowledge			1.25	2	0.53 <sup>NS</sup>
	Good	1	0			
	Average	27	30			
	Poor	22	20			
2	Attitude			4.74	2	0.09 <sup>NS</sup>
	Favourable	24	15			
	Moderately favourable	25	35			
	Unfavourable	1	0			

NS = Not Significant (p > 0.05)

### Discussion

In this study, From 50 males 22(44%) of the male’s knowledge was low while more than half of the males knowledge was average i.e. 27(64%) and only 1(2%) of male had high level of knowledge. Out of 50 females, 20(40%) of the females had low level of knowledge while more than half of the females 30(60%) had average level of knowledge and 0(0%) female had high level of knowledge.

In the present study, 24(48%) of the males had favourable attitude and half of the males 25(50%) had moderately favourable attitude while only 1(2%) of the

males had unfavourable attitude. Out of 50 females, less than half of the females 15(30%) had favourable attitude and more than half of the females 35(70%) had moderately favourable attitude and no females had unfavourable attitude. These results were contradictory to the study conducted by<sup>5</sup> **Onasoga, 2013**. The result showed that respondent’s knowledge of at least one type of male family planning method, only 18(13.2%) had higher knowledge level and rest of the participants 33(24.3%) had lower knowledge regarding vasectomy. Most of the respondent also showed negative attitude towards vasectomy<sup>5</sup>.

The mean knowledge score of males was 7.76+2.33 with obtained range of 2-13 and the mean knowledge score with standard deviation of females was also 7.76+2.33; median was 8 with obtained range of 2-13 whereas the mean attitude score of males was 96.26+12.71; median was 96.50 with obtained range of 73-125 and the mean attitude score of females was 97.6+ 12.49; median was 97.50 with obtained range of 76-125. These findings were contradictory to the results of the study by **Gayathry, D., 2014** who observed that females had higher scores as compared to males which was not significant between the overall knowledge score (18.67+7.798 vs. 18.41+7.177)<sup>6</sup>.

In the present study, the computed p values of knowledge scores of the males with their selected variables were not significant except education i.e p-value 0.02 and occupation i.e p-value 0.01 which were highly significant. Hence knowledge of males towards tubectomy and vasectomy was dependent on educational status and occupation.

In this study, the computed p values of attitude scores of males with their demographic variables were non significant except Educational status i.e p value 0.00, occupation i.e p value 0.02, No. of children i.e p value 0.05, age at marriage i.e p value 0.03 which were highly significant at the 0.05 level of significance and computed p-value of females with all demographic variables were non significant at 0.05 level of significance. The findings are partially matches with the study conducted by **Onasoga, 2013**. The findings reveals that there was no significant association of academic scores of respondents and their attitude towards vasectomy, as well as between marital status and their attitude towards vasectomy significant association was found between the level of knowledge and attitude towards vasectomy<sup>5</sup>.

In the present study, computed p value of males and females with selected variables of knowledge and attitude was non significant at 0.05 level of significance. This shows there is no association between the level of knowledge and attitude of males and females towards tubectomy and vasectomy.

**Ethical Approval:** The moral leeway was gotten by taking consent from Sarpanch of Respective villages to direct the investigation in the rustic zones. The assent from the qualified Couples was gathered preceding the examination. The reason for doing research venture was clarified and affirmation of privacy was given to the members.

## References

1. Taneja P, Jha S. Contraception needs and its usage amongst rural women of India. *Journal of Evolution of Medical and Dental Sciences*. 2014 Dec 1;3(66):14292-300.
2. Etuk SJ, Ekanem AD. Knowledge, attitude and practice of family planning amongst women with unplanned pregnancy in Calabar-Nigeria. *Nigerian Journal of Physiological sciences*. 2003;18(1):65-71.
3. Reddy R, Premarajan KC, Narayan KA, Mishra AK. Rapid appraisal of knowledge, attitude and practices related to family planning method among men within 5 years of married life. *Indian J Prev Soc Med*. 2003 Jan;34(1):63-7.
4. Jain R, Muralidhar S. Contraceptive method: needs, options and utilization. *The Journal of Obstetrics and Gynecology of India*. 2011 Dec 1;61(6):626-34.
5. Onasoga OA, Edoni E, Ekanem J. Knowledge and attitude of men towards vasectomy as a family planning method in Edo State, Nigeria. *J Res Nurs Midwifery*. 2013;2(1):13-21.
6. Gayathry D, Ramana BV, Rao V. A study on assessment of knowledge towards family planning practices among the couples of reproductive age group in the field practice area of Prathima institute of medical sciences, Karimnagar. *International Journal of Community Medicine and Public Health*. 2017 Oct;4(10):3740.

# Nursing Intervention for Caregivers of Post Autologous Bone Marrow Transplantation Patients at Home

Asmaa Farouk Mohamed<sup>1</sup>, Nawal Soliman<sup>2</sup>, Hemat Abd-El-Moneem El-Sayied<sup>2</sup>, Asmaa Talaat<sup>3</sup>

<sup>1</sup>M.Sc.N., Community Health Nursing, <sup>2</sup>Professors of Community Health Nursing, <sup>3</sup>Lecturer of Community Health Nursing, Faculty of Nursing-Ain Shams University, Cairo, Egypt

## Abstract

**Background:** Autologous bone marrow transplantation is a curative procedure for hematological diseases and immune deficiencies. The unique and intensive nature of this treatment requires distinctive care during and post the entire transplant course. Nursing intervention for caregivers post autologous bone marrow transplantation patients at home is an important component of the care that improves and develops knowledge and practice of the caregivers, to take care of the patients in order to help them follow the demanding treatment plan to reach recovery.

**Aim to** evaluate the effect of nursing intervention for caregivers of post-autologous bone marrow transplantation patients at home.

**Material and Method:** A Quasi-experimental study was carried out among convenient sample of 143 patients and their caregivers who attended the follow up clinic during the first six months post autologous bone marrow transplantation. The study was conducted among patients and their caregivers in three different hospitals Sheikh Zayed Specialized Hospital, National oncology institute, and Nasser institute at outpatient's follow-up clinics. A self-administered questionnaire of patients and their caregivers' demographic data, and reported checklist of caregivers' knowledge and practices toward post-autologous bone marrow transplantation patients at home.

**Results:** There was a statistically significant difference between pre and post nursing intervention, which indicate improvement in caregivers' knowledge and practice post implementation of the nursing intervention program, and positive correlation between their knowledge and practice.

**Conclusion and Recommendations:** Although caregivers had adequate knowledge, practice on some aspects, gaps were identified. There is a need for educational interventions and discharge plan to upgrade knowledge and practices of the caregivers of post autologous bone marrow transplantation patient at home.

**Keywords:** *Autologous bone marrow transplantation, caregivers, nursing intervention, home.*

## Introduction

Since the onset and progression of bone marrow transplantation it was evident from the 1950s to early 1960s that nurses play an important role within the multi professional team caring for patients and their families go through this treatment.<sup>1</sup> Bone marrow transplant is an umbrella term for the grouping of a variety of procedures. These transplants use stem cells from bone marrow, peripheral blood or cord blood and more recently the procedure has been called haemopoietic

stem cell transplantation (HSCT) The type of treatment is then classified based on the origin of the stem cells, autologous being derived from the recipient himself.<sup>2</sup>

The family does need support, and need pre- and post-HSCT education and psychosocial intervention,. All stages of the transplant process will affect family members. The effect of this severe medical procedure will clearly extend beyond the person concerned to the entire family network.<sup>3</sup> In the post-transplant duration, it is important to have a distinct pattern of evaluation

to assess disease condition and for any post-transplant complications.<sup>4</sup> Increasing caregivers' confidence and competence require training in the skills they need to provide care to the patient. Past studies have repetitively shown that caregivers often express attentiveness in, and have a need for education and support programs.<sup>5</sup>

The population of Egypt exceeded 100 million in 2020. There are fifteen transplant centers and the transplant rate is 8.4 million. Bone marrow transplantation in Egypt began on a restricted scale in 1989. In 1997, the rate of transplantation increased significantly.<sup>6</sup> Specific attention has developed towards educating the long-term survivors and their caregivers in which nursing intervention plays a significant role because medical treatment activities are more in the background and day-to-day questions have to be dealt with.<sup>1</sup>

**Research Hypothesis:** The nursing intervention program will improve the caregivers' level of knowledge and practices in caring of post Autologous Bone Marrow Transplantation Patients at Home.

## Materials and Method

A quasi-experimental study was carried out among 143 patients and their caregivers at outpatient follow-up clinics in three biggest hospitals in Cairo, Egypt for autologous bone marrow transplantation patients, Sheikh Zayed Specialized Hospital, National Oncology Institute, and Nasser Institute. An official written letter including the title and purpose of the study obtained from the dean of Faculty of Nursing, Ain Shams University to get the approval form directors of the mention hospitals to conduct the study. A consent was obtained from each participant (patient and caregiver).

The 143 (patients and caregivers) were divided into 6 groups. The actual process of data collection was carried out in the period from February 2019 to July 2019. The intervention program consisted of 17 hours (5 hours theoretical, 12 hours practical). Educational media were used such as poster, PowerPoint, laptop, handout Arabic booklet, videos.

The tool was developed by the researcher, based on reviewing related literatures and experts' opinions, written in Arabic language, and Completed under supervision of the researcher through group interview. A self-administered questionnaire of patients and their caregivers' demographic data includes 10 questions. Self-Reported checklist of caregivers' practices and

knowledge toward post autologous bone marrow transplantation patients at home. Caregivers' Knowledge consisted of 15 questions with Cronbach's value 0.78.

Answers were coded as follow: poor = 1, good = 2. Caregivers' practices consisted of 90 questions including:- patient transfer, Central venous catheter care, Meals preparation and diet restrictions, Personal hygiene, Medication administration, and Following Infection control. With Cronbach's value 0.76.

The total score was divided into two scale: Poor > 60% Good  $\geq$  60%.

The collected data were organized; tabulated and analyzed using software, the appropriate statistical tests was the Statistical Package for Social Science SPSS (version 25). The statistical analysis includes; percentage (%), Chi-Square test ( $X^2$ ), Proportion probability P value.

### Significance of results was described as follows:

- Not-significant difference obtained at  $p > 0.05$ .
- Significant difference obtained at  $p < 0.05$ .

Evaluation the level of improvement in caregivers' knowledge, practice, was done by giving post-test similar to pre-test. Evaluation was administered to the caregivers after completion of the program in order to estimate the effect of the program on the caregivers, and recognize the benefit of the program and what are the ways of obstacles to lack of implementation.

## Results

Table (1) shows that, the median and range of age of the studied patients was 48 (21-50) years, in relation to gender, 53.1% were males, and 67.1% were married, while 58% had 3-4 children, as regards educational level 42% of them had university education. Concerning occupation, 37.8% were employees, with 70.6% had sufficient monthly income.

**Regarding the caregivers:** Illustrates that, the median and range of age of the studied caregivers was 47 (18-60) years. 68.5% of the caregivers were females. Regarding Kin-relation with the patient 30.8% were spouse. Related to educational level 41.9 % of the studied sample were secondary education. In relation to the marital status, 41.9% were married, Concerning of job 34.3% were employees, and 76.9% of time of care were full time.

**Figure (1)** displays that, pre interventional program good knowledge and practice was 27.2%, 36.4%, respectively, while post implementation of an interventional program good knowledge and practice was 87.5%, 89.3% respectively.

**Table (2)** Clarifies there was statistical significant relation between pre and post of total caregivers' demographic characteristics (age, gender, educational level, occupation, time of care) and total caregivers' knowledge and practice score. However marital status, kin-relation, shows no significant effects on caregivers' knowledge and practice.

**Table (3)** Illustrates that there was statistical significant positive correlation between pre & post-test of total caregivers' knowledge and practices at  $P < 0.001$ .

**Table (1): Distribution of the patients and their caregivers according to their demographic characteristics (n=143).**

Demographic characteristics	Patients	Caregivers
	N (%)	N (%)
Median age, yrs. (range)	48 (21-50)	47 (18-60)
<b>Gender:</b>		
Male	76 (53.1)	45 (31.5)
Female	67 (46.9)	98 (68.5)
<b>Marital status</b>		
Single	19 (13.3)	28 (19.6)
Married	96 (67.1)	60 (41.9)
Divorced	12 (8.4)	29 (20.3)
Widow	16 (11.2)	26 (18.2)

Demographic characteristics	Patients	Caregivers
	N (%)	N (%)
<b>Number of children</b>		
Non	21 (14.7)	
1-2	34 (23.8)	
3 – 4	83 (58.0)	
≤ 5	5 (3.5)	
<b>Educational level:</b>		
Does not Read or write	7 (4.9)	7 (4.9)
Read & write	3 (2.1)	6 (4.2)
Primary	19 (13.3)	42 (29.4) 60 (41.9)
Secondary	54 (37.7)	
University	60 (42.0)	28 (19.6)
<b>Occupation</b>		
Jobless	14 (9.8)	21 (14.7)
Employee	87 (60.8)	88 (61.5)
Housewife	42 (29.4)	34 (23.8)
<b>Monthly income</b>		
Sufficient	101 (70.6)	
Not sufficient	42 (29.4)	
<b>Kin-relation</b>		
Parent		22 (15.4)
Spouse		44 (30.8)
Children		33 (23.0)
Brother		2 (1.4)
Sister		19 (13.3)
Relatives		9 (6.3)
Friend		8 (5.6)
Paid- caregiver		6 (4.2)
<b>Time of care</b>		
Full time		110 (76.9)
Part time		33 (23.1)



**Figure (1): Distribution of total caregivers' knowledge and practice total score level regarding pre and post nursing intervention (n=143).**



**Table (2): Relation between caregivers’ demographic characteristics and total caregivers’ knowledge and practice score level pre & post interventional program (n = 143).**

Caregivers’ demographic characteristics	Total caregivers’ knowledge				Total caregivers’ practices			
	Pre-test		Post-test		Pre-test		Post-test	
	X2	P	X2	P	X2	P	X2	P
Age	82.500	0.000	89.277	0.000	123.779	0.001	80.920	0.001
Gender	116.783	0.000	9.456	0.001	69.205	0.000	11.303	0.001
Marital status	2.228	0.136	2.145	0.143	2.168	0.141	1.597	0.206
Educational level	124.415	0.000	31.069	0.000	105.187	0.000	94.024	0.000
Occupation	123.779	0.001	80.920	0.001	74.465	0.001	104.485	0.001
Kin-relation	0.509	0.476	0.901	0.088	0.653	0.419	1.293	0.255
Time of care	105.187	0.000	94.024	0.000	33.784	0.001	65.534	0.001

Not Significant P > 0.05 Significant P < 0.05

**Table (3): Correlation between caregivers’ knowledge and practices pre & post training program (n=143).**

Item	Total caregivers’ practice			
	Pre-test		Post-test	
	R	P	R	P
Total caregivers’ knowledge	0.870	0.000	0.915	0.000

**Discussion**

The current study illustrated that **Table (1)** the median and range of age of the studied patients was 48 (21-50) years, in relation to gender, around half of the patients were males, and about two third were married, while more than half had 3-4 children, as regards educational level less than half of them had university education. Concerning occupation, almost one third were employees, with more than two third had sufficient monthly income. This study was in agreement with previous studies.<sup>7,8</sup>

Regarding the caregivers Illustrates that, the median and rang of age of the studied caregivers was 47 (18-60)years. More than two third of the caregivers were females. Regarding Kin-relation with the patient less than one third were spouse. Related to educational level below than half of the studied sample were secondary education. In relation to the marital status, less than half were married, Concerning of job almost one third were employees, and more than three quarter of time of care were full time. This study was in the consistent with previous studies.<sup>7,9,10</sup> Similar findings also were reported in the studies conducted in USA. Becoming a caregiver

was a second full-time occupation, as caregiving had become the priority in their lifetime.<sup>11</sup>

But another earlier study was in contrast to the current study, claiming that young caregivers typically have to juggle jobs, their own family commitments, middle-aged caregivers usually worry about missing workdays. Interruptions in work absence leave and reduced productivity. In addition to, limited income can place families at risk of care for non-compliance or of treatment related decision on the basis of income.<sup>12</sup>

Regarding caregivers’ knowledge and practice **Figure (1)** displays that, most of the caregivers had good knowledge, and majority of them had good practice post-interventional program, indicating that the caregivers improved in their knowledge and practice after application of nursing interventional program. This could be because they got benefit of the program, and education outcomes. The level of good knowledge and practice were lower in pre-interventional program as mentioned in early study that Family caregivers often feel unprepared, have inadequate knowledge, and receive little guidance from the transplant team. Beside education should pass expertise, skills and

details. Successful delivery of education is a dynamic process that depends on sufficient timing. The primary outcome identified in the majority of health education. Respondents show increased health awareness and make healthier decisions about their patients' health following intervention. So good education also increases patient/caregiver self-efficacy, reduces anxiety by planning for transplantation, and increase the satisfaction of the patient. More long-term education results might include improvement in survival and transplantation morbidity, accessibility of health care, willingness of patients/caregivers to return to work, and quality of life.<sup>12,13</sup> other study revealed that the preparation of family caregivers for their position must include clear education, including skills training. Preparing caregivers should be an ongoing process such that benefits are maintained and education programmes develop as required.<sup>14</sup>

Concerning caregivers' demography **Table (2)** Clarifies there was statistical significant relation between pre and post of total caregivers' demographic characteristics (age, gender, educational level, occupation, time of care) and total caregivers' knowledge and practice score level. However marital status, kin-relation, shows no significant effects on caregivers' knowledge and practice. The finding was supported by other study conducted in USA Indicating that the caregiver does not necessarily discuss the gender position of the participants. This can be explained at least in part by the fact that the majority of caregivers are women, that caregivers themselves are viewed as a woman's position, and that male caregivers make less use of resources, including support groups, than women do.<sup>5</sup>

The same results were observed in early studies that educational and training needs would flow over time, driven by complex processes that characterize adult and family life trajectories. Only a few States provide financial aid to family members who perform the position of caregivers. Therefore, to give full-time care, caregiver has to leave the workforce to support the loved ones. Currently, the Health Care Management System offers some assistance to spouses who perform the function of caregivers.<sup>5,13</sup> With regard to time of treatment. In addition, there were statistically significant differences between the pre-and post-intervention programme, the current research in the same line of the previous study showed that full-time caregivers offer more support and can apply the information acquired by the caregiver from the programme.<sup>14</sup>

There were no major variations in marital status, the relationship of caregivers and their expertise and experience in the current research. The findings show that, in accordance with the previous studies. It reported that there was no significant relation between marital status, and kin-relation of caregivers and their knowledge and practice. This may be due to the nature of the intimate relationship between the caregiver and the patient. It did not rely on the relationship. However, depending on the nature of the relationship between the patient and the caregiver, it could possibly lead to a complicated situation of caregiving that could affect the delivery of care, but did not influence awareness.<sup>5,9,13</sup>

Finally **Table (3)** Illustrates that there was strong positive correlation between pre & post-test of total caregivers' knowledge and practices, the caregivers' total knowledge score was positively associated with the total practice score toward post autologous bone marrow transplantation patients at home. The higher the knowledge, the higher the practice, in which this shows that caregivers' practice is directly related to their knowledge as reported in the previous study<sup>12,13</sup> In the most recent sense, a similar study was performed in the United States, which determined that there is a substantial association between the degree of education of caregivers and their practice in post-autologous bone marrow transplantation patients. Improved awareness and/or willingness to offer treatment to United States.<sup>12</sup> In other previous study mentioned that Role preparedness has been studied in terms of how the development of knowledge and skills might protect the caregiver from role distress when the difficulty of care or the need for care is high.<sup>9</sup>

## Conclusion

Based on the results of the current study and research hypothesis; implementation of nursing intervention program improved the knowledge and practices of the caregivers of postautologous bone marrow transplantation patients at home, there was statistically significant differences between pre/post-nursing intervention post autologous bone marrow transplantation regarding caregivers' knowledge, practice. In addition, there was statistically significant relations between caregivers' demographic characteristics and total score level of caregivers' knowledge and practice in some parts, beside there was positive correlation between pre & post-test of total caregivers' knowledge and practices score level. Further research with a larger sample of caregivers

from other governorates in Egypt are required in order to have a better understanding the needs of caregivers' knowledge and practices post autologous bone marrow transplantation patient at home.

**Conflict of Interest:** Nil

**Source of Funding:** Nil

**Ethical Clearance:** Obtained

### References

1. Kenyon MI, Babic AL; Fliedner MC. The European Blood and Marrow Transplantation Textbook for Nurses. Under the Auspices of EBMT. Switzerland: Springer International Publishing; 2018. P XIII – XVI. <https://doi.org/10.1007/978-3-319-50026-3>
2. Cutler TJ, Brown M. Haematology Nursing. UK: WILEY-BLACKWELL Publisher; 2012. P. 287.
3. Yong L. A Family Perspective on a Program for Bone Marrow Transplantation of Adults (Family Impact Analysis Series). Madison, WI: Policy Institute for Family Impact Seminars; 2003. P. 1.
4. Yarbro HC, Wujcik D, Gobel HB. Cancer Nursing, PRINCIPLES AND PRACTICE. Canada: Jones and Bartlett Publishers; 2011. P. 511.
5. Toseland WR, Haigler HD, Monahan JD. Education and Support Programs for Caregivers. Caregiving: Research, Practice, Policy. New York: Springer Publisher; 2011. P. 13-15.
6. Mahmoud HK, Fathy GM, Elhaddad A, Fahmy OA, Abdel-Mooti M, Abdelfattah R et al.: Hematopoietic Stem Cell Transplantation in Egypt: Challenges and Opportunities. Mediterranean Journal of Hematology and Infectious Diseases 2020, 12(1): e2020023:1-7 DOI: <http://dx.doi.org/10.4084/MJHID.2020.023>
- 7] J amani K, Onstad EL, Bar M, Carpenter AP, Krakow FE, Salit BR et al.: Quality of Life of Caregivers of Hematopoietic Cell Transplant Recipients. ELSEVIER. Biology Blood Marrow Transplant 24(2018)2271-2276.
8. Barban A, Coracin L, Musqueira P, Barban A, Ruiz L, Ruiz M. Analysis of the feasibility of early hospital discharge after autologous hematopoietic stem cell transplantation and the implications to nursing care. Revista Brasileira de Hematologia e Hemoterapia. Brazilian Journal of Hematology and Hemotherapy. ELSEVIER. Rev Bras Hematol Hemoter. 2014;36(4):264–268
9. Gemmill R, cooke L, William CA, Grant M: Informal Caregivers of Hematopoietic Cell Transplant Patients: A Review and Recommendations for Interventions and Research. Cancer Nurs. 2011 November; 34(6): E13–E21.1-15 doi:10.1097/NCC.0b013e31820a592d.
10. Von D, Spath M, Nielsen, Fife B: The Caregiver's Role Across the Bone Marrow Transplantation Trajectory. Wolters Kluwer Health 2015; 1-9 DOI: 10.1097/NCC.0000000000000242.
11. LeSeure P, Chongkham-ang S: The Experience of Caregivers Living with Cancer Patients: A Systematic Review and Meta-Synthesis. J. Pers. Med. 2015, 5, 406-439; doi:10.3390/jpm5040406.
12. National Cancer Institute (NCI): Informal Caregivers in Cancer: Roles, Burden, and Support (PDQ®): Supportive care - Health Professional Information [NCI]. <https://www.uwhealth.org/health/topic/nci/family-caregivers-in-cancer-roles-and-challenges-pdq-supportive-care-health-professional-information-nci/ncicdr0000681705.html>
13. Schoemans M, Finn L, Foster J, Roche-Green A, Bevens M, Kullberg Setal. A Conceptual Framework and Key Research Questions in Educational Needs of Blood and Marrow Transplantation Patients, Caregivers, and Families. Biology Blood Marrow Transplant 2019;25: 1416\_1423.
14. Berry L, Jacobson J. Supporting the Supporters: What Family Caregivers Need to Care for a Loved One With Cancer. Journal of Oncology Practice DOI: 10.1200/JOP.2016.017913; published online ahead of print at [ascopubs.org/journal/jop](http://ascopubs.org/journal/jop) on December 20, 2016; 35-41.

# Psychological Problems among the Health Workers During Pandemic Covid-19

Astabrak A. N. Al-Hamoodi<sup>1</sup>, Burhan Hadi<sup>2</sup>, Kafi Mohammad Nasir Al Asadi<sup>3</sup>

<sup>1</sup> *Asst. Lect., Master in Mental and Psychological Health, University of Kufa-College of Nursin*, <sup>2</sup> *Asst. Lect., Master in Mental and Psychological Healthm Altoosi University College*, <sup>3</sup> *Prof., Ph.D. Community Health in Nursing Department, Altoosi University College, Iraq*

## Abstract

The COVID-19 is a globally problem influences in all function of life, from health to economic and political of countries. It is still to elevated in incidence and killed people specially among health workers. The study aimed to assess the psychological problems among health workers who work in health facilities at Babylon Province.

Descriptive-analytic study conducted during the era of COVI-19 by using online GHQ-12 items as instrument to measure the symptoms of psychological problems. Convenience sample included 220 health workers participated in the study. The study revealed elevated in psychological problems among health workers and found significant relationship between gender and psychological problems. The study concluded to the support and available the enough training and medical health equipment may be reduced it.

**Keyword:** *Psychological problems, health workers, pandemic Covid-19.*

## Introduction

The COVID-19 is a global outbreak is a highly contagious and it is main cause of respiratory illness.<sup>[1]</sup> It is a viral infection recognized by fever, shortness of breath, cough and chest infection.<sup>[2]</sup> First detect to it in Wuhan, China<sup>[3]</sup>, and rapidly spread in all world yet<sup>[1]</sup>. But COVID-19 is becoming an increasing public event being a rapid epidemic<sup>[4]</sup>. The World Health Organization states in the official website (March, 2020), there is 100,000 person and more are diagnosed with COVID-19 infection around of world<sup>[5]</sup>. So that any person can be affected emotionally and exposure to psychological problems symptoms during of the COVID-19 now. Most communities and people had overwhelming feelings of fear, stress and anxiety about a COVID-19 disease

<sup>[6]</sup>, but there is evidence reported to proof the health workers are effected by the psychological problems after the COVID-19 reach to the maximum point such as stress, anxiety, insomnia and other health problems. <sup>[7]</sup> Everyone responds to stressful circumstances and reacts differently according to experiences, abilities to adapted with it and how coping with emotional distress <sup>[8]</sup> due to the highly risks of exposure or ethical dilemma and stress of workload and work hours <sup>[9,10, 11]</sup>.

Sadly, some healthcare workers can face rejection because of stigma or fear by their families or friends, so it may be make them which is a victim and increased the psychological problems on them <sup>[12]</sup>.

The study goals to assess the symptoms of psychological problems among the health workers during pandemic Covid-19 at Babylon Province and find out the relationship between their characteristics and the symptoms of psychological problems among them .

---

## Corresponding Author:

**Astabrak A. N. Al-Hamoodi**

Asst. Lect., Master Degree in Mental and Psychological Health, University of Kufa-College of Nursing  
e-mail: astabrka.alhamoody@uokufa.edu.iq

## Material and Method

The descriptive-analytic study design conducted at A Nonprobability convenience sample was conducted in

Babylon Province during the era pandemic Covid-19 in world generally and in Iraq especially from 20 March to 5th April 2020 by using Google samples forms online to self-reported questionnaire distributed on 220 participants (57 female and 163 male) from general health workers (24500) were work in all health care facilities in Babylon Province (see table (1)). After get consent to participated in study. The study sample is a non-probability convenience sample, included participants from all governmental health facilities of Babylon Province weather worked in isolated facilities of COVID-19 or in another governmental health facilities.

The study questionnaire had two parts. Part one related to demographic characteristics of health workers like age, gender, experiences duration with contagious diseases, level education, marital status. Part two related

to General Health questionnaire (GHQ12-items) to explore the psychological problems in health workers who are not have psychological problems by self-reported. The questionnaire is translated and use in Al-Hamoodi study (2019)<sup>[13]</sup> and before him it used for first time by Goldberg (1970) was use GHQ to assess psychological well-being. It has four scores (0-3) begin from much less than usual to better than usual. It has cutoff point 1.5, when a person had  $\geq 1.5$  that mean had psychological distress. This scale is a common used in primary health care setting.

The researchers are used descriptive statistics to describe the results of data and determine the achievements of the study goals or not by using computer programs (SPSS v.17 and Microsoft Office Excel (2010)) to reveal the results.

## Results

**Table (1): Total number of health workers in the health facilities at Babylon Province**

	Total number of nurses only	Total number of other health workers	Total
All governmental health workers at pandemic COVID-19	12450	12050	24500
<b>Total</b>	<b>12450</b>	<b>12050</b>	<b>24500</b>

**Table 2. Demographic characteristics of governmental health workers in health facilities at Babylon Province**

		N = 220	
		Frequency	Percent
Gender	Male	163	74.1
	Female	57	25.9
Age groups	$\leq 30$ yrs	151	68.6
	30 - 45	56	25.5
	More than 45 yrs	13	5.9
Level education	Post Graduate	21	9.5
	College Graduate	97	44.1
	Institute Graduate	85	38.6
	Secondary School	17	7.7
Specialty of health workers	Medicine	35	15.9
	Nursing	106	48.2
	Other health workers	63	28.6
	Support health workers	16	7.3
<b>Total</b>		<b>220</b>	<b>100</b>

**Table 3. Social and duration of experiences of health workers at era of COVID-19 pandemic in health facilities at Babylon Province.**

		N = 220	
		Frequency	Percent
Marital status	Married	144	65.5
	Separated	2	0.9
	Single	73	33.2
	Widow	1	0.5
Number of children	Not had children	112	50.9
	1-2 child	62	28.2
	3-4 child	33	15.5
	More than 5	13	5.9
Place job	Health sector	17	7.7
	Hospital	176	80
	Center of health office	14	6.4
	Special centers	8	3.6
	Voluntary work	5	2.3
Previous Skills with endemic Diseases	Not worked previously	185	84.1
	< 1 month	6	2.7
	1-6 months	14	6.4
	6-12 months	2	0.9
	1-5 yrs	9	4.1
	>5 yrs	4	1.8
Worked in Isolated units previously	Not worked previously	193	87.7
	< 1 month	6	2.7
	1-6 months	20	9.1
	>5 yrs	1	0.5
Worked in Isolated units Now	Not worked previously	194	88.2
	< 1 month	7	3.2
	1-6 months	19	8.6
Total		38	100.0

**Table 4. Level of General Mental Health of governmental health workers in health facilities at Babylon Province**

No.	Items	Ratings	(N = 220)		M.	S.D.
			F.	%		
1.	Been able to concentrate on what you're doing?	- Better than usual	42	19.1	2.97	0.68
		- Same as usual	134	6.9		
		- Less than usual	39	17.7		
		- Much less than usual	5	2.3		

No.	Items	Ratings	(N = 220)		M.	S.D.
			F.	%		
2.	Lost much sleep over worry?	- Not at all	0	0	2.47	1.24
		- No more than usual	86	39.1		
		- Rather more than usual	79	35.9		
		- Much more than usual	55	25		
3.	Felt you were playing a useful part in things?	- More than usual	40	18.2	3.03	0.61
		- Same as usual	150	68.2		
		- Less than usual	26	11.8		
		- Much less than usual	4	1.8		
4.	Felt capable of making decisions about things?	- More than usual	50	22.7	3	0.73
		- Same as usual	128	58.2		
		- Less than usual	34	15.5		
		- Much less than usual	8	3.6		
5.	Felt constantly under strain?	- Not at all	0	0	2.91	1.22
		- No more than usual	58	26.4		
		- Rather more than usual	65	29.5		
		- Much more than usual	97	44.1		
	Been able to concentrate on what you're doing?	- Better than usual	1	0.5	2.5	0.52
		- Same as usual	110	50		
		- Less than usual	108	49		
		- Much less than usual	1	0.5		
	Lost much sleep over worry?	- Not at all	11	5	3	0.8
		- No more than usual	37	16.8		
		- Rather more than usual	113	51.4		
		- Much more than usual	59	26.8		
	Felt you were playing a useful part in things?	- More than usual	58	26.4	2.4	1.28
		- Same as usual	67	30.5		
		- Less than usual	0	0		
		- Much less than usual	95	43.2		
	Felt capable of making decisions about things?	- More than usual	19	8.6	1.67	1.07
		- Same as usual	45	20.5		
		- Less than usual	0	0		
		- Much less than usual	156	70.9		
	Felt constantly under strain?	- Not at all	176	80	1.49	1.01
		- No more than usual	0	0		
		- Rather more than usual	24	10.9		
		- Much more than usual	20	9.1		
	Felt you couldn't overcome your difficulties?	- Not at all	65	29.5	2.58	1.09
		- No more than usual	118	53.6		
		- Rather more than usual	0	0		
		- Much more than usual	37	16.8		

**Table 5. Overall Psychological Well-being among governmental health workers in health facilities at Babylon Province**

Psychological well-being G.H.Q	(N = 220)	
	F.	%
No Psychological Distress	111	50.5
Psychological Distress	109	49.5
<b>Total</b>	<b>220</b>	<b>100.0</b>

The table revealed (50.5 %) was have psychological distress (49.5 %) were have psychological distress.

**Table (6): The relationship between Overall Psychological Well-being (GHQ) and Demographic Characteristics of governmental health workers in health facilities at Babylon Province**

(N = 220)	Demographic characteristics	Overall Psychological Well-being		Chi-Square tests		
		Less than usual	Same as usual	Value	df	Sig.
Gender	Male	87	76	3.689	1	.05
	female	22	35			
Age groups	<= 30 yrs	75	76	2.197	2	.33
	30- 45 yrs	30	26			
	>45 yrs	4	9			
Marital status	Married	71	73	3.133	3	.37
	Separated	0	2			
	Single	38	35			
	Widow	0	1			
Education level	College	44	53	4.055	3	.26
	Institute	46	39			
	Post Graduate	13	8			
	Secondary School	6	11			
Place Job	Health Sector	10	7	1.202	4	.88
	Hospital	85	91			
	Office of Health	8	6			
	Specialty center	4	4			
	Voluntary Work	2	3			
Specialty	Medicine	21	14	1.864	3	.61
	Nursing	50	56			
	Other Health Workers	30	33			
	Support Health Workers	8	8			
Privious Skills with endemic Disease by month	Not has worked previousely	94	91	2.840	5	.72
	< 1 month	4	2			
	1-6 months	5	9			
	6-12 months	1	1			
	1-5 yrs	3	6			
	>5 yrs	2	2			



(N = 220)	Demographic characteristics	Overall Psychological Well-being		Chi-Square tests		
		Less than usual	Same as usual	Value	df	Sig.
Worked in Isolated units previously	Not has worked previousely	97	96	1.787	3	.61
	< 1 month	3	3			
	1-6 months	8	12			
	>5 yrs	1	0			

## Discussion

Most of health workers are participated in study are males (74%) and their aged less than 30 years old (68%) and had bachelor degree (44%) (table 2). About (65%) of participants are married and not had child (50.1%) and they are not worked previously in isolated places or practical skills with epidemic diseases (84%) (table (3)). In table (4) revealed the Level of general mental health of participants in the study according the items of general health questionnaire (GHQ-12 items) who work in health facilities at Babylon Province, but generally, half health workers are participated in study had highly incidence levels of psychological problems during the COVID-19 virus (table 5). Therefore, these result considered as a risk indicator if it is not treated and can be increased among them. These result consent with result of Zhang study (2020)<sup>[1]</sup>. These the problems had a significant complication and impairment in social and occupational functioning; and feeling overwhelmed by the demands of everyday life on them<sup>[5]</sup>. The reasons for the psychological problems may be attributed to the many factors such as the initially inadequate awareness about COVID-19 and knowledge about how prevent it and control, as well as long-term of workload, and lack the medical protective equipment. In table (6) the researchers find significant relationship between the psychological problems and gender of health workers<sup>[8]</sup> may due to the nature of male from female by how adopting and coping with the stress and events.

The researchers concluded to increase in psychiatric problems among health workers and may be elevated if it is not treated correctly. Decrease stigma, encouragement and training about how to reduce and faces stresses are very important. Finally, the support and available the medical equipment is important items to decrease the psychological problems on them.

**Financial Disclosure:** There is no financial disclosure.

**Conflict of Interest:** None to declare.

**Ethical Clearance:** After the administrative arrangements are completed, acceptance of health workers participants was sought for after explaining to them the aim of the study and inform them that all the information taken will be treated confidentially and it is for research purposes only, then taken the consent from them to participate in this study. Also, an ethical approval was obtained from ethical committee of research in Faculty of Nursing University of Kufa regarding confidentiality and anonymity of participants.

## References

- Zhang W, Wang k, Yin L, Zhao W, Xue Q., Peng M, Min B, Tian Q, Leng H, Du J, Chang H, Yang Y, Li W, Shangguan F, Yan T, Dong H. Mental Health and Psychosocial Problems of Medical Health Workers during the COVID-19 Epidemic in China, *PsychotherPsychosom*, Published online: April 9, 2020; 2-12.
- Mishriky R S, and JishiA S. Mental Health Tool Kit, Johns Hopkins Aramco Health Care, 2020; 1(2).
- Li Q, Guan X, Wu P, Wang X, Zhou L, Tong Y, et al. Early transmission dynamics in Wuhan, China, of novel coronavirus-infected pneumonia, *N Engl J Med*, 2020mar; 382(13): 1199–1207.
- Day M. Covid-19: surge in cases in Italy and South Korea makes pandemic look more likely. *BMJ*, 2020, Feb; 368: 751.
- World Health Organization [Internet]. Geneva: WHO statement on cases of COVID-19 surpassing 100 000, 2020, March 7; <https://www.who.int/newsroom/detail/07-03-2020-who-statement-oncase-of-covid-19-surpassing-100-00>.
- Maryland Department of Health: Coronavirus Disease 2019 (COVID-19): Frequently Asked Questions About Mental Health, Updated June 5, 2020.
- Jansson M, Rello j. Mental Health in Healthcare Workers and the Covid-19 Pandemic Era: Novel

- Challenge for Critical Care, *Journal of Intensive and Critical Care*, 2020; 6(2:6), DOI: 10.36648/2471-8505.6.2.6
8. Guidelines COVID-19 Management: mental health and psychosocial support in covid-19, 2020 Updated On (24 March 2020); No.5.
  9. Moghbelli H, Ellithy K, Eslami Z. SCCM COVID-19 Rapid-Cycle Survey 2 Report, on website, 2020 Mar.
  10. Pappa S, Ntella V, Giannakas T, Giannakoulis VG, Papoutsis E, et al. Prevalence of depression, anxiety, and insomnia among healthcare workers during the COVID-19 pandemic: A systematic review and meta-analysis. *Brain Behav Immun*, 2020.
  11. Pfefferbaum B, North CS. Mental Health and the Covid-19 Pandemic. *N Engl J Med*, 2020.
  12. National Guideline and Standard Operating Procedure on Mental Health and Psychosocial Support in Disaster, NGSPMHPS, 2019; Edition 2<sup>nd</sup>.
  13. Al-Hamoody Astabrak A. Psychological problems among special educators in governmental institutes of handicap children, 2019; in pressed.

# Helicobacter Pylori-Associated Iron-Deficiency Anemia and Interleukins Effect

AthraaRazaq Mohammed Hindi<sup>1</sup>, Oday MitibHadi<sup>2</sup>

<sup>1</sup>Research Scholar, College of Health and Medical Techniques, Al-Furat Al-Awsat Technical University, Al-Najaf, Al-Kufa, Iraq, <sup>2</sup>Professor, Corresponding Author, College of Health and Medical Techniques, Al-Furat Al-Awsat Technical University, Al-Najaf, Al-Kufa, Iraq

## Abstract

Helicobacter pylori (*H. pylori*) is a highly prevalence microbial infection, that acts as an iron stressor in susceptible individuals the relationship between ferritin and cytokine levels in individuals infected with *H. pylori* remains controversial. Based on serology testing for anti-*H. pylori* IgG, participants (70 seropositive and 70 seronegative aged 30-60 years) were enrolled. Serum iron profiles including iron, ferritin, and total iron-binding capacity, were measured. IL-1 $\beta$  and IL-6 serum levels were compared. The mean value of interleukin 1beta (IL-1 $\beta$ ) level of patients and controls revealed that *H. pylori* patients had a significantly higher at ( $P < 0.001$ ) mean of (IL-1 $\beta$ ) when compared to the controls, as shown in this study there is positive correlation between gastric interleukin 1beta (IL-1 $\beta$ ) and iron deficiency anemia (IDA) blood parameters observed in resent study could be due to the powerful capability of IL-1 $\beta$  in inhibiting gastric acid secretion. The mean value of Interleukin-6 (IL-6)) level of patients and controls revealed that *H. pylori* patients had a significantly higher at ( $P < 0.001$ ) mean of (IL-6) when compared to the controls.

**Keywords:** *Helicobacter pylori*, iron deficiency anemia, interleukins.

## Introduction

*Helicobacter pylori* is a spiral-shaped, Gram-negative bacterium that is responsible for infections affecting more than half of the world's population and is currently known to play a causative role in the pathogenesis of chronic gastritis, peptic ulcer diseases, gastric cancer and mucosa-associated lymphoid tissue lymphoma<sup>(1)</sup>. *H. pylori* is recognized as the most common cause of chronic active gastritis and is also an important pathogenic factor in peptic ulcer disease. The outcome of infection is thought to be related to severity and distribution of *H. pylori*-related inflammation<sup>(2)</sup>.

Biological factors that affect clinical outcome in *H. pylori* infection have been widely studied. In addition to bacterial virulence determinants in *H. pylori* strains, immunological factors in the host are likely to play a crucial role in different clinical expression of *H. pylori*-infection<sup>(3)</sup>. *H. pylori* infection first induces neutrophilic gastritis, which progresses to chronic gastritis in most people. Activation and migration of these inflammatory cells into the gastric mucosa is related to increased production of proinflammatory cytokines, including IL-8, IL-1 $\beta$ , TNF- $\alpha$  and IL-6 which are believed to contribute to maintaining the gastric inflammation and causing epithelial cell damage<sup>(4)</sup>. The inflammation that may happen in the stomach and proinflammatory cytokines lead to anemia, Anemia induced by digestive diseases refers to anemia due to iron deficiency. Conventional gastrointestinal diagnostic workup fails to establish the cause of iron deficiency in about one third of patients<sup>(5)</sup>. Recent meta-analyses indicates *H. pylori* eradication results in improved iron status of children and adults with ID/IDA compared with iron therapy alone, this suggests underlying changes in gastric inflammation,

---

### Corresponding Author:

**AthraaRazaq Mohammed Hindi**

Research Scholar, College of Health and Medical Techniques, Al-Furat Al-Awsat Technical University, Al-Najaf, Al-Kufa, Iraq  
e-mail: kuh.aud@atu.edu.iq

or infection-related perturbations in gastric physiology may contribute to ID in *H. pylori* infection<sup>(6)</sup>. *H. pylori* infection is also associated with marked reduction in gastric juice ascorbic acid, which binds to reduced ferrous iron facilitating iron transport and uptake. In adults, hypochlorhydria in *H. pylori*-associated corpus atrophy has a role in ID through changes in physiology of iron-complex absorption. Although *H. pylori* is acquired early in life<sup>(7)</sup>. In western countries there are only some uncontrolled intervention studies showing recovery from anaemia after *H. pylori* eradication. *H. pylori* infection has been considered as a risk factor for IDA. The British Society of Gastroenterology recommends eradication of *H. pylori* infection in patients with IDA and normal colonoscopy and oesophagogastroduodenoscopy<sup>(8)</sup>.

### Materials and Method

The study is conducted on the *Helicobacter pylori* patient in digestive system center at (Al-Sadder Hospital) in Najaf province-Iraq from February to August 2019. A total of 70 *H. pylori* infected individual divided into two groups: males and females (males 45 and females 25) were enrolled in this study. Their ages ranged from (30 to 60) years. They were diagnosed by specialist physicians depending on the clinical features, family history and confirmed by laboratory analysis of *H. pylori* stool antigen. A specific questionnaire was designed to both patients and control groups.

*Helicobacter pylori* stool antigen test (HpSA) is noninvasive diagnostic modules for diagnosis of *Helicobacter pylori* (*H. pylori*) infection. SAT based on enzyme immunoassay was used to identify the infection as follows: the HpSA test used in this study is based on a sandwich enzyme immunoassay (EIA) and uses microtiter plates coated with polyclonal rabbit anti-*H. pylori* antibodies as the capture antibody and a second antibody to *H. pylori*, labeled with peroxidase. The minimal concentration of *H. pylori* determined by this kit was <0.015 mg/g of stool. The optical densities at 450 nm for negative and positive controls were <0.200 and >1.000, respectively, and the cutoff value was defined as the negative control value + 0.200<sup>(9)</sup>.

Five milliliters (ml) of blood were withdrawn by vein puncture from *Helicobacter pylori* patients and healthy control. A tourniquet was applied directly on the skin around the arm, the skin over the vein was sterilized with 70% ethyl alcohol, then blood was collected by syringe divided into two aliquots. The first (2 ml) was

added to anticoagulant containing tube (EDTA tube) for estimation of hemoglobin and packed cell volume and the second (3 ml) was put in serum separating tube (SST) which also known as gel tube, to be allowed to clot at room temperature for 15-20 minutes, and then it was centrifuged for 5 minutes at 5000 rpm, to get the serum. The separated serum was transferred into plain tube and storage it at -20 °C until being used in ELISA test<sup>(10)</sup>.

Ten micro liters (µl) of the EDTA blood sample was placed in the aspirator on the instrument Mindray BC-60s. EDTA, ethylene diamine dihydrochloride; CBC, complete blood count; Hb, hemoglobin; MCV, mean corpuscular volume; MCH, mean corpuscular volume, MCHC, mean corpuscular volume concentration, HCT, *hematocrit test*. All these test were done to evaluate the anemia (Iron deficiency anemia).

Iron, FER, serum ferritin, TIBC, total iron binding capacity, TRANS, transferrin, were used to determine the type of anemia.

IgG immunoglobulin G, |IL- 1β, interleukin1 beta, IL-6, interleukin 6, our studies focused on the relationship between bacteria and anemia by levels of interleukin and how effects on hepcidin production.

Data of the study participants, *Helicobacter pylori* patients and controls, were entered, managed and analyzed using the Statistical Package for Social Sciences (SPSS) version 25 software for windows, IBM, US, 2017. All variables were checked for errors or inconsistency prior to the analysis process. Continuous variables included the age, Hb, PCV, WBCs count, RBCs count, MCV, MCH, iron, ferritin, TIBC, transferrin, IL-1β, IL-6 and IgG titer were tested for statistical normality distribution using histogram and normal distribution curves and they all appeared to follow the statistical normal distribution. Chi-square test was used to assess the significance of differences in the frequencies of categorical variables between *H. pylori* patients and controls. (ANOVA) F test used to compare mean levels of these parameters across the age groups. Level of significance (P. value) of 0.05 or less considered significant. Finally, results and findings presented in tables and or figures accordingly, using the Microsoft Word application 2010 for windows .

### Results

The result of immunoglobulin G (IgG) level of

patients and controls revealed that H. pylori patients had a significantly higher at ( $P < 0.001$ ) mean of IgG when compared to the controls; it was found that interleukin 1beta (IL-1 $\beta$ ) level of patients and controls revealed that H. pylori patients had a significantly higher at ( $P <$

0.001) mean of (IL-1 $\beta$ ) when compared to the controls; The mean value of Interleukin-6 (IL-6)) level of patients and controls revealed that H. pylori patients had a significantly higher at ( $P < 0.001$ ) mean of (IL-6) when compared to the controls .

**Table (1): Comparison of mean values of Immunoglobulin G(IgG), Interleukin -1 $\beta$  and Interleukin-6 of Helicobacter pylori patients and controls**

Parameters	Group				t-test df = 138	p- value
	Patients (n=70)		Control (n=70)			
	Mean	SD*	Mean	SD*		
IgG pg/ml	53.78	9.7	3.46	1.5	42.71	<0.001 sig
IL-1 $\beta$ pg/ml	83.24	17.02	32.79	7.86	22.50	<0.001 sig
IL-6 pg/ml	565.49	177.48	72.01	14.91	23.18	<0.001 sig

## Discussion

The mean value of immunoglobulin G (IgG) level of patients and controls revealed that H. pylori patients had a significantly higher at ( $P < 0.001$ ) mean of IgG when compared to the controls, as shown in table (1) (11). Serum anti-H. pylori IgG titer was measured using ELISA, subjects with high Hp-IgG antibody titer have a high H. pylori density some studies suggest that the high density of H. pylori (12).

The mean value of interleukin 1beta (IL-1 $\beta$ ) level of patients and controls revealed that H. pylori patients had a significantly higher at ( $P < 0.001$ ) mean of (IL-1 $\beta$ ) when compared to the controls, as shown in table (1) . There is positive correlation between gastric interleukin 1beta (IL-1 $\beta$ ) and iron deficiency anemia (IDA) blood parameters observed in resent study could be due to the powerful capability of IL-1 $\beta$  in inhibiting gastric acid secretion (13) . The mean value of Interleukin-6 (IL-6)) level of patients and controls revealed that H. pylori patients had a significantly higher at ( $P < 0.001$ ) mean of (IL-6) when compared to the controls, as shown in table (1) .

Inflammation has a potent effect on iron homeostasis, by reducing intestinal iron absorption, and sequestering iron in macrophages, thereby decreasing serum iron levels. There is now substantial evidence that these effects of inflammation are also mediated by hepcidin. Hepcidin is a 25-amino acid peptide hormone secreted by hepatocytes that circulates in blood plasma and is

excreted in the urine . Hepcidin inhibits intestinal iron absorption, iron recycling in macrophages, and release of stored iron from hepatocytes, thereby decreasing body iron availability (14).

## Conclusion

From the present study, we can conclude that Helicobacter pylori patients are at high risk for iron deficiency. There is statistically significant positive correlation was noticed between interleukin-6 and interleukin-1 beta and iron store that cause iron deficiency anemia. The levels of interleukin-6 and interleukin-1beta in patients with Helicobacter pylori, these parameters work directly on hepcidin level which in turn affects on ferritin.

**Ethical Clearance:** Taken from Al-Furat Al-Awsat Technical University ethical committee.

**Source of Funding:** Self

**Conflict of Interest:** Nil

## References

1. Binh T T, Shiota S, Suzuki R., Matsuda M., Trang T. T. H., Kwon D. H., Iwatani S. & Yamaoka Y. Discovery of novel mutations for clarithromycin resistance in Helicobacter pylori by using next-generation sequencing. J Antimicrob Chemother 2014;69(7): 1796-1803.
2. Azadegan-Dehkordi F., Bagheri N., Shirzad

- M., Sanei M. H., Hashemzadeh-Chaleshtori M., Rafieian-Kopaei M., Tabatabaiefar M. A., and Shirzad H. Correlation Between Mucosal IL-6 mRNA Expression Level and Virulence Factors of *Helicobacter pylori* in Iranian Adult Patients with Chronic Gastritis. *Jundishapur J. Microbiol.* 2015; 8(8): e21701.
3. Lee W. J. Digestive system. In *Vitamin C in Human Health and Disease* (pp. 141-151). Springer, Dordrecht, 2019 .
  4. Talebi Bezmin Abadi A. The *Helicobacter pylori* dupA: a novel biomarker for digestive diseases. *Front. Med.* 2014; 1: 13.
  5. Hudak L., Jaraisy A., Haj S., & Muhsen K. An updated systematic review and meta-analysis on the association between *Helicobacter pylori* infection and iron deficiency anemia. *Helicobacter* 2017; 22(1): e12330.
  6. Harris P. R., Serrano C. A., Villagrán A., Walker M. M., Thomson M., Duarte I., & Crabtree J. E. *Helicobacter pylori*-associated hypochlorhydria in children, and development of iron deficiency. *J. Clin. Pathol.* 2013; 66(4): 343-347.
  7. Monzón H., Forné M., Esteve M., Rosinach M., Loras C., Espinós J. C., & Fernández-Bañares F. *Helicobacter pylori* infection as a cause of iron deficiency anaemia of unknown origin. *World J Gastroenterol* 2013; 19(26): 4166.
  8. Cid T. P., Fernández M. C., Benito Martínez S., & Jones N. L. Pathogenesis of *Helicobacter pylori* Infection. *Helicobacter* 2013; 18: 12-17.
  9. Falsafi T., Valizadeh N., Sepehr S., & Najafi M. Application of a stool antigen test to evaluate the incidence of *Helicobacter pylori* infection in children and adolescents from Tehran, Iran. *Clin Diagn Lab Immunol* 2005 12(9): 1094-1097.
  10. Pagana K. D., Pagana T.J., and Pagana T. M. *Mosby's Diagnostic and laboratory test reference.* 12<sup>th</sup> edition. Mosby, an imprint of Elsevier Inc., USA, 2015 .
  11. Vidarsson G., Dekkers G., & Rispens T. IgG subclasses and allotypes: from structure to effector functions. *Frontiers in immunology*, 5, 520.
  - 12] Danciu M., Simion U., Poroach R., Pădureanu S.S., Constantinescu, R. N., Arhire L. I., & Mihalache A. The role of histological evaluation of *Helicobacter pylori* infection in obese patients referred to laparoscopic sleeve gastrectomy. *Romanian J MorpholEmbryol* 2016; 57(4): 1303-11.
  13. Queiroz D. M. M., Rocha A. M. C., Melo F. F., Rocha G. A., Teixeira K. N., Carvalho S. D., & Crabtree J. E. Increased gastric IL-1 $\beta$  concentration and iron deficiency parameters in *H. pylori* infected children. *PLoS One*, 2013; 8(2): 22-25
  14. Ganz T., and Nemeth E. Hcpidin and disorders of iron metabolism. *Annu. Rev. Med* 2011; 62 : 347-360.

# The Influences of Antenatal Care, Postnatal Care and Early Initiation of Breastfeeding on an Exclusive Breastfeeding Pattern in the Working Area of Manukan Kulon Public Health Center at Surabaya City

Azizi Pridasari<sup>1</sup>, Lutfi Agus Salim<sup>2</sup>

<sup>1</sup>Bachelor Student in Department Biostatistics and Demography, Faculty of Public Health, Universitas Airlangga, Surabaya, Indonesia, <sup>2</sup>Associate Professor in Department Biostatistics and Demography, Faculty of Public Health, Universitas Airlangga, Surabaya, Indonesia

## Abstract

Exclusive breastfeeding is very important for babies to maintain their immune system, brain intelligence, emotion stability and to protect babies from various diseases that are causes of death. Breastfeeding will also benefit the mother, which will reduce blood loss during menstruation, restore maternal weight as before pregnancy, reduce the risk of breast cancer, and uterine cancer. The purpose of this study was to determine the influences of antenatal care, postnatal care and early initiation of breastfeeding on an exclusive breastfeeding pattern. The samples used in this study were mothers who had babies aged 7-12 months in June to August 2018 as many as 48 respondents in the working area of Manukan Kulon Health Center in Surabaya. This study used the descriptive and bivariate analyses. The obtained results were antenatal care ( $p = 0.001$ ), postnatal care ( $p = 0.002$ ) and early initiation of breastfeeding ( $p = 0,000$ ). During pregnancy the majority of mothers make complete antenatal care visits with a frequency of 10 times, antenatal care is very important for mothers, especially the pattern of breastfeeding. In addition to the importance of antenatal care visits, mothers who have given birth and are entering the postnatal care phase are required to make postnatal care visits. Socialization from health workers and the support of closest people are required in order to achieve the exclusive breastfeeding.

**Keywords:** *Exclusive Breastfeeding, Early Initiation of Breastfeeding, Antenatal Care, Postnatal Care.*

## Introduction

Exclusive breastfeeding is the provision of breast milk that is given to infants without giving any additional food and drinks to the baby until the age of 6 months and given the breastfeeding as early as possible <sup>(1)</sup>. Breast milk as the main food of babies is

very important because breast milk contains 60% of the nutritional needs of babies. Breast milk has several benefits including the intelligence of baby's brain, the baby's emotion stability and can protect the baby from various diseases that are causes of death. Breastfeeding will also benefit the mother, which will reduce blood loss during menstruation, restore maternal weight as before pre-pregnancy and reduce the risk of breast cancer and uterine cancer. Although breastfeeding and breast milk are very beneficial, it is estimated that 85% of mothers in the world do not give an exclusive breastfeeding as recommended by WHO (2002). Many mothers in many countries do not provide exclusive breastfeeding due to various factors such as social, cultural, economic and political<sup>(2)</sup>.

---

### Corresponding Author:

**Lutfi Agus Salim**

Associate Professor in Department Biostatistics and Demography, Faculty of Public Health, Universitas Airlangga, Surabaya, Indonesia  
e-mail: lutfi.as@fkm.unair.ac.id

Breastfeeding can affect the reduction in newborn mortality from the first day of birth by 16% and will reduce death possibility by 22% if the newborn is given breast milk within the first hour after birth. In 2012, the 0-5 month's infants received exclusive breastfeeding with the percentage of 41.5%. In 2013, infants who received exclusive breastfeeding were 38%. In 2014, the coverage of exclusive breastfeeding in Indonesia did not meet the strategic plan target of 52.3% while the target to be achieved was 80%. However, in 2015, the national target of exclusive breastfeeding was reduced to the amount of 39% so that the national target was able to be reached.

In 2016, the results of nutrition monitoring in Indonesia showed that newborns received early initiation of breastfeeding with the percentage of 51.9%. The infants who were aged 0-5 months received an exclusive breastfeeding with the percentage of 54%, while infants who were aged 0-6 months get exclusive breastfeeding by 29.5%. On these results, it can be concluded that babies received a complementary food of breastfeeding at the age of 5 months on average.

According to the Isrono study in 2013, mothers who gave exclusive breastfeeding in the working area of Serpong Public Health Center were as much as 14.6%<sup>(3)</sup>. In conclusion, the information that has been given and obtained were not necessarily going to be implemented properly.

## Methodology

The samples used in this study were mothers who had babies aged 7-12 months in June to August 2018 as many as 48 respondents. The technique used in this study was by carrying out the data retrieval in the working area of Manukan Kulon Public Health Center at Surabaya City by using the simple random sampling formula.

The dependent variable in this study was the pattern of exclusive breastfeeding. Meanwhile, the independent variables in this study were the influence of antenatal care, postnatal care and early initiation of breastfeeding.

Data analyses in this study were using descriptive and bivariate analyses. Descriptive analysis was used to describe the characteristics of each independent and dependent variables. Meanwhile, bivariate analysis was used to see the relationship between each independent and

dependent variables using a logistic regression analysis. Through the logistic regression test, the value of  $p$  would be obtained, which in this study used a significance level of 0.05. Research between the two variables was said to be meaningful if it had a value of  $p < 0,05$  which meant  $H_0$  was rejected and  $H_1$  was accepted. It was said to be meaningless if it had  $p \geq 0,05$  which meant that  $H_0$  was accepted and  $H_1$  was rejected. Bivariate analysis was carried out to select candidates for influential factors.

## Results

Antenatal care is a midwifery service for pregnant women that aims to maintain the health of pregnant women and ensure normal birth can be carried out at least four times during pregnancy to confinement. Antenatal care visits are grouped into 2 groups, namely complete and incomplete antenatal care visits. Research result shows that the majority of respondents made a complete antenatal visit from the beginning of the pregnancy to giving birth with a total of 44 people (91.6%). Respondents who had an incomplete antenatal care visit were as many as 4 people (8.4%) with a frequency of 4 time visits.

Postnatal Care (PNC) is the period after the placenta is born and the period ends when the uterus organs returns to its pre-pregnancy state. At this time, the body is making both physical and psychosocial adjustments to the birth process that starts immediately after the placenta is born until the body can adjust to perfection and ends when the uterine organs return to their pre-pregnancy state which lasts for 6 weeks. Research result shows that all respondents take the postnatal care visit after giving birth, although with different frequency of visits. The most postnatal care visit was 2 times with a percentage of 60.4%, followed by postnatal care visits as much as 3 times by 31.3% and the least was one time postnatal care visit with a percentage of 8.3%. The percentage was very good because postnatal care visits were suggested to be done at least once after giving a birth.

The coverage of early initiation of breastfeeding among respondents in the working area of Manukan Kulon Public Health Center at Surabaya can be categorized as good, because most respondents initiated early breastfeeding immediately after the baby was born with the percentage of 91.7% and 8.3 % did not initiate early breastfeeding.



**Table 1. Distribution of Breastfeeding Pattern Based on Ante Natal Care (ANC) Visits**

ANC Visit	Breastfeeding Pattern				Total	
	Exclusive		Non-Exclusive			
	n	%	n	%	N	%
Complete	4	9,1	40	90,9	44	100,0
Incomplete	0	0,0	4	100,0	4	100,0
<b>Total</b>	<b>4</b>	<b>8,3</b>	<b>44</b>	<b>91,7</b>	<b>48</b>	<b>100,0</b>

Distribution results on the pattern of breastfeeding based on Antenatal Care visit in the table 1 shows that most respondents with complete ANC visits gave breastfeeding with a non-exclusive pattern with a

percentage of 90.9% while respondents who did not routinely make ANC visits gave breastfeeding with a non-exclusively pattern by 100%.

**Table 2 Distribution of Breastfeeding Pattern Based on Post Natal Care (PNC) Visit**

PNC Visit	Breastfeeding Pattern				Total	
	Exclusive		Non-Exclusive			
	n	%	n	%	n	%
1 Time	0	0,0	4	100,0	4	100,0
2 Time	4	3,18	25	86,2	29	100,0
3 Time	0	0,0	15	100,0	15	100,0
<b>Total</b>	<b>4</b>	<b>8,3</b>	<b>44</b>	<b>91,7</b>	<b>48</b>	<b>100,0</b>

Based on the results in table 2, the majority of respondents visited Postnatal Care twice with a frequency of 29 respondents. The respondents who visited PNC twice and determined the pattern of non-exclusive breastfeeding had a lower percentage with a

total of 86.2%. Meanwhile, the respondents who visited PNC once and three times and determined the pattern of non-exclusive breastfeeding to their babies had a greater percentage by 100% respectively.

**Table 3 Distribution of Breastfeeding Pattern Based on the Early Initiation of Breastfeeding (EIB)**

EIB	Breastfeeding Pattern				Total	
	Exclusive		Non-Exclusive			
	n	%	n	%	n	%
Yes	4	9,1	40	90,9	44	100,0
No	0	0,0	4	100,0	4	100,0
<b>Total</b>	<b>4</b>	<b>8,3</b>	<b>44</b>	<b>91,7</b>	<b>48</b>	<b>100,0</b>

The pattern of breastfeeding based on Early Initiation of Breastfeeding in table 3 shows that there were more respondents who did the EIB than those who did not. Respondents who did EIB mostly gave non-exclusive breastfeeding to their babies with the percentage of

90.9%. Meanwhile, the respondents who did not give an EIB tended to give a non-exclusive breastfeeding to their babies with a percentage of 100%. The analysis of the independent and dependent variables by using logistic regression analysis ( $\alpha = 0,05$ ) are as follows.

**Table 4 Bivariate Analysis of Antenatal Care, Postnatal Care and Early Initiation of Breastfeeding**

Variable	Sig	Explanation
Antenatal Care	0,001	Significant
Postnatal Care	0,002	Significant
Early Initiation of Breastfeeding	0,000	Significant

Based on table 4, the logistic regression analysis obtained, there were 3 variables that influenced the pattern of breastfeeding to mothers, namely antenatal care ( $p = 0,001$ ), postnatal care ( $p = 0,002$ ) and early initiation of breastfeeding ( $p = 0,000$ ).

### Discussion

**Antenatal Care Factor:** Antenatal care is a health service for a mother during her pregnancy which carried out in accordance with established antenatal care standards. The visit of pregnant women to health services is recommended as follows; once in the first quarter, once in the second quarter and at least 2 times in the third quarter<sup>(4)</sup>. Ideally, every woman who is pregnant wants to have a pregnancy check in order to detect abnormalities that exist or will arise in the pregnancy are quickly identified and can be addressed immediately before affecting the pregnancy by conducting antenatal care checks<sup>(5)</sup>.

The results show that the respondents who did a complete antenatal care visit were as much as 91.6% while the respondents who did not make a complete antenatal visit were 8.4%. The results of the study show that most respondents were aware of the importance of maintaining pregnancy<sup>(6)</sup>.

According to the Indonesian Ministry of Health (2012), ANC visits of pregnant women are influenced by several factors<sup>(7)</sup>. The factors are including internal factors such as parity, mother's age and also external factors such as mother's knowledge, attitudes, socioeconomic conditions, socio-cultural, geographical, information and also the support from both staff and family<sup>(8)</sup>.

The results show that the majority of respondents with a percentage of 91.6% made a complete ANC visit, the respondents who gave exclusive breastfeeding by 9.1% and while the respondents who gave non-exclusive breastfeeding were at 90.9%. This study was in line with a research conducted by Suparmi and Ika (2012) which

stated that ANC visits affect the increase in the scope of exclusive breastfeeding<sup>(9)</sup>.

### Postnatal Care Factor on Breastfeeding Pattern:

Postnatal care is a series of treatments performed for postpartum mothers including massages, breast care, oxytocin massage, postpartum spa and so on. Postnatal care is done so that the puerperal mother can pass through the puerperium phase well without any complications<sup>(10)</sup>.

The purpose of the postnatal care visit is to take care of the health of both mother and baby, both physical and psychological, to treat the patient if any complications occur, provide health education regarding self-health care, nutrition, breastfeeding, provide information to the baby and care for healthy babies and providing family planning services<sup>(11)</sup>.

The results show that the respondents who routinely visited postnatal care once were 8.3%, while those who did postnatal care visit twice were 60.4% and the respondents who visited postnatal care three times amounted to 31.3%. The distribution of PNC visits is positively related to the pattern of breastfeeding. Most respondents with a total of 86.2% with the frequency of PNC visits as much as twice decided to do the breastfeeding with a non-exclusive pattern.

The results show that postnatal care visits affect the pattern of breastfeeding. This study was in line with the research conducted by Seid et.al (2013) in Bahir Dar City Administration, Northwest Ethiopia which stated that there was a relationship between the amount of PNC visits with the exclusive pattern of breastfeeding<sup>(12)</sup>.

### Early Initiation of Breastfeeding (EIB) Factor on Breastfeeding Pattern:

Early Initiation of Breastfeeding (EIB) which stands for early initiation of breastfeeding, is the baby's active effort to suckle within the first hour of birth, both normal and cesarean deliveries. The baby is placed on the mother's abdomen and chest immediately after birth and given the opportunity to start breastfeeding herself or himself by crawling for breasts and letting the baby's skin contact with her mother for an hour. On the first hour, the baby finds his mother's breasts in the beginning of a "life-sustaining between mother and child." The World Health Organization (WHO) recommended early breastfeeding to be initiated within the first hour after the baby is born by placing the baby in the mother's chest as soon as the baby is out of the birth canal<sup>(13)</sup>.

The results of this study indicate that respondents who did an EIB were as many as 91.7%, while the respondents who did not do the EIB were 8.3%. In conclusion, most mothers have understood the importance of EIB for babies. The analysis shows that EIB has a big influence on the pattern of breastfeeding. This study was in line with the study of Pongtuluran, et.al (2017) who stated that there is a relationship between EIB and exclusive breastfeeding patterns<sup>(14)</sup>.

### Conclusion

During their pregnancy, majority of mothers make complete antenatal care visits with a frequency of 10 times, antenatal care is very important for mothers, especially the pattern of breastfeeding. In addition to the importance of antenatal care visits, mothers who have given birth and are entering the postnatal care phase are required to make postnatal care visits. Most of the mothers did a two times postnatal care visit and the postnatal care visit in this study had a major influence on the pattern of breastfeeding.

The coverage of mothers who initiate breastfeeding early in their babies after birth (EIB) can also be categorized as good. Therefore, the early initiation of breastfeeding has an influence on the pattern of breastfeeding.

**Suggestion:** For couples who are going to get married are required to take counseling at a public health center or a hospital to educate themselves regarding the preparation that will be done after marriage and after they have children. Counseling can also increase the mother's knowledge, one of which is the importance of breastfeeding for infants. In addition, health workers also provide education on how to treat breast nipples and injured breasts during breastfeeding.

**Conflict of Interest:** The authors have no conflict of interest with the material presented in this paper

**Sources of Funding:** None

**Ethical Clearance:** None.

### References

- Lindawati R. Hubungan Pengetahuan, Pendidikan dan Dukungan Keluarga dengan Pemberian ASI Eksklusif. *Faletehan Health Journal*. 2019;6(1):30–6.
- Laksono W. ASI, Menyusui, dan Sadari. Nuha Medika: Yogyakarta. 2010;
- Anggraeni MF, Herawati S, Mustika DN. Pemberian Asi Eksklusif Berdasarkan Status Bekerja Ibu Yang Memiliki Bayi Usia 6-11 Bulan Di Wilayah Kerja Puskesmas Karangawen 1 Kabupaten Demak. *Jurnal Kebidanan [Internet]*. 2015;4(1). Available from: [https://jurnal.unimus.ac.id/index.php/jur\\_bid/article/view/1389](https://jurnal.unimus.ac.id/index.php/jur_bid/article/view/1389)
- Ministry of Health Republic of Indonesia. Profil Kesehatan Indonesia tahun 2014. Jakarta: Kementerian Kesehatan RI. 2015. 1–382 p.
- Ministry of Health Republic of Indonesia. InfoDATIN : pusat data dan informasi kementerian kesehatan RI: mother's day. Jakarta: Jakarta: Pusat Data dan Informasi Kementerian Kesehatan RI; 2014.
- Ningsih P. Hubungan Umur, Pengetahuan Dan Dukungan Keluarga Dengan Kunjungan Antenatal Care (Anc)(K4) Ibu Hamil Di Puskesmas Pariaman Tahun 2018. *Jurnal Ilmu Keperawatan dan Kebidanan*. 2020;11(1):62–9.
- Direktur Jenderal Bina Kesehatan Masyarakat. Pedoman pelayanan antenatal terpadu. Kementerian Kesehatan. Jakarta; 2012.
- Kurniawan B. Determinan keberhasilan pemberian air susu ibu eksklusif. *Jurnal Kedokteran Brawijaya*. 2013;27(4):236–40.
- Suparmi S, Saptarini I. Determinan Pemberian Asi Eksklusif: Analisis Data Sekunder Survei Demografi Dan Kesehatan Indonesia 2012. *Indonesian Journal of Reproductive Health*. 2014;5(1):15–21.
- Mirzaei K, Ghadikolaee S, Mousavi Bazzaz M, Ziaee M. Mother's satisfaction of postpartum care and its relationship with midwifery care at Urban Health Centers, Mashhad, Iran. *journal of midwifery and reproductive health*. 2016 Oct 21;
- Manuaba IBG. Ilmu kebidanan, penyakit kandungan dan keluarga berencana. Jakarta: EGC. 2010;15:157.
- Seid AM, Yesuf ME, Koye DN. Prevalence of Exclusive Breastfeeding Practices and associated factors among mothers in Bahir Dar city, Northwest Ethiopia: a community based cross-sectional study. *International Breastfeeding Journal [Internet]*. 2013;8(1):14. Available from: <https://doi.org/10.1186/1746-4358-8-14>

13. Djamil A, Hermawan NSA, Setiarini N. Hubungan Pelaksanaan Manajemen Laktasi oleh Petugas Kesehatan terhadap ASI Eksklusif pada Ibu Menyusui. *Jurnal Kesehatan*. 2018;9(1):113–6.
14. Ekaristi P, Kandou GD, Mayulu N. Hubungan Inisiasi Menyusui Dini (Imd) Dengan Pemberian Asi Eksklusif Di Kota Manado. *KESMAS*. 2017;6(3).

# Medico-Legal Updates of the Adverse Threat of Cigarette Advertisements on Children

Bambang Eko Turisno<sup>1</sup>, IGA Gangga Santi Dewi<sup>1</sup>, Suharto<sup>1</sup>, Ery Agus Priyono<sup>1</sup>

<sup>1</sup>Lecturer at Faculty of Law, Diponegoro University, Indonesia

## Abstract

Advertising is an integral part of modern business activities. Information on ad serving in the form of true, clear and honest information about the condition and guarantee of goods is a consumer right that must be given by business actors. In Indonesia, cigarette advertisements in laws and regulations limit and provide several conditions. Some cigarette advertisements do not meet the conditions. The results showed that cigarette advertisements include, visual, tagline, images, placement, airtime, and content of advertisements using psychological persuasion, targeting the share of adolescents and children, who play a role in the onset of cigarette use, encouraging young people to start smoking that threatens children and teenagers.

**Keywords:** *Medico-legal aspects, cigarette, advertisements, adverse effect, children.*

## Introduction

Advertising is an inseparable part of modern business. This fact is closely related to the way of modern industrial production which produces products in large quantities, so it must find a buyer. Advertising primarily intends to provide information on the products produced that are expected to be effective, so that products or services are in demand in the market. Gov. Reg No. 19/2003 concerning Amendments to Gov. Reg No.81 of 1999 concerning Safeguarding Cigarettes for Health, stated that cigarette advertising is an activity to introduce, promote cigarettes with or without rewards to the public with the aim of influencing consumers to use the cigarettes offered. Advertising can be divided into two functions, namely the informative function and the persuasive function. In reality there are no ads that are merely informative and no ads that are merely persuasive.

However, there are advertisements with more dominant information elements, and advertisements with the most striking promotional elements. Providing true, clear, and honest information about the conditions and guarantees of goods and/or services as well as providing an explanation of the use, repair and maintenance specified in Article 7 (b) of the Consumer Protection Act is the obligation of business actors. Information that is true, clear, and honest about the conditions and guarantees of goods and/or services according to Article 4.1 is the consumer's right. Business actors have the obligation as stipulated in Article 7 to have a good intention in carrying out their business activities.

Cigarette advertising can only be done with certain requirements. The public knows that smoking can have negative effects, although on the other hand some people still consume it. The prevalence of active smokers in Indonesia is increasing very fast. Cigarettes contain an addictive substance which if inhaled can endanger health for individuals and society. Each cigarette contains nicotine and tar which are substances, compounds or substances that are addictive and carcinogenic. Forms of cigarette advertisements are widely displayed on billboards, print media and television media. A number of cigarette advertisements, targeting the share of teenagers and children, groups of children and adolescents are very vulnerable to advertisements because they can create

---

### Corresponding Author:

**Bambang Eko Turisno**

Lecturer at Faculty of Law, Diponegoro University, Jl. Prof. Soedarto, Tembalang, Semarang, Central Java 50275, Indonesia

e-mail: bambangekoturisno@live.undip.ac.id

models that are imitated and form inappropriate dreams. Advertising, promotion, production requirements and sales of cigarettes, the settings have not been determined to the maximum. The study discusses the protection of children in cigarette advertisements which include, how the contents of cigarette advertisement loading in Indonesia and how children protect against cigarette advertisements.

**Research Method:** The approach method used is classified as empirical juridical and analytical descriptive research specifications, and qualitative analysis is also used. Data collection includes records, documents, articles and clippings from the mass media as well as data obtained by looking at the legislation and relevant literature. The data was also obtained directly through observations in the field observations, which were carried out directly at the research location which included brochures, banners, cigarette billboards, and cigarette advertisements on television.

**Cigarette Advertisements in Indonesia:** Most countries impose regulations on advertising practices. In general, industry regulations and laws in many countries are aimed at protecting companies from unfair competitive attacks<sup>1</sup>. Regulation is also to protect consumers against false and misleading advertising. Consumers must be protected from wrong business practices and their ignorance. Promotional activities according to Article 1.6 Law No. 8/1999 concerning Consumer Protection as an activity for introducing or disseminating information on goods and/or services to attract consumers to buy goods and/or services to be traded, is giving obligations to business actors in Article 7 to have an intention good at doing business. Obligations of business actors specified in Article 7 (b), namely to provide true, clear and honest information about the conditions and guarantees of goods and/or services and to provide explanations for the use, repair and maintenance. Information that is true, clear, and honest about the conditions and guarantees of goods and/or services according to Article 4.1 is the consumer's right.

In Indonesia, the advertising material as Article 17 Gov. Reg. No. 19 of 2003 concerning Amendments to Gov. Reg. No. 81 of 1999 concerning Safeguarding Cigarettes for Health determines that it is prohibited to stimulate or encourage people to smoke, illustrate or suggest that smoking provides health benefits, display or illustrate in the form of pictures, writing or a combination

of both, cigarette packets, cigarettes or people who are smoking or point to people who are smoking, aimed at or displaying in the form of pictures or writing or a combination of both, children, adolescents, or pregnant women, to name the product concerned of cigarettes, and be contrary to the norms prevailing in society.

**Cigarette advertisements and protection for children:** A report from the US Department of Health and Human Services shows that if a person does not start smoking until past the age of adolescence, he will not start smoking. of the adults who had smoked, 88% lit their first cigarette at the age of 18, and more than 44% were accustomed to smoking at that age. Some studies demonstrated that the younger a person starts smoking, the higher the likelihood of someone becoming a heavy smoker<sup>2,3,4</sup>. Furthermore, Bezilla, George and Gallup International Foundation show that seventy percent of teenagers who smoke regret their decision and 66% want to quit smoking<sup>5</sup>.

Cigarette marketing is important to encourage young people to start smoking<sup>6,7</sup>. Teinowitz stated that exposure to advertisements and other forms of marketing communication played a role in the beginning of the use of tobacco products and 90% of smoking habits started with teenagers, according to the Institute of Health and Human Services in his research. The results of a Pollay et al, showed that brand advertising significantly influences brand selection, especially in young people<sup>8</sup>. Tobacco brands are more often associated with positive images than producer names. Advertising spending to increase market share is dedicated to developing brand identification and preferences rather than developing producer identification. Consumers identify and buy tobacco products through brand names instead of producer name. A number of cigarette advertisements, targeting the share of teenagers and children, not adults. The selection of media and inappropriate broadcast time tagged a number of cigarette advertisements including 'just enjoy it, and, 'no you are not crowded', targeting the share of teenagers and children, not adults. Therefore cigarette advertising is considered detrimental to children and adolescents. Cigarette advertisements display cigarette brands by including the price of cigarettes per stick, the aim is to make it easier for children to calculate the money they have to buy cigarettes.

Groups of children and adolescents are very vulnerable because advertising can create models that are imitated and form inappropriate dreams. As a visual

media, television can show something that creates a false impression through optical illusions or similar means. The strength of TV is the demonstration ability. This TV is a champion in marketing, because this media allows people to see products or services plus the demo, in an easy way. Delivered in an advertisement, one of the functions of cigarettes is to show males. Cigarettes are a man's male identity<sup>9</sup>. With a cigarette he feels as male as a cowboy warrior, while riding a gallant horse or associated with super busy executive work while inhaling puffs of smoke that are said to contain nuclear material. Cigarette advertisements featuring masculinity as illustrated in a contest of courage through adventure. As a result, men want to smoke to the point of smelling to show their masculinity, the assumption will be awesome when smoking. The creation of psychological consumer desires, one's desire for goods that "makes him feel personal achievement, promises social acceptance". According to John K. Galbraith, quoted by Velasquez is a manipulative advertisement<sup>10</sup>.

Warning of the dangers of smoking contained in cigarette advertisements, Fox et al, put forward some of the results of the study as follows<sup>7</sup>. First, Pollay and Strasburger et al, research cited young people as being far more sensitive to advertising than adults<sup>11,12</sup>. Young people are easily persuaded by display ads, which are used extensively in advertising tobacco products. The nature of youth makes teenagers more sensitive than other age groups to advertising parables and promotion appeal. Many brand loyalties, according to Raphael, started in adolescence and surviving into adulthood<sup>13</sup>. Research from Beltramini on cigarette warnings shows that adolescents are less trustworthy<sup>14</sup>. According to Maluoff et al, it requires a high level of reading comprehension<sup>15</sup>. Teenagers tend to underestimate the risk of using dangerous products. Laventhal et al, research proves that adolescents tend to underestimate the dangers of smoking and overestimate smoking excess<sup>16</sup>. Teenagers see themselves as immune to the negative effects of smoking, according to Fischer et al, young people also have difficulty connecting the negative impacts that can occur in the future<sup>17</sup>. General provisions of Gov. Reg. No.19 of 2003 concerning Amendments to Gov. Reg. No. 81 of 1999 concerning Safeguarding Cigarettes for Health require cigarette labels, i.e. any information about cigarettes in the form of pictures, writing, a combination of both, or other forms included in cigarettes, put in, placed on, or are part of cigarette packaging.

Regarding advertising about products that are detrimental to public health, the government can limit or even ban<sup>18</sup>. In the United States, Fox et al, who quoted Teinowitz even though no central regulations were applied to tobacco product advertising, the local government began to take action<sup>7,8</sup>. Tobacco advertising is prohibited on billboards in the Baltimore area. Baltimore regional regulations forbidding the placement of any signs from cigarette advertisements in publicly visible locations, such as billboards, building sides, and free standing signage<sup>2</sup>.

In 1965 the cigarette warning was adopted in the United States. Cigarette warnings are one of the most widespread uses of explanation disclosure ordered by central policy and help the role of government policy in warning consumers of the dangers of smoking<sup>7</sup>. Warn adolescents can prove difficult. The nature of adolescence makes dependence on tobacco, making stopping smoking a very difficult thing to do later. Warning of statistics and the increasing amount of evidence of increased smoking rates in adolescents, President Clinton proposed steps to reduce smoking rates in adolescents. One such step is to further limit advertising. On August 10, 1995, President Clinton, as Press issued by the White House 1995 page 1, announced a six-step plan to limit "advertisement, promotion, distribution and marketing of cigarettes for teenagers." First, teens must prove their age with an identity card to buy cigarettes. Second, automatic sales machines will be banned. Third, smokeless cigarette or tobacco billboards near playgrounds or schools will be banned. Fourth, pictures will not appear on billboards outside the room or in advertisements noticed by many teenage audiences. Fifth, marketing to teenagers is prohibited, and the prohibition includes items ranging from selling single cigarettes, T-shirts and sports bags to sponsoring sports activities. Sixth, through education efforts, the tobacco industry must fund and implement an annual \$ 150 million campaign aimed at stopping teenagers from smoking<sup>2</sup>.

If we see in the United States there is an institution called the Federal Trade Commission (FTC) which has been involved in the continuous supervision and marketing practice of cigarette advertising, starting in the early 1940s. Cigarette advertising in the United States is more limited than other legitimate consumer products. Some regulations are mainly information (warning labels), while others affect the level of direct advertising (broadcast ban). Over a period of six decades, the FTC governed the overall direction of cigarette

marketing, including content advertising and placement, label warnings, and product development. Through the testing program, he is able to influence the types of cigarettes produced and consumed. The FTC is involved in monitoring the practice of cigarette advertisements and preparing in-depth reports on these practices. It was held with opinions on cigarette testing, advertising, and labeling, and published consumer smoking advisories. Directly or indirectly, the FTC has begun or influenced the promotion and development of products in the cigarette industry<sup>19</sup>. The Federal Trade Commission (FTC) has the power to regulate “dishonest and deceptive business practices,” including advertisements for food and drugs. With the section on the 1967 State Law on Cigarette Labels and Ads Congress has authorized the FTC to enforce restrictions on cigarette advertising and report to Congress once a year in relation to smokeless tobacco and tobacco advertising, including recommendations for further restrictions by the agency believed to be enacted by Congress<sup>2</sup>.

### Conclusion

In Indonesia, cigarette advertising is limited by several requirements, but cigarette advertising is actually more liberal and unethical. Some cigarette advertisements are illogical and misleading. Advertisers use psychological persuasion, which advertisers are aiming for is not the use of reason by users or potential users but human emotions. Manipulative cigarette advertisements create desires in consumers who are psychological. Many cigarette advertisements do not meet the conditions. Violations at the time of display of cigarette advertisements on electronic media also on the prohibition to display advertisements for the appearance of cigarettes and or the use of cigarettes.

Cigarette ads target the share of teenagers and children. Cigarette advertisements encourage young people to start smoking which harms children and adolescents. Advertising plays a role in the initial use of tobacco products. Cigarette advertisements harm teenagers and children. To reduce smoking rates in teenagers, it is necessary to limit cigarette advertising. The beginning of the use of tobacco products by teenagers needs to be prevented. Cigarette marketing, including advertising to adolescents besides being prohibited, education efforts need to be made that the tobacco industry must fund and implement campaigns aimed at stopping youth from smoking.

**Suggestion:** Limiting cigarette advertisements for teenagers in addition to promotion, distribution and marketing. Reducing smoking rates in teenagers. Institutions that regulate, supervise and sanction the overall direction of cigarette marketing, including advertisements, are needed. Censored before airing on television and mass media as well as continuous monitoring of cigarette advertising practices. Local regulations should prohibit the placement of any sign of cigarette advertisements in a publicly visible location and monitor the content of advertisements on billboard advertisements.

**Ethical Clearance:** This research was ethically approved by Faculty of Law, Universitas Diponegoro, Semarang, Indonesia

**Funding:** This research receives Research Grant Funds at the Faculty of Law of Diponegoro University in the 2020 budget year.

**Conflict of Interests:** There are no conflict of interests

### References

1. Simamora, H. *Manajemen Pemasaran*. Jakarta, Penerbit Salemba Empat; 2010.
2. Petty RD, McKay SE, Dundas MJ, Yeargain JW. The FDA’s proposed rules regulating tobacco and underage smoking and the commercial speech doctrine. *Journal of Public Policy & Marketing*. 1996 Sep;15(2):296-303.
3. Escobedo LG, Reddy M, Giovino GA. The relationship between depressive symptoms and cigarette smoking in US adolescents. *Addiction*. 1998 Mar 1;93(3):433.
4. Taioli E, Wynder E. Effect of the age at which smoking begins on frequency of smoking in adulthood. *The New England Journal of Medicine*. 1991 Sep 26;325(13):968-9.
5. Bezilla R, George H. Gallup International Foundation, United States of America. *Teen-Age Attitudes and Behavior Concerning Tobacco: Report of the Findings*. Princeton, NJ: George H. Gallup International Institute. 1992.
6. Hastings GB, Aitken PP. Tobacco advertising and children’s smoking: a review of the evidence. *European Journal of Marketing*. 1995 Nov 1.



7. Fox RJ, Krugman DM, Fletcher JE, Fischer PM. Adolescents' attention to beer and cigarette print ads and associated product warnings. *Journal of advertising*. 1998 Oct 1;27(3):57-68.
8. Teinowitz I. Tobacco cases worry ad groups. *Advertising Age*. 2001;72(13):17-17.
9. Kartajaya H, Indrio BD, Madyani D. *Marketing in venus*. Gramedia Pustaka Utama; 2004.
10. Velasquez MG. *Business ethics: Concepts and cases* (Vol. 111). Upper Saddle River, NJ: Prentice Hall; 2002.
11. Pollay RW. The distorted mirror: Reflections on the unintended consequences of advertising. *Journal of marketing*. 1986 Apr;50(2):18-36.
12. Strasburger VC, Wilson BJ, Jordan AB. *Children, adolescents, and the media*. Sage Publications; 2013 Mar 14.
13. Raphael M. Are you kidding?. *Direct Marketing*; 1993;56(3).
14. Beltramini RF. Perceived believability of warning label information presented in cigarette advertising. *Journal of Advertising*. 1988 Jun 1;17(2):26-32.
15. Malouff J, Gabrilowitz D, Schutte N. Readability of health warnings on alcohol and tobacco products. *American Journal of Public Health*. 1992 Mar;82(3):464-.
16. Leventhal H, Glynn K, Fleming R. Is the smoking decision an 'informed choice'? : effect of smoking risk factors on smoking beliefs. *Jama*. 1987 Jun 26;257(24):3373-6.
17. Fischer S, Spiegelhalter B, Eisenbarth J, Preussmann R. Investigations on the origin of tobacco-specific nitrosamines in mainstream smoke of cigarettes. *Carcinogenesis*. 1990 May 1;11(5):723-30.
18. Kasali R. *Manajemen periklanan konsep dan aplikasinya di Indonesia*. Pustaka Utama Grafiti; 1992.
19. Nelson J P. Advertising bans in the United States. *EH. Net Encyclopedia*; 2004(1):29.

# Term Lowbirth Weight Neonate: Maternal Factors

Bashar Mukhlif Khalaf<sup>1</sup>, Zuhair Idreas Mohammed<sup>1</sup>, Nada Hasan Ali<sup>1</sup>

<sup>1</sup>Board Dr. Pediatrics, Department of Pediatrics, Al-qayarh General hospital, Mosul, Iraq

## Abstract

The current research aims to detect the maternal risk factors that influence the birth weight of the babies. Risk factors related to the mothers like gestational age, maternal age, nutrition, and medical problems play a role in the delivery of infants with low birth weight. The sample consisted of 267 ladies give a birth to newborns. Mothers with less than or = 150cm giving low birth weight babies (62.3%) while those with more than 150cm giving low birth weight babies (37.7%) . In the normal birth weight group, working mothers represent (82.1%) while in normal birth weight group they represent (17.4%). Mothers more than or = 35 years old giving (33.1%) normal birth weight babies. Young mothers less than 20 years old gave more low birth weight babies (28.7%) than older mothers with more 20 years old.

The maternal risk factors of low birth weight babies include maternal age < 20 years old, low maternal educational level, working mothers, smoking, pre-pregnancy weight<50kg, maternal height ≤150cm, low socioeconomic status, inter pregnancy interval of less than one year, previous low birth weight babies, history of infertility and first week neonatal death, low rate of visiting to antenatal care centers.

**Keywords:** Low birth weight, risk factors, antenatal care, fetal growth.

## Introduction

According to the WHO, low birth weight (LBW) is defined as the weight at birth of less than 2.5 kg whatever the gestational age<sup>1</sup>. While, very LBW (VLBW) is the infant weight < 1.5 kg, and extremely LBW (ELBW), the infant <1kg.<sup>2</sup>

LBW is considered a major health concern all over the world, particularly in developing countries. Around 25 million LBW infants are born per year, and 20 % of them die globally<sup>1</sup>.

Infants who weigh less than 2,499 gm at birth are at twenty times more risk of neonatal death than those who weigh more than 2,500 gm<sup>3</sup>.

The prevalence of low birth weight in in developed regions (7%) while in developing countries (16.5%)<sup>4</sup>.

There are many risk factors of LBW in developing countries include the age of the mother, maternal education, attendance of the antenatal care (ANC) follow-up, socioeconomic status, and maternal body mass index<sup>5</sup>.

In general, LBW is due to genetic, nutritional, obstetric, constitutional, prenatal maternal morbidities, drugs and toxins exposure, and ANC follow-up. In addition, other risk factors have also been reported like age of the mother, smoking, birth spacing, genital infections, anemia, stress, and ill health mothers<sup>6</sup>.

The aim of the study was to find the maternal risk factors for LBW in full term babies.

## Materials and Method

This is a prospective cohort study that was carried out during the period from the 1<sup>st</sup> of March 2019 till the 1<sup>st</sup> of July 2019 that involving 267 ladies delivered at AL-Khansaa and Ibn-Alatheer Maternity and Children Teaching Hospitals in Mosulcity/Iraq.

---

### Corresponding Author:

**Bashar Mukhlif Khalaf,**

Pediatrician Dr., Department of Pediatrics, Al-qayarh General hospital, Mosul, Iraq

e-mail: basharmukhlif@gmail.com

Data were collected through a special questionnaire regarding mothers age, address, education, smoking habit, history of abortion or infertility, residency (rural or urban), antenatal care visit with the number of these visits, any supplementation of tonics, any ante-partum complication have been evaluated and the informed consent was taken from every mother. Newborn babies were examine for gender and presence of congenital anomalies. Gestational age was determined were the full term babies (<sup>3</sup>37 weeks of gestation) and the birth weight was measured immediately after delivery.

The newborns divided into two groups, a case group with LBW <2.5 kg and a control group with normal birth weight (NBW) of ≥2.5 kg.

- **Inclusion Criteria:** All live babies born at term-gestational age.

- **Exclusion Criteria:** Intra-uterine deaths, stillbirths, and twins deliveries.

The results were analyzed using Chi-squared method, where P-Value is not significant if it is > 0.05, significant if < 0.05, and highly significant if < 0.001.

**Results**

Out of 267 term babies, there are 166 (62.5%) with normal birth weight, and 101 (37.5%) with LBW.

**Table (1)** shows that a mothers where maternal age < 20 years, low maternal educational level, working mothers, smoking habit, low socioeconomic status associated with significant relation with LBW.

**Table (1) Socio-demographic characteristics of 267 mothers**

Age of mother		LBW		NBW		p-value
		No.	%	No.	%	
<20 years	47	29	61.7	18	38.3	<0.001
20-24 years	51	25	49.1	26	50.9	
25-29 years	43	21	48.8	22	51.2	
30-34 years	60	15	25	45	75	
≥ 35 years	66	11	16.6	55	83.3	
<b>Total</b>	<b>267</b>	<b>101</b>	<b>37.8</b>	<b>166</b>	<b>62.2</b>	
<b>Residence</b>						>0.05
Rural	107	39	36.4	68	63.6	
Urban	160	62	38.7	98	61.3	
<b>Total</b>	<b>267</b>	<b>101</b>	<b>37.8</b>	<b>166</b>	<b>62.2</b>	
<b>Level of education of mother</b>						<0.001
Illiterate	54	43	79.7	11	20.3	
Primary	50	33	66	17	34	
Intermediary	36	13	36.1	23	63.9	
Secondary	59	7	11.9	52	88.1	
University & above	68	5	7.4	63	92.6	
<b>Total</b>	<b>267</b>	<b>101</b>	<b>37.8</b>	<b>166</b>	<b>62.2</b>	
<b>Employment-status</b>						<0.001
Worker	112	83	74.1	29	25.9	
House-wives	155	11.6	17.9	137	88.4	
<b>Total</b>	<b>267</b>	<b>101</b>	<b>37.8</b>	<b>166</b>	<b>62.2</b>	

Age of mother		LBW		NBW		p-value
		No.	%	No.	%	
<b>Smoking habit</b>						<0.001
Non- smoker	112	16	14.3	96	85.7	
Passive smoker	82	36	43.9	46	56.1	
Current Smoker	73	49	67.1	24	32.9	
<b>Total</b>	<b>267</b>	<b>101</b>	<b>37.8</b>	<b>166</b>	<b>62.2</b>	
<b>Socioeconomic status</b>						<0.001
High	108	15	14.9	93	56	
Moderate	66	21	20.8	45	27.1	
Low	93	65	64.3	28	16.9	
<b>Total</b>	<b>267</b>	<b>101</b>	<b>37.8</b>	<b>166</b>	<b>62.2</b>	

As shown in **table (2)**, pre-delivery weight (less than 50k.g.), maternal height ( $\leq 150$ cm) and short-spacing ( $< 1$  year) associated with significant relation with LBW.

**Table (2) Clinical aspects related to mothers**

Pre-pregnancy weight		LBW		NBW		p-value
		No.	%	No.	%	
<50kg	47	29	61.7	18	38.3	<0.001
50-89kg	149	51	34.2	98	65.8	
$\geq 90$ kg	71	21	29.6	50	70.4	
<b>Total</b>	<b>267</b>	<b>101</b>	<b>37.8</b>	<b>166</b>	<b>62.2</b>	
<b>Maternal height cm</b>						<0.001
$\leq 150$	95	63	66.3	32	33.7	
$> 150$	172	38	22.1	134	77.9	
Total	267	101	37.8	166	62.2	
<b>Parity</b>						<0.005
Prime	110	52	51.5	58	35	
2-3	73	28	38.4	45	61.6	
$>3$	84	21	25	63	75	
<b>Total</b>	<b>267</b>	<b>101</b>	<b>37.8</b>	<b>166</b>	<b>62.2</b>	
<b>Spacing(years)</b>						<0.001
$< 1$	31	26	46.4	5	7.0	
1	25	14	25	11	15.5	
2	34	11	19.6	23	32.4	
$\geq 3$	37	5	9.0	32	45.1	
<b>Total</b>	<b>127</b>	<b>56</b>	<b>44.1</b>	<b>71</b>	<b>55.9</b>	

**Table (3) Distribution of the birth weight according to the mothers previous obstetrical history**

Previous obstetrical history		LBW		NBW		p-value
		No.	%	No.	%	
1	<b>History of previous LBW deliveries*</b>					<0.001
	Yes	28	68.3	45	40.1	
	No	13	31.7	67	59.9	
	<b>Total</b>	<b>41</b>	<b>26.6</b>	<b>112</b>	<b>37.4</b>	
2	<b>History of stillbirth*</b>					<0.001
	Yes	37	77.1	26	24.8	
	No	11	22.9	79	75.2	
	<b>Total</b>	<b>48</b>	<b>31.4</b>	<b>105</b>	<b>68.6</b>	
3	<b>History of 1<sup>st</sup> week neonatal death*</b>					<0.001
	Yes	31	57.4	21	21.2	
	No	23	42.6	78	78.8	
	<b>Total</b>	<b>54</b>	<b>35.3</b>	<b>99</b>	<b>64.7</b>	
4	<b>History of infertility</b>					<0.001
	Yes	62	61.4	45	27.1	
	No	39	38.6	121	72.9	
	<b>Total</b>	<b>101</b>	<b>37.8</b>	<b>166</b>	<b>62.2</b>	
5	<b>History of abortion</b>					>0.05
	Yes	21	20.8	44	26.5	
	No	80	79.2	122	73.5	
	<b>Total</b>	<b>101</b>	<b>37.8</b>	<b>166</b>	<b>62.2</b>	

\*After exclusion of primiparous (114) from total number (267), the remain number (153).

As shown in **table (3)**, mothers who had delivered LBW babies previously, (68.3%) gave birth to LBW babies again. The risk of giving birth to LBW babies significantly increased in mothers with history of still birth (77.1%), previous history of first week neonatal death (57.4%) and history of infertility (61.4%).

**Table (4) Distribution of the birth weight according to the mother attendance to antenatal care centers**

ANC attendance		LBW		NBW		p-value
		No.	%	No.	%	
1	<b>Antenatal care</b>					≤0.001
	Absent	26	25.8	24	14.5	
	Present	75	74.2	142	85.5	
	<b>Total</b>	<b>101</b>	<b>37.8</b>	<b>166</b>	<b>62.2</b>	
2	<b>Number of visits</b>					<0.001
	1-3	35	46.7	11	7.7	
	4-6	21	28.0	51	35.7	
	≥ 7	19	25.3	81	56.6	
	<b>Total</b>	<b>75</b>	<b>31.9</b>	<b>143</b>	<b>68.1</b>	

ANC attendance		LBW		NBW		p-value
		No.	%	No.	%	
3	Date of 1 <sup>st</sup> visit					<0.005
	1 <sup>st</sup> trimester	15	20.0	59	41.3	
	2 <sup>nd</sup> trimester	26	34.7	44	30.8	
	3 <sup>rd</sup> trimester	34	45.3	40	27.9	
	<b>Total</b>	<b>75</b>	<b>31.9</b>	<b>143</b>	<b>68.1</b>	
4	Iron-folate supplementation					<0.005
	No	58	77.3	58	40.6	
	Yes	17	22.7	85	59.4	
	<b>Total</b>	<b>75</b>	<b>31.9</b>	<b>143</b>	<b>68.1</b>	

As shown in **table (4)**. Significant association was found between the number of visits to ANC center and giving LBW-babies. The mothers who was not received iron-folate supplementation were significantly at higher risk of giving LBW babies.

### Discussion

In this study a significant association was observed between the age and fetal growth were mothers less than 20 years old gave birth to a LBW babies. Similar finding was observed by Althabe et al study<sup>7</sup>. This could be explained by the fact that such teenagers have not completed their physical growth and the additional caloric requirement of the pregnancy may create a competition between the mother and the fetus for nutrients.

human health may be effected by environmental exposures but no significant association was found between residence and fetal growth. This is in agreement with the study of Dimple<sup>8</sup>.

The present study showed that as the maternal educational level increases, the chance of delivering LBW neonate decreases, the same result was reported in Pakistan<sup>9</sup>.

working mothers were more prone to deliver LBW neonates, this is partially may explained by the lack of the time needed for mother to rest and that exercise during work may reduce blood flow from the uterus to the placenta. This result coincides with study carried out in Tehran which illustrate that LBW among employed mothers was 5 times more likely than unemployed ones<sup>10</sup>.

In our study, there is a significant association between cigarette smoking and delivering LBW neonate. This finding was consistent with the finding reported byZheng et al<sup>11</sup>.

Maternal pre-pregnancy weight status has an important rule on fetal growth and the ability of the placenta to supply essential nutrients to the fetus depends on the nutritional status of the mother<sup>12</sup>. This study show that women with low pre-pregnancy weight (<50 k.g) were more prone to deliver small babies. the same result was reported byZ. He et al<sup>13</sup>.

Maternal height also revealed significant association with LBW babies, women whose height were less than or = 150cm appeared to be significantly at higher risk of having LBW-babies. This might be explained by genetic susceptibility. This result was in accordance with the finding in study in 2015 in Nepal<sup>14</sup>.

The LBW babies were more likely to be the first born baby. This might be explained by the fact that multiparous women know more about how to deal with their pregnancy. This finding was similar to that found byRosy et al<sup>15</sup>.

Result demonstrated that those mothers with low SES were more prone to delivering LBW neonate when compared with high SES mothers. The logic explanation for this finding is that mothers with low SES may not attended health care and with poor nutrition. This result supports that reported by Rosy et al<sup>15</sup>.

This study showed that there was a significant association between short spacing and LBW babies. This might be due to nutritional deprivation and incomplete

return of the maternal physiology to normal levels encountered among rapid conceivers. similar finding were reported by other studies in India<sup>16</sup>.

Mother with history of previous LBW delivery are more likely to having LBW neonates in subsequent pregnancy. This finding was also obtained by Mvunta et al<sup>17</sup>. The explanation of this finding may be due to the persistence of socio-demographic factors like age, poor nutritional and social status.

The study also clarified a significant risk of LBW in pregnancy preceded by history of stillbirth or first week neonatal death. This finding was compatible to that found by Feresu<sup>18</sup>.

Compared with infants conceived within 12 months of trying, those conceived after a waiting time of 12 months have a higher risk of preterm birth and LBW<sup>19</sup>. Mothers with history of infertility were more prone to deliver LBW-babies. This finding was in agreement with the study of Wannous et al in Syria<sup>20</sup>.

Regarding previous history of abortion, no significant association was found with LBW babies, this finding support the finding detected in Syria<sup>20</sup>.

Prenatal care considered an important tools available to detect obstetric risk factors that may impact on optimal fetal development, and final birth weight<sup>21</sup>. Mothers with no antenatal care, were more prone to deliver LBW babies this was in agreement with that found by Howlader<sup>22</sup>.

The prevalence of LBW significantly affected by micronutrient deficiencies during pregnancy, particularly iron and folate<sup>23</sup>. This study detected that nutritional supplementation with iron and folate during pregnancy was associated with reducing the risk of giving LBW neonate. This finding was in agreement with that observed by Howlader<sup>22</sup>.

### Conclusion

The study showed the maternal risk factors for LBW neonates were maternal age 20 years, low maternal educational level, working mothers, smoking habit, pre-delivery weight (less than 50 kg), maternal height ( $\leq 150$ cm), low socioeconomic status and short-spacing (1 year), less frequent and late visits to ANC-centers and with no supplementation of iron and folate. Previous bad obstetrical history is a probable risk factor.

### Conflict of Interest:

**Source of Funding:** Self

**Ethical Clearance:** Not required

### References

1. World Health Organization. Global nutrition targets 2025: Stunting policy brief. World Health Organization; 2014.
2. Ballot DE, Potterton J, Chirwa T, Hilburn N, Cooper PA. Developmental outcome of very low birth weight infants in a developing country. *BMC pediatrics*. 2012 Dec 1;12(1):11.
3. Choudhary AK, Choudhary A, Tiwari SC, Dwivedi R. Factors associated with low birth weight among newborns in an urban slum community in Bhopal. *Indian journal of public health*. 2013 Jan 1;57(1):20.
4. Bharati P, Pal M, Bandyopadhyay M, Bhakta A, Chakraborty S. Prevalence and causes of low birth weight in India. *Malaysian Journal of Nutrition*. 2011 Dec 1;17(3).
5. Mahumud RA, Sultana M, Sarker AR. Distribution and determinants of low birth weight in developing countries. *Journal of preventive medicine and public health*. 2017 Jan;50(1):18.
6. Deshpande Jayant D, Phalke DB, Bangal VB, D Peeyuusha BS. Maternal risk factors for low birth weight neonates: a hospital based casecontrol study in rural area of western maharashtra, India. *National Journal of Community Medicine*. 2011 Oct;2(3):394-8.
7. Althabe F, Moore JL, Gibbons L, Berrueta M, Goudar SS, Chomba E, Derman RJ, Patel A, Saleem S, Pasha O, Esamai F. Adverse maternal and perinatal outcomes in adolescent pregnancies: The Global Network's Maternal Newborn Health Registry study. *Reproductive health*. 2015 Dec 1;12(S2):S8.
8. Dimple VK, Doibale MK, Nair A, Rajput PS. Assessment of maternal risk factors associated with low birth weight neonates at a tertiary hospital, Nanded, Maharashtra. *Nigerian medical journal: journal of the Nigeria Medical Association*. 2016 Jan;57(1):37.
9. Dayanithi M. Low birth weight and premature births and their associated maternal factors. *Int J Community Med Public Health*. 2018 Jun;5(6):2277.

10. Mahmoodi Z, Karimlou M, Sajjadi H, Dejman M, Vameghi M, Dolatian M, Mahmoodi A. Association of maternal working condition with low birth weight: The social determinants of health approach. *Annals of medical and health sciences research*. 2015;5(6):385-91.
11. Zheng W, Suzuki K, Tanaka T, Kohama M, Yamagata Z, Okinawa Child Health Study Group. Association between maternal smoking during pregnancy and low birthweight: effects by maternal age. *PloS one*. 2016 Jan 21;11(1):e0146241.
12. Field ME, Anthony RV, Engle TE, Archibeque SL, Keisler DH, Han H. Duration of maternal undernutrition differentially alters fetal growth and hormone concentrations. *Domestic animal endocrinology*. 2015 Apr 1;51:1-7.
13. He Z, Bishwajit G, Yaya S, Cheng Z, Zou D, Zhou Y. Prevalence of low birth weight and its association with maternal body weight status in selected countries in Africa: a cross-sectional study. *BMJ open*. 2018 Aug 1;8(8):e020410.
14. Shakya KL, Shrestha N, Kisiju P, Onta SR. Association of maternal factors with low birth weight in selected hospitals of Nepal. *Journal of Nepal Health Research Council*. 2015 Dec 31.
15. Rosy N, Sultana N, Naher L, Pervin Z, Das SK, Islam MM, Khair MA, Arif KM. Risk factors of low birth weight baby. *Faridpur Medical College Journal*. 2018 Aug 24;13(1):31-4.
16. Fourie N, du Rand SM, Morton DG. Risks of preterm labour among women who attend public antenatal care clinics. *Africa Journal of Nursing and Midwifery*. 2018 Jun 1;20(1):1-6.
17. Mvunta MH, Mboya IB, Msuya SE, John B, Obure J, Mahande MJ. Incidence and recurrence risk of low birth weight in Northern Tanzania: A registry based study. *Plos one*. 2019 Apr 22;14(4):e0215768.
18. Feresu SA, Harlow SD, Woelk GB. Risk factors for low birthweight in Zimbabwean women: a secondary data analysis. *PloS one*. 2015 Jun 26;10(6):e0129705.
19. Jaques AM, Amor DJ, Baker HG, Healy DL, Ukoumunne OC, Breheny S, Garrett C, Halliday JL. Adverse obstetric and perinatal outcomes in subfertile women conceiving without assisted reproductive technologies. *Fertility and sterility*. 2010 Dec 1;94(7):2674-9.
20. Wannous S, Arous S. Incidence and determinants of low birth weight in Syrian government hospitals. *EMHJ-Eastern Mediterranean Health Journal*, 7 (6), 966-974, 2001. 2001.
21. Pinzón-Rondón ÁM, Gutiérrez-Pinzon V, Madriñan-Navia H, Amin J, Aguilera-Otalvaro P, Hoyos-Martínez A. Low birth weight and prenatal care in Colombia: a cross-sectional study. *BMC pregnancy and childbirth*. 2015 Dec 1;15(1):118.
22. Howlader M, Hossain MS. MS Relationship among Antenatal Care Practices and Socioeconomic Factors with Birth Weight of Neonates in Dhaka City. *Journal of Gynecology and Women's Health*.;8.
23. Elhassan EM, Abbaker AO, Haggaz AD, Abubaker MS, Adam I. Anaemia and low birth weight in Medani, Hospital Sudan. *BMC research notes*. 2010 Dec;3(1):1-5.



# Detection of Heavy Elements and Pathogenic Microorganisms in the Water and Sediments of Domestic Water Tanks in the Center of AL-Nasiriyah

Basim Y. Al-khafaji<sup>1</sup>, Hassan Abd Ali Namaa<sup>2</sup>

<sup>1</sup>Prof., <sup>2</sup>MBS., Thi-Qar University-College of Science Thi-Qar University-College of Science

## Abstract

The current study was conducted to show the presence of heavy elements and pathogenic microorganisms and the quality and validity of water and sediments in the household water tanks at the city center of Nasiriyah and their suitability for household and drinking uses from the autumn 2019 to summer 2020. Physical, chemical and biological checks of water were carried out in three stations, two selected stations located in the center of Nasiriyah city (1- Erido 2- Al-Salhiya), and the third station, Al-Asalah, which is located in Al-Shatrah district. Samples were collected monthly and quarterly, with three replications per station. The study included measuring the temperature of air and water, the pH, salinity, turbidity, dissolved oxygen DO, and the Biological Oxygen Demand BOD5. In addition, the concentration of four heavy elements (cadmium, copper, lead and zinc) in the water was measured in its entirety. The study included measuring the TOC content and mixing the sediment, and also the concentration of four heavy elements (cadmium, Copper, lead and zinc) are completely sediment. The study also included investigation of bacterial contamination by detecting the total numbers of aerobic bacteria, the number of coliform bacteria, the number of fecal coliform bacteria, the numbers of fecal and *Pseudomonas Aeruginosa* bacteria in the water and sediments. The results of the physical and chemical tests of water in the study stations showed that the values of air and water temperatures ranged between (20.1-40) C and (17.50-30) C, respectively, and that the water of the studied stations was basic as the pH values ranged between (7.00-8.20) The salinity values ranged between (485-837) ppm, and the turbidity values were between (2.50-6.79) NTU. The dissolved oxygen values ranged between (5.39-8.01) mg/liter, and the Biological Oxygen Demand BOD5 were between (2.93-8.5) mg/liter.

**Keywords:** Heavy elements, pathogenic, microorganisms, sediments, domestic water, tanks, AL-Nasiriyah

## Introduction

Water is one of the main and basic pillars of life, and the presence of water is necessary for the existence of life, so water pollution is one of the basic and main risks that threaten the lives of all living things, especially human life. Therefore, the water must be free from the chemical, physical and biological contaminants of drinking water,

and this water must be acceptable for being colorless, tasteless and odorless<sup>(1)</sup>. Attention has been paid by the World Health Organization, the US Environmental Protection Agency and many other health institutions to diseases that could result from water pollution and to control or prevent those diseases.<sup>(2)</sup>

**Literature Review:** Measuring the concentrations of heavy elements in the water cannot give a reliable and accurate indication of the degree of pollution due to the difference in the quantities of water discharges, the suspended load and the imbalance of the sources that throw these pollutants into the water environment. Therefore, its concentration in sediments was measured because it is the main and accurate indicator of contamination with these types of pollutants, and it is the

---

### Corresponding Author:

Hassan Abd Ali Namaa

Thi-Qar University-College of Science Thi-Qar  
University-College of Science,  
e-mail: hsnalamry315@gmail.com

direct recipient of pollutants in the aquatic environment<sup>(3)</sup> and represents an important source of heavy elements in the aqueous phase as the role of sediments is a store and transporter of heavy elements, and through the sediments we can identify the history of pollution, due to their ability to pollute and collect heavy elements significantly. It is possible that the concentration of these elements in sediments is more than (1000-10000) times than their concentration in water.<sup>(4)</sup>

### Methodology

The following were performed to 3 water samples: air and water temperatures, volumetric analysis of sediment particles, extraction of heavy elements from water, extraction of heavy metals from sediments, the culture media and isolation.<sup>(5)</sup>

### Results

- **Air and Water Temperature:** It was found that there are no significant differences. Among the stations, as no significant differences were found, as for the seasons, significant differences were recorded for all seasons. The temperatures showed a clear seasonal change during the study period, as the lowest values were during the winter season and the highest during the summer, and this can be explained by the nature of the climate in Iraq.<sup>(6)</sup>
- **The pH Values:** Results of the statistical analysis showed that there were no significant differences between the stations. This narrow range of values may be attributed to the pH in the stations during the

seasons of the year refers to the amount of industrial water that is discharged and its dissolved salts that are directly proportional to the pH value and thus be basic<sup>(7)</sup>.

- **Turbidity:** Results of the statistical analysis showed that there were no significant differences between the stations. The suspended matter that causes turbidity is organic and includes phytoplankton, animal and microscopic organisms, or inorganic materials such as soil, clay and silt particles, and turbidity is responsible for water color changes<sup>(8)</sup>.
- **Dissolved Oxygen (DO):** Results of the statistical analysis showed that there are no significant differences between the stations, but in the seasons, there are significant differences for all seasons. The highest value was recorded in the third station during the summer of 2020 and the reason for this increase may be attributed to the fast water currents, good ventilation and the continuous mixing of water<sup>(9)</sup>.
- **Biological Oxygen Demand (BOD5):** It was noticed that there were no significant differences, but in the seasons, there are significant differences for all seasons. From the results, the highest BOD5 values were observed in the third station, which is due to the arrival of organic wastes that were discarded in the river water or human and industrial activities near the first station. This may be due to rainfall and high water levels, and this result is identical to what Naji (1988) stated, and they agreed with him<sup>(10)</sup>.

**Table (1) showed the rates of the physical and chemical properties of the study stations water for the period from Autumn 2019 until Summer 2020**

Season	St.	Air Tem.		Water Tem.		pH		Salinity		Turbidity		DO		BOD	
		M	SD	M	SD	M	SD	M	SD	M	SD	M	SD	M	SD
Autumn	St.1	26.2a	.27	24.00 <sup>a</sup>	.61	7.97a	.05	837a	5.59	4.90a	3.02	6.61a	.49	6.43a	1.5
	St.2	25.1b	.41	23.00b	.70	8.00a	.07	820b	2.91	4.73a	2.84	6.63a	.36	6.35a	1.6
	St.3	25.00b	.25	23.00b	.50	7.00b	.02	785c	2.60	2.50a	1.10	6.90a	.10	8.5a	1.0
<b>LSD</b>		<b>0.77</b>		<b>1.12</b>		<b>0.30</b>		<b>4.22</b>		<b>2.99</b>		<b>0.36</b>		<b>1.75</b>	
Winter	St.1	21.0a	2.23	17.76b	.33	7.80a	.28	488b	1.78	4.27a	.62	5.39a	.50	5.67a	1.4
	St.2	22.3a	1.56	17.50b	.35	7.80a	.21	532a	6.22	4.20a	.60	5.40a	.43	5.69a	1.4
	St.3	20.1a	1.02	18.00a	.45	7.00a	.02	485b	3.50	3.00a	0.21	6.10a	.35	7.10a	.90
<b>LSD</b>		<b>3.79</b>		<b>0.54</b>		<b>0.26</b>		<b>4.84</b>		<b>0.60</b>		<b>0.47</b>		<b>1.34</b>	

Season	St.	Air Tem.		Water Tem.		pH		Salinity		Turbidity		DO		BOD	
		M	SD	M	SD	M	SD	M	SD	M	SD	M	SD	M	SD
Spring	St.1	33.6a	.54	24.00b	.00	7.96a	.04	580b	2.07	6.79a	.61	5.79a	.37	3.07a	.37
	St.2	33.6a	.54	24.80 <sup>ab</sup>	.44	8.07a	.23	592a	3.56	6.67a	.70	5.71a	.42	2.93a	.56
	St.3	33.1a	.53	24.00b	.01	7.50b	.05	575c	2.02	4.80b	.50	7.01a	.38	3.30a	.31
<b>LSD</b>		<b>0.67</b>		<b>1.28</b>		<b>0.21</b>		<b>4.62</b>		<b>0.68</b>		<b>0.52</b>		<b>0.50</b>	
Summer	St.1	39.20b	.44	29.40a	.54	8.14a	.11	757b	4.61	6.25a	.45	6.87a	.43	3.91a	.69
	St.2	39.60 <sup>b</sup>	.54	29.40a	.54	8.20a	.07	780a	3.56	6.31a	.47	6.90a	.40	3.93a	.72
	St.3	40.00a	.01	30.00a	.71	7.60b	.10	730c	2.21	5.40b	.39	8.01a	.39	4.90a	.68
<b>LSD</b>		<b>0.55</b>		<b>0.85</b>		<b>0.12</b>		<b>4.22</b>		<b>0.57</b>		<b>0.44</b>		<b>0.77</b>	

- Sediment Total Organic Carbon Content (TOC %):** The statistical analysis revealed that there are significant differences between the stations. Human activities and natural processes lead to an increase in the carbon concentration of total organic matter in the sediments. Likewise, organic carbon in sediments increases with small grain size (silt) and has great affinity for new crystalline deposits<sup>(11)</sup>.

**Table (2): TOC% rates for study stations for the period from Fall 2019 until Summer 2020**

TOC	Autumn		Winter		Spring		Summer	
	M	SD	M	SD	M	SD	M	SD
St1	2.41b	.44	2.18b	.09	3.56a	.12	4.12a	.16
St2	3.24a	.85	3.61a	1.26	3.50a	.48	3.86b	.05

- Volumetric Analysis of Sediment Particles:** The statistical analysis showed statistically significant differences of sediment mixture between the stations. The results showed that the sediment mixture was Clay-silty in all the stations studied. The percentage of soil plays an important role in determining the quality of the sediment, as it affects the ability of the sediment to retain the ions of heavy elements, organic matter and salts in quantitatively and qualitatively<sup>(12)</sup>, the more small-diameter granules are, the more quantities are preserved.

**Table (3) showed mixing rates of sediments%**

		St.1	St.2
Autumn	Sand	10.3	17.5
	Clay	48	50
	Silt	41.7	32.5
Winter	Sand	5.1	6.2
	Clay	54.8	55.1
	Silt	40.1	38.7
Spring	Sand	1.7	2.4
	Clay	50.1	56.7
	Silt	48.2	40.9
Summer	Sand	18.1	22.4
	Clay	40.9	50.4
	Silt	41	27.2

- Heavy Elements in Water:** The results of the current study showed that the average levels of concentrations of heavy elements in the water for the three study stations of cadmium, copper, lead and zinc (5.32, 0.46, 0.00432, 0.0052) mg/liter, respectively, as an input of heavy elements in the aquatic environment changes over time, and the main factor that effects on this change in element concentrations is the receipt of water for untreated household, agricultural and industrial wastes, and the

highest concentrations of elements were recorded in the summer and the lowest in the fall. This may be due to differences in water levels between seasons, as high water leads to dilution and dispersion of elements, and that the change in the level of water level It contains two-fold concentrations of heavy elements, for example, high water levels reduce the concentrations of heavy elements in the water, and their decrease leads to an increase in the concentrations of these elements<sup>(13)</sup>.

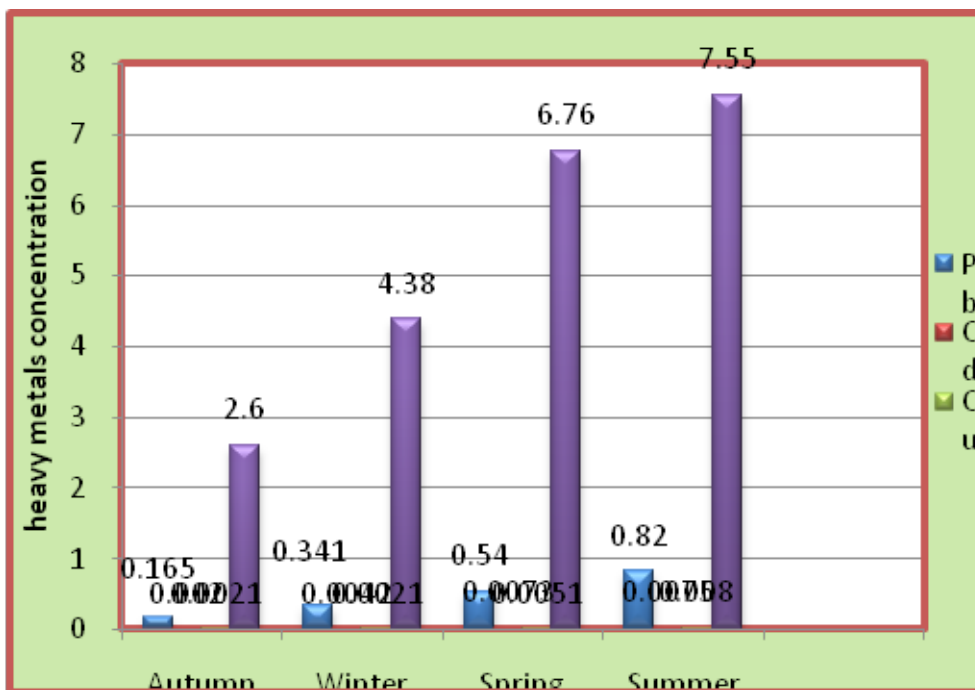


Figure (1) Shows the annual rate of heavy elements in water

- Total Number of Aerobic Bacteria (TBC):** The results of the statistical analysis recorded the presence of significant differences between the stations. This group represented mostly the bacteria that enter the water from sewage waste and the types of bacteria that wash with the soil into water bodies during the rainy and flood seasons, in addition to the original bacteria present in the water and the types of pathogenic bacteria, including optional aerobic and anaerobic bacteria<sup>(14)</sup>.
- Total Coliform Bacteria Count (TC):** The results of the statistical analysis recorded the presence of significant differences between the stations. Coliform bacteria are usually found in the intestines of human and warm-blooded animals and are

associated with pathogenic bacteria, which is an appropriate microbial indicator to determine the quality of drinking water due to its ease of detection and calculation<sup>(15)</sup>.

- Number of Fecal Coliform Bacteria (FC):** Statistically, significant differences were recorded between stations except for the second and third stations. No significant difference was recorded between them. Bacteria E. coli is a fecal source due to its permanent presence in human feces and other mammals and birds in large numbers and is rarely found in soil or water not contaminated with fecal waste<sup>(16)</sup>.
- Counts of Fecal Coliform Bacteria (FSb):** Statistically, a significant difference was recorded

between the stations, as no significant difference was recorded between the second and third stations. The current study recorded the highest rates of fecal coliform bacteria in the first station during the summer of 2020, and this may be due to the previously mentioned reasons about the rates of coliform bacteria and the plant itself. Seasonal changes also play a role in increasing the numbers of this bacterium<sup>(17)</sup>.

**Conflict of Interest:** Nil

**Source of Funding:** Self

**Ethical Clearance:** Not required

### References

1. Al-Fatlawi, Y .F. Study of drinking water quality for some Baghdad water liquefaction projects. PhD thesis, College of Science, University of Baghdad. College of Science.(2007).
2. Al-Jubouri, A.A. Study of microbial evidence of biological pollution and some physical and chemical factors on them of the waters of the Tigris and Zab rivers in Hawija and Tikrit, Master Thesis, College of Education, University of Tikrit(2005.).
3. Van den Broek, J.L.; Gledhill, K.S. and Morgan, D.G. Heavy metal concentrations in the Mosquito fish, *Gambusia Holbrooke*, in the manly Lagoon Catchment. UTS Fresh water Ecology, Department of Environmental Science, university of Technology, Sydney.(2002).
4. Al-Khafaji, B.Y. Preliminary survey of selected heavy metals in Al-Jubayla creek connected with Shatt Al-Arab River. *Marina Mesopotamica*. (2000). 15(1): 69 -80.
5. Yi, L, Hong, Y, Wang, D and Zhu, Y. 'Determination of free heavy metal ion concentrations in soils around a cadmium rich zinc deposit', *Geochemical Journal*, (2007), vol. 41, no. 4, pp. 235-40
6. Al-Lami, A. A. The water quality of the Tigris sediments before and after the city of Baghdad - Iraq. *Iraqi Journal of Biology*, (2002). 296-289: (2) 2.
7. Al-Zamili, T. F; Abdul-Hussein, M. A. Evaluation of the physical and chemical properties of the waters of the DhiQar Marshlands. *Al-Qadisiyah Journal of Pure Sciences*, (2009). 14 (1): 182-191.
8. Helfric L.A.; Jams, P. and Richard, N. Guide to understanding and managing lakes, part 1, physical measurement publication, (2005). PP: 420- 538.
9. Abdul-Jabbar, R. A and al-Lami, A. A and Rushdie, S. A. The concentrations of some elements in the waters of the Tigris River and the Lower Zab tributary. *Tikrit University Journal of Agricultural Sciences*, (2006). 67-56: (1) 6.
10. Al-Samarrai, B. A. M. An environmental and microbial study of liquefied water in Salah al-Din Governorate, Master Thesis, College of Science, Tikrit University, (2009). p. 122.
11. Al-Aqili, N. H. The Environmental Reality of Drinking Water in Baghdad Governorate. The specialized symposium towards healthy and safe drinking water for the Iraqi citizen. Ministry of Higher Education and Scientific Research, University of Baghdad, Market Research and Consumer Protection Center.(2007).
12. Al-Asadi, W. M. Phenotypic and ecological study of *Hydrilla verticillata* (L.F) Royle. Master Thesis, College of Science - University of Basra,(2009).
13. Szymanowska, A.; Samecka, A. and Kempers, A.J. (1999). Heavy metals in three lakes in west Poland *Ecotoxicol – Envi. Saf.* 43(1): 9 – 21.
14. Al-awady, A.A.M. Concentrations of some trace metals in water, sediments and two cyprinidae species in Al-Masab Alamm, Al-Nassiriya, Iraq. Ph.D. Thesis, College of Science for Women, Baghdad University.(2012). p 191
15. World Health Organization (WHO). *Guideline for Drinking Water Quality*. (2nd Ed.). Health Criteria and other Supporting Information, Geneva.(1996).
16. Edberg, S.C.C.; Rice, W.W.; Karlin, R.J. and Allen, M.J. E. coli the best biological drinking water indicator for public health protection. *J. App. Microb.*, (2000). 88: 106-116.
17. Gary, H.I. and Adams, J.C. Indicator bacteria in water and stream sediments near the snowy Range in Southern WYON Ming. *Water, air and Soil Pollution*, (1985). 25 (2): 133-144
18. Mena, K. D. and C. P. Gerba. Risk assessment of *Pseudomonas Aeruginosa* in water. *Reviews of Environmental Contamination and Toxicology*, (2009) .vol. 201, Spring US, p: 71 – 115.

# Appraisal the Quality of Drinking Tap Water in Different Regions of Kirkuk City

Batool Kh. Mohammad<sup>1</sup>, Kameran Sh. Husien<sup>2</sup>, Israa Zainal<sup>1</sup>

<sup>1</sup>Assistant Lecturer. College of Science, Kirkuk University-Kirkuk, Iraq,

<sup>2</sup>Professor, College of Science, Kirkuk University-Kirkuk, Iraq

## Abstract

This study was conducted to demonstrate the suitability of drinking tap water from different regions of Kirkuk city by analyzing some chemical and physical properties included (temperature, pH, turbidity, electric conductivity, total soluble solids, total hardness, total suspended solids, nitrates, calcium, magnesium, chloride, sulfate, sodium and phosphate) and eight heavy metals concentration including (Cd, Cr, Cu, Fe, Zn, Ni, Mn and Mg) which have been detected in drinking water. The drinking tap water of Kirkuk city processed by the Directorate of Kirkuk's water for human consumption, all data compared with (IQS 417/2001) except for temperature. The results offered that the concentrations of 8 studied metals are little than National Standards Organization of Iraq (IQS) except for (Ni) which is found to be high (12.267mg/L) dose which not meet specifications, the results were analyzed using the analytic Jena AAS NOVAA 350. The results of chemical and physical properties compared with drinking water standards displays that the concentration of studied chemical and physical are little than the estimated levels that were announced by the National Standards Organization of Iraq (IQS) except for two analysis (turbidity and total soluble solids) were found to be highest rate (6.9NTU) and (79mg/L) respectively which does not meet specifications.

**Keywords:** *Heavy metals, drinking tap water, water quality.*

## Introduction

Water pollution is one of the most important challenges. It has been proven that half of the world's rivers were severely polluted with decrease in the level of water. Water pollution include two sources: (point and non-point) source.<sup>1</sup> Point sources are effectively identifiable sources, including: oil effuse from a tanker, igniter from a factory, wastewater streaming (both municipal and manufacturing) and storm sewer discharges and affect mostly the area near it, while, non-point sources are those of different sources of origin and the number of ways in which pollution has

occurred in groundwater or surface water and in the area near it like runoff from agricultural fields, urban waste...etc. Sometimes environmental pollution in one place has an influence hundred or even thousands of miles away, which is known as trans-border pollution.<sup>2</sup> Water pollutants may be organic pollutants (comprise of insecticides and herbicides, organo -halides and other forms of chemicals; bacteria from sewage and lives tocks farming; food processing wastes; pathogens; volatile organic compounds ... etc.) and inorganic pollutants (may emerge from heavy metals which arise from acid mine drainage; silt from surface run-off, logging, slash and burning practices and land filling; fertilizers from agricultural run-off which include nitrates and phosphates... etc. and chemical waste from industrial manufacturing effluents).<sup>1</sup> Heavy metals are known as metallic elements that have a comparatively high density and specific gravity (about five times) compared to water,<sup>3,4</sup> they exist on the earth with different ratios in rocks and soil depending on their location. They are released from rocks by weathering processes to form soil

---

### Corresponding Author:

**Kameran Sh. Husien**

Professor, College of Science, Kirkuk University-  
Kirkuk, Iraq

e-mail: kamerandalo@uokirkuk.edu.iq

and are bio-geochemically cycled to form rocks again in a natural cycle. Inorganic heavy metals as pollutants cannot degrade like organic pollutants and turn to harmless products but continue and accumulate in the soil.<sup>5,6</sup> Naturally water contain different concentrations from heavy metals,<sup>7, 8</sup> some of them are essential for the aquatic life, and others are toxic. Accumulation and distribution of metals in the aquatic system dependent on the sediment texture, mineralogical composition and physical transport.<sup>9</sup> Heavy metals sources in water may be from waste water without treatment, industries effluents and contamination with heavy metals ions.<sup>10</sup> Surface water is much exposable to contamination by heavy metals due to untreated sewage and factory waste into rivers and lakes.<sup>11</sup> The importance of heavy metals is getting more for their accumulation through tropic level and non-degradable nature causing a deleterious biological effect.<sup>12, 13</sup> The deadlier diseases like edema of eyelids, tumor, congestion of nasal mucous membranes and pharynx, stuffiness of the head and gastrointestinal, muscular, reproductive, neurological and genetic distortions caused by some of these heavy metals have been documented.<sup>14</sup> Subsequently, monitoring heavy metals is important for safety assessment of the environment and human health in particular.<sup>12, 15</sup> Also, to evaluate the status of the river water quality with respect

to drinking and agricultural irrigation purposes.<sup>16</sup> Heavy metals are absorbed through the orally, inhalation and/or skin. Regardless of the manner of heavy metal entry in the body, the blood circulatory system is possibly the first to be affected following exposure and adverse effects on blood coagulation can lead to associated thrombotic disease.<sup>17</sup> The aim of this study is to evaluate the quality of water, with respect to its heavy metal contamination index method for drinking tap water quality in different regions of Kirkuk city.

## Materials and Method

**The Studied Regions:** Kirkuk city located in the north part of Iraq, between ((44° 15'00" -44° 30'00"E) and (35°19'00"-35° 32'00" N)<sup>18</sup> (figure 1).

Khassa is Crisp River flux from north - east to south-west across the central of Kirkuk city. The study region is characterized by arid to semi-arid climate. And the main river that requires the major water source to Kirkuk governorate is Lasser Zab. The length of Lesser river is 400 km, and its catchment area is about 22,250 km<sup>2</sup>.<sup>19</sup> Generally, this region consists of industrial, domestic, agricultural and oil fields site. Oil is the major source of its economic efficacies.



Kirkuk City (1) Gharnata. (2) Quria. (3) Hazir. (4) Shorja . (5) Shurau. (6) Raheem Awa. (7) Arafa. (8) Khadraa. (9) Wasty.

**Figure 1. Map of Iraq showing the sample region in Kirkuk city.**

**Samples Collection:** The samples of drinking tap water were collected by following the quality sample assortment protocol and tips given in Central Organization for Quality Control and Standardization, Council of Ministers, Republic of Iraq (IQS 417/2001) results,<sup>20</sup> in November 2019 from regions which is next: Gharnats, Quria, Haziran, Shorja, Shurau, Raheem Awa, Arafa, Khadraa and wasty. Drinking water sample were collected in 1 liter capacity plastic bottles. Before sampling, the special precautions were taken throughout the sampling of water within the elite places of study regions. Before the gathering of the samples, the bottles were washed with cleaner directed by tap water and different times rinse with distilled water. The water at the sample locations were allowed to rinse for several time then the bottles were rinse thrice with this water and 1 liter was taken as sample from each source of water. The samples were preserved at 4°C until used.

### Sample preparation and experimental analysis

#### Samples were prepared by following two steps:

[1] The first step including determination of physico-chemical properties (pH, electrical Conductivity (E.C°), temperature (C°) and total dissolved solid (T.D.S)) for drinking tap water. The pH of the drinking tap water samples was measured using a pH meter, which calibrated, with two standard solutions (pH 4.0 and 7.0). The conductivity, temperature and total dissolved solid of the samples was measured using a conductivity meter. The probe was calibrated using a standard solution with a known conductivity. [2] The second step including the laboratory performed which include: The analyses of eight heavy metals including (Cu,

Zn, Mg, Fe, Cd, Mn, Cr and Ni) using Flame atomic absorption spectrophotometer (AA-6800 AAS coupled with GFA-EX7 graphite furnace atomizer and ASC-6100 auto sampler from Shimadzu (Koyoto, Japan), for samples. The standard solution for each tested element was prepared according to its concentration and used to calibrate the system before analyzing each water sample. The device automatically recorded focus and results of statistical analysis in Standard Deviation (SD) and Relative Standard Deviation (RSD).

Concentrations of elements were estimated using the analytic jena AAS NOVAA 350, which uses acetylene gas as fuel for both Cd, Mg, Mn, Fe, Cu, Ni, Zn, Cr respectively, and used air as a Catalyst for all elements. The Liquid spray rate 4ml/min at wavelengths was 228.8, 285.2, 279.5, 248.3, 324.8, 232, 213.9, 357.9 (nm) respectively. Also, Standard analytical chemistry method and EDTA were used to measure the Ca and total hardness, Argentometric method is used to measure the Cl and the Mg using calculation method. The phosphate was measured Vanadomolybdo phosphoric acid colorimetric method, Flam emission Photometer is used to measure the Sodium and the sulfute using Gravimetric method. For the turbidity used turbidity meter. Measurement of the TSS by gravimetric method. Finally, using Brucine method to measure nitrate.

### Results and Discussion

Table (1) shows the values of the analyzed physiochemical parameters of drinking tap water from different regions in Kirkuk city.

**Table (1): Physiochemical parameters of drinking tap water from different regions in Kirkuk city**

Region	pH	T (C°)	EC° (µs/cm)	*TDS (mg/l)	Turbidity (NTU)	**TSS (mg/l)
Gharnata	8	20.9	388	179	5.9	69.3
Quria	7.8	20.6	386	177	6.4	73.7
Haziran	7.9	19.9	410	185	6.9	79
Shorja	7.9	20.2	386	175	6.1	71.3
Shurau	8	21.5	556	259.3	4.4	54
Raheem Awa	7.9	20.4	411	188	5.6	68.7
Arafa	7.7	24.2	397	195.3	4.8	58
Khadraa	8.1	20.6	410	188	6.5	68.3
Wasty	8	20.2	407	181.3	5.8	75

\*TDS :total Dissolved solids, \*\* TSS :total Suspended Solids.



The obtained pH values ranged from 7.7 to 8.1 with an overall mean of (7.9), the permissible limit of pH is given as (6.5-8.5) by IQS/417. The highest value found in Khadraa region and the lowest in Arafa region of Kirkuk city, note that it conform to the specification, indicating that the during tap water in Kirkuk city is alkaline (pH >7). Furthermore, there are no remarkable variations in sampling sites, and thus, it can be concluded that the water treatment and purification method had only a small effect on the hydronium ion concentration.<sup>21</sup> The temperature results indicated that the highest temperature of drinking tap water were found in the Arafa region while the lowest in the Haziran region, the temperature ranges between (19.9 - 24.2C<sup>o</sup>) with an overall mean of (20.9C<sup>o</sup>), the water temperature changes with the change in weather. Measurement is necessary because it affects various water properties such as (viscosity, density, solubility) of chemicals and bacteriological activity. The temperature affects chlorine effectiveness in water sterilization where chlorine is more effective in sanitizing water with increasing water temperature,<sup>22</sup> as cleared in the table (1). The E.C<sup>o</sup> of the regions to drinking tap water of Kirkuk city was measured and found that the highest value in Shurau region while the lowest value in Shorja and Quria regions, where the E.C<sup>o</sup> ranged between (386 – 556) µs/cm with an overall mean of (416) µs/cm as presents in table (1), the permissible limit of E.C<sup>o</sup> is given as 1000 µg/cm by IQS/417, note that

it conform to the specifications. There is a relationship between turbidity and water quality, also a between turbidity and bacterial content in water, the turbidity lower the chlorine's effectiveness in sanitizing the water and therefore water need more chlorine to eliminate the bacteria and pathogens.<sup>23</sup> The analysis showed that the rang value of turbidity within the range of (4.4-6.9) NTU with an overall mean of (5.65) NTU as in presents table (1), the regions of drinking tap water Kirkuk city results found that the highest value in Haziran region and the lowest value in Shurau region. the permissible limit of turbidity is given as 5 NTU by IQS/417 and found that it does not comply with the specifications. The T.S.S consists of organic and clay materials, and contains some microorganisms such as algae and bacteria. In the current study the values of T.S.S ranged from (54 to 79) mg/L and TSS an overall mean of (68) mg/L of the regions to drinking tap water of Kirkuk city and found the highest value in Haziran region and the lowest value in Shurau region as cleared in table (1). The permissible limit of T.S.S is given as 0mg/L by IQS/417, and it does not comply with the specifications. The T.D.S of the regions to drinking tap water of Kirkuk city was measured and found that the highest value in Shurau region while the lowest value in Shorja and Quria regions, where the T.D.S ranged between (175 – 259.3) mg/L with an overall mean of (191) mg/L as presents in table (1).

**Table (2): Chemical analysis of drinking water in the city of Kirkuk:**

Region	Po <sub>4</sub> <sup>-3</sup> (mg/l)	Total Hardness (mg/l)	Ca <sup>+2</sup> (mg/l)	Mg <sup>+2</sup> (mg/l)	Cl <sup>-</sup> (mg/l)	Na <sup>+</sup> (mg/l)	So <sub>4</sub> <sup>-2</sup> (mg/l)	NO <sub>3</sub> <sup>-</sup> (mg/l)
Granda	1.98	178	37.3	21.3	16.7	9.3	38	7.076
Quria	2.383	182	38.7	20.8	16.7	9.33	38.1	7.64
Haziran	1.7	182	38	21.13	16.6	9.5	36.7	7.25
Shorja	1.45	182	38.7	20.9	16	9.3	36	7.125
Shurau	1.323	195	47.3	18.63	23.3	14.7	46	7.162
Raheem Awa	1.625	178	36	21.5	13.3	9.3	33.3	7.458
Arafa	1.348	182	38.7	20.8	16	9.7	35.3	7.69
Khadraa	1.953	183.7	37.7	21.83	17.3	10.7	34	7.209
Wasty	1.653	185	38.7	21.6	17.3	10.3	34	6.758

The PO<sub>4</sub><sup>-3</sup> of drinking tap water regions of Kirkuk city, found to be higher value in Quria region and lower rate in Shurau region, where the PO<sub>4</sub><sup>-3</sup> ranges between (1.323 – 2.383) mg/L with an overall mean of (1.7) mg/L

as in table (2). The permissible limit of PO<sub>4</sub><sup>-3</sup> is given as 3 mg/L by IQS/417, it conform to the specifications. The total hardness and Ca<sup>+2</sup> of the above regions drinking tap water of Kirkuk city was measured and found that the

highest value in Shurau region and the lowest value in Raheem Awa region, where the total hardness is between (178 – 195) mg/L with an overall mean of (183) mg/L,  $\text{Ca}^{+2}$  is ranges between (36 – 47.3) mg/L with an overall mean of (39) mg/L as clear in table (2), the permissible limit of total hardness is given as 500 mg/L and  $\text{Ca}^{+2}$  is concentration equal to 50mg/L by IQS/417 and it conform to the specifications. The measuring  $\text{Mg}^{+2}$  of drinking tap water in different regions of Kirkuk city cleared that higher value in Khadeaa region and the lower value in Shurau. The  $\text{Mg}^{+2}$  ranges between (18.63 – 21.83) mg/L with an overall mean of (20.94) mg/L as in table (2), the permissible limit of  $\text{Mg}^{+2}$  is given as 50 mg/L by IQS/417, note that it conform to the specifications. Measuring the  $\text{Na}^{+}$  and  $\text{Cl}^{-}$  concentration of the drinking tap water of Kirkuk city, the results indicated that the Higher value were in shurau region and the lower value in Raheem Awa region, where the  $\text{Na}^{+}$  ranges between (9.3 - 14.7) mg/L with an overall mean of (10) mg/L, and  $\text{Cl}^{-}$  ranges between (13.3 – 23.3) mg/L with an overall mean of (17) mg/L as in table (2), the permissible limit

of  $\text{Na}^{+}$  is 200 mg/L and  $\text{Cl}^{-}$  as 250mg/L by IQS/417, they conform to the specifications. The  $\text{SO}_4^{-2}$  concentration of the drinking tap water regions of Kirkuk city found that the higher value in Shurau region and the lower value in Raheem Awa region, where the  $\text{SO}_4^{-2}$  ranges between (33.3 – 46) mg/L with an overall mean of (37) mg/L as in table (2), the permissible limit of  $\text{SO}_4^{-2}$  is given as (250) mg/L by IQS/417 and it conform to the specifications. The  $\text{NO}_3^{-}$  concentration was measured of the drinking tap water regions of Kirkuk city and found that the higher value in Quria region and the lower value in Wasty region, where the  $\text{NO}_3^{-}$  ranges between (6.758 – 7.69) mg/L with an overall mean of (7.2) mg/L as in a table (2), the permissible limit of  $\text{NO}_3^{-}$  is given as (50) mg/L by IQS/417, it conform to the specifications. The concentration of Cu in the drinking tap water samples ranges from (0 - 0.526) mg/L with the average of (0.2012) mg/L as in a table(3). The permissible limit of Cu is specified as 1 mg/L by IQS/417, it conform to the specifications.<sup>24</sup>

**Table (3): The values of (Cu, Ni, Zn) by Flame atomic absorption spectrometer of drinking tap water in different regions of Kirkuk city:**

Region	Copper			Nickel			Zinc		
	mg/l	SD	RSD[%]	mg/l	SD	RSD[%]	mg/l	SD	RSD[%]
Gharnda	0.3505	0.02583	7.369	7.235667	1.3223	63.854	N.D	N.D	N.D
Qurial	0.525867	0.105645	17.44033	8.993	1.15415	11.397	N.D	N.D	N.D
Haziran	0.215	0.10116	29.92667	8.657	1.149	15.525	N.D	N.D	N.D
Shorja	0.08215	0.2549	310.3	12.26733	1.321433	9.491	N.D	N.D	N.D
Shurau	0.08215	0.2142	327	6.792	1.792	26.57	N.D	N.D	N.D
Raheem Awa	0.0655	0.1492	75.65	4.718	2.03135	41.695	N.D	N.D	N.D
Arafa	0.08715	0.161935	201.085	3.901	0.583733	14.02333	N.D	N.D	N.D
Khadraa	N.D	N.D	N.D	5.6755	0.9523	14.8515	N.D	N.D	N.D
Wasty	N.D	N.D	N.D	0.9442	0.7812	133.075	N.D	N.D	N.D

The concentration of Ni in the drinking tap water samples ranges from (0.9442– 12.267) mg/L with the average of (6.5759) mg/L as in a table (3). The permissible limit of Ni is given as 0.02 mg/L IQS/417 for drinking tap water, all samples did not meet the permissible limits of IQS/417. The high Ni concentration was sound in samples of Shorja, Huzairan and Quria regions and the lower region in Wasty region.<sup>25</sup> The concentration of Zn of the different regions drinking

tap water of Kirkuk city, did not reach the percentage of Kirkuk city regions as in table (3). The permissible limit of Zn is given as 3 mg/L IQS/417 for drinking tap water. Each specimen was within the permissible limits of IQS/417.<sup>26</sup> The concentration of Fe in the drinking tap water samples ranged from (0- 0.0205) mg/L with the average of (0.01907 mg/L) mg/L as in a table (4). The permissible limit of Fe is given as 0.3 mg/L IQS/417 for drinking water. Each the specimens

were within the permissible limits of IQS/417. The high Fe concentrations were noticed in Gharntaa and Quria samples of the study regions but there are not in Wasty,

Khadraa, Arafa, Raheem Awa, Shurau and shorja of the study regions.

**Table (4): Measurement of (Cd, Mn, Fe) by Flame atomic absorption spectrometer of drinking**

Region	Iron			Cadmium			Manganese		
	mg/l	SD	RSD[%]	mg/l	SD	RSD[%]	mg/l	SD	RSD[%]
Gharnata	0.020503	0.000794	4.364667	N.D	N.D	N.D	0.00299	0.000033	1.162333
Quria	0.018338	0.003821	48.9585	N.D	N.D	N.D	0.003707	0.0000497	1.474667
Haziran	0.01837	0.01378	75.04	N.D	N.D	N.D	0.004415	0.0000477	1.081667
Shorja	N.D	N.D	N.D	N.D	N.D	N.D	0.00464	0.0000213	0.433667
Shurau	N.D	N.D	N.D	N.D	N.D	N.D	0.005815	0.000055	0.968
Raheem Awa	N.D	N.D	N.D	N.D	N.D	N.D	0.005989	0.0001017	1.678
Arafa	N.D	N.D	N.D	N.D	N.D	N.D	0.006336	0.000037	0.616667
Khadraa	N.D	N.D	N.D	N.D	N.D	N.D	0.007591	0.0000297	0.390333
Wasty	N.D	N.D	N.D	N.D	N.D	N.D	0.007587	0.0000577	0.767667

The concentration of Mn in the drinking tap water samples ranges from (0.00299- 0.007591) mg/L with the average of (0.005452) mg/L as in a table (4). The permissible limit of Mn is given as 0.1 mg/L IQS/417 for drinking water. Each the specimens were within the permissible limits of IQS/417. The higher Mg concentrations were noticed in samples khadraa and Wasty of the study regions and the lower rate in Gharnata of the study region. The levels of Cd present in drinking tap water of Kirkuk city appeared that did not get a

percentage in the different regions of Kirkuk city as in a table (4). The permissible limit of Cd is given as 0.003 mg/L IQS/417 for drinking tap water. Each the specimens were within the permissible limits of IQS/417. The Cr levels of the drinking tap water regions of Kirkuk city did not get a percentage in the regions of Kirkuk city as in a table (5). The permissible limit of Cr is given as 0.05 mg/L IQS/417 for drinking water. Each the specimens were within the permissible limits of IQS/417.<sup>27</sup>

**Table (5): Mg and Cr concentration by Flame atomic absorption spectrometer of drinking tap water of Kirkuk city.**

Region	Magnesium			Chromium		
	mg/l	SD	RSD[%]	Mg/l	SD	RSD[%]
Gharnata	0.450333	0.003441	0.770667	N.D	N.D	N.D
Quria	0.380933	0.003969	1.042	N.D	N.D	N.D
Haziran	0.5796	0.003767	0.745333	N.D	N.D	N.D
Shorja	0.450967	0.003913	0.803	N.D	N.D	N.D
Shurau	1.187667	0.016068	1.777	N.D	N.D	N.D
Raheem Awa	0.628867	0.002311	0.392333	N.D	N.D	N.D
Arafa	0.622	0.010647	1.579333	N.D	N.D	N.D
Khadraa	0.635067	0.006713	0.849	N.D	N.D	N.D
Wasty	0.3641	0.001564	0.431333	N.D	N.D	N.D

The level of Mg of the drinking tap water samples ranges from (0.3641- 1.187667) mg/L with the average of (0.5888) mg/L as in a table (5). The permissible limit of Mg is given as 50 mg/L IQS/417 for drinking water. Each the specimens were within the permissible limits of IQS/417. The higher Mn levels were noticed in samples Shurau and Khadraa of the study regions and the lower value in Wasty of the study region. Likewise, Mg, Mg<sup>+2</sup> was measured in search and these was a large difference between atom-shaped Mg and ion-shaped magnesium,

the reason for this relates to some of the interference that has been challenged due to the presence of some element ions that lead to interference with the magnesium ion.<sup>28</sup>

Table (6) cleared the water quality characteristics according to Iraqi specifications, (minimum, maximum and average) concentration of heavy metals, chemical and physical properties of drinking tap water sample of the studied regions.

**Table (6): Classifying water quality characteristics of drinking tap water sample of the studied regions.**

Parameters	Unit	(IQS 417/2001)	Min	Max	Average
pH	-	6.5-8.5	7.7	8.1	7.9
TDS	mg/l	1000	175	259.3	191.988
TSS	mg/l	0	54	79	68.588
NO <sub>3</sub> <sup>-2</sup>	mg/l	50	6.758	7.69	7.26311
Mg	mg/l	50	18.63	21.83	20.9433
Ca	mg/l	50	36	47.3	41.65
SO <sub>4</sub> <sup>-2</sup>	mg/l	250	33.3	46	36.822
Cl <sup>-</sup>	mg/l	250	13.3	23.3	17.022
Na <sup>+</sup>	mg/l	200	9.3	14.7	10.236
PO <sub>4</sub> <sup>-3</sup>	mg/l	3	1.323	2.383	1.712
Cd	mg/l	0.003	N.D	N.D	N.D
Cr	mg/l	0.05	N.D	N.D	N.D
Cu	mg/l	1	0.0655	0.5258	0.2011
Fe	mg/l	0.3	0.01833	0.0205	0.01907
Zn	mg/l	3	N.D	N.D	N.D
Ni	mg/l	0.02	0.9442	12.2673	6.5759
Mn	mg/l	0.1	0.0029	0.0076	0.0055
Mg	mg/l	50	0.3641	1.1876	0.5888
E.C <sup>o</sup>	mg/l	1000	386	556	416.77
Total hardness	mg/l	500	178	195	183.1
Turbidity	NTU	5	4.4	6.9	5.65

## Conclusions

Twenty-seven samples of drinking water were collected in Kirkuk region. From the samples analysis the following heavy metal, chemical and physical properties (range) were obtained (in mg/L): pH(19.9-24.2), T.D.S(175-259.3), T.S.S(54-79), NO<sub>3</sub><sup>-2</sup> (6.758-7.69), Mg<sup>+2</sup> (18.63-21.83), Ca<sup>+2</sup> (36-47.3), So<sub>4</sub><sup>-2</sup> (33.3-

46), Cl<sup>-</sup> (13.3-23.3), Na<sup>+</sup> (9.3-14.7), Po<sub>4</sub><sup>-3</sup> (1.323-2.383), Cd (0), Cu(0.0655-0.5258), Cr(0), Fe(0.01833-0.0205), Zn(0), Ni(0.9442-12.2673), Mn (0.0029-0.0076), Mg (0.3641-1.1876), E.C<sup>o</sup> (386-556), total hardness (178-195), Turbidity (4.4-6.9NTU) and temperature (19.9-24.2C<sup>o</sup>). The results showed that the concentrations of 8 studied metals are little than (IQS) except for (Ni) which is found to be high (12.267mg/L) dose which not meet

specifications, the mean concentrations of the metals were observed in the order: Ni>Mg>Cu>Fe>Mn>Zn>Cd>Cr. The results of chemical and physical properties compared with drinking water standards displays that the concentration of studied chemical and physical are little than the estimated levels that were announced by the (IQS) except for two analysis(Turbidity and total soluble solids) were found to be highest rate(6.9NTU) and (79mg/L) respectively which does not meet specifications. But a tap water and equipped by the Directorate of Water Kirkuk has been found to occur large variations between regions in the physical, chemical characteristics and heavy metal despite being processed from the same source was due to the poor quality of networks, processing and leaks in pipelines causing water pollution.

**Conflict of Interest:**None of the authors have any conflicts of interest to declare.

**Source of Funding:**The research was performed independently, there is no funding

**Ethical Clearance:**The project was approved by the local ethical committee in University of Kirkuk.

### References

1. Singh, M. R., & Gupta, A. Water pollution-sources, effects and control, 2017.
2. Mishra, R. K., & Dubey, S. C. Fresh water availability and its global challenge. *International Journal of Engineering Science Invention Research & Development*, 2015;2(4), 2349
3. Tchounwou, P. B., Yedjou, C.G., Patlolla, A. K., & Sutton, D. J. Heavy Metals Toxicity and the Environment. *EXS*, 2012; 101, 133.
4. H. R. Habib, S. M. Awadh, & M. Z. Muslim. Toxic Heavy Metals in Soil and Some Plants in Baghdad, Iraq. *J. Al-Nahrain Univ.*, 2012;15(2), 1–16.
5. A. M. Aenab & S. K. Singh. Evaluation of Drinking Water Pollution and Health Effects in Baghdad, Iraq. *J. Environ. Prot. (Irvine, Calif.)*, 2012; 3,533–37.
6. Sankhla, M. S., Kumari, M., Nandan, M., Kumar, R., & Agrawal, P. Heavy metals contamination in water and their hazardous effect on human health-a review. *Int. J. Curr. Microbiol. App. Sci*, 2016; 5(10), 759-66.
7. Verma, R., & Dwivedi, P. Heavy metal water pollution-A case study. *Recent Research in Science and Technology*, 2013; 5(5).
8. M. A. Mashkool. Concentrations of some heavy metals in water, sediments and two types of plants in Al-Chibayish Marsh in Thi-Qar province in southern Iraq. M.Sc. Thesis, University of Queensland, Australia. 2012.
9. M. A. Habeeb & A. K. Al-bermani. Environmental study of water quality and some heavy metals in water, sediment and aquatic macrophytas in lotic ecosystem, Iraq” *Mesopotamia Environ. J.*, 2015; 1(2). 66–84.
10. M. N. Abbas & F. S. Abbas. Utilization of iraqi rice husk in theremoval of heavy metals from wastewater. *Res. J. Environ. Earth Sci.*, 2013; 5(7). 370–80.
11. A. Hameed, M. J. Al-Obaidy, A. A. M. Al-Mashhady, E.S. Awad, & A. J.Kadhem. Heavy Metals pollution in Surface water of Mahrut River, Diyala, Iraq. *Int. J. Adv. Res.*, 2014; 2(10). 1039-44.
12. S. Morais, F. Garcia, & M. L. Pereira. Heavy Metals and Human Health. *Environ. Heal. Emerg. Issues Pract.*, 2012.
13. Bruins, M. R.; Kapil, S.; Oehme, F. W. Microbial resistance to metals in the environment. *Ecotox. Environ. Safe.*, 2000; 45, 198-207.
14. Tsuji, L. J. S.; Karagatzides, J. D. Chronic lead exposure, body condition and testis mass in wild Mallard Ducks, B. *Environ. Contam. Tox.*, 2001; 67, 489-495.
15. I. K. Al-mayaly. Determination of some heavy metals in some artificial fruit juices in iraqi local markets. *Int. J. Res. Dev. Pharm. Life Sci.*, 2013;2(4). 507–10.
16. L. H. Ibraheem & S. A. Abed. Accumulation detection of some heavymetals AL-Diwaniyah City, Iraq. *RASAYAN J. Chem*, 2017; 10(2).339–43.
17. Wu, X., Cobbina, S. J., Mao, G., Xu, H., Zhang, Z., & Yang, L. A review of toxicity and mechanisms of individual and mixtures of heavy metals in the environment. *Environmental Science and Pollution Research*, 2016; 23(9), 8244-59.
18. Hassan A. A. Al-Jumaily. Qualitative Assessment of Pollution Indices for Heavy Metal of The Drinking Water in Kirkuk City, Northern Iraq. *Journal of Environment and Earth Science*, 2016; 6(9), 94-104.

19. Heshmati, A. Integrated water resources management in Kurdistan Region, Nova Science Publishers, New York. 2009.
20. Drinking-Water Standard, I. Q. S. 417. Central Organization for Quality Control and Standardization, Council of Ministers, Republic of Iraq. 2001.
21. Fawell, J. K., Hickman, J. R., Mintz, B., & Pike, E. B. pH in drinking-water. Revised background document for development of WHO guidelines for drinking-water quality. 2007, Geneva: World Health Organization.
22. Saleh, S.M., Habib, S.M. Study the effect of turbidity on the sterilization process in drinking water, Tikrit University Department of Environmental Engineering. Unpublished report. 2013.
23. World Health Organization. Water quality and health-review of turbidity: information for regulators and water suppliers (No. WHO/FWC/WSH/17.01). World Health Organization. 2017.
24. Engwa, G.A., Ferdinand, P.U., Nwalo, F.N., & Unachukwu, M. N. Mechanism and health effects of heavy metal toxicity in humans. In Poisoning in the Modern World-New Tricks for an Old Dog?. Intech Open. 2019.
25. Lešková, A., Zvarík, M., Araya, T., & Giehl, R. F. Nickel toxicity targets cell wall-related processes and PIN2-mediated auxin transport to inhibit root elongation and gravitropic responses in Arabidopsis. *Plant and Cell Physiology*, 2020; 61(3), 519-35.
26. Jamshaid, M., Khan, A.A., Ahmed, K., & Saleem, M. Heavy metal in drinking water its effect on human health and its treatment techniques-a review. *International J. of Biosciences (IJB)*, 2018; 12,223-40.
27. Lourdes, Â.M., Cuin, A., Delbem, I.D., Campos, N. S., Sousa, R. A., Ciminelli, V. S., & Silva, J. C. Chemical Characterization and Human Health Risk Assessment Analysis of Cd, Cr, Fe, Mn and Zn. *Brazilian Journal of Analytical Chemistry*, 2020; 7(26), 36-50.
28. Kozisek, F. Regulations for calcium, magnesium or hardness in drinking water in the European Union member states. *Regulatory Toxicology and Pharmacology*, 2020; 112, 104589.

# Strategies Adopted by Women of Rural and Urban Areas for Weight Losspost-Pregnancy

Blessy Mohandass<sup>1</sup>, Amanpreet Kaur<sup>2</sup>; Timsy<sup>2</sup>; Nitika Choudhary<sup>3</sup>, Shivani Rana<sup>3</sup>, Sonaly Robinson<sup>3</sup>

<sup>1</sup>Nursing Tutor, <sup>2</sup>Assistant Professor, <sup>3</sup>B.Sc. Nursing IVth Year Students, Chitkara School of Health Sciences, Chitkara University, Punjab, India

## Abstract

Pregnancy is the most important and pleasurable moment in a woman's life when along with the bliss of motherhood, they also tend to gain extra weight. In the field of medicine, health, or physical fitness, weight loss refers to a reduction of the total body mass utilizing various weight loss techniques. Gaining an adequate amount of weight during pregnancy is essential, but it is also crucial that one should lose the extra pounds to decrease the chances of obesity. The study was conducted to assess the strategies used by nursing mothers to reduce their weight after pregnancy residing in rural and urban areas. The study was conducted to find out the strategies adopted by nursing mothers for weight loss. A self-structured checklist having 27 items of common strategies used for weight loss was used to collect data from the participants. The results revealed that nursing mothers residing in the urban area adopted a higher number of weight-loss strategies as compared to nursing mothers residing in the rural area. The findings of the study that the nursing mother residing in the urban area adopted more weight-loss strategies as compared to nursing mothers residing in the rural area. Level of Evidence: Level III, Evidence obtained from well-designed cohort or case-control analytic studies

**Keywords:** Diet, Exercise, Gestational Weight gain, Obesity, Postnatal Weight loss, Pregnancy, Weight Loss.

## Introduction

In the field of health, medicine or physical fettle, weight loss means a decrease in total body mass by a mean decrease in fluid, body fat or adipose tissue or lean mass, i.e., bone mineral deposits, muscle tendon, and other connective tissues. Weight loss can occur either inconspicuously because of malnutrition or disease or even because of a conscious effort emends an actual or perceived overweight or obese condition. "Unexplained" weight loss not due to a drop in calorific intake or exercise is called cachexia and may be a symptom of a severe medical condition. It is commonly known as slim intentional weight loss. "Intentional" weight loss is the loss in total body mass due to efforts

to improve fitness & health or by slimming to change one's physical appearance. Weight loss in plus size or rotund individuals reduces health risks,<sup>[1]</sup> increases fitness<sup>[2]</sup>, and can delay the onset of diabetes.<sup>[1]</sup> Weight loss also happens when the body utilizes more energy in work and metabolism than it absorbs from food or other nutrients. It will then utilize stored reserves of fat or musculature, resulting in gradual weight loss.<sup>[3]</sup> There is also a known dietary modification called 'balanced percentage diets,' which are low-calorie diets. Nutritionists most commonly recommend these types of diets because of their minimal detrimental effects. Besides limiting the intake of calories, a balanced diet regulates the consumption of macronutrients. Research states that 55% of the total number of allocated daily calories are from carbohydrates, 15% from protein, and 30% from fats with no more than 10% of total fat coming from saturated forms. A recommended 1,200 calorie diet would provide approximately 660 calories from carbohydrates, 180 from proteins, and 360 from fats, for example. Some studies suggest that increased

---

### Corresponding Author:

**Blessy Mohandass**

Nursing Tutor, Department of Nursing, Chitkara School of Health Sciences, Chitkara University, Punjab, India

protein consumption can help alleviate hunger pangs associated with lower calorie intake by increasing the sensation of safety.<sup>[4]</sup> Depression, stress, or boredom can also contribute to weight gain<sup>[5]</sup>, and people are advised to seek medical assistance in these cases. A 2010 study found that dieticians who had a full night's sleep lost more than twice as much fat as dieticians with sleep deprivation.<sup>[6][7]</sup> Although vitamin D supplementation might help, studies have not supported this<sup>[8]</sup>, a majority of dieters regain the lost weight.<sup>[9]</sup> According to the American Dietary Guidelines, those who and manage a healthy weight do so most successfully by being careful to consume just enough calories to meet their needs and be physically active.<sup>[10]</sup> Very few studies are conducted in India that explore post-pregnancy weight control by women. The proportion of women holding 5 kg or more after six months of post-partum ranged from 14% to 20 % in various studies.<sup>[11]</sup> Recent studies suggest that gestation, along with physical activity behavior among females, can be a powerful teachable movement to promote a healthy diet and eating practices. Appropriate physical exercise and a balanced diet for nutrition might help cut extra pounds. Managing obesity can include lifestyle changes, medications, or surgery. The first intervention for obesity is dieting and physical exercise.<sup>[12]</sup> Diet modifications may produce weight loss over the short term,<sup>[13]</sup> but maintaining this weight loss is often complicated and many times requires making exercise and lower-calorie diet, a permanent part of an individual's lifestyle<sup>[14][15]</sup> The success rates of long-term weight loss maintenance with lifestyle changes are low, ranging from only 2 to 20%.<sup>[16]</sup> Dietary and lifestyle changes have also been found to be effective in preventing excessive weight gain during pregnancy and improve the outcome for both the mother and the child. The National Institute of Health recommends a total weight loss goal of 5% to 10% of the person's current weight over six months.<sup>[17]</sup> The present study aims to find the different strategies adopted by nursing mothers of rural-urban areas for weight loss post-pregnancy and delivery.

### Materials and Method

A Non-Experimental Comparative Design was used to find out the strategies adopted for weight control by Nursing Mothers residing in rural and urban areas. Using a Non-probability convenient sampling technique, 50 subjects from rural and 50 from an urban area, a total of 100 nursing mothers were selected. Willing nursing mothers, who were breastfeeding, their child from 03

months up to 01 years after delivery, who were available during data collection, were selected. The investigators developed a self-structured tool after the extensive review of the literature on the relevant topic after discussion with experts and research guides. It consisted of two parts; Part A consisted of demographic variables such as age, education, number of children, mode of delivery, height, type of family, employment status and Part B consisted of self-structured checklist to assess the strategies adopted by nursing mothers for weight control was given to the participant to respond to by tick marking the appropriate point. The checklist had three domains, namely; Exercise having 05 items, Dietary modification having 16 items, and Lifestyle modification containing 06 items. The reliability of the Practice Checklist was checked by Inter- method, which was found to be ' $r$ ' =0.9. Formal permission obtained from the office of the Municipal Corporation. The participants were assured of anonymity and confidentiality regarding the data collected. The objectives of the study were explained to the mothers before the data collection, and the checklist was distributed, and data was collected using the paper and pencil method. Ethical clearance was obtained from the Institutional Ethical & Research Committee.

### Results

Analysis and interpretation of the data were made according to the objectives of the study. Descriptive and Inferential statistics were utilized to interpret the data. They were further explained under various sections. Table 1 shows the frequency and percentage distribution of sample characteristics. It shows that a maximum of 29 (58%) nursing mothers from rural areas were in the group 25-31 years. On the other hand, a maximum of 24 (48%) nursing mothers from urban areas were in the age group above 32, and the minimum 6 (12%) were in the age group 18-24. When asked about the number of children, 29 (58%) of nursing mothers from rural areas had two children, and 21 (42%) women had one child. On the contrary, urban areas maximum 25 (50%) of nursing mothers from urban areas had two children, and only 1 (2%) had three or more children. On applying the Chi test for homogeneity between the samples, it was found that there was significant homogeneity in Age, Education Mode of Delivery, and Employment status of the nursing mothers residing in rural and urban areas. Out of a total of 50 nursing mothers, Only four mothers residing in the rural area said that they 'went to the gym,' whereas 14 mothers residing in the urban area chose 'to go to a gym' for weight control. There was a



significant association ( $p < 0.05$ ) between the two groups and the 'use of Yoga' as a strategy for weight control in nursing mothers. Out of a total of 50 nursing mothers, 36 mothers residing in the rural area said that they 'drink water before taking meal' whereas 21 mothers residing in the urban area choose to 'drink water before taking meal' for weight control. Only ten mothers residing in the rural area and from the urban area 'consulted a dietician' to control their weight. When asked about 'eating calculation/diet chart,' almost the same number of mothers residing in rural area as 13 and 14 in the urban area responded affirmatively. About 32 nursing mothers residing in the rural area and 30 mothers residing in the urban area said that they 'skipped their meals' to control weight. A similar finding was seen where 34 mothers from rural areas and 33 mothers residing in the urban area 'took short and frequent meals.' Less than half 36 residing in rural areas responded that 'they opt for healthy snacking (home-cooked less oily food),' while 41 mothers residing in the urban area using the same strategy to control weight. Both mothers residing in rural 33 and urban areas 36 said that they preferred to 'eat at home than outside' to control weight. Twenty-one nursing mothers residing in rural areas 'opted for high fiber diet' while 34 mothers residing in the urban area using the same strategy to control weight. Also, 26 mothers residing in the rural area and 44 from urban areas 'included fresh fruit and vegetables in their diet' to control their weight. When asked, more than half of 36 mothers residing in rural areas responded that they 'take green tea every day' while 41 mothers are residing in the urban area using the same strategy to control weight. About 24 mothers residing in a rural area 'took warm water with few lemons regularly drops' on the other hand, only 16 mothers residing in the urban area used the same approach to control weight. There was a significant association ( $p < 0.05$ ) between the two groups and 'drinking water before taking meals,' consulting a, 'opting for high fiber diet,' including fresh and vegetables in my diet, 'take warm water with few lemons drops regularly,' stopped taking Oily foods and Caffeine' as a strategy for weight control in nursing mothers. Out of a total of 50 nursing mothers, only 20 mothers residing in the rural area said that they take dinner early evening, whereas 10 mothers residing in the urban area chose to take dinner in the early evening for weight control. Only 11 nursing mothers of a rural area and 29 from the urban area took chemical agents/medication to control their weight. About 20 mothers residing in the rural area used to check their weight

regularly; on the other hand, 40 mothers residing in the urban area checked their weight regularly. 30 nursing mothers residing in the rural area and 34 mothers residing in an urban area were motivated to reduce weight. 20 mothers from rural areas and 32 mothers residing in urban area 'slept for 6-8 hours straight regularly' to control weight. Only seven mothers residing in rural areas responded that they tried to 'remain stress-free by indulging in leisure activity' while 34 mothers residing in the urban area using the same strategy to control weight. Half, 26, mothers residing in rural areas responded that they drank at least 8-10 glasses of water/daily, while 34 mothers residing in the urban area used the same strategy to control weight. It was therefore clearly evident that nursing mothers residing in urban areas chose more strategies to control weight such as, take dinner in the early evening, take chemical agents/medications, check their weight regularly, motivated to reduce weight, sleep for 6-8 hours straight regularly, try to remain stress-free by indulging in leisure activity as compared to nursing mothers residing in rural areas. There was a significant difference ( $p < 0.05$ ) between the two groups and 'taking medications for weight loss,' 'checking weight regularly,' and 'being motivated to reduce weight' as a strategy for weight control in nursing mothers. Table 2 reveals the comparison of significant difference between the two groups trying exercise as a strategy adopted for weight control; it was found that there was a significant difference ( $p < 0.05$ ) between the two groups and 'use of Yoga' as a strategy for weight control in nursing mothers. Table 3 reveals the comparison of significant difference between the two groups trying dietary modification as a strategy adopted for weight control by, on the application of Chi-square test, it was found that there was a significant association ( $p < 0.05$ ) between the two groups and 'drinking water before taking meals,' consulting a, 'opting for high fiber diet,' including fresh and vegetables in my diet, 'take warm water with few lemons drops regularly,' stopped taking Oily foods and Caffeine' as a strategy for weight control in nursing mothers. Table 4 reveals the comparison of the significant relationship between the two groups trying lifestyle modification as a strategy adopted for weight control by, on the application of Chi-square test, it was found that there was a significant difference ( $p > 0.05$ ) between the two groups and 'taking medications for weight loss,' 'checking weight regularly,' and 'being motivated to reduce weight' as a strategy for weight control in nursing mothers.

**Table 1: Frequency and Percentage distribution of Sample Characteristics N=100**

Socio Demographic variables	Rural n=50		Urban n=50		Chi Test	P Value	df
	(f)	(%)	(f)	(%)			
<b>Age(Years)</b>							
18–24	13	26%	6	12%	12.232	0.002*	2
25–31	29	58%	20	40%			
Above 32	8	16%	24	48%			
<b>Education</b>							
Illiterate	12	24%	1	2%	56.507	0.000*	3
Matriculation	37	74%	12	24%			
Graduate	0	0%	29	58%			
Post Graduate	1	2%	8	16%			
<b>Number of Child</b>							
One	21	42%	24	48%	1.496	0.473 <sup>NS</sup>	2
Two	29	58%	25	50%			
Three or more children	0	0%	1	2%			
<b>Mode of Delivery</b>							
Normal vaginal delivery	40	80%	23	46%	12.398	0.000*	1
Caesarean	10	20%	27	54%			
<b>Type of Family</b>							
Nuclear	0	0%	0	0%	0.041	0.839 <sup>NS</sup>	1
Joint	50	100%	50	100%			
<b>Employment Status</b>							
Employed	20	40%	21	42%	15.174	0.000*	1
Unemployed	30	60%	29	58%			

\* Significant, NS non significant

**Table 2: Comparison of exercise as a strategy adopted for weight control by nursing mothers residing in rural and urban areas N = 100**

Exercise as a Strategy	Area	Yes (f)	No (f)	Chi Test	'p' Value	df
I go to a Gym	Rural n=50	2	48	3.053	0.081 <sup>NS</sup>	1
	Urban n=50	7	43			
I mildly/moderately exercise	Rural n=50	21	29	1.004	0.316 <sup>NS</sup>	1
	Urban n=50	26	24			
I do yoga	Rural n=50	4	46	6.775	0.009*	1
	Urban n=50	14	36			
I go for a walk	Rural n=50	35	15	1.333	0.248 <sup>NS</sup>	1
	Urban n=50	40	10			
I go to dance classes	Rural n=50	4	46	0.444	0.505 <sup>NS</sup>	1
	Urban n=50	6	44			

\* Significant, NS non significant

**Table 3: Comparison of Dietary Modification as a strategy adopted for weight control by nursing mothers residing in rural and urban areas N = 100**

Dietary Modification as a Strategy	Area	Yes f (%)	No f (%)	Chi Test	'p' Value
I drink 8-10 glasses of water daily	Rural n = 50	26	24	2.667	0.102 <sup>NS</sup>
	Urban n = 50	34	16		
I drink water before taking meals	Rural n = 50	36	14	9.180	0.002*
	Urban n = 50	21	29		
I consult a dietician	Rural n = 50	10	40	3.934	0.047*
	Urban n = 50	19	31		
I eat by Calorie calculation/Diet chart	Rural n = 50	13	37	0.051	0.822 <sup>NS</sup>
	Urban n = 50	14	36		
I skip my meals	Rural n = 50	32	18	0.170	0.680 <sup>NS</sup>
	Urban n = 50	30	20		
I take short and frequent meals	Rural n = 50	34	16	0.045	0.832 <sup>NS</sup>
	Urban n = 50	33	17		
I opt for healthy Snacking (Home cooked less oily food)	Rural n = 50	36	14	1.412	0.235 <sup>NS</sup>
	Urban n = 50	41	9		
I eat at home than outside	Rural n = 50	33	17	0.421	0.517 <sup>NS</sup>
	Urban n = 50	36	14		
I opt for high fibre diet	Rural n = 50	21	29	6.828	0.009*
	Urban n = 50	34	16		
I include fresh fruits and vegetables in my diet	Rural n = 50	26	24	15.429	0.000*
	Urban n = 50	44	6		
I take green tea everyday	Rural n = 50	13	37	0.437	0.509 <sup>NS</sup>
	Urban n = 50	16	34		
I take warm water with few lemon drops regularly	Rural n = 50	24	26	7.429	0.006*
	Urban n = 50	11	39		
I have stopped taking Oily foods	Rural n = 50	15	35	5.911	0.015*
	Urban n = 50	27	23		
I have stopped taking Dairy food items	Rural n = 50	23	27	0.367	0.545 <sup>NS</sup>
	Urban n = 50	20	30		
I have stopped taking Sweet food	Rural n = 50	26	24	2.667	0.102 <sup>NS</sup>
	Urban n = 50	34	16		
I have stopped taking Caffeine	Rural n = 50	36	14	9.180	0.002*
	Urban n = 50	21	29		

\* Significant, NS non significant

**Table 4: Comparison of Lifestyle Modification as a strategy adopted for weight control by nursing mothers residing in rural and urban areas N = 100**

Lifestyle Modifications as a Strategy	Area	Yes (f)	No (f)	Chi Test	'p' Value
I take dinner in early evening	Rural n = 50	18	32	1.714	0.190 <sup>NS</sup>
	Urban n = 50	12	38		
I take medications for weight loss	Rural n = 50	20	30	4.762	0.029*
	Urban n = 50	10	40		
I check my weight regularly	Rural n = 50	11	39	13.500	0.000*
	Urban n = 50	29	21		
I am motivated to reduce weight	Rural n = 50	20	30	16.667	0.000*
	Urban n = 50	40	10		
I sleep for 06-08 hours straight regularly	Rural n = 50	30	20	0.694	0.405 <sup>NS</sup>
	Urban n = 50	34	16		
I try to remain stress free by indulging in leisure activity	Rural n = 50	20	30	5.769	0.016*
	Urban n = 50	32	18		

\* Significant, NS non significant

### Discussion

The investigator found that there was a non-significant relationship between the numbers of strategies adopted for weight with socio-demographic variables. Investigators also find that the nursing mothers residing in the urban area adopted more strategies for weight control as compare to nursing mother residing in the rural area. A study of 2,464 in the U.S. similarly found that the women who tried to lose or maintain their weight had adopted exercise more as a strategy than dietary changes. Women who were advised to maintain or gain weight were less as compared to women who were trying to lose weight.<sup>[18]</sup>

### Conclusion

The finding shows that the number of strategies adopted for weight control by nursing mothers residing in the urban area was higher than mothers residing in the rural area. Controlled trials can be conducted to evaluate the effectiveness of specific strategies.

**Acknowledgment:** We would also like to thank Dr. Harmeet Kaur, Principal, Chitkara School of Health Sciences, Chitkara University, Punjab, India, for her unending guidance during the period of our study.

**Conflicts of Interest:** None

**Source of Funding:** Self

### References

1. Dietary Guidelines - health.gov [Internet]. Health.gov. (2019) [cited 14 January 2019]. Available from: <https://health.gov/dietaryguidelines/2015/guidelines/>. Retrieved 20 January 2019.
2. Blackburn GL, Walker WA. Science-based solutions to obesity: what are the roles of academia, government, industry, and health care?-. *The American journal of clinical nutrition.* (2005) Jul 1;82(1):207S-10S.
3. ColdF, Health E, Disease H, Disease L, Management P, Conditions S et al. The Mayo Clinic Diet Review [Internet]. WebMD. (2019) [cited 14 March 2019]. Available from: <https://www.webmd.com/diet/features/the-mayo-clinic-diet#High-Protein-Diet-for-Weight-Loss>. Retrieved 13 January 2019
4. Feingold KR, Grunfeld C. The effect of inflammation and infection on lipids and lipoproteins. In *Endotext* [Internet] (2019) Jan 8. MD Text. com, Inc. Retrieved 21 January 2019.
5. Harmon K. Sleep might help dieters shed more fat. *Scientific American.* [Internet] (2010). Retrieved 20 January 2019.
6. Institute for Quality and Efficiency in Health Care. «Health benefits of losing weight». Fact sheet, Informed Health Online. (2017) Institute for Quality and Efficiency in Health Care. Retrieved 27 June 2018.

7. Lau DC, Douketis JD, Morrison KM, Hramiak IM, Sharma AM, Ur E. (2006) Canadian clinical practice guidelines on the management and prevention of obesity in adults and children [summary]. *Cmaj*. 2007 Apr 10;176(8):S1-3.
8. LeBlanc, E; O'Connor, E; Whitlock, EP (2011). «Screening for and management of obesity and overweight in adults». Evidence Syntheses, No. 89. U.S. Agency for Healthcare Research and Quality (AHRQ). Retrieved 27 June 2018.
9. Nedeltcheva A, Kilkus J, Imperial J, Schoeller D, Penev P. Insufficient Sleep Undermines Dietary Efforts to Reduce Adiposity. *Annals of Internal Medicine*. (2010); 153(7):435.
10. Pathak K, Soares MJ, Calton EK, Zhao Y, Hallett J. Vitamin D supplementation and body weight status: a systematic review and meta-analysis of randomized controlled trials. *Obesity reviews*. (2014) Jun; 15(6):528-37.
11. Shick SM, Wing RR, Klem ML, McGUIRE MT, Hill JO, Seagle H. Persons successful at long-term weight loss and maintenance continue to consume a low-energy, low-fat diet. *Journal of the American Dietetic Association*. (1998) Apr 1;98(4):408-13.
12. Strychar I. Diet in the management of weight loss. *Cmaj*. (2006) Jan 3;174(1):56-63.
13. Sumithran P, Proietto J. The defence of body weight: a physiological basis for weight regain after weight loss. *Clinical Science*. (2013) Feb 1;124(4):231-41.
14. Tate DF, Jeffery RW, Sherwood NE, Wing RR. Long-term weight losses associated with prescription of higher physical activity goals. Are higher levels of physical activity protective against weight regain?. *The American journal of clinical nutrition*. (2007) Apr 1;85(4):954-9.
15. Thangaratinam S, Rogozińska E, Jolly K, Glinkowski S, Roseboom T, Tomlinson JW, Kunz R, Mol BW, Coomarasamy A, Khan KS. Effects of interventions in pregnancy on maternal weight and obstetric outcomes: meta-analysis of randomised evidence. *Bmj*. (2012) May 17;344:e2088.
16. Weight loss - Howling Pixel [Internet]. Howlingpixel.com. (2019) [cited 14 March 2019]. Available from: [https://howlingpixel.com/i-en/Weight\\_loss](https://howlingpixel.com/i-en/Weight_loss). Retrieved 13 January 2019.
17. Williams SG, Schmidt DK, Redd SC, Storms W. Key clinical activities for quality asthma care. Recommendations of the National Asthma Education and Prevention Program. *MMWR Recommendations and Reports*. (2003) Mar; 52 (RR-6):1-8.
18. Yeganeholadadam, N. Association between Weight Discrimination and Program Adherence in a Clinical Weight Management Program. (2016).

# Assess the Knowledge, Practice and Attitude Regarding Nosocomial Infections and their Preventive among Health Care Staff

Blessy Mohandass<sup>1</sup>, Amanpreet Kaur<sup>2</sup>, Timsy<sup>2</sup>, Harmeet Kour<sup>3</sup>,  
Navneet Kaur<sup>3</sup>, Pema Choden<sup>3</sup>, Aishwarya Thakur<sup>3</sup>

<sup>1</sup>Nursing Tutor, <sup>2</sup>Assistant Professor, <sup>3</sup>B.Sc. Nursing IV<sup>th</sup> Year Students, Chitkara School of Health Sciences, Chitkara University, Punjab, India

## Abstract

Nosocomial infections are diseases acquired within 48 hours or more of hospital admission or within 30 days of discharge. The objectives of the study were to assess the knowledge, attitude and practice regarding nosocomial infection and their prevention among health care workers. To determine the relationship between knowledge, attitude and practice regarding nosocomial infection and their prevention among health care workers. To find out association between the knowledge, attitude and practice regarding nosocomial infection and their prevention among health care workers. The research design selected for the study was descriptive research design and a total 100 health care staff were selected as study sample tool was used for data collection. Self-introduction was given and purpose of gathering the information and nature of study was explained before taking information through non probability convenient sampling technique. A self- structured questionnaire, consent was signed by participants. The result revealed that the most of the health care staff 76(76%) had excellent knowledge regarding nosocomial infection and their prevention less than half, 43(43%) had positive attitude regarding nosocomial infection and their prevention. On the contrary, 74(74%) had excellent practice regarding nosocomial infection and their prevention. On applying the spearman correlation test, relationship between knowledge and attitude was found to be significant at  $p < 0.05$ . Hence, researchers concluded that the present study was undertaken to identify the level of knowledge, attitude and practice regarding nosocomial infection and prevention among health care staff in selected hospitals of Punjab. The finding showed that majority of the participants had excellent knowledge and practice. There were gaps in relationship between knowledge and practice and attitude which is found to be not significant at  $p < 0.05$ .

**Keywords:** Knowledge, Infection, Practice, Nosocomial.

## Introduction

Hospital acquired infections which are acquired or caught by a patient in a special location i.e. hospital and acquired after 48 hrs. On patient admission, 3 days of discharge and 30 days after surgery.<sup>1-2</sup> Hospital-associated infections also include occupational

infections due to occupational hazard in health care workers.<sup>3-6</sup> There is various sort of transmissions of these microorganisms and virus acquired through direct contact between patient and doctor as well from patient to nurses and vice versa associated with nursing infected surface, through air such as droplets, aerosols etc. and also commonly through by common vehicles as food and water.<sup>7-9</sup> Nosocomial infections go beyond their effects on morbidity and mortality in every country and have so many economic implications. Infection management should be a part of implementations for all health care workers, not only for their health purpose but also to decrease the prevalence of nosocomial

---

### Corresponding Author:

**Amanpreet Kaur**

Assistant Professor, Chitkara School of Health Sciences, Chitkara University, Punjab, India

infections and thus improve patient safety and risks of acquiring infections.<sup>10</sup> Hand washing process leads to complete hand hygiene by healthcare staff has essential importance in the control of infections.<sup>11</sup> Nosocomial infections increase the morbidity, mortality and duration of patients who stay at hospital prices. It is estimated that Nosocomial infections comprise more than 2 million patients per year. Negative outcomes of nosocomial infections differ by type of infection and their related costs.<sup>12</sup> During the 1950s, programs for the surveillance, prevention and control of nosocomial infections were created. However, questions regarding the efficiency and cost-effectiveness of these programs still exist.<sup>13</sup> That is why, this shows that knowledge regarding the effectiveness of nosocomial infection surveillance, prevention, and control is must emphasise on public health: screening, preventing and managing nosocomial infections.

### Materials and Method

Research approach for the study was a quantitative research approach, as it allows the investigator to collect and cover data. In this analysis, the Descriptive research design was used, and a non-experimental research design was used to determine the knowledge, practice and attitude regarding nosocomial infections among health care workers in selected Hospitals of Punjab. A total 100 health care staff were selected as study sample tool was used for data collection. Self-introduction was given and purpose of gathering the information and nature of study was explained before taking information through non probability convenient sampling technique. A self- structured questionnaire, consent was signed by participants. In Inclusion Criteria all the health care worker i.e. Doctors, Nurses, Physiotherapist, OT Technician, Lab Technician, Radiologists who are in direct contact with the patient was selected for this study and in exclusion criteria health care staff that were not willing to participate was excluded. Using Non-Probability Convenient sampling technique was selected to select a group of 100 healthcare staff who will be representative of the population being studied.

### Results

The study revealed that present research was selected to assess the knowledge, practice and attitude of nosocomial infections and prevention for their health care staff in hospitals. The descriptive research design was selected. Non-Convenient sampling technique was selected for the study. The data was obtained from 100

health care workers who were analysed. The finding of the study for the showed that out of 100 subjects 76(76%) had excellent knowledge regarding nosocomial infection and their prevention and also 74 (74%) had excellent practice regarding nosocomial infection and their prevention. So, this concludes that majority of the participants had excellent knowledge and practice and less than half had positive attitude. The second objective of the study findings revealed that relationship between the knowledge, practice and attitude of health care staff regarding nosocomial infection. In current study, on applying spearman's correlation test, relationship between knowledge and attitude was found to be significant at  $p < 0.05$ . The relationship between knowledge and practice and attitude was found to be not significant at  $p < 0.05$ . The findings of the study showed that there was a linear correlation between knowledge and attitude at  $p < 0.05$ . Overall, there was no correlation between attitude and practice scores of individuals with regard to nosocomial infection prevention and control. The third objective findings revealed that the chi-square value showed that there was a significant association between knowledge and highest educational qualification. No significant association with the selected demographic variables was noted between attitude and practice. The results showed that nurses with a master's degree showed higher mean scores of knowledge than the other two groups.<sup>14</sup> An important statistical difference in mean information scores was found at  $p < 0.05$ .

### Discussion

Discussion deals with the results of the study. In the discussion, the investigator ties tighter all the loose ends of the study. The results and the discussion of the study are investigators opportunity to examine the logic of theoretical framework, the method and analysis. The present study was selected to assess the knowledge, practice and attitude regarding nosocomial infection and their prevention among health care staff in selected hospitals. Descriptive research method was selected and data was collected by self-reported paper and pencil. Data was collected from 100 health care staff that were analysed and interpreted. The relationship between knowledge and practice and relationship between attitude and practice was not significant at  $p < 0.05$ . Chi square value revealed that there was a significant association between knowledge and highest educational qualification. No significant association was seen between attitude and practice with their selected demographic variables.

**Table 1: Percentage and Frequency distribution of Knowledge, Attitude and Practice score of healthcare staff regarding nosocomial infections and their prevention N=100**

Level of Knowledge Score	Percentage	Frequency	Mean	S.D.
Excellent knowledge (9-12)	76%	76	9.64	1.77
Good knowledge (4-8)	24%	24		
Inadequate knowledge (<4)	0%	0		
<b>Maximum Score = 12 Minimum Score = 0</b>				
Level of Attitude Score	Percentage	Frequency	Mean	S.D.
Positive Attitude (9-12)	43%	43	7.71	1.79
Neutral Attitude (4-8)	51%	51		
Negative Attitude (<4)	6%	6		
<b>Maximum Score = 12 Minimum Score = 0</b>				
Level of Practice Score	Percentage	Frequency	Mean	S.D.
Excellent Practice (9-12)	74%	74	10.01	2.06
Good Practice (4-8)	25%	25		
Poor Practice (<4)	1%	1		
<b>Maximum Score=12 Minimum Score=0</b>				

**Table 2: Relationship between the knowledge, attitude and practice regarding nosocomial infections and their prevention among healthcare staff N=100**

Relationship Between	Mean	S.D.	Correlation	P value	Results
Knowledge	9.64	1.77	0.418*	0.000	Significant
Attitude	7.71	1.79			
Knowledge	9.64	1.77	0.139	0.167	Not significant
Practice	10.01	2.06			
Attitude	7.71	1.79	0.025	0.802	Not significant
Practice	10.01	2.06			

\*Significant, <sup>NS</sup> Not Significant**Table 3: Association between knowledge of healthcare staff regarding nosocomial infections and their prevention and selected socio demographic variables. N=100**

Variable Opts	Level of Knowledge			Chi Test	P Value	df	Table Value
	Poor Knowledge	Good Knowledge	Excellent Knowledge				
<b>Age</b>							
21-25 years	0	10	39	0.809	0.847 <sup>NS</sup>	3	7.815
26-30 years	0	8	23				
31-35 years	0	4	9				
36-40 years	0	2	5				
<b>Gender</b>							
Male	0	12	49	1.606	0.205 <sup>NS</sup>	1	3.841
Female	0	12	27				



Variable Opts	Level of Knowledge			Chi Test	P Value	df	Table Value
	Poor Knowledge	Good Knowledge	Excellent Knowledge				
<b>Highest Educational Qualification</b>				9.904	0.019*	3	7.815
Master	0	15	25				
Graduate	0	4	39				
Diploma	0	3	5				
Others	0	2	7				
<b>Numbers of years in Healthcare practice</b>				1.890	0.595 <sup>NS</sup>	3	7.815
≤ 1 year	0	4	22				
1-5 years	0	12	34				
6-10 years	0	5	10				
More than 10 years	0	3	10				
<b>Have You Ever Received Occupational Recently Any Training on Universal Precautions?</b>				0.805	0.370 <sup>NS</sup>	1	3.841
Yes	0	19	53				
No	0	5	23				
Maximum Score = 12 Minimum Score = 0				*Significant <sup>NS</sup> Not Significant			

**Table 4: Association between Attitude of healthcare staff regarding nosocomial infections and their prevention and selected socio demographic variables. N=100**

Variable	Level of Attitude			Chi Test	P Value	df	Table Value
	Negative Attitude	Neutral Attitude	Positive Attitude				
<b>Age</b>				6.880	0.332 <sup>NS</sup>	6	12.592
21-25 years	3	25	21				
26-30 years	2	19	10				
31-35 years	1	6	6				
36-40 years	0	1	6				
<b>Gender</b>				2.863	0.239 <sup>NS</sup>	2	5.991
Male	4	27	30				
Female	2	24	13				
<b>Highest Educational Qualification</b>				9.851	0.131 <sup>NS</sup>	6	12.592
Master	5	21	14				
Graduate	0	22	21				
Diploma	1	2	5				
Others	0	6	3				
<b>Numbers of years in Healthcare practice</b>				6.321	0.388 <sup>NS</sup>	6	12.592
≤ 1 year	1	16	9				
1-5 years	4	22	20				
6-10 years	1	9	5				
More than 10 years	0	4	9				

Variable	Level of Attitude			Chi Test	P Value	df	Table Value
	Negative Attitude	Neutral Attitude	Positive Attitude				
<b>Have You Ever Received Occupational Recently any Training on Universal Precautions?</b>				0.350	0.839 <sup>NS</sup>	2	5.991
Yes	4	38	30				
No	2	13	13				
<b>Maximum Score = 12 Minimum Score = 0</b>				*Significant <sup>NS</sup> Not Significant			

**Table 5: Association between Practice of healthcare staff regarding nosocomial infections and their prevention and selected socio demographic variables. N=100**

Variable	Level of Practice			Chi Test	P Value	df	Table Value
	Poor practice	Good practice	Excellent practice				
<b>Age</b>				4.150	0.656 <sup>NS</sup>	6	12.592
21-25 years	0	10	39				
26-30 years	1	8	22				
31-35 years	0	5	8				
36-40 years	0	2	5				
<b>Gender</b>				1.617	0.446 <sup>NS</sup>	2	5.991
Male	0	15	46				
Female	1	10	28				
<b>Highest Educational Qualification</b>				9.218	0.162 <sup>NS</sup>	6	12.592
Master	1	5	34				
Graduate	0	12	31				
Diploma	0	4	4				
Others	0	4	5				
<b>Numbers of years in Healthcare practice</b>				7.065	0.315 <sup>NS</sup>	6	12.592
≤ 1 year	0	6	20				
1-5 years	0	13	33				
6-10 years	1	2	12				
More than 10 years	0	4	9				
<b>Have You Ever Received Occupational Recently Any Training on Universal Precautions?</b>				4.791	0.091 <sup>NS</sup>	2	5.991
Yes	1	22	49				
No	0	3	25				
<b>Maximum Score = 12 Minimum Score = 0</b>				*Significant <sup>NS</sup> Not Significant			

**Conclusion**

The study concluded that 76 (76%) of the healthcare staff had excellent knowledge and prevention of nosocomial infection Less than half, 43(43%) had

positive attitude regarding nosocomial infection and their prevention. On the contrary, 74(74%) had excellent practice regarding nosocomial infection and their prevention. On applying Spearman’s Correlation test,

relationship between Knowledge and Attitude was found to be significant at  $p < 0.05$ . The relationship between Knowledge and Practice and the relationship between Attitude and Practice was found to be not significant at  $p < 0.05$ . The Chi-square value showed that there was a significant association between Knowledge and Highest Educational Qualification.

**Acknowledgment:** We would also like to thank Dr. Harmeet Kaur, Principal, Chitkara School of Health Sciences, Chitkara University Punjab India for her unending guidance during the period of our study.

**Ethical Clearance:** The ethical clearance was obtained from institutional research committee.

**Source of Funding:** Self

**Conflicts of Interest:** None

### References

1. Alrubaiee G, Baharom A, Shahar H, Daud S, Basaleem H. Knowledge and practices of nurses regarding nosocomial infection control measures in private hospitals in Sana'a City, Yemen. *Safety in Health*. 2017;3(1).
2. Gadade M. A Study to Assess the Knowledge Regarding Nosocomial Infection among B.Sc. Nursing Students in Selected Nursing Institutions of Pune City. *Journal of Medical Science And clinical Research*. 2018;6(2).
3. Yogita M, Sangita R, Summaiya M. Impact of knowledge, attitudes & practices among doctors, nurses & ward aids for prevention & control of tuberculosis infection in tuberculosis outpatient department and indoor patient department in tertiary care hospital. *Journal of Patient Safety & Infection Control*. 2015;3(2):72-73.
4. Cherian V, Rajesh R. A Study to Assess The Knowledge and Practice among Nurse on Infection Control Measures in Pediatric Unit at Pondicherry Institute of Medical Science, Puducherry. *International Journal of Advances in Nursing Management*. 2018;6(3):215.
5. Fashafsheh I, Ayed A, Koni M, Hussein S, Thultheen I. Midwives and Nurses Compliance with Standard Precautions in Palestinian Hospitals. *Open Journal of Nursing*. 2016;06(04):294-302.
6. Gruda A, Sopjani I. The Knowledge, Attitudes and Practices of Nurses Toward Management of Hospital-acquired Infections in the University Clinical Center of Kosovo. *Materia Socio Medica*. 2017;29(2):84.
7. Knowledge and Practices of Nurses Regarding Spread of Nosocomial Infection In government Hospitals, Lahore. *Journal of Liaquat University of Medical & Health Sciences*. 2017;16(03):149-153.
8. Kalantarzadeh M, Mohammadnejad E, Ehsani S, Tamizi Z. Knowledge and Practice of Nurses About the Control and Prevention of Nosocomial Infections in Emergency Departments. *Archives of Clinical Infectious Diseases*. 1901;9(4).
9. Lobo D, Sams L, Fernandez S. Correlation between health professionals knowledge, attitude and practice about infection control measures. *Journal of Medical and Allied Sciences*. 2019;9(1):26.
10. Mohapatra A. Assessment of Knowledge and Practice to Control Nosocomial Infection, Among the Staff Nurses, Hi-Tech Medical College and Hospital. *Nursing & Care Open Access Journal*. 2017;2(1).
11. Najafi F, Jafari Motlagh Z, Dargahi A, Reshadat S, Moradi Nazar M. Knowledge, Attitude and Practice of Nurses Regarding Nosocomial Infections Control in Teaching Hospitals of Kermanshah University of Medical Sciences, Iran (2015). *Archives of Hygiene Sciences*. 2017;6(4):314-319.
12. Sodhi K, Shrivastava A, Arya M, Kumar M. Knowledge of infection control practices among intensive care nurses in a tertiary care hospital. *Journal of Infection and Public Health*. 2013;6(4):269-275.
13. Sarani H, Balouchi A, Masinaeinezhad N, Ebrahimitabas E. Knowledge, Attitude and Practice of Nurses about Standard Precautions for Hospital-Acquired Infection in Teaching Hospitals Affiliated to Zabol University of Medical Sciences (2014). *Global Journal of Health Science*. 2015;8(3):193.
14. Shrestha G, Thapa B. Knowledge and Practice on Infection Prevention among Nurses of Bir Hospital, Kathmandu. *Journal of Nepal Health Research Council*. 2018;16(3):330-335.

# Oncology Research Productivity of Iraqi Authors: A Bibliometric Analysis During 1955–2019

Bushra H Shnawa<sup>1,2</sup>, Shireen M Al-Majmaie<sup>2,3</sup>

<sup>1</sup>Department of Biology, Faculty of Science, Soran University, Erbil-Iraq, <sup>2</sup>Scientific Research Center, Soran University, <sup>3</sup>Department of Computer Science, Faculty of Science, Soran University

## Abstract

Cancer is a major health enigma all over the world. In Iraq, cancer caused a large number of deaths and significant morbidity. Nevertheless, limited information is available on how cancer-related literature has developed. This study aimed to analyze the published research on cancer carried out by Iraqi authors by assessing a bibliometric analysis. Data from 1955 to 2019 was retrieved from Scopus and Google Scholar. The findings of the current study showed significant growth in recent research output regarding cancer, particularly after the 2000s, and more than half of Iraqi publications were internationally published as 79.4% of them. Breast cancer was the type of cancer most targeted by researchers in a percentage of (29%), and the degree of collaboration of Iraqi authors was high (0.808) according to the Subramanyamin method. This study is the first one to analyze Iraqi publications regarding cancer. Our results can help to direct a national knowledge program, planning, and funding assessments. Moreover, to establish new national and international organized collaborations.

**Keywords:** Cancer, Lymphoma, Malignancy, Leukemia, Tumor, Iraq.

## Introduction

Cancer is an important reason for morbidity and mortality worldwide regardless of the level of human development. The GLOBOCAN estimates indicated that there were 18.1 million new cases of cancer and 9.6 million deaths from cancer in 2018<sup>1,2</sup>. The percentage of cancer increased by 33% during the period between 2005 to 2015 as a result of population growth and aging<sup>3</sup>. Presently, cancer is the second cause of death internationally and is predicted to hit 27.1 million individuals by 2030 particularly in high-income countries. In Iraq, also cancer is the second leading cause of cancer death following cerebrovascular diseases<sup>4,5</sup>. It is known as an important and growing public health burden in

Iraq. Currently, Khoshnaw et al.,<sup>4</sup> found an increase in annual cancer incidence rates in Iraq, owing to increase of cancer with age and high proportions of hematological malignancies. This increased proportion of leukemia in most Iraqi towns was related to the exposure to depleted uranium, which was used during the wars against Iraq from 1990 until 2010<sup>6-10</sup>. Moreover, Al-Shammari<sup>11</sup> pointed out that the sand particles of Iraq contain toxic substances, which dates back to the pollution resulted from military activities that disassemble the desert sands and change it into light dust. This dust spreads to cities by dust storms. Also, the occurrence of depleted uranium in the Iraqi food chain is proved by evaluating the uranium in animals' organs in various Iraqi cities with the highest level in the south of Iraq. One of the main locations of pollution in Iraq is the Al-twaitha nuclear research site. Other researchers recorded that cancer incidences per 100,000 populations of Baghdad have increased; also, it is raised in Basra. Besides, total incidence of breast and lung cancer, Leukemia and Lymphoma, has doubled even tripled. The situation in Mosul governorate is like other regions and the percentage of cancer has further amplified since the Gulf War<sup>12</sup>. Previous review of

---

### Corresponding Author:

**Dr. Bushra Hussain Shnawa**

Prof., Soran University, Faculty of Science, Biology  
Department, Kurdistan, Erbil- Iraq  
e-mail: bushra.shnawa@soran.edu.iq

Iraqi scientific publications regarding environmental pollutants concluded that Basrah, Baghdad, Falluja, Mosul and Thi-Qar are the most affected towns in Iraq<sup>11</sup>.

Productivity in the area of medical terms and research can be measured by some variables. The number of research publications is one of the parameters that can be used to evaluate productivity as well as the quality of research. This can be achieved by using bibliometric analysis<sup>13, 14</sup>.

Bibliometrics is a systematic method for assessing research productivity which can help map alterations in the interest of a scientific community over time<sup>15</sup>, and can provide visions into both qualitative and quantitative research trends. In bibliometric analysis, a large database, such as Scopus, is used to retrieve, analyze and present the data. In addition, bibliometric analysis shows citations and research collaboration. A citation is accounted for when research is referenced by another peer reviewed research. Citation analysis includes ranking and assessing an article or journal based on the sum of citations it collects. As well as to recognize the highest frequently cited research; bibliometric is also used to determine the impact of journals<sup>16</sup>.

### Method

Analysis of published researches regarding cancer in Iraq was conducted to analyze the trends of publications.

**The Database Used:** In this study data from Scopus (Elsevier) was used. Also, Google was searched to gather more articles that not present in Scopus. As well as Scopus and Google Scholar were dependent to collect the citation number of articles.

Bibliometric analysis was performed on March 2019 by downloading all the cancer papers related to Iraqi researchers published between 1955 and 2019, using the keywords including “Cancer”, “Malignancy”, “Lymphoma”, “Leukemia”, “Tumor” and “Iraq”.

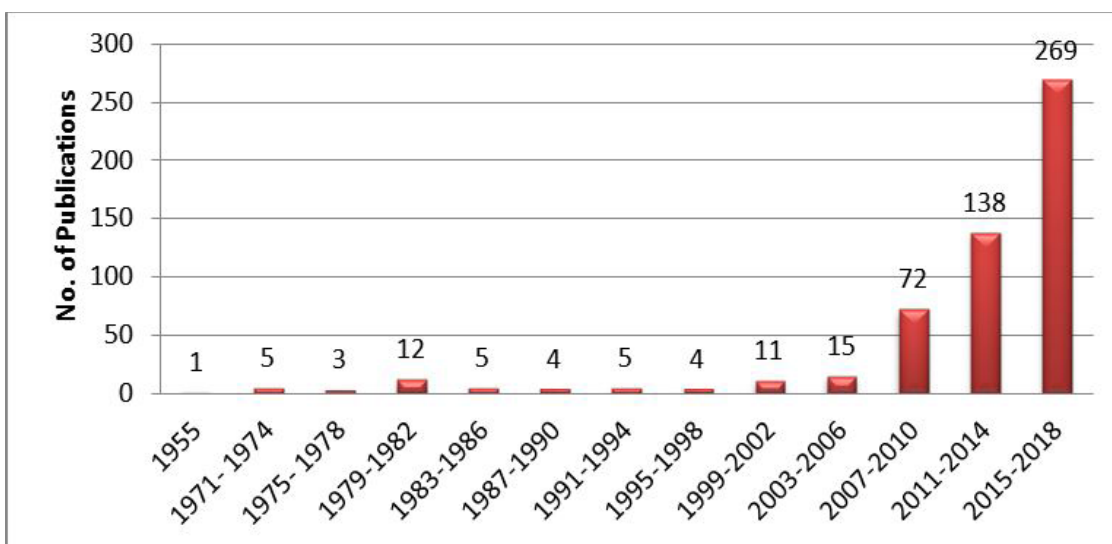
As in any bibliometric study, the retrieved data were arranged as MS Excel file, analyzed and tabulated for presenting the results. The following information was obtained for each article: title, journal name, date of publication, author, number of authors, type of journal, affiliation, and abstract. The data presented to show the annual growth of Iraqi cancer researches, most frequent keywords to explain research interest and publications gaps, national and international research collaboration, most active researchers, journals, governorates and institutions, and the most cited articles among the cancer researches that have the Iraqi affiliation. For calculating the degree of author’s collaboration, the mathematical method of Subramanyamin<sup>17</sup> was followed.  $C = \frac{Nm}{Nm + Ns}$ , Where, C = Degree of collaboration, Nm = number of multi-authored articles and Ns = number of single-authored articles.

**Statistical Analysis:** T-test was applied to determine the significant differences in the current results at level of 0.05% or less.

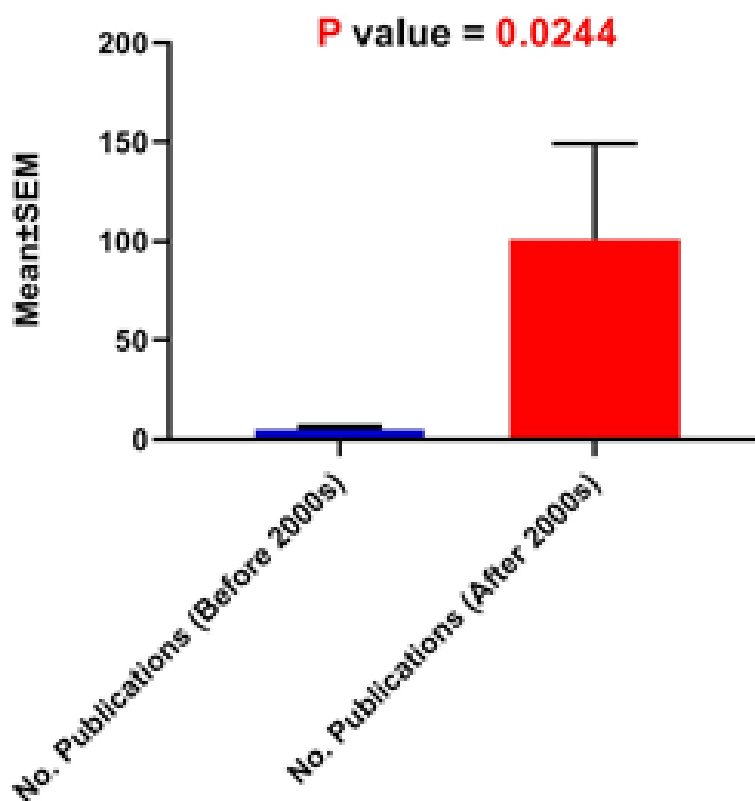
### Results

The initial search showed 736 references from both of the considered databases, and the final number of the researches was 544 after removing the duplicates.

The annual growth of Iraqi publications regarding cancer is represented in Figure 1, A. The graph shows that the number of publications remained low, followed by a steady phase until 2004. There was a noticeable sharp increase in the number of publications after 2005, which reached a maximum of approximately 269 publications in the last 4 years of the study period, and represented 49.4 % of the published articles concerning cancer by Iraqi authors. The statistical analysis of the present finding confirmed the occurrence of highly significant differences (P-value= 0.024) between Iraqi cancer publication before 2000 and that published after this year as in Figure 1, B.



A



B

**Figure 1. A. Distribution of publications by years, B. Comparison between number of publication before and after 2000s.**

Breast cancer was the type of cancer most targeted by Iraqi researchers 29.04 %, followed by the articles that cover: cancer as general, female reproduction system, intestinal, and cell line as 17.27%, 6.6%, 6.06%, 5.8% respectively, and then the articles that focused on

the other types of cancer as shown in Figure 2. There was a significant difference between the number of publications regarding breast cancer and that related to the other types of cancer ( $P < 0.05$ ).

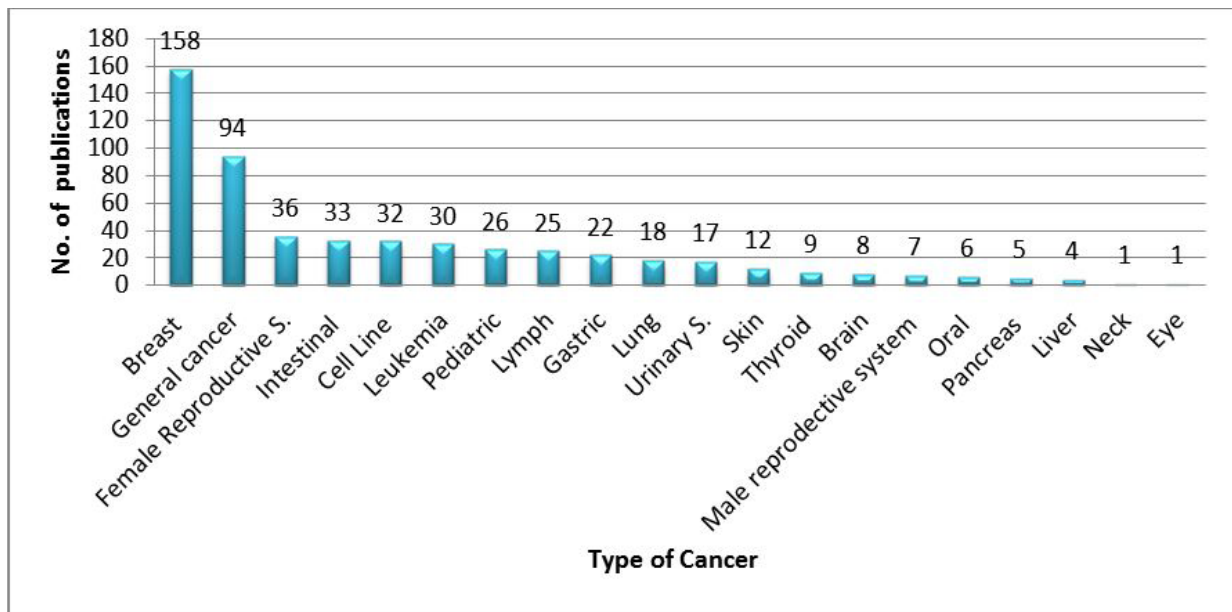


Figure 2. Number of publications by the type of cancer

Moreover, the current study revealed that the majority of articles were published by three authors as 29.59 %, followed by a single researcher as 19.1, and

double authors as 17.4% %, these results are summarized in Figure 3. The degree of collaboration of Iraqi authors was high as 0.808.

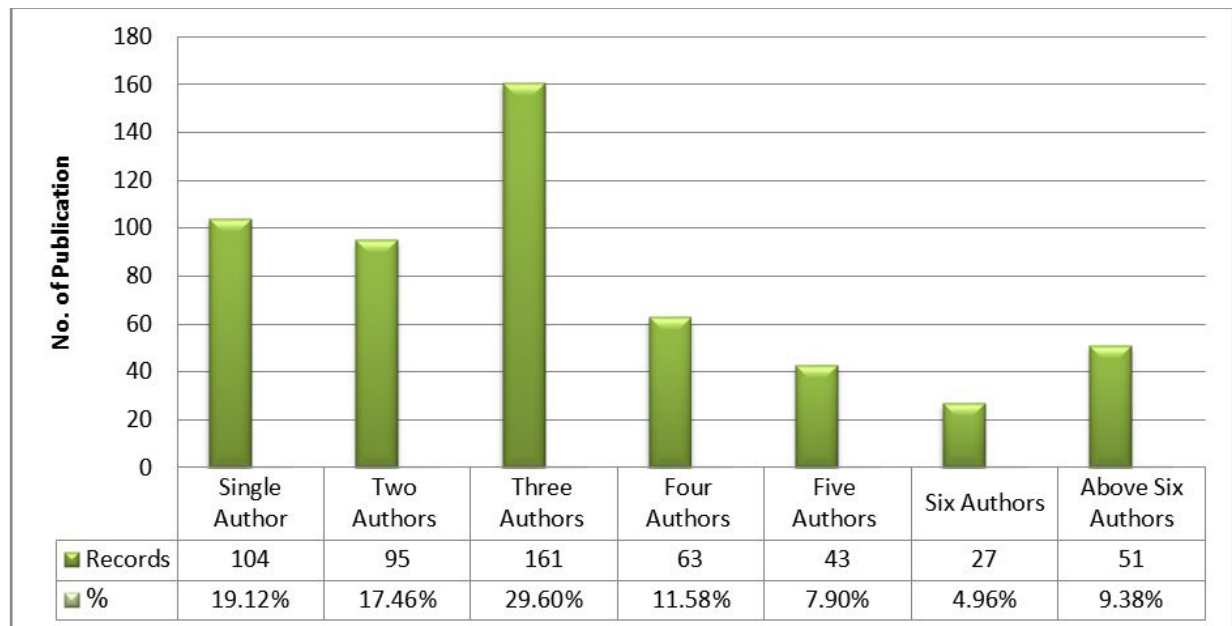
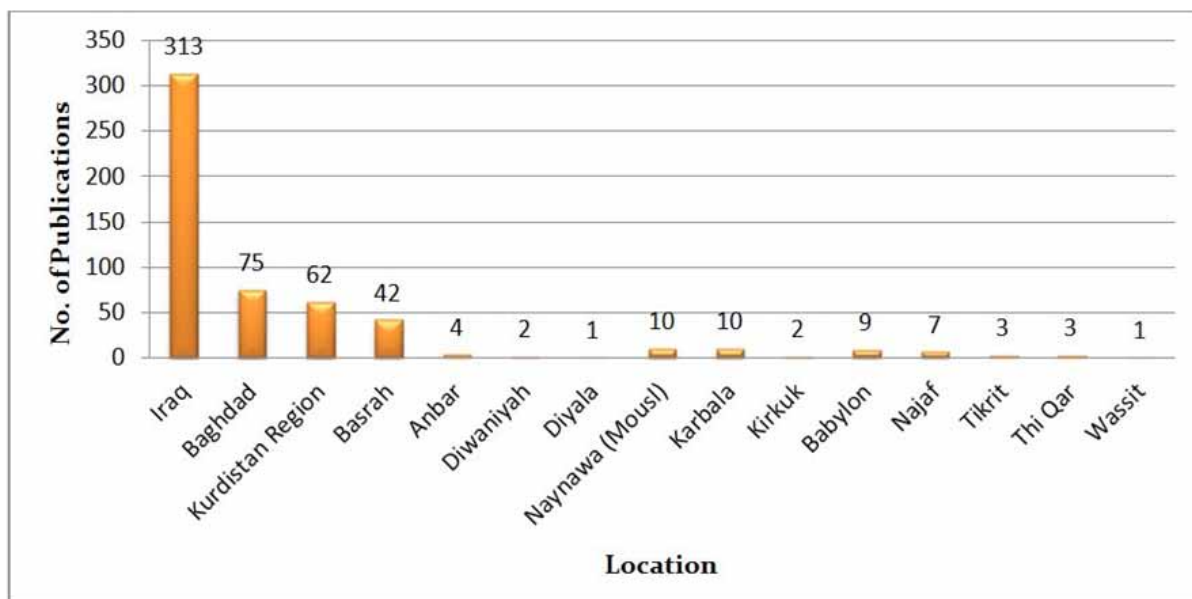


Figure 3. Number of publications related to authority

Regarding the relationship between the number of articles and location, the current finding showed that most publications included all Iraqi patients and didn't restrict to one area which reached 57.5 %, followed by

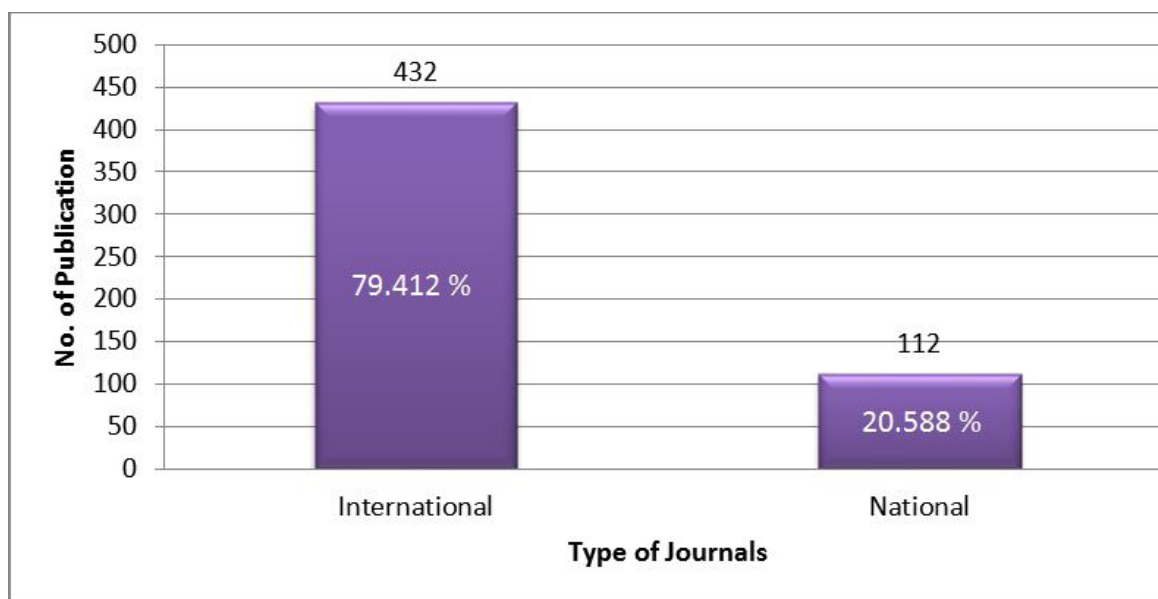
the articles that related to cancer patients of Baghdad (13.7%), Kurdistan (11.3%), and Basrah (7.7%) as shown in Figure 4.



**Figure 4. Iraqi cancer publications related to location**

Moreover, the majority of Iraqi articles regarding cancer was published in the international journal, in the percentage of 79.4 % compared to national journals as, 20.5% as shown in Figure 5. The number of internationally published publications significantly differing from that

published in national journals ( $P < 0.05$ ). Also, the Asian pacific journal of cancer prevention and the journal of Faculty medicine - Baghdad University have recorded as the journals with most publications.

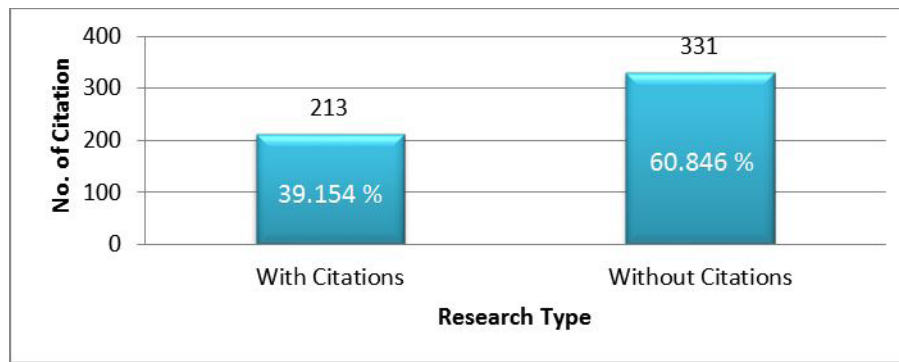


**Figure 5. Iraqi publications related to the type of journals**

Concerning citations, the current results showed that a total of 213 articles had citations and 331 papers without citations as shown in Figure 6. The top twelve research that ranked by the total number of citations has

recorded. The highest citation of the publications was 465 times, that captured by a study related to gastric cancer, published in Gastroenterology in 2007.





**Figure 6. Classification of Iraqi cancer articles depending on citations**

### Discussion

The current work is the first bibliometric research to analyze the Iraqi publications. Scopus (Elsevier) has been used owing to its inclusiveness of MEDLINE. Also, Scopus has a huge number of indexed journals (about 23,000 journals). So, the literature recovered from Scopus will be higher than that collected from the Web of Science and others. It is concluded that PubMed remains an important resource for medicine and biomedical sciences<sup>18</sup>. Moreover, Scopus has many characteristics that simplify citation analysis, calculating research partnership, and data arranged by Microsoft Excel for more tabulation and mapping. In fact, several published bibliometric researches have depended upon Scopus to collect their specific data<sup>19-21</sup>. Whereas; Cabral. et al.<sup>22</sup> performed their study using data from the Web of Science Core Collection. The finding of the current study showed that the number of Iraqi articles on cancer was significantly increased over the last years. Several factors may have contributed to this increasing trend. One important factor for this growth is that the global increase of cancer burden and particularly owing to the noticeable increase in the incidence of cancer in Iraq. Depending on the latest report of the Iraqi ministry of health in 2016, cancer resulted in 9.05% of all death, and it is the second leading cause of death in Iraq after cerebrovascular diseases<sup>23</sup>. Iraq, a war-torn country since the 1980s nowadays has several life challenges that have an impact on the population's development and its civil services. Medical health services and supplies considered as the most affected sectors in this country. In cancer care, for instance, there is deficiency in radiotherapy machines, inadequate funding, and infrastructure<sup>24-25</sup>. Intensity Modulated Radiation Therapy (IMRT) is one of the recent radiotherapy methods next to the 3-Dimensional-Conformal Radiation

Therapy which became available early 2000s in the developed nations. Despite all the challenges, IMRT was dependent in Iraq in 2013 and it is still running<sup>26</sup>. Furthermore, the degree of collaboration of Iraqi authors as high as 0.8, it is obvious from the present study that co-authorship and teamwork is a common phenomenon among cancer researchers in Iraq.

Regarding cancer types, the present data showed that there was a significant increase in the number of publications related to breast cancer. This finding confirmed the fact that the incidence of breast cancer in Iraq is relatively high, and has been increased during the previous few years, as concluded by a recent epidemiological investigation<sup>27</sup>. Since 2008, breast cancer incidence has amplified by more than 20%, although death has increased by 14% (522,000 deaths in 2012<sup>28</sup>). Similar to many other developing countries, Iraq struggles against the rising burden of breast cancer, the incidence in Iraqi females has risen in the last two decades and the frequency of the disease directed to younger age. *Owing to* lacking the healthcare, infrastructure required to identify, early diagnose, and the availability of treatment for the disease<sup>29-30</sup>. The cases in Iraqi female amplified from 26.6/100,000 in 2000 to 31.5/100,000 in 2009<sup>31</sup>. Moreover, it has been described that the average age at presentation of breast cancer in women from the Arabian region is about a decade earlier than the Western countries<sup>32</sup>. Results of recent investigation suggest that a comprehensive strategy to improve community awareness, surveillance, diagnosis, medication, and palliative care is required to decrease the emergent burden of breast cancer in Arab countries<sup>33</sup>. Furthermore, civil conflicts, added to the already existing social, political, and economic instabilities, certainly increase the burden of breast cancer in some Arab countries<sup>34</sup>. Also Abood<sup>35</sup> concluded that breast cancer onset at

least a decade earlier and at a late stage in Iraqi females when compared to patients of Western countries. Similar findings were documented in comparative research on the characteristics of breast cancer between Iraqi and British women. They pointed out that the mean age of the Iraqi patients at the time of diagnosis was 12 years younger than patients of Britain and also showed a higher tendency to infect advanced stages<sup>36</sup>.

Approximately 79% of Iraqi publications have been published in international journals, which represent a high percentage in comparison with articles published in national journals (20.5%). In this context, the current study has some limitations because some articles published in national journals were underestimated. Furthermore, numerous numbers of Iraqi publications have citations which reflected the importance of these studies, specifically which harvested a large number of citations like Rhead et al.,<sup>37</sup>. Recent findings suggested that in all subject areas, Google Scholar citation data is fundamentally a superset of Web of Science and Scopus, with considerable extra coverage<sup>38</sup>.

### Conclusion

This study showed that 49% of the number of publications was achieved during the period from 2015–2019. The occurrence of highly significant differences between Iraqi cancer publication before 2000 and that published after this year was also documented. The current study provides valuable insight into the cancer research productivity of Iraqi researchers. Also, it has clarified the trends among the investigation area. Besides this, the high degree of collaboration of Iraqi authors in this aspect, it was highlighted. This work proposes an evidence-based framework on which to initiate future research approaches and academic directions. Highlighting the causative agents of cancer, and how to develop effective control programs, are highly recommended.

**Conflict of Interest Statement:** We declare that we have no conflict of interest.

**Ethical Clearance:** It is not required

**Source of Funding:** Self

### References

1. Bray F, Ferlay J, Soerjomataram I, et al. Global cancer statistics 2018: GLOBOCAN estimates of incidence and mortality worldwide for 36 cancers in 185 countries. *CA Cancer J Clin* 2018;68:394-424. <https://doi.org/10.3322/caac.21492>
2. Ferlay J, Colombet M, Soerjomataram I, et al. Estimating the global cancer incidence and mortality in 2018: GLOBOCAN sources and method. 2019;144:1941-1953. DOI: 10.1002/ijc.31937. Epub 2018 Dec 6.
3. Fitzmaurice C, Allen C, Barber RM, et al. Global, Regional, and National Cancer Incidence, Mortality, Years of Life Lost, Years Lived With Disability, and Disability-Adjusted Life-years for 32 Cancer Groups, 1990 to 2015: A Systematic Analysis for the Global Burden of Disease Study. *JAMA Oncol* 2017;3:524-548. DOI: 10.1001/jamaoncol.2016.5688
4. Khoshnaw N, Mohammed HA, Abdullah DA. Patterns of Cancer in Kurdistan - Results of Eight Years Cancer Registration in Sulaymaniyah Province-Kurdistan-Iraq. *Asian Pacific journal of cancer prevention : APJCP* 2015;16:8525-8531.
5. Planning Directorate MoHE. Annual Statistical Report. Republic of Iraq, 2016.
6. Abdul Latif BI, Al-Diwan JK, Al-Hadithi TS, et al. Low birth weight and prematurity in the neonatal unit of a maternity and pediatrics hospital in Iraq. *J Trop Pediatr* 2006;52:148-50. DOI: 10.1093/tropej/fmi098.
7. Alaani S, Tafash M, Busby C, et al. Uranium and other contaminants in hair from the parents of children with congenital anomalies in Fallujah, Iraq. *Conflict and Health* 2011;5:15. DOI: 10.1186/1752-1505-5-15.
8. Bertell R. Depleted Uranium: All the Questions about Du and Gulf War Syndrome are Not Yet Answered. *International Journal of Health Services* 2006; 36:503-520. DOI: 10.2190/13JL-9LHM-FMR4-0V7B.
9. Hagopian A, Lafta R, Hassan J, et al. Trends in childhood leukemia in Basrah, Iraq, 1993-2007. *Am J Public Health* 2010;100:1081-7. DOI: 10.2105/AJPH.2009.164236
10. Karim ZA, Khidhir KG, Ahmed RA, et al. Leukemia Study in Sulaymaniyah Province, Kurdistan, Iraq. *Chin Med J (Engl)* 2016; 129:244-5. DOI: 10.4103/0366-6999.173551.
11. Al-Shammari AM. Environmental pollutions associated to conflicts in Iraq and related health problems. *Rev Environ Health* 2016; 31:245-50. DOI: 10.1515/reveh-2015-0024.

12. Fathi RA, Matti LY, Al-Salih HS, et al. Environmental pollution by depleted uranium in Iraq with special reference to Mosul and possible effects on cancer and birth defect rates. *Med Confl Surviv* 2013; 29:7-25. DOI: 10.1080/13623699.2013.765173.
13. Tadmouri GO, Bissar-Tadmouri N. Biomedical publications in an unstable region: the Arab world, 1988-2002. *Lancet* 2003;362:1766.
14. Latif R. Medical and biomedical research productivity from the Kingdom of Saudi Arabia (2008-2012). *J Family Community Med* 2015;22:25-30.
15. Michon F, Tummers M. The Dynamic Interest in Topics within the Biomedical Scientific Community. *PLOS ONE* 2009;4:e6544. <https://doi.org/10.1371/journal.pone.0006544>
16. Murray MR, Wang T, Schroeder GD, et al. The 100 most cited spine articles. *Eur Spine J* 2012;21:2059-69. DOI: 10.1007/s00586-012-2303-2
17. Subramanyam K. Bibliometric studies of research collaboration: A review. *Journal of Information Science* 1983;6:33-38. <https://doi.org/10.1177/016555158300600105>
18. Falagas ME, Pitsouni EI, Malietzis GA, et al. Comparison of PubMed, Scopus, Web of Science, and Google Scholar: strengths and weaknesses. *The FASEB Journal* 2008;22:338-342. DOI: 10.1096/fj.07-9492LSF
19. Sweileh WM. Bibliometric analysis of literature on toxic epidermal necrolysis and Stevens-Johnson syndrome: 1940 - 2015. *Orphanet J Rare Dis* 2017;12:14. DOI: 10.1186/s13023-017-0566-8
20. Sweileh WM. Bibliometric analysis of peer-reviewed literature in transgender health (1900–2017). *BMC International Health and Human Rights* 2018;18:16. DOI: 10.1186/s12914-018-0155-5.
21. Sweileh WM. A bibliometric analysis of health-related literature on natural disasters from 1900 to 2017. *Health Research Policy and Systems* 2019;17:18. <https://doi.org/10.1186/s12961-019-0418-1>
22. Cabral BP, da Graça Derengowski Fonseca M, Mota FB. The recent landscape of cancer research worldwide: a bibliometric and network analysis. *Oncotarget* 2018;9:30474-30484. DOI: 10.18632/oncotarget.25730
23. (IMH) IMoH. Annual statistical report. 2016.
24. Gendari AH, Ameen HA, Ramzi ZS, et al. Geriatric radiotherapy in a war-torn country: Experience from Iraq. *J Geriatr Oncol* 2018;9:346-351.
25. L M-H. *Cancer Care in Iraq: A Descriptive Study*: Riga, Latvia, LAP Lambert Academic Publishing 2012.
26. Mohammad KAM-H, L Y. . Three years of practicing Intensity Modulated Radiation Therapy (IMRT) in a war-torn country – 1st report from an Iraqi institution. *International Conference on Advances in Radiation Oncology*, 2017.
27. O SH, L AH, N AA, et al. Epidemiology of Breast Cancer among Females in Basrah. *Asian Pac J Cancer Prev* 2016;17:191-5.
28. Ferlay J, Soerjomataram I, Dikshit R, et al. Cancer incidence and mortality worldwide: sources, method and major patterns in GLOBOCAN 2012. *Int J Cancer* 2015;136:E359-86. <http://globocan.iarc.fr>
29. Alsamarai AM AS. Breast cancer frequency rate shift toward younger age in Iraq. *IJSRSET* 2015;1(5): 407-414.
30. Ewaid SH, Al-Azzawi LHA. Breast cancer risk assessment by Gail Model in women of Baghdad. *Alexandria Journal of Medicine* 2017;53:183-186. DOI: 10.1016/j.ajme.2016.09.001
31. (ICB) ICB. Results of the Iraqi Cancer Registry 2010. Baghdad: Iraqi Cancer Registry Center: Ministry of Health, 2010.
32. Albeshan SM, Mackey MG, Hossain SZ, et al. Breast Cancer Epidemiology in Gulf Cooperation Council Countries: A Regional and International Comparison. *Clin Breast Cancer* 2018;18:e381-e392.
33. Hashim MJ, Al-Shamsi FA, Al-Marzooqi NA, et al. Burden of Breast Cancer in the Arab World: Findings from Global Burden of Disease, 2016. *J Epidemiol Glob Health* 2018;8:54-58.
34. Burden of cancer in the Eastern Mediterranean Region, 2005-2015: findings from the Global Burden of Disease 2015 Study. *Int J Public Health* 2018;63:151-164. DOI:10.1007/s00038-017-0999-9.
35. Abood RA. Breast Cancer in Basra Oncology Center: A Clinico- Epidemiological Analysis. *Asian Pac J Cancer Prev* 2018;19:2943-2946. DOI: 10.22034/APJCP.2018.19.10.2943

36. Alwan NA, Kerr D, Al-Okati D, et al. Comparative study on the clinicopathological profiles of breast cancer among Iraqi and British patients. *The Open Public Health Journal* 2018;11. DOI: 10.2174/1874944501811010177
- 37- Rhead, J. L., Letley, D. P., Mohammadi, M., Hussein, N., Mohagheghi, M. A., Eshagh Hosseini, M., & Atherton, J. C. (2007). A New *Helicobacter pylori* Vacuolating Cytotoxin Determinant, the Intermediate Region, Is Associated With Gastric Cancer. *Gastroenterology*, 133(3), 926–936. doi:10.1053/j.gastro.2007.06.056
38. Martín-Martín A, Orduña-Malea E, Thelwall M, et al. Google Scholar, Web of Science, and Scopus: a systematic comparison of citations in 252 subject categories. *J. Informetrics* 2018;12:1160-1177. <https://doi.org/10.1016/J.JOI.2018.09.002>.

# A Study to Assess the Nursing Students Experience Regarding Online Classes During Covid-19 Lock Down Periods in SRM College of Nursing, Kattankulathur, Kancheepuram District-603203, Tamil Nadu, India

C. Kanniammal<sup>1</sup>, T. Suseelal<sup>1</sup>, P. Malarvizhi<sup>2</sup>, P. Vijay Daniel Raj<sup>2</sup>

<sup>1</sup>Dean, <sup>1</sup>Associate Professor, <sup>2</sup>Assistant Professor, <sup>2</sup>Tutor, SRM College of Nursing, SRM Institute of Science & Technology, Kattankulathur, Kancheepuram-603 203, Tamil Nadu, India

## Abstract

Covid-19 is a dreadful communicable disease which brought dramatic changes in the Education system globally. Online zoom classes are conducted all over the world to teach and guide the students, so that the academic year will not be wasted. The present study aims to explore the learning experience of nursing students regarding online classes during Covid-19 lockdown periods and to associate the learning experience of nursing students with the demographic variables. A single blinded quantitative study with purposive sampling technique, 250 B.Sc. Nursing students were enrolled in this study. Demographic variables and 23 questions on teaching, learning and difficulties of online classes were used in a 5 point likert scale. Data was collected by sharing the questions in Google dox format to the students. The result of the study revealed high level of satisfaction with maximum score of 63.0 and minimum score of 26.0. This result was significant with the mean value of 46.21 and the standard deviation of 7.32. The association of the learning experience of nursing students with the demographic variables was significant with the year of study of the participants. Hence the research hypothesis formulated in this study was proved.

**Keywords:** Covid-19, Online classes, Lock down period, Teaching, Learning, Difficulties, Nursing students experience.

## Introduction

Now a days Covid-19 virus is predominant globally. It is a dreadful communicable disease causing severe morbidity and mortality. Educational system is facing multiple challenges to complete the academic curriculum of 2020. Meticulous planning and guidance from the academicians, professors and teachers is essential to shift the classroom teaching to online Education. The online

Education has several technological advancement which has to be adapted by the teachers and students. India is a developing country giving the best education for all age groups. Online classes through media is valuable. Students are able to communicate with video and audio and clear all doubts with teachers. Home environment will be good to concentrate without emotional and physical strain<sup>1</sup>

In our daily work technology is used in maximum areas and it is the part and parcel of our life. Since the schools and colleges are closed due to lockdown digital and Microsoft zoom classes can be promoted by the universities. It will be flexible and economical<sup>2</sup>. Virtual education is emerging all over the world. Faculties and students has to develop skills to online teaching mode. The parents has to understand and cooperate. So that the academic curriculum can be completed without any loss for the students.<sup>3</sup>

---

### Corresponding Author:

**Dr. T. Suseelal**

College of Nursing, SRM Institute of Science and Technology, Kattankulathur, Kancheepuram, District-603203, Tamil Nadu, India  
Phone No.: 9952943319  
e-mail: suseelal.john@gmail.com

Worldwide around 1.5 billion students are learning in on line mode. Many students do not have wifi connection and high-fi cell phone. The parents must buy the necessary gadgets and they should supervise their children to gain maximum benefit from on line classes. Most of the students are interested in virtual education. The teachers has to provide adequate content in advance. So that the students will be aware of their lessons. Many new advancement are available which can be used by the teachers.<sup>4,5</sup>

Previous studies revealed the control method of influenza. That time school education were modified. <sup>6</sup> Since this online education is new to the students few students reported eye strain and head ache. It can be solved by adjusting the class time.<sup>7</sup>

One of the study done on the impact of Covid-19 and higher education revealed that students were unaware of the classes and there was lack of personal touch and interaction. It can be tackled by the teachers by enquiring the students individually. The parents has to give their full support and motivate their students to cooperate with the current scenario.<sup>8</sup>

Another study done in Maharashtra, India stated that some of the students reported positive impact on online classes and few students reported about lack of concentration. However online classes are very useful except network issues which can be rectified. It is the responsibility of the Universities to support their professor's and teacher's in completion of the curriculum and conduction of on line examination to promote the students.<sup>9</sup> with this great vision the faculty of SRM College of Nursing intended to assess the Nursing students experience regarding online classes during Covid- 19 lockdown period. This study was done after 4 months of online education.

### **Material and Method**

The study was conducted through online among B.Sc. Nursing students of SRM College of Nursing in the month of August 2020. B.Sc. Nursing students 250 were enrolled by purposive sampling technique. Demographic variables include were age, gender, course of study, device used by students to attend online classes, online media used by teachers.

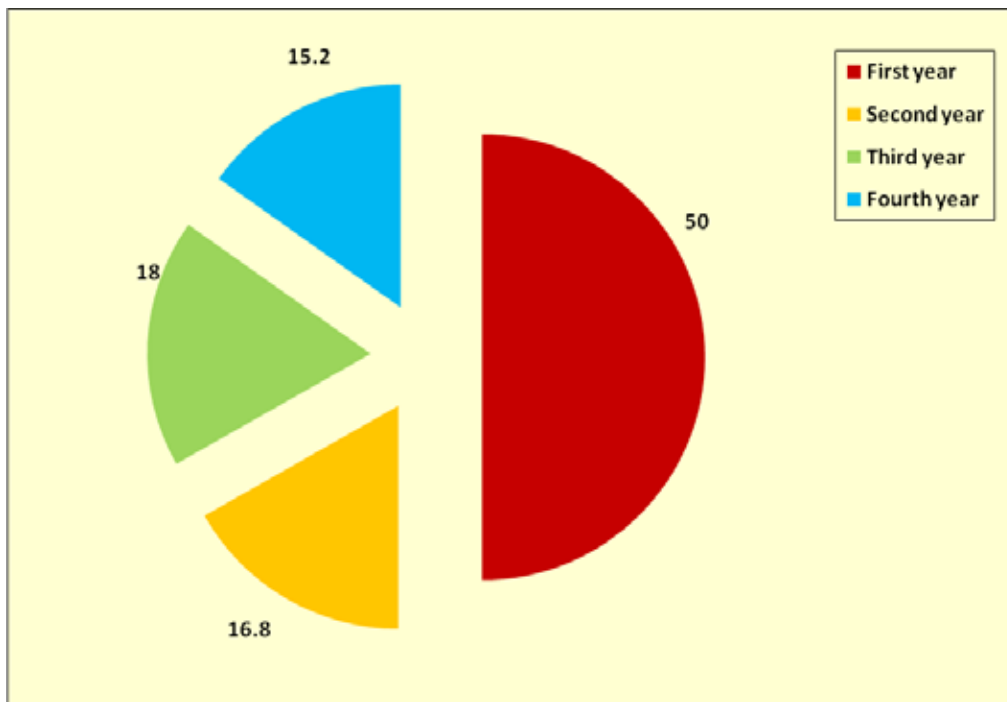
Around 23 self-structured questions were developed in Google dox form on 3 domains such as teaching, learning and difficulties of online classes in a likert scale with 5 points. In teaching dimension effectiveness of teaching method used by the faculty, response to online classes and the students satisfaction on the online teaching were included. In learning dimension effectiveness of understanding learning process, positive effect regarding university exam, ideas on future online classes and their interest to traditional learning were included. Regarding online difficulties the students over all stress level in online classes, stress due to Covid -19 disease condition, students feelings on online versus traditional lectures, problem on internet issues, time to read and physical problems experienced were included. One open ended question on their suggestions regarding teaching, learning and difficulties faced in virtual classes was included.

**After the** correction of the tool by the experts in Medical Surgical Nursing, pilot study was done among 10 students in online. The reliability of the tool was tested by test retest method and the r value 0.8 was found to be reliable. The questionnaire was found feasible to proceed to the main study.

The Google form questionnaire was shared to the students in on line to the participants. The collected raw data was spread in the Excel master coding sheet and it was analysed using statistical package for social sciences (spss- 16). The p value of 0.05 level was used for statistical significance.

### **Results**

Regarding the frequency and percentage distribution of the demographic variables revealed majority of the participants among 250 B.Sc. Nursing Students 204 (81.6%) belongs to 18-20 years, females were 206 (82.4%), majority of them 240 (96.0%) used smart phone for the online classes and around 10 (4.0%) students used laptop. Regarding method of teaching majority of the teachers 241 (96.4%) used the zoom app and the Google class room on line was used by 7 teachers (2.8%).



**Fig. I. Percentage distribution of year of study of nursing students**

**Table 1: Frequency and percentage distribution of level of learning experience among nursing students. N = 250**

Learning Experience	No.	%
Unsatisfied (1–21)	0	0
Satisfied (22–42)	71	28.4
Highly satisfied (43–63)	179	71.6

The above table reveals majority of the students 179 (71.6%) were highly satisfied and 71 (28.4%) of the students were satisfied with the on line classes done by the teachers.

**Table 2: Assessment of mean and standard deviation of learning experience score among nursing students. N = 250**

Variables	Score
Minimum Score	26.0
Maximum Score	63.0
Mean	46.21
Standard Deviation	7.32

The above table reveals high level of satisfaction with maximum score of 63.0 and minimum score of 26.0. This result is significant with the mean value of

46.21 and the standard deviation of 7.32. Hence the study is significant.

The association of the learning experience of nursing students with their demographic variables was significant with the year of study of the participants. Other variables like age, gender, course of study, device used by students to attend online classes, online media used by teachers were not associated with the demographic variables.

### Discussion

The present study on assessing the experience of Nursing students about online classes during Covid -19 lock down period is the need of the hour. This is the first time the Nursing faculty and students of SRM College of Nursing were exposed to online classes. It is believed that during this lock down period students are having many difficulties to understand the classes. There is no motivation, no social interaction and the students are psychologically upset due to the distraction and lack of support at home. Some of the students have very poor net work coverage and the students had head ache due to continuous online education mode. The students were convinced by the teachers and by weekly 3 classes and individual phone calls and watsup messages students were happy to cooperate with the classes.

In this study 250 B.Sc. Nursing students participated. The findings of the present study revealed that majority of the students 179 (71.6%) were highly satisfied and 71 (28.4%) of the students were satisfied with the on line classes done by the teachers. The result of the study revealed high level of satisfaction with maximum score of 63.0 and minimum score of 26.0. This result was significant with the mean value of 46.21 and the standard deviation of 7.32. The association of the learning experience of nursing students with the demographic variables was significant with the age group of the participants. Hence the research hypothesis formulated in this study was proved.

This result is supported by the study of **Dr. Anjana kannankara** (2020) on E-learning the Best Bet during lockdown. The study states that online learning will facilitate to face the challenge of working in this new environment as well as embrace the new opportunities to everyone. Hence, this study can be done in other areas of education to facilitate the online education.<sup>10</sup>

### Conclusion

The present study high light the success of the online teaching and learning programme of B.Sc. Nursing students during this Covid-19 pandemic period. The teaching faculty and the students has to adapt new learning method for the completion of the curriculum. The parents has to help and motivate the students in continuous learning process during this critical situation. This study can be done in other areas of education to develop knowledge and confidence among the students.

**Acknowledgement:** The Dean and team of Medical Surgical faculty conceived and designed the study and collected the data. Analysis was done by Mr. Arvind statistitian. Interpretation and drafting of the article was done by Dr. T. Suseelal, P. Malarvizhi and Mr. P. Vijai Daniel Raj. Dean, college of Nursing has done the final revision and approval of version to be published.

**Conflict of Interest:** The authors declared no competing interest.

**Ethical Clearance:** Ethical approval was obtained from the SRM University research committee who follows WHO standards and the 1964 Helsinki declaration and its later amendments.

**Source of Funding:** Self

### References

1. Shatakshi L, Nardav S. CoVid-19 Unmasking the new face of Education among the students' studying at Graphic Era Hill University, Dehradun, Uttarakhand, India. *IJ Research Pharm Sci.* 2020; 11(1):48-53
2. VeenaS, Sheetal M, Navita V. COVID 19 Lockdown Technology Adaption, Teaching, Learning, Students Engagement and Faculty Experience in Banglore. *Muktshabd.* 2020; 10(4),698-702
3. Giorgi B, David K. Transition to Online Education in Schools during aSARS-CoV-2 Coronavirus (COVID-19) Pandemic in Georgia. *Pedagogical Research.* 2020; 5(4) : 2-9
4. Daniel J. Education and the COVID-19 pandemic. 2020.
5. Vikram R. J, Bagul TD, Sagar R A. COVID-19 era: students' role to look at problems in Education system during lockdown issues in Maharashtra. *I J Research and Review.* 2020; 7(5): 328-33
6. Russell M. V, Simon J R, Helen C, Joseph W, Claire S, et al ., School closure and management practices during coronavirus outbreaks including COVID 19: a rapid systematic review. 2020; 4 (5) : 397-404
7. Wei B. COVID-19 and online teaching in higher education: Human behavior and emerging technologies. A case study of Peking University. 2020; 2 (2):
8. Amit K. A, Srinivasan R. Impact of Pandemic COVID-19 on the Teaching – Learning Process : A Study of Higher Education Teacher Manages. *Indian journal of management.* 2020; 13 (4) :43-56
9. Vikram R. J, Tushar D, Bagul, Sagar R.A. COVID-19 Era: Students' Role to Look at Problems in Education System during Lockdown Issues in Maharashtra. *India IJ Research and Review.* 2020; 7 (5): 328- 33
10. Anjana K.E.-Learning: The Best Bet during lock down. 2020.



# Study of Anxiety Levels among Occupational Therapy Students During Various Academic Assessments

Chirag Pincha<sup>1</sup>, A.V. Anuja<sup>2</sup>, A. Sangeetha<sup>3</sup>, M. Karthika<sup>4</sup>, Samuel Sundar Doss<sup>5</sup>

<sup>1</sup>MBBS Student, <sup>2</sup>Assistant Professor, <sup>3</sup>Assistant Professor, Department of Physiology, Saveetha Medical college & Hospital, Thandalam, Chennai, <sup>4</sup>Assistant Professor, Department of Physiology, Dhanalakshmi Srinivasan Medical college & Hospital, Perambalur, <sup>5</sup>Tutor, Department of Physiology, Saveetha Medical college & Hospital, Thandalam, Chennai

## Abstract

Test anxiety among university graduate students is significant and generates public interest. Test anxiety leads to cognitive symptoms such as racing thoughts, nausea, blankness and difficulty in retrieving information. When stress is experienced in excess it contributes to anxiety before and during exams and eventually affects academic performance.

**Aim:** The aim of the study is to evaluate the anxiety levels among occupational Therapy students during various academic assessments.

**Method:** A total of 160 Occupational Therapy Students participated in this study. The Anxiety Inventory was used to evaluate the anxiety level.

**Results:** The results indicated that anxiety affects students performance during theory & practical assessments and was found to be statistically significant ( $p < 0.0001$ ).

**Recommendation:** It is suggested that the pattern of conducting examinations may be modified to reduce student test anxiety.

**Keywords:** Test anxiety, Academic Assessments, Occupational Therapy Students.

## Introduction

One of the most pervasive reactions that students have to encounter during different types of academic assessments is test anxiety<sup>(1)</sup>. Test anxiety by definition is a set of phenomenological, psychological, and behavioural responses that accompany possible negative consequences in a person<sup>(2)</sup>. Academic stress is an emerging problem across countries, cultures and must

be viewed in detail<sup>(3)</sup>. Every student has a dream to lead success, family pride & social mobility<sup>(4)</sup>. Test Anxiety is a bi-directional structure of affective & Cognitive elements<sup>(5)</sup>. The cognitive component is Self cretinism and negative effects of failure during exams<sup>(6)</sup>. The student anxiety during the test causes an inability to recall information, rise in heart rate, nervousness, sweaty palms<sup>(7)</sup>.

Stress is not necessarily harmful, stress can motivate and it is a state of mental or emotional strain due to adverse or demanding circumstances<sup>(8)</sup>. The signs of stress which is experienced by most students before and during the examination are irregular sleep, tiredness, stomach upset, loneliness, feeling restless, difficulty in recalling whatever studied, panic when the question paper is given and difficulty answering it. The most stressful factors identified in educational institutions

---

### Corresponding Author:

**Dr. A.V. Anuja**

Assistant Professor, Department of Physiology,  
Saveetha Medical College & Hospital, Chennai  
e-mail: dr.anujasaki@gmail.com  
Mobile No.: 9710702121

are evaluations and competitions between students and students' academic failures<sup>(9)</sup>. Identifying the influencing factors on student academic performance is a challenge for teachers<sup>(10)</sup>. Since the test scores are very significant for academic and carrier progress, the students are naturally under immense pressure to achieve high scores so the test anxiety becomes an universal experience in contemporary society, there seems to be some connection between the level of anxiety, experienced by the learners and their scores<sup>(11)</sup>.

Aside from academic factors, other influencing factors include financial factors, health problems<sup>(12)</sup>. This anxiety during or before exams have a major impact leading to lack of decision making and gives rise to nervousness and might also lead to suicide<sup>(13)</sup>. It is perceived that to reduce anxiety levels in students before & during exams constructive learning method only will help the students to become independent and develop their own concepts pertaining on the subjects<sup>(14)</sup>. This anxiety many of the students face before their exams may interfere with their ability to score marks<sup>(15)</sup>. This study focuses on the anxiety levels of different age groups among occupational therapy students.

### Materials

A cross-sectional questionnaire based study was conducted among occupational therapy students during the academic year 2019-20 at Saveetha Medical College and Hospital after obtaining ethical approval by the board of the institute (SMC/IEC/2019/22). Informed consent of the participants were obtained. A total of 160 students between 18-24 yrs participated in the study. Students on depression medication or any physical anxiety and depression were excluded from the study. The Test Anxiety Scale Questionnaire by Nist and Diehl (1990) was used to measure the level of anxiety. This

scale consists of 10 items. Each item is scored based on how often they have experienced the mentioned signs of test anxiety. The scoring consisted of a 5-point scale, in which 1 was (never), and 5 (always) Items were then summed for a total score, which ranged between 10 and 50, where low scores between 10-19 indicated that students do not suffer from test anxiety, mid-scores between 20-35 indicated that although students exhibit some of the characteristics of test anxiety, the level of stress and tension is healthy and high scores over 35 showed that students experience unhealthy levels of anxiety. The questionnaire included demographic details, age, sex and symptoms before and during exams. Students those who are having history of neurological disorders, psychological disorders were excluded from the study. Signs of nervousness such as sweaty palms, shaky hands right before the test and panic attack before exam, going blank and not able to recall before the exam, trouble sleeping the night before the exam were collected. The data was analyzed using SPSS 20.1.

### Results

The present study was done to assess anxiety among Occupational therapy students during different academic assessments and the results are as given below.

**Table I : Demographic details**

	Theory	Practicals	Mean & SD
<b>Age:</b>			
18 yrs	11	11	19.5 ±0.92 (Theory)
19yrs	21	24	19.5 ±0.89 (Practicals)
20 yrs	44	44	
<b>Sex:</b>			
Male	11%	12%	
Female	66%	71%	

Table I show that more students were in the age group of 19 and 20 yrs with mean age 19 ±0.92 years. of the participants >65 % were females.

**Table II: Comparison of Anxiety scores between Theory and Practical Assessments**

Assessment	Low score	Moderate score	High Score	Chi-Square ( $\chi^2$ )	P Value
Theory n = 77	1%(0.96)	4%(16.84) (9.79)	72% (59.19) (2.77)	24.333	<0.5
Practical n = 83	1% (1.04)	31% (18.16) (9.09)	51% (63.81) (2.57)		

Table II indicates a high degree of anxiety level (High score > 36-50) among occupational therapy students during theory and practical assessment. The results show statistically significant. ( $\chi^2 = 24.223$ ,  $p < 0.5$ ).

**Table III: Comparison of test anxiety among Occupational students during Theory & Practical assessment.**

Parameters	Theory (Mean±SD)	Practicals (Mean±SD)	t-test
1. Do you have any viable signs of nervousness such as sweaty palms, shaky legs, right before the test?	2.18±0.93	2.44 ± 1.00	p = 0.1150 t = 1.5946
2. Do you experience butterflies in your stomach before the exam	2.00±0.86	2.32±1.04	p = 0.039* t = 2.0744
3. Do you feel nauseous before the exam?	1.49±0.87	2.90±0.94	p = 0.0001 * t = 9.8069
4. Does your mind go blank before the test?	2.43±0.87	2.35±0.89	p = 0.5672 t = 0.5734
5. Do you remember the information that you blanked out in the exam hall and remember as soon as you get out of the exam hall?	2.41±0.82	2.60±0.93	p = 0.2253 t = 1.2225
6. Do you feel panicked knowing that the exam is time-limited and get more nervous and write the exam worse	2.20±0.80	2.11±0.87	p = 0.4566 t = 0.7483
7. Do you feel that you have done your test badly as soon as you leave the exam?	1.93±0.60	2.15±0.88	p = 0.0399* t = 2.0915
8. Do you feel nervous if the teacher stands next to you and then You can no longer answer the questions?	2.01±0.92	2.23±0.92	p = 0.1290 t = 1.5348
9. Do you feel you take most of the time in answering the questions or to decide to hand in the paper or not?	2.12±0.73	2.07±0.78	p = 0.6890 t = 0.4018
10. Do you feel constantly restless throughout the test (moving your feet playing with your pen looking around the room and looking at the clock)	2.12±0.92	2.57±1.13	p = 0.0183* t = 2.4123
11. Do you feel that the invigilator/teacher is watching you?	2.00±1.83	2.27±0.96	P = 0.0864 t = 1.7376

Table III explains the student mean score of test anxiety relation between theory & practical assessment.

The students faced the dreaded stomach before practical exam (p= 0.039\*), nausea (p= 0.0001\*), felt bad that they performed badly once they left the exam hall (p=0.0399\*) and the students were constantly restless throughout the test (p =0.0183\*). The results were found to be statistically significant. The study also showed that students were more nervous to practical viva when compare to theory 52.4% were always nervous, 24.4% were often nervous and 18.3% were nervous sometimes during practical exam. A majority of participants never felt 51.2% that viva is easier to score marks than theory and practical exam 39% and 8.5% sometimes and often felt that viva is easier to score respectively. The results also showed that 30 % of participants during Theory exam never felt has forgotten everything and may fail while the remaining 70 % has forgotten and felt may fail. Also only 23.7% of participants do not feel more nervous sitting in first row during the exam remaining 76.3% feel more nervous sitting in first row.

## Discussion

Exam anxiety may cause cognitive changes like difficulty in memorizing, inability to recall information's etc<sup>(16)</sup>. Exceeding level of test anxiety results in mental, physical discomfort leading to focus problems and mental disruption<sup>(17)</sup>. Diversity of findings found in various researches indicates that different factors cause test anxiety in students<sup>(18)</sup>. Some authors suggest that test anxiety may worsen cognitive resources like attention and working memory, thus preventing students from concentrating on the exam<sup>(19)</sup>. The present study revealed that majority of participants were female in the mean age group of 19.5 ±0.92 yrs (Table I). Studies repeatedly found due to higher levels of emotion in females generally report higher levels of anxiety<sup>(20)</sup>. Arch reported a very high prevalence of anxiety and depression (70%) among medical students in Pakistan<sup>(21)</sup>. Another study has shown that academics and taking exams are the most powerful stresses in medical and paramedical students<sup>(22)</sup>. The result of this study was identified to have a high level of anxiety score and the

highest mean score during practical examinations. This result is similar to David & Ross<sup>(23)</sup> who proposed that a very high proportion of students had some form of test anxiety. More recent explanations refer to the fact that anxiety may affect students' motivation and undermine their learning strategies<sup>(24)</sup>. Whatever the cause, test anxiety may reduce students' academic achievement by interfering with their exam preparation, their performance while taking an exam, or both.

### Conclusion

The study shows that anxiety affects students' performance during theory & practical assessments and was found to be statistically significant. Hence it is suggested that the pattern of conducting examinations may be modified or certain relation techniques can be applied before exams to reduce student test anxiety.

**Limitation of the Study:** Further studies including a large number of medical and paramedical students should be done.

**Source of Funding:** Self

**Conflict of Interest:** Nil

**Acknowledgment:** We acknowledge great help received from the scholars whose articles are cited and included in the references of this manuscript.

### References

1. Sarason IT, Test anxiety and the intellectual performance of college students. *Journal of Educational Psychology*, 1961; 52: 201–206.
2. Zeidner M. Test anxiety: The state of the art. New York: Plenum Press. Online [http://www.uc.edu/psc/sh/SH\\_Test\\_Anxiety.htm](http://www.uc.edu/psc/sh/SH_Test_Anxiety.htm). 1998.
3. Wong PTP, Wong LCJ, Scot C et al. Beyond stress and coping: The positive psychology of transformation. *Handbook of Multicultural perspectives on stress and coping*. New York, NY: Springer.2006; 1-26.
4. Gow L, Balla J, Kember D et al . The learning approaches of Chinese people: A function of socialization processes and the context of learning. In M. H. Bond (Ed.)*The handbook of Chinese psychology* .New York: Oxford University Press. 1996.109– 123.
5. Morris L, Davis W, Hutchings CH et al. Cognitive and emotional components of anxiety: Literature review and a revised worry-emotionality scale. *Journal of Educational Psychology*, 1981; 73: 541–555.
6. Zeidner M. Test anxiety: The state of the art. New York: Plenum Press. Online [http://www.uc.edu/psc/sh/SH\\_Test\\_Anxiety.htm](http://www.uc.edu/psc/sh/SH_Test_Anxiety.htm).1998
7. Eysenck MW. Anxiety: The cognitive perspective. Hove, England: Erlbaum. 1992.
8. Mittal R, Kumar R. Exam stress in MBBS students and the method used for its alleviation. *Int J Med and Dent Sci* 2018; 7(1):1604-1608
9. Fairbrother K, Warn J. Workplace Dimensions, Stress and Job Satisfaction, *J. Managerial Psychology*.2003; 18(1): 8-21
10. Eggen P, Kauchak D. *Educational Psychology: Windows on Classrooms*. Upper Saddle River, NJ: Prentice Hall. 4th ed.1999
11. Bonde JP. Psychosocial factors at work and risk of depression: a systematic review of the epidemiological evidence. *Occup Environ Med*.2008; 65(7):438-45.
12. Ahmed W, Minnaert A, Kuyper H et al. Reciprocal relationships between mathself-concept and math anxiety. *Learning and Individual Differences*, 2011; 22: 385-389
13. Banerejee S, Youth and Exam Stress, *Social Welfare*, 2001;48:17.
14. Hyseni-Duraku, Interplay Z between academic and personal factors in the academic performance of Bachelor students. 2014
15. Thangaraj S, Souza L. Prevalence of stress levels among first year medical undergraduate students. *International Journal of Interdisciplinary and Multidisciplinary Studies*, 2014;1:176-81.
16. Alam MM. Academic achievement in relation to socio-economic status, anxiety level and achievement motivation: A comparative study of Muslim and non-muslim school children of Uttar Pradesh. Doctoral Dissertation, Aligarh Muslim University .2001.
17. Hamzah F, Che Mat K, Bhagat V, Mahyiddin N. Test Anxiety and its Impact on first year University Students and the over View of mind and body Intervention to Enhance coping Skills in Facing Exam. *Research J. Pharm. and Tech*. 2018; 11(6):2220-2228.
18. Moadeli Z, Ghazanfari-Hesamabedi MA. Survey

- on the students' exam anxiety in the Fatemeh (P.B.A.H.) College of Nursing and Midwifery. *Journal of Strides in Development of Medical Education*, 2005; 1(2):65-72.
19. Eysenck, MW. *Anxiety: The cognitive perspective*. Hove, England: Erlbaum. 1992
  20. Deffenbacher JL. Worry and emotionality in test anxiety. In Sarason IG (Ed.), *Test anxiety: Theory, research, and applications*. New Jersey: Lawrence Erlbaum Associates. 1980.
  21. Khan MS, Mahmood S, Badshah A et al. Prevalence of depression, anxiety and their associated factors among medical students in Karachi, Pakistan. *J Pak Med Assoc*. 2006; 56(12):583-586.
  22. Fuad MD, Al-Zurfi BMN, Abdelqader MA et al. Prevalence and risk factors of stress, anxiety and depression among medical students of a private medical university in Malaysia. *MJPHM*. 2016;16(3):87-92.
  23. David B, Ross. College of Lake County, Grayslake, Illinois 847-543-2352. <http://clcpage.s.cllinois.edu/home/cou052.2010>
  24. Linnenbrink EA, Schutz PA, Pekrun R The role of affect in student learning: A multi-dimensional approach to considering the interaction of affect, motivation, and engagement. In (Eds.), *Educational psychology serie*, 2007; 107-124.

# Plasma CD4 Count and Duration ARV as a Predictor of Virological Failure Amongst AIDS Patients

Choirina Windradi<sup>1,2</sup>, Erwin Astha Triyono<sup>1,3</sup>, Musofa Rusli<sup>1,3</sup>

<sup>1</sup>Faculty of Medicine, Universitas Airlangga, Surabaya 60131, Indonesia, <sup>2</sup>Senior resident of Department of Internal Medicine, Faculty of Medicine- Dr. Soetomo Teaching Hospital, Universitas Airlangga, Surabaya 60131, Indonesia, <sup>3</sup>Tutor of Tropic and Infection Department of Internal Medicine, Faculty of Medicine- Dr. Soetomo Teaching Hospital, Universitas Airlangga, Surabaya 60131, Indonesia

## Abstract

**Background:** The 90-90-90 strategy to overcome the HIV/AIDS (*Human Immunodeficiency Virus/Acquired Immunodeficiency Syndrome*) epidemic in the world still has challenges because 20% of people live with HIV/AIDS (PLWHA) received anti retroviral (ARVs) are at risk of virological failure. This study describes and analyzes the factors that influence the occurrence of virological failure in AIDS patients who have taken ARVs.

**Method:** A hospital based cross-sectional study and retrospective medical record review in Dr. Soetomo Teaching Hospital Surabaya from January 2017 until December 2018. Virological failure is plasma viral load greater than 1000 copies/ml.

**Result:** According to data analysis for each variable, we used a CD4 (*Cluster of Differentiation*) cut-off of 134 cells/ $\mu$ l and  $\geq 20.5$  months for virological failure. There was a statistically significant relationship between CD4 cell count 95% CI (1.33-11,281) p 0.010 and duration of ARV (1,396-11.78) 95% CI p 0.01. Summation of total score from both variables has a p value  $<0.001$  which means the total score of the two variables is significant as a predictor of virological failure. The total area of the ROC curve is 73.6% with a sensitivity of 81.5% and specificity of 44.4%.

**Conclusion:** The duration of ARV consumption and CD4 cell count have an effect and can be an initial evaluation of the occurrence of virological failure.

**Keywords:** *Virological Failure, HIV, AIDS, ARV.*

## Introduction

Human Immunodeficiency Virus (HIV) is a virus that causes serious health problems in the world. In Indonesia, in 2018 an increase in the prevalence of

people with HIV/AIDS (Acquired Immunodeficiency Syndrome) (PLWHA). The strategy in the world to overcome the epidemic is 90-90-90 which means that by the end of 2020 90% of all patients is diagnosed of HIV, get antiretroviral (ARVs), and suppression of viral load (viral load/VL)<sup>(1)</sup>. Yet, Indonesia could only reached 47% to diagnose of HIV status, 31.9% of ARV accesses, and 0.6% suppression of viral load<sup>(2)</sup>.

ARVs play an important role in achieving the 90-90-90 target. However, one of the challenges in the management of HIV is virological failure. About 20% of PLWHA experience virological failure despite taking ARVs<sup>(2)</sup>. Meanwhile, virological failure is associated with a 40% risk of death<sup>(3,4)</sup>.

---

### Corresponding Author:

**Dr. Erwin Astha Triyono**

Department of Internal Medicine, Faculty of Medicine- Dr. Soetomo Teaching Hospital, Universitas Airlangga, Surabaya 60131, Indonesia

Tel: +6231-502-3865; Fax: +6231-502-3865

e-mail: erwintriyono@yahoo.com

Extensive research on the factors associated with virological failure has been carried out. In a case control study in Ethiopia, CD4 counts  $<200$  cells/mm<sup>3</sup>, first-line ARV regimens and adherence had an important role in the occurrence of virological failure<sup>(5)</sup>. Thus, the existence of other known risk factors in the population from this study is expected to provide a new perspective in the management of PLWHA as well as interventions, especially in Indonesia.

The results of this study are expected to be able to explain the factors that influence virological failure in PLWHA who has received ARVs.

## Materials and Method

**Study area, design, time, population:** A hospital based cross sectional study with a retrospective approach in HIV patients at outpatient clinic UPIPI (Intermediate Care Unit and Infectious Diseases) Dr. Soetomo Hospital Teaching Surabaya. This study is conducted from January 2017 until December 2018.

We collect medical record of HIV/AIDS patients aged  $\geq 21$  years who suspicious suffered from virological failure based on the criteria of clinical, immunological, virological failure, and non-compliance with taking ARVs at least for 6 months. We ruled out patients who did not have plasma CD4 count and viral load data at the time of study. Sample was carried out in a consecutive manner from population met the inclusion criteria and there were no exclusion criteria.

**Terms of Operational:** Virological failure is a condition in PLWHA that shows failure to suppress the amount of virus in the blood after taking ARV for at least 6 months, a viral load of more than 1000 copies/ml. Good adherence is the number of drugs taken compared with the drugs given every month  $\geq 95\%$ .

## Result

**Sociodemographic Characteristic of Patients:** A total of 72 patients met the inclusion and exclusion criteria were included in this study. of these, 51 were men while 21 were women. The average age (SD) of

patients in this study was 39.04 (9,964) (range 24-67 years). The average duration of ARV consumption was 29.3 (32.3) (range 6-156 months). 54 patients had primary education (75%) while 18 (25%) patients continued through college. 48 (66.7%) patients received FDC and 24 (33.3%) patients received regimens based on TDF/NVP, ZDV/NVP, ZDV/EFV, ZDV/LPV, TDF/LPV, TDF/RPV, and FTC/LPV. The majority of patients in the study had risk factors for unsafe sex (heterosexual or homosexual) (93%). 55 patients (76%) were in stage III-IV. Opportunistic infections that accompanied the patients in this study were hepatitis C 3 (4%), Toxoplasmosis 8 (11%), PCP 13 (18%) and tuberculosis 13 (18%) (**Table 1**).

**Virological failure and Associated Factors:** Of the variables associated with virological failure, CD4 cell count and duration of antiretroviral drugs have a significant relationship. The normality test from the CD4 data shows  $p > 0.05$  which means that the CD4 data has a normal distribution while the duration of ARV consumption has an abnormal data distribution ( $p < 0.05$ ). The CD4 test was then continued with Mann Whitney (**Table 2**) data analysis while the duration of ARV consumption used an independent t-test (**Table 2**).

Using data analysis, the cut-off for CD4  $\leq 134$  cells/ul was obtained while the duration of ARV consumption was  $\geq 20.5$  months. Statistical analysis for CD4 data and ARV duration using the SPSS 20 program showed a significant relationship between CD4 cell count ( $p < 0.05$ ) and duration of ARV consumption ( $p < 0.05$ ) with virological failure. We use logistic regression analysis to calculate SE and  $\beta$  to formulate a predictive total score (**Table 3**). From the results of the analysis, each score of 1 was obtained for CD4 cell count and duration of ARV.

Summation scores to each of the research subject variables was described as total scores that passed on to logistic regression analysis. The next assessment is the discrimination of the scoring model obtained  $p$  value  $< 0.001$  with an area under curve (AUC) of 73.6%. The cut-off of this model shows a sensitivity value of 81.5% and a specificity of 44.4% (**Picture 1**).

**Table 1. Factors Contribute to Virological Failure**

Variable	Group		p-value
	Failure n (%)	Non Failure n (%)	
<b>Gender</b>			
Men	18 (35,2%)	33 (64,8%)	0,598
Woman	9 (42,8%)	12 (57,2%)	
<b>Education</b>			
Primary	21(38,9%)	33 (61,1%)	0,782
College	6 (33,3%)	12 (67,7%)	
<b>ARVs Regimen</b>			
FDC	15 (31,2%)	33 (68,8%)	0,132
Non FDC	12 (50%)	12 (50%)	
<b>Risk Factors</b>			
Unsafe Sex	23 (34,3%)	44 (65,6%)	0,062
Drug injections	4 (80%)	1 (20%)	
<b>Hepatitis C</b>			
Positive	2 (66,67%)	1 (33,3%)	0,136
Negative	5 (19,2%)	21 (80,8%)	
<b>Tuberkulosis</b>			
Positive	7 (53,8%)	6 (46,2%)	0,214
Negative	20 (33,8%)	39 (66,1%)	

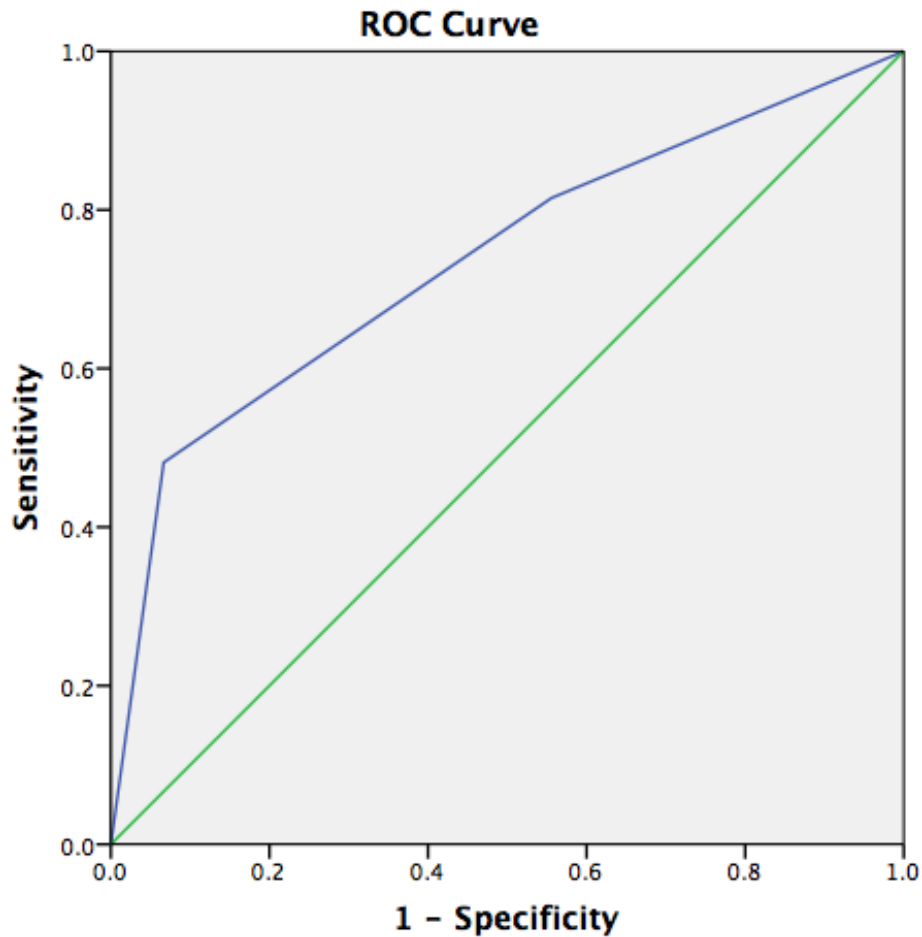
**Table 2. Statistical Analysis For ARV Duration and CD4 Count**

Variable (n=72)	Suppression VL (n=45)	Virological Failure (n=27)	P value	OR (95%)
ARV duration	21.44±26.05	42.59±37.6	0.01	1.396-11.78
CD4	255.38±190.328	156.36±140	0.01	1.33-11.281

**Table 3. Logistic Regression Analysis and Model Scoring for Plasma CD4 count and Duration ARV Consumption**

Variabel	b	SE	β/SE	(β/SE)/2.484	Rounded
ARV Duration	1.354	0.545	2.484	1	1
CD4 Count	1.400	0.544	2.573	1.03	1
<b>Total score</b>					<b>2</b>





**Picture 1. ROC Curve For Total Score of Plasma CD4 Count and Duration ARV Consumption**

## Discussion

The results of data analysis for each variable that affects virological failure, only CD4 and duration of ARV have a significant relationship. The total predictor scores of the two variables have significant results so that the score model can assist clinicians in evaluating suspicion of virological failure. The assumption of this score is that patients with CD4 counts  $\leq 134$  and duration  $\geq 20.5$  months have a risk of virological failure with a sensitivity of about 81.5%.

CD4 T cells are known as components of the humoral and cellular immune responses to exogenous antigens. HIV binds to CD4 molecules on the surface of helper T cells (Th cells) and replicates on them. This causes damage and decreases in CD4 T cell counts<sup>(6)</sup>.

Several hypotheses in 1980 stated that the decrease in the number of CD4 T cells was caused by rapid damage due to resistance to HIV. Through this theory there is a

balance of homeostasis when CD4 T cells are damaged by HIV, it will be offset by T cell production. However, this balance mechanism will be disrupted when there is no production response to T cells due to the burden of T cell production. Therefore, during HIV infection, around one billion HIV particles are produced each day, causing an increase in the number of infected CD4 T cells. Every time a memory CD4 T cell is infected, it will undergo an elimination process that causes a decrease in the number of CD4 T cells. The mechanism of apoptosis of infected CD4 T cells supports this hypothesis but naïve CD8 T cells and uninfected CD4 T cells that participate in elimination in the asymptomatic phase cannot be explained by this process<sup>(6)</sup>.

The second hypothesis that causes CD4 T cell decline in HIV is chronic immune activation under hyperimmune conditions. This condition induces an increase in the division of CD4 cells, CD8 cells, NK cells, and B cells. T cell division also increases the

ability to renew itself which can increase the number of cells. The hypothesis of the number of T cells decreases due to activation because the activated CD4 has a short life and disappears due to apoptosis. HIV causes its targets and increases replication through chronic immune activation. HIV activates immunity through Nef, Tat, Vpr, Vpu and pro-inflammatory cytokines. The presence of HIV DNA in the cytoplasm will activate pro-inflammatory cytokines so that the HIV virus will cause chronic immune activation<sup>(6)</sup>.

Patients with low CD4 cell counts have a nine-fold risk of virological failure than patients with high CD4 cell counts ( $> 200$  cells/mm<sup>3</sup>). This finding is consistent with research in Switzerland and Uganda. In theory, there is an inverse relationship between CD4 cell count and replication and viral load. Patients with impaired immune status have a risk of opportunistic infections as well as low immune status and high levels of viral replication. Patients with CD4 counts  $\leq 199$  have a risk of virological failure OR 10.09 95% CI (2.47-41.29), CD4 200-349 OR 2.94 95% CI (0.86-10.07), CD4 350-499 OR 0.83 95% CI (0.18-3.8). CD4<sup>+</sup> T cells are the majority of cells infected with HIV. The HIV virus causes adverse effects on the level and proportion of these cells in lymphoid tissue and blood. Some of the mechanisms adopted by viruses that cause a reduction in CD4<sup>+</sup> lymphocyte counts include dysregulation of cell proliferation and homeostasis. HIV-1 infection alters CD4 T-cell homeostasis, which is a balance between the rate of production and cell death. This results in a higher rate of cell damage compared to production, contributing to a decrease in CD4<sup>+</sup> T cells. HIV infection also interferes with the production of thymic and hematopoietic progenitor cells, causing cell death through the release of the gp120 virus protein. HIV infection causes a cycle that involves activation and death of the immune system then drives HIV replication<sup>(7)</sup>.

Adherence is an important factor for the success of therapy in AIDS patients. Interruption of ARV consumption, especially the NNRTI regimen, causes an increase in virological failure and antiretroviral resistance. This observation reflects the low genetic barrier to antiviral resistance to NNRTIs, such as prolongation of the plasma half-life of NNRTI, which causes the plasma concentration of NRTI therapy to decrease. In areas with limited access to antiretroviral therapy, interruption of therapy causes the total cost of treatment to be more expensive due to difficulty accessing health services, distribution difficulties and drug storage.

The risk of non-compliance leads to virological failure OR 3.6 95% CI (1.2-11)<sup>(8)</sup>. Unfortunately, bivariat analysis of adherence in this study did not show a significant relationship.

When adherence decreases, the dose of the drug becomes intermittent, causing exposure to single and multiple drugs to have a longer half-life. A similar situation occurs when PLWHA stop all antiretroviral drugs<sup>(9)</sup>. In this study, if the duration of antiretroviral drugs was assessed based on the duration of antiretroviral consumption, a significant relationship was found ( $p < 0.001$ ) which means that the longer the patient took antiretrovirals the lower the adherence to antiretroviral consumption.

Limitation of this study were this research was conducted at the outpatient clinic UPIPI Dr. Soetomo Teaching Hospital Surabaya, which is a tertiary referral health facility so that the exclusion inclusion criteria cannot describe the condition of HIV/AIDS patients extensively, CD4 evaluation data and viral load are not all tested periodically so they cannot describe the tendency of failure and suppression of virological, incomplete medical record data regarding reasons for selection, replacement of antiretroviral drugs and side effects of antiretroviral drugs in patients, unable to evaluate virological failure based on patient adherence every 6 months and the underlying reasons. Furthermore, the total score predictor model shows an area under curve of only 73.6% indicating that there are other variables that can affect virological failure.

Researchers hope that with these findings an evaluation of virological failure can be carried out intensively. This will have an impact on the patient's clinical course, the risk of drug mutations and the mortality of AIDS patients. A study with patient compliance interventions is needed to study the relationship of adherence to virological failure in HIV/AIDS patients.

## Conclusion

Patients with CD4  $\leq 134$  cells/ul and duration of ARV consumption  $\geq 20.5$  months have a risk of virological failure.

**Acknowledgments:** We would like to express our deepest gratitude for the patients who participated in the study and the work of the Outpatient Clinic UPIPI Dr. Soetomo Hospital Teaching and support research. The

tremendous contributions on the part of the counselors, medical records staff, have been essential to the success of this study.

**Conflicts of Interest:** The authors declare no conflicts of interest in this HIV/AIDS research.

**Source of Funding:** This research did not received any endorsement or funded by specific grant. All the funding came from researchers.

**Ethical Consideration:** Ethical clearance was obtained from Ethics Committee Dr. Soetomo Teaching Hospital Universitas Airlangga and official letter was submitted to the Dr Soetomo Hospital administration prior to data collection.

### References

1. UN Joint Programme on HIV/AIDS (UNAIDS). to help end the AIDS epidemic. United Nations. 2014; 1-30.
2. Menkes. Keputusan Menteri Kesehatan Republik Indonesia Nomor HK 0107/Menkes/90/2019. Pedoman Nasional Pelayanan Kedokteran Tatalaksana HIV. 2019;1–220.
3. Endebu T, Deksisa A, Moges T, Kisi T, Ensermu T. Incidence of Virological Failure and Associated Factors among Adult HIV-Positive Patients on First Line Antiretroviral Therapy Regimen, Central Ethiopia. 2018;4(2):44–51.
4. Miller V, Phillips AN, Clotet B, Mocroft A, Ledergerber B, Kirk O, et al. Association of Virus Load, CD4 Cell Count, and Treatment with Clinical Progression in Human Immunodeficiency Virus–Infected Patients with Very Low CD4 Cell Counts. *J Infect Dis.* 2002;186(2):189–97.
5. Kiweewa F, Esber A, Musingye E, Reed D, Crowell TA, Cham F, et al. HIV virologic failure and its predictors among HIV-infected adults on antiretroviral therapy in the African Cohort Study. *PLoS One.* 2019;14(2):1–16.
6. Vijayan KV, Karthigeyan KP, Tripathi SP, Hanna LE. Pathophysiology of CD4+ T-Cell depletion in HIV-1 and HIV-2 infections. *Front Immunol.* 2017;8(MAY):1–8.
7. Lagat K (Lahti U of ASDP in N. FACTORS LEADING TO FASTER PROGRESSION OF HIV TO AIDS. 2018;
8. Ayele G, Tessema B, Amsalu A, Ferede G, Yismaw G. Prevalence and associated factors of treatment failure among HIV/AIDS patients on HAART attending University of Gondar Referral Hospital Northwest Ethiopia. *BMC Immunol.* 2018;19(1):1–13.
9. von Wyl V, Klimkait T, Yerly S, Nicca D, Furrer H, Cavassini M, et al. Adherence as a Predictor of the Development of Class-Specific Resistance Mutations: The Swiss HIV Cohort Study. *PLoS One.* 2013;8(10):1–11.

# Physiotherapy Students Willingness to Report Misconduct to Protect the Patient's Interests in Chennai

D. Malarvizhi<sup>1</sup>, Bhagya Lakshmi K.<sup>2</sup>, Hariharan S.<sup>2</sup>

<sup>1</sup>Prof. Dean, <sup>2</sup>BPT IV YEAR Student, SRM College of Physiotherapy, SRM Institute of Science and Technology, Kattankulathur, Chengalpattu, Tamil Nadu, India

## Abstract

**Background:** Applying the ethics in practice is more essential than just learning it. Any sought of misconduct to the patient is not just an ethical issue but it will also degrade the professionalism and it brings a sense of insecurity in patients and this will slow down the progress of treatment. So it is not only important to avoid the ethical issues and misconduct but it is also necessary to stand against ethical issues that happen within the organization that may done by colleagues or higher authorities without any dilemma. **OBJECTIVE:** This study aims to find out the difficulties and dilemmas of the physiotherapist in ethical decision making and disclosing the misconduct of their colleagues without any hesitation. **METHODOLOGY:** A close ended questionnaire was used to assess the willingness of the student physiotherapist to expose the misconduct which might be an internal or external disclosure. The questionnaire consisted of two clinical scenarios which were most likely to arise in a work place. Each scenario consisted of 5 questions that rated the severity, likelihood of confronting, internal disclosure, external disclosure to the association and external disclosure to media. The scoring was based on five point likert scale. It was a study that was done with convenient sampling method. The questionnaire was given to 100 Physiotherapy students in Chennai of both the sexes who were willing to participate in the study. **RESULT:** From the statistical analysis, there is a significant difference obtained for the likelihood of reporting the manager's misconduct than colleague's misconduct. Also their willingness to report internally within the organization is greater than that of reporting externally to the association and to the media. **CONCLUSION:** Ethics being a part of Physiotherapy curriculum, these students have well understood the ethical and professional behavior and have good ethical acceptance. Hence we conclude that the students do understand the seriousness of any misconduct of a therapist to the patient and are willing to expose any misconduct they encounter to the internal or external environment.

**Keywords:** *Ethics, Students, Physiotherapy, Misconduct, Ethical dilemma*

## Introduction

Whistle blowing is usually defined as the reporting "by organization members (former or current) of illegal, immoral, or illegitimate practices under the control of their employers to persons or organizations that may be able to effect action"<sup>1</sup>. Reporting any sought of unethical behaviour is more inevitable and essential in the field of health sciences as it is concerned with human lives. Whistle blowing largely helps in the reducing the rates of misconduct in future<sup>2,3</sup>. But still blowing a whistle against the organisation or colleague or a superior is a major dilemma faced by an individual because when blowing a whistle, it not only involves the whistle blower

and the organisation but it also involves the patient who is actually affected, this will lead to deterioration of the hospital's fame. This will put the whistle blower at risk<sup>1,2</sup>. All though whistle blowing is a moral behaviour, it will risk the life of the one who reports the misconduct. The person who voluntarily reports the misconduct might be exploited and might end up in losing his livelihood<sup>1,4</sup>. Despite these consequences it is to be noted that those who are with high self-ideals are the one to report the misconduct as they are ones intolerable to the unethical behaviour<sup>4</sup>. It must also be noted that a person will hesitate to report his friend if found guilty because of their bond or because of the fear that they might get caught one day<sup>5</sup>.

When a person is dishonest or unethical during his student life then there are high chances that he will be more deviant during his professional life<sup>5</sup>. Any unethical behaviour as a professional will lead to distrust of patients and a sense of insecurity which in turn reduces the progress in the patient condition that will lead to ending up of the professional's career<sup>6</sup>. This is the reason why any sought of unprofessional behaviour has to reported and stopped immediately. Since ethical acceptance begins at the college level<sup>7</sup>, it is important to know level of ethical knowledge and their willingness to follow ethics and their ability to make decisions in critical cases and their willingness to report the unethical behaviour that is either conducted by their superior or their colleague. Though this subject is of high importance there are not enough researches done in India to find out about the ethical dilemmas and decision making related to physiotherapy. Our study aims to find out how well the students are able to understand the seriousness of the misconduct of the therapist to the patient and how willing are they to expose any misconduct they encounter to the internal or external environment. Internal disclosure implies reporting misconduct to an higher authority within the organization. External disclosure implies reporting misconduct outside the organization such as law enforcement or media

### Materials and Methodology

Based on the selection criteria only physiotherapy students of UG final year, PG first and second year and interns those who were pursuing their degree in

Chennai were selected as participants. Departmental ethical committee approval was obtained. A total of 100 participants were aimed and a closed ended questionnaire was sent as google forms. Students from colleges without ethics as a part of curriculum were excluded. Initially the participants were asked to fill the demographic data that included the name, age, college they belonged to, and the year they were studying. The questionnaire consisted of 2 clinical scenarios and 5 set of questions were asked under each scenario. The first scenario was related to colleague's misconduct and the second one was concerned with the misconduct by the higher official. The first question dealt with how far the students were able to understand the seriousness of the situation while the second question dealt with the student's willingness to confront the misbehaviour to the one who committed it and insisting him to correct what he did. Question 3 and 4 dealt with blowing whistle to the internal environment. Question 5 is related to the blowing of whistle to the external environment. All the questions were rated according to 5-point likert scale. The answer for the first question ranged from "very serious" to "not serious at all". The answers for the remaining four questions ranged from "strongly agree" to "strongly disagree".

### Results

The mean differences between the groups were assessed using the paired sample's test. The data were analyzed using SPSS statistical software, PC version 20.0

**Table 1: Comparison between the respondents' scores for the two case stories regarding the severity of the misconduct, the likelihood of taking action to change the situation and the indices of internal and external whistle blowing.**

	Sample	Case story 1 colleague misconduct (n 100)		Case story 2 director misconduct (n 100)	
		Mean	SD	Mean	SD
1. Severity of the misconduct	100	3.75	0.989	4.03	0.915
2. Likelihood of taking action by confronting the person responsible for the wrongdoing to repair the harm done	100	3.84	0.861	4.04	0.953
3. Internal whistle blowing: likelihood of reporting the misconduct to someone in the workplace	100	3.51	1.010	3.78	1.069
4. External whistle blowing: likelihood of reporting the misconduct to the Physical Therapists' Association	100	3.43	1.037	3.64	0.802
5. External whistle blowing: likelihood of reporting the misconduct to the media	100	3.15	1.086	3.65	1.029

**Table 1** shows the comparison between the respondents’ scores for the two case stories regarding the severity of the misconduct, the likelihood of taking action to change the situation and the indices of internal and external whistle blowing.

**Table 2: Paired sample test**

Paired Samples Statistics					
		Mean	N	Std. Deviation	Sig.
<b>Pair 1:</b> Internal whistle blowing reporting to a superior in the work place	If you decide not to talk to your colleague, or if you have talked to her about the matter and not succeeded in getting her to report the incident, how likely is it that you will go to someone at the center who has the power to intervene, such as the head of physiotherapy ward or ethics comitee, or if snyone is at the rehablitationcentre	3.51	100	1.010	.010
	If you decide not to talk to the director, or if you have talked to her and not been able to change her mind, how likely is it that you will report the director’s intentions to someone at the center who has the power to intervene, such as the center’s genral director or ethics comitee if any one is at the centre	3.78	100	1.069	
<b>Pair 2:</b> External whistle blowing reporting to the physical therapists association	If you decide not to approach anyone at the centre, or if you do talk to someone and he or she does nothing to intervene, how likely is it that you will turn to the Physical Therapists’ Association, an external body	3.43	100	1.037	.016
	If you do not refer the matter to an authority at the centre, or if you do and he or she does not intervene in the director’s decision, how likely is it that you will turn to the Physical Therapists’ Association, an external authority?	3.64	100	0.802	
Colleague’s report to media	If you decide not to report the matter to the Physical Therapists’ Association, or if you do talk to them and they do nothing, how likely is it that you will report the matter to the media?	3.15	100	1.086	.056
<b>Pair 3:</b> Director report to media	If you decide not to report the matter to the Physical Therapists Association, or if you do talk to them and they do nothing, how likely is it that you will report the matter to the media?	3.65	100	1.029	

**Table 1** shows the comparison between the respondents’ scores for the two case stories regarding the severity of the misconduct, the likelihood of taking action to change the situation and the indices of internal and external whistle blowing. From the scores obtained, the likelihood of reporting director’s misconduct is higher than that of colleague’s misconduct.

**Table 2** shows the comparison between the scores of the internal and external whistle blowing to the association and to media. From the scores obtained, the likelihood for internal whistle blowing is higher than that of external whistle blowing. There is a significant difference (0.010) between the internal whistle blowing for colleague and director misconduct. There is a significant difference (0.016) between the external whistle blowing for colleague and director misconduct in reporting to the physical therapy association. There is

a non-significant difference (0.056) between the external whistle blowing for colleague and director misconduct in reporting to the media.

### Discussion

The purpose of this study is to find out how well the students are able to understand the seriousness of the misconduct of the therapist to the patient and how willing are they to expose any misconduct they encounter to the internal or external environment. Totally 100 physiotherapy students with ethics as a part of curriculum were taken into consideration out of which 58 female and 42 male students have participated. From the study it is found that the physiotherapy students witnessed the situations that are harmful to the patients to be very serious. In such situations, they are likely to report to the higher authorities in both cases

of misconduct by their colleague as well as manager. However the rate of likelihood to report varied between both the case stories. Hence there was a significant difference obtained by the statistical analysis of the obtained data. From the scores obtained the likelihood of considering the severity of misconduct, confronting the person responsible for the wrongdoing, reporting the misconduct to someone in workplace, to the association or to the media for the director's misconduct was higher than that of colleague's misconduct. This shows that the students give more importance to the interest of patient rather than supporting the misconduct of colleague or manager. In situations where such misconduct arises their willingness to report seems to be expressed rather than supporting the misconduct. Similarly the scores obtained for internal whistle blowing was higher than that of external whistle blowing. The reason for this might be because the students prioritize to report to the superior authority within the organization than disclosing it outside the organization<sup>8</sup>. Also **Abraham Mansbach et al., (2011)** has stated that the students prefers and follows a pattern of internal whistle blowing after which the external whistle blowing is being is approached rarely<sup>9</sup>. **Anna Myers., (2008)** has also stated that it is wiser to whistle blow first internally and then externally outside the organization. It is more ethical and also being loyal to the organization<sup>10</sup>. While also expresses that whistle blowing to an unethical or a deviant act is a core component of an employee and that at all costs whistle blowing to root out a criminal activity which is possibly harmful to the client or the reputation of the institution must be encouraged<sup>11</sup>.

### Conclusion

Ethics being a part of Physiotherapy curriculum, these students have well understood the ethical and professional behavior and have good ethical acceptance. Hence we conclude that the students do understand the seriousness of any misconduct of a therapist to the patient and are willing to expose any misconduct they encounter to the internal or external environment.

The limitation and recommendation of the study are The answer that was recorded by the participants was just their interest and opinion towards whistle blowing as a student. But the actual response that they give when they are into the situations might vary. In future studies can be done with a comparison between physiotherapy students with and without ethics as a part of curriculum.

In future studies can be done with a comparison between physiotherapy students and practitioners.

**Ethical Clearance:** Departmental Ethical clearance was obtained.

**Conflict of Interest:** Nil

**Source of Funding:** Self

### References:

1. Mansbach A, Kushnir T, Ziedenberg H, Bachner YG. Reporting misconduct of a coworker to protect a patient: a comparison between experienced nurses and nursing students. *The scientific world journal*. 2014;2014.
2. Mansbach A, Bachner YG. Internal or external whistleblowing: nurses' willingness to report wrongdoing. *Nursing Ethics*. 2010 Jul;17(4):483-90.
3. Ray SL. Whistleblowing and organizational ethics. *Nursing ethics*. 2006 Jul;13(4):438-45.
4. C.Fred Alford. Ithaca, NY; Whistleblowers: Broken Lives and Organizational Power. Cornell University press,2001 17pp.
5. Abdulghani HM et.al, Self-reported cheating among medical students: An alarming finding in a cross-sectional study from Saudi Arabia, *PLoS ONE*(2018)13(3)
6. Paul S Mueller et.al, Teaching and Assessing Professionalism in Medical Learners and Practicing Physicians. *Ramban Maimonides Med J* 2015;6(2)
7. Dworkin TM, Baucus MS. Internal vs. external whistleblowers: A comparison of whistleblowing processes. *Journal of business ethics*. 1998 Sep 1;17(12):1281-98
8. Abraham Manasbacht.al, Physiotherapy students willingness to report misconduct to protect the patient's interest *J Med Ethics* 2010 36:802-805.
9. Mansbach A, Bachner YG, Melzer I. Physical therapy students' willingness to report misconduct to protect the patient's interests. *Journal of medical ethics*. 2010 Dec 1;36(12):802-5.
10. Myers A. How to blow the whistle safely, *Nursing Standard* (through 2013). 2008 Feb 27;(25):24
11. Dungan J, Waytz A, Young L. The psychology of whistleblowing. *Current Opinion in Psychology*. 2015 Dec 1;6:129-33.

# Effect of Phase 1 Cardiac Rehabilitation to Non-Invasive Hemodynamics in Acute Myocardial Infarction Patients

Desi Natalia Trijayanti Idris<sup>1</sup>, Dian Taviyanda<sup>1</sup>, Srinalesti Mahanani<sup>1</sup>

<sup>1</sup>Lecturer of Nursing Study Bachelor Program, STIKES RS Baptis Kediri

## Abstract

Cardiovascular emergencies often occur suddenly, delays in treatment cause the condition to worsen. One of the cases of cardiovascular emergency is acute myocardial infarction (AMI). AMI patients must have stable hemodynamics in order to improve their condition. Management of nursing care that can be done to maintain hemodynamic stability of AMI patients is the implementation of Phase 1 Cardiac Rehabilitation. The purpose of this study was to analyze the effect of Phase 1 Cardiac Rehabilitation on Non-Invasive Hemodynamics for Acute Myocardial Infarction Patients in the ICCU Room of Kediri Baptis Hospital. The research design used a quasi experiment one group pre post test design. Population in this study were all AMI patients who were treated in the ICCU Room of the Kediri Baptist Hospital who were taken using a quota sampling technique with a sample size of 35 respondents. The instrument used was an observation sheet including: systolic - diastolic blood pressure and heart rate. Phase 1 cardiac rehabilitation program intervention was carried out for 2 consecutive days, with 2 training sessions/day (morning and evening). Each training session with a duration of 15 minutes. The data analysis of this study used the Paired T-Test statistical test. The results of this study showed that  $p = 0.026$ ,  $p = 0.014$   $p < 0.05$  and that  $p = 0.024$   $p < 0.05$ , which means there is an effect of phase 1 cardiac rehabilitation on systolic, diastolic blood pressure and heart rate in acute myocardial infarction patients in the ICCU room of Kediri Baptist Hospital. Conclusion Cardiac Rehabilitation Phase 1 has a significant effect on heart muscle function based on the results of blood pressure checks seen from systolic and diastolic and heart rate. Where the greatest significance is on heart rate compared to blood pressure.

**Keywords:** *Cardiac Rehabilitation Phase 1, Non-Invasive Hemodynamics, Blood Pressure, Heart Rate.*

## Introduction

Acute Myocardial Infarction (hereinafter referred to as AMI) is myocardial necrosis caused by an imbalance between the supply and demand for oxygen to the heart muscle<sup>1</sup> and or AMI is a disease that attacks the heart organ. Which causes cell death in the heart muscle due to a long myocardial ischemic process in the heart<sup>2</sup>. Patients with AMI must receive therapy for at least 24 hours, and preferably for the index hospitalization duration, up to 8 days or until the patient does not feel the symptoms of infarction, namely no chest<sup>3</sup>. Myocardial ischemia will occur in the initial state if reperfusion action is not taken immediately, this can lead to permanent (irreversible) heart necrosis. AMI can cause complications due to ventricular remodeling and ultimately can lead to cardiogenic shock, congestive heart failure, and persistent ventricular dysrhythmias. Management of

action on AMI cannot be delayed if there is a delay every 30 minutes it can increase the risk of death by about 80%<sup>4</sup>. During treatment it is necessary to observe to see whether the patient's hemodynamics have increased or decreased. It is hoped that the hemodynamic condition after an AMI attack can be maintained at normal levels/conditions.

Based on data from the American Heart Association in 2014, heart disease is the cause of 1 in every 6 deaths in the United States in 2010<sup>5</sup>. Heart disease causes 7.2 million deaths per year worldwide<sup>6</sup>. AMI and its associated functional disorders can cause heart failure affecting 2-3% of the population in industrialized countries with an increase in age > 65 yr. A combined estimate of 20 million people have heart failure in Europe and the US and its prevalence is increasing. The highest Case Fatality Rate (CFR) occurred in AMI (13.49%) and



then followed by heart failure (13.42%) and other heart diseases (13.37%)<sup>7</sup>. This phenomenon is supported by the results of the Basic Health Research in 2013 which showed that AMI is one of the diseases diagnosed by many doctors compared to other heart disorders<sup>8</sup>. According to the medical record data of the ICCU room at Kediri Baptist Hospital (November 2019), 45 patients came with an AMI medical diagnosis.

AMI patients experience atherosclerotic plaque in the blood vessels, this can play an important role in the occurrence of total or almost total occlusion, either due to the thrombus blockage that is formed or by platelet aggregation and inflammatory responses that can cause a decrease in coronary blood flow, this results in failure of contractions ventricles, decreased cardiac output (hemodynamically unstable) and compensatory mechanisms that will overwork the heart and can cause the area of necrosis to expand<sup>9</sup>. Increased heart rate rhythm usually does not occur continuously, parasympathetic stimulation (mostly inferior) can reduce heart rate and blood pressure<sup>10</sup>. Blood pressure has an important role in determining risk stratification and effective prognosis information, where low blood pressure is associated with a poor prognosis, although there are several studies reporting different results<sup>11</sup>. Hemodynamic treatment in AMII patients aims to improve oxygen delivery in the body which is affected by (Cardiac Output/CO), hemoglobin (Hb), and oxygen saturation (SaO<sub>2</sub>). If oxygen delivery is impaired due to decreased cardiac output (CO), proper handling is required, cardiac output is an important hemodynamic variable and is often assessed by one of them based on NIBP and on the calculation of the MAP value (Mean Aetrial Pressure), by measuring pressure. Blood and mean arterial pressure (MAP), can indicate conditions of cardiac output.

AMI management requires a holistic approach, both in prevention and treatment. The management of AMI can be divided into two, namely pharmacology and non pharmacology. In general, the pharmacology that can be done is to give nitroglycerin tablets if pain complaints persist, aspirin, Clopidogrel, morphine sulfate, and reperfusion therapy. For AMI patients, the principle of pharmacological management is to make a prompt and precise diagnosis, determine whether there is an indication for immediate reperfusion with thrombolytics, restore coronary blood flow with primary thrombolytics to save the heart from AMI, limit the extent of AMI, and maintain heart function<sup>12</sup>. Research

that supports this Patrick, (2013) states that AMI patients undergo reperfusion with fibrinolytic therapy for at least 48 hours, and preferably for the duration of hospitalization index, up to 8 days or until the patient does not feel the symptoms of infarction, which is not feeling chest pain<sup>3</sup>. Non-pharmacological management can be provided with bed rest, oxygenation, and cardiac rehabilitation<sup>13</sup>. In addition to fibrinolytic therapy, post AMI patients need to be rehabilitated by the heart, so that they can return to optimal conditions physically, medically, psychologically, socially, emotionally, sexually, and vocational, cardiac rehabilitation is also useful for exercising mobility and heart work and restoring conditions to meet needs everyday life. It is possible that if cardiac rehabilitation is not carried out then the heart muscles periodically decrease activity, expand ischemia or infarction and trigger repeated attacks, this can lead to death. The rehabilitation program for people with heart problems is a multiphase program designed to restore heart problems, especially those with coronary artery disorders. This program includes physical activity training, psychological counseling, and behavioral therapy towards a healthy lifestyle<sup>14</sup>. This program aims to optimize heart function, eliminate psychological problems, and improve the quality of life of patients<sup>15</sup>. Rehabilitation is an integral part of the holistic management of heart disease, in addition to standard medical therapy and cardiac intervention measures for some sufferers. Cardiac rehabilitation is basically a process that aims to restore the physical, psychological, and social functions of an AMI patient to an optimal level. This is supported by research<sup>16</sup> which explains that when cardiac rehabilitation is carried out there needs to be a doctor's control as the person in charge of care and it is necessary to observe vital signs and evaluate heart records. Cardiac rehabilitation is carried out by doctors, physiotherapists, nurses, psychologists, nutritionists and social workers. The cardiac rehabilitation program consists of four phases, namely phase I during which the patient is hospitalized which focuses on early ambulation and health education. Phase I cardiac rehabilitation is the initial recovery after an acute phase attack carried out in the ICCU room for 2-3 days, in infarct patients without complications, and 5-7 days in infarct patients who have complications. Phase II immediately after the patient is discharged from the hospital which is carried out under the supervision of the rehabilitation team. Phase III immediately after phase II is still under supervision and phase IV is a long-term maintenance phase. The goal of rehabilitation in phase

It is to accelerate the recovery process and minimize the risk of prolonged rest and immobilization, such as deep vein thrombosis and muscle weakness<sup>17</sup>.

**Method**

The research design used a quasi experiment one group pre post test design. The single research variable is non-invasive hemodynamics, namely blood pressure and pulse frequency. Population in this study were all AMI patients who were treated in the ICCU Room of the Kediri Baptist Hospital who were taken using a quota sampling technique with a sample size of 35 respondents. The action that will be given to the patient is cardiac rehabilitation phase 1 which is performed 1x24 hours after the patient does not feel chest pain. Prior to the implementation of phase 1 cardiac rehabilitation, the patient was measured blood pressure and pulse frequency as measured variables. Researchers were assisted by assistants or research assistants (ICCU room nurses) to select predetermined respondents and then provided informed consent and explanations of research procedures. The instrument used was an observation sheet including: systolic - diastolic blood pressure and pulse frequency. Hemodynamic monitors are used to measure the patient’s blood pressure, pulse rate. Phase 1 cardiac rehabilitation program intervention was carried out for 2 consecutive days, with 2 training sessions/day (morning and evening). Each training session with

a duration of 15 minutes. Hemodynamic assessment was done pre-test (before intervention), and post-test every day after the intervention in the afternoon. The data in the study consist of two demographic data and respondent hemodynamic data. The data analysis of this study used the Paired T-Test statistical test. Before the statistical test was carried out, the data normality was tested and declared normal. The study was conducted after obtaining ethical clearance from the Health Research Ethics Commission (KEPK) STIKES Baptis Hospital Kediri. This research has passed ethics with letter number 076/30/III/EC/KEPK-3/STIKES WSBK/2020.

**Result**

**Description of Sample Characteristics:**

Characteristics of acute myocardial infarction patients based on gender with the most frequent male 21 respondents, namely 60%, age with a maximum frequency of 56-60 years 21 respondents, namely 34.3%, with a mean of 60.00 and a standard deviation of ± 7.985, a history of hypertension with a frequency of more than 50% had a history of hypertension 20 respondents that is 57.1%, a history of diabetes mellitus with a frequency of more than 50% had a history of hypertension 19 respondents that is 54.3% and family history with the frequency of AMI at most have a family history with AMI 24 respondents that is 68.6%.

**Non-Invasive Hemodynamic Data (Blood Pressure and Heart Rate):**

**Table 1. Statistical Test of the Effect of Phase 1 Cardiac Rehabilitation on Systolic Blood Pressure in Acute Myocardial Infarction Patients in the ICCU Room at Kediri Baptis Hospital April - August 2020 (n = 35)**

		t	df	Sig. (2-tailed)
Pair 1	Difference in systole before intervention - difference in systole after intervention	2.333	34	.026

**Table 2. Statistical Test of the Effect of Phase 1 Cardiac Rehabilitation on Diastolic Blood Pressure in Acute Myocardial Infarction Patients in the ICCU Room at Kediri Baptis Hospital April - August 2020 (n = 35)**

		t	df	Sig. (2-tailed)
Pair 1	Difference of Diastole Before Intervention - Difference of Diastole After Intervention	2.590	34	.014

**Table 3. Statistical Test of the Effect of Phase 1 Cardiac Rehabilitation on Heart Rate in Acute Myocardial Infarction Patients in the ICCU Room at Kediri Baptist Hospital April - August 2020 (n = 35)**

		t	df	Sig. (2-tailed)
Pair 1	Difference of Diastole Before Intervention - Difference of Diastole After Intervention	2.363	34	.024

Based on table 1, the results show that  $p = 0.026$   $p < 0.05$ . Based on table 2, the results show that  $p = 0.014$   $p < 0.05$  and based on table 3, the results show that  $p = 0.024$   $p < 0.05$ , which means that there is an effect of phase 1 cardiac rehabilitation on systolic, diastolic blood pressure and heart rate in acute myocardial infarction patients in ICCU room Kediri Baptist Hospital.

## Discussion

Mortality and morbidity of cases of cardiovascular emergencies often occur suddenly, delays in handling brought to the emergency room cause the condition to worsen. Cardiovascular disease is a disease that involves the heart and blood vessels. Heart disease is estimated to be the leading cause of death worldwide, this is evidenced by the rapidly increasing prevalence of cardiovascular disease in developed and developing countries. The prevalence and incidence of this disease is quite high and is increasing from year to year<sup>18</sup>.

Heart problems are health problems whose incidence has increased from year to year. One of the heart disorders is Acute Myocardial Infarction (AMI). Globally, this is the first major cause of death in developing countries, replacing the death rate due to infection, another thing stated by Waly et al (2014) is that one of the cardiovascular diseases that is the leading cause of death in the world is Acute Myocardial Infarction (AMI). The case fatality rate (CFR) of the IMA is the highest compared to other heart diseases. Intensive systematic efforts are needed to prevent increased morbidity cases that can be handled by cardiac rehabilitation programs. Patients with heart problems need a comprehensive rehabilitative program to develop post-attack physical abilities and prevent recurrent attacks. Heart disorders are pathological conditions in the heart where there are abnormalities that cause physiological disorders of the heart.

IMA is a condition in which the blood supply to a part of the heart stops so that the heart muscle cells die<sup>19</sup>. This situation refers to the process of damage to the myocardial tissue of the heart which experiences necrosis due to inadequate blood supply so that coronary blood flow is reduced. The cause of decreased blood supply may be due to critical narrowing of the coronary arteries due to atherosclerosis or total blockage of the arteries by embolism or thrombus. Therefore, in each case there is always an imbalance between the supply and demand for cardiac oxygen<sup>20</sup>.

This disorder can be asymptomatic (asymptomatic), mild, to severe. Heart attack (myocardial infarction) is a serious disorder in which heart blood flow stops, causing the death of some heart cells. Heart problems are the number one cause of death in adults in developed countries. The factors that trigger a heart attack are smoking, consuming high cholesterol foods, lack of movement, and laziness to exercise, stress, and lack of rest<sup>21</sup>. In coronary heart disorders, there are variations in the level of atherosclerosis, the degree of myocardial ischemia, impaired heart ventricular function, the frequency and degree of heart symptoms such as dysrhythmias, increased blood pressure and heart rate response to exercise and fatigue<sup>22</sup>. These conditions need to be evaluated to estimate the risk of further infarction, cardiac arrest and heart failure. The clinical judgment regarding the exercise program, type and type of exercise is mainly based on the calculation of the risk (prognosis) and the functional capacity of the patient.

Hemodynamic treatment in AMI patients aims to improve oxygen delivery in the body which is affected by (Cardiac Output/CO), hemoglobin (Hb), and oxygen saturation (SaO<sub>2</sub>). If oxygen delivery is impaired due to decreased cardiac output (CO), proper handling is needed, cardiac output is an important hemodynamic variable and is often assessed by one of which is based on NIBP and on the calculation of MAP (Mean Arterial Pressure), by measuring pressure. Blood and mean arterial pressure (MAP), can indicate conditions of cardiac output. Hemodynamics is divided into 2, namely invasive and non-invasive. Non-invasive hemodynamics consists of indicators as a measure. Two of them are blood pressure and pulse rate. High and persistent blood pressure will cause direct trauma to the walls of the coronary arteries, thereby facilitating coronary atherosclerosis. This causes angina pectoris, coronary insufficiency and myocardial infarction to occur more frequently in people with hypertension than normal people<sup>23</sup>. High blood pressure is a risk factor for AMI. Patients with high blood pressure experience an increase in after load which indirectly increases the workload of the heart. Conditions like this will trigger left ventricular hypertrophy as compensation for increased after load which ultimately increases the heart's oxygen demand. (AMI) can occur repeatedly, this recurrent myocardial infarction is called recurrent acute myocardial infarction because of uncontrolled risk factors or patient non-compliance in undergoing rehabilitation therapy. Patients who have experienced an AMI attack are 50%

likely to experience a recurrent<sup>24</sup>. Recurrent AMI can be prevented by controlling risk factors. Several studies have shown that secondary prevention, including risk factor control and pharmacological treatment, can prevent the incidence of recurrent acute myocardial infarction and reduce mortality and morbidity in patients with coronary heart disease<sup>25</sup>. Secondary prevention by controlling one of them by controlling blood pressure. Secondary prevention is based on clinical evidence and studies using control, large numbers of samples<sup>26-27</sup>.

Current medical treatment for AMI patients is generally carried out with pharmacological therapy and cardiac revascularization<sup>28</sup>. Revascularization measures that have been well proven in patients with AMI caused by atherosclerosis are CABG (Coronary Artery Bypass Graft) surgery and PCI (Percutaneous Coronary Intervention) procedures. AMI patients who have undergone cardiac revascularization will undergo further action, namely cardiac rehabilitation. The rehabilitation program for people with heart problems is a multi-phase program designed to treat heart problems, especially those with coronary artery disorders. In this program, patients are trained to return to life optimally and productively. This program is based on physiological, psychological, social, vocational and recreational knowledge. This program includes exercise therapy, psychological counseling, and behavioral therapy towards a healthy lifestyle. Lifestyle suggestions include quitting smoking, a diet high in fiber, low in fat and stress management.

The rehabilitation program for AMI patients aims to: (1) optimize the physical capacity of the body, (2) provide counseling to patients and families in preventing worsening and (3) help patients to return to physical activities such as before experiencing heart problems<sup>29</sup>. The physical exercise program is based on the patient's level of awareness and individual ground. The important thing to note is that the exercise program should be monitored based on the target pulse frequency. In addition, the rehabilitative physical exercise program for people with heart problems aims to optimize the physical capacity of the body, provide counseling to patients and their families in preventing worsening and helping patients to return to activities' physical as before experiencing heart problems<sup>15</sup>. States those contemporary training programs are directed based on individual needs. In low-risk individuals, an unsupervised exercise program can be carried out immediately, whereas in high-risk patients, a monitored

exercise program can be carried out over a longer time interval. In general, the training program is divided into inpatient and outpatient programs<sup>21</sup>.

Inpatient training program can be carried out from 48 hours after heart trouble as long as there are no contraindications. Physical exercise is limited to daily activities, such as hand and leg movements and changing postures. The exercise program usually takes the form of supervised ambulatory physical therapy. In this phase, ECG monitoring is necessary to assess the response to exercise. Training in this phase must be according to the readiness of the team that can handle an emergency situation if a heart attack occurs during training. The benefits of physical exercise in this phase are as additional surveillance material, train patients to be able to carry out activities in daily activities, and to avoid negative physiological and psychological effects on bedrest. The goals of this first phase of physical exercise must be tailored to the patient's needs. Patients with low activity may only need physical exercise to support daily activities (ADL: activity of daily life). Patients with better physical capacity can run an exercise program for tertiary prevention and follow a long-term program to increase cardiorespiratory endurance, body composition, and flexibility and muscle endurance<sup>30</sup>.

AMI patients need heart rehabilitation, so that they can return to an optimal condition physically, medically, psychologically, socially, emotionally, sexually, and vocally, cardiac rehabilitation is also useful for exercising mobility and heart work and restoring conditions to meet the needs of daily life. . If no cardiac rehabilitation is done, the heart muscles periodically decrease activity, expand ischemia or infarction and trigger repeated attacks, this can lead to death. The physical exercise program is based on the patient's level of awareness and individual needs. The important thing to note is that the exercise program should be monitored based on target pulse frequency, perceived exertion and prediction of METs. If there are symptoms of cardiac, orthopedic or neuromuscular disorders, it is necessary to review the exercise program<sup>31</sup>. Patients with heart disease can return to being productive people in their environment so that a new approach is needed as an additional method that can improve the care for people with "coronary prone", patients after myocardial infarction, and sufferers after coronary bypass surgery. This additional treatment program is known as "Cardiac Rehabilitation". This is of course very much in accordance with the National Health System (SKN) which states that health efforts must

cover promotive, preventive, curative and rehabilitative aspects.

The cardiac rehabilitation program is one of the non-pharmacological management of AMI patients. AMI patients are the main indication that a cardiac rehabilitation program is recommended<sup>32</sup>. Deaner further explained that the cardiac rehabilitation program consists of four phases, namely phase I while the patient is in the hospital, phase II immediately after the patient is discharged from the hospital, phase III immediately after phase II is still under the supervision of the cardiac rehabilitation team, and phase IV is the term maintenance phase long. The rehabilitation program for AMI patients aims to restore the optimal physical, mental, social and vocational conditions.

AMI can indeed cause immobilization and instability of hemodynamics, however, so that patients avoid various complications due to immobilization and hemodynamic instability, it is still necessary to do cardiac rehabilitation where cardiac rehabilitation is done in phase 1 because it is done after the patient does not feel pain. Phase 1 cardiac rehabilitation should be given immediately in order to train the range of motion of the joints, change position exercises (tilt, sit, and stand), muscle strengthening exercises, static balance exercises either sitting or standing. All exercises are carried out in stages, according to the patient's condition. Cardiac rehabilitation in critical patients can increase muscle strength, reduce oxidative stress and inflammation, during activity or exercise will maximize 60% -75% oxygen intake and increase antioxidant production<sup>33</sup>. The cardiac rehabilitation program currently developed by nurses can improve not only physical and cardiac outcomes, but also mental and psychological well-being before discharge from the hospital<sup>34</sup>.

Phase 1 cardiac rehabilitation therapy is very beneficial for AMI patients, however the implementation of cardiac rehabilitation by nurses must be based on the patient's level of awareness and individual needs. In addition, the important thing for nurses to pay attention to is that the cardiac rehabilitation program should be monitored based on blood pressure targets and perceived exertion<sup>35</sup>. This is very necessary to optimize the health status of AMI patients. The results of previous research conducted by<sup>36</sup> proved that the cardiac rehabilitation program, one of which is early mobilization, can reduce heart rate and does not cause changes in blood pressure. Therefore, based on the results of this study,

the use of a cardiac rehabilitation program, namely early mobilization in the care of AMI patients, is highly recommended. The impact if hemodynamics is not monitored carefully during early mobilization will result in deterioration, shock and loss of consciousness. Early mobilization will increase the work of the heart, the body tolerates it quickly. Therefore monitoring is very necessary during early mobilization interventions to prevent worse conditions. Critically ill patients generally have poor vascular elasticity, malfunctioning feedback cycles and/or low cardiovascular reserves. For patients whose hemodynamic status is imbalanced, a solution that can be suggested is to train the patient to tolerate changes in position rather than leaving them in a supine position<sup>37</sup>. Hemodynamic instability is one of the challenges for nurses to mobilize critical patients. To balance the risks and benefits of mobilization in critical patients, nurses must determine the right type of mobilization, pay attention to certain diseases, assess risk factors, determine the time for mobilization sessions, and reduce the speed of mobilization that can affect the cardiovascular system response<sup>37</sup>.

The results showed that there was an effect of phase 1 cardiac rehabilitation on systolic and diastolic blood pressure. Cardiac rehabilitation phase 1 has a significant association with changes in heart muscle function (seen from blood pressure). This can be seen from the paired T-Test where the p-value is 0.026, 0.014 ( $p < 0.05$ ), meaning that there is a significant effect between phase 1 cardiac rehabilitation on blood pressure. This can also be explained by the extent of changes that occurred in patients with AMI before phase 1 cardiac rehabilitation intervention and after being given phase 1 cardiac rehabilitation. According to WHO (2000), the diastolic filling cardiac cycle is determined by the effective filling pressure and resistance in the wall. The ventricular muscles (preload), while the ability of systolic ejection depends on the strength of the contraction of the heart muscles (myocardium) against blood pressure (afterload). Phase 1 cardiac rehabilitation can affect blood pressure due to the efficiency of the work of the heart or the ability of the heart to increase according to the changes that occur. Changes that occur can be in the form of heart rate, stroke volume, and cardiac output. When performing phase 1 cardiac rehabilitation, blood pressure will rise considerably, systolic blood pressure can rise to 150 - 200 mmHg from resting systolic pressure of 110-120 mmHg. Conversely, as soon as the physical exercise is finished, the blood pressure will drop below

normal and lasts for 30 - 120 minutes. Regular phase 1 cardiac rehabilitation can lower blood pressure. The recommended frequency of phase 1 cardiac rehabilitation is 3-5 times a week, with duration of 15-60 minutes of exercise once. Changes in blood pressure, among others, occur because the blood vessels are dilated and relaxed (relaxes the blood vessels) as well as widening a water pipe will reduce water pressure. In this case, exercise can reduce peripheral resistance. Changes in blood pressure can also occur due to reduced pumping activity of the heart. The heart muscle in people who regularly exercise is very strong, so the heart muscle is also strong, 12 weeks of programmed physical exercise is more likely to cause significant changes in the work efficiency of the heart compared to peripheral resistance. The results of this study are supported by research conducted by<sup>38</sup> which states that there is a significant effect on blood pressure with a p-value of 0.001 ( $p < 0.05$ ), other studies that support<sup>39</sup> stated that the cardiac rehabilitation program was effective in encouraging an initial increase in exercise capacity and a significant reduction in resting systolic and diastolic blood pressure ( $p < 0.001$ ) and research that<sup>40</sup> stated that phase 1 cardiac rehabilitation had an effect on hemodynamic status (blood pressure: Systole, diastole)  $p < 0.005$ .

The results showed that there was an effect of phase 1 cardiac rehabilitation on the pulse rate (heart rate). Cardiac rehabilitation phase 1 has a significant association with changes in heart muscle function (seen from and pulse rate). This can be seen from the paired T-Test where the p-value is 0.014 ( $p < 0.05$ ), meaning that there is a significant effect between phase 1 cardiac rehabilitation on pulse frequency. The heart rate is produced by the contraction of the heart muscle as it pumps blood. A normal heart rate has a contraction period of 0.40 from the cardiac cycle. Cardiovascular regulation is seen immediately after exercise. This work also serves to transport the O<sub>2</sub> needed by the muscles to contract during exercise. When the heart is at rest, the pulse will be less. The normal pulse rate is 60-80 beats per minute. O<sub>2</sub> consumption by the heart muscle can be calculated by multiplying the pulse rate and systolic blood pressure. Trained cardiac muscle requires less O<sub>2</sub> for any given load and requires less O<sub>2</sub> for physical work or activity. Cardiac Rehabilitation Phase 1 is a good form of exercise for cardiorespiratory fitness. The increase in pulse rate during activity should be between 70-75% of the maximum pulse rate. Meanwhile, the maximum pulse rate is 220 as an absolute number minus

age. Cardiac rehabilitation in myocardial infarction must be started immediately after the patient is stable and continued for life<sup>41</sup>. Heart rehabilitation phase 1 is highly recommended in influencing and improving the work of the heart<sup>42</sup>. From the above explanation, it can be concluded that the phase of Cardiac Rehabilitation affects the pulse of a patient with AMI, because in principle, every increase in one's activity will be followed by an increase in pulse, because increased activity requires body metabolism. Thus, to meet these metabolic needs, high oxygen is needed as well, this need will be met by increasing the heart rate to pump blood throughout the body that needs it. This study is supported by research conducted by<sup>40</sup> which states that phase 1 cardiac rehabilitation has an effect on hemodynamic status (pulse frequency)  $p < 0.005$ . Another supportive study is<sup>43</sup> which states that a cardiac rehabilitation program can help increase pulse frequency with a value of  $p = 0.040$ . In addition, the results of this study are also supported by the research of<sup>39</sup> stating that after rehabilitation, the case group showed a significant increase in the rehabilitation time of the heart in phase 1 heart rate ( $p < 0.001$ ). There are also studies that have different results from this study, namely research that has been conducted by<sup>38</sup> states that there is a significant effect on blood pressure with a pvalue of 0.001 ( $p < 0.05$ ). Phase 1 cardiac rehabilitation has no significant effect significant changes to the respondent's heart rate.

## Conclusion

Cardiac Rehabilitation Phase 1 has a significant effect on heart muscle function based on the results of blood pressure checks seen from systolic and diastolic and heart rate. Where the greatest significance is on heart rate compared to blood pressure.

**Acknowledgments:** We would like to thank the Ministry of Research and Technology/National Research and Innovation Agency, Deputy for Strengthening Research and Development for the research grant for Beginner Lecturers for Research Implementation in 2020. We also do not forget to thank the respondents and all those involved in it.

**Conflict of Interest:** None to declare

**Source of Funding:** Ministry of Research and Technology/National Research and Innovation Agency Deputy for Research and Development Strengthening for Fiscal Year 2020.

**Ethical Clearance:** Ethical clearance from the Health Research Ethics Commission (KEPK) STIKES Kediri Baptist Hospital. This research has passed ethics with letter number 076/30/III/EC/KEPK-3/STIKES WSBK/2020.

### Reference

- Rubenstein, D., Wayne, D., & Bradley J. Lecture notes kedokteran klinis edisi ke-6. 2017.
- Idris DNT. Pengaruh Rehabilitasi Jantung Fase 1 terhadap tingkat kenyamanan dan kualitas hidup pasien AMI di Ruang IPI Rumah Sakit Baptist Kediri. <http://repository.ums.ac.id>. 2017;
- Patrick J, Scanlon, David P, Faxon, James L, Ritchie et al. (2013). ACC/AHA Guidelines for coronary angiography: A report of the American college of cardiology/American Heart Association Task force on practice guidelines (Committee on coronary angiography). *J Am Coll Cardiol*. 2013;33(6):1756–824.
- Rao, N., S. & Binbrek, A. S. Erythropoietin to augment myocardial salvage induced by coronary thrombolysis in patients with ST segment elevation acute myocardial infarction. *Am J Cardiol*. 2009;104:1035–40.
- Alan S, Mary Ann Bauman, Sallyann M, Gregg C, Willie L, Kim A et al. An Effective Approach to High Blood Pressure Control. A Science Advisory From the American Heart Association, the American College of Cardiology, and the Centers for Disease Control and Prevention. *J Am Coll Cardiol*. 2014;63(12):1230.
- Gosh, Nina. et al. Noninvasive cardiovascular imaging in coronary artery disease. *Imaging Med*. 2010;2(3).
- Sulistiyowati. Pengaruh sudut posisi tidur terhadap kualitas tidur dan status kardiovaskuler pada pasien Infark Miokard Akut (AMI) di ruang ICVCU RSUD Dr. Moewardi Surakarta. 2015.
- Sitorus, M.R.P., Ketaren, I., dan Yanti S. Simplified Clinical Electrocardiogram Score sebagai Faktor Prediktor Mortalitas pada Pasien Infark Miokard Akut di Intensive Cardiac Care Unit (ICCU) RSUD Dr. Soedarso. *J Kedokt Yars*. 2016;24(3):116–74.
- Overbaugh KJ. Acute coronary syndrome. *AJN*. 2009;105(5).
- Price SA WL. Patofisiologi: konsep klinis proses-proses penyakit. 6th ed. Jakarta: Buku Kedokteran EGC; 2005.
- Huang, B. Yang, Y. Zhu, J. Liang, Y. & Tan H. Clinical Characteristic and short-Term Outcomes in Patients with Elevated Admission Systolic Blood Pressure After Acute ST Elevation Myocardial Infarction: A Population-Based Study. *Bmjopen*. 2014;
- RI. D. Pharmaceutical care untuk pasien penyakit jantung koroner : fokus sindrom koroner akut, Jakarta. 2007.
- PERKENI. Pedoman tatalaksana sindrom koroner akut. 2015.
- Al TP et. Pedoman Tatalaksana Sindrom Koroner Akut, Perhimpunan Dokter Spesialis Kardiovaskuler Indonesia. 2010.
- Arovah NI. Program Latihan Fisik Rehabilitatif pada Penderita Penyakit Jantung. 2012.
- Piotrowicz, R., & Wolszakiewicz J. Cardiac rehabilitation following myocardial infarction. *Cardiol J*. 2008;15(5):481–7.
- Lubis AC. Rehabilitasi Jantung Paska Infark Miokard Departemen Kardiologi dan kedokteran vaskular FK USU. 2009.
- Waly, Muhammad, T., Pujo, & Listyanto P. Prevalensi Pasien Infark Miokard Akut yang Menjadi Cardiac Arrest di ICU/HCU RSUP Dr. Kariadi Semarang. *J Stud Fak Kedokt Univ Diponegoro*. 2014;
- Pratiwi F, Inne., Rifqi, S., & Maharani N. Komplikasi pada pasien infark miokard akut ST-elevasi (STEMI) yang mendapat maupun tidak mendapat terapi reperfusi. *J Stud RSUP Dr Kariadi Semarang*. 2011;
- Prasetyo, R.D., Syafri, M. & E. No Title. *J Kesehat Andalas*. 2014;6(4).
- Ades PA. Cardiac rehabilitation and secondary prevention of coronary heart disease *The New England J Med*. 2001(345):12.
- Williams M. A. Exercise testing in cardiac rehabilitation. *Exercise prescription and beyond. Cardiol Clin*. 2001;19(3).
- TB A. Faktor risiko penyakit jantung koroner. 2004.
- LE. WS & R. Secondary prevention strategies for coronary heart disease. *J Thromb Thrombolysis*. 2010;29(8).
- Clark, A.M., Hartling, L., Vandermeer, B., &

- McAlister FA. Meta analysis: secondary prevention programs for patients with coronary artery disease. *Ann Intern Med.* 2005;143(9).
26. Antman et al. ACC/AHA Guidelines for the Management of Patients With ST-Elevation Myocardial Infarction. *Circulation.* 2004;110.
27. Smith F, Gordon K DS. Effective chronic disease management: patients' perspectives on medication-related problems. *Patient Educ Couns.* 2007;65(3).
28. Majid A. Penyakit Jantung Koroner dalam: Patofisiologi, Pencegahan dan Pengobatan Terkini. Medan: FK Universitas Sumatera Utara; 2007.
29. Jolliffe, J. A., K. Rees, R. S. Taylor, D. Thompson N. O and SE. Exercise-based Rehabilitation for Coronary Heart Disease. *Sport Med J.* 2001;
30. Marchionni, N., F. Fattirolo, S. Fumagalli, N. Oldridge, F. Del Lungo, L. Morosi CB and GM. Improved Exercise Tolerance and Quality of Life with Cardiac Rehabilitation of Older Patients after Myocardial Infarction: Results of a Randomised, Controlled Trial. *Circulation.* 2003;107(17).
31. Lavie, C. J. RVM and ABL. No Title Benefits of Cardiac Rehabilitation and Exercise Training in Secondary Coronary Prevention in the Elderly. *Am Coll Cardiol.* 1993;22(3).
32. Deaner SL. Depressive Symptoms And Problem Solving As Predictor of Adherence To The Cardiac Medical Regimen. 1999;
33. Nofiyanto, M. dan Adhinugraha TS. Pengaruh Tindakan Mobilisasi Dini terhadap Denyut Jantung dan Frekuensi Pernapasan pada Pasien Kritis di ICU RSUD Sleman Yogyakarta. *Media Ilmu Kesehat.* 2016;5(3).
34. Rifai, A., Hadisaputro S dan S. Pengaruh Mobilisasi Dini terhadap Perubahan Tanda-tanda Vital pada Pasien Infark Miokard Akut. *LINK.* 2015;11(1).
35. Yenni, E., Nurchayati, S., dan Sabrian F. Pengaruh Pendidikan Kesehatan Latihan Rehabilitasi Jantung terhadap Pengetahuan dan Kemampuan Mobilisasi Dini pada Pasien Congestive Heart Failure (CHF). *J Online Mhs Bid Ilmu Keperawatan.* 2015;2(1).
36. Asgari et al. of Early Mobilization Program on the Heart Rate and Blood Pressure of Patients With Myocardial Infarction Hospitalized at the Coronary Care Unit. *Middle East J Rehabil Heal.* 2015;2(1).
37. KM V. Understanding Critically Ill Patients' Hemodynamic Response to Mobilization: Using The Evidence to Make it Safe and Feasible. *Crit Care Nurs Q.* 2013;36(1).
38. Badriyah D. Rehabilitasi Jantung Post Sindrome Koroner Akut untuk Memperbaiki Hemodinamik dan EKG di Wilayah Taman Sidoarjo. Universitas Muhammadiyah Surabaya. 2013.
39. Shabani, Ramin et al. Effects of cardiac rehabilitation program on physical capacity, blood pressure, heart rate recovery and myocardial oxygen consumption in patients undergoing coronary artery bypass grafting. *Med Sci.* 2011;21(2).
40. Listyaningrum C. Pengaruh Rehabilitasi Jantung Fase 1 Terhadap Perubahan Hemodinamik pada Pasien STEMI di Ruang ICU-CCU RSUD Dr. Soedirman Kebumen. Sekolah Tinggi Ilmu Kesehatan Muhammadiyah Gombong. 2018.
41. Roveny. Rehabilitasi Jantung setelah Infark Miokard. *J Tek.* 2017;44(9).
42. Rahmanti A. Mobilisasi Progresif terhadap perubahan Tekanan Darah Pasien di Intensive Care unit. 2010;
43. Anari et al. Effect of Cardiac Rehabilitation Program on Heart Rate Recovery in Coronary Heart Disease. *J Tehran Univ Hear Cent.* 2015;10(4).



# Awareness among MBBS Students About Rise of Violence Against Doctors

Divya Reddy Pannala<sup>1</sup>, S.M. Krishna Sagar<sup>2</sup>, Hemantha Rao Amara<sup>3</sup>, Harshini Deshapathi<sup>4</sup>

<sup>1</sup>Assistant Professor, Department of Forensic Medicine RVM Institute of Medical Sciences, Siddipet, <sup>2</sup>Assistant Professor, Department of Forensic Medicine, Mahavir Institute of Medical Sciences, Vikarabad, <sup>3</sup>Professor, Department of Forensic Medicine, <sup>4</sup>nd Year UG, RVM Institute of Medical Sciences, Siddipet

## Abstract

World Health Organisation defined workplace violence as incidents where employees are abused, threatened, assaulted or subjected to other offensive behaviour in circumstances related to their work. According to an ongoing study by the Indian Medical Association, over 75% of doctors have faced violence at work, majority of the cases were reported from emergency wards and Intensive Care Units. In the last decade, Governments of 19 states in India have passed laws for the protection of physicians. However, the law is not being effectively implemented either due to lack of awareness or resistance from administration. A questionnaire based study was conducted on MBBS students to assess their level of awareness about violence on doctors and protection laws. The knowledge among the students about these laws was very low, which could be improved if the topic "Violence on Doctors" is included in the new competency based curriculum, separately in Forensic Medicine subject.

**Keywords:** Awareness, violence, MBBS students, protective laws, competency based curriculum, doctors.

## Introduction

According to World Health Organisation, healthcare workers are four times more likely to be injured due to workplace violence than all other workers combined.<sup>1</sup> This problem is mainly due to lack of social awareness, poor infrastructure in many hospitals and increasing expectations even during poor prognostic conditions leading to rise in acts of violence against doctors. Hence, it has become necessary to raise awareness regarding this issue and implement stringent regulatory measures to prevent such kind of violent acts.

In a study conducted by Indian Medical Association, over 75% of doctors across the country have faced at

least some form of violence and in that, 68.33% of the violence was committed by the patient attenders or escorts.<sup>2</sup> But these numbers are underestimated, as most cases of violence are not reported especially in India. In the last decade, Governments of 19 states in India have passed laws for the safeguard of physicians.<sup>3</sup> However, the law is not being effectively implemented either due to lack of awareness or resistance from administration.

To avoid any serious problems due to violence, a doctor must be well trained in dealing with such incidents. The knowledge on national and state protective laws against violence on doctors is important and they must be included as a part of the teaching curriculum at undergraduate level which would help the upcoming doctors to know about their legal rights. Thus, the current study aims to evaluate the level of awareness about rise in violence against doctors and protection laws amongst the MBBS undergraduates.

## Methodology

This was a cross sectional study done over a period of 2 months from 1<sup>st</sup> May to 30<sup>th</sup> June 2020.

---

### Corresponding Author:

**Dr. S.M. Krishna Sagar**

Assistant Professor, Department of Forensic Medicine,  
Mahavir Institute of Medical Sciences

e-mail: krisrocks.37@gmail.com

Mobile Number: 9966780329

Questionnaire (dichotomous and multiple-choice questionnaire) was distributed through online survey (google forms) to students of all medical colleges in the states of Telangana and Andhra Pradesh. Based on the completion of the forms within the given study period,

405 MBBS undergraduate students belonging to three academic years (2<sup>nd</sup>, 3<sup>rd</sup> and 4<sup>th</sup> year MBBS) were a part of this study. The data were analysed in SPSS and expressed as number and percentages and presented in the form of text, tables, and figures.

## Results

**Table 1: Awareness on violence**

Variables		Frequency	%
On rise in incidents	Yes	404	99.8
	No	1	0.2
Components of Violence	All components	315	77.8
	Combination of more than 2 components	70	17.3
	Single Component	13	3.2
	None	2	0.5
Mode of awareness	Media	371	91.6
	Family	2	0.5
	Friends/Colleagues	27	6.7
	Teachers/Professors in College	5	1.2
Most recent incident you have heard of/seen/experienced by yourself	Assaults in Telangana state	377	93
	Assaults in AP state	8	2
	Assaults in other states	10	2.5
	Could not recall	10	2.5

315 (77.8%) students mentioned that physical assault, psychological violence including verbal abuse, telephonic threats and warning gestures, damage to medical equipment and damage to clinical establishment constitute as violence on doctors. 12 (3%) students considered violence as only physical assault, 1 (0.2%)

as only verbal abuse, 5 (1.2%) of them it a combination of physical and verbal abuse. 70 (17.3%) considered it to be a varying combination of the components. 2 (0.5%) participants did not consider any of the components as violence on doctors.

**Table 2: Awareness on laws and punishments protecting doctors**

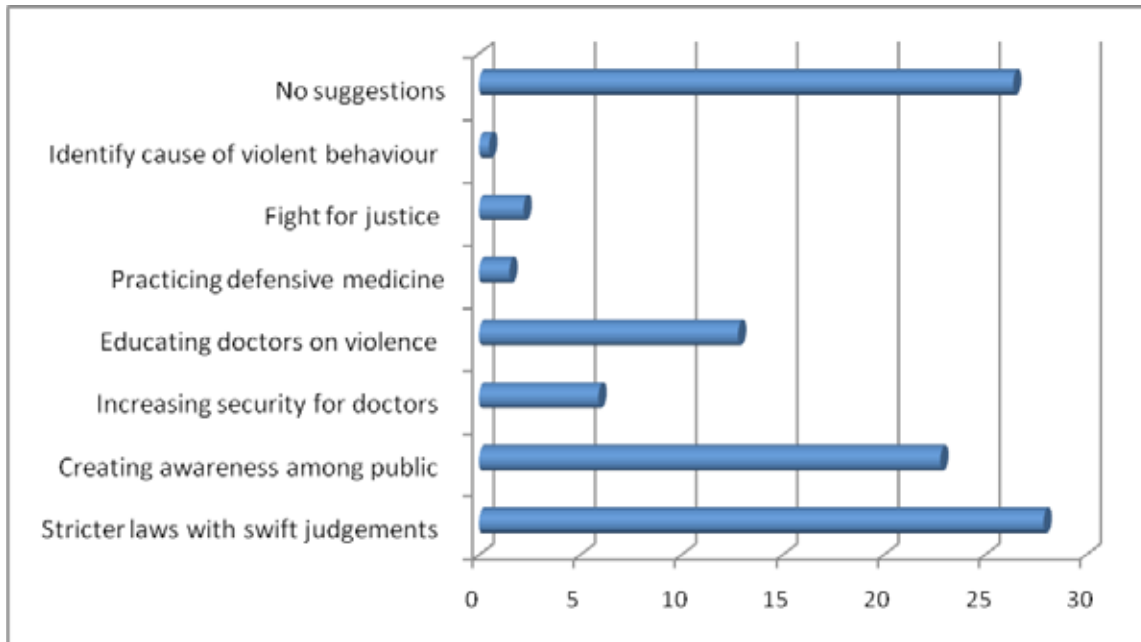
Variables		Frequency	%
Awareness of any National and State Laws protecting doctors	Yes	166	41
	No	239	59
Special judicial Punishments	Yes	188	46.4
	No	217	53.6
If punishments for Hurt or Grievous Hurt (as per IPC) would be applicable for miscreants	Yes	201	49.6
	No	16	4
	Don' Know	188	46.4
If punishments are different for assault on doctors from assault on other health care providers (nurses/paramedical staff)?	Yes	125	30.9
	No	280	69.1

356 (87.9%) of the participants said that the existing laws are not sufficient for protecting doctors whereas 7 (1.7%) of them think they are and 42 (10.4%) do not know the answer to the question posed. 345 (85.2%)

of the students mentioned that punishments should vary based on the type and severity of violence and 60 (14.8%) do not consider so.

**Table 3: Method to increase awareness**

Variables		Frequency	%
Conducting workshops and CME programs	Yes	366	90.4
	No	39	9.6
Participation of student unions for public awareness	Yes	401	99
	No	04	1
Topic inclusion in Forensic Medicine under new Competency Based Curriculum	Yes	393	97
	No	12	3



**Fig 1: Student suggestions regarding violence on doctors in percentages**

**Discussion**

Based on a study conducted by Rajesh et al in 2017, there has been a recent rise in vandalism cases, majority of them were reported between 2014 and 2016.<sup>4</sup> These violent incidents are not exclusive to government hospitals but occurred in private setups too. 99.8% students were aware of the rise in incidence of violence on doctors. 91.6% students had heard about these incidences through media, 6.7% through friends and colleagues and 0.5% through family. Though media is playing a key role in creating awareness about such

incidences, it is known to twist facts for the purpose of sensationalization. Only 1.2% of the participants were made aware through teachers or professors in college about this issue. Teachers in medical colleges should play a major role by conducting live discussions and debates among students so as to identify, prevent and rectify factors leading to this epidemic rise in violence.

Violence on doctors includes physical assault, verbal abuse, warning gestures, telephonic threats and damage to medical equipment/establishment.<sup>5</sup> 77.8% of the students know what constitutes as violence of the

remaining 90 students, 13.3% considered violence as only physical assault and 5.5% opted for combination of physical assault and verbal abuse. 54.8% of students, who chose multiple options, did not consider telephonic threats as part of violence. Also, 14.4% did not consider damage to medical property and 22.2% did not know that warning gestures constitute violence. When asked to mention about a recent incident they have seen, heard of or experienced, 92.1% of the participants mentioned about the physical assault that occurred on a medical resident at Gandhi Hospital, Telangana on 9<sup>th</sup> June 2020. 5.4% of the participants mentioned various other incidents where doctors were attacked in places like Indore, Kolkata, Vijayawada, etc. All of them had mentioned only about cases where doctors were physical assaulted but none wrote about any incidents involving verbal abuse, damage to clinical establishment or other forms of violence.

Protection of Medicare Service Persons (MPA) and Medicare Service Institutions Acts were passed in 19 states in India. This act was passed in Telangana and Andhra Pradesh in 2008. Even so, 59% of the participants were unaware of them and as per the Act, offenders can be imprisoned for up to three years and pay a fine of upto Rs.50,000 or double the cost of damage to Medical equipment/establishment.<sup>6</sup> But, 53.6% of the students were not aware of the punishments. Offenders can be tried under both the Indian Penal Code (S. 319 and 320 IPC) or MPA Act if they have physically assaulted a doctor. 49.6% of the students knew that a case can be filed under sections for causing hurt or grievous hurt as per IPC but, 46.4% were unaware about this. Nurses and Paramedical staff are directly involved in patient care and equally vulnerable to violence. Medicare Protection Act is applicable for doctors as well as other healthcare providers.<sup>6</sup> But, 30.9% of the participants are not aware of it.

87.9% of the participants did not think that the existing laws are sufficient for protection of doctors from violence. As per study conducted by Gohil RK et al in 2018, only 20% of the cases were reported to the police and majority 56.3% of offenders faced no consequences whereas 23.9% were issued a verbal warning.<sup>7</sup> Hence, there is a need for the laws to not only be strengthened but also enforced. Majority of the participants, 85.2% think that every act of violence on doctors should be thoroughly investigated and punished appropriately, including psychological violence. As per study by Kumar M et al, younger doctors with less

work experience were more prone to physical violence.<sup>8</sup> Hence, it would benefit them if workshops and CME programs were conducted on this issue on a regular basis and 90.4% of the participants agreed to this.

Study by Kumar M et al concludes that there should be a written policy in the emergency services about the punishments which should be pasted over the walls and other visible areas in hospital vicinity to educate the people.<sup>8</sup> 99% of the students also believe that raising the awareness among public is important which can be done by student unions through social media and other platforms.. Study by Gohil RK et al stated that majority of the doctors are not trained in the measures that need to be taken when facing workplace violence or procedures followed to approach legal help.<sup>7</sup> Thus, 97% of the participants want this topic to be included in the new Competency Based Curriculum in Forensic Medicine subject as a separate chapter.

An open ended question was added at the end of the study which required students to write-in their suggestions and comments about the issue which were broadly classified. 27.9% of the participants mentioned that the government should strengthen the laws relating to violence on doctors and that swift judgements should be passed against the offenders. 22.8% of them said by raising awareness among the people on this issue, the problem can be curbed. 12.8% stated that awareness among medical fraternity about precautionary measures and various protective laws is important. Other suggestions included increasing security in hospitals and emergency wards, identification and elimination of the underlying causes of violent behaviour, practicing defensive medicine and prioritizing saving themselves over their patients and resorting to strikes demanding justice.

## Conclusion

Violence against doctors in India is a multifactorial problem, which may result from unrealistic expectations from doctors, yellow journalism, poor infrastructure in government hospitals or involvement of local leaders/politicians. In few cases, violent conflicts are inevitable even when proper protocol has been followed by the practitioner or hospital. The existing laws that protect doctors against violence in India are minimal and less stringent, thus resulting in proactive acts of violence due to lenience arising from the current legal scenario. In the current study, it is evident that the level of awareness

among MBBS students about various protective laws against violence is very low, which should be improved. This can be achieved, if the issue “Violence on Doctors” is included in the new competency based curriculum, separately in Forensic Medicine subject. By incorporating this topic into the new curriculum, it will provide a chance to increase the awareness regarding such acts of violence from the undergraduate level itself, equipping them to handle such incidents in a proper manner legally in their future medical practice.

**Ethical clearance:** Taken

**Conflict of Interest:** Nil

**Source of Funding:** Nil

### References

1. Dey S. Over 75% of doctors have faced violence at work, study finds. Times India. 2015;4. Available at: <https://timesofindia.indiatimes.com/india/Over-75-of-doctors-have-faced-violence-at-work-study-finds/articleshow/47143806.cms>.
2. Martino V. Relationship between work stress and workplace violence in the health sector, Workplace violence in the health sector, Geneva. 2003;1-11. Available at: [http://worktrauma.org/health/wv\\_stresspaper.pdf](http://worktrauma.org/health/wv_stresspaper.pdf).
3. Saxena S. The forgotten pandemic – violence against doctors. Times of India Blogs. Published on 12.06.2020. Available at: [timesofindia.indiatimes.com/blogs/un-travesty/the-forgotten-pandemic-violence-against-doctors/](https://timesofindia.indiatimes.com/blogs/un-travesty/the-forgotten-pandemic-violence-against-doctors/)
4. Ranjan R, Meenakshi, Singh M, Pal R, et al. Epidemiology of violence against medical practitioners in a developing country (2006-2017). J Health Res Rev. 2018; 5(3):153-160.
5. Ghosh K. Violence against doctors: A wake-up call. IJMR. 2018; 148 (2):130-3.
6. The Telangana Medicare Service Persons and Medicare Service Institutions (Prevention of Violence And Damage To Property) Act, 2008. Act No. 11. Available at: [indiacode.nic.in/bitstream/123456789/8676/1/act\\_11\\_of\\_2008.pdf](http://indiacode.nic.in/bitstream/123456789/8676/1/act_11_of_2008.pdf).
7. Gohil RK, Singh P, Saxena N, Patel G. Work place violence against resident doctors of a tertiary care hospital in Delhi, India. ISJ 2019; 6(3):975-981.
8. Kumar M, Verma M, Das T, Pardeshi G. A Study of Workplace Violence Experienced by Doctors and Associated Risk Factors in a Tertiary Care Hospital of South Delhi, India. J Clin Diagn Res. 2016; 10(11): LC06–LC10.

# Study of Production and Characterization of Laccase Enzyme from *Klebsiella pneumoniae* K7 Isolate

Doaa Khalid Mezaal<sup>1</sup>, Essam Fadel Al-Jumaili<sup>1</sup>, Ahmed Majeed Al-Shammari<sup>2</sup>

<sup>1</sup>Doctoral Degree Student, Prof., Biotechnology Dept. Genetic Engineering and Biotechnology Institute for Post Graduate Studies/University of Baghdad/Iraq, <sup>2</sup>Assistant Prof., Experimental Therapy Dept. Iraqi Centre for Cancer Medical Genetic Research, Mastansiriyeh University

## Abstract

Sixty four local isolated of *Klebsiella* spp. have been isolated from environment samples (soil and water). These isolates were identified and diagnosis according to phenotype and biochemical tests. These isolates were subjected to primary and secondary screening, to select the isolate with the highest laccase activity. Fifteen isolates chosen from primary screening for screening their enzyme activity in secondary screening. It has been found the *Klebsiella*(K7) has the highest productivity of the enzyme (12 Unit/ml). *Klebsiella*(K7) isolate was diagnosis by Vitak 2 system, it was identified as *K. pneumoniae*. The laccase purified was characterization, the experiments showed that: The molecular weight of laccase was 120KD and the optimum pH for the purified laccase activity was 4.5 and for stability was 6.5. the optimum temperature for enzyme activity was 40°C, the enzyme showed that laccase lost 22, 23 and 20% of its initial activity at 20, 25 and 35°C, respectively.

**Keywords:** *Klebsiella* (K7), laccase enzyme, Enzyme characterization, Enzyme kinetic.

## Introduction

Laccase (EC 1.10.3.2) is one of the important of multicopper oxidases enzymes, these enzymes have the ability to oxidize a wide range of organic, and inorganic compounds, including diphenols, polyphenols, substituted phenols, diamines and aromatic amines, this reaction would reduction of molecular oxygen to water<sup>[1]</sup>. Bacteria are become a featured source of laccase production, the used of bacterial laccase in different applications are growing rapidly, this is due to many reasons such as bacteria are easy to handle, the word in different environmental conditions and the bacterial laccase activity and stability at high temperature and

natural pH<sup>[2]</sup>. *Klebsiella* spp. is one of the interesting laccase source<sup>[3]</sup>. The *Klebsiella* is a genus of Gram-negative, non-motile, facultative anaerobic, rod-shaped (ranging from 0.3 to 1.0 µm in width to 0.6-6.0 µm in length), generally with polysaccharide-based capsule bacteria. Unlike other enzymes of oxidoreductases and peroxidase<sup>[4]</sup>, The bacterial laccases were found to be thermostable and alkaline stable by Sharma *et al.*<sup>[5]</sup>. Laccase activity vary by changing pH, this variation may be due to the reaction caused by the binding of enzyme to substrate, ionization of the substrate, oxygen, or the enzyme itself<sup>[6]</sup>. The most thermostable laccases have been isolated from bacteria; the half-life of *Bacillus subtilis* CotA was 112 min at 80°C<sup>[7]</sup> and that of *Streptomyces lavendulae* laccase was 100 min at 70°C<sup>[8]</sup>. These properties of laccase make it has many applications in industrial, environmental (paper, pulp, textiles and bioremediation) and in medical fields (synthesis complex medical products such as antibiotics and anticancer drugs)<sup>[9]</sup>. The aim of this study is an attempt to screening of laccase producing *Klebsiella*, and select the isolate with the highest enzyme activity and characterization of laccase enzyme.

---

### Correspondence Author:

**Dr. Essam Fadel Al-Jumaili**

Professor, Biotechnology Dept. Genetic Engineering and Biotechnology Institute for Post Graduate Studies/ University of Baghdad/Iraq  
e-mail: professoraljumaily@gmail.com

## Materials and Method

**ABTS plate screen assay:** The isolates showing methyl orange degradation were further screened for enzyme laccase, on this media which prepared by adding 0.2 mM ABTS and 0.1 mM CuSO<sub>4</sub> (after filtering them) in Mineral Salt Agar. Blue green oxidation zone around the bacteria colony indicated the presence of laccase.

**Laccase assay:** Laccase activity was monitored by measuring the maximum absorption of oxidation of ABTS at 25°C as a substrate. The reaction mixture containing 1ml of crude enzyme and 1ml of ABTS (0.2mM). The oxidation of ABTS was determined by measuring the absorbance at 420 nm. The blank mixture containing 1ml of sodium acetate buffer (0.1mM, pH5) and 1ml of ABTS . Laccase activity was calculated as follows:

$$\text{Laccase activity } \left( \frac{\text{U}}{\text{ml}} \right) = \frac{A \times V \times 106}{\epsilon \text{ ABTS} \times t \times v}$$

Where: A: Absorbance at 420nm; V: Total volume of reaction mixture in (ml);  $\epsilon$  : molar extinction coefficient of ABTS =36000M<sup>-1</sup>cm<sup>-1</sup>; t:incubation time (1min) and v: volume of enzyme used in (ml)<sup>[10]</sup>. Protein concentration was assayed by the method of Bradford<sup>[11]</sup>.

**Effect of pH on Enzyme Activity:** The effect of pH on the activity of the laccase was determined at 37°C in 0.05M Tris-HCl buffer (pH 3,3.5,4,4.5,5,5.5, 6) 0.05 M sodium phosphate buffer (pH 6.5,7,7.5,8) and 0.05M Tris-base buffer (pH 8) . The laccase activity was determined at different pH (4-9) by mixing 1ml of ABTS with 1ml of purified enzyme and the activity was measured with different buffers.

**Effect of pH on Enzyme Stability:** The effect of pH on laccase stability was examined by adding 1ml of enzyme of to a test tubes containing buffer at different pH (3, 3.5, 4,4.5, 5,5.5,6, 6.5,7,7.5,8), and incubated 30min at 37°C in a water bath, then added the ABTS to mixer and measured the activity with different buffers.

**Effect of Temperature on Enzyme Activity:** The temperature profile of the purified enzyme was studied by measuring the activity at different temperatures (25,30, 35, 40, 45, 50, 55, 60) °C . The purified laccase solution was incubated with ABTS in different temperatures for 10 min and the activity was determined.

**Effect of Temperature on Enzyme Stability:** The purified laccase was incubated at different temperature

ranged between (25,30, 35, 40, 45, 50, 55, 60, 65,70)°C . followed by incubation in ice bathfor 30min. The enzyme activity was assayed using ABTS, and the relation between remaining activity (%) toward temperature was plotted to determine the optimum temperature of laccase stability.

**Laccase Kinetics :K<sub>m</sub>, V<sub>max</sub> values determination:** Pre-steady state kinetic analysis was performed using ABTS at different concentration (0.1, 0.15, 0.2, 0.25,0.3mM) in 0.1mM of sodium acetate buffer at pH 5 and estimate the enzyme activity, then the initial velocity (V<sub>o</sub>) value was estimated. The relationship between [1/V<sub>o</sub>] versus [1/S<sub>o</sub>] was plotted to determine the K<sub>m</sub> and V<sub>max</sub> values according to Lineweaver-Burk reciprocal plot.

## Results and Discussion

**Screening of *Klebsiella pneumoniae* Isolates for Laccase Production:** Out of sixty four *Klebsiella pneumoniae* isolates, there were thirty isolates showed a clear zone around the colony on methyl orange plate, these isolate further screened for enzyme laccase on ABTs plate, it found that twenty one give a positive results . The activity of the enzyme of the fifteen isolates of *K. pneumoniae*, that have ability to produce laccase, was measured to select the highest isolation activity for choose the isolate that have the highest activity (Table 1). The laccase activity was monitored by measuring the maximum absorption of oxidation of ABTS as a substrate.

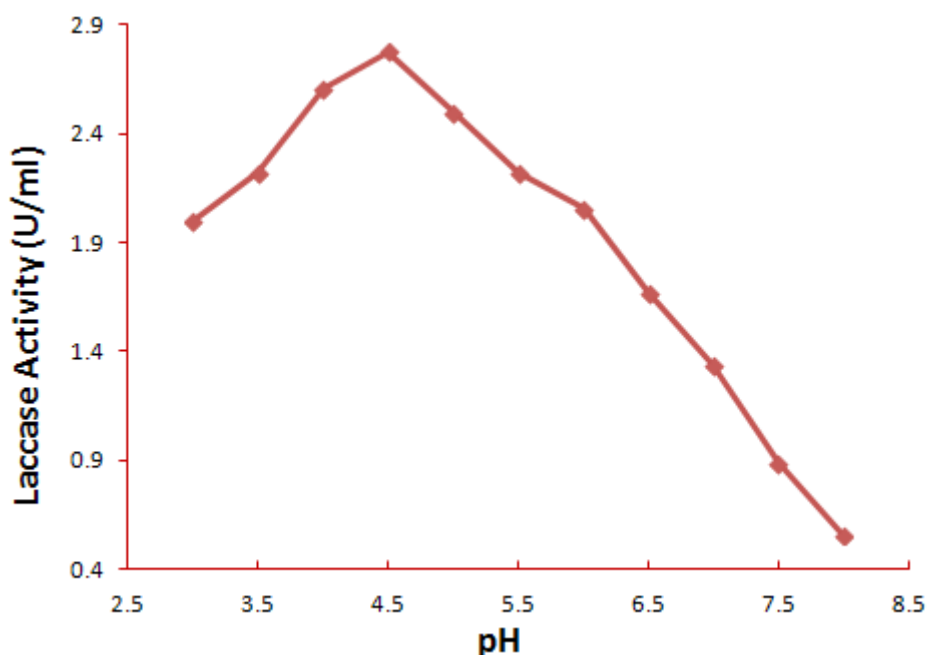
**Table (1) : Screening the *Klebsiella pneumoniae* producing Laccase enzyme.**

<i>Klebsiella pneumoniae</i> Isolates	Enzyme activity (Unit/ml)
K1	8.23
K2	7.60
K3	10.23
K4	10.06
K5	9.37
K6	6.57
K7	12
K8	6.78
K9	7.83
K10	9.54
K11	6.97
K12	7.94
K15	7.21

**Molecular Weight Determination:** The molecular weight of purified laccase was determined by Gel filtration chromatograph, which depending on the size of the separated molecules with their charge<sup>[12]</sup>, using Sephacryl S-200. The results in Figure (2) shows the relationship between logarithm of molecular weight and  $(V_e/V_o)$  of four different standard proteins in gel filtration column include Catalase (232KD), Arginine Deaminase (125.892KD), Bovine Serum albumin (67KD) and Pepsin (34.5KD), these proteins and laccase were eluted individually. The results in indicated that laccase has a molecular weight of (120KD). The molecular weight of laccase was determined which that purified from *c-Proteobacterium* JBBY using ABTS as substrate<sup>[13]</sup>. Also, Siroosiet *al.*<sup>[14]</sup> estimated

molecular weight of laccase from *Bacillus* sp. WT to be 180KD and Verma and Shirkot<sup>[15]</sup> purified laccase from *Geobacillus thermocatenulatus* MS5 with molecular weight 42.5KD. By using another different substrates of laccase the molecular weight was estimated.

**Effect of pH on Enzyme Activity:** The optimum pH for laccase activity was determined with ABTS as substrate in a pH range of (3-7). As results in Figure (1), it was found that the best pH of laccase activity in ranged between (4,4.5 and 5), with a maximum and sharp decline in enzyme activity at pH 4.5 with enzyme activity (2.8 U/ml). While, observed that enzyme activity was reduced at nearly acidic pH (3,3.5) and at alkaline pH (5.5-7).



**Figure (1): Effect of different pH on Laccase activity.**

Verma and Shirkot<sup>[15]</sup>, and Liu *et al.*<sup>[16]</sup> were purified laccase from *Pseudomonas aeruginosa*, *Ochrobactrum* sp.531 and *Thermophilus* SG0.5JP17-16, receptivity by using ABTS as a substrate, found that the optimum pH of laccase activity was at 4.5. The optimum pH on laccase activity was at 4.5, which purified from *Trametes versicolor*.<sup>[17]</sup>

Compared to phenolic substrates, the redox potential of ABTS does not depend on the pH, oxidation does not involve the protons. So, the effect of pH on the laccase activity towards the different substrates could be related

to the balance between the two opposing effects, first the redox potential difference between the substrates and type 1 copper site and second binding of hydroxide anion ( $\text{OH}^-$ ) to the type 2/type 3 copper site<sup>[18]</sup>.

**Effect of pH on Enzyme Stability:** Figure (2) shown that the optimum pH of laccase stability ranged between 6-7 and the a maximum stability was at pH 6.5, where the enzyme retained 100% of its activity. While, retained 94.42% of its activity at pH 6 and about 94.42% and 82.03% at pH 7.



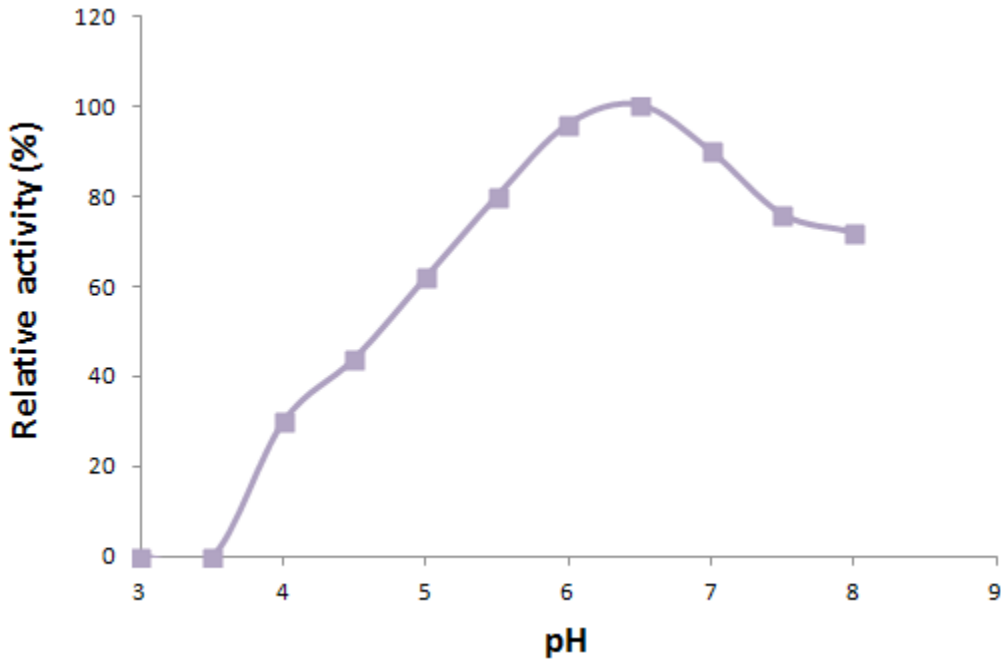


Figure (2): Effect of different pH on Laccase stability

The reason for decreasing in enzyme stability at acidic pH is due to the effect of acidic environment in enzymatic structure which cause ionizing groups in active site. The declining in enzyme activity at pH above the optimum pH may be due to irreversible denaturation of enzyme molecule that leads to change in enzyme structure associated with the formation of enzyme dimerization that leads to enzyme autolysis<sup>[19]</sup>.

**Effect of Temperature on Enzyme Activity:**  
 The temperature profile of the laccase was studied by measuring the activity in a range of 25–60°C with 5°C interval. The results in Figure (3) showed an increase in laccase activity towards 40°C with an activity of 3.17 U/ml. After 40°C the activity decrease and the minimum activity was recorded at 60°C which was 2.5 U/ml.

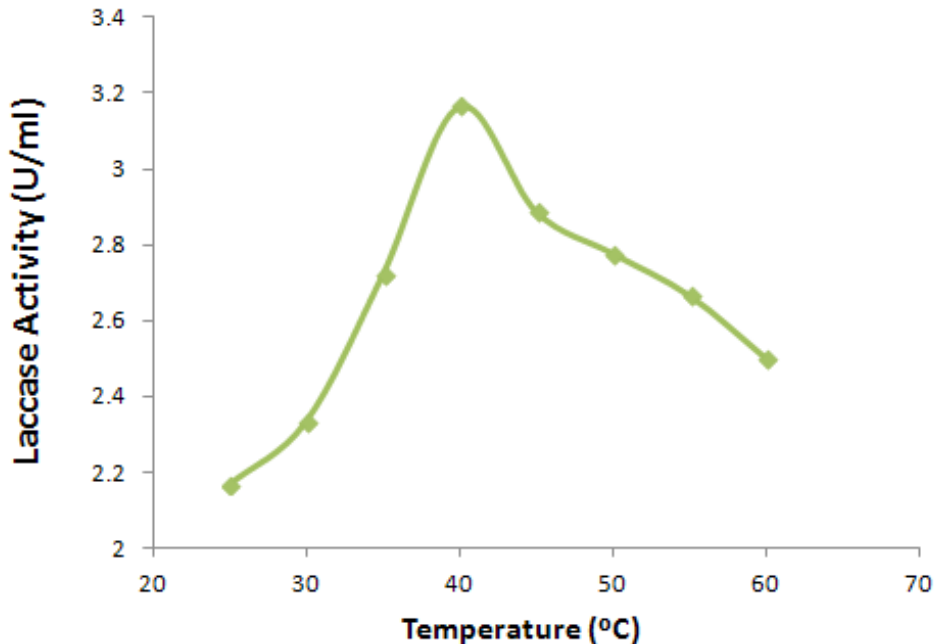


Figure (3): Effect of different temperatures on Laccase activity.

Siroosiet *al.*<sup>[20]</sup> determined the optimal temperature of laccase activity at 37 °C, which purified from *Bacillus sp. WT*, *Pseudomonas aeruginosa* and *Rhodococcus sp.*, respectively. Demissie and Kumar<sup>[21]</sup> found the optimal temperature, that purified from *Streptomyces sp.* was at 35 °C. While, temperature was 35 °C of laccase from *Pseudomonas luridastrain LR5.1* determined by Dhiman and Shirkot<sup>[22]</sup>. The reason for decreasing of an enzyme activity towards higher temperature is that the speed of enzyme interaction increase with increasing temperature within a certain range due to increased energy kinetics

and the collisions between enzyme molecules and substrate, except that the high temperatures within certain limits lead to denaturation of the enzyme and loss of three dimensional structure and then decline in enzyme activity.<sup>[23]</sup>

#### Effect of Temperature on Enzyme Stability:

The thermostability of laccase was determined at temperatures ranging from 25 to 60°C . The results in Figure (4) showed that laccase lost 22, 23 and 20% of its initial activity at 20, 25 and 35°C, respectively.

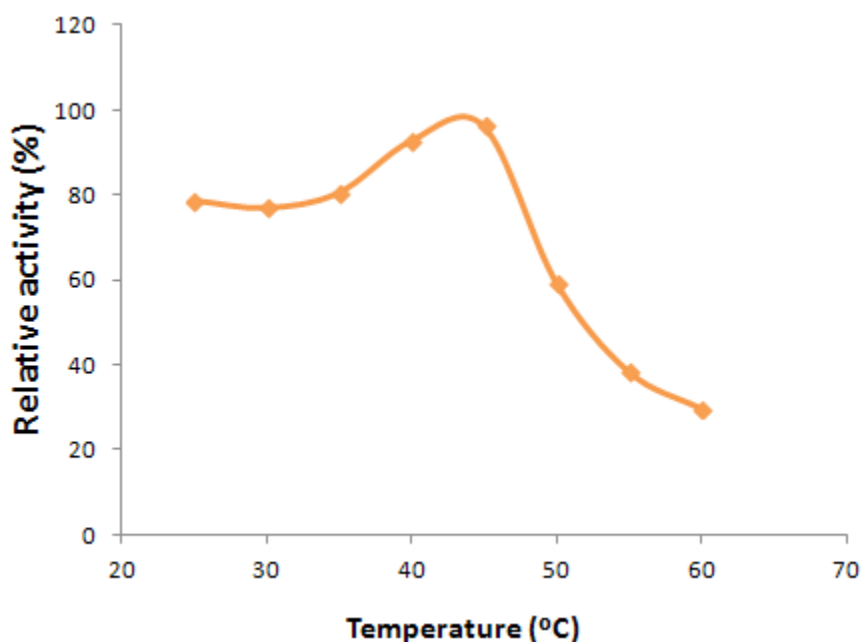


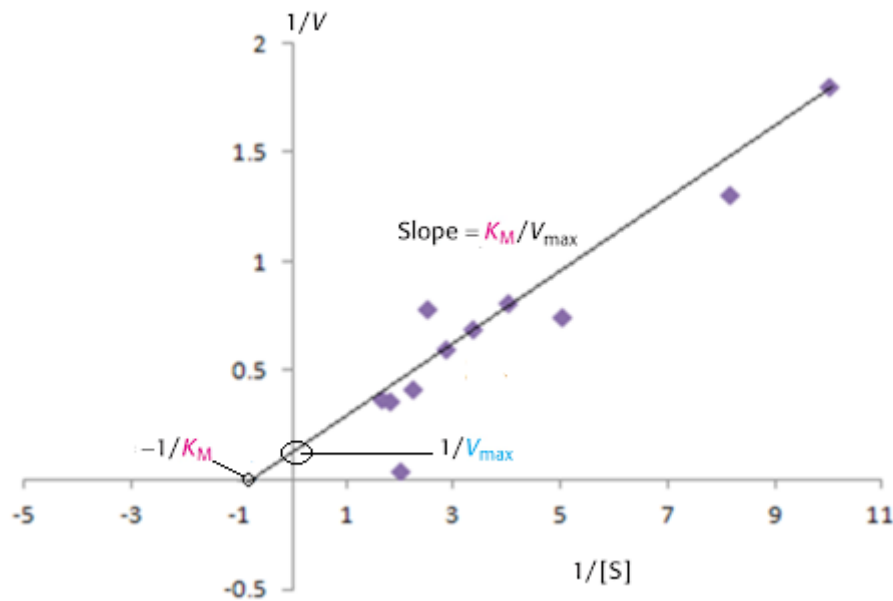
Figure (4): Effect of different temperatures on Laccase stability.

Most cold-adapted enzymes exhibit poor thermal stability at temperatures above 40°C, and their activity decreases as temperature increases.<sup>[24]</sup>

The reduction of activity above 40°C is due to sensitivity to high temperature, reflecting the effect of temperature on the three dimensional structure of protein by damaging R-groups of amino acids which lead to denaturation of protein and losing its activity. In

general, laccases are stable at 30-50°C and rapidly lose activity at temperatures above 60°C<sup>[25]</sup>.

**Determination Km, Vmax Values:** As shown in Figure (5) relation between substrate concentration ABTS and enzyme activity. Activity was measured at different ABTS concentrations (0.1, 0.15, 0.2, 0.25 and 0.3mM) in 0.1mM of sodium acetate buffer at pH 5.



**Figure (5): Lineweaver-Burk double reciprocal plot of (1/Vo) versus the [So] for the purified laccase.**

Singhal *et al.*<sup>[34]</sup> characterized laccase enzyme activity produced by *Cryptococcus albidus*, ABTS was used as a substrate. By Michaelis–Menten kinetics the  $K_m$  was 0.8158 mM and  $V_{max}$  was 1527.74 U/mg. The  $K_m$  of laccase purified *Bacillus subtilis*CotA by Martins *et al.*<sup>[7]</sup> was 0.106mM. Laccase purified from *K. pneumoniae* by using ABTS as substrate. The  $K_m$  values were 0.467, 3.97 and 0.38mM for NITW715076, NITW715076\_1 and NITW715076\_2 *K. pneumoniae* strains, respectively<sup>[26]</sup>.

### Conclusion

*K. pneumoniae* have been proved to its ability to produce laccase. And The molecular weight of laccase was determined at 120KD. The optimum pH of enzyme activity and stability is 4.5 and 6.5, receptivity. The optimum temperature for laccase activity is 40°C while for stability is (20- 35°C).

**Conflict of Interest:** The author knows of no financial interest or any conflict of interest relative to this article.

**Funding:** Self

**Ethical Clearance:** Not required

### References

1. Ghodake, GS, Yang, J, Shinde, SS, Mistry, BM, Kim, DY and Sung, JS, et al. Paper waste extracted  $\alpha$ -cellulose fibers super-magnetized and chitosan functionalized for covalent laccase immobilization. *Bioresource Technology*, 2018; 261:420–427.
2. Guan, ZB, Shui, Y, Song, CM., Zhang, N, Cai, YJ. and Liao, XR. Efficient secretory production of CotA-laccase and its application in the decolorization and detoxification of industrial textile wastewater. *Environmental Science and Pollution Research*, 2015; 22:9515–9523.
3. Guan, ZB, Liao, Q, Wang, HR, Chen, Y and Liao, XR. Bacterial laccases: promising biological green tools for industrial applications. *Cellular and Molecular Life Sciences*;2018; 75:3569–92.
4. Brisse, S, Issenhuth-Jeanjean, S and Grimont, P. Molecular serotyping of Klebsiella species isolates by restriction of the amplified capsular antigen gene cluster. *Journal of Clinical Microbiology*, 2004; 42: 3388-3398.
5. Sharma, P, Goel, R and Capalsh, N. Bacterial laccase, *World Journal of Microbiology and Biotechnology*, 2007; 23: 823-832
6. Clive, D. A guide to protein Isolation. Kluwer Academic Publisher. New York, USA 2002, 1-186.
7. Martins, LO. Soares, CM; Pereira, MM, Teixeira MT, Costa, GH and Henriques, AO. Molecular and biochemical characterization of a highly stable bacterial laccase that occurs as a structural component of the *Bacillus subtilis* endospore coat.

- Journal of Biological Chemistry,2002; 277: 18849-18859.
8. Suzuki, T, Endo, K, Ito, M, Tsujibo, H, Miyamoto, K. and Inamori, YA, Thermostable laccase from *Streptomyces lavendulae* REN-7: purification, characterization, nucleotide sequence and expression. *Bioscience, Biotechnology, and Biochemistry*, 2003; 67:2167–2175.
  9. Shi, X, Liu, Q, Ma, J, Liao, H, Xiong, X, Zheng, K, Wang, T, Liu, X, Xu, T, Yuan, S, Zhang, X and Zhu, Y. An acid-stable bacterial laccase identified from the endophyte *Pantoea ananatis* Sd-1 genome exhibiting lignin degradation and dye decolorization abilities, *Biotechnol Lett*,2015; 37:2279–2288.
  10. Liu, L, Lin, Z, Zheng, T, Lin, L, Zheng, C. and Lin, Z. Fermentation optimization and characterization of the laccase from *Pleurotus ostreatus* strain 10969. *Enzyme and Microbial Technology*,2009; 44: 426–433.
  11. Bradford, MM. A rapid and sensitive method for the quantitation of microorganism's protein utilizing the principle of protein-dye binding. *Analytical Biochem*, 1976, 72: 248-254.
  12. Segel, IH. *Biochemical calculations*, John Wiley and sons. New York. 2nd edition. 1976; pp34.
  13. Singh, G, Ahuja, N, Batish, M, Capalash, N. and Sharma, P. Biobleaching of wheat straw-rich-soda pulp with alkalophilic laccase from  $\gamma$ -proteobacterium JB: Optimization of process parameters using Response Surface Methodology. *BioResources Technology*, 2008; 99, 7472–7479.
  14. Siroosi, M, Amoozegar, MA and Khajeh, K. Purification and characterization of an alkaline chloride-tolerant laccase from a halotolerant bacterium, *Bacillus* sp. strain WT. *Journal of Molecular Catalysis B: Enzymatic*, 2016; 134:89–97.
  15. Verma, A and Shirkot, P. Purification and characterization of thermostable laccase from thermophilic *Geobacillus thermocatenulatus* MS5 and its applications in removal of textile dyes *Sch Acad. Journal of Biosciences*, 2014; 2:479–485.
  16. Liu, Q, Luo, L, Wang, X, Shen, Z and Zheng, L. Comprehensive analysis of rice laccase gene (OsLAC) family and ectopic expression of OsLAC10 enhances tolerance to copper stress in *Arabidopsis*. *International Journal of Molecular Sciences*,2017; 18:209.
  17. Litwińska, K, Bischof, F, Matthes, F, Bode, R, Rutten, T and Kunze G. Characterization of recombinant laccase from *Trametes versicolor* synthesized by *Arxula adenivorans* and its application in the degradation of pharmaceuticals. *AMB Express*, 2019; 9:102.
  18. Xu, F. Effects of redox potential and hydroxide inhibition on the pH activity profile of fungal laccases. *Journal of Biological Chemistry*, 1997; 272: 924-928.
  19. Abdulah AR. The use of partially purified laccase produced by some fungal isolates in Aflatoxin B1 degradation. M.Sc. Thesis in Biotechnology, University of Baghdad College of Science Department of Biotechnology. 2008.
  20. Siroosi, M, Amoozegar, MA and Khajeh, K. Purification and characterization of an alkaline chloride-tolerant laccase from a halotolerant bacterium, *Bacillus* sp. strain WT. *Journal of Molecular Catalysis B: Enzymatic*, 2016; 134:89–97.
  21. Demissie, AG and Kumar, A Isolation of novel bacteria isolate from soil for production of extra-cellular laccase enzyme. *International Journal of Emerging Technology and Advanced Engineering*,2014; 4:404–407.
  22. Dhiman, K and Shirkot, P. Bioprospecting and molecular characterization of laccase producing bacteria from paper mills of Himachal Pradesh. *Proceedings of the National Academy of Sciences, India, Section B*,2015; 85:1095–1103.
  23. Ke, MM, Ramesh, B, Hang, YA and Liu, ZD. Engineering and characterization of a novel low temperature active and thermo stable esterase from marine *Enterobacter cloacae*. *International Journal of Biological Macromolecules*,2018; 118, 304–310.
  24. Xu, F. Effects of redox potential and hydroxide inhibition on the pH activity profile of fungal laccases. *Journal of Biological Chemistry*. 1997; 272: 924-928.
  25. Singhal, A, Choudhary, G and Thakur, I. Characterization of laccase activity produced by *Cryptococcus albidus*. *Preparative Biochemistry and Biotechnology*,2012; 42(2).
  26. Gaur, N, Narasimhulu, K and Setty, YP. Extraction of ligninolytic enzymes from novel *Klebsiella pneumoniae* strains and its application in wastewater treatment. *Applied Water Science*,2018; Vol.8.

# Transformation of the Social Insurance Management Agency on Health

Endang Sulistyarningsih<sup>1</sup>, Hartiwiningsih<sup>2</sup>, Is Haryanto<sup>2</sup>

<sup>1</sup>Doctoral Student at Legal Studies, Sebelas Maret University, Surakarta, Indonesia,

<sup>2</sup>Lecturer at Sebelas Maret University, Surakarta, Indonesia

## Abstract

Health insurance is a type of insurance product that specifically guarantees the cost of health or care of the insurance members if they are sick or have an accident. Implementation of social security is a state obligation mandated by the 1945 Constitution. The issuance of the Social Insurance Management Agency (BPJS) act as the implementer of the National Social Security System act (SJSN) resulted in PT Askes transforming into Social Insurance Management Agency on Health (BPJS Kesehatan). The National Social Security System is organized on the basis of humanitarian principles, principles of benefit, and the principle of social justice for all Indonesians. The National Social Security System aims to provide and guarantees the fulfillment of a decent life base for each participant and/or his family member. The National Social Security System is organized on the basis of such principles: mutual cooperation, non-profit, disclosure, prudence, accountability, portability, mandatory membership, trust fund, and the social security fund will be used entirely for program development and for the interest of participants. Although the preparation and implementation of the National Social Security System is quite well, but in reality there are still various impacts and problems encountered in the operation of BPJS Kesehatan such as lack of socialization, service facilities, inappropriate data, and personnel who are still lacking in giving a good services and information.

**Keywords:** Health insurance, legal analysis, transformation, BPJS Kesehatan.

## Introduction

Health insurance is a type of insurance product that specifically guarantees the cost of health or care of the insurance members if they are sick or have an accident. Health insurance is a type of insurance product that specifically guarantees the cost of health or care of insurance members if they fall ill or have an accident. Health insurance products are usually provided by social insurance companies, life insurance companies, and general insurance companies. In Indonesia, PT Askes Indonesia is one of the social insurance companies that

organize health insurance for its members in need both for civil servants and non-civil servants. Their children will also be financed until the age of 21st. It also applies to pensioners.

PT Askes (Persero) is a State-Owned Enterprise specially assigned by the government to provide health care insurance for Government Civil Servants, TNI (Indonesian National Army), POLRI (Indonesian National Police), pensioners, veterans, families of the pioneers of Indonesian independence and other Business Entities. Health Insurance Program (ASKES) which is organized under Government Regulation No. 69 of 1991 is mandatory for civil servants/recipients of pensions/pioneers of independence/veterans and members of their families.

Over the last few decades, Indonesia has implemented several social security programs. The law that specifically regulates social security for private

---

### Corresponding Author:

Endang Sulistyarningsih

Sebelas Maret University, Jl. Ir. Sutami No. 36, Jebres, Surakarta, Central Java 57126, Indonesia

workers is Law No. 3 of 1992 on Social Security of Workers (JAMSOSTEK) which includes health care insurance program, accident insurance, old-age insurance and death insurance. For Civil Servants (PNS), there are savings fund program and Insurance of Civil Servants (TASPEN) which were established under Government Regulation No. 26 of 1981. Besides that, there is also Health Insurance Program (ASKES) which is based on Government Regulation No. 69 of 1991.

For Indonesian National Army (TNI), members of the Indonesian National Police (POLRI), civil servants of the Department of Defense/TNI/POLRI and their families, the Indonesian Armed Forces Social Insurance (ASABRI) program has been implemented in accordance with Government Regulation No. 67 of 1991 which is a change from Government Regulation No. 44 Year 1971.

Programs mentioned above cover only a small percentage of Indonesian, while the majority of them have not received adequate protection. In addition, the implementation of various social security programs has not been able to provide fair and sufficient protection to the participants in accordance with the benefits of the program which are the rights of participants. In relation to the above, it is deemed necessary to develop a social security system capable of synchronizing the various forms of social security implemented by some organizers in order to reach wider membership and provide greater benefits for each participant.

Act 4 of the BPJS Law (No. 24 of 2011) contains BPJS principles such as mutual cooperation, non-profit, disclosure, prudence, accountability, portability, mandatory membership, trust fund, and the social security fund will be used entirely for program development and for the interest of participants.

The non-profit principle in BPJS is different from the goal of the establishment of state-owned enterprises, which is to pursue profits to improve the company. The principles set forth in the BPJS law will change many things in the implementation of social security in Indonesia. The preparation period of the transformation from PT ASKES (Persero) to BPJS Kesehatan was starting from November 25, 2011 to January 1, 2013. It has started on January 1, 2014 and also explained the purpose of the transformation is to make it easier and improve health insurance services to the public. One of the principles of BPJS Health is the principle of mutual cooperation which means to help each other so that the

social security system is in accordance with the basic philosophy of 5th principle of Pancasila (Social Justice for all Indonesian people). The focus of this paper will discuss the implementation of Article 57 of the BPJS Law concerning the transformation of PT ASKES (Persero) into the BPJS Kesehatan and the juridical implications of its' transformation.

**Utilitarianism, Theory of Law and Social Change:** The theory of utilitarianism was conceived to state that the law is made to benefit the society and the law should be based on benefits for human happiness.<sup>1,2</sup> So, this understanding assesses whether it is good or not in terms of usefulness or benefits that it comes. The basic principle of utilitarianism is a moral act or regulation that can support the happiness of all concerned so that it can benefit all citizens.

The development of material law and procedural law follow certain stages, ranging from simple form to the most advanced stage in which law is organized systematically.<sup>3</sup> He states that the changes of the law are in accordance with the changes that occur in the social system of society that supports the legal system.

The law is said to be a tool for changing society, as it is known that the law was born by man and to guarantee the interests and rights of man himself. From this man the color of law and its application will determine what he will experience in the association of his life.<sup>4</sup> Law is a tool to change society. It means that the law is used as a tool by the agent of change or a pioneer of change (a person or group of people who gain the trust of the community as the leader of the community institutions). A planned social change is always under control of the pioneer of the change. Therefore, if the government wants to establish bodies that have function to change society, then the law is required to establish the body to determine and limit its power.<sup>5</sup>

**Health Insurance Management on National Constitution:** Pancasila and the 1945 Constitution mandated that the state has a responsibility to protect the entire Indonesian and promote the general welfare in the context of realizing social justice for all Indonesian people. It is to realize a decent and dignified life and to fulfill the right to the basic needs of the citizens for the achievement of social welfare, the State organizes the service and development of social welfare in a planned, directed and sustainable manner. State and social security are components that integrate with social protection

systems. National social security systems include health insurance, life insurance, accident insurance and pension benefits financed by employer contributions and employee contributions. The National Social Security System (SJSN) is a lifelong social program that forms a social protection system composed of parts of the approach system in the provision of social security and as an effort to create jobs by the government and empowerment of the marginal community to become a prosperous self-reliant community.<sup>6</sup> The National Social Security System which is based on Law No. 40 of 2004 (about the National Social Security System/SJSN) is a state program for a lifetime that must be held by a public legal entity with permanent legal force. To answer the problem of juridical study of the transformation of PT Askes (Persero) into BPJS Kesehatan, the writer uses Utilitarianisme Theory and Social Change Theory.

**Implementation of Article 57 BPJS Law on Transformation of PT Askes (Persero) into BPJS Kesehatan:** The definition of policy implementation according to Van Metten and Van Horn is acts committed by individuals, officials, government, or private groups directed to achieve the objectives outlined in policy decisions.<sup>7</sup>

As it is known that PT Askes (Persero) is a State-Owned Enterprise (BUMN) that organizes a social security program, its capital is partly or wholly owned by the government. There are 3 kinds of BUMN. First, Perjan is a BUMN whose capital is owned by the government. Perjan is service-oriented towards the community. Second, Perum is a Business Entity managed by State whose purpose is to gain profit and provide services to the public. Third, Persero is one of the Business Entities managed by State or Region. Unlike Perum or Perjan, the main purpose of establishing a Persero is to seek profit (commercial).

At the beginning, the form of business entity of PT Askes (Persero) was in the form of a public company (Perum) under the name of Perum Husada Bhakti and based on Government Regulation No. 6 of 1992, the status of Perum was changed to a company (PT) and then on January 1, 2014 PT Askes (Persero) changed its name to BPJS Kesehatan based on Law Number 24 of 2011 on BPJS.

Characteristics of BPJS Kesehatan that different from other BUMNs is to pursue profit in order to increase the value of the company. BPJS Kesehatan is oriented

to serve community. It has a non-profit principle, the management of trust funds by BPJS Kesehatan is not for profit (for profit oriented) but to meet the maximum interests of participants. Funds collected from participating are trust funds which is managed for the welfare of the participants. So the results of its development will be utilized as much as possible for the benefit of participants.

As a private legal entity, a Persero Company is not established by a state authority with a law but established by an individual, as any other public company should be registered with a Notary and authorized by the Ministry of Justice and Human Rights.

In contrast, the establishment of the Social Insurance Management Agency (BPJS) by state authorities is established under National Social Security System Act and Social Insurance Management Agency Act. The establishment of BPJS is not registered with a notary public and does not require the authorization of a government agency.

The main obstacle encountered by BUMN Persero is the ineffectiveness of social security law enforcement because there is no authority to regulate, supervise or impose sanctions on participants. On the contrary, the BPJS as a public legal entity has the power and authority to govern the public through the authority to make public binding regulations. As a public legal entity, BPJS is obligated to convey responsibility for the performance of its duties to the President. BPJS deliver its performance in the form of annual program management and financial report audited by a public accountant to the President with carbon copy to the National Social Security Board, no later than June 30th of the following year.

In 2004 the government established and enacted Law Number 40 of 2004 on National Security System as the implementation of Article 5 paragraph (1) and Article 52 of the National Social Security System Law after the Constitutional Court's decision No. 007/PUU-III/2005 dated 25 November 2011 and enacted Law Number 24/2011 on the Social Insurance Management Agency. BPJS Kesehatan starts to operate on January 1st, 2014 and PT Askes (Persero) was closed without liquidation. At the same time, the Minister of BUMN through the General Meeting of Shareholders approved the report on closing financial position of PT Askes (Persero) after the audit at the public accounting firm and the Minister of Finance authorized the opening financial position of

BPJS Kesehatan and the opening social security fund report. For the first time, the Board of Commissioners and the Board of Directors of PT Askes (Persero) was appointed as BPJS Kesehatan Supervisory Board for a maximum period of 2 years since BPJS Kesehatan started to operate.

The final change from the transformation processes of BPJS is the change of organizational culture.<sup>6</sup> In Article 40 paragraph (2) of BPJS Law, it requires BPJS to separate the assets of BPJS and the assets of the Social Security Fund. Article 40 paragraph (3) of the BPJS Law affirms that the assets of the Social Security Fund are not an asset of BPJS. This assertion ensures that the Social Security Fund is a trust fund of all participants and not the assets of BPJS.

Furthermore, in Article 4 of BPJS Law, it regulates BPJS principles: principles of mutual cooperation, non-profit principles, principles of openness, prudential principles, accountability principles, portability principles, compulsory membership principles and trust fund principles.

**Juridical Implications of the Transformation of PT Askes (Persero) into BPJS Kesehatan:** The legal basis for the transformation of PT Askes (Persero) into BPJS includes Law Number 40 of 2004 regarding National Social Security System and Law Number 24 of 2011 on BPJS. Furthermore, some Government Regulations (PP) and Presidential Regulations (Perpres) also regulate the implementation of BPJS Kesehatan. From the various legal basis underlying the transformation of PT Askes (Persero) into BPJS whether it is based on the Law, Government Regulation, or Presidential Regulation, there are various impacts or consequences of it. For the company, the impact is that the company must register its employees to BPJS Kesehatan. Furthermore, company are required to allocate funds to pay contributions to BPJS Kesehatan. For society, the impact is that membership is mandatory and participants must pay the contribution.

Factors that impede the implementation of the National Health Insurance currently encountered by BPJS Kesehatan are some, including (1) lack of socialization; (2) inadequate number of health service facilities and uneven distribution, especially for remote areas, borders and islands with low service levels due to geographical conditions and poor health facilities in the area; (3) lack of treatment room facilities resulting

in many patients experiencing delay in handling because they have to wait for an empty treatment room to be served (especially at government hospitals); (4) the number of health personnel is less than the required amount; (5) the problem will arise in the contribution participants (PBI) because the data is not in accordance with conditions in the field so this causes serious problems.

## Conclusion

Based on Government Regulation No. 6 of 1992 the status of Perum is changed to a Persero company and from January 1, 2014, PT Askes changed its name to BPJS Kesehatan based on Law no. 24 of 2011. At that time PT Askes (Persero) was closed without liquidation and also accompanied by the transfer of assets, rights and obligations of PT Askes (Persero) and its employees moved into BPJS Kesehatan. Characteristics of BPJS are oriented to serve community. Funds collected from participants' contribution are trust funds that will be managed for the welfare of participants. The juridical implications of PT Askes (Persero) transformation into BPJS Kesehatan is affecting the company where it is required to register its employees to BPJS Kesehatan and the company must allocate funds to pay the contribution of BPJS Kesehatan. Impact for participants or communities is participants must pay contributions to BPJS Kesehatan except for whose premium paid by the government.

**Ethical Clearance:** This research was ethically approved by Sebelas Maret University.

**Funding:** This research receives no external funding.

**Conflict of Interests:** There are no conflict of interests

## References

1. Bentham J, Mill JS. The utilitarians. Garden City, NY: Anchor Press/Doubleday;1973.
2. Tanya BL, Simanjuntak YN, Hage MY. Teori Hukum Strategi Tertib Manusia Lintas Ruang dan Generasi. Genta Publishing;2010.
3. Weber M. From Max Weber: Essays in sociology. Routledge;2009.
4. Dirdjosisworo S. Sosiologi Hukum. Rajawali Pers; 1983.



5. Soemardjan S. Sifat-sifat panutan di Dalam Pandangan Masyarakat Indonesia. Masalah-masalah Ekonomi dan factor-faktor Ipolsos, Leknas, Mipi, Rajawali Press;1965.
6. Sulastomo. Sistem Jaminan Sosial Nasional Sebuah Introduksi. Rajawali Press;2008.
7. El Kawaqi. [http://:www.el\\_kawaqi.blogspot.com](http://www.el_kawaqi.blogspot.com), Artikel Implementasi Menurut Para Ahli, 2012, accessed January 15, 2018.

# Bio-Nanocomposites: Preparation Technology and Applications

Fadhil K. Farhan<sup>1</sup>, Nura Anwer Abdulzahara<sup>2</sup>, Muhammad AL-Jobori<sup>3</sup>

<sup>1</sup>Assistant Professor, <sup>2</sup>Research Scholar, <sup>3</sup>Research Scholar, Department of Medical Physics,  
College of Science, University of Karkh for Science, Baghdad, Iraq

## Abstract

In this paper, combinations of a ceramic mixture with a polymer were developed to be used as a substitute for damaged bones or teeth. Overlays were prepared using the manual mixing method, followed by the use of ultrasound technology to ensure uniform distribution of the powder within the polymer. The polymer (PMMA) is supported with a ceramic powder (HAMgO) prepared using an effective mechanical mixing method. Where the percentages were used for consolidation, starting from (1%-4%). The results of the tests showed mechanical corrosion or the so-called wear and tear of a significant improvement for the reinforced polymeric compounds as the corrosion rate decreased to less than half at 4%. Likewise, the results of the particle hardness examination showed a successive increase in the percentages compared to the polymer base material. The results of the durability of compressibility and the Yunk coefficient showed a direct increase with the increase in the percentages of the added ceramic powder. The results were interpreted using the scanning electron microscope and by relying on the density values approved from the results of the exercise.

**Keyword:** Nano-composites, polymer, PMMA, HAMgO, Compression Strength, Young Modulus.

## Introduction

Polymeric composites have unique properties that qualify them to work in all fields, including industrial, medical and engineering, in addition to their use in military applications and in the manufacture of spacecraft<sup>[1,2]</sup>. Many researchers in this field were interested recently in this century in developing and producing polymeric-based compositions that act as materials that have the ability to withstand various mechanical stresses and have the ability to operate in harsh environmental conditions<sup>[3,4]</sup>. In light of this, many researchers were able to prepare polymeric nanoparticles that are used in bone and skeletal alternatives as well as used in the manufacture of teeth and their permanent fillings<sup>[5,6]</sup>. These prepared compounds underwent

high physical and mechanical conditions and showed great success in tolerating scratching and wear and resistance to fracture compression<sup>[7,8]</sup>. The polymers are histologically compatible with the organism are the most important characteristics in the formation of nanocomposites in this field and the most important medical polymers are (PLA, PMMA, HDPE, PVA, as well as biochemical materials are one of the pillars of the preparation of polymeric compounds for medical compensation use, such as Al<sub>2</sub>O<sub>3</sub>, ZrO<sub>2</sub>, TiO<sub>2</sub>, CaO, HA, MgO<sup>[9,10,11]</sup>. These compounds have specific properties that have the ability to withstand mechanical stresses and have the ability to resist bacteria and fungi. Most ceramic materials are materials compatible with body tissue and bonding, especially if they are in the nanoscale <sup>[12, 13]</sup>. Many researchers studied at AH in the field where the researcher *Fadhil K. Farhan and et al.* Prepared polymer compounds supported with binary ceramic powder from and obtained advanced results in improving mechanical properties<sup>[14]</sup>. The aim of the research is to manufacture Nano molecules based on a polymer supported by a resistant bi-ceramic market Wearing and working in exceptional conditions and in various forms.

---

### Corresponding Author:

**Fadhil K. Farhan**

Department of Medical Physics, College of Science,  
University of Karkh for Science, Baghdad, Iraq  
e-mail: fadfarh9@gmail.com

**Materials and preparation of nanocomposites:**

The materials were prepared first after they were diagnosed and their ability to work in this field was determined as the polymer was purchased and it is in two parts the first is a liquid called the monomer chloroform and the second part which is the powder imported from the United Arab Emirates and with regard to ceramic powders it has been imported from the US states with a size of 20 nanometers and a purity of 99.998. The overlays were prepared using liquid mixing and ultrasound technology for 10 minutes to ensure a homogeneous distribution between the polymer and the binary powder. Then the models were formed according to the measurements approved in the examination.

**Practical part:** The PIN-ON- DISC system was used to calculate the sliding wear and tear wear rate of the compounds. Models were created with dimensions of 1 cm in diameter and 3 cm in length. Using the following equations, the final wear rate<sup>[15]</sup>. Was calculated:

$W_r = \Delta m / S_D$  .....Wear rate (g/cm)  
 $\Delta m = m_1 - m_2$  ..... Wear loss (g)  
 $S_D = \pi \cdot N \cdot D \cdot T$  ..... Sliding distance (m)  
 $V_s = \pi \cdot N \cdot D / 60$  .....Sliding velocity (m/s)

**Where:**

- N: 2950 (rive/min)
- D: Routing distance (m) = 0.06 m
- T: Sliding time (min)

$W_v = W_r \cdot \rho$  ..... Volume Wear  
 $W_{coeff} = W_v \cdot H_V / L \cdot S_D$  ..... Coefficient Wear

**Where:**

- $\rho$ :Experimental density (g/cc)
- $H_V$ : Number Hardiness (MPa)

With regard to density, the Archimedes method was used to calculate the density of nanocomposites as well as the dimensional method to ensure the accuracy of the calculation. Vickers hardness device was also used to calculate the surface micro hardness of the superposition's where the results were recorded directly from the system in mica units and using a time of 20 seconds and a force of 0.5 Newton where the equation was used:

$Hv = 1875 p \backslash d^2$  (MPa)

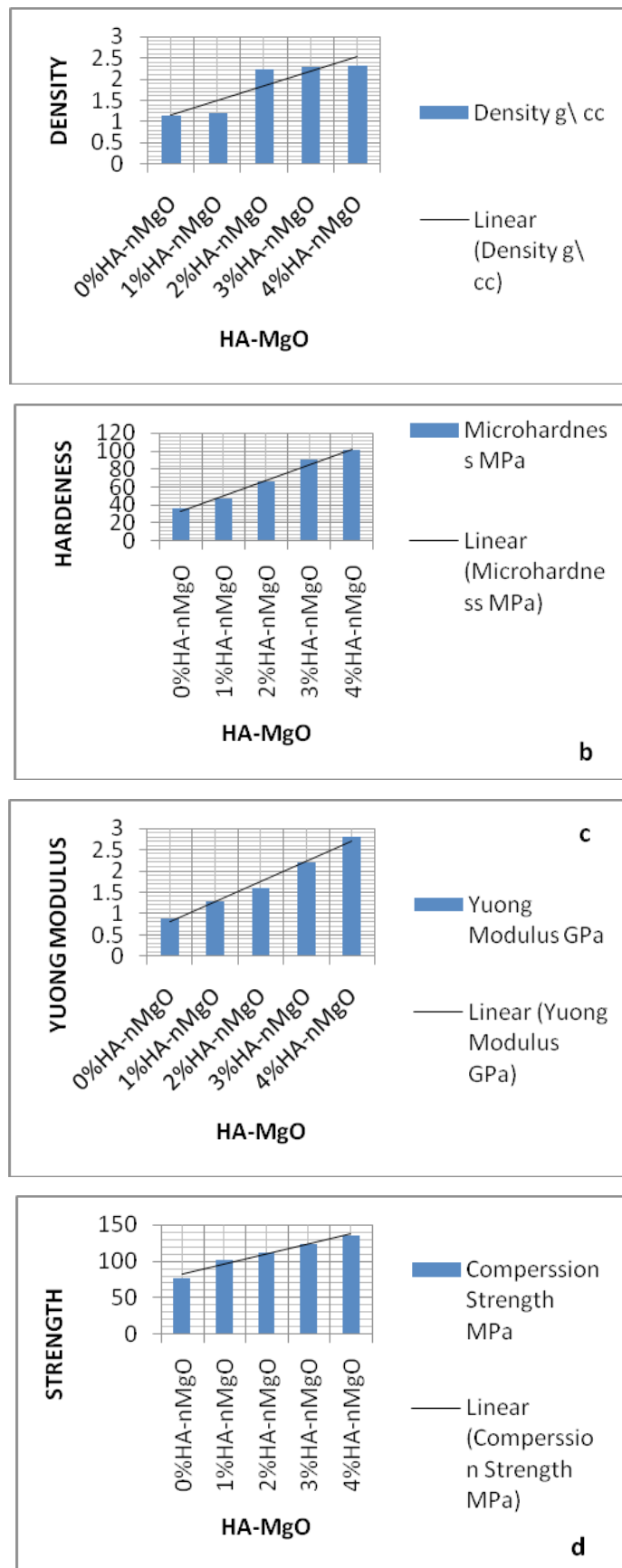
With regard to the compression test, the results were obtained by the examination system, called the universal machine, where the models were formatted as cylinders with dimensions of 2cm x2cm

**Results and Discussion**

**Physical Properties Results:** Table No. (1) And Figure (1) show a summary of the practical results of the physical properties that were performed for the prepared models, where the values of the practical intensity that were calculated by the Archimedes method and also were confirmed using the dimensional method. The results showed a significant improvement in the values of practical density with a direct increase with the percentage of additives. The reason is due to the closing of pores and the stacking of particles between the components of the mixed materials. The other reason is due to the high density of the additive and to the high surface area and the nano-scale of it. This is illustrated in Figure 1 of the density.

All other properties, such as particle hardness, compressive strength, young modulus (elastic modulus), all depend mainly on the density values for their structural association with these properties. The hardness values showed a significant improvement and a significant increase in the values of nanocomposites compared to the base material (polymer). The reason is due to the cohesion between the molecules, the substances formed for the compounds, as well as the reason due to the high density possessed by the nanocomposite, and this is shown by Figure (1) of the hardness.

An important test for studying the physical properties is calculating the durability of compression, which is very similar in the mechanism for measuring hardness. The results of compression durability show a clear improvement in the durability values of the compounds compared to the base material. The reason is due to the nanomaterial in transferring stress and distributing it in a way that reduces the failure in the model and this is clearly evident in the figure (compression strength). In Figure 1 of the modulus of elasticity, the great improvement in the values of the modulus of elasticity is evident. This indicates the resistance of the material to compression to a certain extent without any breakdown or collapse. All these properties are consistent with the source<sup>[16]</sup>.



**Fig.(1): Experimental of Mechanical Properties (a) Density, (b) Hardness, (c) young modulus, and (d) comparrison with Wight percentage HA-MgO.**

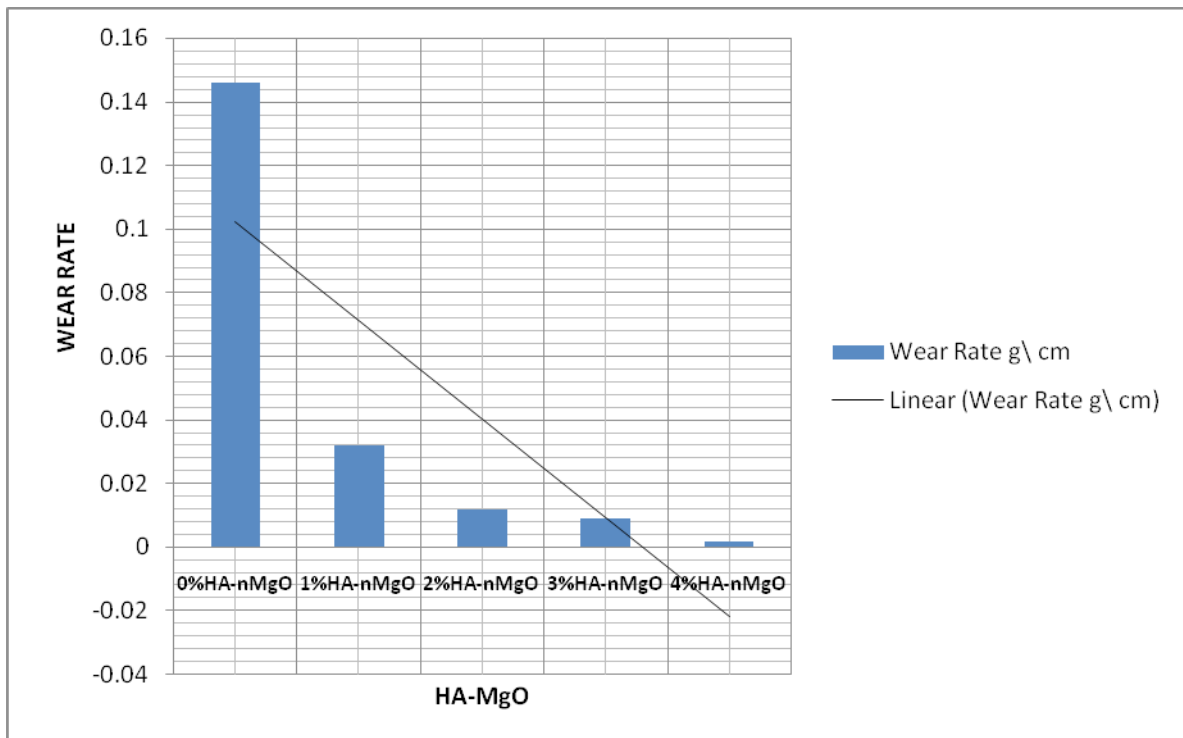
**Table (1): Practical results of the physical properties of Nano-composites PMMA\HA-nMgO**

Samples	Density g/cm <sup>3</sup>	Micro-Hardness MPa	Compression Strength MPa	Modulus – Elastic GPa
PMMA\0% HAMgO	1.144	36.2	77.4	0.877
PMMA\1%HAMgO	1.198	46.9	102.4	1.3
PMMA\2%HAMgO	2.22	65.5	111.5	1.6
PMMA\3%HAMgO	2.28	89.7	122.6	2.2
PMMA\4%HAMgO	2.32	100.5	135.3	2.8

**Discuss the wear Rate properties:** Table 2 and Figure (2.3) show a summary of the practical results of the triple properties of the prepared samples. A screw-on-disk device was used to calculate the dry mechanical corrosion rate of the nanocomposites and the dominant model. The results showed the calculation of the dry sliding wear factor and a clear decrease in the amount of skimming of the nanocomposites. This is due to the improvement of the outer surface of the samples supported by the Nano powder, which led to blocking the pores and voids and strengthening the bonds between the components of the supported sample compared to the unsupported substance (polymer). Therefore, such a work can be used in the dental industry and

damaged bone compensation, because these prepared nanocomposites have a high resistance to wear and wear, and this is consistent with the source.

In order to check the practical results of calculating the dry mechanical corrosion rate, the volumetric wear rate was calculated to ensure the accuracy of the calculation. It was included in the calculation of the mechanical corrosion rate, the practical intensity of the prepared models. Figure 3 shows volumetric wear behavior and we note the significant decrease in the volumetric corrosion values of nanocomposites compared to the base material (Polymer).

**Fig.(2): Experimental Wear Rate with Wight percentage HA-MgO**

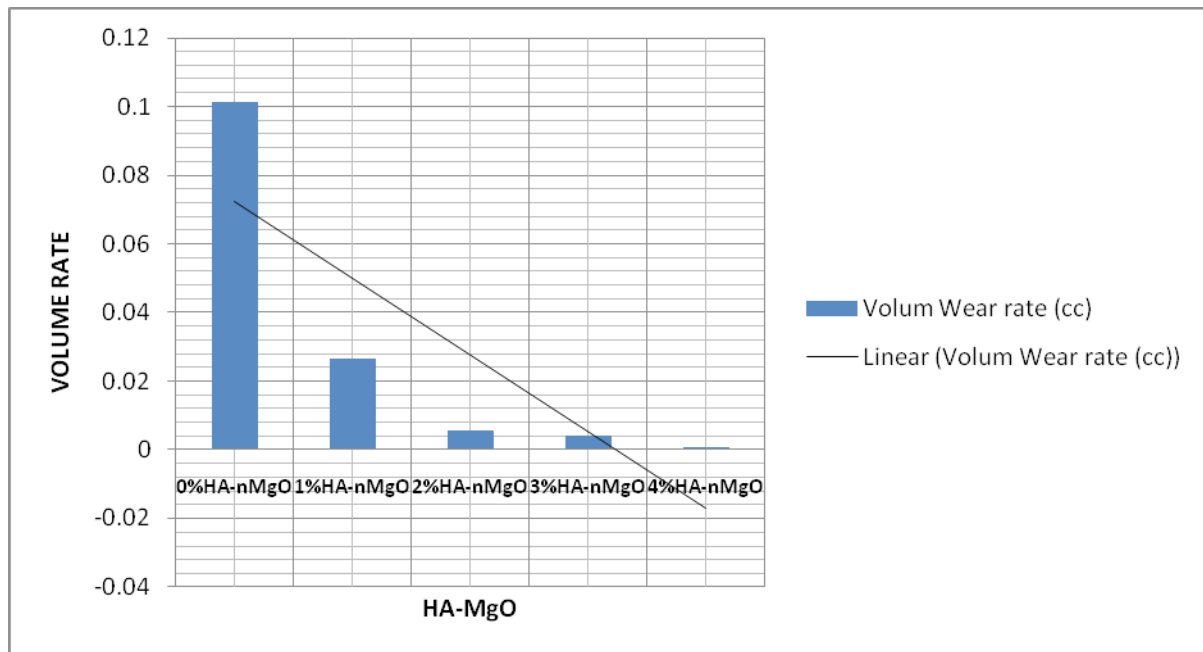


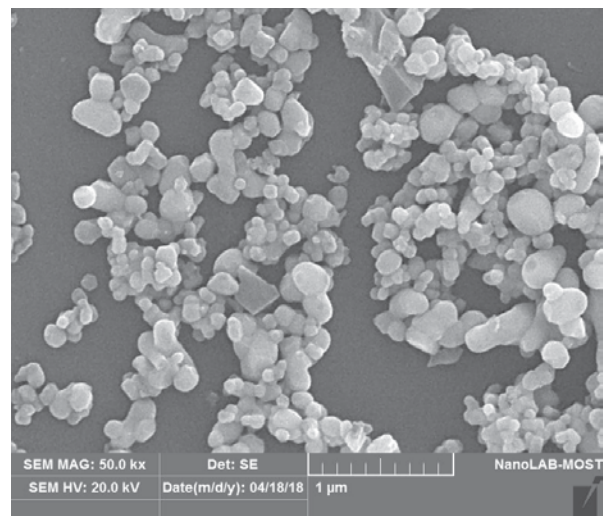
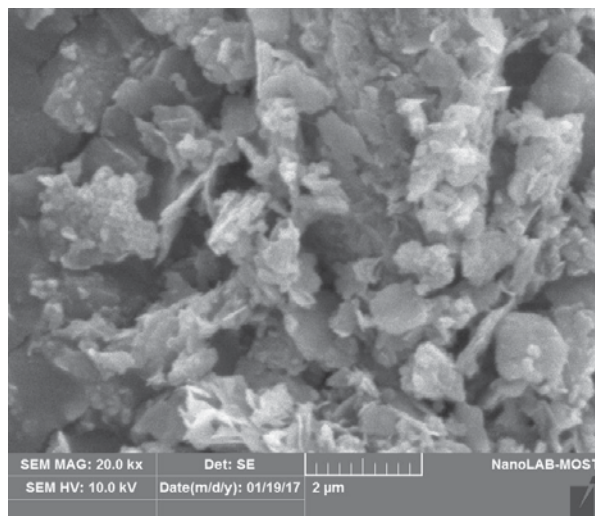
Fig.(3): Experimental Volume Wear Rate with Wight percentage HA-MgO

Table (2): Wear rate at 10 min

Sample	Mass before wear (g)	Mass After wear (g)	Wear Rate (g/cm) <sup>10<sup>-5</sup></sup>	Volume Wear <sup>10<sup>-6</sup> cm<sup>3</sup></sup>
0%HA-nMgO	3.246	3.100	0.146	0.10138
1%HA-nMgO	3.677	3.645	0.032	0.02671
2%HA-nMgO	3.886	3.874	0.012	0.00545
3%HA-nMgO	3.998	3.989	0.009	0.00394
4%HA-nMgO	4.125	4.123	0.002	0.00086

**Discuss the results of the scanning electron microscope:** Figure (4) shows pictures of the powders forming the HA-MgO compound. Figure (4) a shows the hexa-structure of the hydroxybite with a nanoscale of 20 nm. Figure (4) b shows the fibrous and spindle

composition of the nano-magnesium oxide compound, while Figure 4 (c) shows the mixed composition of the two compounds to form a non-distinct homogeneous compound.



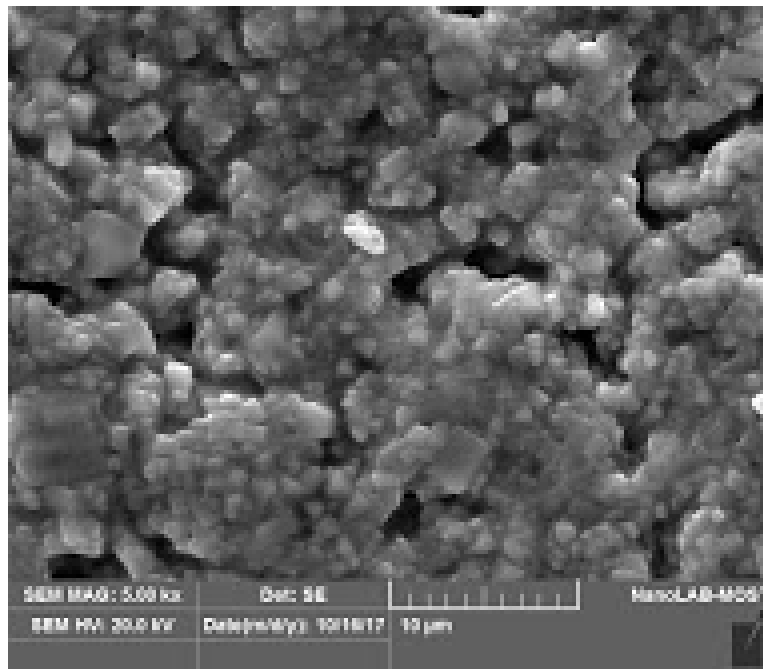


Fig. (4): SEM-Images of (a) HA, (b) MgO, and (c) HA-MgO

## Conclusions

**We conclude from the above from the current research:**

1. The significant improvement in all the physical properties of the nanocomposites is due to the great correlation between the nanocomposite within the polymer molecules, which gives it strength, durability, hardness and an increase in stacking.
2. The significant decrease in the scaling amount of nanocomposites to rates that do not nearly affect the weight and size of the samples is due to the high surface area of the nanocomposite and to the nanoscale used.
3. Scanning electron microscopy images show the shape and size of the compounds involved in the final compound composition, and through them the result was explained in (1,2) in addition to the density values.

**Ethical Clearance:** This study was approved by the Ethics Committee, University of Karkh for Science. The study protocol was thoroughly explained for using samples of patients and written informed consents were obtained from them prior to participation in the study.

**Source of Funding:** By Self

**Conflict of Interest:** Nil

## References

1. Patel RR, Kishorekumar B, Gupta N. Effect of filler materials and pre-processing techniques on conduction processes in epoxy-based nanodielectrics. In 2009 IEEE Electrical Insulation Conference 2009 May 31 (pp. 392-396). IEEE.
2. Suresha B. The role of fillers on friction and slide wear characteristics in glass-epoxy composite systems. *Journal of Minerals and Materials Characterization and Engineering*. 2006 Jun 12;5(01):87.
3. Jabbar A, Nayyef S. Studying mechanical and physical properties for polymer composite material reinforced by metal powders, Baghdad, 2008.
4. Dawood JJ. A Comparison Between the Wear Rate Behavior of Polyester Reinforced by Glass and Kevlar Fibers. *Engineering and Technology Journal*. 2009;27(11):2273-85.
5. Sun H, He S, Wu P, Gao C, Feng P, Xiao T, Deng Y, Shuai C. A novel MgO-CaO-SiO<sub>2</sub> system for fabricating bone scaffolds with improved overall performance. *Materials*. 2016 Apr;9(4):287.
6. Tan TY, Kennedy BJ, Zhou Q, Ling CD, Müller W, Howard CJ, Carpenter MA, Knight KS. Impact

- of Jahn-Teller active Mn 3+ on strain effects and phase transitions in Sr<sub>0.65</sub>Pr<sub>0.35</sub>MnO<sub>3</sub>. *Physical Review B*. 2012 Mar 19;85(10):104107.
7. Farhan FK, Kadhim MO, Ashour SJ. Preparation and Development of Ceramic System CaTiO<sub>3</sub> for Used Medical Applications. *Journal of Computational and Theoretical Nanoscience*. 2019 Jan 1;16(1):109-14.
  8. Kurella A, Dahotre NB. Surface modification for bioimplants: the role of laser surface engineering. *Journal of biomaterials applications*. 2005 Jul;20(1):5-0.
  9. Kharaziha M, Fathi MH. Synthesis and characterization of bioactive forsterite nanopowder. *Ceramics international*. 2009 Aug 1;35(6):2449-54.
  10. Khang D, Lu J, Yao C, Haberstroh KM, Webster TJ. The role of nanometer and sub-micron surface features on vascular and bone cell adhesion on titanium. *Biomaterials*. 2008 Mar 1;29(8):970-83.
  11. Liu Q, Cen L, Yin S, Chen L, Liu G, Chang J, Cui L. A comparative study of proliferation and osteogenic differentiation of adipose-derived stem cells on akermanite and  $\beta$ -TCP ceramics. *Biomaterials*. 2008 Dec 1;29(36):4792-9.
  12. Alwan SA, Alameer SS. The effect of the addition of silanized Nano titania fillers on some physical and mechanical properties of heat cured acrylic denture base materials. *Journal of Baghdad College of Dentistry*. 2015 Mar;325(2218):1-2.
  13. Thandavamoorthy TS. Determination of concrete compressive strength: A novel approach. *Advances in Applied Science Research*. 2015;6(10):88-96.
  14. Farhan FK, Kadhim MO, Ashour SJ. Preparation and Development of Ceramic System CaTiO<sub>3</sub> for Used Medical Applications. *Journal of Computational and Theoretical Nanoscience*. 2019 Jan 1;16(1):109-14.
  15. ASTM Standard Designation G 99-95a (Reapproved 2000). Standard test method for wear testing with a pin-on-disk apparatus. *Metals test method and analytical procedures 03.02*. 2002:414-9.



# Knowledge and Attitudes of Vaccination among Iraqi Pharmacy Students

Fadia Thamir Ahmed

Master of Clinical Pharmacy (M.Sc.), Lecturer/Deputy Head of Clinical Pharmacy Department,  
College of Pharmacy/University of Baghdad

## Abstract

**Objective:** Since the vaccination rate is largely affected by low knowledge and negative attitudes of healthcare professionals, so this study aimed to weigh up the vaccination knowledge and attitudes of pharmacy students.

**Method:** A pilot study using a survey to investigate demographic data, knowledge (20 questions), and attitudes (5 questions) of 156 fifth year and 121 third year pharmacy students from College of Pharmacy/University of Baghdad.

**Results:** The mean score of knowledge and attitudes was intermediate (16.654 and 14.917 out of 25 for the fifth and the third grades, respectively) with a significant difference between the two groups, the students shown to have favorable attitudes about vaccination. The score of the students is not influenced by family-related parameters like father's education, mother's education, the number of siblings and preschool children in the family.

**Conclusion:** A positive attitude and intermediate knowledge level about vaccination among pharmacy students were found. This could be improved by the addition of a specialized vaccinology course to the curriculum in pharmacy colleges and schools in Iraqi universities and going toward implementing the pharmacy-based immunization program for pharmacists by the health authorities which in turn can develop pharmacists' role in the healthcare system in Iraq.

**Keywords:** Knowledge, attitudes, pharmacy students, vaccination.

## Introduction

Immunization involves the administration of vaccines to individuals in order to develop immunity against any specific disease. The World Health Organization (WHO) states that vaccines are biological substances that are either single substance specified for one disease,

combined vaccines in one preparation that immunize the person against more than one disease or they can be live attenuated or weakened viruses that cause mild infection creating immunity against that virus. Immunization may involve the occurrence of a medical incident called the adverse event following immunization (AEFI) that may concern the vaccinated individuals. Controlling AEFIs and monitoring the safety of vaccines will increase immunization programs' credibility<sup>(1)</sup>. There are wrong concepts about vaccination owned by parents that affect their decisions to vaccinate their children; also some of them have hesitation to take vaccines due to safety issues<sup>(2)</sup>. This misconception may come from the possible relation between vaccines and different diseases such as Crohn's disease, multiple sclerosis and autism and the possibility that they can cause diseases which thought

---

### Corresponding Author:

Fadia Thamir Ahmed

Master of Clinical Pharmacy (M.Sc.), Lecturer/Deputy head of Clinical Pharmacy Department, College of Pharmacy/University of Baghdad

e-mail: fadia.ahmed@copharm.uobaghdad.edu.iq

to be vaccines associated<sup>(3)</sup>. Healthcare professionals' knowledge and attitudes toward vaccination can affect the patients' decision to vaccinate<sup>(4)</sup>. Misconceptions among healthcare workers may restrain vaccination process, since low level education and training about vaccination may lead to low rates of vaccination especially in people who are misinformed<sup>(5)</sup>. Pharmacists are able to take a fundamental responsibility in the vaccination administration to decrease vaccine-preventable deaths since they have a unique placement in community pharmacies with long working hours and being available on weekends<sup>(6)</sup>. It's more likely for patients to receive vaccines from educated and incited pharmacists rather than from a non-incited one<sup>(7)</sup>. The development of the practice zone of pharmacists as immunizers has encouraged adult vaccination by community pharmacies<sup>(8)</sup>. Still, reports from pharmacists about their needs to be well informed about the diseases and vaccinations so that they are able providerequired consultations and education to the parents and the patients<sup>(9)</sup>.

As a result, it is vital to guarantee that pharmacists have the required updated knowledge regarding vaccination<sup>(4)</sup>, and the pharmacy students as the future healthcare providers should have the necessary knowledge and attitudes toward vaccination, so it's possible for them to improve the information and conception of the parents so they can make the child vaccination decision<sup>(10)</sup>. This study is aimed to evaluate the knowledge and attitudes of pharmacy students toward vaccination.

## Materials and Method

**Study Design:** A pilot study included a questionnaire according to literature<sup>(10)</sup>. The study instrument has been designed and validated by authors<sup>(10)</sup>, and used in our study to explore the knowledge and attitudes of pharmacy students toward vaccination. The questionnaire composed of two parts: The first one investigated the demographic data, such as gender, age, and family data which include parents' education and the number of pre-school children. The second part contained the attitude and knowledge survey which included five questions about the attitude and twenty questions about the knowledge. The questionnaire was administered (in English) to the fifth (final) and third year students in the College of Pharmacy/University of Baghdad during the academic year 2018/2019 in November and December/2018.

**Ethics:** The students participated in this study expressed voluntary approval to be included when they filled and returned the survey and they are all of age (older than 18). The questionnaire did not contain any personal identifiers during the distribution and collection process.

**Statistics:** The data was arranged and saved using Microsoft Excel. Frequencies and percents were used to describe categorical variables; these include the frequency of responses for the knowledge and attitude expressed as correct and wrong answers. Age and knowledge and attitudes score were presented as means and standard deviations (continuous variables). To calculate knowledge and attitudes' score, correct answers =1; wrong answers =0 values were used and the overall score for each student then the score for all students were calculated. The maximum score that can be obtained equals 25. Windows Statistical Package for the Social Sciences (SPSS) 20 has been used for advance data analysis. Continuous variables (age) have been analyzed by Man-Whitney test for non-parametric distribution, while the association between discrete variables (gender, parents' education, the siblings' number and preschool children's number) and the significance of differences in the knowledge and the attitudes' questions among the two groups have been analyzed by Chi square test for independence. P-values<0.05 were considered to be significant.

## Results

A total of 277 students out of 330 completed the questionnaire (156 students out of 180 from the fifth grade and 121 students out of 150 from the third grade with response rate 86.7% and 80.7% respectively). The majority of students were females for both groups with a non significant difference between the two groups. The age range for the fifth grade was between 22 and 24 years with a mean age of (22.5±0.6) years old, while for the third grade was between 20 and 22 with mean age of (20.6±0.7) with a significant difference between them. The remaining variables are described in table (1), presented as numbers and percents with a non significant difference between the two groups. Mean knowledge and attitudes' score was 16.654 and 14.917 out of 25 for the fifth and the third grade respectively. The responses to the study questionnaire are presented in table (2). The knowledge and attitudes of the students are not influenced by parameters like father's education, mother's education, the number of siblings and

preschool children in the family (these parameters have no significant effect in determining the knowledge and

attitudes of the students with P-value of 0.600, 0.355, 0.484 and 0.402 respectively).

**Table 1: The students' demographic data.**

	Parameter		Fifth grade	Third grade	P-value
1	Age: Mean $\pm$ SD		22.5 $\pm$ 0.6	20.6 $\pm$ 0.7	0.000
2	Gender: n (%)	Female	112(71.8%)	93(76.9%)	0.340
		Male	44(28.2%)	28(23.1%)	
3	Father Education: n (%)	Primary	22(14.1%)	19(15.7%)	0.710
		Secondary	134(85.9%)	102(84.3%)	
4	Mother Education: n (%)	Primary	29(18.6%)	28(23.1%)	0.275
		Secondary	127(81.4%)	93(76.9%)	
5	Brothers and sisters' number: n (%)	1	21(13.5%)	18(14.9%)	0.480
		2	87(55.8%)	76(62.8%)	
		3	39(25%)	22(18.2%)	
		4	9(5.7%)	5(4.1%)	
6	Preschool children's number: n (%)	0	123(78.9%)	113(85.1%)	0.399
		1	30(19.2%)	16(13.2%)	
		2	3(1.9%)	2(1.7%)	

The responses are presented as numbers and percents.

**Table 2: The knowledge and attitudes of Iraqi pharmacy students toward vaccination.**

	Questions	Fifth grade (n:156) Correct answers: n (%)	Third grade (n:121) Correct answers: n (%)	P-value
1	Vaccine is a medical treatment contains killed or modified dangerous viruses and bacteria to be put into the body.	115 (73.72%)	97 (80.2%)	0.209
2	A disease causative agent that is killed or weakened is called active immunization.	128 (82.05%)	74 (61.2%)	<0.001
3	The antibody from person was infected with the disease is called passive immunization.	131 (83.97%)	69 (57%)	<0.001
4	The occurrence of any major infectious disease has not changed significantly by vaccines.	121 (77.56%)	93 (76.9%)	0.890
5	In fact, vaccines cause more disease than they prevent	135 (86.54%)	112 (92.6%)	0.110
6	Vaccines are from the most efficient and cheapest types of medical therapy.	109 (69.87%)	76 (62.8%)	0.216
7	Vaccines result in lifelong protection from many dangerous diseases; this explains why they are given for children on a regular basis.	140 (89.74%)	107 (88.4%)	0.727
8	Vaccination is for all age.	99 (63.46%)	71 (58.7%)	0.417
9	A feasible regular vaccination schedule should be started on the first day	99 (63.46%)	62 (51.2%)	0.041
10	Infants under 1 year of age should never receive vaccines.	82 (52.56%)	71 (58.7%)	0.310
11	More than 70% of vaccination doses are given for children younger than 2 years.	34 (21.79%)	21 (17.4%)	0.358
12	The first vaccination dose is BCG against Tuberculosis.	113 (72.44%)	83 (68.6%)	0.486

	Questions	Fifth grade (n:156) Correct answers: n (%)	Third grade (n:121) Correct answers: n (%)	P-value
13	The vaccine should not be freeze and their storage should be at a temperature above 8°C.	94 (60.26%)	49 (40.5%)	0.001
14	After the seal is opened, the vaccine should be used within 72 hours.	65 (41.67%)	42 (34.7%)	0.238
15	Vaccines are harmful.	75 (48.08%)	53 (43.8%)	0.479
16	In case most of the population acquires protection against infections, the hazard of a few vaccines' adverse reactions is acceptable.	132 (84.62%)	76 (62.8%)	<0.001
17	One significant contraindication in child vaccination is fever.	103 (66.03%)	68 (56.2%)	0.095
18	It is more effective and safer for the child if given extra vaccination.	74 (47.44%)	38 (31.4%)	0.007
19	If vaccination dose was given to the child before the proper time, it will be repeated.	103 (66.03)	63 (52.1%)	0.019
20	The CDC (the Center for Disease Control and Prevention) recommends a yearly adult influenza vaccination.	54 (34.62%)	27 (22.3%)	0.026
21	Is it likely to have influenza as a result of the influenza vaccine?	73 (46.80%)	59 (48.8%)	0.745
22	The influenza vaccine is considered to be safe for children (with ages between 6 months and 18 years) and adults.	115 (73.72%)	79 (65.3%)	0.129
23	Vaccines are necessary	142 (91.02%)	114 (94.2%)	0.320
24	Are you in favor of vaccination in general?	126 (80.77%)	103 (85.1%)	0.342
25	Will you recommend vaccination to others?	136 (87.18%)	98 (81%)	0.158
	Mean knowledge and attitudes score	16.654	14.917	0.009

The responses are presented as numbers and percents.

## Discussion

Overall, this study showed that the final year pharmacy students have positive attitudes toward vaccination with a non significant difference between fifth and third grade pharmacy students. According to the WHO immunization Strategic Advisory Group of Experts, the uncertainty about vaccination is largely growing and attitudes and viewpoints of health professionals are from the objective factors that determine it<sup>(11)</sup>.

Many studies stated that positive attitudes of professionals in healthcare system have been realized to be associated with elevated vaccination rates<sup>(12,13)</sup>. Additionally, the recommendation of vaccines by healthcare professionals arises mainly from their belief that vaccines are beneficial and their professional obligation and requires patients' trust in healthcare workers<sup>(14)</sup>.

Other studies have shown that health professionals are considered a determinant factor for parents and

other persons affecting themselves and their children's vaccination decisions<sup>(15,16)</sup>. Especially after the conflict against vaccination started a few years ago and resulted in hesitation and unwillingness of parents toward children's vaccination due to adverse effects and safety concerns<sup>(17)</sup>, and claimed associations of vaccines to the occurrence of various diseases<sup>(3)</sup>.

Healthcare professionals' vaccination knowledge can affect the vaccination decision, since badly informed caregivers may create obstacles against obtaining coverage of vaccination within a population<sup>(4)</sup>. Furthermore, enlightened and provoked patients by their pharmacist seem to be more likely to receive vaccines<sup>(7)</sup>. So, ensuring that health workers realize the facts, effectiveness and safety of vaccines is vitally important<sup>(4)</sup>. Opportunity to optimize and lead immunization preparation from the beginning of professional education can be obtained by evaluation of awareness, attitudes and concerns of students starting their health care professional study<sup>(14)</sup>.

In our study, the students' knowledge and attitudes have not been affected by various parameters like parents' education, the number of siblings and preschool children in the family for both groups. One study showed that the knowledge about vaccination to be affected by the father education<sup>(10)</sup>.

The first five questions investigated the general knowledge about vaccination and the responses in two questions about passive and active immunization were significantly different between fifth and third year students. This can be attributed to the fact that third year students did not receive the courses of Immunology and Public health yet, which are included in the fourth year syllabus in Iraqi pharmacy schools.

As progressing to more specific questions, correct answers' percentage decreased, with some questions having wrong answers in a higher percentage than right ones. When analyzing the questions investigated children's vaccination, most questions have been answered correctly by both groups with a non significant difference between them, except the questions which talked about that the children receive 70% of vaccination within the first two years of life and the safety of extra vaccination, the answers were mostly wrong in both groups. On the other hand, the question regarding the storage of vaccines has been answered mostly correct by fifth year students and wrong by third year students with a significant difference between them, while the questions related to the use of vaccine after its opening, and the CDC influenza vaccine recommendation for all adults, most answers were incorrect by both groups.

The overall knowledge and attitude score were significantly different between the two groups with both groups having a moderate score value and a higher score for fifth year students. These findings are compatible with another study which showed poor mean knowledge among medical field students<sup>(18)</sup>. This level of knowledge may create a negative attitude toward vaccination as a result of misinformed healthcare workers about vaccine function, aim and adverse effects<sup>(19)</sup>. On the contrary, some studies demonstrated an elevated score of knowledge and attitude toward vaccination among students<sup>(20)</sup>. Another study stated that the knowledge and attitude score was high but has a non significant impact on vaccinations' acceptance<sup>(21)</sup>.

In this study, the score can be linked to the fact that there is no specific course in the college curricula about

vaccination and to inadequate structured exposure of the topic. Consequently, pharmacy students are partially uninformed of its significance, associated side effects, timetable, and storage. In general, there is low knowledge of the essential information about vaccination about their future responsibilities of pharmacist as a healthcare supplier. More than 35 colleges of pharmacy, including private and governmental pharmacy faculties in Iraq<sup>(22)</sup>, all of them follow the same courses' outlines without a specific vaccinology course, and this represents a determinant factor in the pharmacy students' vaccination knowledge deficiency.

Many studies support this fact; a study conducted in the USA revealed that pharmacy schools have an obligation to enhance pharmacy student education and to develop the pharmacist-in-training skills that will prepare pharmacists for such a duty<sup>(5)</sup>. Other studies reported the pharmacists' needs to acquire knowledge<sup>(9)</sup>, and recommended to include a vaccinology course into the undergraduate syllabus of health care professionals in order to develop their knowledge<sup>(23)</sup>. Accordingly, the implication of a vaccinology course in the curriculum of pharmacy schools in Iraq can significantly increase pharmacists' knowledge and improve their attitudes toward vaccination.

On the other hand, a huge number of pharmacists graduate each year and the number of registered pharmacists at the Syndicate of Iraqi Pharmacists has exceeded the pharmacist to population ratio recommended by WHO (1:2000)<sup>(22)</sup>. This led to larger percents of unemployment in the private sector among young pharmacists, in addition to a disguised unemployment among pharmacists in governmental jobs with a limited role of the pharmacists in the hospitals and community health centers, and no role in vaccines' administration, since the Iraqi Ministry of Health does not implement pharmacy-based immunization services.

As a result, implementing pharmacy-based immunization program by the Ministry of Health can offer great benefits by utilizing the large number of pharmacists and provide additional job opportunities in the private sector. As many studies confirmed the readiness of pharmacy students to participate in the pharmacy-based immunization service<sup>(24)</sup>, and the fact that pharmacists have a remarkable role as instructors, implementers and immunizers, by which they can promote patients to be vaccinated and to enhance vaccination rates<sup>(25)</sup>. Another study investigated the implementation the training

program of national immunization, in which a significant impact was reported on the demonstrated knowledge and expertise of the competent students. Nevertheless, the purported pharmacy students' attitudes did not vary considerably<sup>(26)</sup>.

The limitations are small sample size included in our study and the fact that it is confined to students from the College of Pharmacy/University of Baghdad, since students from other pharmacy schools in Iraq may reveal different outcomes. Further larger scale research is required, with students from different pharmacy schools around the country, to obtain more precise and representing results.

### Conclusion

In summary, this study showed a positive attitude toward vaccination among pharmacy students, which is considered to be a good result when taking into account the general misconception appeared in recent years. Both fifth and third year students demonstrated an intermediate level of vaccination knowledge with significant difference and more score for fifth year students over third year students.

The addition of a specialized vaccinology course to the curriculum in pharmacy schools can improve their knowledge and attitudes. Furthermore, implementing the pharmacy-based immunization program by the health authorities can improve the future role of pharmacists in the healthcare system and help to utilize the increased numbers of pharmacists in Iraq.

**Acknowledgement:** Sincere appreciation to all pharmacy students participated in this study.

**Source of Funding:** Self funding

**Conflict of Interest:** Nil

### References

- World Health Organization. Immunization Safety Surveillance: Guidelines for immunization programme managers on surveillance of adverse events following immunization. Third edition. WHO Reg Off West Pacific. 2016;
- Williams SE, Rothman RL, Offit PA, Schaffner W, Sullivan M, Edwards KM. A randomized trial to increase acceptance of childhood vaccines by vaccine-hesitant parents: A pilot study. *Acad Pediatr*. 2013 Sep 1;13(5):475–80.
- Kimmel SR. Vaccine Adverse Events: Separating Myth from Reality. Vol. 66, *American Family Physician*. 2002 Dec.
- Sočan M, Erčulj V LJ. Knowledge and attitudes on pandemic and seasonal influenza vaccination among Slovenian physicians and dentists. *Eur J Public Health*. 2013;23(1):92–7.
- Bain KT, Cullison MA. Deficiencies in Immunization Education and Training in Pharmacy Schools : A Call to Action. *Am J Pharm Educ*. 2009;73(6).
- Hogue MD, Grabenstein JD, Foster SL, Rothholz MC. Pharmacist involvement with immunizations: A decade of professional advancement. Vol. 46, *Journal of the American Pharmacists Association*. American Pharmacists Association; 2006. p. 168–82.
- Kubli K, Mcbane S, Hirsch JD, Lorentz S. Student pharmacists' perceptions of immunizations. *Curr Pharm Teach Learn*. 2017;9(3):479–85.
- Burson RC, Buttenheim AM, Armstrong A, Kristen A, Burson RC, Buttenheim AM, et al. Community pharmacies as sites of adult vaccination : A systematic review. *Hum Vaccin Immunother*. 2016;12(12):3146–59.
- Khanna R, Jariwala K. Awareness and knowledge of autism among pharmacists. *Res Soc Adm Pharm*. 2012 Sep 1;8(5):464–71.
- Allela OQB. Knowledge and Attitude of Immunization among IIUM Pharmacy Students Knowledge and Attitude of Immunization among IIUM Pharmacy Students. *J Basic Clin Pharm*. 2018;8:64–9.
- Dubé E, Gagnon D, Nickels E, Jeram S, Schuster M. Mapping vaccine hesitancy-Country-specific characteristics of a global phenomenon. *Vaccine*. 2014 Nov 20;32(49):6649–54.
- Gust DA, Strine TW, Maurice E, Smith P, Yusuf H, Wilkinson M, et al. Underimmunization among children: effects of vaccine safety concerns on immunization status. *Pediatrics*. 2004;114(1):e16–22.
- Weigel M, Weitmann K, Rautmann C, Schmidt J, Bruns R, Hoffmann W. Impact of physicians' attitude to vaccination on local vaccination coverage for pertussis and measles in Germany. *Eur J Public Health*. 2014 Mar 5;24(6):1009–16.
- Yaqub O, Castle-clark S, Sevdalis N, Chataway J.

- Attitudes to vaccination : A critical review. *Soc Sci Med.* 2014;112:1–11.
15. Smailbegovic MS, Laing GJ, Bedford H. Why do parents decide against immunization? The effect of health beliefs and health professionals. *Child Care Health Dev.* 2003;29(4):303–11.
  16. Smith PJ, Kennedy AM, Wooten K, Gust DA, Pickering LK. Association between health care providers' influence on parents who have concerns about vaccine safety and vaccination coverage. *Pediatrics.* 2006;118(5):e1287–92.
  17. Black S, Rappuoli R. A crisis of public confidence in vaccines. In: *Science Translational Medicine. American Association for the Advancement of Science*; 2010. p. 61mr1-61mr1.
  18. Maroof KA, Bansal R, Parashar P, Sartaj A. Do the medical , dental and nursing students of first year know about hepatitis B ? A study from a university of North India. *J Pak Med Assoc.* 2012;62(1):24–7.
  19. Busse JW, Kulkarni A V, Campbell JB, Injeyan HS. Attitudes toward vaccination: a survey of Canadian chiropractic students. *CMAJ.* 2002;166(12):1531–4.
  20. Lerais I, Durant M, Gardella F, Hoffiger P, Pradier C, Giordanengo V, et al. Assessment of students' knowledge, opinions and behaviours about Human Papilloma Virus (HPV), France, Alpes-Maritimes, 2009. *Bull Épidémiologique Hebd.* 2010;11:97–100.
  21. Bendik MK, Mayo RM, Parker VG. Knowledge, perceptions, and motivations related to HPV vaccination among college women. *J Cancer Educ.* 2011 Sep 21;26(3):459–64.
  22. Ahmed FT, Kadhim SA, Ali FZ. INTENTIONS AND PERCEPTIONS OF IRAQI PHARMACY STUDENTS TOWARD POSTGRADUATE EDUCATION. *Int Res J Pharm.* 2018;9(9):99\_104.
  23. Cvjetkovic SJ, Jeremic VL, Tiosavljevic D V. Journal of Infection and Public Health Knowledge and attitudes toward vaccination : A survey of Serbian students. *J Infect Public Health.* 2017;10(5):649–56.
  24. Luthin DR, King SR, Wensel TM, Rosser AN, Monk-tutor MR. Relationship between pharmacy students ' knowledge about , attitudes toward , and intention to provide pharmacy-based immunization services. *Curr Pharm Teach Learn.* 2011;3(3):171–7.
  25. Bach AT, Goad JA. The role of community pharmacy-based vaccination in the USA : current practice and future directions. *Integr Pharm Res Pract.* 2015;4:67–77.
  26. Marcum ZA, Maffeo CM, Kalsekar I. The impact of an immunization training certificate program on the perceived knowledge , skills and attitudes of pharmacy students toward pharmacy-based immunizations. *Pharm Pract.* 2010;8(2):103–8.

# Trend of Implementation Foster Family Toddlers (FFT) Program in East Java Province at 2015-2019

Fadilatul Fahmiyah<sup>1</sup>, Lutfi Agus Salim<sup>2</sup>

<sup>1</sup>Bachelor Student in Department Biostatistics and Demography, Faculty of Public Health, Universitas Airlangga, Surabaya, Indonesia, <sup>2</sup>Associate Professor in Department Biostatistics and Demography, Faculty of Public Health, Universitas Airlangga, Surabaya, Indonesia

## Abstract

Foster Family Toddlers (FFT) as an effort program to improve the knowledge and skills of parents fostering the development of children in a whole and optimal way. The result of 2018 Basic Health Research, East Java Province shows the percentage low birth weight is 6.5%, underweight of toddler is 15%, wasting of toddler is 8% and the coverage of exclusive breast milk is 40%. East Java Health Profile 2018 showed of low birth weight is 3,7% and the coverage of exclusive breast is 76.83%, underweight and wasting in toddler is not found numbers, but there is the weight of toddler in under red line is 0.77%. Therefore, needs to know trend of the implementation of FFT in East Java. This study was quantitative descriptive research design with secondary data. The result showed the reporting of FFT group from 2015-2017 increased by 4.52% and decreased in 2017-2019 by 4.52% and has not reached the target of KKP 80%. FFT member participation in 2015-2017 increased by 3.78% and decreased in 2017-2019 by 12.55%. FFT family attendance at the 2015-2016 Meeting increased by 1.38% and decreased in 2016-2019 by 1.24%, and the family of members of FFT Child Card Users in 2015-2019 saw a continuous increase of 9.52%. So the result of the trend of the implementation of activities is less maximal because there are still some obstacles to be considered.

**Keywords:** *Foster Family Toddlers, child growth, chart reporting.*

## Introduction

Family development is an effort to realize quality families who live in a healthy environment through family development. Family development is the responsibility of all parties including NPPF as mandated in Law No. 52 of 2009 on Population Development and Family Development<sup>(1)</sup>. Family development policies are carried out through fostering resilience and family welfare<sup>(2)</sup>. One of them is implemented through improving the quality of children by providing access to information, education, counselling and services on

care, parenting and child development to families with toddlers. Children are a valuable investment in the progress of a nation because the child is the future holder of the nation, therefore the child as a Human Resources (HR) must be built early on in order to create quality human resources for the future of the nation<sup>(3)</sup>.

Optimal growth and development is one of the rights of every child stipulated in Law No. 23 of 2002 on Child Protection article 26 items a and b. Under the Law, parents are obliged to nurture and develop children. This is the same as the rights of the child described in the Convention on the Rights of the Child. Based on this it is clear that optimal growth is the right of every child and should be obtained by the child. The realization of the goal is not separated from the role of parents as the child's first environment<sup>(4)</sup>.

The Ministry of National Development Planning noted that during 2018-2019 East Java Province is one of the provinces that is the priority area of stunting problem

---

### Corresponding Author:

**Lutfi Agus Salim**

Associate Professor in Department Biostatistics and Demography, Faculty of Public Health, Universitas Airlangga, Surabaya, Indonesia  
e-mail: lutfi.as@fkm.unair.ac.id



handlers. In 2018, East Java has 11 locus for stunting (including Jember Regency, Nganjuk Regency and Lamongan Regency), and in 2019 increased by 1 district, namely Kediri Regency<sup>(5)</sup>. Basic health research data in 2018 shows that there is a decrease in stunting rates compared to 2013, stunting rates in East Java are still at more than 30%. 2018 Basic Health Research results, East Java Province the numbers are as follows: Underweight percentage of 6.5%; underweight prevalence in toddlers by 15%; the prevalence of wasting in toddlers is 8% and exclusive breast milk coverage is 40%<sup>(6)</sup>. East Java Health Profile 2018 the percentage of underweight was 3.7%; and exclusive breast milk coverage of 76.83%, for indicators of prevalence of underweight and wasting in toddlers there is no figure, however there is data that the figure of toddlers weight below the red line is 0.77%<sup>(7)</sup>.

Recognizing the importance of fostering children's development early on, since 1984 the National Population and Family Planning Board (NFPF) established the Toddler Family Development Program (FFT), and since 1991 this program has developed into the FFT Movement. FFT implementation is an effort to improve the knowledge and skills of parents in fostering the development of children in a whole and optimal way, through the provision of physical, cognitive, socio, emotional and spiritual stimulation. By actively participating in FFT activities, parents are expected to have enough supplies to help their children live their toddler life properly, well and pleasantly<sup>(8)</sup>. Therefore, researchers are determined to study how the trend of implementing FFT activities in East Java Province in 2015-2019.

## Method

This research was used quantitative research method with quantitative descriptive research designs. The data source is used secondary data. This study uses data sourced from the NFPF yearly report and also the policy for the implementation of the NFPF FFT Program.

## Results

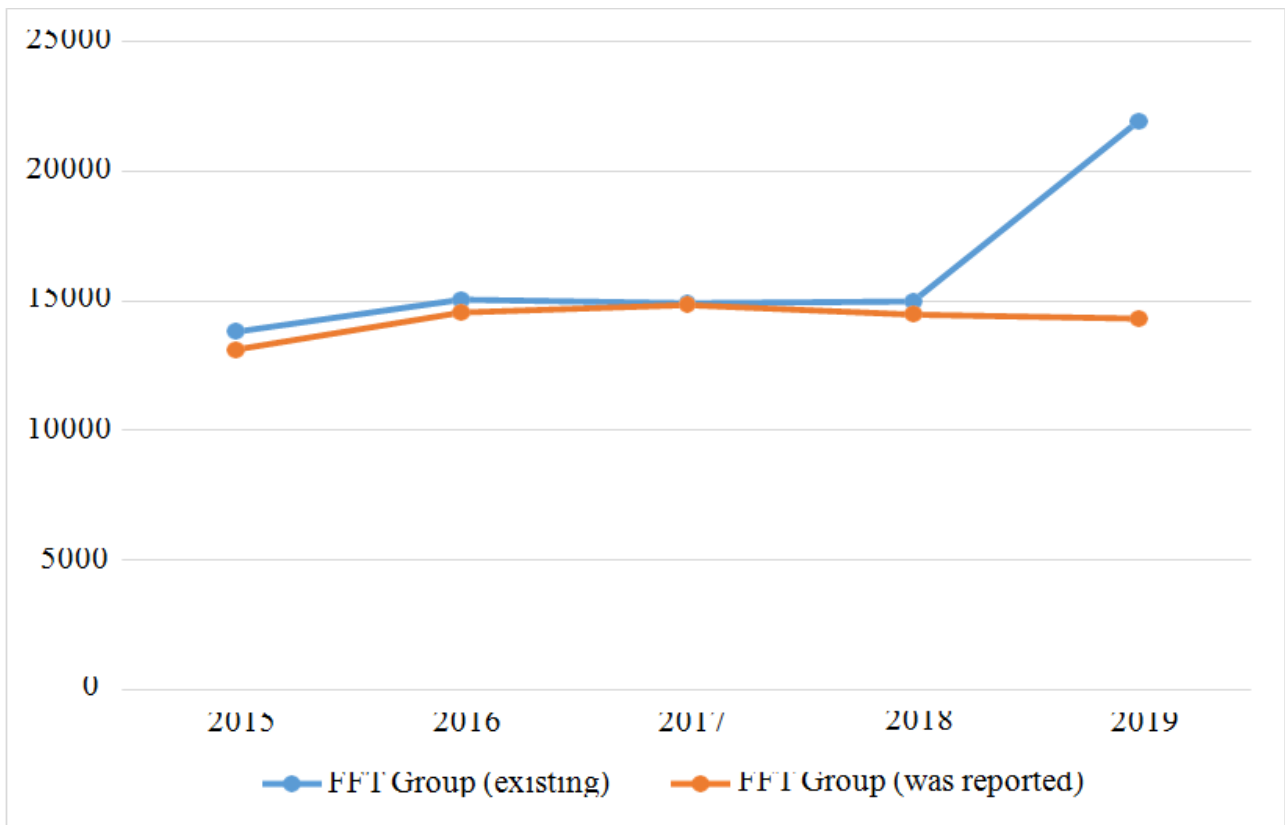
Implementation of FFT are activities that are carried out once a month. To perform its functions properly. The implementers of the FFT program in the field are trained cadres, while participants or members of the FFT

group are parents and other family members who have toddlers (0-5 years) and preschool age (5-6 years)<sup>(9)</sup>. The formation of FFT Group is carried out as a family coaching platform to improve knowledge and skills in parenting and fostering children. The development of FFT group is carried out as an effort to improve the quality and quantity of the group through cooperation with related partners in both the government and private sectors. One form of development is the integrated FFT-integrated service post (POSYANDU)-PAUD (health, education) and the formation of FFT pilot groups in each sub-district<sup>(10)</sup>.

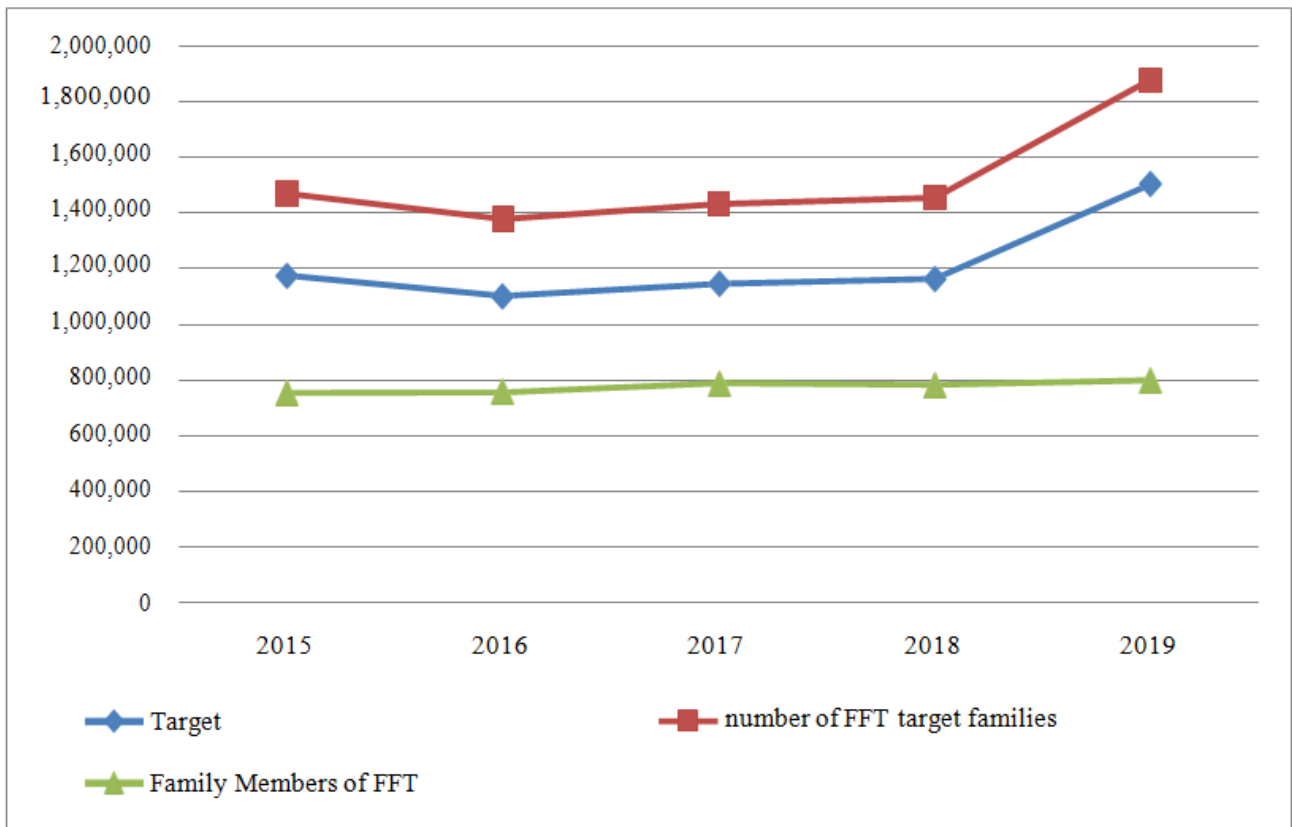
The recording and reporting in the Resilience Program for Children and Toddlers is carried out in a tiered way starting from the implementation of activities by FFT groups at the field level, villages, sub-districts, districts/cities, provinces and national. The recording and reporting of FFT activities is carried out by FFT cadres, including<sup>(11)</sup>:

1. FFT group registration card (K/0/FFT/10)
2. FFT group record card (C/1/FFT/10)
3. FFT report card (R/1/FFT/10)
4. Activity notebooks include: attendance/registration books, records of activity implementation, work plans, ledgers, and participation notes of kb members.

Based on the chart above, shows that the trend from 2015-2017 increased by 4.52% which in 2015 the existing FFT group was 13,809 and which reported a total of 13,121 which means its achievement of 95.02%, then in 2016 the existing FFT group numbered 15,052 and which reported a total of 14,549 which meant its achievement amounted to 96.66% and also in 2017 the existing FFT group numbered 14,912 and which reported a total of 14,843 which meant its achievement of 99.54%. However, there was a decrease in 2017-2019 of 31, 32% where in 2018 the existing FFT group amounted to 14,984 and which reported a total of 14,473 which meant its achievement amounted to 96.59%, then in 2019 the existing FFT group amounted to 21,925 and which reported a total of 14,311 which means its branding of 65.27%. This is because the target of the toddler's family who have to follow the FFT increases.



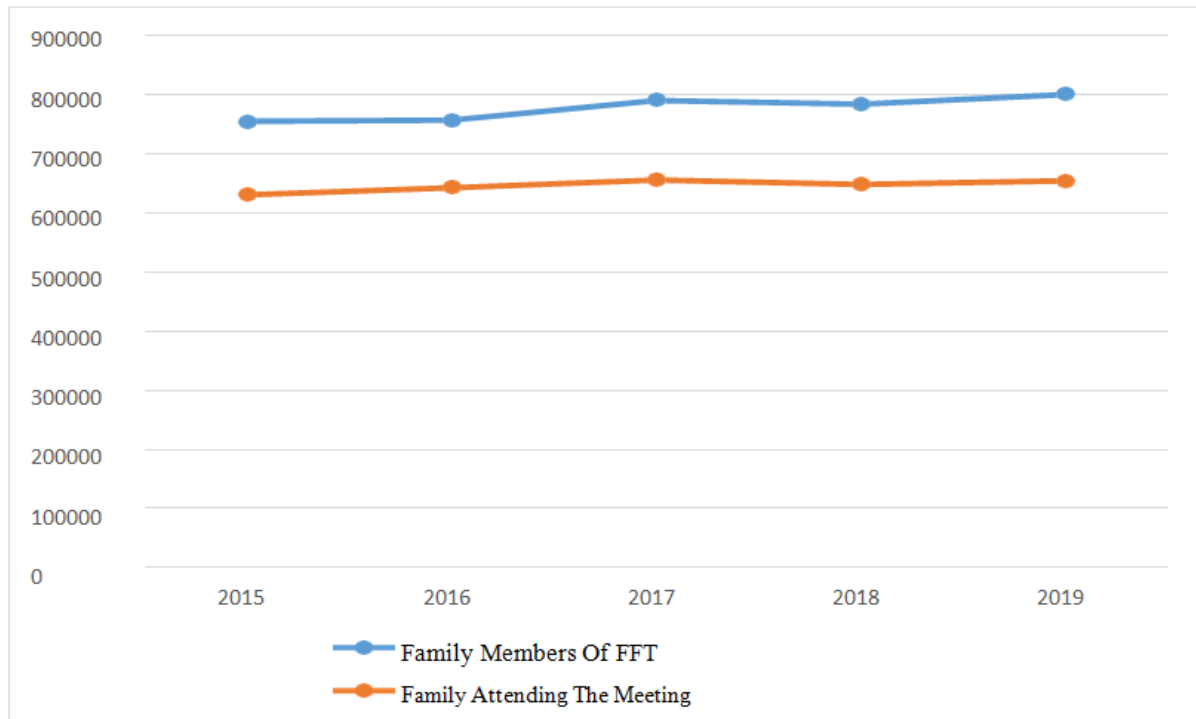
**Figure 1 FFT Group Reporting Trends in East Java Year 2015-2019**



**Figure 2 Trends of FFT Member Participation in East Java Year 2015-2019**

The results of the analysis showed that the trend from 2015-2017 increased by 3.78% where in 2015 the number of FFT target families was 1,470,022 and that FFT members total 754,998 which means the achievement of 51.36%, then in 2016 the number of FFT target families is 1,378,877 and who are members of FFT number 757,142 which means its achievement of 54.91% and also in 2017 the number of FFT target families is 1,432,658 and which is a member of FFT number 789,918 which means its achievement of 55.14%. If seen from the target of KKP that is 80% per year, then FFT membership has not reached the target of 2015 (1,176,018), 2016 (1,103,102), and 2017 (1,146,126).

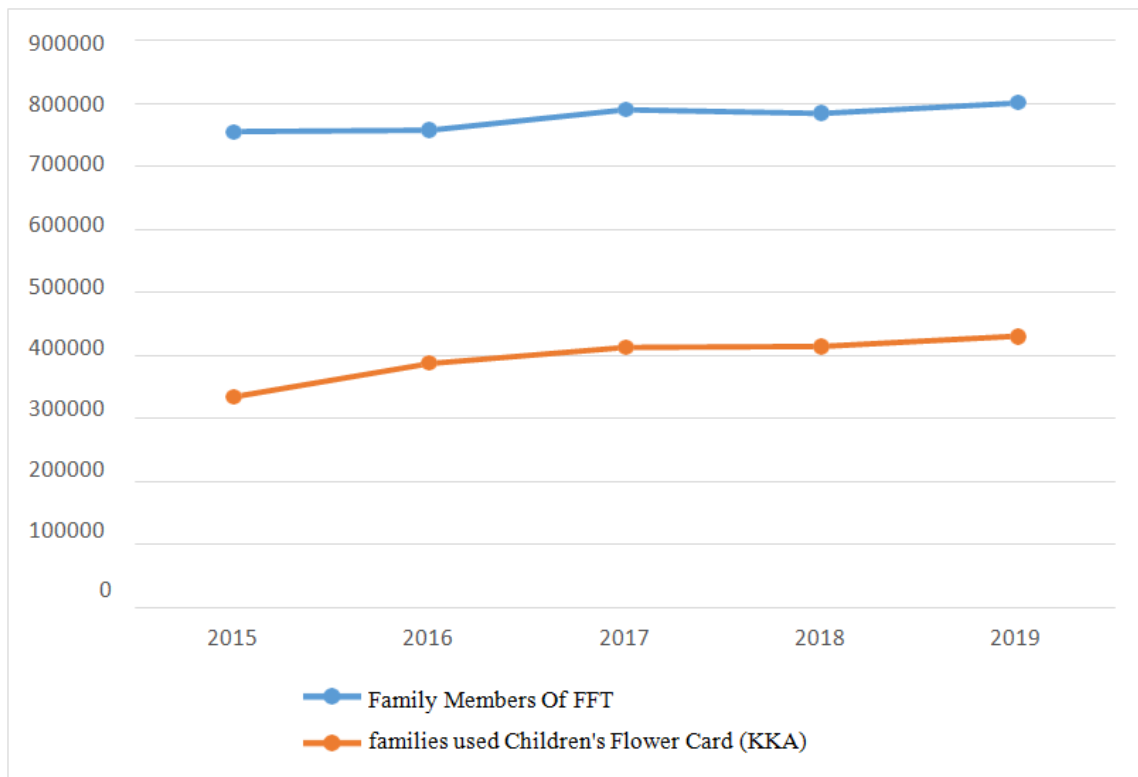
The trend of achievement decreased in 2017-2019 by 12.55% where in 2018 the number of FFT target families was 1,454,885 and that became a member of FFT a total of 784,004 which means its achievement of 53.89%, then in 2019 the number of FFT target families was 1,879,051 and who became a member of FFT numbered 800,378 which means its achievement of 42.59%. If seen from the target of KKP that is 80% per year, then FFT membership has not reached the target of 2018 (1,163,908), and in 2019 (1,503,241). The surge in family participation trends following FFT can be due to the declining number of coaches in the field, people tend to have less interest in finding knowledge and parenting skills through FFT and start relying on gadgets to find knowledge.



**Figure 3 Trends of FFT Family Attendance in East Java Meeting 2015-2019**

Based on the chart, showing that the trend from 2015-2016 increased by 1.38% where in 2015 families attended the meeting as many as 630,963 of the families who were members of the FFT as much as 754,998 which meant the achievement of 83.57%, then in 2016 the family attended the meeting as many as 642,762 of the families who became members of FFT as much as 757,142 which means its achievement amounted to 84.89%. However, there was a decrease in 2016-2019 of 1.24% where in 2017 the family attended the meeting as

many as 655,862 of the families who became members of FFT as much as 789,918 which meant the achievement was 83.03%, in 2018 the family attended the meeting of 648,325 of the families who became members of FFT as many as 784,004 which means the achievement of 82.69%, then in 2019 the family attended the meeting as many as 654,633 of the families who became members of FFT as much as 800,378 which means the achievement of 81.79%.



**Figure 4 Trends of Family Members of FFT Using KKA in East Java in 2015-2019**

Based on the chart, showing that the trend from 2015-2019 increased continuously by 9.52% where in 2015 FFT member families used Children’s Flower Card (KKA) by 334,341 of the families who became FFT members as much as 754,998 which means its achievement of 44.28%, then in 2016 the family of FFT members used KKA as much as 387,288 from families who became members of FFT as much as 757,142 which means its achievement of 51.15% , in 2017 the family of FFT members used KKA as much as 413,041 from families who became members of FFT as much as 789,918 which means its achievement of 52.29%, in 2018, the family of FFT members used KKA as much as 414,207 from families who became members of FFT as much as 784,004 which means its achievement of 52.83%, and in 2019 the family of FFT members used KKA as much as 430,575 from families who became members of FFT as much as 800,378 which means its achievement of 53.80%.

**Discussion**

The government has made various efforts to improve the quality of human resources, among others through the Integrative Holistic Early Childhood Development Program. This program is strengthened by Presidential

Regulation No. 60/2013 on Integrative Holistic Early Childhood Development. With the implementation of holistic integrative early childhood development, it is hoped that the essential needs of early childhood in its entirety including health and nutrition, stimulation of education, moral-emotional coaching, and parenting can be met<sup>(12)</sup>.

The National Family Planning and Population Board (NPFPP) also plays a role in the implementation of integrative holistic early childhood development through the Toddler Family Development (FFT) activity group. Integrative holistic early childhood development is carried out in FFT, early childhood education program Post, and integrated service post-groups. The FFT group improves the knowledge of parents and families who have toddlers regarding parenting; early childhood education program Post provides educational services to early childhood; while integrated service post provides health services for early childhood. Some of the obstacles found in the implementation of FFT, include<sup>(13)</sup>:

1. Limited number of FFT cadres, due to difficulty regeneration of workers and lack of operational support, among others: fee, etc.

2. Limited number of Family Planning Counselors (PKB) handling in the field.
3. FFT cadres who are concurrent as integrated service post cadres so that the implementation of FFT activities does not optimal.
4. Number of cadres, because between the number of cadres and the number of participants is not balanced
5. Inefficient time utilization is also a factor in inhibiting FFT program.

The pattern of child care is also inseparable from the culture of child play. In developmental psychology literature, children aged 0-6 are “good impersonators” and “tenacious learners”, but not a “good listener”(14). Children of this age will be easier to learn and understand by doing activities, not by being told or just words. Therefore, early childhood requires play activity to stimulate nerve development. According to Freud and Erikson playing for a child is very useful as a form of self-adjustment, helping the child master the anxieties and conflicts it faces(3). The game is believed to be able to relieve tension so as to help the child in solving problems and conflicts faced in his life. To realize the above, it is necessary to create a meaningful learning environment for early childhood, among others through a variety of meaningful games that are able to provide comfort for the child in learning and the right stimulation will be realized(15).

### Conclusion

The implementation of the Family Resilience Program of Toddlers and Children is outlined in the Operational Guide to the Implementation of The Resilience Program of Toddlers and Children namely the development of operational policies and strategies, formation and development of FFT groups, the development and provision of FFT Kit facilities, socialization, coaching, monitoring and evaluation of coaching and recording and reporting. FFT Group Reporting Chart shows the trend from 2015-2017 increased by 4.52% but decreased in 2017-2019 by 31.32%. However, if you look at the target of KKP 80%, then the results have not reached the target. FFT Member Participation Chart shows that the trend from 2015-2017 increased by 3.78% but decreased in 2017-2019 by 12.55%. The FFT Family Attendance graph in the Meeting shows that the trend from 2015-2016 increased by 1.38% but decreased in 2016-2019 by 1.24%, and the KKA User FFT Member Family chart shows that the trend from 2015-2019 increased

continuously by 9.52%. Although the result of the trend has decreased or increased, in the implementation of activities there are still some obstacles to be considered.

### Recommendation:

1. Improving institutional strengthening with integrative systems and efforts to prepare aspects of legitimacy such as decision letter (SK), implementation guidelines, technical instructions and so on.
2. Improving commitment, coordination and cooperation with relevant partners, stakeholders and with communities/associations/organizations related to FFT group organizing

**Conflict of Interest:** The authors have no conflict of interest with the material presented in this paper.

**Source of Funding:** None.

**Ethical Clearance:** None. This research was conducted without treating informants

### Reference

1. The Coordinating Ministry for Human Development and Culture of the Republic of Indonesia. Undang-undang no 52 Tahun 2009 tentang Perkembangan Kependudukan dan Pembangunan Keluarga. 2009;
2. National Population and Family Planning Board Indonesia. Keluarga Berencana dan Kesehatan Reproduksi. Jakarta: National Population and Family Planning Board; 2005.
3. Santrock JW. Adolescence [Internet]. McGraw-Hill; 1998. (Brown and Benchmark Series). Available from: <https://books.google.co.id/books?id=KZIEAQAIAAJ>
4. Nutbrown C, Clough P. Pendidikan anak usia dini: Sejarah, filosofi, dan pengalaman. Yogyakarta: Pustaka Pelajar. 2015;
5. Minister of National Planning Development. Pedoman Pelaksanaan Intervensi Penurunan Stunting Terintegrasi di Kabupaten/Kota. Jakarta: Minister of National Planning Development; 2018.
6. Ministry of Health. Riset Kesehatan Dasar 2018. Jakarta: Ministry of Health; 2019.
7. Ministry of Health in East Java. Health Profile in East Java 2018. 2019.
8. National Population And Family Planning Board East Java. Hasil Analisis dan Evaluasi Program

- KKBPK-Maret 2015. Surabaya: National Population And Family Planning Board East Java; 2015.
9. National Population and Family Planning Board Indonesia. Kesehatan Reproduksi. Jakarta: National Population and Family Planning Board; 2008.
  10. National Population and Family Planning Board Indonesia. Kumpulan Istilah Bidang Keluarga Berencana. Jakarta: National Population and Family Planning Board; 1984.
  11. National Population and Family Planning Board Indonesia. Pengasuhan dan Pembinaan Tumbuh Kembang Anak. Jakarta: National Population and Family Planning Board; 2009.
  12. National Population and Family Planning Board Indonesia. Buku Pegangan Kader Bina Keluarga Balita. Jakarta: National Population and Family Planning Board; 2007.
  13. Mardiyono. Model Pengelolaan Bina Keluarga Balita (BKB) Di Propinsi Jawa Timur. *Cakrawala: Jurnal Litbang Kebijakan*. 2012;6(2):184–94.
  14. Susanto A. Perkembangan Anak Usia Dini: pengantar dalam berbagai aspeknya [Internet]. Yogyakarta: Kencana; 2011. Available from: <https://books.google.co.id/books?id=qvOAAQAACAAJ>
  15. Santrock JW. Masa perkembangan anak. Jakarta: Salemba Humanika. 2011;

# Assessment Knowledge of the Patients' with Acute Renal Failure Concerning Dietary Pattern in Dialysis Unite of AL-Zahraa Teaching Hospital at AL-Kut City

Faisal Younus Sameen<sup>1</sup>, Qassim Jawell Odah Abed<sup>2</sup>, Tareq Al-Qassab<sup>3</sup>, Ashwaq Yas Khudhair<sup>4</sup>

<sup>1</sup>M.Sc. Adult Nursing, University of Kirkuk-College of Nursing, <sup>2</sup>M.Sc. Adult Nursing, AL-Kut Technical Institute-Middle Technical University, <sup>3</sup>PhD. Food Hygiene, AL-Kut Technical Institute-Middle Technical University-Iraq, <sup>4</sup>M.Sc. Biochemistry, Al-Karama Teaching Hospital, Lab. Biochemical-Ministry of Health

## Abstract

**Objectives:** To assess the knowledge of patients with acute renal failure concerning dietary pattern for kidney failure in dialysis unite in AL-Zahraa Teaching Hospital at AL-Kut City and Find out relationship between demographic data and knowledge of patient with acute kidney failure. By a non- probability sample account of (30) subjects is selected for the purpose of the present study. A questionnaire as a incomes for data gathering, it consist of two parts; include demographic data and knowledge of patients with acute renal failure concerning dietary pattern which composed of (18) items. By self-administration, data are collected from those who patients with renal failure come in dialysis unite in AL-Zahraa Teaching Hospital and analyzed through the used descriptive and inferential statistic approach. The study results indicated that the most of the participants are within married (60%), and most of them are male. In regarding level of education, they most of them formally graduation, and administrative patients, as well the subjects have chronic disease such as diabetes mellitus and find statistical high significant between level of education and knowledge of patient at p-value <0.05 with non-significant between other demographical data

**Keywords:** Assessment, renal failure, dietary pattern.

## Introduction

Acute kidney failure (AKF) is a disorder in which of therenal are incapable to eliminate waste the crops of breakdown. The disappointment of kidney purpose is quick in its start but possibly reversible. It happens speedily, within 8 wks of kidney damage subsequent in a fastrise in serum urea and creatinine courtesies in patients with beforehand standard kidney purpose<sup>(1)</sup>.It is a disorder usually associated with a high humanity rate, often due to the glitches of sepsis, latecoiled healing and troubledhaemocoagulation. Survivability has been recognized to be better by early suitable nutritional support<sup>(2)</sup>. Although in repetition this is

often problematic to achieve as nutritional support is multifaceted. In the past high disease and humanity rates were connected to infections and inadequate dietary intake. This resulted from unnecessary protein restrictions in an attempt to control uremicindications<sup>(3)</sup>. To a large degree survivability of acute renal failure has still not been prominently improved even with contemporary antibiotics and the careful nourishing valuation of acute renal disappointment patients. This reflects the difficulty of managing patients with this disorder. Though, appropriate nutritional management of ARF patients is essential to recover their long-term forecast<sup>(4)</sup>. Although the precise form this takes remains a contentious issue between clinicians. The nourishment of kidney patients varies and their effect on the progress of the patient's disorder according to the stage in which the illness has been industrialized, we find that nutrition has a protective role and mitigation of the following symptoms if the kidney failure in the early stage.<sup>(5)</sup> Should decrease the quantity of protein, as Urea is the

---

### Corresponding Author:

Faisal Younus Sameen

M.Sc. Adult Nursing, University of Kirkuk-College of Nursing

creation produced by the breakdown of proteins in the body and upsurge the volume of protein in the body leads to increased effect on the kidneys, and consequently it is recommended to decrease the amount of protein in the diet rendering to the patient's condition.

### Methodology

**Study Objectives:** To assess the knowledge of patients' with acute renal failure concerning dietary pattern for kidney failure in dialysis unite in AL-Zahraa Teaching Hospital at AL-Kut City

Find out relationship between demographic data and knowledge of patient with acute renal failure about dietary pattern

**Study design :**A descriptive study, using assessment method, is carried out to assess the knowledge of patients' with acute renal failure concerning dietary pattern for kidney failure in dialysis unite for AL-Zahraa Teaching Hospital at AL-Kut City. A non-probability simple random account of (30) patients who comes for dialysis. A questionnaire as resources of data collection was constructed for the purpose of study. It consisted from two parts, include:

**Part I:** This part contains demographical data which include (gender, address, marital status, level of education, chronic disease, and period of diagnosis).

**Part II:**this part about knowledge of patients with ARF concerning dietary pattern which composed from (18) items and answered on the question by Yes, or No, take time for each one (10-15) minute

**Data analysis:** Complete the used descriptive statistical (SPSS) form(21) analysis tactic that includes, frequencies, percentages, cruel of scores, standard divagation and graphical presentation of data; and inferential statistical data analysis approach that comprise ANOVA test.

### Result and Discussion

Results signify the distribution of the patients' demographic items in term of frequencies and percentage. The **Table (1)** statistical analysis find patient with renal failure specific acute kidney failure have low level of knowledge concerning dietary pattern except questions (4, 5, 6, 7, 11.15, 16, 17) due to mean score for this results in high level (1.81-2) these result agree with <sup>(6)</sup> them study knowledge on dietary group among long-lasting renal disappointment patients experiencing hemodialysis at selected hospital, Kanchipuram. And find patient with chronic renal failure have knowledge deficiency concerning dietary management for renal failure and disagree with <sup>(7)</sup> he which studythat Assessment of the effectiveness of structured teaching package on knowledge regarding nutritionalorganization and casing care in renal failure among patients experiencing hemodialysis and find high level of knowledge for patients with chronic renal failure toward nutrition management. Regarding **Table (3)** this table shows that there is statistical significant association between patient' educational level and their knowledge concerning dietary pattern for renal failure (p value < 0.05) when analyzed by ANOVA. There is No statistical significant association between nurses' (other demographic data) and their knowledge concerning dietary pattern for renal failure and agreement with <sup>(8)</sup> A study to assess the knowledge and practice regarding dietary management of patients from rural area with end stage of renal disease undergoing hemodialysis in a selected hospital at Mysore. Find connection between patient knowledge and practice regarding nutrition management for end stage renal disease and level of education. Disagreement with<sup>(8)</sup> he study is Aevocative study to assess the information on dietary running among chronic renal dissatisfaction patients undergoing hemodialysis, he find non-significant between knowledge of patients with chronic renal failure <sup>(9,10)</sup>.

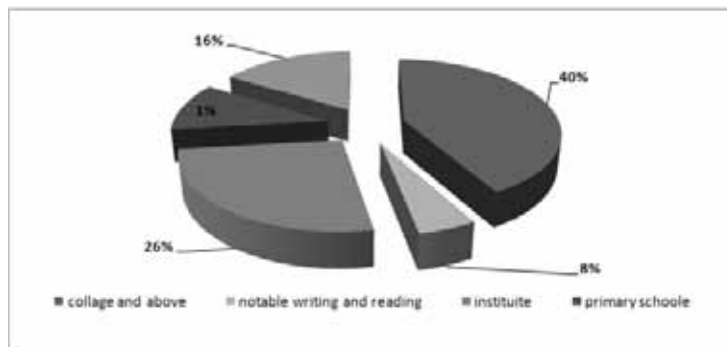
**Table (1): Distribution patient with acute renal failure knowledge concerning dietary pattern for kidney failure in dialysis unite**

N	Variables	Yes answer		No answer		M.S	Ass.
		f	%	f	%		
1	Did you know that renal insufficiency is a term used in the case of failure of the kidneys to perform its functions	13	44.0	17	56.0	1.57	L
2	Did you know that urea is the toxins in the body that are thrown through the kidneys	12	40.0	18	60.0	1.60	L



N	Variables	Yes answer		No answer		M.S	Ass.
		f	%	f	%		
3	Did you know that the main symptoms of acute kidney failure are lack of urination, body buildup and high blood pressure	10	24.0	20	66.0	1.67	M
4	Did you know that dialysis is not a cure for renal failure, but is to reduce the toxins in the body and the transplant is the ultimate treatment	6	20.0	26	80.0	1.80	M
5	Did you know that adherence to a healthy diet reduces the damage of kidneys, especially patients with acute renal failure?	5	16.0	25	84.0	1.83	H
6	Did you know that the diet for patients with renal failure differs from the diet of healthy people	4	13.0	26	87.0	1.87	H
7	Did you know that diet is an important part of the treatment plan and to develop a diet suitable for the patient of renal failure in accordance with the health status of the patient	9	30.0	21	70.0	1.87	H
8	Do you avoid foods that contain high water content such as soup, grapes, watermelon, lettuce, tomatoes, celery	13	44.0	17	56.0	1.57	L
9	Do you avoid salty foods that increase your drinking water?	6	20.0	24	80.0	1.80	M
10	Do you avoid foods that contain vitamin A? Now it increases the calcium and fat deposits in the body	7	23.0	23	77.0	1.80	M
11	An increase in salt intake causes fluid retention, so sodium should be reduced in the diet because it helps control high blood pressure and prevents the body from holding fluids.	3	10.0	27	90.0	1.91	H
12	Reduces phosphorus-containing foods such as milk, meat, poultry, nuts and pulses because the increase in phosphorus leads to a lack of calcium in the body, leading to a lack of bone building	6	20.0	24	80.0	1.80	M
13	Did you know eating large amounts of milk, vegetables and fish increases the amount of calcium that your body needs to build muscle	17	56.0	13	44.0	1.77	M
14	Did you know that increasing the rate of potassium in the body is a danger should avoid some foods such as potatoes, banana, apricot, orange, kiwi and dried fruits such as raisins	6	20.0	24	60.0	1.80	M
15	You take the appropriate water of protein useful for the body was found in white meat	2	7.0	28	93.0	1.93	H
16	Avoid foods that contain spices, especially canned foods, because they contain sodium salts that build up fluids in the cells of the body	5	16.0	25	84.0	18.3	H
17	Avoid protein from nuts, seeds, peanut butter, dried peas, beans, and lentils because they contain a high percentage of potassium and harmful calcium to the body	3	10.0	27	90.0	1.91	H
18	Exercise with adherence to diet reduces kidney damage	4	13.0	26	87.0	1.87	H

F: Frequency, P: Percentage, M.S: Mean of score, Asses = Assessment level, low (1-1.60) = L, moderate (1.61-1.80) = M, high (1.81-2) = H



**Figure (1) Show distribution between level of education for patient' with acute renal failure and knowledge about dietary pattern**

**Table (2): Relationship between demographical data and knowledge of patient concerning dietary pattern**

Level of education	M.S.+S.D.
Knowledge of patients	
Notable read and write	1.25 + 0.442
Able to read and write	1.31+0.471
Primary school	1.28+0.458
Secondary school	1.36+0.488
Institute	1.50+0.511
Collage and above	1.44+ 0.506

\*F: 1.088 \*d.f.: 2 \*p. value : 0.346

### Conclusion

The study concludes that more of the patients who come to dialysis unit in AL-Zahraa Teaching Hospital in AL-Kut City have low level of knowledge concerning dietary pattern that related to renal failure specific patients characterized by short period of diagnosis and low level of education

**Recommendation:** Study recommendation is established education program for teaching and increase patients knowledge concerning dietary pattern for renal failure and makes vide and poster with booklets which includes definitions the renal failure and nutrition management for kidney failure

**Ethical Clearance:** Permission from dialysis unite, in Al-Zahraa directorate was attained before starting the study. All the participants gave verbal consent with confidentiality of participants' identification

**Conflict of Interest:** Nil

**Source of Funding:** Nil

### References

1. R. Manjunatha. A study to assess the knowledge and practice regarding dietary management of patients from rural area with end stage of renal disease undergoing hemodialysis in a selected hospital at Mysore. Cauvery college of nursing Mysore; 2017. Cited on: N0: 5- 6148-16.
2. Srinivasan K. A descriptive study to assess the knowledge on dietary management among chronic renal failure patients undergoing hemodialysis at selected hospital, Kanchipuram. Department of medical surgical nursing. Awadhmadhav college of nursing sciences and research, Gwallor: PID=2014-2-3-13
3. Pamidi S, Tasali E. Obstructive sleep apnea and type 2 diabetes: is there a link? *Front Neurol.* 2012;3:126. Available from: <http://www.ncbi.nlm.nih.gov/pubmed/23015803>
4. Kosseifi S, Bailey B, Price R, Roy TM, Byrd RP, Peiris AN. The association between obstructive sleep apnea syndrome and microvascular complications in well-controlled diabetic patients. *Mil Med [Internet].* 2010 ,175(11):913–6. Available from: <http://www.ncbi.nlm.nih.gov/pubmed/21121505>
5. Blakeley, Sara (2010). *Renal Failure and Replacement Therapies.* Springer Science & Business Media. p. 19. ISBN 9781846289378.
6. Bostrom, M.A.; Freedman, B.I. (2010). "The Spectrum of MYH9-Associated Nephropathy". *Clinical Journal of the American Society of Nephrology.* 5 (6): 1107–13. DOI:10.2215/CJN.08721209. PMC.
7. Ricci, Zaccaria; Ronco, Claudio (2012). "New insights in acute kidney failure in the critically ill". *Swiss Medical Weekly.* 142: w13662
8. Fadem, Stephen Z., M.D., FACP, FASN. *Calculators for Health Care Professionals.* National Kidney Foundation. 2008. 13.
9. Charles RF, Powe NR, Jaar BG, Troll MU, Parekh RS, Boulware LE. Clinical testing patterns and cost implications of variation in the evaluation of CKD among US physicians. *Am J Kidney Dis.* 2009;54(2):227–237.
10. Whaley-Connell A, Sowers JR, McCullough PA, Roberts T, McFarlane SI, Chen SC, Li S, Wang C, Collins AJ, Bakris GL. KEEP Investigators: Diabetes mellitus and CKD awareness: the Kidney Early Evaluation Program (KEEP) and National Health and Nutrition Examination Survey (NHANES) *Am J Kidney Dis.* 2009; 53(4 Suppl 4):S11–S21.

# Assessment of Women's Knowledge and Practices toward Family Planning at Maternity Hospitals in Baghdad City

Fatima Fadel Benyian

Assistant Instructor, Maternal and Neonatal Nursing Department, College of Nursing, University of Baghdad

## Abstract

Family planning is the decision that couples make about if they want to have children, when, how many children, and how they are spaced. Knowledge is necessary to make decisions and know how to avoid conception. Some couple needs counseling because contraception has failed.

**Objectives:** To assess women's knowledge and practices about family planning and find out the association between women's knowledge and practices with some study variables.

**Method:** Descriptive study was conducted from October 2019 to March 2020 at maternity hospitals in Baghdad city. Non probability (purposive sample) was used to collect the data from (79) women who attending outpatient clinics at maternity hospitals in Baghdad city. A questionnaire was designed by the researcher. A pilot-test is conducted in order to determine the reliability of the questionnaire in a sample of (20) women who were excluded from the study sample. Data was analyzed through the use of SPSS version 20.

**Results:** The results revealed that the highest percentage (49.4%) of women's age was (30-39) years. More than two third of them (69.6%) are graduated from college. The higher percentages (63.3) have knowledge and (58.2%) used a family planning method. There are no statistical significant differences between women's knowledge and practice.

**Conclusion:** This study finds that the women have knowledge and used a family planning method, but there are no significant differences between women's knowledge and practices.

**Recommendations:** Based on study findings the source of knowledge from the internet and they choose a type of family planning based on family and friends advice so the researcher recommend to activate the role of health care professional especially doctors and nurses to provide scientific knowledge and counseling to couples to choose the most appropriate method.

**Keywords:** Knowledge, Practices, Family Planning Method, Women.

## Introduction

Family planning is so important that many national health goals speak directly to this area of care. Intentional pregnancy is important for a child's health, because unintended or misused pregnancy leads to short-term and long-term consequences such as a low rate of antenatal care visit, breastfeeding, and may be less eager to protect her fetus from harmful substances. A child of unintended pregnancy is at greater risk of low birth weight, dies in the first year, being abused, and

does not receive sufficient resources for healthy growth and development<sup>[1]</sup>.

Having children is one of the most important roles and performance of a woman, however, for a physiological process; pregnancy is an unexpected, unpleasant, unplanned and high risk and can cause disability and death<sup>[2]</sup>.

Family planning deals with the woman's reproductive health, adequate birth spacing, avoiding

unwanted pregnancies and abortions, preventing sexually transmitted diseases, and improving the quality of life of the mother, fetus and family as a whole<sup>[3]</sup>.

A woman's decision to use family planning method and choosing the method are affected by several complex psychosocial and structural factors, including contraceptive beliefs, negotiation ability with partner about using a contraceptive method, and access to services of reproductive health. Knowledge is an important factor that affects decision making for using a contraceptive method<sup>[4]</sup>.

Globally, perinatal mortality about (40%) of infant mortality yearly, resulting in about three million stillbirths and four million neonatal deaths. Perinatal mortality rate is high in low-income countries, with an average (50 deaths/1000 live births), compared with (ten deaths/1000 live births) in high-income countries. Family planning has been shown that reduce maternal and infant mortality, however contraceptive use in many resource-limited countries <sup>[5]</sup>.

Family Planning services in Iraq need more efforts to be improved, as the indicators include: Modern Contraceptive Prevalence Rate (28%), unmet needs (22%), Adolescents Birth Rate (60%), and unwanted pregnancies (12%). Total Fertility Rate is (4.6) live births per woman and population growth Rate three percent. From above, it's clear that indicators negatively affecting the women and family health and also the development plans<sup>[6]</sup>.

## Materials and Method

Descriptive analytic study design was conducted among women attending outpatient clinics at maternity hospitals to assess their knowledge and practices about family planning. The study was performed from October 2019 to March 2020 at maternity hospitals in Baghdad city. Non probability (purposive sample) used to collect the data from (79) women. A questionnaire was designed by the researcher to assess women's knowledge and practices about family planning. A pilot study conducted in order to determine the reliability of the questionnaire in a sample of (20) women who excluded from the study sample ( $r=0.85$ ). Content validity was determined through a panel of (8) experts their experience mean and SD was  $26.6 \pm 5.5$ . The data was collected after obtaining the agreement from women to participant in this study. The study instrument was consisted of three parts which include: Socio demographic characteristics, women's

knowledge about family planning and women's practices about family planning. Data are analyzed through the use of SPSS (Statistical Process for Social Sciences) version 20.

## Results

**Table (1): Distribution of Study Sample According to Socio-demographic Characteristics**

Socio Demographic Characteristics	F	%
<b>Age/years</b>		
< 20	1	1.3
20-29	21	26.6
30-39	39	49.4
40-49	18	22.8
<b>Total</b>	<b>79</b>	<b>100</b>
<b>Mean=33.94 SD=6.2</b>		
<b>Duration of marriage/years</b>		
1-5	23	29.1
6-10	34	43.0
11-15	11	13.9
16-20	7	8.9
> 21	4	5.1
<b>Total</b>	<b>79</b>	<b>100</b>
<b>Mean=8.7 SD=5.7</b>		
<b>Age of last child/years</b>		
1-4	63	79.7
5-8	11	13.9
9-12	5	6.3
<b>Total</b>	<b>79</b>	<b>100</b>
<b>Mean=4.3 SD=7.1</b>		
<b>Educational level</b>		
Secondary School	6	7.6
Institute graduate	17	21.5
College graduate	55	69.6
Master and higher	1	1.3
<b>Total</b>	<b>79</b>	<b>100</b>

This table illustrates that the highest percentage (49.4%) of women's age were (30-39) years. Regarding duration of marriage the higher percentage (43%) of them were (6-10) years. Regarding educational level more than half of them (69.6%) were graduated from college.

**Table (2) Women's Knowledge about Family Planning Method**

No.	Item	Know		Don't know		MS	RS	Ass
		F	%	F	%			
A	<b>Family planning method</b>							
1	Complex Contraceptive Pills	62	78.5	17	21.5	1.78	89	H
2	Mini Pills	33	41.8	46	58.2	1.41	70.5	L
3	Types of Contraceptive Injection	34	43	45	57	1.43	71.5	L
4	Intrauterine devices	44	55.7	35	44.3	1.55	77.5	M
5	Male Condom	52	65.8	27	34.2	1.65	82.5	M
6	Female condom	45	57	34	43	1.56	78	L
7	Tubal Ligation	54	68.4	25	31.6	1.68	84	M
8	Vasectomy	52	65.8	27	34.2	1.65	82.5	M
B	<b>Ideal pregnancies spacing</b>	36	45.6	43	54.4	1.45	72.5	L
	<b>Total</b>	<b>50</b>	<b>63.3</b>	<b>29</b>	<b>36.7</b>	<b>1.63</b>	<b>81.5</b>	<b>M</b>

(M.S) mean score (R.S) relative sufficiency (Ass.) assessment (Low= $\geq 75$ ), (Moderate= 75.1-87.5), (High= 87.6-100)

This table shows that there are a low level of relative sufficiency and mean score regarding items No.(2,3), while there are a high level of relative sufficiency and mean score regarding items No. (1). Also there are a low level of relative sufficiency and mean score regarding items No. (B). Also the total knowledge relative sufficiency and mean score is moderate level.

**Table (3) Women's Sources of Knowledge about Family Planning Method**

No.	Item	F	%
1	Doctor	16	20.3
2	Nurse	2	2.5
3	Internet media	27	34.2
4	Experience	4	5
5	Reading	12	15.2
6	Friend and Family	18	22.8
	<b>Total</b>	<b>79</b>	<b>100</b>

This table illustrates that the highest percentage (34.2%) of women's sources of knowledge were from the internet and media.

**Table (4) Women's Practices toward Family Planning Method**

No.	Item	F	%
A	<b>Type of family planning</b>		
1	Natural Family planning method	4	5.1
2	Contraceptive Pills	7	8.9
4	Injection	1	1.3
5	Intrauterine devices	19	24.1
6	Male Condom	13	16.5
7	Female condom	1	1.3
8	Tubal Ligation	1	1.3
	Didn't use	33	41.8
B	<b>Women choose type based on</b>		
1	Doctor	11	10.1
2	Couple	7	8.9
3	Experience	1	1.3
5	Family and Friends	27	34.2
6	Didn't use	33	41.8
	<b>Total</b>	<b>79</b>	<b>100</b>

This table shows the highest percentage (24.2%) of women who used a family planning chooses Intrauterine devices, and their choice was based on Family and Friends.

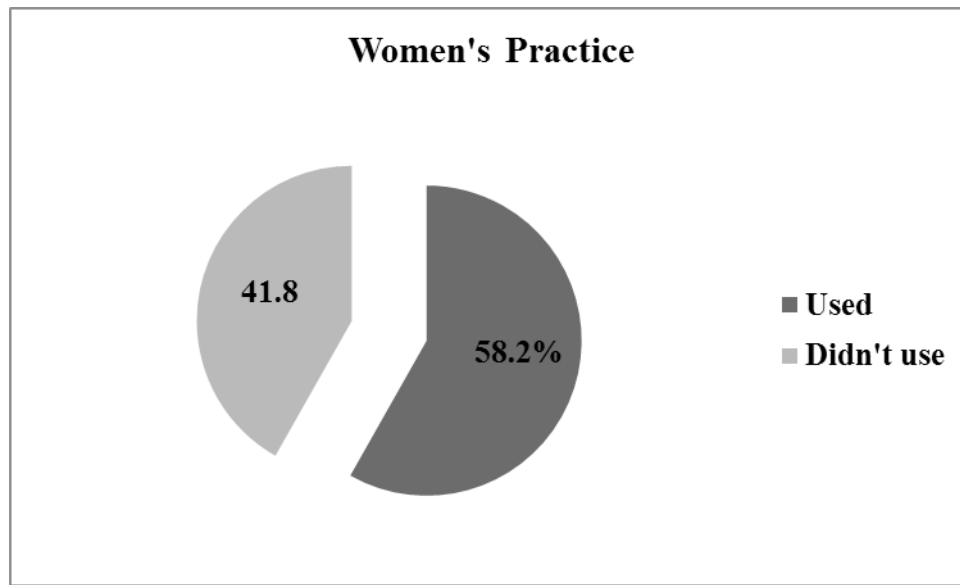


Figure (1) Women’s Practice toward Family Planning Method

Table (5): Association between Women’s Knowledge and Practices with Socio-Demographic Variables

Women’s Knowledge		Know		Don’t know		Chi square statistics			Sig.
		F	%	F	%	Value	df	P-value	
Women’s Practice		30	60	16	55.2	.176	1	.67	Ns
Used		20	40	13	44.8				
Women’s Knowledge		Know		Don’t know		Chi square statistics			Sig.
Socio-demographic variables		F	%	F	%	Value	df	P-value	
Age/years	< 20	1	2	0	0	2.8	3	.41	Ns
	20-29	12	24	9	31				
	30-39	23	46	16	55.2				
	40-49	14	28	4	13.8				
Educational level	Secondary School	2	4	4	13.8	4.4	3	.21	Ns
	Institute graduate	11	22	6	20.7				
	College graduate	37	74	18	62.1				
	Master and higher	0	0	1	3.4				
Women’s Knowledge		Used		Didn’t use		Chi square statistics			Sig.
Socio-demographic variables		F	%	F	%	Value	df	P-value	
Age/years	< 20	0	0	1	3	4.6	3	.2	Ns
	20-29	9	19.6	12	36.4				
	30-39	26	56.5	13	39.4				
	40-49	11	23.9	7	21.2				
Educational level	Secondary School	5	10.9	1	3	3.1	3	.37	Ns
	Institute graduate	9	19.6	8	24.2				
	College graduate	32	69.6	23	69.7				
	Master and higher	0	0	1	3				

(df) degree of freedom, (Sig) significant Probability value (P < 0.05), (NS) Non Significant, (s) significant.

This table shows that there are no statistical significant between women's knowledge and practice with socio-demographic variables toward family planning method

## Discussion

The findings of current study show about half of women's age were (30-39) years, more than one third married for (6-10) years, their last child's age was (1-4 years). Regarding educational level more than two third was graduated from college.

Agha and Rasheed stated that Iraq, like some other developing countries, people have still appreciates early marriage, large families and a role for woman in the home. In addition, the previous Iraqi government, especially in the 1980s, encouraged high fertility to compensate for casualties during its wars. Until the middle of the past decade, the Iraqi Ministry of Health neglected family planning in the country. This explains why the crude birth rate in Iraq was one of the highest in the world in the late 1980s and early 1990s. At the time of their study, health services in Iraq, including family planning, were almost free in government clinics, when these were available, but not all family planning method were available in family planning clinics. Therefore, for many mothers, the sources of family planning services were private clinics and pharmacies due to the limited services<sup>[7]</sup>.

The current study found more than half of study sample have knowledge about family planning method, while they didn't know the ideal pregnancies spacing. This might be due to most of the study sample were graduate from college so they think in family planning are useful to be economically, self-sufficient and more likely to acquire greater confidence and personal control in marital relationships including the discussion of family size and contraceptive use. More than third of their source of knowledge were from the internet, and second higher percent from family and friends. This finding supported with a study who found more than third (42.3%) of study participants had good knowledge, and (50.4%) had good practice towards family planning<sup>[3]</sup>. another study reported that the higher percentage (45%) of the women's source of information was from media, followed by (15%) from internet/friends and relatives and ten percent from health professionals. This study finding also is consistent with a study who found (70%) had gained knowledge of contraception from friends and

relatives and (39%) from TV and radio<sup>[9-10]</sup>.

Women's decision making to use contraceptive method is affected by many factors including knowledge gained from various sources. Blackstock and colleagues found that the role of the social network regarding family planning generally to provide women contraceptive information and particularly to guide women to a specific contraceptive method. They found that the knowledge gained from health care providers especially social network members often enhanced or clarified their knowledge gained from other informal sources, <sup>[4]</sup>.

This study found more than half of study participant were use a family planning method, they choose intrauterine device and male condom as a higher percent. They choose the method based on advice from their family and friends.

The condom use was high rate compared to neighboring countries; this may be due to the free availability of condoms in Dohuk. However, similar rates of condom use have been reported in Iraq and the Islamic Republic of Iran and among Palestinian refugees<sup>[7]</sup>.

Many women want to delay pregnancy and avoid STIs, as options are difficult. There are many method available today, and more will be offered in the near future. The ideal method of contraception for many women should have the following characteristics: ease of use, safety, efficacy, minimal side effects, "nature", non-hormonal method, and immediate reversal. Currently, no single method of contraception offers everything <sup>[8]</sup>.

## Conclusion

This study revealed that more than half of study sample have knowledge about family planning method and they used a family planning method. The most common type of family planning was intra uterine device. There are no statistical significant differences between level of knowledge and women's age or educational level. There are no statistical significant differences between women's knowledge and practice; also there are no statistical significant differences between women's knowledge and practice with socio-demographical variables.

**Recommendation:** This study findings shows the most women's source of knowledge from the internet and most of them choose a type of family planning based on

family and friends advice so the researcher recommend to activate the role of health care professional especially doctors and nurses to provide scientific knowledge and counseling to couples to choose the most appropriate method.

**Funding:** This research was funded by Author. Moreover, I would like to thank all the women who participated in this study and pay tribute to them for their supporting this project.

**Conflict of Interest:** None declared

**Ethical Approval:** Not required

### References

1. Pillitteri, A.: Maternal and Child health Nursing: Care of the Childbearing and Childrearing Family, 6<sup>th</sup> ed., Lippincott Williams & Wilkins Publishers, Philadelphia, 2010, 118-139.
2. Hamed, Z. F.; El-gazzar, A. F.; Mofteh, F. M.: Knowledge, Attitude and Practice of Family Planning Method among Husbands in a Village of Assiut Governorate, *The Egyptian Journal of Hospital Medicine*, 2018, 73(4), 6489–6493.
3. Semachew Kasa, A.; Tarekegn, M.; Embiale, N.: Knowledge, attitude and practice towards family planning among reproductive age women in a resource limited settings of Northwest Ethiopia, *BMC Research Notes*, 2018, 11(577), 1-6. <https://doi.org/10.1186/s13104-018-3689-7>
4. Blackstock, O. J.; Mba-Jonas, A.; Sacajiu, G. M.: Family planning knowledge: The role of social networks and primary care providers as information sources for African American women, *American Journal of Sexuality Education*, 2010, 5(2), 128-143. <https://doi.org/10.1080/10627197.2010.491060>.
5. Kopp, D. M.; Bula, A.; Maman, S.; Chinula, L.; Tsidya, M.; Mwale, M.; Tang, J. H.: Influences on birth spacing intentions and desired interventions among women who have experienced a poor obstetric outcome in Lilongwe Malawi: A qualitative study. *BMC Pregnancy and Childbirth*, 2018, 18(1), 1–11. <https://doi.org/10.1186/s12884-018-1835-9>
6. United Nations reproductive health agency (UNFPA), 2014, Available from <https://iraq.unfpa.org/en/news/strengthening-and-scaling-family-planning-services-iraq>
7. Agha, S.; Rasheed, B.: Family planning and unmet need among Iraqi Kurds, *Eastern Mediterranean Health Journal*, 2007, 13(6), 1328-1390.
8. Ricci, S., Kyle, T.: Maternity and pediatric nursing, 2nd edition, Lippincott Williams & Wilkins, Philadelphia, 2013, 108.
9. Qazi, M.; Saqib, N.; Gupta, S.: Knowledge, attitude and practice of family planning among women of reproductive age group attending outpatient department in a tertiary centre of Northern India. *International Journal of Reproduction, Contraception, Obstetrics and Gynecology*, 2019, 8(5), 1775. <https://doi.org/10.18203/2320-1770.ijrcog20191531>
10. Srivastava R; Srivastava DK; Jina R; Srivastava K; Sharma N, Sana S.: Contraceptive knowledge, attitude and practice (KAP Survey). *J Obstet Gynecol India*, 2005, 55(6), 546-550.



# Regulation of Law Enforcement in Prevention and Handling of Fire Forests in Environmental Hazards

Fatma Ulfatun Najicha<sup>1</sup>, I Gusti Ayu Ketut Rachmi Handayani<sup>1</sup>, Lego Karjoko<sup>1</sup>

<sup>1</sup>Faculty of Law, Sebelas Maret University, Surakarta, Indonesia

## Abstract

Forest is an ecosystem that provides oxygen, wood and a place to live for a variety of flora and fauna and places where interactions between plants (flora) and animals (fauna) are present. But in its development, environmental pollution carried out by most humans that can cause environmental damage, especially forests continue to occur with a variety of motives and types. Environmental damage is getting worse. This condition has directly threatened the life of ecosystems in the forest. One example of forest destruction by human activity is exploitation of natural resources by burning the forest. Forest fires have a wider impact on society, both local, national and international communities. Areas of Indonesia that have many forests with variations in community behavior are quite prone to fires. Knowledge about natural phenomena in the form of forest fires does need to be disseminated to the community. This is important, in order to avoid the impact of the danger caused by the fire.

**Keyword:** Law, Forest, Fire, Environmental Hazards.

## Introduction

Forest is an ecosystem that provides oxygen, wood and a place to live for a variety of flora and fauna and places where interactions between plants (flora) and animals (fauna) are present. Forests also have natural resource potential including teak, meranti wood, sandalwood, acacia wood, fruits, honey, rubber, spices, rattan, sago, and others.

The importance of these resources is increasing because forests are a source of livelihood for many people.<sup>1</sup> In Law Number 41 Year 1999 concerning Forestry, it is stated in Article 1 number 2 which reads: "Forest is a unified system in the form of an expanse of biological natural resources dominated by trees in their natural environment, which cannot be separated from one another".<sup>2</sup>

But in its development, environmental pollution carried out by most humans that can cause environmental damage, especially forests continue to occur with a variety of motives and types. Environmental damage is getting worse. This condition has directly threatened the life of ecosystems in the forest. One example of forest destruction by human activity is exploitation of natural resources by burning the forest.

Forest and land fires basically can occur due to two factors namely, natural factors and human activity factors either intentional or unintentional. Although there is a natural factor in the form of El Nina that hits Indonesia every year, forest and land fires caused by natural processes are very small and rare events. This is due to the type of natural forests in Indonesia that fall into the category of tropical forests or wet rain forests so that the forest floor is always wet/moist. Conversely, 99% of forest fires are caused by human activity, both intentionally and unintentionally. Only 1% of them occur naturally.<sup>3</sup>

---

### Corresponding Author:

**Fatma Ulfatun Najicha**

Faculty of Law, Sebelas Maret University, Surakarta, Indonesia

e-mail: fatmanajicha\_law@staff.uns.ac.id

Knowledge about natural phenomena in the form of forest fires does need to be disseminated to the community. This is important, in order to avoid the impact of the danger caused by the fire. Even though

forest fires are often called pure natural disasters, lately there has been a lot of human intervention in them. Thus, the discussion of the forest fire event widened by involving the phenomenon of social behavior. Forest fires have a wider impact on society, both local, national and international communities. Areas of Indonesia that have many forests with variations in community behavior are quite vulnerable.

## Literature Review

### Environmental Legal Theory Review

**Definition of the Environment:** The environment is a unity of space with all objects, power, conditions, and living things, including humans and their behavior, which affect nature itself, the survival of life, and the welfare of humans and other living things.<sup>4</sup>

**Definition of Forest:** According to forestry expert Dengler the definition of forest is a number of trees that grow on a large enough field so that temperature, humidity, light, wind, and so on no longer determine the environment, but are influenced by vegetation or new trees as long as they grow in a wide enough place and the growth is quite dense (horizontal and vertical).

According to Spurr the forest is considered as an alliance between plants and animals in a biotic association. This association together with its environment forms an ecological system where organisms and the environment influence each other in a complex energy cycle. The understanding of forests for scientists varies greatly according to scientific specifications. For example silvikur experts will provide a different understanding of the forest with forest management experts or ecologists.

Meanwhile, according to Law No. 41 of 1999 concerning forestry, forestry is a management system that has to do with forests, forest areas, and forest products that is held in an integrated manner.<sup>5</sup> Forest is an ecosystem unit in the form of a stretch of land containing biological natural resources which is dominated by trees in their natural environment, which cannot be separated from one another.<sup>5</sup> Forest area is a certain area designated and/or determined by the Government to be maintained as a permanent forest.<sup>5</sup>

## Method

The method used through literature review, from several journals which later the author uses as a basis, comparison, and complement to conduct a review in the

field of Living Environment Law.

## Result and Discussion

**Ways to Prevent and Handle Forest Fires:** Carter (2008) explains that in disaster management activities, pre-disaster aspects must be taken seriously. He divided into three activities namely (1) preventive, (2) mitigation, (3) preparedness. Maximizing all of these stages will determine success in preventing disasters.<sup>6</sup>

**1. Preventive aspects:** Preventive is an effort made so that disasters do not occur. Preventive activities that can be carried out are as follows:

1. Dissemination to the public, companies and all relevant parties that have the potential for forest fires.
2. Education and Counseling. Practically education and counseling is carried out by the leading elements of the task force institutions namely Babinsa, Village Officials, Agricultural Extension Officers, and SKPD.
3. Publication/Opinion through mass media. In addition to socialization and other actions, the task force by cooperating with various related parties continued to make publicity efforts about the dangers of the act of burning the forest either in the form of writing in print or in the mass media.

**4. Technological innovation.** Technological innovation, is specialized in the creation of certain technologies to support forest fire prevention efforts. This is based on the consideration that what is faced when forest fires are land conditions, weather, fire and human behavior.

**2. Mitigation Aspects:** Mitigation is an effort to minimize the impact of disasters. Some mitigation actions taken are:

1. Data collection and recording. This is intended to determine the distribution and potential risk of disasters, so that efforts can be made to minimize the impact that occurs.
2. Routine Patrol. Routine patrol activities are actions carried out by the task force on locations that are allegedly having the potential for forest fires. This patrol is carried out jointly, both from the task force and the community.

**3. Preparedness:** Preparedness is a quick step that

must be taken to respond to a disaster. Some important things to do are:

1. Establish the Governor's Decree regarding the determination of the Task Force.
2. Conducting efforts to synchronize the task force's work program with other institutions in the task force's unit.
3. Establishment of Forest Fire Management Command Posts. The number of posts is adjusted to the existing area.
4. Construction of bore wells as a source of water for fire fighting.
5. Complementary infrastructure facilities to overcome forest fires.

Law Enforcement Arrangements in the Prevention and Handling of Forest Fires in Terms of Law Number 32 Year 2009 Regarding Environmental Protection and Management in Indonesia

Enforcement of environmental law is closely related to the ability of the apparatus and the community's compliance with applicable regulations. The following are some of the means of environmental law enforcement:<sup>7</sup>

- a. Administrative Law Enforcement Facilities. The UUPPLH contains four types of administrative legal sanctions as stated in Article 76 paragraph (2), namely, administrative sanctions consisting of: Written reprimand, Government coercion, Freezing of environmental permits, and Revocation of environmental permits.
- b. Means of Civil Law Enforcement. Civil law instruments can be used in the event of an environmental dispute arising from allegations of pollution and/or environmental damage. Enforcement of environmental law through civil law can be pursued through two channels, namely:

**Court Track:** Settlement of disputes through the courts is regulated in Article 87 to Article 92 UUPPLH-2009, namely to demand compensation and environmental restoration. There are several principles that must be considered by the panel of judges in examining the resolution of environmental disputes through the courts as formulated in Article 87 of the UUPPLH as follows: that causes harm to others or the environment is obliged to pay compensation and/or

carry out certain actions. (2) Every person who carries out the transfer, alteration of the nature and form of business, and/or activities of a business entity that violates the law does not relinquish legal responsibilities and/or obligations of the business entity. (3) The court may determine forced payment of money on any late day for the implementation of court decisions. (4) The amount of forced money is decided based on statutory regulations.<sup>8</sup>

**Out-of-court Paths:** In Law No. 32 of 2009 concerning Environmental Protection and Management of the settlement of environmental disputes outside the court regulated in Article 85 states:<sup>9</sup>

**1. Settlement of environmental disputes outside the court is carried out to reach agreement on**

- (a) The form and amount of compensation,
  - (b) Recovery actions due to pollution/damage,
  - (c) Specific actions to guarantee that pollution/or destruction will not recur, and/or
  - (d) Actions to prevent negative impacts on the environment.
2. Settlement of disputes outside the court does not apply to environmental crimes as regulated in this Law.
  3. In the settlement of environmental disputes outside the court, the services of mediators and/or arbitrators can be used to help resolve environmental disputes.

**Criminal Law Enforcement Facilities:** In Law Number 32 of 2009 concerning Environmental Protection and Management, environmental criminal provisions are regulated in Article 94 through Article 120. While for forest fires the criminal provisions are in Article 108 which states: Every person who burns land as referred to in Article 69 paragraph (1) letter h, shall be sentenced to a maximum imprisonment of 3 (three) years and a maximum of 10 (ten) years and a fine of no less than Rp.3,000,000,000.00 (three billion rupiah) and a maximum of Rp.10,000 .000,000.00 (ten billion rupiah).<sup>9</sup>

## Conclusion

There are three activities to prevent and handle forest fires according to Carter (2008):

1. Preventive is an effort made so that disasters do not occur.

2. Mitigation of efforts to minimize the impact of disasters.
3. Preparedness/preparedness is a quick step that must be taken to respond to a disaster.

Means of environmental law enforcement in terms of Law No. 32 of 2009 concerning Environmental Protection and Management, namely:

1. Means of Administrative Law Enforcement, administrative law sanctions as stated in Article 76 paragraph (2).
2. Means of Civil Law Enforcement:
  - (a) **Court Track:** Settlement of disputes through court is regulated in Article 87 through Article 92.
  - (b) **Track Outside the Court:** Settlement of environmental disputes outside the court is regulated in Article 85.
3. Means of Criminal Law Enforcement, the provisions of environmental crime are regulated in Article 94 to Article 120.

In the effort to prevent and deal with forest fires, active participation in control policies implemented by the government, plantation companies and the community is needed. Prevention efforts aim to reduce the impact of forest fires because these efforts are relatively easier and cheaper than having to overcome the impacts after a fire has occurred. Therefore, it needs a growing awareness from all groups who have a concern for the preservation of forests and the environment to understand that the issue of forest fires and other environmental damage has reached an alarming level.

**Conflict of Interest:** Nil

**Source of Funding:** Self

**Ethical Clearance:** Environmental Law of Research through Environmental to Prevent the Dangers of Environmental Hazards, Faculty Of Law Sebelas Maret University on 02-07-2020.

## Reference

1. Dodi N. Hutan Bagi Ketahanan Nasional. Surakarta: Muhammadiyah University Press; 2005. 1 p.
2. Supriyadi BE. Hukum Agraria Kehutanan: Aspek Hukum Pertanahan Dalam Pengelolaan Hutan Negara. Jakarta: Rajawali Pers; 68–69 p.
3. Suryadi M. Upaya Penanganan Kejahatan Lingkungan Pembakaran Hutan dan Lahan Gambut di Sumatera 2004-2015. *J Int Relations*. 2017;3(2):75–8.
4. Gusti Ayu Ketut Rachmi Handayani I, Gunarto G, Mashdurohatun A, Gusti Putu Diva Awatara I, Najicha FU. Politic of legislation in Indonesia about forestry and the mining activity permit in the forest area of environmental justice. *J Eng Appl Sci*. 2018;13(6).
5. About Forestry. No. 41 Indonesia; 1999.
6. Wibowo KA. Manajemen Penanganan Kebakaran Hutan dan Lahan (Karhutla) Guna Peningkatan Ekonomi Kerakyatan. *J Stud Sos dan Polit*. 2019;3(1).
7. Wibawa AK. Penegakan Hukum Terhadap Tindak Pidana Pembakaran Hutan Guna Pembukaan Lahan (Perspektif Hukum Indonesia Dan Hukum Islam). Surakarta: Faculty Of law Muhamadiyah Surakarta University; 2016.
8. Najicha FU. Politik Hukum Pada Pembentukan Produk Hukum Perundang-Undangan Kehutanan. Kebumen: Intishar Publishing; 2019. 60 p.
9. Law No. 32 2009 Concerning Environmental Protection and Management. No. 32 Indonesia; 2009.

# Study on Effectiveness of Staff Welfare Program Regarding Occupational Stress During COVID 19 Pandemic among Nursing Officers

Franny Joel Emmanuel<sup>1</sup>, Yugmi Vala<sup>2</sup>, Tapan Dodia<sup>3</sup>

<sup>1</sup>Nursing Tutor; M.Sc. Nursing, Child Health Nursing, Manikaka Topawala Institute of Nursing–CHARUSAT; Changa; Ta. Petlad, Dist.–Anand; Gujarat-38842, India, <sup>2</sup>Post-Graduate Diploma in nursing Administration, Symbiosis School for Open and Distance Learning, Pune, India, <sup>3</sup>MBBS, FCCCM, ISCCM, Intensivist, Ruby Hall Clinic, Pune

## Abstract

**Background:** No wonder who you are and what you are, make your soul strong enough to fight against Stress, move ahead with joy, and let us make stress to be alone. Nursing Care for an individual no matter whether an individual is health or unhealthy, no matter from which age group S/He belongs to, however stress perception is highly subjective<sup>1</sup>. Work related stress amongst nursing fraternity can be generated by copious reasons. These reasons are dangerous for nurses especially during the current scenario of “COVID 19 Pandemic”, this stress has been concern throughout the globe.<sup>2</sup>

**Objectives:** Researchers have set the objectives of computing the effectiveness of staff welfare program regarding Occupational stress during “COVID 19 Pandemic” among nurses.

**Methodology:** Researchers have used quasi experimental research design. 60 Nursing staff from a ICU of a reputed hospital of Pune city were recruited with Consecutive non probability technique. Expanded nursing stress scale (ENSS) has used to measure nurses occupational stress during “COVID 19 Pandemic”. This tool is in the form of 5 point likert scale.

**Results:** Researchers have identified that pre-test and post-test’s mean difference is 61.1in experimental group, where as in control group mean difference is 2.3.

**Conclusion:** It reciprocates that experimental group pre test post test mean difference has vast difference than control group, thus staff welfare program is effective in order to reduce the occupational stress during “COVID 19 Pandemic” among nursing fraternity .

**Keywords:** Effectiveness; Staff welfare program; occupational stress; “COVID 19 Pandemic”; nurses.

## Introduction

Nursing is defined as a most kind profession full of knowledge, compassion, and skill. Nurses are the

heart of the hospital, where they have to deal with copious obstacles in terms of physical, mental, spiritual challenges<sup>3</sup>. Majority of all profession or job has work stress may be physically, socially or even emotionally. Stress can be considered as a long lasting, dangerous and emotional impairment which can affect an individual’s health. According to current scenario when globe is suffering with “Corona virus”, and nurses are at high risk to get exposed while performing his/her duties, it is very hard to manage between personal and professional life during this pandemic, where majority of the people are having questions on their survivalist. It is a very much important to examine the nursing literature on stress and

---

### Corresponding Author:

**Ms. Franny Joel Emmanuel**

Nursing Tutor, M.Sc. Nursing: Child Health Nursing, “Manikaka Topawala Institute of Nursing–CHARUSAT, Changa; Ta. Petlad, Dist. – Anand, Gujarat-38842, India  
Ph. No.: 9409026609  
e-mail: frannyemmanuel.nur@charusat.ac.in

one should make some strategies to reduce occupational stress<sup>4</sup>.

Thus, researcher wants to detect occupational stress among ICU nurses, construct and administer Staff welfare program to reduce level of stress among nurses and so they become strong enough to keep aside stress and give quality of work towards their institute and feel free to work efficiently.<sup>5</sup> This staff welfare program includes 2 components: “strike balance with maintenance of workplace stress” and “Breathing exercise”. During the hospital experience, the researchers had come across many nurses suffering from occupational stress and nurses are not focused from resolving or decreasing this stress. Hence researchers wants to put efforts to decrease this occupational stress. So, that the need for this study is an important aspect to be carried out at the time of this pandemic.

**Objectives:**

1. Assess the level of occupational stress during “COVID 19 Pandemic” among nursing officers in experimental group and control group.
2. Compute effectiveness of staff Welfare program regarding occupational stress during “COVID 19 Pandemic”.

**H<sub>1</sub>:** There will be a significant difference in post test occupational stress level between experimental group and control group.

**Assumptions:**

- Nurses of Selected hospital may have high level of stress level need to reduce their occupational stress level.
- They may develop interest during Staff Welfare Program
- Introducing of staff welfare program may reduce stress in nurses.

**Methodology**

**Research Design:** Quasi Experimental research design

**Setting:** One reputed Hospital of Pune City

**Subject:** Nursing Undergraduates

**Sampling techniques:** Consecutive non probability technique

**Sample size:** 60 sample (30 control group, 30 experimental group)

**Variables: Demographic variable:** Age, Gender, Years of experience, Marital status, Monthly salary, Education qualification, Number of dependency members in family, Year of experience at current hospital, perception of nurses for doctor, perception of nurses for other colleague, skip meal at duty, night Duty is....., are you getting rest/leave enough, Family Type.

**Independent variable:** Staff welfare Program

**Dependent Variable:** Occupational Stress

**Inclusion Criteria:**

1. Staff who are willing to Participate in the study
2. Staff who can read writes and understand English language.
3. Staff that are registered with nursing council.
4. Staff who is working in medical and surgical ICU
5. Staff who is having at least 1 year of experience of ICU.
6. Staff who works in ICU at the time of COVID 19 Pandemic but not associated with corona positive patients.

**Exclusion Criteria:**

1. Staff who are undergone to any alternative therapy.
2. Staff who has experience sudden loss
3. Staff who is having any other psychological or physical problems
4. Staff who is not available at the time of post tests
5. Staff who can't attend all the sessions of staff welfare program

**Explanation of the tool: Tool comprise of 2 sections:**

**Section 1:** Deals with 14 demographic variables. It is in the form of Semi structured Questioners with multiple choice answers

**Section 2:** Self modified “Expanded nursing stress scale (ENSS)” has used to measure nurses occupational stress. The ENSS is an expanded and updated revision of classic nursing scale developed by Gray–Toft and Anderson (1981).<sup>6</sup> This scale is used to assess

occupational stress in nurses. It is an expanded version of the original 34-items Nursing stress scale. ENSS contained 57 items in nine subscales. The 57 each items were arranged in 5 point Likert response scale.

Total score 285 which classified into, absolute grading is used

- 57: No Stress
- 58-133: Mild Stress
- 134-209: Moderate Stress
- 210-285: Sever stress

The researcher modified the expanded nursing stress scale to assess the level of stress among nurses.

**Description of staff welfare program:** In this research study researchers have created one program for reduction of occupational stress, it includes two components: “Strike balance with maintenance of workplace stress” and “Breathing exercise”. Researchers have undergone with online certificate course on maintenance of workplace stress from udemy online course.

**Manage Workplace Stress and Strike a Balance:** In this component nurses will able to Identify & understand stressors, how to manage them with these techniques, How to determine priorities & values, Set smart & measurable goals, how to balance an individual’s Personal life and work place life by setting up plethora of priorities and factoring in some downtime, various team building, motivating activities are been included in this welfare program.<sup>7</sup>

**Breathing exercise:** Sample are trained for 3 breathing exercise such as “alternative breathing”, “Stimulating breathing technique”, “Abdominal breathing.” Each breathing exercise will long for 10 min<sup>8</sup>

**Statistics: Descriptive statistics:** Mean, SD, frequency distribution

**Inferential Statistics:** Unpaired t test

## Result

The collected statistics were edited, tabulated, analyzed, interpreted furthermore findings were presented in the shape of tables and graphs representing in the following segments.

**Segment I:** Plotting data Frequency and Percentage data distribution of Population characteristics Variable

**Segment II:** Data Frequency and percentage distribution of occupational stress score

**Segment III:** Unpaired t test calculation

**Segment I: Plotting Data Frequency and Percentage Data Distribution of Population Characteristics Variable**

As per demographic data collection table shows that in experimental group 24 no. of nurses (80%) are in between 20-30 years of age, 5 no. of nurses (16.67%) are in between 32-40 years of age, 1 no. nurses (3.33%) is in between 42-60 years of age. In control group 25 no. of nurses (83.34%) are in between 20-30 years of age, 4 no. of nurses (13.33%) are in between 31-40 years and 1 no. of nurses (3.33%) is in between 41-60 years

As per gender in control group 22 no. of nurses (70%) are female, 8 no. of nurses (30%) are male. In experimental group 24 no. of nurses (80%) are female, 6(20%) nurses are male.

In experience variable majority 13(43.34%) nurses have experience of 3-5 years, 10(33.33%) nurses have experience of 1-2 years and 7(23.33) nurses have experience of more than 5 years in control group. While in experimental group majority 13(43.34%) nurses have experience of 1-2 years, 11 nurses have experience of 3-5 years and 6 (20%) of nurses have experiences of more than 5 years.

As per marital data 20 no. (66.67%) of nurses are unmarried, 10 no. (33.34%) of nurses are married and in control group. Where in experimental group 17 (56.66%) are unmarried, 13 (43.34%) are married.

21(70%) nurses are satisfied from their salary and 9(30%) nurses are not satisfied from their salary in control group while in experimental group 22(73.34%) nurses are satisfied from their salary and 8(26.66%) nurses are dissatisfied from their salary.

Education qualification in control group 25(83.33%) nurses certified from GNM course, 5(16.67%) certified from BSC course. Education qualification in experimental group include 25(83.33%) nurses certified from GNM course, 4 nurses certified from BSC nursing course, 1(3.33%) certified from post basic BSC nursing course as per table number 4.

According to table no. 4, in control group 10(33.34%) nurses has more than 2 dependency members in family, 9(30%) nurses has none dependency member in family, 7(23.33%) nurses has 2 dependency members in family, 4(13.33%) nurses has 1 dependency member in family. Number of Dependency member in family in experimental group include 13(43.34%) nurses has none member, 12(40.00%) nurses has 2 members, 3(10.00%) nurses has more than 2 members, 2(6.66%) nurses has 1 member.

As per Year of experience in current hospital in control group 17(56.67%) nurses have 1 to 2 year experience, 11(36.66%) nurses have 3 to 5 year experience, 2(6.66%) nurses have more than 5 years experience. Year of experience in current hospital in experimental group include 20(66.67%) nurses have 1 to 2 year experience, 9(30.00%) nurses have 3 to 5 year experience and 1(3.33%) nurses have more than 5 years of experience.

Perception of nurse for doctor in control group 16(53.33%) nurses has excellent perception for doctors, 10(33.33%) nurses has Average perception for doctor, 4(13.34%) nurses has Poor perception for doctor. Perception of nurse for doctor in experimental group include 20(66.67%) nurses has excellent perception for doctor, 7(23.33%) nurses has Average perception for doctor, and 3 (10.00%) nurses has Poor perception for doctor as per data.

As per data, perception of nurse for other collages in control group 22(73.34%) nurses have Excellent perception for other collages, 8(26.66%) nurses have Average perception for other collages, 0(0%) nurses have Poor perception for other collages. Perceptions of nurse for other collages in experimental group include

24(80.00%) nurses have excellent perception for other collages, 5(16.67%) nurses have Average perception, and 1 (3.33%) nurses have Poor perception for other collages.

Skip meal at duty in control group 17(56.67%) nurses never skip meal at duty, 13(43.33%) nurses sometime skip meal at duty. In experimental group include 23(76.67%) nurses never skip meal at duty, 7(23.33%) nurses skip sometime meal at duty.

Night duty in control group 26(86.66%) nurses feel safe night duty, 4(13.34%) nurses feel reasonable safe night duty. Night duty in experimental group include 28(93.34%) nurses feel safe night duty, 2(6.66%) nurses feel reasonable safe night duty as per above data.

As per above table nurses who are getting rest enough in control group 19(63.33%) nurses getting rest some time, 6(20.00%) nurses never getting rest and 5(16.67%) nurses always getting rest. Nurses who are getting rest enough in experimental group include 18(60.00%) nurses are getting sometime rest, 8(26.66%) nurses always getting rest, 4(13.34%) nurses never getting rest.

Family type in control group 16(20.00%) nurses are belongs form extended family type 13(43.33%) nurses are belongs form joint family, 11(36.67%) nurses are belongs from Nuclear family type. Family type in experimental group include 16(53.34%) nurses are form joint family type, 9(30%) nurses are form Nuclear family type, 5(16.66%) nurses are for extended family type as per above table.

**Segment II: “Data Frequency and Percentage Data Distribution of Emotional Intelligence Score”**

**Table 1: Data Frequency and Percentage data distribution of occupational stress score**

Class Interval	Experimental Group				Control Group			
	Pre Test		Post Test		Pre Test		Post Test	
	Frequency	%	Frequency	%	Frequency	%	Frequency	%
57: No stress	0	0%	1	3.33%	0	0%	0	0%
58-133: Mild stress	5	16.67%	22	73.34%	9	30%	6	20%
134-209: Moderate stress	10	33.33%	7	23.33%	9	30%	9	30%
210-285: Severe stress	15	50%	0	0%	12	40%	15	50%



**Segment III: “Effectiveness of Staff Welfare Program on Occupational Stress of ICU Staff Nurses”****Table 2: Mean, standard deviation, mean difference and unpaired ‘t’ test value of pre-test and post-test score in experimental group**

Variable		Mean	Mean difference	SD	DF	t- value	Table value	Significant
Occupational stress score	Pre-test	194.7	61.1	13	29	8.63	2.04	S*
	Post-test	133.6						

\*(0.05,29)2.04

**Inference:** This table Depicts mean, standard deviation of pre-test and post-test in experimental group with the mean difference is 61.1, SD is 13, paired’ is 8.63 value and p value, df value of pre-test and post-test stress level score.

**Table 3: Mean, standard deviation, mean difference and ‘t’ value of pre-test and post-test score in control group**

Variable		Mean	Mean difference	SD	DF	t- value	Table value	Significant
Occupational stress score	Pre-test	182.93	2.3	14.82	29	-1.16	2.04	NS*
	Post-test	185.23						

\*(0.05,29)2.04

**Inference:** This table Depicts mean, standard deviation of pre-test and post-test in experimental group with the mean difference is 2.3, SD is 14.82, paired’ is -1.16 value and p value, df value of pre-test and post-test stress level score

**Discussion**

Pre-test stress level: Mean pre-test score = 194.7, pre-test stress level score reveals that 5 nurses (16.67%) are having mild occupational stress, 10 nurses (33.33%) are having moderate occupational stress and 15 nurses (50%) are having severe occupational stress. Post-test stress level: Mean post-test score = 133.6, where post-test score reveals that 1 nurse (3.33%) is having no occupational stress, 22 nurses (73.34%) are having mild occupational stress, 7 nurses (23.33%) are having moderate occupational stress and no one is having severe occupational stress. Where the control group Pre-test stress level: Mean pre-test score = 182.93, pre-test stress level score reveals that 9 nurses (30%) are having mild occupational stress, 9 nurses (30%) are having moderate occupational stress and 12 nurses (40%) are having severe occupational stress. Post-test stress level: Mean post-test score = 185.23, post-test stress level score reveals that 6 nurses (20%) are having mild stress, 9 nurses (30%) are having moderate stress, 15 nurses (50%) are having severe stress.

**Conclusion**

To the best of our comprehension, this literature review implicates the relationship between Occupational stress and nursing fraternities are higher. With specific association to all above mentioned studies we researchers have come up with the serious note of discussion.<sup>6</sup> These Review divulge plethora of facts, these facts are fascinating and interesting. This study review that there is a different score of occupational stress among nursing officers after the intervention of staff welfare program, Researchers believe that to boost the favorable condition of nursing staff and to reduce the occupational stress, an individual should emphasize to receive staff welfare program. This may also lead in positive social change, reducing emotional conflicts, resulting in high productivity.<sup>9</sup>

**Recommendations:** In the light of the above finding and personal experience of the investigator the following recommendations are offered: The study can be replicated on larger sample; thereby finding can be generalized for a larger sample. Nurses working in

any set up can use the staff welfare program (manage workplace and strike a balance and breathing exercises) to decrease occupational stress level. The department should also create such kind of Protocols to keep their nurses fit and fine.

#### **Suggestions:**

- A study can be replicated on a large sample which will facilitate more reliable research.
- A similar study can be conducted in different setting.

**Ethical Consideration:** Inform consent was obtained from the samples who have participated in research study in the consent form. Confidentiality of all sample's information is maintained properly.

**Conflict of Interest:** There is no any means of conflict of interest within the researchers

**Funding Agency:** Researchers have not received any fund from any agency.

#### **References**

1. B M. Self-reported stress and its effects on nurses.- PubMed-NCBI [Internet]. Ncbi.nlm.nih.gov. Available from: <https://www.ncbi.nlm.nih.gov/pubmed/12212429>
2. Novel Coronavirus (2019-nCoV) situation reports [Internet]. Who.int. 2020. Available from: <https://www.who.int/emergencies/diseases/novel-coronavirus-2019/situation-reports>
3. Nola Pender: Health Promotion Model (Nursing Theory Guide) [Internet]. Nurseslabs. 2020. Available from: <https://nurseslabs.com/nola-pender-health-promotion-model/9>.
4. B.T.Basvanthappa,"NURSING RESEARCH", 2nd edition, Jaypee Brothers Medical Private Ltd, page no. 61-63
5. Annals of Indian Psychiatry: Table of Contents [Internet]. Anip.co.in. 2020. Available from: <http://www.anip.co.in/searchresult.asp?I1.x=0 & I1.y=0 & search=A+profile+of+occupational+stress+in+nurses>
6. Effect of Stress Management Interventions on Job Stress among Nurses working in Critical Care Units - ProQuest [Internet]. Search.proquest.com. 2020. Available from: [https://search.proquest.com/openview/5fd1cd48c7bbfb57613e665fbd935054/1? pq-origsite=gscholar & cbl=35042](https://search.proquest.com/openview/5fd1cd48c7bbfb57613e665fbd935054/1?pq-origsite=gscholar & cbl=35042)
7. F Polit, Cheryl Tatano Beek, "Nursing Research principles and method", 7th edition, Lippincott Williams and Wilkins Publishers-Philadelphia, Page no. 450-452
8. French SE Lenton R, Walters V, Eyles J. An empirical evaluation of expanded nursing stress scale. *J Nurs Meas* 2000;8 160-178.
9. Karl Pearson's Formula for Finding the Degree of Correlation [Internet]. Economics Discussion. 2020. Available from: <http://www.economicsdiscussion.net/correlation/karl-pearseons-formula-for-finding-the-degree-of-correlation/2579>

# Nomophobia: An Assessment of No Phone Phobia among Adolescents

Gaurav Kohli<sup>1</sup>, Manu Kohli<sup>2</sup>, Poonam Joshi<sup>3</sup>

<sup>1</sup>Gaurav Kohli, Professor, Chitkara School of Health sciences, Punjab, India, <sup>2</sup>Manu Kohli, Associate Professor, Chitkara School of Health Sciences, Chitkara University, Punjab, India, <sup>3</sup>Poonam Joshi, Assistant Professor, Guru Hargobind College of Nursing, Raikot, Punjab, India

## Abstract

Nomophobia is a fear of being without mobile phone and it's like fear of losing phone, checking it for call but it's not ringing, mobile gaming and engage in social sites at maximum. This was a study to assess nomophobia among adolescents. The aim of study was to identify the mobile usage pattern and risk of developing nomophobia among the college students. The selected Setting was college of Education Halwara, Ludhiana, Punjab. A non-experimental/exploratory research design was utilized and 80 Elementary teacher training students were selected through consecutive sampling technique. A self – reporting checklist was utilized to assess the mobile usage pattern and rating scale assessed the risk of developing nomophobia. Analysis was done using SPSS 16.0 version. Descriptive and inferential statistics were used to analyze the data. The findings indicated that the maximum 55 (68.25%) of students follows the normal mobile usage pattern similarly the maximum 67 (83.75%) of participants were at the lower risk of developing nomophobia. There was moderate uphill (positive) relationship between the mobile usage pattern and risk of developing nomophobia. It is concluded that informative material and sensitizing sessions can help the students to cope up with this addiction.

**Keywords:** *Nomophobia, mobile, mobile addiction, smart phone, adolescents.*

## Introduction

In the era of technology, our affections are flowing more toward gadgets than humans. Similarly, youngster's love for mobile has increased to the maximum, which is making them weaker in certain spheres of life. The word nomophobia designed for mental health problem arises from mobile usage, which is an existence of self without phone or fear of losing phone. Nomophobia also known as no-mobile phobia, which may come in situation like no network area, not recharged, battery discharged, misplaced or any other. <sup>1</sup>The new age mobile phone has replaced various things (diary, computer, calculator, music player, camera, video game, mode of entertainment, concerns, conversations and group involvements) of our lives, which are also predisposing causes of this irrational apprehension of being without phone.<sup>2</sup>

The reckless use of mobiles is unfolding the barriers to social and parental control. It's a free zone to share

the views, ideas and imaginations with peer groups. Secondly, it's a major status symbol among youngsters in this era. Due to this boundary free approach, the dependency is taking toll on physical, mental, social and financial health of youngsters. Modern mobile phones are recognized as new epidemic disease of the century and the students are main affected chunk of it. It is quoted as a best measure to use in study in terms of material accessibility but more than serving the purpose it exposes our young population to its addiction. New platform of mobile phones like android can help the students in many domains of the study as comes with educational apps but it also pushing the students toward mental dependence toward mobile phones.<sup>3</sup>

According to data regulatory authority of India there are about 1.18 billion mobile users in India and the age group of 19-24 years reveals the high degree of penetration in usage. They show significant inclination for their own mobile phones. 2 out of 3 mobile users are unmarried or singles.<sup>4</sup> A study revealed that the

excessive use of mobile phone among teenagers results in restless, fatigue and insomnia. Findings of the study highlighted the percentile of mobile utilization in various life routines as 58% Indian users utilize it to maximum during air travel, 69% in cinema halls, 21% on religious place, 79% on weddings ceremonies, 25% in shopping and last 80% Indian use it on dining table. According to cross-sectional study, adolescents are mainly linked to the factors (depression, social separation, drug/alcohol use and academic failure) associated with intense mobile phone usage. The total number of 1328 samples with age limit of 31-20 years were selected in the study. The result shows that the factors like mobile phone possession is contributing to 96.5% (one phone 80.5% and >1 phone 15.9%), carry to educational institution is 54.8%, whereas 46.1% keep it on during the class even, extreme mobile dependence was calculated to 39.1% (26.1% among females and 13% males).<sup>5</sup>

This investigation was conducted to assess mobile usage pattern and risk of developing nomophobia; to find out the correlation between mobile usage pattern and risk of developing nomophobia; to assess the relation between mobile usage pattern and risk of developing nomophobia with demographic variables. This original paper contributed to explore the most susceptible population to Nomophobia as they are the one who carried India to 2<sup>nd</sup> rank among most gaming nations. This is a sign to explore this component of addiction prevailing with increased screen time. Researchers went through the facts available as well as carried out the investigation for same. This will help the research community to guide their investigations toward this important and less explored component of adolescents' mental health.

### **Materials and Method**

A quantitative approach and an exploratory research design were adopted to identify the mobile phone usage and risk of developing nomophobia among students. The demographic variables of the study were age (in years), gender, father and mother education, Family monthly income, type of family and academic year, Research variables were mobile usage pattern and risk of developing nomophobia. The main study was conducted in Shri Guru Ram Dass College of Education, Halwara and sample of 80 students were selected with consecutive sampling technique. All the students were possessing smart phones and there was no exception. The tool consists of three parts i.e.

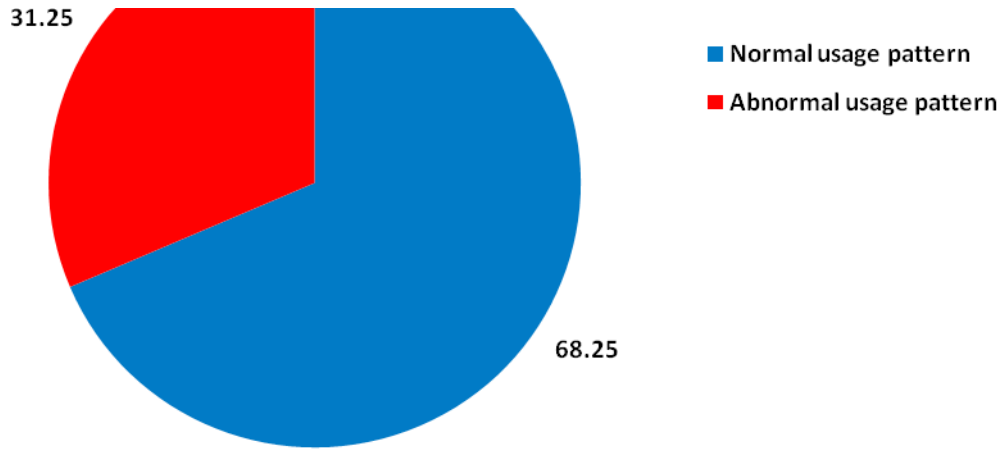
sample characteristics; self-structured checklist to assess mobile usage pattern and self-structured rating scale to assess the risk of developing nomophobia. The criterion measure of tools was categorized as Mobile usage pattern checklist - Normal usage pattern and abnormal usage pattern, whereas rating scale to identify the risk of developing nomophobia was categorized as No risk, Lower risk and High risk. The tool was validated by 15 experts as well as calculated reliability of tool was 0.91 for checklist and 0.89 for rating scale. An approval was extended by the ethical committee of G.H.G College of Nursing. A written consent was taken from each participant after explaining the aim of study. An assurance was extended by the researchers about their responses will be confidential and utilized for research purpose. Researchers explained the rights to participants i.e. they can withdraw and refuse the answer as well as intervention wouldn't pose them to any physical, mental and social threat. Responses were recorded in one sitting and an average time taken by each student to mark their responses was 35-40 mins. Responses were analyzed with the help of descriptive and inferential statistics. The problem faced by the researcher to carry on this study was difficulty to get permissions as students were engaged in their coursework.

### **Results**

Analysis and interpretations were carried out according to the laid down objectives of the study. The data was demographically distributed according to age (in years), gender, father's and mother's education, Residence place, Family monthly income, type of family and academic year. There were maximum 37 (46.25%) students in the age group of 18-19 years followed by 30 (37.5%) of students fall in 20 to 21 years of age, whereas minimum 13 (16.25%) students were of >21 years. More than half 55 (68.75%) students were females whereas minimum 25 (31.25%) students were males. The maximum 39 (48.75%) students' fathers were educated between 6<sup>th</sup> – 10<sup>th</sup> followed by 19 (23.75%) students' fathers were educated up to primary followed by 10 (12.5%) students' fathers were educated between 10+1-10+2 followed by 8 (10%) students' fathers were illiterate whereas minimum 4 (5%) students' fathers were educated up to graduation and above. The maximum 30 (37.5%) students' mothers were educated between 6<sup>th</sup> -10<sup>th</sup> followed by 22 (27.50%) students' mothers were educated up to primary followed by 17 (21.27%) of students' mothers were illiterate followed by 8 (10%) students' mothers were educated between

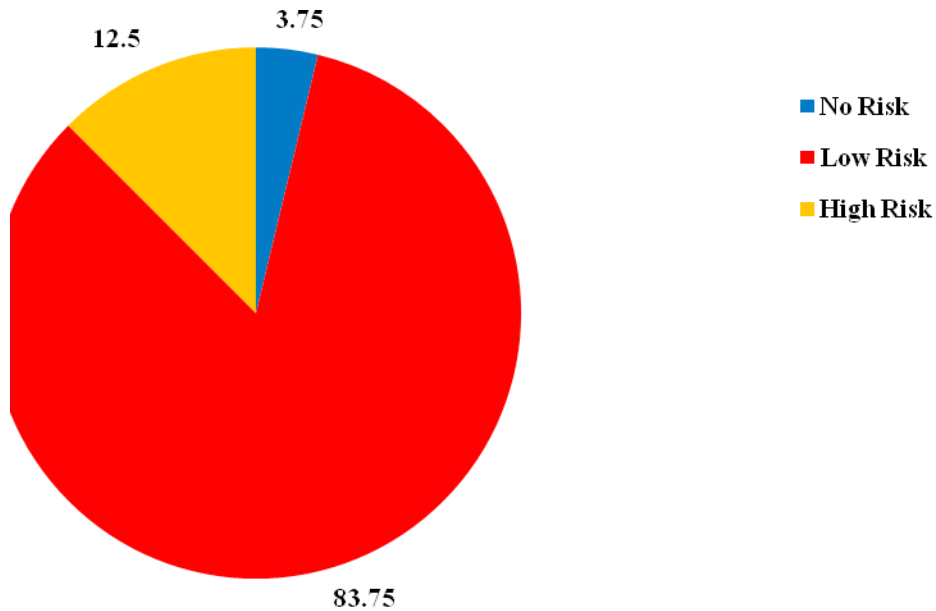
10+1-10+2 whereas minimum 3 (3.33%) of students' mothers were educated up to graduation and above. The total 80 (100%) students were residing at home and no one was living in hostel. There were 35 (43.75%) students had ≤5000 monthly family income followed by 34 (42.5%) students had 5001-10000 monthly family income followed by 8 (10%) students had 10001-15000 monthly family income whereas 3 (3.33%) of students had ≥15001 monthly family income. Nearly half 49

(61.25%) of students belong to nuclear family followed by 30 (37.5 %) students from joint family whereas minimum 1 (1.25%) students belong to extended family. The maximum 46 (57.5%) students were studying in second year whereas 34 (42.5%) students in first year of elementary teacher training course. Figure 1 reveals that the 55 (68.25%) students follows the normal mobile usage pattern whereas minimum 25 (31.25%) students were in the category of abnormal mobile usage pattern.



**Fig 1:** Percentage distribution of mobile usage pattern

Figure 2 depicts that maximum 67 (83.75%) students at the lower risk of developing nomophobia followed by 10 (12.5%) students at higher risk, whereas 03 (3.75%) students at no risk of developing nomophobia.



**Fig 2:** Percentage of risks of developing nomophobia

Table 1 depicts that the mean scores was 51.41 of students at risk of developing nomophobia, whereas the mean score was 9.16 for the mobile usage pattern of

students. The calculated r value between mobile usage pattern and risk of developing nomophobia was 0.506. Hence it was concluded that there was a moderate uphill

(positive) relationship between the mobile usage pattern and risk of developing nomophobia among students.

**Table 1: Correlation between mobile usage pattern and risk of developing nomophobia among students (N=80)**

Correlation	N	Mean±SD	r
Mobile Usage Pattern	80	9.16±2.65	0.506
Risk of developing nomophobia	80	51.41±14.16	

Table 2 reveals the relationship between mobile usage and demographic variables. The calculated F and t values of age (in years), gender, father and mother education, Family monthly income, type of family and academic year found no significant at  $p < 0.05$ , which means there was not significant relationship between the variables.

**Table 2: Relationship between mobile usage pattern with demographic data (N=80)**

Sr.No.	Demographic data	F value	P value
1	Age	0.27	0.760
2	Gender	0.19	0.421
3	Father’s education	0.06	0.992
4	Mother’s education	0.64	0.635
5	Family income	0.74	0.528
6	Type of family	0.70	0.496
7	Academic year	0.80	0.372

F – F value, t – t value,  $p < 0.05$

**Table 3: Relationship between risk of developing nomophobia with demographic data (N=80)**

Sr.No.	Demographic data	F value	P value
1	Age	0.866	0.424
2	Gender	5.881*	0.001
3	Father’s education	0.956	0.436
4	Mother’s education	0.742	0.566
5	Family income	2.110	0.105
6	Type of family	5.220	0.190
7	Academic year	2.242	0.138

F – F value, t – t value, \* significant at  $p < 0.05$

Table 3 depicts the relationship between risk of developing nomophobia with demographic variables. It

reveals that the calculated F values between age (in years), father and mother education, Family monthly income, type of family and academic year found no significant relationship with risk of developing nomophobia. The calculated t value between gender and risk of developing nomophobia had shown significant relations.

### Discussion

The findings of study were supported by Salloju V, Ranjith B (2017)<sup>6</sup>, the cross-sectional study was conducted to assess the severity of mobile dependency among 171 pharmacy students. The target age group was 17-25 years. Findings show that only 24.37 % of pharmacy students had risk of developing nomophobia. George S, Saif N, Joseph B (2017)<sup>7</sup> supports the findings of study, topic was to find the utilization of mobile among medical students in Kerala, which shows that only 35% of medical students are frequent mobile users, whereas 65% were normal mobile users. Similarly finding were reported by Kaur A, Sharma P (2015)<sup>8</sup> an investigation was conducted to find out the threat of producing nomophobia among students of nursing. The findings suggested that there was moderate correlation of mobile use and threat of producing nomophobia. Mertkan D Gezgin, Ozlem Cakir (2016)<sup>9</sup> conducted an investigation to find out the prevalence of nomophobia in pre-service teachers of Trakya university and results concluded that age has relationship with the mobile usage pattern in preschool teachers. Datta S, Nelson V, Simon S (2016)<sup>10</sup> who conducted a study to assess the mobile use and problems reported by the students of medical education. Findings concluded that father’s education has no association with mobile usage pattern in medical students. Prasad M, Patthi B, Singla A, Gupta R, Saha S, Kumar J, et al. (2017)<sup>11</sup> who conducted a Cross-sectional investigation of mobile use and threat of growing nomophobia Among Students of dental. The association of father’s education was found not significant with risk of developing nomophobia. Sanjay Dixit, Harish Shukla, A.K Bhagwat, Arpita Bindal, Abhilasha Goyal, Alia K Zaidi, et al. (2010)<sup>12</sup> who conducted an investigation to find out mobile addiction in the students of medical college in India. Results showed no association of risk of developing nomophobia with academic sessions. The limitations of this research study was few studies available in the field of mobile usage pattern. Secondly the sample size limited and not containing responses from the students of other professions.

## Conclusion

In this study one third (31.25%) of the total students had abnormal mobile usage pattern, which can also be referred as frequent users. The maximum number of students was not at the risk of developing nomophobia. There was a moderate uphill (positive) relationship between the mobile usage pattern and risk of developing nomophobia among students. The calculated F and t values of age (in years), gender, father and mother education, Family monthly income, type of family and academic year found no significant at  $p < 0.05$ , which means there was not significant relationship between the variables. Age (in years), gender, father and mother education, Family monthly income, type of family and academic year had no notified relationship with risk of developing nomophobia, whereas the calculated t-value between gender and risk of developing nomophobia had shown significant relations.

**Acknowledgement:** We owe the gratitude toward our family to hold up throughout this project as well as special thanks to our principal Mrs. Harmeet Kaur Kang for instilling an eager inside for the professional growth.

**Financial support and Sponsorship:** Self-funded project

**Conflict of Interest:** Researchers had not conflict of interest

## References

1. RupaniMahir P, Parikh khushali D, Trivedi Atul V, Singh Mahindra P, Patel Ayushi, Vadodariya Bhakti, et al. CROSS-SECTIONAL STUDY ON MOBILE PHONE INVOLVEMENT AMONG MEDICAL STUDENTS OF A TERTIARY CARE TEACHING HOSPITAL OF WESTERN INDIA. National Journal of Community Medicine [Internet]. 2016 Jul [cited 2018Mar 13];7(7):600–13. Available from: [http://njcmindia.org/uploads/7-7\\_609-613.pdf](http://njcmindia.org/uploads/7-7_609-613.pdf)
2. Katharine B. Phone reliant Britons in the grip of nomophobia, The independent. March 31, 2008. Available from: <http://www.independent.co.uk/news/uk/life-style/gadgets-and-tech/news/survey-suggests-half-of-britons-fear-being-without-their-mobile-8784706.html> [last accessed on 2018 March 28]
3. A study to analyze relationship between psychological behavioral factors on Whats App addiction among Youth in Jalandhar District in Punjab. Global advanced research journal [Internet]. 2015May [cited 2018Mar13];4(5):203–7. Available from: <http://garj.org/garjmb/5/2015/4/5/a-study-to-analyze-relationship-between-psychological-behavioral-factors-on-whatsapp-addiction-among-youth-in-jalandhar-district-in-punjab>
4. Telecom Regulatory Authority of India [Internet]. Home | Telecom Regulatory Authority of India | Government of India. [cited 2018Mar28]. Available from: <https://main.trai.gov.in/>
5. Arumugam B, Sachi S, Nagalingam S. A descriptive study on behaviour associated with mobile phone usage and its effect on health among medical students in chennai. Journal of Evolution of Medical and Dental Sciences. 2014;3(7):1590–95.
6. Salloju V, Ranjith B. Cross sectional evaluation of nomophobia severity -mobile phone dependency among south Indian pharmacy college students. Adv J Pharm Life sci Res [Internet]. April 2017 [cited 2018 Mar 13]; 5(1): pp 7-12. Available from [https://www.researchgate.net/publication/316107849\\_CROSS\\_SECTIONAL\\_EVALUATION\\_oF\\_NOMOPHOBIA\\_SEVERITYMOBILE\\_PHONE\\_DEPENDENCY\\_AMONG\\_SOUTH\\_INDIAN\\_PHARMACY\\_COLLEGE\\_STUDENTS](https://www.researchgate.net/publication/316107849_CROSS_SECTIONAL_EVALUATION_oF_NOMOPHOBIA_SEVERITYMOBILE_PHONE_DEPENDENCY_AMONG_SOUTH_INDIAN_PHARMACY_COLLEGE_STUDENTS)
7. George S, Saif N, Joseph B. A study on the mobile phone usage pattern and its dependence among medical students of a college in Kerala, India. International journal of Research in Medical Sciences. 2017Aug;5(8):3615–19. DOI: <http://dx.doi.org/10.18203/2320-6012.ijrms20173573>
8. Kaur A, Sharma P. A study on the mobile phone usage pattern and its dependence among medical students of a college in Kerala, India. A Descriptive Study to Assess the Risk of Developing Nomophobia among Students of Selected Nursing Colleges Ludhiana, Punjab [Internet]. 2015Sep [cited 2018Mar];1(2):1–6. Available from: <https://www.indianjournals.com/ijor.aspx?target=ijor:ijpn&volume=1&issue=2&article=001>
9. Gezgin DM, Cakir O. Analysis of nomophobic behaviors of adolescents regarding various factors. Journal of human science . 2016May;13(2):2501–19.
10. Mobile phone use pattern and self-reported health problems among medical students. Journal of evolution of medical and dental sciences [Internet].

- 2016Mar [cited 2018Mar];5(21):1116–9. Available from: [https://www.jemds.com/latest-articles.php?at\\_id=10437](https://www.jemds.com/latest-articles.php?at_id=10437)
11. Prasad M, Patthi B, Singla A, Gupta R, Saha S, Kumar JK, Malhi R, Pandita V Nomophobia: A Cross-sectional Study to Assess Mobile Phone Usage Among Dental Students. *Journal of clinical and diagnostic research* [Internet]. 2017Feb [cited 2018Mar];11(2):ZC34–ZC39. Available from: <https://www.ncbi.nlm.nih.gov/pubmed/28384977>
  12. Dixit S, Shukla H, Bhagwat A, Bindal A, Goyal A, Zaidi A, et al. A study to evaluate mobile phone dependence among students of a medical college and associated hospital of central India. *Indian Journal of Community Medicine* [Internet]. 2010Apr;35(2):339–41. Available from: <https://www.ncbi.nlm.nih.gov/pmc/articles/PMC2940198>



# Production of Bioemulsifiers from Bacteria Grown on Hydrocarbons

Ghassan M. Ahmed

Assistant Lecture, Biotechnology Department/Institute of Genetic Engineering and Biotechnology for Graduate Studies/University of Baghdad

## Abstract

This work aimed to identify biosurfactant-producing bacterial strains isolated from hydrocarbon-contaminated sites and to evaluate their biosurfactant properties. The drop-collapse method and minimal agar added with a layer of diesel as carbon source were used for screening, positive strains were able to grow in a liquid medium, and surface tension and emulsification index were determined in cell-free supernatant and cell suspension. 250 bacterial isolate were tested, and 16 were positive for the drop-collapse and hydrocarbon-layer agar method. Most of the strains were *Pseudomonas*, except for three strains (*Acinetobacter*, *Bacillus*, and *Rhodococcus*). Surface tension was similar in cell-free and cell suspension measurements, with values in the range of 58 to 26 (mN/m), and all formed stable emulsions with engine oil (77-92% E<sub>24</sub>). Considering the variety of molecular structures among microbial biosurfactants, they have different chemical properties that can be exploited commercially, for applications as diverse as bioremediation or degradable detergents.

**Keywords:** Biosurfactants, emulsifiers, soil flora, hydrocarbon contamination.

## Introduction

One of the main causes of global contamination is the release of contaminants to the environment, including petroleum and petroleum-derived products<sup>(1)</sup>, which also exert a risk for human and animal health since many of these contaminants have demonstrated to be toxic and carcinogenic<sup>(2)</sup>. Microorganisms has proven to be effective to remove the effects soil and water contamination caused by hydrocarbon, using their metabolic abilities that can modify or use hydrocarbons as a source of carbon and energy. The compounds' chemical structure and its bioavailability (concentration, toxicity, mobility, and access) can affect the efficiency their degradation<sup>(3)</sup>. Many microorganisms produced Biosurfactants, to metabolize water-immiscible substrates, allowing its adsorption, emulsification,

or dispersion<sup>(4)</sup>. Aerobic microorganisms, using as carbon sources, hydrocarbons, animal or vegetal oils, or a mixture of them mainly synthesizes microbial biosurfactants<sup>(5, 6)</sup>. Biosurfactants can be remain attached to the cell wall (intracellularly) and/or could be released to the media<sup>(7, 8)</sup>. A wide range of variation in biosurfactants physical and biological properties are allowed by the main difference in the hydrophilic head chemical nature<sup>(9)</sup>.

The term biosurfactant and bioemulsifier are considered interchangeable, but although all bioemulsifiers are considered biosurfactants, not all the biosurfactants produce stable emulsions. Biosurfactants reduce surface tension between two liquids, while bioemulsifiers induce dispersion of undissolved material throughout the liquid, by formation and stabilization of droplets of the dispersed phase<sup>(10, 6)</sup>. Biosurfactants produced by Microorganisms are classified by its chemical composition and its microbial origin<sup>(10)</sup>. Glycolipids or lipopeptides (Low molecular weight biosurfactants) can diminish surface tension but does not form stable emulsions<sup>(3)</sup>.

---

### Corresponding Author:

Ghassan M. Ahmed

Assistant Lecture, Biotechnology Department/  
Institute of Genetic Engineering and Biotechnology for  
Graduate Studies/University of Baghdad  
e-mail: ghassan.m.ahmed@ige.uobaghdad.edu.iq

The biosurfactant-producing microbial strains is an interesting research area, due to the wide variety of uses

and the diversity of those molecules<sup>(11)</sup>. Several methods were used for isolation and screening of interesting bacterial strains; the easiest common method is the drop-collapse test<sup>(12)</sup>, which has been described that the used carbon source to grow the microorganisms, is important on the identification of biosurfactants producing strains<sup>(5)</sup>. This work is an attempt to identify biosurfactant and/or bioemulsifier producing bacteria from soil bacterial isolates obtained from sites contaminated by hydrocarbon.

## Methods

**Bacterial Strains:** Bacterial strains were isolated from soil contaminated obtained by selective enrichment<sup>(25)</sup>. Soil samples were taken and screened for hydrocarbon-degrading bacteria by inoculation into mineral salt agar (Na<sub>2</sub>HPO<sub>4</sub> 6g, KH<sub>2</sub>PO<sub>4</sub> 3g, NaCl 0.5g, NH<sub>4</sub>Cl .1 g, MgSO<sub>4</sub>·7H<sub>2</sub>O 0.24g, and CaCl<sub>2</sub> 0.01g, Bacto-Agar 15 g, distilled water 1 l) without carbon source added to the plates, and were incubated at 25°C in a chamber saturated with gasoline vapors from 5-7 days. Colonies with different morphology were selected and inoculated into Tryptic Soy Agar (TSA) to obtain pure cultures, and periodical transfer into TSA to maintain strains<sup>(13)</sup>.

**Growth Conditions:** Pure cultures were grown on broth added with glucose (2% w/v) olive oil, paraffin or sucrose (1% w/v), and incubated at 120 rpm for five days, according to Bodour and Miller<sup>(12)</sup>. After incubation, biosurfactant production was tested. Cells were recovered by centrifugation (12,000 x g, 5 min) and suspended in 1 ml of minimal saltbroth..

**Biosurfactant production evaluation and Surface Tension Determination:** The initial identification of biosurfactant-producing bacteria were done by drop-collapse method<sup>(14)</sup>. The tests were carried by triplicate, using culture supernatant and cell suspensions. Biosurfactant production was monitored in mineral salt agar plates added with a layer of a combustible material, according to the method proposed by Kiyohara *et al.*<sup>(15)</sup>. Plates were inoculated aseptically transferring a bacterial colony with sterile toothpicks were incubated at 28°C for 7 days.

In the drop-collapse test, Positive bacterial strains were also evaluated for surface tension and stable emulsion formation. Strains were grown in minimal saltbroth added with sucrose (1% w/v for *Acinetobacter*, *Bacillus*, *Rhodococcus*) or glucose (2% w/v for

*Pseudomonas*) and incubated for five days at 120 rpm. For measurements of surface tension, five ml of broth supernatant tube that was submerged in water bath at 28°C. Surface tension was calculated by measuring the height reached by the liquid when freely ascended through a capillary tube<sup>(16)</sup>. The surface tension was calculated according to the formula (2):

$$\gamma = \frac{rh\delta g}{2}$$

$\gamma$  = Surface tension (mN/m);

r = capillary radius (0.05 cm);

$\delta$  = Density (g/mL);

g = gravity (980 cm/s<sup>2</sup>);

h = height of the liquid column (cm).

**Emulsification Index Determination:** Two ml of supernatant or cell suspension and 3 ml of a selected hydrocarbon were mixed and vortexed in a test tube for 2 min and then maintained at 25°C. The height of the emulsions layer were measured after 24 h to calculate the emulsification index<sup>(3)</sup> according to the following equation used to determine the emulsification index (E<sub>24</sub>):

$$E_{24} = \left( \frac{\text{height of emulsion layer}}{\text{height of total solution}} \right) \times 100$$

## Results

**Bacterial Screening:** Bacterial isolate were obtained from two different soils contaminated with hydrocarbons (diesel and used engineoil<sup>(17)</sup>. 250 bacterial isolates were selected for the test of biosurfactants production based on their growth on minimal saltagar plates without a carbon source and incubated in a gasoline-saturated atmosphere.. Of all isolates, 82 were obtained from a site contaminated with used engine oil and 168 from a site contaminated with diesel. According to the initial characterization (colonial morphology, Gram stain, and biochemical tests), bacterial isolates belonged to the genera *Pseudomonas*, *Rhodococcus*, *Bacillus*, *Micrococcus*, *Staphylococcus*, *Acinetobacter*, and *Serratia*. All these genera were reported to be present in hydrocarbon-contaminated sites, and hydrocarbon degraders<sup>(18,1)</sup>.

Some microorganisms produce biosurfactants in water-insoluble substrates, such as vegetable or mineral oils, while other microorganisms can produce these

metabolites in presence of carbohydrates as carbon sources<sup>(5)</sup>. All 250 bacterial isolates were grown in mineral salt supplemented with glucose, sucrose or olive oil, and the supernatant was used to select for biosurfactant-producing bacteria by the drop-collapse

test. Sixteen isolates were positive and of those, 11 strains were growing in glucose, six in olive oil, and only three in sucrose; of those, three strains produced biosurfactants in olive oil as well as in glucose as substrates (Table 1).

**Table 1: Production of Biosurfactant and identification of isolates grown in glucose, sucrose and olive oil as the carbon source**

Isolate	Source	Genera	Gram stain	Glucose	Sucrose	Olive oil
S4M5	Diesel	Pseudomonas	N	-	-	+
S4M9	Diesel	Pseudomonas	N	+	-	+
S4Nb	Engine oil	Pseudomonas	N	+	-	-
S4Nc	Engine oil	Pseudomonas	N	+	-	+
S5B20	Diesel	Rhodococcus	P	-	+	-
S5C2	Diesel	Pseudomonas	N	+	-	-
S5C2c	Diesel	Pseudomonas	N	-	-	+
S5Z2	Diesel	Acinetobacter	N	-	+	-
S6Ba	Engine oil	Pseudomonas	N	-	-	+
ST – 7	Engine oil	Pseudomonas	N	+	-	-
S1M2	Diesel	Bacillus	P	-	+	-
S2M7	Engine oil	Pseudomonas	N	+	-	-
S33c	Engine oil	Pseudomonas	N	+	-	-
S22a	Engine oil	Pseudomonas	N	+	-	-
S4d1	Engine oil	Pseudomonas	N	+	-	-
S4M2	Diesel	Pseudomonas	N	+	-	-

The substrates used had been reported to promote biosurfactant production<sup>(14,19 and 20)</sup>. Although the biodegradation capacity of the 250 isolates has not been tested by the reduction of hydrocarbons in pure culture, many are likely to degrade hydrocarbons since they were isolated in mineral salt agar plates, incubated in a hydrocarbon-saturated atmosphere as carbon source. However, only a small proportion were biosurfactant producers, which support the concept of the bacterial community, that will help other microorganisms to degrade the wide variety of hydrocarbons found at the site<sup>(21,4)</sup>.

The drop-collapse test was considered positive when within one minute, the drop expanded on the oily surface of the microplate lid. Besides the 16 positive isolates, another 21 strains (18 in olive oil, one in maize starch, one in sucrose, and one in paraffin) showed a partial collapsed drop after one minute, suggesting that

those microorganisms produced only a small amount of biosurfactant, or it remained intracellular<sup>(14)</sup>.

The majority of the positive strains were identified as *Pseudomonas* spp., which are one of the most reported biosurfactant producer, and rhamnolipid had been reported that the most known biosurfactant that they produce<sup>(22,23)</sup>. Other *Pseudomonas* related microorganisms, such as *Burkholderia plantarii*<sup>(24)</sup> and *Ps. chlororaphis*<sup>(25)</sup> also reported as biosurfactants producer.

The 16 isolates described in Table (1) were inoculated in a mineral salt agar plate covered with a layer of a combustible material, a clear zone around the colonies was observed in the glucose-free plates after 24 h of incubation. Biosurfactants are liberated to the surroundings and emulsification occurs as the main mechanism to introduce water-insoluble substrates to the cell interior<sup>(18)</sup>.

Surface tension measurement showed that to give a positive drop collapse test, a surface tension lower than 45 mN/m was necessary. The surface tension of Mineral salt broth was 69.97 mN/m. No differences were observed in the surface tension of cell-free supernatants and cell suspensions for all bacterial strains tested ( $p > 0.05$ , data are shown), opposing results obtained by Batista *et al.*<sup>(11)</sup>. The lower surface tension values, both with or without cells, was reached by *Pseudomonas* strains (26.7 mN/m) and were closely followed by the *Bacillus* strain (33.32 mN/m) (Table 2).

Even though lipopeptides produced by *Bacillus* are known as one of the most powerful microbial biosurfactants<sup>(9)</sup>, *Pseudomonas* rhamnolipids are also effective, and both of them are extracellular<sup>(29)</sup>. The important point is, if a surfactant that reduces the surface tension of water can form stable emulsions<sup>(11)</sup>. The term emulsifier is often used in an application-oriented manner to describe the combination of all the surface-active compounds that constitute the bioemulsifier secreted by the cell to facilitate the assimilation of an insoluble substrate<sup>(6)</sup>. As described in Table 2, most of the strains that had lower surface tension values were also the ones that formed the largest and more stable emulsions. In addition, there was no significant difference between the emulsions formed by the released biosurfactant or the cell suspension ( $p > 0.05$ ). For all water-insoluble compounds tested, emulsions were more stable in the hydro carbonated portion of the oil-water mixture. When a supernatant without cells was used, emulsification index (after 24 hours) ranged from 0 to 99.9% for diesel, from 0.0 to 99.9% for kerosene, and from 76.2 to 92.8% for engine oil (Table 2). With high statistical differences between strains within each compound ( $F = 15.55$  for diesel,  $F = 99.9.60$  for kerosene and  $F = 2.35$  for engine oil respectively;  $p < 0.01$ ). For decane, the emulsion index was in the range of 0-10% and there were no differences among strains ( $p > 0.05$ ).

The emulsification index can vary with bacterial growth phase<sup>(13)</sup>. The highest emulsification index values of diesel, kerosene, and engine oil were detected for *Pseudomonas* strains. Monteiro *et al.*<sup>(22)</sup> reported an emulsification index of 70% after 30 days of incubation, demonstrating that emulsions produced by *P. aeruginosa* rhamnolipids are stable, and can be used in the control of environmental contamination. Only *Bacillus* and *Acinetobacter* formed stable emulsions with decane. Emulsions formed by *Acinetobacter* were small, but optically clear, probably due to vesicles rich in

phosphatidylethanolamine that are formed, as observed by Desai & Banat<sup>(10)</sup>, and the emulsion formed by *Rhodococcus* cells incorporated air in the emulsion, giving a column height higher than the controls.

## Conclusion

Hydrocarbon contaminated sites can be considered as enrichment environments for the selection of hydrocarbon degrading and/or biosurfactant producing microbial strains. Production of biosurfactants and bioemulsifiers by soil microorganisms provides them with an advantage in contaminated sited, since they can use water-insoluble carbon sources for growth.

**Conflict of Interest:** Nil.

**Source of Funding:** Self-funding

**Ethical Clearance:** Ethical Clearance from the institutional ethical committee obtained for the study.

## References

- 1 Rahman K, Rahman T, Korkoutas Y, Petsas I, Marchant R, Banat I. Enhanced bioremediation of n – alcano in petroleum sludge using bacterial consortium amended with rhamnolipid and micronutrients. *Bioresour. Technol.* 2003; 90, 159-168.
- 2 Prabhu Y, Phale P. Biodegradation of phenanthrene by *Pseudomonas* sp. Strain PP2: novel metabolic pathway, role of biosurfactant and cell surface hydrophobicity in hydrocarbon assimilation. *Appl. Microbiol. Biotechnol.* 2003; 61, 342-351.
3. Christofi N, Ivshina I. Microbial surfactants and their use in field studies of soil remediation. *J. Appl. Microbiol.* 2002; 93, 915-929.
4. Ron E. Rosenberg, E. Biosurfactants and oil bioremediation. *Current Opinion Biotechnol.* 2002; 13, 249-252.
5. Bognolo G. Biosurfactants as emulsifying agents for hydrocarbons. *Colloids Surfaces A: Physicochem. Engineering Aspects.* 1999; 152, 41-52.
6. Fiechter A. Biosurfactants: moving towards industrial application. *Tibtech.* 1992; 10, 208-217.
7. Bognolo G. Biosurfactants as emulsifying agents for hydrocarbons. *Colloids Surfaces A: Physicochem. Engineering Aspects.* 1999; 152, 41-52.
8. Lin SC. Biosurfactants: Recent advances. *J Chem. Tech Biotechnol.* 1996; 66:109-120.

9. Lu JR, Zhao XB, Yaseen M. Biomimetic amphiphiles: biosurfactants. *Current Opinion Colloid Interface Sci.* 2007; 12, 60-67.
10. Desai JD, Banat IM. Microbial production of surfactants and their commercial potential. *Microbiol. Mol. Biol. Rev.* 1997; 61, 47-64.
11. Batista SB, Mounteer AH, Amorim FR, Tótola MR. Isolation and characterization of biosurfactant/bioemulsifier-producing bacteria from petroleum contaminated sites. *Bioresour. Technol.*, 2006; 97, 868875.
12. Bodour AA, Drees KP, Maier RM. Distribution of biosurfactant-producing bacteria in undisturbed and contaminated arid Southwestern soils. *Appl. Environm. Microbiol.* 2003; 69, 3280-3287.
13. Koneman E. *Color Atlas and Textbook of Diagnostic Microbiology*. 6<sup>th</sup> Edition. Lippincott Williams & Wilkins, USA. 2005.
14. Batista, S.B.; Mounteer, A.H.; Amorim, F.R.; Tótola, M.R. Isolation and characterization of biosurfactant/bioemulsifier-producing bacteria from petroleum contaminated sites. *Bioresour. Technol.* 2006; 97, 868875.
15. Kiyohara H, Nagao K, Yano K. Rapid screen for bacteria degrading water-insoluble, solid hydrocarbons on agar plates. *Appl. Environm. Microbiol.* 1982; 43, 454-457.
16. Munguia T, Smith CA. Surface tension determination through capillary rise and laser diffraction patterns. *J. Chem. Educ.* 2001; 78, 343-344.
17. Nevárez-Moorillón GV, Piñón-Castillo H, Torres-Muñoz V, MuñozCastellanos LN, Vélez-Sánchez Verín C, Espinoza JV. et al. Soil contaminated with diesel (residual fuel no. 6). Remediation strategies. 2004; In Magar VI, Kelley ME. (eds). *In Situ and On-site Bioremediation-2003*. Battelle Press, Columbia OH. USA. Paper E-22
18. Bouchez M, Rakatozafy H, Marchal R, Leveau J, Vandecasteele J. Diversity of bacterial strains degrading hexadecane in relation to the mode of substrate uptake. *J. Appl. Microbiol.* 1999; 86, 421-428.
19. Olivera NL, Commendatore MG, Morán AC, Esteves JL. Biosurfactant-enhanced degradation of residual hydrocarbons from ship bilge wastes. *J. Ind. Microbiol. Biotechnol.* 2000; 25:70-73.
20. Vipulanandan C, Ren X. Enhanced solubility and biodegradation of naphthalene with biosurfactant. *J. Environm. Eng. Geophys.* 2000; 126, 629-633.
21. Rahman K, Banat I, Thahira J, Thayumamavan T, Lakshmanaperumalsamy, P. Bioremediation of gasoline contaminated soil by a bacterial consortium amended with poultry litter, coir pith and rhamnolipid biosurfactant. *Bioresour. Technol.* 2002; 81, 25-32.
22. Monteiro SA, Sasaki GL, Souza LM, Meira JA, Araújo JM, Mitchell DA. et al. Molecular and structural characterization of the biosurfactant produced by *Pseudomonas aeruginosa* DAUPE614. *Chem. Phys. Lipids* 2007; 147, 1-13.
23. Wu JY, Yeh K, Lu WB, Lin CL, Chang JS. Rhamnolipid production with indigenous *Pseudomonas aeruginosa* EM1 isolated from oil-contaminated site. *Bioresour. Technol.* 2008; 99, 1157-1164.
24. Andrä J, Rademann J, Howe J, Koch MHJ, Heine H, Zähringer U. et al. Endotoxin-like properties of a rhamnolipid exotoxin from *Burkholderia (Pseudomonas) plantarii*: immune cell stimulation and biophysical characterization. *Biol. Chem.* 2006; 387, 301-310.
25. Gunther IV, NW, Nuñez A, Fett W, Solaiman DYK. Production of rhamnolipids by *Pseudomonas chlororaphis*, a nonpathogenic bacterium. *Appl. Environm. Microbiol.* 2005; 71, 2288-2293.

# Prevalence of Head Lice (*Pediculus humanus capitis*) among Primary School Children in Baghdad Suburbs

Hadeel T. Al-Barrak

Lecturer Ph.D, College of Medicine, Ibn Sina University, Baghdad, Iraq

## Abstract

A cross-sectional school-based study was performed with the objectives to determine the prevalence of head lice infestation among primary schools in Baghdad suburbs (Abu Ghraib, Al-Yousifiya, Al-Radwanayah, Al-Al-Taji, and Al-Hussainiya). The study included examination of 920 male and female students in several elementary schools' class first to sixth (age 6-15 year). These schools include urban, rural, and economically and culturally diverse regions for the period from February to June 2018. The results of the current study showed that the total injury rate was 9%, and the Radwanayah region recorded the highest infection rate of 13.2 and the Al-Al-Taji rejoin region recorded the lowest (6.1%). The female infection rate was greater than that of males and reached 12.3 and 5.6 respectively. The results indicated a significant relationship between the spread of head lice and the educational status of parents, sharing of the head comb, and infection with dandruff.

**Keywords:** *Pediculus humanus capitis*, head lice, epidemiology.

## Introduction

Lice or head lice (*Pediculus humanus*) infestation is a public health problem in many developing countries where the WHO primary health care program is incompetent and random. Lice are parasitic insects that do not have wings, that live in the scalp and hair, and that they feed on small amounts of blood., And lead to skin irritation. In Iraq, external parasites, including head lice, remained neglected, according to the Center for Communicable Disease Control, in its annual reports (1986-1991), the presence of a total infection rate for head lice amounted to (0.047%) for the all population of the country. Although contamination of body lice has been almost eliminated in the world, but head lice can be seen all over the world and in Iraq, it can be seen in abundance especially in poor places with high population

density and lack of personal hygiene instructions. It is easy to spread, especially among children in school, direct contact with the injured, and Share tools, brushes, towels, blankets, and clothes <sup>(1)</sup>. Female head lice lay around 3000 eggs, and lice transmit many diseases, such as a disease Epidemic typhus, which causes Rickettsia bacteria (*Candidatus rieszia pediculicola*) that supply the lice with B-vitamins, absent in the human blood <sup>(2,3)</sup>, and recurrent fever while feeding on human blood and causing a high body temperature <sup>(4)</sup>. Several studies were conducted in Iraq, including AL kubiassy <sup>(5)</sup> in Baghdad and Kadir *et al* <sup>(6)</sup> in the city of Kirkuk and a study conducted by Jabber <sup>(7)</sup> in the city of Amara. Despite the use of insecticides in treating head lice insects, the misuse of these pesticides and their overuse led to the occurrence of insect resistance to them and thus increases the prevalence of that insect <sup>(8)</sup>. The objectives of the recent study are to determine the prevalence of head lice infestation among primary schools in Baghdad suburbs

---

## Corresponding Author:

Hadeel T. Al-Barrak

Lecturer Ph.D, College of Medicine, Ibn Sina University, Baghdad, Iraq

e-mail: dralbarrak222@gmail.com

Phone: +9647735150507

## Materials and Method

This cross-sectional descriptive study was conducted in primary school children urban and rural in Baghdad suburb s (Abu-Ghraib, Tagi, Al-Yousifiya, Al-Radwanayah and Al-Hussainiya regions from February

to June 2018. The study was conducted on 30 randomly selected primary schools to test the pupils from first to sixth grade. In general, 920 pupils residing in urban, and rural were selected in the 6-15 years age group studied individually and privately under a flashlight for all stages of the head lice life cycle such as lice/eggs (Nits), nymphs or adult lice. In this process, a handled magnifying lens was used to accurately display it using gloves and for the purpose of dispersing hair, thin wooden sticks were used to examine the presence of lice stages. The infestation was indicated when there was the adult, nymph or nits (eggs), The hair of each child examined for at least 2-3 minutes depending on hair longevity. Examined students were grouped according to their gender (sex) and age.

**Statistical Analysis:** Data analysis was analyzed using SPSS software, version 24. P- value  $\leq 0.05$  regarded statistical significance.

## Results and Discussion

The rate of head lice infestation in primary schools in the outskirts of Baghdad was 9% with an average infestation by Nits 3%, Nymphs 4.6% adults 8.7%, and the infestation by more than one stage was 4.3% of the infected pupils (Table 1).

**Table 1: The parasites stages on the infected head of pupils in the elementary schools of the suburbs of Baghdad**

Growth stage	Number examined	Infected	Infection rate %
Nits (Egg)	920	28	3.0 %
Nymph	920	42	4.6 %
Adult	920	80	8.7%
More than one stage	920	40	4.3 %
Chi squ are test P-value 0.001***			

\*\*\* Very high significant (P < 0.001)

The results indicated that there are statistical differences for head lice infestation between the suburban areas of Baghdad, where the region of Al-Radwanayah topped the infection rate by 13.4% and the lowest infection was recorded 6.1 % of the Al-Taji region (Table 2).

**Table 2: Prevalence of head lice infestation in relation to Baghdad suburbs**

Provence	Number examined	Infected	Infection rate %
Abu-Ghraib	177	17	9.6 %
Al-Hussainiya	171	13	7.6 %
Radwania	201	27	13.4%
Tagi	297	18	6.1 %
Yousfia	74	8	10.8 %
Total	920	83	9 %
Chi squ are test P-value 0.049			

In Iraq, several epidemiological studies of head-lice were performed and a wide range of infection rates was observed. In Baghdad the infestation rate ranged from 2.9%<sup>(9)</sup> to 48.9%<sup>(10)</sup>. In city of Kirkuk 20%<sup>(11)</sup>, in city of Samarra 15.29%<sup>(12)</sup>. And in Mosul 33.2%<sup>(13)</sup>. In addition, infestation in rural areas outpaced urban areas,

by 10.1% and 7.5% respectively, and that may be due to better hygiene in urban area, higher socio-economic levels, and better family education. These results were consistent with what found by Nejati<sup>(15)</sup>, who reported a 6.58% and 12.44% prevalence of pediculosis in urban and rural areas in Iran

The results also proved that the female infection was more than the male infection, as it recorded 12.3 % and 5.6 %, respectively (Table 3). This significant difference can be attributed to the behavior patterns between boys and girls, which have affected prevalence rate such as

girls' clothes. Moreover, girls generally have longer hair compared to boys and long hair that requires better combing. Moreover, fit female hair as a place for breeding head lice, covering female hair with scarf etc.

**Table 3: Prevalence of head lice infestation in relation to Gender**

Gender	Number examined	Infected	Infection rate %
Male	449	25	5.6 %
Female	471	58	12.3 %
Total	920	83	9 %
Chi square test P-value 0.001			

All Iraqi studies indicated a high rate of infection among females compared to that of males, and it is believed that the difference in the infection between the sexes with head lice does not have a physiological basis, but rather depends on the difference in hairstyle, as long, wavy hair is a predominant characteristic of older girls and the few number of cuts hair in females helps to maintain and permanence of the injury<sup>(16)</sup>. This phenomenon can be explained by the fact that girls have longer hair, which facilitates the transmission of lice from head to head, that they are more social, and often touch the hair of other girls. Additionally, in long hair, nits remain attached to hair growth accordingly, these

are signs of previous infection, which were successfully treated, and remained for months, while short boys' hair was cut, and led to removing head lice.

With regard to the relationship of head lice infestation with the age group (Table 4), it was observed that the highest rates of infection were a group of age 6–7 to 12-13 years % in both sexes ( $P > 0.05$ ). This result is consistent with what Al-Aboody (16) found that head lice infestation abounds within the ages from 7 to more than 11 year, and Salehi<sup>(17)</sup> who found that there were no statistical differences between the ages of primary school students for grades 1 through 6 in Isfahan, Iran.

**Table 4: Prevalence of head lice by age group of primary schools in Baghdad suburbs**

Age group	Number examined	Infected	Infection rate %
6-7 yr	339	35	10.3 %
8-9 yr	256	21	8.2 %
10-11 yr	214	18	8.4 %
12-13 yr	91	8	9.9 %
14–15 yr	20	1	5 %
Chi square test P-value 0.843			

In Present study, the frequency of washing of hair, the number of family members, sharing bed and towels, and the length of the hair did not differ significantly between affected and uninfected children. Whereas, parent education, the habits of sharing combs, and the presence of dandruff had a significant effect on the prevalence of head lice in pupils of elementary schools (Table 5). The percent of infected pupils whose

parents were uneducated was 19.1% compared to 4.5 for pupils whose parents were educated ( $P$ -value  $< 0.001$ ). Likewise, the percentage of infection increased with the presence of dandruff, where the infection rate was recorded 52 and 48%, respectively. Sharing combs recorded 97.6% of the haired combs. These results are consistent with Degirli<sup>(18)</sup>, Nejati<sup>(19)</sup>.



**Table 5: Prevalence of head lice in relation to frequency of bathing, sharing towel, sharing beds, sharing combs, hair length, and dandruff infection of primary schools in Baghdad suburbs**

Character	Number examined	Infected	Infection rate %	P-value
<b>Parent Education</b>				
Educated	637	29	4.5%	0.001***
Not educated	283	54	19.1%	
<b>Frequency of bathing</b>				
1 a week	789	71	9.0%	0.882
2 a week	115	10	8.7 %	
3 a week	16	2	12.5 %	
<b>Sharing Towel</b>				
Sharing	868	78	9.0	0.878
No Sharing	52	5	9.6	
<b>Sharing Beds</b>				
Sharing	54	29	9.0	0.992
No Sharing	599	321	9.0	
<b>Sharing Comb</b>				
Sharing	882	81	9.2	0.041*
No Sharing	38	2	5.3	
<b>Hair Length</b>				
Short	255	16	6.3	0.137
Medium	456	43	9.4	
Long	209	24	11.5	
<b>Dandruff</b>				
Infected	140	43	23.5	0.001***
Not infected	737	40	5.4	

\*,\*\*\* Probability value < 0.05, < 0.001 respectively

## Conclusion

The results obtained from the current study showed a greater prevalence among children aged 6-12 years with greater of the female gender, housing in rural areas, children who shared head combs jointly with the rest of the family, children with dandruff in the scalp and children whose parents are not educated. Our suggestion is that social and economic levels and health conditions should be improved for the successful treatment of lice infestation, by raising parents' awareness through educational programs.

**Conflict of Interest:** None

**Funding:** Self

**Ethical Clearance:** Not required

## References

- Hunter, J. A. and Barker S. C. Susceptibility of head lice (*Pediculus humanus capitis*) to pediculicides in Australia. *Parasitol. Res.*, 2003. 90 (6): 476–478.
- Kirkness, E. F., Haas, B. J., Sun, W., Braig, H. R., Perotti, M. A., Clark, J. M. Genome sequences of the human body louse and its primary endosymbiont provide insights into the permanent parasitic lifestyle. *Proc. Natl. Acad. Sci. U.S.A.* 2010.107, 12168–12173
- Boyd, B. M., and Reed, D. L. Taxonomy of lice and their endosymbiotic bacteria in the post-genomic era. *Clin. Microbiol. Infect.* 2012. 18, 324–331
- Chosidow, O. 2000. Scabies and pediculosis. *Lancet* 355, 819–826.
- Al-Kubiassy, W; Abdul Karim E.T. Head lice in pupils of two primary schools in Baghdad. *J Bahrain Med Soc.* 2003.15:34–38.
- Kadir, Mohammed A.; Dawood S. Awad; Khulood Talab Khalil Al-Sheikhly. Prevalence study of head lice among pupils in some primary schools

- in Kirkuk city and its effects in some of the hematological and biochemical parameters. *Tikrit Journal of Pure Sciences* 2012. 17 (3): 7-12
7. Jabber, Aswan Kadhium. Prevalence of head lice infestation among some primary school students in Amara city, *Mesan Research Journal*, 2005. volume 1 (2) -191.206
  8. Burgess, I. F. Human lice and their control. *Annu. Rev. Entomol.* 2004. 49:457\_481
  9. Al-Muethin, Thilal Mahdi Hassan. Comparison of prevalence of infection - with intestinal parasites and infection with family lice in Baal primary school students and kindergartens in Baghdad after nine years of the siege. Master Thesis, College of Science, University of Baghdad: 2011.151 pages.
  10. Al-Kubiassy, W; Abdul Karim E.T. Head lice in pupils of two primary schools in Baghdad. *J Bahrain Med Soc.* 2003.15:34–38.
  11. Kadir, Mohammed A.; Dawood S. Awad; Khulood Talab Khalil Al-Sheikhly. Prevalence study of head lice among pupils in some primary schools in Kirkuk city and its effects in some of the hematological and biochemical parameters. *Tikrit Journal of Pure Sciences* 2012. 17 (3): 7-12
  12. Al-Samarrai R.J. and Kadir, M.A. Prevalence of head lice among primary schools children in Sammara City urban and rural Samarra areas in – Salahaddin Province. *Med. J. Tikrit University*, 2000, 6, 47 – 51
  13. Al-Abady, A.I. Survey on tick infestation in humans, in Mosul city. *Tikrit J. Pure Sci.*, 2009. 14(2), 61-67.
  14. Nejati, J.; A. Keyhani; A. T. Kareshk; H. Mahmoudvand; A. Saghafipour; M. Khorminasab; R. Tavakoli Oliaee; S. M. Mosavi. Prevalence and Risk Factors of Pediculosis in Primary School Children in South West of Iran. *Iran J Public Health*, 2018. Vol. 47, No.12: 1923-1929
  15. Al-Affas, N. H. The incidence of the head lous (*Pediculus humanus capitis*) among pupils of two schools in Basrah city. *J. Comm. Med.*, 1993. 6 (1): 37 – 44
  16. Al-Aboudy, Bassd A. Prevalence of head Lice (*Pediculus humanus capitis*) among primary schools’ pupils in Nassirya city. *Um Salama Journal.* 2008. 5 (2): 207-210.
  17. Salehi, S.; M. Ban. A study of head lice infestation (*Pediculosis capitis*) among primary School Students in the village of Abadan in 2012, *IJCBNM* July 2014, vol 2, No.3: 195-198
  18. Degerli, S.; E. Malayali; and K. Y. Mumcuoglu. 2013. Head Lice Prevalence and Associated Factors in Two Boarding Schools in Sivas. *Turkiye Parazitol Derg.* 2013; 37: 32-35
  19. Nejati, J.; A. Keyhani; A. T. Kareshk; H. Mahmoudvand; A. Saghafipour; M. Khorminasab; R. Tavakoli Oliaee; S. M. Mosavi. Prevalence and Risk Factors of Pediculosis in Primary School Children in South West of Iran. *Iran J Public Health*, Vol. 47, No. 2018. 12: 1923-1929

# Estimating the Concentration of Lead and Cadmium for Some Areas of Najaf Governorate

Hakeem J. I.

*Assistance Prof., Department of Environment, Faculty of Science, University of Kufa, Najaf, Iraq*

## Abstract

The study showed that lead element is higher than the normal limits due to the high level of gases. Which makes the concentrations of lead vehicles in the fuel used high. Cadmium is within the normal level because the sources of this element in the study areas are limited.

**Keywords:** *Heavy metals, pollution, concertation, health, raw materials.*

## Introduction

Heavy elements, or what is known as heavy metals, are defined as those elements that are more than five times the density of water, and they have negative effects on the environment when they are used excessively, as they affect human, animal and plant health<sup>(1)</sup>.

Lead is one of the most dangerous and widespread pollutants as a result of the significant development achieved in the chemical and mining industries and the growing uses of this mineral in various technologies<sup>(2)</sup>. The importance of any source of exposure to lead differs according to the geographical location, climate, ground chemistry and industrial activities, as well as the exposure intensity that the individual faces with different age, gender, profession, food, and culture. The population of developing countries is higher because their lead protection rules are less stringent than in developed countries<sup>(3)</sup>.

Cadmium is one of the toxic heavy metals that play an important role in environmental pollution and constitutes a threat to human and animal health alike<sup>(4,5)</sup>, as it is found in nature in a pure form linked with other raw materials<sup>(6)</sup> and is excreted to the environment from industrial waste and from agricultural fertilizers<sup>(7)</sup>.

---

## Corresponding Author:

**Hakeem J. I.**

Department of Environment, Faculty of Science,  
University of Kufa, Najaf, Iraq  
e-mail: hakilaby@gmail.com

## Materials and Method

### Sample collection

**Soil samples were taken from the most traffic-crowded areas in the province of Najaf**

1. Intersection of the airport
2. The intersection of the twentieth revolution
3. The intersection of Al-Sahedrin
4. Al-Zahra'a intersection
5. Al-Wafa University intersection
6. Al Mukhtar Tunnel
7. The intersection of the northern transportation garage
8. The intersection of the southern transport garage
9. Najaf - Karbala checkpoint
10. Najaf Control - Abu Sukher

### The chemicals used:

1. Hydrochloric acid
2. Nitric acid

### Method of measuring concentrations

**After drying and grinding the sample and sifting it, we do the following**

1. Take (0.5) grams from the sample and put it in a conical flask
2. Digest the sample by adding a 3: 1 ratio of hydrochloric acid to nitric

3. Evaporate the sample by placing the beaker on a constant heat source until all the liquid has evaporated
4. We add nitric acid with 2% dilution.
5. Filter the sample and supplement the filtrate to 100 ml with distilled water
6. The sample is measured using atomic absorption technology

### Results and Discussion

Table 1 shows the concentration of lead in soil samples for some areas of Najaf Governorate. Table 2 shows the concentration of cadmium in soil samples for some areas of Najaf Governorate.

**Table 1 Concentrations of lead**

Region	Lead (ppm)
Al Mukhtar Tunnel	0.142
Najaf-Karbala checkpoint	0.171
The intersection of Al-Sahedrin	0.191
Twentieth Revolution Zone	0.174
The control of Abu Sakhir	0.12
Airport junction	0.161
The intersection of Wafa-Jahma	0.12
Southern garage	0.141
North garage	0.191
Al-Zahra'a intersection	0.135

**Table 2 Concentrations of cadmium**

Region	Cadmium (ppm)
Al Mukhtar Tunnel	0.0182
Najaf-Karbala checkpoint	0.015
The intersection of Al-Sahedrin	0.0189
Twentieth Revolution Zone	0.0121
The control of Abu Sakhir	0.011
Airport junction	0.01
The intersection of Wafa-Jahma	0.009
Southern garage	0.015
North garage	0.0058
Al-Zahra'a intersection	0.017

The study showed that the levels of the lead element are higher than the normal limits due to the high level of gases emitted from cars, as these areas are very congested, especially at peak time, and the lack of control over the specifications of fuel used in automobile engines, which makes the concentrations of lead vehicles in the fuel used high. Cadmium is within the normal level because the sources of this element in the study areas are limited.

### Conclusions

Lead element are higher than the normal limits due to the high level of gases emitted from cars. Cadmium is within the normal level because the sources of this element are limited.

**Ethical Clearance:** This study was approved by the Ethics Committee, University of Kufa. The study protocol was thoroughly explained for using samples. This investigation was done according to the principals of the Declaration of Helsinki.

**Source of Funding:** By Self

**Conflict of Interest:** Nil

### References

1. Heavy elements, sources and damages to the environment, promising research center in biological control and agricultural information, Qassim University, Saudi Arabia, 2012-1437.
2. World Health Organization Publication, Childhood lead poisoning, Geneva, Switzerland, 2010
3. OECD regulation, risk reduction monographs. Paris, France, 1993
4. Bhowmik Debjit, Kumar K. P. Sampath and Umadevi M. Lead Poisoning the Future of Lead's Impact Alarming on our society. The Pharma Innovation, vol. 1, No.6, 2012.
5. WHO/FAO/IAEA: Report on trace elements in human nutrition and human health, World Health Organization, Geneva, 1996.
6. Jarup, K., Berglund. Health effect of cadmium exposure Work Environ. Health, 24 (suppl. 1), 199.
7. Ikediobi, C. Response of antioxidant enzyme and redox, metabolites to cadmium induced oxidative stress in CRL-1439 normal rat liver cell. Int. J. Mol. Med., 14 (1):87-92. 2004

# Socio-demographic Predictors of Perceived Health among Syrian Refugees in Jordan

Hamza Alduraidi<sup>1</sup>, Ziyad Saleh<sup>2</sup>, Ayman Hamdan-Mansour<sup>3</sup>

<sup>1</sup>RN, MPH, PhD. Director, Accreditation Department, Accreditation and Quality Assurance Center; Assistant Professor, Community Health Nursing Department, School of Nursing, The University of Jordan, Amman, 11942, Jordan, <sup>2</sup>RN, PhD. Associate Professor, Clinical Nursing Department, School of Nursing, The University of Jordan, Amman, 11942, Jordan, <sup>3</sup>Professor, Community Health Nursing Department, School of Nursing, The University of Jordan, Amman, 11942, Jordan

## Abstract

The purpose of this study is to investigate the association between socio-demographic characteristics and perceived health among Syrian refugees in Jordan.

**Method:** A cross-sectional quantitative descriptive design was adopted, where a sample of 151 Syrian refugees living inside and outside camps in Amman, Jordan was surveyed for physical, psychological, social and environmental perceived health using a 12-item questionnaire.

**Results:** Each domain's score was computed out of 60. The mean perceived physical health was  $27.6 \pm 11.5$ ; perceived psychological health  $27.1 \pm 10.1$ ; perceived social health  $32.6 \pm 10.3$ ; and perceived environmental health  $30 \pm 9.1$ . Predictors of perceived physical health included age group  $F_{(2)} = 3.12$ ,  $p = .012$ , marital status  $F_{(3)} = 4.71$ ,  $p = .004$ , and income level  $F_{(2)} = 1.75$ ,  $p = .047$ . Predictors of perceived psychological health included income level  $F_{(2)} = 2.79$ ,  $p = .005$ , place of living  $t = 3.32$ ,  $p = .007$ , and marital status  $F_{(3)} = 4.09$ ,  $p = .034$ . Predictors of perceived social health included gender  $t = 2.04$ ,  $p = .026$ , age group  $F_{(2)} = 3.64$ ,  $p = .000$ , living place  $t = -3.61$ ,  $p = .031$ , and household size  $r = .61$ ,  $p = .048$ . And the only predictor of perceived environmental health included was place of living  $t = 5.64$ ,  $p = .000$ .

**Conclusion:** Living inside refugee camp, large household, poverty, older age, and being divorced or widow are associated with lower perceived health. Modifying some factors may help improve perceived health among Syrian refugees in Jordan and beyond.

**Keywords:** Perceived health, Socio-demographic predictors, Syrian refugees.

## Introduction

As a result of political turmoil, destruction, and armed conflict, millions of Syrians have become refugees, faced with the reality of fleeing their previous lives, their homes, and sometimes, even members of their families. They have headed to other regions in Syria, or other countries in search of safety and protection<sup>[1]</sup>. Since the fighting in Syria began in 2011, more than 470, 000 people have been killed, 1 million injured, and several millions forced to flee their homes for fear of persecution and seek asylum elsewhere<sup>[1]</sup>. Syrian refugees fled to neighboring nations such as Lebanon,

---

### Correspondence Author:

**Hamza Alduraidi, RN, MPH, PhD**

Director, Accreditation Department, Accreditation and Quality Assurance Center; Assistant Professor, Community Health Nursing Department, School of Nursing, The University of Jordan, Amman, 11942, Jordan

e-mail: h.alduraidi@ju.edu.jo

Phone: +962 6 5355000 Ext. 23169

Cell Phone: +962 7 7272 4079

Jordan, and Turkey in order to stay safe and salvage their lives and their family's lives<sup>[2]</sup>.

Jordan historically hosted several waves of refugees from neighboring countries, such as Palestine and Iraq<sup>[3]</sup>. Today, Jordan alone hosts over 680 thousand registered Syrian refugees, but this only represents a fraction of the total number of Syrian refugees in country, which is estimated to be 1.4 million, or 20% of Jordan's population<sup>[2]</sup>. The vast majority of Syrian refugee communities in Jordan (approximately 80%) are located in non-camp settings, specifically in cities close to the Northern border between Jordan and Syria, including Mafraq and Irbid, and in the capital, Amman<sup>[4]</sup>. Over 85% of Syrian refugee population live under poverty line<sup>[4]</sup>.

The aforementioned circumstances make the daily life of Syrian refugees filled with hardships and stressors on the physical and social levels. Syrian refugees often live with limited means to provide shelter and food to their children and families, representing basic necessities of survival<sup>[5]</sup>. There is no question that Syrian refugees residing in Jordan face grave and often insurmountable financial barriers towards accessing basic health services, which leads to poor health<sup>[3]</sup>. Therefore, this paper investigates the socio-demographic predictors of Syrian refugees' perceived physical, psychological, social and environmental health.

## Materials and Method

**Design:** A cross-sectional quantitative descriptive design was utilized to identify association between socio-demographic characteristics (such as gender, age group, place of living, family size, marital status, educational level, employment status and income level) as independent variables, and perceived physical, psychological, social and environmental health as dependent variables.

**Settings:** Sample was recruited from Syrian refugee communities inside Zaatari refugee camp, and in non-camp settings in greater Amman and Zarqaa.

**Sample and Population:** A sample of 151 registered Syrian refugees aged 18 years and above, willing to participate were included in this study. Those with terminal illnesses or severe disabilities were excluded.

**Data collection Procedures:** Data collection started after acquiring ethical approval from the Institutional

Review Board (IRB) Committee of the School of Nursing, The University of Jordan. Potential participants were approached in their communities between September and November 2019, merit of the study and its benefits were explained, informed consent was signed, and then the Arabic questionnaire was completed.

**Instrument:** The data was collected using a two-part questionnaire:

1. Socio-demographic data that include gender, age group, place of living, family size, marital status, educational level, employment status and income level.
2. A 12-item, Arabic, self-reported, perceived health questionnaire with four domains; perceived physical, psychological, social and environmental health. This questionnaire was developed by the authors in light of reviewing several international instruments. Face validity was confirmed by three experts.

**Pilot Study:** A pilot study on 22 subjects prior to the main study. Result showed satisfactory reliability with a Cronbach's alpha of .82.

## Findings:

**Sample Characteristics:** As presented in table (1), the sample consisted of 151 adult Syrian refugees whose ages ranged between 18 and 69 years, with a mean of 31.3 years (SD = 10 years). Age was recoded into three age groups for statistical purposes, as shown in the table. Majority (73.5%) were males, and married (54.3%), 31.8% were single, and those a few reported being widowed (7.3%) or divorced (6.6%). Ninety-one participants (60.3%) resided outside camp in Amman or Zarqaa', and 60 participants (39.7%) resided in Al-Azraq refugee camp. In terms of educational level, 38 participants (25.2%) reported receiving education lower than middle school, 20 participants (13.2%) had middle school education, 70 participants (46.4%) had high school education, and only 23 participants (15.2%) had some college or university degree. Those who reported a monthly family income below absolute poverty line (at about JD200 per month per household) were only 7 (7.3%), those who reported a family monthly income between absolute poverty line and poverty line (at about JD400 per month per household) were 36 (37.5%), and those who reported a family monthly income above poverty line were 53 (55.2%) (DOS, 2019). It is important to report that out of the 151 participants,

55 decided not to answer the income question, so the numbers in the table add up to 96 participants.

**Table 1. Sample Characteristics (N = 151)**

Characteristic	Count (%)
Gender Male	111 (73.5)
Female	40 (26.5)
Age Group 18-29 years	73 (48.3)
30-39 years	54 (35.8)
40 years or older	24 (15.9)
Marital Status Single	48 (31.8)
Married	82 (54.3)
Widowed	11 (7.3)
Divorced	10 (6.6)
Living Place Inside Camp	60 (39.7)
Outside Camp	91 (60.3)
Educational Level Below Middle School	38 (25.2)
Middle School	20 (13.2)
High School	70 (46.4)
College or Higher	23 (15.2)
Employment Status Unemployed	75 (49.7)
Employed	76 (50.3)
Family Monthly Income Level* Below JD199	7 (7.3)
JD200-299	36 (37.5)
JD300 or Higher	53 (55.2)

\*55 participants (36.4%) chose not to answer this question

### Perceived Health Scores

A 12-item, Arabic language questionnaire was used to test the perceived health score for each of the four domains; physical, psychological, social and environmental. Items of the questionnaire were Likert-scale type ranging from extremely poor to extremely satisfying. Each domain's score was computed out of 60.

The score for perceived physical health ranged between 4.5 and 56.9, with a mean of  $27.6 \pm 11.5$  out of 60; perceived psychological health scores ranged between 4 and 52.7 with a mean of  $27.1 \pm 10.1$  out of 60; perceived social health scores ranged between 6.8 and 60, with a mean of  $32.6 \pm 10.3$  out of 60; and perceived environmental health scores ranged between 5.8 and 58.8, with a mean of  $30 \pm 9.1$  out of 60.

**Socio-demographic Predictors:** The scores of each of the four domains of perceived health was tested for its association with socio-demographic characteristics. These characteristics included gender, age group, marital status, employment status, household size, educational level, income status, as well as living place (inside vs. outside camp). This association was tested using a series of independent-sample t tests, one-way ANOVA tests, and Pearson's r correlation tests according to each variable type. A number of socio-demographic characteristics were found to be significantly associated with each of the four domains' scores, and are therefore considered predictors.

Socio-demographic predictors of perceived physical health included age group, where participants aged 18-29 scored 31.3, those aged 30-39 scored 27.8, and those aged 40 or older scored only 24.4 ( $F_{(2)}=3.12$ ,  $p=.012$ ); marital status, where single participants scored 28.8, married scored 26.9, divorced scored 22.9, and widow/er scored only 22 ( $F_{(3)}=4.71$ ,  $p=.004$ ); and income level, where participants whose families receive a monthly income below JD199 scored only 25.8, those between JD200-299 scored 27, and those above JD300 scored 30.1 ( $F_{(2)}=1.75$ ,  $p=.047$ ).

Socio-demographic predictors of perceived psychological health also included monthly income level, where participants whose families receive a monthly income below JD199 scored only 28, those between JD200-299 scored 29.2, and those above JD300 scored 31.4 ( $F_{(2)}=2.79$ ,  $p=.005$ ); place of living, where refugees inside camps scored 26.9, and those outside camps scored 29.6 ( $t=3.32$ ,  $p=.007$ ); and marital status, where single participants scored 27.8, married scored 27.1, divorced scored 23.5, and widow/er scored only 22.9 ( $F_{(3)}=4.09$ ,  $p=.034$ ).

Socio-demographic predictors of perceived social health included gender, where males scored 32.6, and females scored 29.9 ( $t=2.04$ ,  $p=.026$ ); age group, where participants aged 18-29 scored 33, those aged 30-39 scored 29.7, and those aged 40 or older scored only 26.2 ( $F_{(2)}=3.64$ ,  $p=.000$ ); living place, where refugees living inside camps scored 32.6, and those living outside camps scored 27.3 ( $t=-3.61$ ,  $p=.031$ ), and household size, where a statistically-significant correlation was found between number of household members and perceived social health score (Pearson's  $r=.61$ ,  $p=.048$ ).

Finally, the only socio-demographic predictor of perceived environmental health was place of living, where refugees living inside camps scored 29.6, and those living outside camps scored 33.7 ( $t=5.64$ ,  $p=.000$ ). All other socio-demographic characteristics were not significantly associated with the score of environmental health domain.

### Discussion

Numerous research found a strong association between health and socio-demographic factors in several populations, namely among refugees<sup>[3]</sup>. Regarding living inside refugee camps, the findings of this study came in line with the results of a 2017 study by Alduraidi & Waters, where Palestinian refugees inside refugee camps fared worse in terms of both physical and environmental health, but fared better in terms of social relationships<sup>[5]</sup>. The explanation of these findings may be the strong connections between refugee families inside the camp, and the shared concerns, hopes and stressors between these families.

Regarding the association between poverty and inferior physical health, a 2015 study by Hamdan-Mansour and colleagues suggested that poverty predicted worse health and life satisfaction among Jordanian patients<sup>[6]</sup>. This association was also evident in a 2020 study by Alduraidi and colleagues, where Syrian refugees with lower financial resources demonstrated lower resilience than their younger counterparts<sup>[7]</sup>.

In terms of the association between age and perceived physical and psychological health, the findings of this study came in line with those of a 2017 study by Hamdan-Mansour and colleagues and a 2020 study by Khatib and colleagues, as well as a 2020 study by Alduraidi and colleagues<sup>[8-9-7]</sup>. It is worth mentioning that another 2017 study by Hamdan-Mansour and colleagues, and a 2019 study by Saleh and colleagues have revealed that the older the person, the more likely he/she is to express inferior physical health problems both subjectively and objectively<sup>[10-11]</sup>.

Furthermore, relatively-high numbers of divorced and widow individuals, and relatively large family size are characteristics of refugee communities as revealed in a 2018 study by Alduraidi & Waters, where these socio-demographic characteristics were found to be significantly associated with distress, sadness, and poor perceived psychological health<sup>[3]</sup>.

### Conclusion

The findings of this study provide an evidence that some modifiable socio-demographic characteristics are associated with inferior perceived health scores among Syrian refugees in Jordan. Poverty and large household size were associated with inferior perceived physical, psychological and social health. It is, therefore, recommended that policy makers should target resolving the problem of limited financial resources and large family size among Syrian refugees in Jordan.

Living inside refugee camp was associated with inferior perceived psychological and environmental health on one hand. On the other hand, perceived social health inside the camp was superior. Policy makers should, therefore, establish psychological/mental health services, and work on improving physical environmental conditions inside the camp. Meanwhile, policy makers should implement solutions for promoting social support networks among refugees outside the camp. Finally, older refugees, divorced and widow individuals expressed low scores in several domains. Thus, policy makers are invited to implement programs to help promote health in these special demographics.

**Conflict of Interest:** The authors declare no conflict of interest related to publication of this article.

**Financial Disclosure:** There is no financial disclosure.

**Ethical Clearance:** The study has been approved by the ethics and research committee at The school of Nursing, The University of Jordan.

### References

1. Rizkalla, N., & Segal, S. P. Well-Being and Posttraumatic Growth Among Syrian Refugees in Jordan. *Journal of Traumatic Stress*, 2018. 31(2), 213–222. <https://doi.org/10.1002/jts.22281>
2. United Nations High Commissioner for Refugees. External Statistical Report on Active Registered Syrians in Jordan; 2200. <http://data.unhcr.org/syrianrefugees/download.php?id=8714>. Accessed June 2, 2020
3. Alduraidi H, Waters CM. Depression, Perceived Health, and Right-of-Return Hopefulness of Palestinian Refugees. *J Nurs Scholarsh*. 2018; 50(2):163-171. doi:10.1111/jnu.12363



4. Government of Jordan, Fafu Institute for Applied International Studies. The living conditions of Syrian refugees in Jordan: Results from the 2017-2018 survey of Syrian refugees inside and outside camps. Retrieved March 13, 2019 from: <https://reliefweb.int/report/jordan/living-conditions-syrian-refugees-jordan-results-2017-2018-survey-syrian-refugees>
5. Alduraidi H, Waters CM. Health-related quality of life of Palestinian refugees inside and outside camps in Jordan. *Nurs Outlook*. 2017;65(4):436-443. doi:10.1016/j.outlook.2017.05.007
6. Hamdan-Mansour AM, Al Abeiat DD, Alzoghaibi IN, Ghannam BM, Hanouneh S I. Psychosocial and sociodemographic correlates of life satisfaction among patients diagnosed with cancer in Jordan. *J Cancer Edu* 2015; 30(1): 31-36.
7. Alduraidi H, Dardas LA, Price MM. Social Determinants of Resilience Among Syrian Refugees in Jordan. *J PsychosocNurs Ment Health Serv*. 2020;58(8):31-38. doi:10.3928/00989134-20200624-04
8. Hamdan-Mansour A. Sociodemographic correlates of somatic symptoms of older persons in Jordan. *Jordan Med J* 2017; 51 (3): 119-130.
9. Khatib A, Hamdan- Mansour A, Ratrouf H, Alenezi A, Chahien T. Testing the effectiveness of integrated elderly care model on quality of care and health outcomes among hospitalized elderlies in West Bank. *Malaysia Journal of Public Health Medicine* 2020; 20(1): 82-89.
10. Hamdan-Mansour A, Shehadeh J, Puskar K, El-Hneiti M, M Haourani E. Investigating physical, psychological and social well-being of older persons in Jordan. *Current Aging Science*. 2017 Aug 1;10(3):217-23.
11. Saleh ZT, Lennie TA, Alhurani AS, Almansour IM, Alduraidi H, Moser DK. High Dietary Sodium Intake is Associated with Shorter Event-Free Survival in Patients with Heart Failure and Comorbid Diabetes [published online ahead of print, 2019 Nov 18]. *Clin Nurs Res*. 2019;1054773819888743. doi:10.1177/1054773819888743.

# Predictors of Psychosocial Burden among Workers During the COVID-19 Pandemic Period in Indonesia

Hario Megatsari<sup>1</sup>, Agung Dwi Laksono<sup>2</sup>, Mursyidul Ibad<sup>3</sup>, Yeni Tri Herwanto<sup>4</sup>, Kinanty Putri Sarweni<sup>4</sup>, Rachmad Ardiansyah Pua Geno<sup>4</sup>, Estiningtyas Nugraheni<sup>4</sup>

<sup>1</sup>Faculty of Public Health, Universitas Airlangga, Surabaya, Indonesia, <sup>2</sup>Researcher, National Institute of Health Research and Development, the Indonesian Ministry of Health, Jakarta, Indonesia, <sup>3</sup>Researcher, Faculty of Health, Nadlatul Ulama University, Surabaya, Indonesia, <sup>4</sup>Researcher, The Indonesian Public Health Union, Makassar, Indonesia.

## Abstract

Psychosocial burden as a result of the risk of decreasing income and the possibility of being laid off from work is a problem that must be faced by workers during the COVID-19 pandemic. The study was aimed at analyzing predictors of psychosocial burden among workers during the co-19 pandemic period. A total of 6,053 worker respondents were involved in this study. The psychosocial burden was reviewed based on the worries level. There were 4 independent variables involved in the analysis, including age, gender, marital, and education. A multivariate test was performed using binary logistic regression. The results found that the workers in the  $\leq 19$  age group were 1.900 times more likely than the  $\geq 50$  age group to experience a psychosocial burden. The workers in the 40-49 age group were 1.523 times more likely than the  $\geq 50$  age group. Male workers were 0.693 times more likely than female workers to experience a psychosocial burden. The higher education workers were 0.563 times more likely than workers with secondary education. It could be concluded that the 3 variables were proven as predictors of the psychosocial burden among workers during the COVID-19 pandemic period in Indonesia, namely age, gender, and education.

**Keywords:** *Mental health, workers, psychosocial burden, health behavior, COVID-19.*

## Introduction

The pandemic of COVID-19 is not going to end very soon shortly. There are some arguments to support the statement. The most recent number of COVID-19 cases in the world indicate that the number of new cases was increasing in the past 7 days from July 9<sup>th</sup>, 2020 to July 16<sup>th</sup>, 2020. The detailed information can be accessed in the [www.worldometers.info/coronavirus/](http://www.worldometers.info/coronavirus/). Based on the website, it was also informed that the mortality rate of this disease was around 7% at the global level.

The number of COVID-19 cases in Indonesia has not decreased trend. It can be seen on the official website of the government, namely [www.covid19.go.id](http://www.covid19.go.id). Based on the website accessed on July 15<sup>th</sup>, 2020, the number of COVID-19 cases in Indonesia spread all over the province and district/city. And there is no indication the outbreak will end soon<sup>1</sup>.

The Indonesia government has taken several strategies to stop the chain of transmission of COVID-19. Some of the strategies are issuing Minister of Health Regulation No. 9 of 2020 concerning Large-Scale Social Limitation Guidelines in the context of accelerating the handling of COVID-19. The regulation regulates the restrictions that must be obeyed by the society. These restrictions include schools being closed, public transportation stopped, work from home, and so on. The main idea of the regulation is to lessen the movement of the community<sup>2,3</sup>.

---

### Corresponding Author:

**Hario Megatsari**

Faculty of Public Health, Universitas Airlangga,  
Surabaya, Indonesia

e-mail: [hario.megatsari@fkm.unair.ac.id](mailto:hario.megatsari@fkm.unair.ac.id)

The impact of these regulations and restrictions have an impact on all sectors of social life, namely religious aspects, economic aspects, aspects of education, and aspects of social psychology. This can be seen from the many facts reported by the mass media about the impact of these restrictions, including the existence of a group of people who still have to work even though the regulation has been enforced in their territory<sup>4</sup>. The longer the Large Scale Social Restrictions, the more violations committed by the community<sup>5</sup>.

The limitation of community mobility during COVID-19 can potentially trigger anxiety in the form of depression and stress on society<sup>6,7</sup>. Anxiety is also reported because of the health beliefs that originate from the large amount of hoax information scattered on social media, which worsens the atmosphere<sup>8-10</sup>. The situation of the mass psychology getting worse due to the theory of conspiracy echoed by celebrities and influencers<sup>11,12</sup>, including conspiracy theories believed by the president of the USA, Donald Trump, as a form of celebrities and influencers resistance to the existence of the power of his government<sup>13</sup>.

Public anxiety can lead to new public health problems. WHO defines health as a good condition in 3 dimensions of human life, namely the physical, social, and mental dimensions<sup>14</sup>. Anxiety is included in an unhealthy condition in WHO's perspective, so special attention is needed to pay close attention to the community's situation, especially in the current outbreak of COVID-19. On the other hand, the rate of unemployment during COVID-19 was increasing due to the situation of pandemic<sup>15,16</sup>. Based on the background description, this study is intended to analyze the predictors of psychosocial burden among workers during the COVID-19 pandemic period in Indonesia.

## Materials and Method

The study was conducted by collecting data through online surveys of people who claimed to have jobs, who are domiciled throughout Indonesia. Data collection was carried out for 8 days (June 6-13, 2020). A total of 6,053 worker respondents were included in this analysis.

Psychosocial burden variables were arranged based on the worries level. The worries level was built based on the assessment of anxiety in 5 aspects of daily life, namely economic, religious, educational, employment, and social aspects. The questions in the questionnaire

were arranged with five answer choices (Likert scale). Assessment of the worries level by adding up scores from 5 aspects measured, then dividing it into 2 categories of psychosocial burden, which were not worried and worried.

Four independent variables were included in the analysis. The four variables are age group, gender, marital status, education level. Age group was the respondent's acknowledgment of the last birthday that has passed. Age groups were divided into 6 categories, namely  $\leq 19$ , 20-29, 30-39, 40-49, and  $\geq 50$ . Gender was divided into 2 categories, namely male and female. Marital status consists of 3 categories, namely single, married, and divorced/widowed. Education level was the respondent's recognition of the level of education that has been passed. Education level was divided into 2 categories, namely secondary and below, and higher.

The variables involved in this study, both dependent and independent, were dichotomous variables. Researchers used the bivariate test at an early stage with the Chi-Square test. This initial test was to select the independent variables that will be included in the next test phase. The multivariate test at the final stage was carried out using binary logistic regression to determine the predictors of psychosocial burden among workers during the COVID-19 pandemic period in Indonesia. All stages of analysis in this study were carried out with the help of SPSS software version 22.

## Results and Discussion

Table 1 is a display of descriptive statistics of the characteristics of worker respondents. It can be seen that workers who have a psychosocial burden are dominated by workers who are in the age group of 20-29 and have female gender.

Based on marital status, the married workers dominate groups that have a psychosocial burden. While based on education level, the workers who have higher education dominate both categories of the psychosocial burden.

Information about the result of the binary logistic regression of psychosocial burden among workers during the COVID-19 pandemic period in Indonesia is presented in Table 2. All selected variables are included in this final analysis.

**Table 1. Descriptive Statistics of Respondent Characteristics (n=6,053)**

Variables	The psychosocial burden				P
	Not worried		Worried		
	n	%	n	%	
<b>Age groups</b>					<b>***&lt; 0.001</b>
≤ 19	16	1.7%	131	2.6%	
20-29	234	25.2%	2028	39.6%	
30-39	238	25.6%	1401	27.3%	
40-49	229	24.7%	992	19.4%	
≥ 50	211	22.7%	573	11.2%	
<b>Gender</b>					<b>***&lt; 0.001</b>
Male	414	44.6%	1716	33.5%	
Female	514	55.4%	3409	66.5%	
<b>Marital status</b>					<b>***&lt; 0.001</b>
Single	242	26.1%	1861	36.3%	
Married	652	70.3%	3110	60.7%	
Divorced/Widowed	34	3.7%	154	3.0%	
<b>Education level</b>					<b>***&lt; 0.001</b>
Secondary and below	160	17.2%	1609	31.4%	
Higher	768	82.8%	3516	68.6%	

Note: \*p <0.05; \*\*p <0.01; \*\*\*p <0.001.

**Table 2. The result of binary logistic regression of psychosocial burden(the worries level) of community in Indonesia, 2020 (n=6,053)**

Variables	The psychosocial burden			
	Sig	OR	Lower Bound	Upper Bound
Age groups: ≤ 19	*0.041	1.900	1.026	3.519
Age groups: 20-29	***< 0.001	2.652	1.999	3.518
Age groups: 30-39	***< 0.001	1.992	1.607	2.470
Age groups: 40-49	***< 0.001	1.523	1.227	1.889
Age groups: ≥ 50	-	-	-	-
Gender: Male	***< 0.001	0.693	0.598	0.803
Gender: Female	-	-	-	-
Marital status: Single	-	-	-	-
Marital status: Married	0.112	1.210	0.957	1.532
Marital status: Widowed/Divorced	0.690	1.094	0.702	1.706
Education Level: Secondary	-	-	-	-
Education Level: Higher	***< 0.001	0.563	0.458	0.692

Note: \*p <0.05; \*\*p <0.01; \*\*\*p <0.001.

Table 2 shows that the workers in the  $\leq 19$  age group were 1.900 times more likely than the  $\geq 50$  age group to experience a psychosocial burden (OR 1.900; 95% CI 1.026-3.519). The workers in the 20-29 age group were 2.652 times more likely than the  $\geq 50$  age group to experience a psychosocial burden (OR 2.652; 95% CI 1.999-3.518). The workers in the 30-39 age group were 1.992 times more likely than the  $\geq 50$  age group to experience a psychosocial burden (OR 1.992; 95% CI 1.607-2.470). The workers in the 40-49 age group were 1.523 times more likely than the  $\geq 50$  age group to experience a psychosocial burden (OR 1.523; 95% CI 1.227-1.889). Information from the results of this analysis shows that age is a predictor of psychosocial burden among workers during the COVID-19 pandemic period in Indonesia. The workers who have the oldest age have the lowest possibility to experience psychosocial burdens.

Age as a predictor of psychosocial burden is also reported in several studies in various countries<sup>17-19</sup>. Older age is directly proportional to more life experiences. The senior workers have a more coping mechanism in dealing with uncertain situations during the COVID-19 pandemic period<sup>20,21</sup>.

Table 2 informs that male workers are 0.693 times more likely than female workers to experience psychosocial burden (OR 0.693; 95% CI 0.598-0.803). The results of this analysis indicate that gender is a predictor of psychosocial burden among workers during the COVID-19 pandemic period in Indonesia. The female workers have a higher chance of experiencing psychosocial burden.

Consistent information was also found in previous studies. The female group was reported to have more potential to experience mental disorders in the form of depression and anxiety compared to the male group<sup>22</sup>. Male workers are considered more able to cope with uncertainty pressures during the pandemic than female workers<sup>23</sup>.

Table 2 shows that workers with higher education are 0.563 times more likely than workers with secondary education to experience psychosocial burden (OR 0.563; 95% CI 0.458-0.692). This information shows that education level is a predictor of psychosocial burden among workers during the COVID-19 pandemic in Indonesia. Higher education has a lower probability of experiencing psychosocial burden.

Better education is directly proportional to the ability of workers to respond to the COVID-19 pandemic situation. Educational factors make a person able to understand information and digest the situation better so that they are better prepared to deal with uncertain situations during the COVID-19 pandemic<sup>24,25</sup>. Several previous studies inform that education is often found as a positive predictor of health sector performance<sup>26-28</sup>.

## Conclusions

Based on the results of the analysis it could be concluded that 3 variables were proven to be predictors of the psychosocial burden among workers during the co-19 pandemic period in Indonesia. The four variables were age group, gender, and education level.

**Acknowledgments:** The author would like to thank all the Persakmi and IKA Airlangga Surabaya who have allowed the use of online survey data about this psychosocial.

**Source of Funding:** Self-funding

**Conflict of Interest:** The authors declare no conflict of interest, financial or otherwise.

**Ethical Clearance:** This study of the psychosocial burden of community during the COVID-19 pandemic period in Indonesia has received ethical approval from the national ethics commission (No: RK.05/KEPK/STIK/VIK/2020). The respondents' identities have all been deleted from the dataset. Respondents have provided written approval for their involvement in the study.

## References

- Hoseinpour Dehkordi A, Alizadeh M, Derakhshan P, Babazadeh P, Jahandideh A. Understanding epidemic data and statistics: A case study of COVID-19. *J Med Virol.* 2020;92(7):868–82.
- Task Force for the Acceleration of Handling COVID-19. COVID-19 Health Handling Protocol (Protokol Kesehatan Penanganan COVID-19) [Internet]. Indonesia; 2020 p. 1–10. Available from: <https://covid19.go.id/p/protokol/protokol-kesehatan-penanganan-covid-19>
- Laksono AD, Wulandari RD, Ibad M, Herwanto YT, Sarweni KP, Geno RAP, et al. Predictors of Healthy Lifestyle in The COVID-19 Pandemic Period in East Java, Indonesia. *J Crit Rev.* 2020;7(18):1515–21.

4. Laksono AD, Ibad M, Herwanto YT, Sarweni KP, Geno RAP, Nugraheni E. Evaluation of the Implementation of Large Scale Social Restrictions in East Java, Indonesia (Evaluasi Pelaksanaan Pembatasan Sosial Berskala Besar di Jawa Timur, Indonesia) [Internet]. Surabaya; 2020. Available from: [https://www.researchgate.net/publication/342053442\\_Evaluasi\\_Pelaksanaan\\_Pembatasan\\_Sosial\\_Berskala\\_Besar\\_di\\_Jawa\\_Timur](https://www.researchgate.net/publication/342053442_Evaluasi_Pelaksanaan_Pembatasan_Sosial_Berskala_Besar_di_Jawa_Timur)
5. Ibad M, Laksono AD, Herwanto YT, Sarweni KP, Geno RAP, Nugraheni E. East Java Needs “Public Health” Police (Jawa Timur Perlu Polisi “Kesehatan Masyarakat”) [Internet]. Surabaya; 2020. Available from: [https://www.researchgate.net/publication/341627090\\_JAWA\\_TIMUR\\_PERLU\\_POLISI\\_KESEHATAN\\_MASYARAKAT](https://www.researchgate.net/publication/341627090_JAWA_TIMUR_PERLU_POLISI_KESEHATAN_MASYARAKAT)
6. Bohlken J, Schömig F, Lemke MR, Pumberger M, Riedel-Heller SG. COVID-19 Pandemic: Stress Experience of Healthcare Workers: A Short Current Review. *Psychiatr Prax.* 2020;47(4):190-7.
7. Fawaz M, Samaha A. The psychosocial effects of being quarantined following exposure to COVID-19: A qualitative study of Lebanese health care workers. *Int J Soc Psychiatry.* 2020;In press:In press.
8. Costa MF da. Health belief model for coronavirus infection risk determinants. *Rev Saude Publica.* 2019;54(47):1–12.
9. Athbi HA, Hassan HB. Health Beliefs of Patients with Coronary Heart Disease toward Secondary Prevention: The Health Beliefs Model as a Theoretical Framework. *Indian J Public Heal Res Dev.* 2019;10(1):272–8.
10. Evans G. Questions: COVID-19 mortality, conspiracy theories, and the mysterious lack of sick children: “Flu has a mortality of 0.1% - This has a mortality 10 times that.” *Hosp Infect Control Prev.* 2020;47(4):1.
11. Task Force for the Acceleration of Handling COVID-19. Hoax Buster [Internet]. Jakarta; 2020. Available from: <https://covid19.go.id/p/hoax-buster>
12. Meiryani, Siagian P, Lusianah, Lesmana T. Technology’s role to avoid the spread of COVID-19. *Int J Psychosoc Rehabil.* 2020;24(7):9902–9.
13. Dyer O. Trump claims public health warnings on covid-19 are a conspiracy against him. *BMJ.* 2020;BMJ (Clini:m941).
14. World Health Organization. Preamble to the Constitution of WHO. New York, Geneva; 1946.
15. Sri Kasnelly FAJ. MENINGKATNYA ANGKA PENGANGGURAN DITENGAH PANDEMI (COVID-19). *Al-Mizan J Ekon Syariah.* 2020;3(1).
16. Tran BX, Vu GT, Latkin CA, Pham HQ, Phan HT, Le HT, et al. Characterize health and economic vulnerabilities of workers to control the emergence of COVID-19 in an industrial zone in Vietnam. *Saf Sci.* 2020;129:Article number 104811.
17. Gualano MR, Lo Moro G, Voglino G, Bert F, Siliquini R. Effects of COVID-19 lockdown on mental health and sleep disturbances in Italy. *Int J Environ Res Public Health.* 2020;17(13):1–13.
18. Mazza C, Ricci E, Biondi S, Colasanti M, Ferracuti S, Napoli C, et al. A nationwide survey of psychological distress among italian people during the covid-19 pandemic: Immediate psychological responses and associated factors. *Int J Environ Res Public Health.* 2020;17(9):Article number 3165.
19. Dubey S, Biswas P, Ghosh R, Chatterjee S, Dubey MJ, Chatterjee S, et al. Psychosocial impact of COVID-19. *Diabetes Metab Syndr Clin Res Rev.* 2020;14(5):779–88.
20. Ozamiz-Etxebarria N, Idoiaga Mondragon N, Dosil Santamaria M, Picaza Gorrotxategi M. Psychological Symptoms During the Two Stages of Lockdown in Response to the COVID-19 Outbreak: An Investigation in a Sample of Citizens in Northern Spain. *Front Psychol.* 2020;11:Article number 1491.
21. Ozamiz-Etxebarria N, Dosil-Santamaria M, Picaza-Gorrochategui M, Idoiaga-Mondragon N. Stress, anxiety, and depression levels in the initial stage of the COVID-19 outbreak in a population sample in the northern Spain. *Cad Saude Publica.* 2020;36(4):Article number e00054020.
22. Kiely KM, Brady B, Byles J. Gender, mental health and ageing. *Maturitas.* 2019;129:76–84.
23. Ballering AV, Bonvanie IJ, Olde Hartman TC, Monden R, Rosmalen JGM. Gender and sex independently associate with common somatic symptoms and lifetime prevalence of chronic disease. *Soc Sci Med.* 2020;253:Article number 112968.
24. Roy D, Tripathy S, Kar SK, Sharma N, Verma SK,

- Kaushal V. Study of knowledge, attitude, anxiety & perceived mental healthcare need in Indian population during COVID-19 pandemic. *Asian J Psychiatr.* 2020; In press: Article number 102083.
25. Chen Q, Min C, Zhang W, Wang G, Ma X, Evans R. Unpacking the black box: How to promote citizen engagement through government social media during the COVID-19 crisis. *Comput Human Behav.* 2020;110:Article number 106380.
  26. Wulandari RD, Laksono AD. Education as predictor of the knowledge of pregnancy danger signs in Rural Indonesia. *Int J Innov Creat Chang.* 2020;13(1):1037–51.
  27. Wulandari RD, Laksono AD. Determinants of knowledge of pregnancy danger signs in Indonesia. *PLoS One.* 2020;15(5):Article number e0232550.
  28. Ipa M, Widawati M, Laksono AD, Kusriani I, Dhewantara PW. Variation of preventive practices and its association with malaria infection in eastern Indonesia: Findings from community-based survey. *PLoS One.* 2020;15(5):e0232909.

# Relationship of Family Support with Anxiety Levels in Preschool Children Hospitalized in Pediatric Ward Syech Yusuf Hospital Gowa Regency, Indonesia

Hartati<sup>1</sup>, St. Aminah<sup>2</sup>, Muh. Yusuf M.<sup>3</sup>

<sup>1</sup>Associate Professor, <sup>2</sup>Associate Professor, <sup>3</sup>Associate Professor in Department of Nursing, Researcher in the Center of Excellent on Urban Health of Health Polytechnic of Makassar, Indonesia

## Abstract

The family is a collection of two or more people, with each other tied to each other emotionally, and living in the same area in an adjacent area. Family support is the attitude, actions, and acceptance of the family of its members. Anxiety is an individual's response to an unpleasant situation experienced by all living things in everyday life. The purpose of this study was to determine the relationship of family support with anxiety levels in pre-school age children in the children's care room at Syech Yusuf Hospital Gowa Regency. This research method was analytic descriptive with a cross-sectional study design. The research sample of 31 people using Purposive Sampling techniques. Place of research in the Children's Care Room Syech Yusuf Hospital Gowa Regency. The study was conducted from July to October 2019. The data collection used questionnaire sheets. Data analysis using the chi-square test. The results showed that family support of 31 respondents, the highest frequency of respondent family support was good as many as 16 respondents (51.6%) and the lowest frequency was enough as many as 15 respondents (48.4%). Data on children's anxiety level were obtained from 31 respondents, the highest frequency of respondents' anxiety level was 19 respondents (61.3%) and the lowest frequency was weight, which was 12 respondents (38.7%). Based on the results of the Chi-Square statistical tests that have been done, it was obtained that the value of  $X^2 = 14,685$  with a significant level of  $p = 0,000$  with  $\alpha = 0.05$ . The conclusion of the study showed that there was a relationship between family support and anxiety levels in preschool children.

**Keywords:** *Family Support, child anxiety level.*

## Introduction

Family support is the attitude, actions, and acceptance of the family of its members. Family members see that supportive people are always ready to provide help and assistance if needed.<sup>1</sup>

Family social support is a process that occurs throughout life, the nature and type of social support vary in various stages of the life cycle. However, at all stages of the life cycle, family social support makes the family able to function with a variety of intelligence and reason. As a result, this improves health and family adaptation.<sup>1</sup>

Family social support refers to social support that is seen by the family as something that can be accessed or held for the family (social support can or is not used, but family members view that supportive people are always ready to provide help and assistance if needed). Family social support can be in the form of internal family social support, such as support from husband or wife and support from siblings or external family social support.<sup>1</sup>

---

### Corresponding Author:

**M. Askar**

Researcher in the Center of Excellent on Urban Health of Health Polytechnic of Makassar, Jl. Banta-Bantaeng No. 46, Makassar, South Sulawesi, Indonesia. 90222  
e-mail: askar@poltekkes-mks.ac.id  
Mobile No.: 085299947722



The family is expected to be able to function to realize the process of developing mutual love and affection between family members, between relatives, and between generations which are the basis of a harmonious family.<sup>2</sup> Family relationships are a happy home. In a life characterized by compassion, all parties are required to have a responsibility, sacrifice, mutual help, honesty, mutual trust, mutual understanding, and peace in the home.<sup>2</sup>

Both buffering effects (social support withhold the negative effects of stress on health) and major effects (social support directly influencing health effects) were found. Indeed the buffering and main effects of social support on health and well-being may function together. More specifically, the existence of adequate social support is associated with decreased mortality, easier recovery from illness and among older people, cognitive function, physical and emotional health.<sup>1</sup>

The family is an important element in care, especially care for children. by because children are part of the family, the nurse must be able to recognize the family as a place to stay or remain constant in the child's life.<sup>3</sup>The child's stature at the hospital is a stressful experience, both for children and parents. The hospital environment itself is a cause of stress and anxiety in children. In children who are hospitalized, challenges will have to be faced such as overcoming a separation, adjusting to an unfamiliar environment, adjusting with many people to take care of it, and often having to relate and interact with sick children and experience following the painful therapy.<sup>4</sup>

Preschoolers experience the greatest anxiety when they first enter the hospital due to the illness conditions experienced by children. If the child experiences high anxiety during hospitalization, the child will likely experience developmental dysfunction. Children will experience disorders, such as somatic, emotional, and psychomotor disorders.<sup>5</sup>

Reaction to illness or self-problems experienced by preschoolers such as separation, not knowing the environment or unfamiliar environment, loss of affection, body image will react like a regression that is a loss of control, displacement, aggression (denying), withdrawing protest behavior, and more sensitive and passive such as refusing to eat and others.<sup>6</sup>

Nearly four million children in one year were hospitalized. The average child gets treatment for six

days.<sup>7</sup> In addition to requiring special care compared to other patients, sick children also have special features and characteristics because children are not miniatures of adults or small adults. And the time needed to treat patients with children 20-45% more than the time to care for adults.<sup>7</sup>

The estimated 35 per 100 children undergo hospitalization. The Effects of Play Therapy in Reducing Anxiety in Preschool Children (2.5-5 years) who experienced Hospitalization at the Tugurejo Regional General Hospital, the data obtained in 2006 preschool children who experienced hospitalization were 122 children, in 2007 there were 642 children, in 2008 there were 977 children, in 2009 there were 929 children, in 2010 there were 223 children, in 2011 there were 181 children.<sup>8</sup>As many as 45.2 % of families provide strong support and 41.9% of families provide strong support and only 12.9% of families provide very strong support, both from the nuclear family and extended family.<sup>9</sup>

The population of children being treated in the hospital has experienced a very dramatic increase.<sup>10</sup> The percentage of children being treated at the hospital is now experiencing more serious and complex problems than the incidence of hospitalization in previous years. Nearly 4,000,000 children were hospitalized in one year, the average child being treated for six days.<sup>7</sup>

The results of the initial survey conducted in the nursery were obtained as follows: in the nursery in January to December 2017 the number of preschool children (3-6 years old) treated by 219 patients in Syech Yusuf Gowa Regional Hospital with an average child was suffering from a high level of anxiety which was around 98%.

## Materials and Method

The type of research used was descriptive-analytic with a Cross-Sectional approach, data concerning independent variables or risk and dependent or effect variables, collected at the same time.<sup>11</sup> In this study, researchers conducted data collection on the Relationship of Family Support and Anxiety Level. The population is a group area consisting of objects and subjects which become certain quantities and characteristics expected by researchers to be studied and then drawn conclusions.<sup>12</sup> The population in this study were all children ages preschool children admitted to Syech Yusuf hospitals and Hospitalized in the Pediatric ward with the average number of patients preschoolers January to April

2018 at 57 preschoolers. The instrument used for data collection in this study was to use an observation sheet. The family support observation sheet, has 20 questions, and the family support measurement scale used can be measured with a Likert scale) with the highest scale 4 and the lowest scale 1. The resulting score is between 20-80 where family support is good: 61-80, adequate family support: 41-60, family support lacking: 20-40. Data processing procedures were performed through the stages of editing, coding, data entry, and cleaning, and data analysis through the analysis procedure univariate and bivariate analysis using the chi-square test.

### Results

Family Characteristic of Respondents of this study described as part of research subject. Respondent (Children’s family) in this study based on gender, consisted of the male was 4 respondents (12,9% and female was 27 respondents (87.1%).

**Table 1: The Age Group of Respondent (Children’s Family)**

Age (years old)	Amount	
	Frequency	%
< 25	13	41.9
25 – 34	8	25.8
35 – 44	8	25.8
> 45	2	6.5
<b>Total</b>	<b>31</b>	<b>100</b>

Table 1 showed data from the 31 respondents, the highest frequency in the age group <25 years was 14 respondents(41.9%) and the lowest frequency in the age group>45 years was as much as 2 respondents (6.5%).

**Table 2: The Occupation of the Respondent (Children’s Family)**

Pekerja and fcsd Occupation	Amount	
	Frequency	%
Civil Servants	3	9.7
Traders/Entrepreneurs	3	9.7
Farmers	8	25.8
Private employees	2	6.5
Unemployed	15	48.4
<b>Total</b>	<b>31</b>	<b>100</b>

Table 2 showed data from the 31 respondents, the

highest frequency of respondent’s occupation was as a civil servant as many as 10 respondents (32.3%) and the lowest frequency was Private Employees as many as 3 respondents (9.7%).

**Table 3: Education Level of Respondents (Children’s Family)**

Education Level	Amount	
	Frequency	%
Elementary school	3	9.7
Junior High School	10	32.3
Senior High School	13	41.9
University	5	16.1
<b>Total</b>	<b>31</b>	<b>100</b>

Table 3 showed data from the 31 respondents, the highest frequency of education of respondents was Senior High School (13 respondents (32.3%) and the lowest frequency was elementary school, which was 3 respondents (9.7%).Number of Respondent Children (Children’s Family) in this study showed data from the 31 respondents, the highest frequency of 1-2 respondent children was 19 respondents (61.3%) and the lowest frequency was 3-4 children, which was 12 respondents (38.7%).

**Table 4: Age of Respondent Observed (Children hospitalized)**

Age of Children (years old)	Amount	
	Frequency	%
3	12	38.7
4	12	38.7
5	3	9.7
6	4	12.9
<b>Total</b>	<b>31</b>	<b>100</b>

Table 4 showed data from the 31 respondents, the highest frequency of the children was 3 years and 4 years old, each with 12 respondents (38.7%), and the lowest frequency was 5 years of age with 3 respondents (9.7%). Respondent observed (Children hospitalized) in this study based on gender, consisted of the male was 11 respondents (35.5% and female was 20 respondents (65.5%).

Hospitalized experiences of respondents (hospitalized children) data from the 31 respondents showed that the highest frequency of respondent’s

hospitalized experience was 29 respondents (93.5%) never been hospitalized and the lowest frequency was ever been hospitalized as many as 2 respondents (6.5%). The care length of respondents (hospitalized children) showed data that most of the children had been hospitalizing for 1 day as much as 28 respondents (90.3%), and 3 respondents (9.7%) had been hospitalizing for 2-3 days when this study was conducted.

In this study, we found data from the 31 respondents, the highest frequency of respondent family support was in good category as many as 16 respondents (51.6%) and the lowest frequency was in enough category as many as 15 respondents (48.4%). The Anxiety Levels of Preschool children hospitalized found data from the 31 respondents, the highest frequency of respondents' anxiety level was 19 respondents (61.3%) in mild-moderate level and the lowest frequency was severe anxiety, which was 12 respondents (38.7%)

**Table 5: Family Support Relationship With Anxiety Levels in Preschool Children Hospitalised in Pediatric Ward Syech Yusuf Hospital Gowa, Indonesia 2019**

Family Support	Anxiety Level				Amount	
	Mild-Moderate		Severe			
	n	%	n	%	n	%
Good	15	48.8	1	3.2	16	51.6
Enough	4	12.9	11	35.5	15	48.4
<b>Total</b>	<b>19</b>	<b>61.3</b>	<b>12</b>	<b>38.7</b>	<b>31</b>	<b>100</b>

$X^2 = 14.685, p\text{-value} = 0.000$

From table 5 above showed data from the 31 respondents, it was found good family support that was as much as 16 respondents (51.62%) and enough family support that was as much as 15 respondents (48.4%), whose level of anxiety was 19 respondents (61.3%) in mild-moderate level and had severe anxiety level experienced by 12 respondents (38.7%).Based on the Chi-Square statistical test results that have been obtained, the results obtained a value of  $X^2=14.685$  with a significant level of  $p=0.000$  with  $\alpha=0.05$ .

**Discussion**

This study showed the results from the analysis were  $p=0,000 < \alpha=0.05$  so that according to the basis of the hypothesis research decision making<sup>11</sup> Ho was rejected and Ha was accepted. This means that there was a relationship between family support with the level of anxiety in children ages preschool.

Family support is one factor that can help children in coping with stressors. Family support can have a buffering effect that is family support holding back the negative effects of stress on health and the main effect that is family support directly influences health improvement.<sup>1</sup> High parental support will also increase self-esteem, coping abilities of children in dealing with various stressors faced during hospitalization. With this coping ability, the level of anxiety experienced by children when hospitalization can be minimized.

Parents are encouraged to stay with young children as long as possible so that the separation behavior is minimized. The willingness of parents to stay depends on their involvement with children at home, their work situation, and their level of comfort with the hospital, as well as the amount of support they receive from other family members and friends in meeting the needs of other family members.<sup>13</sup>

The factors that influence anxiety responses in sick children who are hospitalized are not only due to family support but there are other factors including the foreign environment, the presence of strangers, medical equipment, inability to do activities, pain due to medical action/injury to the body. Here family support only exerts a few percent influences.<sup>14</sup>

For children, illness is a difficult time, where the child must leave a familiar environment, move to a hospital that is still unfamiliar to him, in a state of illness and loneliness, and must undergo a variety of frightening treatment procedures.<sup>15</sup> Foreigners who are around (in the hospital) for children ages preschool considered the person who threatened her. Moreover, health workers (nurses or doctors) who always carry out medical actions that are considered painful so that children easily arise anxiety when interacting with strangers to him.

Children aged 3 to 6 years are at the stage of psychosocial development initiative vs guilt. The psychosocial development stage (Erikson) of children aged 3 to 6 years is characterized by intrusive and energetic behavior, the courage to strive, and strong imagination. The explanation of pre-school age children's fantasy toward strange or excessive environments.<sup>16</sup> Children aged 3 years experience the highest increase in attention span when compared to ages 4.5 and 6 years<sup>17</sup> so this is a compelling reason to explain why 3-year-olds experience the most moderate anxiety.

### Conclusion

The family support for children was hospitalized in the pediatric ward of Syech Yusuf Hospital Gowa, Indonesia available for all children treated during this study. Nevertheless, the support received by every child varied from one another. There were 51.6% of children had a good category of family support while 48.4 children got enough category of family support from their family during hospitalization. The highest anxiety level of 31 respondents, the frequency of mild to moderate anxiety level of respondents were 19 respondents (61.3%) and the lowest frequency was severe, as many as 12 respondents (38.7%) in preschool-aged children who were hospitalized in the pediatric ward of Syech Yusuf Hospital Gowa. There was a relationship between family support with the level of anxiety in preschool children hospitalized in the pediatric ward of Syech Yusuf Hospital Gowa, Indonesia.

**Conflict of Interest:** Nil

**Source of Funding:** Self

**Ethical Clearance:** Taken from National Health Research and Development Ethical Committee Ministry of the Health Republic of Indonesia.

### References

1. Friedman MM. Family Nursing; Theory and Practice. Jakarta: EGC. 1998.
2. Soetjiningsih. Children's Growth and Development. Jakarta: EGC. 1995.
3. Wong DL. Pediatric Nursing Textbook. 6<sup>th</sup> Edition. Jakarta: EGC. 2002.
4. Supartini Y. Textbook of Basic Concept Pediatric Nursing. Jakarta: EGC. 2004.
5. Isranil E. Factors Affect Anxiety of School Children Hospitalized in Pediatric Ward of Dr. Sardjito Hospital. Thesis, Unpublished, Gadjah Mada University, Yogyakarta: 2006.
6. Hidayat AAA. Introduction to Pediatric Nursing Science. 1<sup>st</sup> Edition. Jakarta: SalembaMedika. 2005.
7. Hikmawati U. The effect of playing therapy on the anxiety of preschool children during hospitalization in Pediatric Ward IRNA II Dr. Sardjito Hospital. Thesis, Unpublished, Gadjah Mada University, Yogyakarta: 2000.
8. Katinawati, Sri H, Syamsul A. The effect of playing therapy in reducing the anxiety of Preschool Children (3-5 years) hospitalized in Tugurejo Semarang Hospital. Karya Ilmiah. 2012;1(1):1-6.
9. Milyawati L, Hastuti D. Family Support, Knowledge, and Mother's Perception and the Relationship to the Mother's Coping Strategy for Children with Autism Spectrum Disorder (ASD). Jurnal Ilmu Keluarga dan Konsumen. 2010;2(2):137-142.
10. Wong, Whaley. Developmental Psychology of Children and Adolescents. Bandung: Rosdakarya. 2001.
11. Notoatmodjo S. Health Research Methodology. Jakarta: RinekaCipta. 2005.
12. Sugiyono. Statistics for Research. Bandung: Alfabeta. 2010.
13. Potter, Perry. Fundamental of Nursing. Vol. 1, 4<sup>th</sup> Edition. Jakarta: EGC. 2005.
14. Nursalam. Infant and Child Nursing Care. Jakarta: SalembaMedika. 2005.
15. Wong DL, et al. Textbook of Pediatric Nursing. Jakarta: EGC. 2008.
16. Wong DL. Clinical Guides for Pediatric Nursing. 4<sup>th</sup> Edition. Jakarta: EGC. 2003.
17. Erni M, Andika R. The Relationship between Family Support and Anxiety Levels Due to Hospitalization in Pre-School Children in Pediatric Ward Dr. SoeradjiTirtonegoro Hospital. 2007.

# The Effect of Quorum Sensing genes (*lasI*, *rhlI*) in Some Virulence Factors of *Pseudomonas aeruginosa* Isolated from Different Clinical Sources

Hasan Falah Lahij<sup>1</sup>, Abdulla H. Alkhater<sup>2</sup>, Muthanna Hamid Hassan<sup>1</sup>, Luma Amer Yassir<sup>3</sup>

<sup>1</sup>Lecturer, Biology Department-Collage of Sciences, University of Anbar, Ramadi, Iraq, <sup>2</sup>Scholar researcher, Al-Maarif University Collage, Department of Medical Laboratory Techniques, Iraq, <sup>3</sup>Prof, National Center of Hematology, Al -Mustansiryah University, Baghdad, Iraq

## Abstract

**Background and Objective:** Quorum sensing (QS) is a chemical language of bacteria, and use of N-acyl-homoserine lactone (AHL) signals is one of the most known mechanisms by which bacteria can communicate with each other to regulate the gene expression based on bacterial density. Previous studies suggested that QS has an important role in pathogenicity of *P.aeruginosa*, so that the present study investigation the correlation of QS genes in local isolate of *P.aeruginosa* with production of virulence factors.

**Materials and Method:** The study included collection of 126 samples from various clinical sources and, these samples included wounds, burns, ear, cystic fibrosis and urinary tract infections (UTI). Pyocyanin and biofilm production were determined spectrophotometrically, QS genes were detected by PCR based on specific sequences for *lasI* and *rhlI* genes.

**Results:** Final diagnosis showed that 51 isolates belong to target bacteria and, the phenotypic detection of some virulence factors showed that 46 isolates (90%) showed variance in the strength of Pyocyanin production, and 44 (86%) of the isolates showed a differences in their ability to biofilm formation and, screened QS genes showed that 48 (94%) of isolates were positive for *lasI* gene, while 44 (86%) of isolates have *rhlI* gene, and this study pointed that 9 isolates have one of QS genes *lasI* or *rhlI*, and also have one or more of virulence factors, as well as the results showed that 1 isolate out of 51 negative for both QS genes and weakly in production of virulence factors.

**Conclusion:** Most of local isolates were positive for QS genes and, QS plays an important role in the pathogenesis, not all of the virulence factors controlled by QS. The study indicated that the isolates which have both QS genes were more virulence than isolates that have single gene.

**Keywords:** *Pseudomonas aeruginosa*, Quorum sensing, virulence factors, Biofilm, Pyocyanin.

## Introduction

*Pseudomonas aeruginosa* is a successful opportunistic secondary pathogen and most predominant

species in community infection<sup>(1)</sup>. Immunosuppressed people are the individuals remain at high risk of this infection such as those with severe burns, cancer, cystic fibrosis and acquired immune deficiency syndromes (AIDS)<sup>(2)</sup>. The virulence factors of *P. aeruginosa* play an important role in the pathological state, the survival of the bacteria and the invasion of host tissues<sup>(3)</sup>.

Bacteria have chemical molecule which mediated cell to cell communication system to regulate gene expression and group activates within communities<sup>(4)</sup>.

---

### Corresponding Author:

**Muthanna Hamid Hassan**

Lecturer, Biology Department-Collage of Sciences,  
University of Anbar, Ramadi, Iraq  
e-mail: muthanna-477-aliraqi@uoanbar.edu.iq

Quorum sensing (QS) was first discovered in the marine bioluminescent bacterium *Vibrio fischeri* in the period early 1970<sup>(5)</sup>. QS is widely spread in the bacteria, and considered as a “speaking” systems, QS plays major role in virulence factor production, and biofilm formation<sup>(6)</sup>. The communication occurs through small molecules called acyl homoserine lactones (AHL) also known as “Autoinducers” that diffuse freely across the membranes of bacteria when bacterial density increase, these molecules when reach to threshold concentration act as cofactors of transcriptional regulators<sup>(7)</sup>.

*P.aeruginosa* has two of QS system *las* and *rhl* system<sup>(8)</sup>. The *las* system consist of *lasI*, which is responsible for the synthesis of N-(3-oxododecanoyl)-L-homoserine lactone (3O-C12-HSL), and the transcriptional activator *LasR*<sup>(9)</sup>, the *lasR* binds to (3-oxo-C12-HSL) molecule and regulates expression of specific genes<sup>(10)</sup>. While another QS system in *P.aeruginosa* consists of the *rhlI* and *rhlR* genes<sup>(11,12)</sup>. The *rhlI* synthase responsible for produce of the AHL (N-butyryl-L-homoserine lactone (C4-HSL), and *rhlR* is the transcriptional regulator only when *rhlR* is complexed with C4-HSL does it regulate the expression of several genes (rhamnolipid, elastase cyanide, alkaline protease, and pyocyanin production<sup>(13)</sup>. Briefly *lasI* and *rhlI* genes activate of *lasR* and *rhlR* gene to activate encoding virulent genes.

The QS system contributes in increase virulent of *P.aeruginosa*. However, only a few local studies are available concerning the role of *P.aeruginosa* QS systems in various clinical infections. So that the present study try to understanding the role of QS gene in

production of virulence factors (pathogenicity) in local isolates of *P.aeruginosa*.

## Methodology

The study samples (126) were collected from clinical state including both sexes with different ages, who suffered from; cystic fibrosis, urinary tract infections, wounds, burns and ear infection from different teaching hospitals in Baghdad city. The study was carried out through May 2016 till May 2017.

**Laboratory and Molecular Diagnosis:** The samples cultured in Pseudomonas agar and Cetramide agar. Lab. diagnosis was done according to Holt *et al*<sup>(14)</sup> while the molecular diagnosis was done based on *16SrRNA* gene as a detection gene.

**Detection of some Virulence Factors:** Pyocyanin production determinate according to Parsons *et al*<sup>(16)</sup> and, biofilm formation method was done according to Bose *et al*<sup>(17)</sup>.

**DNA extraction method:** The bacterial DNA extracted according to Genomic DNA mini Kit which provides by Geneaid Company.

**PCR technique used for Detection of QS Genes and 16SrRNA gene**

Primers (table1) were designed by Primer3 program according to NCBI and supplied by the Bioneer Company as a lyophilized product of different picomol concentrations.

**Table 1: Sequence of primers and their size**

Gene		Sequence of forward and reverse Primer(5'- 3')	Size (bp)	Annealing Temp.°C
16SrRNA	F	GGGGGATCTTCGGACCTCA	956	58
	R	TCCTTAGAGTGCCACCCG		
Las I	F	GCGCGAAGAGTTCGATAAAA	537	60
	R	ATCTGGGTCTTGGCATTGAG		
Rhl I	F	CTTGGTCATGATCGAATTGCTC	626	61
	R	ACGGCTGACGACCTCACAC		

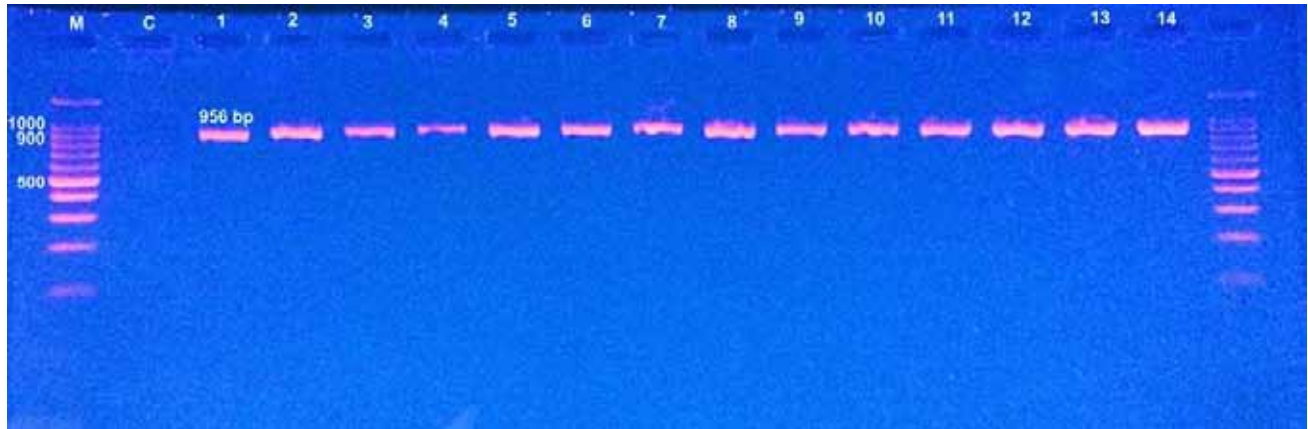
F: Forward sequences, R: Reverse sequences

**Sequencing of *lasI* and *rhlI* genes:** To search for the presence of mutations that may affect the QS genes, *lasI* and *rhlI* underwent sequencing according to Senturk (23).

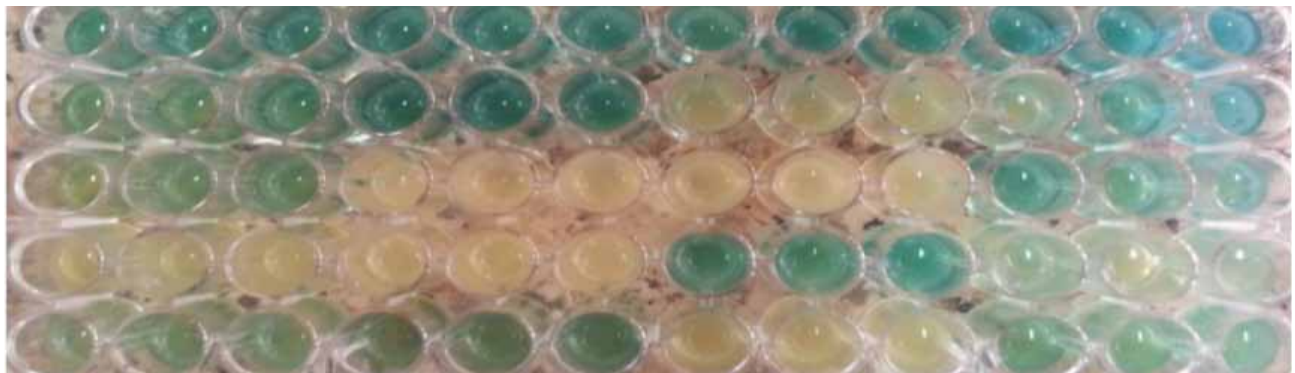
## Results

The collected samples were cultured in some media agar to initially diagnosis based on morphological characteristics of the colonies. Molecular detection used to confirm final diagnosis of all isolates. The result of gel electrophoresis (figure 1) for amplification PCR product showed that presence of bands in same level for all isolates. Final diagnosis of *P.aeruginosa* showed that 51 isolates belong to target bacteria.

Pyocyanin pigment estimated by measure of absorbance in ELISA reader equipment (VERSAmax microplate reader, Molecular Devices, USA) at 690nm, the results showed that 46 (90%) of isolates have ability to produce pyocyanin through 3 days of incubation but in varying degrees (figure 2). While the results of biofilm formation showed that 44 (86.2%) of isolates produce biofilm.



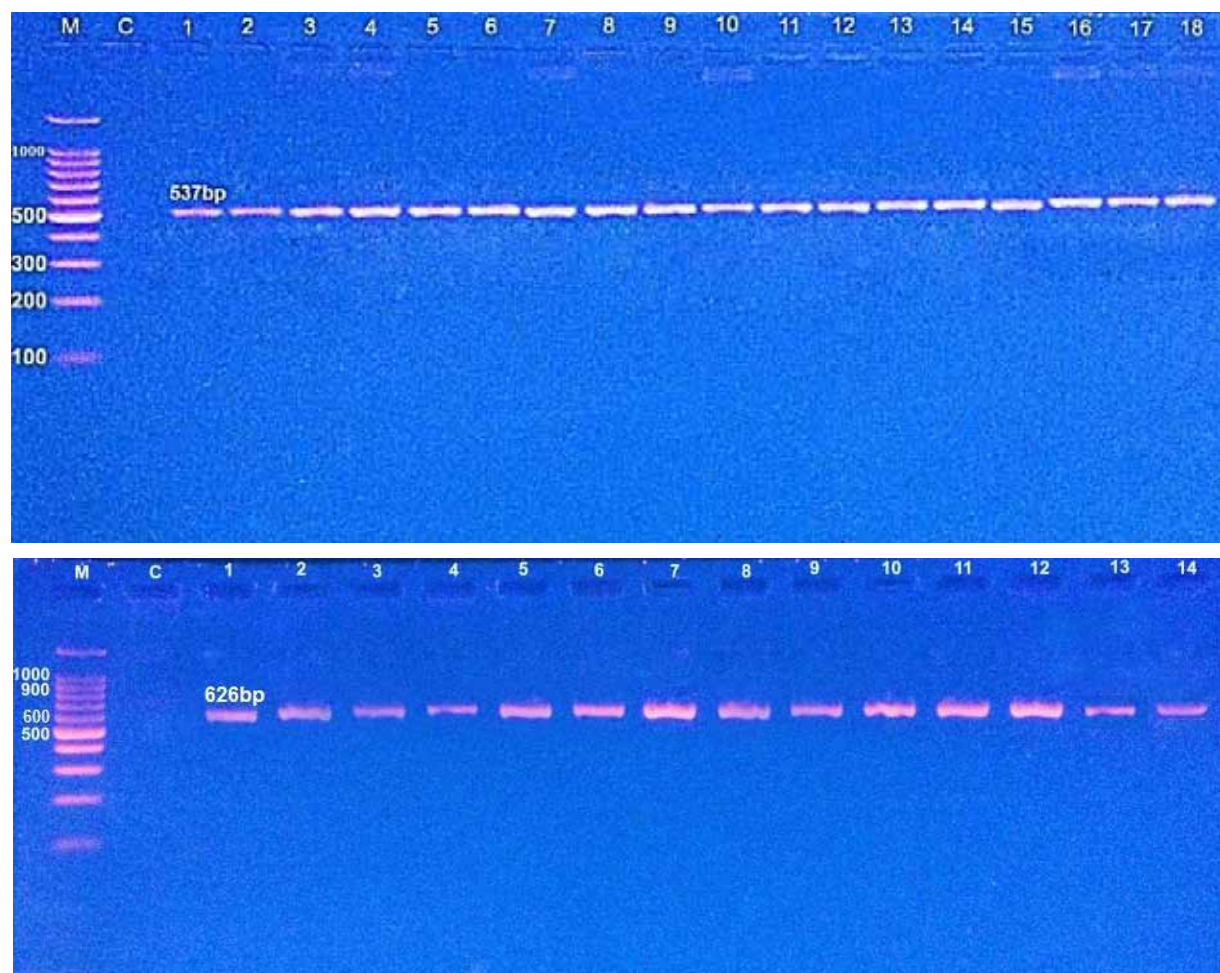
**Figure 1:** Agarose gel electrophoresis (1.5% agarose, 7 V/cm<sup>2</sup> for 90min) of *16SrRNA* gene (956bp). Lane M: represent 100bp DNA ladder, Lane C: represent negative control, Lanes 1-13: represent bands of *P.aeruginosa* gene.



**Figure 2:** Produce of pyocyanin pigment by *P.aeruginosa* isolates.

Molecular detection of (QS) genes by used specific primers for *lasI* and *rhlI* genes showed that 48 (94.1%) of isolates were positive for this gene, where are the bands appeared within the expected size of the gene (537bp) for all positive isolates (Figure 3). While 44 (86.2%) of isolates have *rhlI* gene (Figure 3), the results pointed that 9 isolates have one of QS genes *lasI* or *rhlI*, and also

have one or more of virulence factors, and one isolates out of 51 negative for both QS genes. To determine if QS genes have mutations in some isolate, sequence analysis of the PCR products showed that no difference in sequences where the percent of matching 100% for *rhlI* gene and 99% for *lasI* gene when comparing with the information bank within the site [www.ncbi.nlm.gov](http://www.ncbi.nlm.gov).



**Figure 3: Agarose gel electrophoresis (1.5% agarose, 7 V/cm<sup>2</sup> for 90min) for (a) *rhlI* gene (626bp) and (b) *lasI* (537bp). Lane M: represent 100bp DNA ladder, Lane C: represent Negative control, Lanes 1-14, 18 represent bands of *P.aeruginosa* gene.**

## Discussion

In the present study examined the role of QS in production of some virulence factors of *P. aeruginosa* in various clinical infections. Final diagnosis based on molecular detection of *16SrRNA* gene which is considered one of the basic criteria in the classification because of highly constant and unable to change over time of its regions<sup>(15)</sup>, showed that 51 isolates belong to target bacteria and, highest percentage of clinical isolates belong to burns followed by wounds, this may explain that *P.aeruginosa* is one of the more bacterial species that cause burns and wounds infection in hospitals.

Virulence factors (Biofilm and Pyocyanin) were examined spectrophotometrically, result of biofilm formation indicated that most of isolate were able to biofilm formation, but in varying degrees with compare

to negative control, the isolates capable to form biofilm ranged in intensity among high, medium and weak adherent. The high productivity of biofilm formation may be back to sensitivity of way to measure the few quantities formed, and considered important method in studying the early stages of biofilm formation<sup>(19)</sup>, this results agree with Heydari and Eftekhar<sup>(18)</sup>. While pyocyanin production increases over time, this explains the state of competition among bacterial cells on nutrients whereas the pigment consider is an antagonist, also our result nearly with Oleiwi<sup>(20)</sup>.

Many studies and reports indicated that there is a strong correlation among QS system and biofilm formation, where the results of biofilm formation showed that (43/44) of isolates which have able to biofilm form were positive to QS genes. The *las* gene plays an



important role in maintenance of *P.aeruginosa* biofilm, where that the signaling 3-oxo-C12-HSL (synthesized by *LasI*) is necessary for the establishment of *P. aeruginosa* biofilm, whereas a *lasI* mutant forms a flat and thin biofilm, and *lasI* is expressed in a large number of cells during the initial stage of biofilm formation<sup>(22)</sup>. QS genes regulate the production of pyocyanin pigment, whereas results of pyocyanin production showed that 39/46 of isolates which are able to produce of pyocyanin were positive to *rhII* gene.

Among of 51 isolates identified one isolate was defective in production of all virulence factors, but have QS genes *lasI* and *rhII*, this result may be indicated to absent of *lasR* or *rhIR* genes, because sequencing analyses revealed no mutation in *lasI* or *rhII* gene of this isolate, or may be ways used in detect virulence factors were not sensitive to very few quantities produced by this isolate. This study pointed that 9 of isolates have one of QS genes *lasI* or *rhII*, and also produce one or more of virulence factor. As well as the results showed that 1 isolate (P35) out of 51 negative for both QS genes and weakly in production of virulence factors these isolate from wound, this results agree with<sup>(24)</sup> who identified QS deficient in clinical isolate which lost all virulence factors tested, but still caused a wound infection, suggested that in addition to known virulence factors, there may be another factors yet uncharacterized involved in the pathogenesis of *P. aeruginosa*. Another possibility that may indicate or lead a QS deficient strain to cause infection is the presence of multiple strains of *P. aeruginosa* in the same infection site.

The present study confirm that important role of QS systems in Pathogenesis of *P. aeruginosa* bacteria and also indicated that *P. aeruginosa* able to causing clinical infections in humans despite an weakness of QS system in some isolates. On the other hand these results do not contradict with theory that QS system plays a main role in *P. aeruginosa* pathogenicity, and not all virulence factor controlled by QS<sup>(21)</sup>.

### Conclusions

Most of local isolates of *P.aeruginosa* were positive for QS genes, also QS plays an important role in the pathogenesis of *P.aeruginosa* infection in varous, not all of the virulence factors controlled by QS system. The *lasI* gene has important role in the production of biofilm. Detection of bacteria by *16SrRNA* gene is very simple and rapid technique compare with other conventional method.

**Conflict of Interest:** None

**Funding:** Self

**Ethical Clearance:** Not required

### References

1. Breidenstein EB, de la Fuente-Núñez C, Hancock RE. *Pseudomonas aeruginosa*: all roads lead to resistance. *Trends in microbiology*. 2011 Aug 1;19(8):419-26.
2. Phennicie RT. Examining the Role of Specific Virulence Mechanisms During *Pseudomonas Aeruginosa* Infection in a Zebrafish Model of Cystic Fibrosis. 2011.
3. Hogardt M, Heesemann J. Microevolution of *Pseudomonas aeruginosa* to a chronic pathogen of the cystic fibrosis lung. In *Between pathogenicity and commensalism 2011* (pp. 91-118). Springer, Berlin, Heidelberg.
4. Yang, L. *Pseudomonas aeruginosa* quorum sensing .A factor in biofilm development and an antipathogenic drug target. PH.D thesis Department of system Biology .technical university of Denmark. 2009.
5. Nealson KH, Platt T, Hastings JW. Cellular control of the synthesis and activity of the bacterial luminescent system. *Journal of bacteriology*. 1970 Oct 1;104(1):313-22.
6. Yin WF, Purmal K, Chin S, Chan XY, Koh CL, Sam CK, Chan KG. N-acyl homoserine lactone production by *Klebsiella pneumoniae* isolated from human tongue surface. *Sensors*. 2012 Mar;12(3):3472-83.
7. Taga ME, Bassler BL. Chemical communication among bacteria. *Proceedings of the National Academy of Sciences*. 2003 Nov 25;100(suppl 2):14549-54.
8. Wagner VE, Li LL, Isabella VM, Iglewski BH. Analysis of the hierarchy of quorum-sensing regulation in *Pseudomonas aeruginosa*. *Analytical and bioanalytical chemistry*. 2007 Jan 1;387(2):469-79.
9. Kumar,S.vishwe,M. Katoch. Text book of microbiology. 1stED.gaypee brothers medical publisher. 2012.
10. Kiratisin P, Tucker KD, Passador L. LasR, a transcriptional activator of *Pseudomonas aeruginosa* virulence genes, functions as a multimer. *Journal of*

- bacteriology. 2002 Sep 1;184(17):4912-9.
11. Schaber JA, Triffo WJ, Suh SJ, Oliver JW, Hastert MC, Griswold JA, Auer M, Hamood AN, Rumbaugh KP. *Pseudomonas aeruginosa* forms biofilms in acute infection independent of cell-to-cell signaling. *Infection and immunity*. 2007 Aug 1;75(8):3715-21.
  12. Sifri CD. Quorum sensing: bacteria talk sense. *Clinical infectious diseases*. 2008 Oct 15;47(8):1070-6.
  13. Karatuna O, Yagci AY. Analysis of quorum sensing-dependent virulence factor production and its relationship with antimicrobial susceptibility in *Pseudomonas aeruginosa* respiratory isolates. *Clinical Microbiology and Infection*. 2010 Dec 1;16(12):1770-5.
  14. Holt, J.G.; Kreig, N.R.; Sneath, P.H. ; Staley, J.T. and Williams, S.T. *Bergey's Manual of Determinative Bacteriology*. 9<sup>th</sup> ed. Wikins. 1994. pp: 1063.
  15. Brooks, G.F.; Carroll, K.C.; Butel, J.S.; Morse, S.A. and Mietzner, T.A.. *Medical Microbiology*. 25th ed. Mcgraw-HILL companies . New York . 2010.
  16. Parsons JF, Greenhagen BT, Shi K, Calabrese K, Robinson H, Ladner JE. Structural and functional analysis of the pyocyanin biosynthetic protein PhzM from *Pseudomonas aeruginosa*. *Biochemistry*. 2007 Feb 20;46(7):1821-8.
  17. Bose S, Khodke M, Basak S, Mallick SK. Detection of biofilm producing staphylococci: need of the hour. *Journal of clinical and diagnostic research*. 2009 Dec 1;3(6):1915-20.
  18. Heydari S, Eftekhari F. Biofilm formation and  $\beta$ -lactamase production in burn isolates of *Pseudomonas aeruginosa*. *Jundishapur journal of microbiology*. 2015 Mar;8(3).
  19. Shaikh I, Musaddiq M. Detection and analysis of Biofilm production and extracellular polymeric substance in *Pseudomonas aeruginosa* isolated from clinical specimens. *Bioscience Biotechnology Research Communications*. 2010. 3(1):74-78.
  20. Oleiwi SR. Study the Effect of Pyocyanin Extracted from *Pseudomonas aeruginosa* on DNA Fragmentation of Human Lymphocytes Cells .*Iraqi Journal of Science*, 2015. 56(2B): 1366-1371.
  21. Al-Musawi DM. Correlation of Quorum Sensing Genes with Some Virulence Factors in *Pseudomonas aeruginosa*. M.Sc. Thesis, College of Science, Al-Mustanslriyah University. 2012.
  22. Davey ME, Caiazza NC, O'Toole GA. Rhamnolipid surfactant production affects biofilm architecture in *Pseudomonas aeruginosa* PAO1. *Journal of bacteriology*. 2003 Feb 1;185(3):1027-36.
  23. Senturk S, Ulusoy S, Bosgelmez-Tinaz G, Yagci A. Quorum sensing and virulence of *Pseudomonas aeruginosa* during urinary tract infections. *The Journal of Infection in Developing Countries*. 2012 Mar 23;6(06):501-7.
  24. Schaber JA, Carty NL, McDonald NA, Graham ED, Cheluvappa R, Griswold JA, Hamood AN. Analysis of quorum sensing-deficient clinical isolates of *Pseudomonas aeruginosa*. *Journal of medical microbiology*. 2004 Sep 1;53(9):841-853.

# Total Matrix Metalloproteinase-2 and Prostaglandin E2 as Potential Biomarkers in Iraqi AML Patients

Hassnien S. AL- Hashemi<sup>1</sup>, Sabah A. Hameid A. Rahman<sup>2</sup>, Zeyad A. Shabeeb<sup>3</sup>

<sup>1</sup>Assistant Lecturer, MSc Clinical Immunology, National center of Hematology, Mustansiriyah University, Iraq, <sup>2</sup>Professor, PhD Clinical Physiology, College of Science, Mustansiriyah University, Iraq, <sup>3</sup>Assistant Professor, PhD Clinical Immunology, National center of Hematology, Mustansiriyah University, Iraq

## Abstract

**Acute Myeloid Leukemias (AMLs)** are rare but extremely malignant neoplasms that are liable for a big amount of fatalities associated with cancer. Acute myeloid leukemia (AML) results from accumulation of abnormal myeloblasts, most commonly in the bone marrow, leading to bone marrow failure and death. The present study was carried out to evaluate MMP-2 and PG E2 in sera and of (50) AML Iraqi patients, In addition to control group involving (50) matched apparently healthy subjects. This study was done in the National center of hematology, Department of biology at AL-Mustansiyria University, Baghdad Medical City since January 2019 to June 2020. The aim of study was to determine the level of total Matrix Metalloproteinase 2 and prostaglandin E2 in patients with AML by ELISA. and study the impact of these parameters on the pathogenesis of disease, also predict the AML and how the parameters correlated with stages and severity of disease and responsiveness to therapy. Conclusion: MMP-2 decreased and elevated of PGE2 in the serum of AML patients .

**Keywords:** AML, MMP-2, PGE2, ELISA, Matrix metalloproteinase, prostaglandin E2.

## Introduction

**Matrix Metalloproteinase-2 (MMP-2) and Prostaglandin E2 (PG E2) Roles in AML:** The Matrix Metalloproteinase (MMP) family was discovered from studies of collagen breakdown during tadpole morphogenesis<sup>(15)</sup>. Matrix Metalloproteinase (MMP) are now known as a family of 24 homologous Zn<sup>2+</sup> -dependent proteinases essential for normal extracellular matrix (ECM) breakdown, growth factor secretion and cytokine activation during wound healing, tissue remodeling, embryogenesis, neovascularisation, cell migration, and immune response regulation<sup>(33,26)</sup>.

MMP-2, also called gelatinase A, promotes the invasion and metastasis of cancer cells by destroying the collagen IV, V and X present in the ECM and basement membranes<sup>(16)</sup>.

MMPs play an significant role in the development of hematologic malignancies. Most of the research centered on the role of MMP-2 in leukemia gelatinases. Shows the role of hematopathogenesis MMPs in hematological disorder. This explains the role of MMPs and their inhibitors in hematological malignancies including MDS, AML and chronic myeloid leukemia <sup>(35)</sup>. Higher angiogenesis was observed in patients with acute leukemia, which vanished if complete hematological remission was achieved<sup>(10,27,28)</sup>. The increased vessel density found in the AML bone marrow correlated with the expression of the vascular endothelial growth factor (VEGF) <sup>(7)</sup>; Hence a role is hypothesized for other angiogenic factors such as matrix metalloproteinases. No expression of MMP-2 could be detected in normal mononuclear bone marrow cells<sup>(19)</sup>. Matrigel may be invaded by primary AML blasts, depending on their

---

### Corresponding Author:

**Hassnien S. AL- Hashemi**

National Center of Hematology, Mustansiriyah University, Baghdad, Iraq

e-mail: hassnhashmi@gmail.com

Phone Number: 00964 7702580096

MMP-2 expression<sup>(31)</sup>. MMP-2 expression may also contribute to the increased vessel density observed in AML patients' bone marrow during diagnosis by promoting in vitro cell migration<sup>(10)</sup>. Abnormal expression levels of MMP-2 were observed in AML patients and myelodysplastic syndrome (MDS)<sup>(32)</sup>. MMP-2 has a low level of expression in myeloid cells; MMP-9 is found primarily in T lymphocytes, malignant B lymphocytes and mature myeloid and monocytic cells<sup>(1)</sup>.

Prostaglandin E2 also called dinoprostone belongs to the family of lipid hormone-like signaling eicosanoids with essential inflammatory and physiological functions<sup>(8)</sup>. Most eicosanoid molecules are made from the enzymatic modification of arachidonic acid (AA), a polyunsaturated fatty acid esterified in mammalian cell membrane phospholipids<sup>(4)</sup>. PG E2 is produced presently and acts as autocrine and paracrine lipid mediators to maintain local homeostasis in the body. Both level and profile of prostaglandin (PG) production change drastically during an inflammatory response. The production of PG in uninflamed tissues is normally very low but increases immediately in acute inflammation before leukocyte recruitment and immune cell infiltration<sup>(29)</sup>. Biosynthesis of prostaglandin is blocked by non-steroidal anti-inflammatory drugs (NSAIDs), which inhibit the action of either cyclooxygenases or both. In addition to their role in homeostasis, prostanoids can modulate immune responses and contribute to tumor initiation, vascularization and chronic inflammation<sup>(30)</sup>.

The mechanisms that underlie PGE2's effects on cancer growth are, elusive. In a recent review, Zelenay et al. presented first direct evidence that PGE2 could promote tumor growth by evading immune attacks in melanoma models for murine tumor transplantation<sup>(36)</sup>.

Tumor derived prostaglandin E2 (PGE2) plays a major role in suppressing the activity and survival of CTLs in patients undergoing immunotherapy for cancer. PGE2 have also been shown to suppress survival of CTLs, interferon type I production and in vitro cytotoxicity Previous evidence shows that exhausted CTLs increased the expression of certain inhibitory receptors including the PGE2 receptors EP4 and EP2 using profiling of the entire genome expression<sup>(25)</sup>. In AML blasts, PGE2 has been shown to be upregulated as opposed to mononuclear blood cells<sup>(13)</sup>. It has elevated serum levels of prostaglandin E2 in patients with acute

lymphoid leukemia. Upon full remission with induction chemotherapy, the elevated plasma prostaglandin E2 levels decreased significantly<sup>(22)</sup>.

## Method

The study was conducted on 50 Iraqi patients with acute myeloid leukemia and 50 matched healthy looking subject. The age range of the patients within 17-80 years. This study was done in the National center of hematology, Department of biology at AL-Mustansiyyria University, Baghdad Medical City since January 2019 to June 2020 . Each patient was subjected to physical examination done by specialist and illness –information related to this research were obtained.

This assay employs the quantitative sandwich enzyme immunoassay technique (ELISA) (for Total MMP-2 and PG E2 in serum, the kits was used from R & D Systems,USA.

## Result and Discussion

The present study demonstrated a statistically significant decreased level of Matrix Metalloproteinase 2 in patients with AML as compared with control subjects ( $p < 0.01$ ) **Table (1) Figure (1)** the current findings were agreed with (Lin *et al.*, 2002) who show there was lower level of MMP-2 in the AML patient Also another report in Egypt<sup>(3)</sup> that mentioned there were decrease in the level of MMP-2 in AML patients.

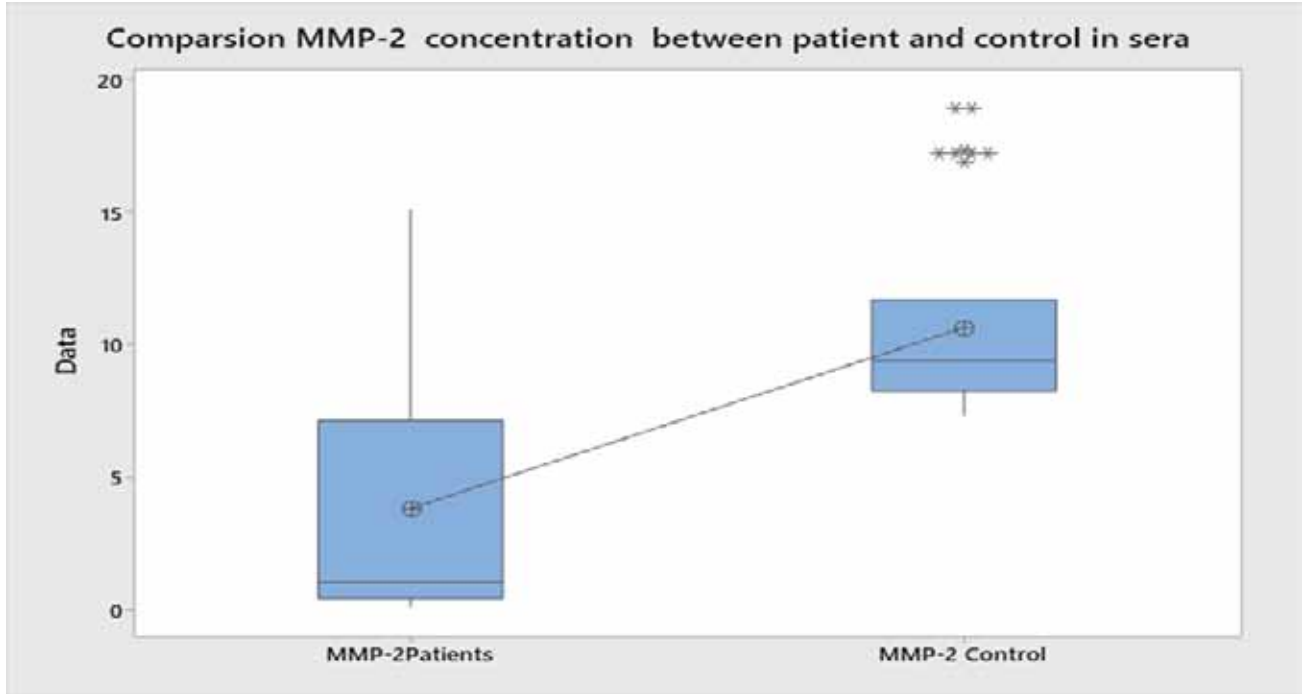
In Iranian study<sup>(6)</sup> who showed the MMP-2 levels in AML patient were not much higher as compared to normal bone marrow (BM) donor.

An association of MMP-2/-9 expression with invasive activity of leukemic cells in acute lymphoblastic leukemia (ALL) and acute myelogenous leukemia (AML) has been recorded earlier. In addition, MMP-2/-9 seems to have prognostic effect in AML<sup>(12)</sup>. Another study that measured the expression of MMP-2 in the Amyloid precursor protein (APP) which is prognostic significance in AML, the expression of MMP-2 revealed decreasing in the patients<sup>(17)</sup>.

Our finding Disagree with<sup>(6)</sup> because they were used Bone marrow CD34 to measured MMP-2 in the blast cell and also Real time PCR technique while present study use Enzyme linked Immunosorbent Assay (ELISA).

**Table (1): Matrix Metalloproteinase 2 (Total MMP-2) concentration among patient and control in serum. \*\*( $P < 0.01$ )**

Total MMP-2	No.	Mean $\pm$ se	Range	P-value	T-test Value
Patients	50	3.815 $\pm$ 0.72	0.122-15.1	0.000	-7.49**
Control	50	10.636 $\pm$ 0.558	7.3-18.9		



**Figure (1) Matrix Metalloproteinase 2 (Total MMP-2) concentration among patient and control**

The concentration of prostaglandin E2 in AML patient serum was (339.5  $\pm$  60.8) while the concentration of prostaglandin E2 of the healthy control serum were (19.95  $\pm$  0.558) there were a highly significant differences between patient and control ( $P < 0.01$ ). the present result was agree with previous reports (9,24,30). **Table (2) (Figure 2)**

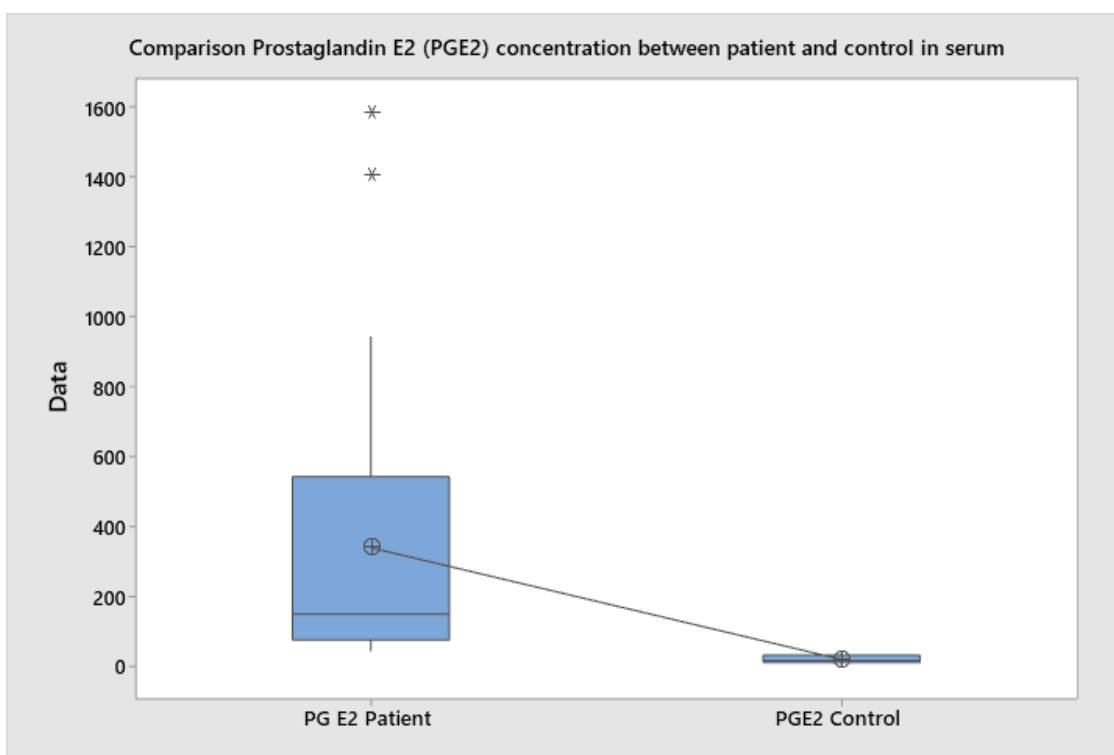
The current result were agree with<sup>(22)</sup> who were showed there was increase in the level of PG E2 in the AML children compared with control .

Importantly, similar results were obtained<sup>(15)</sup> who were show >100-fold PGE2 more than healthy control

The tumor-promotive activity of PGE2 regulated by A vascular endothelial growth factor (VEGF) or cyclic monophosphate-dependent adenosines (cAMP) pathway which induces an activation of the proliferation of the cancer cell and has anti-apoptotic effects in various tissues<sup>(34)</sup>.

**Table (2): Prostaglandin E2 (PGE2) concentration among patient and control in serum . \*\*( $P < 0.01$ )**

Total PGE2	No.	Mean $\pm$ se	Range	P-value	T – test Value
Patients	50	339.5 $\pm$ 60.8	45.3-1585.9	0.000	5.25**
Control	50	19.95 $\pm$ 0.558	2.21-40.01		



**Figure (2) Prostaglandin E2 (PGE2) concentration among patient and control in serum**

In the course of current analysis, we examined serum samples of a total of 50 patients with Newly AML(8%) ( $n = 4$ ), Partial remission AML(22%) ( $n=11$ ), AML in complete remission (10%) ( $n= 5$ ), Refractory (36%) ( $n = 18$ ), and Relapse(24%) ( $n= 12$ ).

The level of Matrix Metalloproteinase 2 (MMP-2) were decreased in the relapse ( $2.23 \pm 0.8$  ng/ml), refractory ( $3.37 \pm 1.41$  ng/ml), partial remission ( $3.57 \pm 1.54$  ng/ml) and newly diagnosis patients ( $2.03 \pm 1.55$  ng/ml) compared with healthy control ( $10.636 \pm 0.558$  ng/ml) **Table (3)**. The present data agree with <sup>(32)</sup> who were compared between AML-treated patients with intensive chemotherapy, the expression of MMP-2 was not different in resistant cases and in patients with complete remission

MMP-2 pretreated lower than level of MMP-2 post treated agreed with <sup>(3)</sup> However <sup>(23)</sup> who revealed the patient with acute lymphoblastic leukemia (ALL) patients, they found MMP-2 level were higher as compared to BM donors.

The pervious study were measured the MMP-9 level before treated with chemotherapy and after treatment they showed decrease in the level of matrix metalloproteinase in the patient with lung cancer <sup>(11)</sup>.

While the concentration of Prostaglandin E2 were much higher in relapse patient ( $498 \pm 211$  pg/ml) and also high in partial remission patients ( $347 \pm 132$ ) and the level of prostaglandin E2 in refractory ( $291.2 \pm 86.4$ ), complete remission ( $301 \pm 86.4$ ) and newly diagnosis ( $246 \pm 140$ ) were higher than human control ( $19.95 \pm 0.558$ ) **Table (3)**. Although there is a scarcity of researches that is similar to the current research the current findings were agreed with <sup>(2)</sup> elevate of PGE2 that will lead to increases the activation of Tregs and participates in the development of Myeloid derived suppresser cell (MDSC) Such cells infiltrate the microenvironment of the tumor and dampen the immune response of the tumor by inhibiting the function of the T-cell effector, which in turn hampers immunity against cancer<sup>(24)</sup>.

**Table (3): AML patient Among All parameters and stages of disease**

Parameters	Control	Newly(n=4)	Partial (PR) (n=11)	Complete (CR) (n=5)	Refractory (RF) (n=18)	Relapse (R) (n=12)
MMP-2±SE	10.636±0.558	2.03±1.55	3.57±1.54	8.93±1.89	3.37±1.41	2.23±0.8
PGE-2	19.95±0.558	246±140	347±132	301±86.4	291.2±86.4	498±211

### Conclusion

The mean level of Matrix Metalloproteinase 2 (Total MMP-2) concentration serum was a statistically decreased in patients of AML as compared with control subjects ( $p < 0.05$ ), furthermore The levels of Prostaglandin E2 (PGE2) concentration were significantly increased in patients with AML compared with healthy subjects ( $339.5 \pm 60.8$  pg/ml vs.  $19.95 \pm 0.55$  pg/ml) ( $p < 0.05$ ). the level of MMP-2 deceased and PG-E2 elevated with AML stages that were consider MMP-2 and PG-E2 was indictor for progression of AML disease .

**Conflict of Interest:** None

**Funding:** Self

**Ethical Clearance:** Not required

- Amin A. A., Bagheri, M., Zibara, K., Maleki Behzad, M., & Shahrabi, S. Expression and activity of matrix Metalloproteinases in leukemia. *Journal of Pediatric Hematology/Oncology*, 2019. 41(2), 87–95. <https://doi.org/10.1097/mpH.0000000000001386>.
- Andreeff M. Novel Targets in the AML Microenvironment. *Clinical Lymphoma Myeloma and Leukemia*, 2017. 17, S208–S213. [doi:10.1016/j.clml.2017.08.103](https://doi.org/10.1016/j.clml.2017.08.103)
- Aref, S., Osman, E., Mansy, S., Omer, N., Azmy, E., Goda, T., & El-Sherbiny, M. Prognostic relevance of circulating matrix metalloproteinase-2 in acute myeloid leukaemia patients. *Hematological Oncology*, 2007. 25(3), 121–126. [doi:10.1002/hon.817](https://doi.org/10.1002/hon.817)
- Black HS, Rhodes LE. Potential benefits of omega-3 fatty acids in non-melanoma skin cancer. *Journal of clinical medicine*. 2016 Feb;5(2):23.
- Carter BZ, Mak PY, Wang X, Tao W, Ruvolo V, Mak D, Mu H, Burks JK, Andreeff M. An ARC-Regulated IL1 $\beta$ /Cox-2/PGE2/ $\beta$ -Catenin/ARC Circuit Controls Leukemia-Microenvironment Interactions and Confers Drug Resistance in AML. *Cancer research*. 2019 Mar 15;79(6):1165-77.
- Chaudhary Ak., Chaudhary S., Ghosh K., Chandrakala Shanmukaiah C., Nadkarni AH. Secretion and Expression of Matrix Metalloproteinase-2 and 9 from Bone Marrow Mononuclear Cells in Myelodysplastic Syndrome and Acute Myeloid Leukemia. *Asian Pac J Cancer Prev*, 2016 17 (3), 1519-1529. [doi.org/10.7314/APJCP.2016.17.3.1519](https://doi.org/10.7314/APJCP.2016.17.3.1519)
- de Bont ESJM, Rosati S, Jacobs S, Kamps WA, Vellenga E. Increased bone marrow vascularization in patients with acute myeloid leukaemia: a possible role for vascular endothelial growth factor. *Br J Haematol* 2001;113:296–304.
- Dennis, E. A., & Norris, P. C. Eicosanoid storm in infection and inflammation. *Nature Reviews. Immunology*, 2015. 15, 511–523.
- Dharmapuri G, Doneti R, Philip GH, Kalle AM. Celecoxib sensitizes imatinib-resistant K562 cells to imatinib by inhibiting MRP1-5, ABCA2 and ABCG2 transporters via Wnt and Ras signaling pathways. *Leuk Res* 2015; 39: 696-701.
- Di Raimondo F, Palumbo GA, Azzaro MP, Giustolisi R. Angiogenesis in acute myeloid leukemia. *Blood*; 2000, 96:3656.
- Ertan E., Soydinc, H., Yazar, A., Ustuner, Z., Tas, F., & Yasasever, V. Matrix metalloproteinase-9 decreased after chemotherapy in patients with non-small cell lung cancer. *Tumori*, 2011. 97(3), 286–289. <https://doi.org/10.1700/912.10023>
- Feng S., Cen, J., Huang, Y., Shen, H., Yao, L., Wang, Y., & Chen, Z. Matrix metalloproteinase-2 and -9 secreted by leukemic cells increase the permeability of blood-brain barrier by disrupting tight junction proteins. *PloS one*, 2011. 6(8), e20599. <https://doi.org/10.1371/journal.pone.0020599>
- Fiancette, R.; Vincent, C.; Donnard, M.; Bordessoule, D.; Turlure, P.; Trimoreau, F.; Denizot, Y. Genes encoding multiple forms of phospholipase A(2) are expressed in immature forms of human leukemic blasts. *Leukemia*, 2009. 23, 1196–1199.

14. Gentles AJ, Plevritis SK, Majeti R, Alizadeh AA. Association of a leukemic stem cell gene expression signature with clinical outcomes in acute myeloid leukemia. *JAMA*; 2010. 304(24):2706-271
15. Gross, J., and Lapiere, C.M. Collagenolytic activity in amphibian tissues: a tissue culture assay. *Proc Natl Acad Sci U S A*, 1962. 48: 1014-1022.
16. Iurlaro M, Loverro G, Vacca A, Cormio G, Ribatti D, Minischetti M, Ria R., Bruno M., Selvaggi L. Angiogenesis extent and expression of matrix metalloproteinase-2 and -9 correlate with upgrading and myometrial invasion in endometrial carcinoma. *Eur J Clin Invest*. 1999; 29(9):793±801. doi: 10.1046/j.1365-2362.00532.x PMID: 10469168
17. Jiang, L., Yu, G., Meng, W., Wang, Z., Meng, F., & Ma, W. Overexpression of amyloid precursor protein in acute myeloid leukemia enhances extramedullary infiltration by MMP-2. *Tumor Biology*, 2012. 34(2), 629–636. doi:10.1007/s13277-012-0589-7
18. Jung N, Dai B, Gentles AJ, Majeti R, Feinberg AP. An LSC epigenetic signature is largely mutation independent and implicates the HOXA cluster in AML pathogenesis. *Nat Commun*; 2015. 6:8489.
19. Klein S.L., Flanagan K.L. Sex differences in immune responses. *Nat. Rev. Immunol*. 2016. 16:626–638. doi: 10.1038/nri.2016.90.
20. Klein, G., Vellenga, E., Fraaije, M. ., Kamps, W. ., & de Bont, E. S. J. M. The possible role of matrix metalloproteinase (MMP)-2 and MMP-9 in cancer, e.g. acute leukemia. *Critical Reviews in Oncology/Hematology*, 2004. 50(2), 87–100. doi:10.1016/j.critrevonc.2003.09.001
21. Bhat GM. A child with acute lymphoblastic leukemia (ALL) presenting with symptomatic hypercalcemia and multiple osteolytic lesions. *Indian Journal of Medical and Paediatric Oncology*. 2007 Jul 1;28(3):46.
22. Lee YH, Lim YJ, Bae JJ, Kim JY, Shin JH. Hypercalcemia and extensive osteolytic lesion with increased plasma prostaglandin E2 level in a child with acute lymphoblastic leukemia. *The Korean Journal of Hematology*. 2007 Dec 1;42(4):433-8.
23. Lin LI, Lin DT, Chang CJ, Lee CY, Tang JL, Tien HF. Marrow matrix metalloproteinases (MMPs) and tissue inhibitors of MMP in acute leukaemia: potential role of MMP-9 as a surrogate marker to monitor leukaemic status in patients with acute myelogenous leukaemia. *Br J Haematol*. 2002. 117(4):835-841. doi:10.1046/j.1365-2141.2002.03510.x
24. Loew, A., Köhnke, T., Rehbeil, E., Pietzner, A., & Weylandt, K.-H. A Role for Lipid Mediators in Acute Myeloid Leukemia. *International Journal of Molecular Sciences*, 2019. 20(10), 2425. doi:10.3390/ijms20102425
25. Miao J, Lu X, Hu Y, Piao C, Wu X, Liu X, Huang C, Yue Wang, Li D, Liu J. Prostaglandin E2 and PD-1 mediated inhibition of antitumor CTL responses in the human tumor microenvironment. *Oncotarget*. 2017 Oct 2017. 27; 8(52): 89802–89810.
26. Nagase, H., Visse, R., and Murphy, G. Structure and function of matrix metalloproteinases and TIMPs. *Cardiovasc Res*. 2006. 69(3): 562-573. doi: 10.1016/j.cardiores.2005.12.002.
27. Padró T, Berdel WE, Büchner T, Mesters RM. Angiogenesis and anemia in acute myeloid leukemia. *Blood*; 2000a, 96:3656–7.
28. Padró T, Ruiz S, Bieker R, Bürger H, Steins M, Kienast J, Büchner T, Berdel WE, Mesters RM. Increased angiogenesis in the bone marrow of patients with acute myeloid leukemia. *Blood*, 2000b, 95:2637–44.
29. Ricciotti, E., & FitzGerald, G. A. Prostaglandins and Inflammation. *Arteriosclerosis, Thrombosis, and Vascular Biology*, 2011. 31(5), 986–1000. doi:10.1161/atvbaha.110.207449
30. Snouwaert J.N., Jania L., Nguyen M.T., Dontu P., Besse J., Akla B., Ferré P.J. and Koller B.H. Prostaglandin E2 produced by tumor cells or by the host tumor microenvironment is not completely abolished by aspirin or celecoxib and limits the ability of the host immune system to control tumor growth. *AACR*. 2019.79(17),503 .
31. Sawicki G, Matsuzaki A, Janowska-Wieczorek A. Expression of the active form of MMP-2 on the surface of leukemic cells accounts for their in vitro invasion. *J Cancer Res Clin Oncol*; 1998. 124:245–52.
32. Travaglini, E., Benatti, C., Malcovati, L., Porta, M. G. D., Galli, A., Bonetti, E., Rosti V., Cazzola M., Invernizzi, R. Biological and clinical relevance of matrix metalloproteinases 2 and 9 in acute myeloid leukaemias and myelodysplastic syndromes. *European Journal of Haematology*, 2008. 80(3), 216–226. doi:10.1111/j.1600-0609.2007.01012.x.



33. Visse, R., and Nagase, H. Matrix metalloproteinases and tissue inhibitors of metalloproteinases: structure, function, and biochemistry. *Circ Res.* 2003 92(8): 827-839. doi: 10.1161/01.RES.0000070112.80711.3D.
34. Wang D, Dubois RN. Eicosanoids and cancer. *Nat Rev Cancer.* 2010;10:181–193. doi: 10.1038/nrc2809.
35. Yu F.X., Han Z.C. Matrix bone marrow metalloproteinases: gelatinase functions in physiological hematopoiesis and hematopoietic malignancies, *Histol. Histopathetic.* 21 Segment 2006, 519–531.
36. Zelenay, S., van der Veen, A. G., Böttcher, J. P., Snelgrove, K. J., Rogers, N., Acton, S. E., Reis e Sousa, C. Cyclooxygenase-Dependent Tumor Growth through Evasion of Immunity. *Cell,* 2015.162(6), 1257-1270. doi:10.1016/j.cell.2015.08.015.

# Molecular Profile of Integrase gene *intI* and Carbapenem gene in *Aeromonas sobria* Isolates

Hawraa Natiq Kabroot AL-Fatlawy<sup>1</sup>, Taghreed Abdul Al-Kareem Al-Makhzoomy<sup>2</sup>,  
Mohammed Abdulaali Al-Hakeem<sup>3</sup>

<sup>1</sup>Ph.D. Dr. Academic(Molecular Genetics) in Dep. of Medical Laboratory Techniques, Al-Toosi University College, Najaf, IRAQ, <sup>2</sup>M.Sc. (Microbiology) in Laboratory Investigation department, Faculty of Science, University of Kufa, Najaf, IRAQ. <sup>3</sup>B.Sc. in Biology department, Faculty of Science, University of Kufa, Najaf, IRAQ

## Abstract

The current study includes the detection of *Aeromonas sobria* isolates were obtained from total 157 samples involved the clinical samples (diarrhea samples) from patients suffering from diarrheal infections during the period from April 2017 to November 2017. at AL-Central Health Laboratory in Najaf governorate. These isolates were diagnosed by four method as (Culture method, biochemical tests, Vitek@2GN cards system and Polymerase chain reaction (PCR) technique). The Vitek@2GN cards system was the best method for diagnosis, which have led to isolate and diagnosis of 33 isolate. Multidrug resistance (MDR) of bacteria were detected by MIC testing and performed with the automated VITEK@2 GN/AST compact system. A clear variation was observed in their susceptibility to 13 antibiotics disks, these isolates of *A.sobria* were revealed resistance for some antibiotics such as Penicillin class Methicillin, Amoxicillin, Ampicillin, Penicillin (100%), and (91.6%) for Carbenicillin, and high rates of resistance (100%) to Cephalosporins that represented by Ceftazidime, Cefotaxime, Cefoxitin and Cefepime. The investigation of mobile genetic elements among isolates demonstrated that *A.sobria* have been Class I integron genes (class 1 integron represented by integrase *intI1*, and IMP genes).

**Keywords:** *Aeromonas soria*, IMP gene, integrase *intI1*, Antibiotics and imipenem.

## Introduction

*Aeromonas sobria* are species of the genus *Aeromonas*, which belongs to the family *Aeromonadaceae* that received increasing attention opportunistic pathogens because of its association with both diarrheal and extra intestinal infection in human disease especially in children and persons with impaired immune system<sup>1,2,3</sup>. Multidrug resistance (MDR) was reported in the genus of *Aeromonas*<sup>4</sup>. *A.hydrophila* and *A.sobria* are antibiotic resistant a variety of antibiotics have been used to treat infection caused by *A.hydrophila*

and *A.sobria*. The high occurrence of (MDR) observed in *Aeromonas spp.*<sup>5,6</sup>. The antibiotic resistance genes that integrons capture are located on gene cassettes. *Aeromonas spp.* have been contain Class I integrin<sup>7</sup>. Integrons may be found as part of mobile genetic elements such as plasmids and transposons. Integrons can also be found in chromosomes. The aim of study for this purpose, the steps were: 1- Isolation and identification of *A.sobria* in clinical and in Najaf by VITEK@ 2 GN/ID card system. 2- Detection the Antimicrobial susceptibility of *A.hydrophila* and *A.sobria* isolates using antibiotics disks and MIC/AST. 3- Characterization of Class I integron and related mobile genetic elements (MGE) among MDR isolates. And determination of some MDR and  $\beta$ -lactamase resistance genes such as (*bla*<sub>IMP</sub>).

## Corresponding Author:

**Hawraa Natiq Kabroot AL-Fatlawy**

Ph.D. Dr. Academic(Molecular Genetics) in Dep. of Medical Laboratory Techniques, Al-Toosi University College, Najaf, IRAQ

e-mail: dr.hawraank9@altoosi.edu.iq

## Materials and Method

- **Identification of *Aeromonas*:** Phenotypic properties were recorded on microscopic characteristics by

Gram's stain was used to examine the isolated bacteria for studying the microscopic characteristics such as gram reaction, shape, motile and the media that are used (TCBS agar; MacConkey agar and blood agar) for primary identification of *Aeromonas*. Also Biochemical tests used Catalase test (3% Hydrogen Peroxide), Oxidase test, Indole Production test, Simmon's Citrate test and Motility test were all these tests and urease test result according to studies<sup>8,9</sup>.

- **Identification of *Aeromonas* by VITEK@2 GN-ID System:** The identified *Aeromonas ssp* isolates were confirmed with the automated VITEK@2 compact system by using GN/ID cards. The GN ID card is based on established biochemical method (64 reaction) and newly developed substrates, measuring various metabolic activities.
- **Antibiotics susceptibility:** Minimum Inhibitory Concentration (MIC) antibiotics were used by VITEK@2/AST, such as (AST-GN084, AST-GN093 Card system), as mentioned in antibiotics disks were used 13 antibiotic of many class and sub-class antibiotics (Penicillins, Cepheims, Monobactams, Nitrofurans, Quinolones, Ansamycin,  $\beta$ -lactamase, Carbapenem, Tetracycline, Aminoglycosides, Phenicol, Folate pathway inhibitors and Lipopeptide).

## Results And Discussion

**Isolation and Identification Culture and Biochemical Tests:** The isolation and identification of *Aeromonas sobria* showed that only 33 isolate were positive based on the morphological characteristics of the colonies on TCBS, MacConkey agar, Aeromonas media and blood agar media These isolates were smooth yellow, shiny, flat, about 2-3 mm in diameter colonies on TCBS (Fig. 1), while they were small and pale colonies on MacConkey's agar when incubated for 24h. While microscopic examination of cultures showed that the bacteria were gram-negative slightly curved rods, non-spore forming cells, arranged as single or double of bacterium bacilli. The classification of *Aeromonas* has been confusing because of lack of matching between phenotypic and genotypic characteristics of species and multiple method that are required for accurate taxonomy<sup>10</sup>.



**Fig. 1: *A.sobria* isolate on Aeromonas isolation agar and**

On the other hand, the results of biochemical tests referred to that not all were positive to oxidase and catalase tests. The positive isolates were characterized with the ability to ferment the glucose only on KIA, so the isolates gave alkaline slant with acid bottom without H<sub>2</sub>S or CO<sub>2</sub> production. Also, isolates showed positive results to simmon's citrate and negative to urease test [Table 1]. According to these biochemical tests only 33 stool samples showed positive result as *A.sobria*. This result was predicted by previous studies<sup>6,11,12</sup>.

**Table 1: Biochemical tests for *Aeromonas***

No.	Tests	<i>A.sobria</i>
1	Oxidase test	+
2	Kligler iron agar	Alk/Acid with gas
3	Indole test	+
4	Citrate test	+
5	Methyl red test.	+
6	VP	+

The identification by VITEK@2 was performed with the automated VITEK@2 system using GN-ID cards which contained 64 biochemical tests. The results were demonstrated 33 *A.sobria* isolates were confirmed with ID message confidence level ranging excellent (Probability percentage from 94 to 99.7 %).

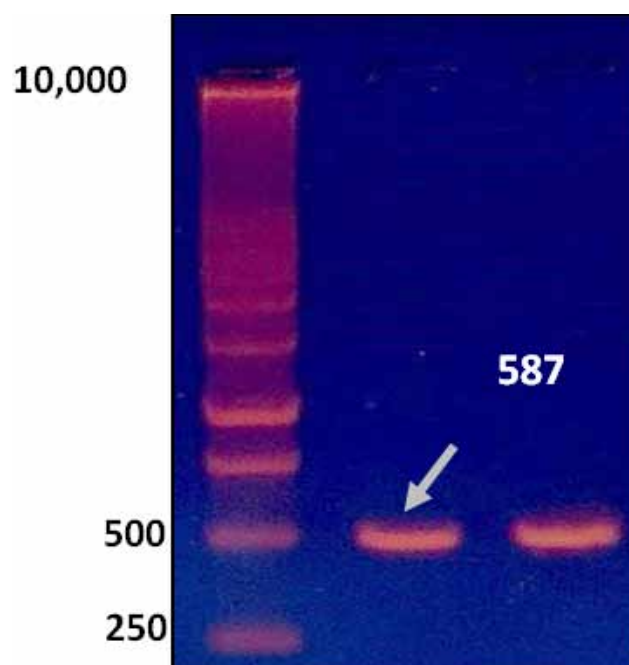
**Molecular Identification by PCR Technique:****Antimicrobial Susceptibility Determination:****A. Minimum Inhibitory Concentration of**

**Aeromonas:** MIC testing was performed with the automated VITEK@2 GN/AST compact system. The results of the study revealed that all *A.sobria* isolates were resistant to minimum of many classes of antibiotics (MIC) to which they are tested. Hence, all isolates were considered to be multidrug resistant (MDR), revealed that the resistant of *A.sobria* isolates to Penicillins (Ampicillin, Amoxicillin/Clavulanic, Piperacillin and Piperacillin-Tazobactam) were recorded in 100% for all isolates. The resistance to  $\beta$ -lactam/ $\beta$ -lactamase inhibitor combinations was appeared in 100% of *Aeromonas* isolates. MDR of *A.sobria* isolates were represented by resistance to twelve class and sub class of antibiotic. All isolates appeared resistance to (Penicillin class) Methicillin, Amoxicillin, Ampicillin, Penicillin (100%), and (91.6%) for Carbenicillin. The study also revealed a high rates of resistance to Cephalosporins that represented by Ceftazidime, Cefotaxime, Cefoxitin and Cefepime were detected in (100%). Resistance to all  $\beta$ -lactam/ $\beta$ -lactamase inhibitor combinations including Amoxicillin-Clavulanic acid and Piperacillin-Tazobactam (100%). The results of resistance isolates appeared high resistance to Imipenem (75%), Meropenem (77%) and Ertapenem (80%) of Carbapenem class, were effective against the majority of these isolates, these results agreed with other studies such as<sup>4,13</sup>. The human populations within these regions are at risk of exposure to antimicrobial resistant bacteria, and thereby disseminating antimicrobial resistance (ARGs) genes<sup>14</sup>.

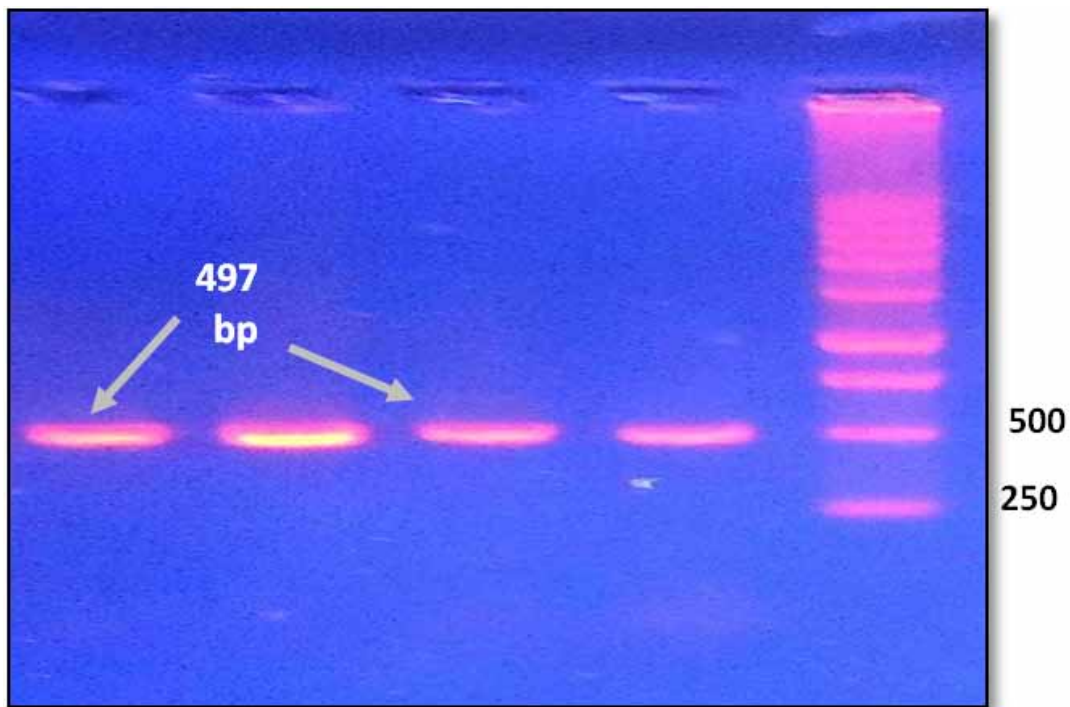
**Molecular Detection of Resistance and Integron**

**Class I Genes:** All *A.sobria* isolates were detected for the present of ESBL genes. The results revealed that isolates yielded amplification products with specific primers for types of extended-spectrum- $\beta$ -lactamase(ESBL) and

metallo- $\beta$ -lactamase (Carbapenem) antibiotics genes. All isolates in the present study were tested phenotypically of ESBL and Carbapenem production by MIC method and genotype. However, gene in the families only IMP were examined in the present study. Detection of these genes was performed by PCR technique. The results revealed that out of the 29 *A.sobria* isolates contained of genes 29 isolate *bla*<sub>IMP</sub>(587 bp), *intI1*(497bp) genes as mentioned in [fig. 2] and [fig. 3]. Previous studies unquestionably established the role (>85% of isolates) of many *Aeromonas* spp. such as *A. hydrophila*, *A. Sobria*, *A.caviae* and *A. veronii* in diarrhea<sup>4,15</sup>. Deng *et al*<sup>16</sup> confirmed that *Aeromonas* strains containing multiple drug-resistance integrons, and these data suggests that surveillance for antimicrobial resistance of animal origin and responsible use of antimicrobials in aquaculture is necessary in these farms. Current results are agreed of *Aeromonas* produced class I integron genes with other studies<sup>7,17,18</sup>.



**Fig. 3: Agarose Gel Electrophoresis (1.5%) of PCR products of *intI1*(497 bp) gene of *.sobria* isolates for (45) min at (100) volt.**



**Fig. 2: Agarose Gel Electrophoresis (1.5%) of PCR products of IMP Genes (587bp) of *A.sobria* isolates for (45) min at (100) volt.**

### Conclusion

The frequency of *A.sobria* isolates in Najaf were higher among local clinical isolates. Identification by VITEK@2GN card system and Molecular techniques are necessary for detection of pathogenic bacteria among clinical isolates. Molecular characterization of Class I integron genes, genetic elements (MGE) among MDR isolates were found in most *Aeromonas* isolates. *A.sobria* was multidrug resistance by shown a great emergence of MDR isolates among strains isolated and resistance to twelve class and sub class of antibiotic Methicillin, Amoxicillin, Ampicillin, Penicillin, Ceftazidime, Cefotaxime, Cefoxitin and Cefepime, Amoxicillin Clavulanic acid and Pipracillin-Tazobactam, Rifampin.

**Acknowledgement:** We would like to thank all laboratories staffs at dep. Of Medical Laboratory Techniques of Al-Toosi University College, and laboratories staffs at Faculty of Science, University of Kufa, Najaf, Iraq.

**Funding:** None

**Conflict of Interest:** All authors are no conflict of interest.

**Contribution:** The authors in this work have approved it for publication in your journal .

**Data:** All data were analyzed during this work are included in the manuscript.

**Ethics Statement:** The work does not contain any study with animals performed or human participant by any of the author.

### References

1. Naharro, G.; Riano, J.; de Castro, L.; Alvarez, S.; Luengo, J.M. *Aeromonas*: Molecular Detection of Foodborne Pathogens (Liu D. Ed.). CRC Press. North Ryde, 2009; 273–289.
2. Uche, O.A. and Johnkennedy, N. Prevalence of *Aeromonas* species among patients attending general hospital Owerri. *J.AMS*, 2014; 1(4):1:10.
3. Al-Fatlawy, H.N.K and AL-Hadrawy, H.A. Isolation and Characterization of *A. hydrophila* from the Al-Jadryia River in Baghdad (Iraq). *American Journal of Educational Research*, 2014, Vol. 2, No. 8, 658-662. DOI:10.12691/education-2-8-14.
4. Bakhtiar-Lijon, Md;Khatun, M.;Islam, A.;Khatun, M. and Islam, A. Detection of multidrug resistance

- Aeromonas hydrophilum* farm raised fresh water prawns. *J. Adv. Vet. Anim. Res.*, 2016; 2(4): 469-474.
5. Ndi, O.L., Barton, M.D. Incidence of class 1 integron and other antibiotic resistance determinants in *Aeromonas* spp. from rainbow trout farms in Australia. *J. Fish Dis.* 2011; 34, 589–599.
  6. AL-Fatlawy, H.N.K; Aldahhan, H.A and Alsaadi, A.H. Phylogenetic of ERIC-DNA Fingerprinting and New Sequencing of *Aeromonas* Species and *V. Cholerae* DNA. *American Journal of Applied Sciences* 2017, 14 (10): 955.964. DOI: 10.3844/ajassp.2017.955.964.
  7. Mazel, D. Integrons: agents of bacterial evolution. *Nat Rev Microbiol*; 2006; 4:608–620.
  8. Jawetz, E., Melnick J.I. and Adelberg E.A.. *Medical Microbiology*, 2016; 27th Edn., Appleton and Lange U.S.A.
  9. WHO. World Health Organization, *Microbiological agents in drinking water. 2000 Vibrio cholerae* (2<sup>nd</sup>ed.).
  10. Králová, S.; Staňková, E.; and Sedláček, I. Classification of *Aeromonas* spp. isolated from water and clinical sources and distribution of virulence genes. *Folia Microbiol*, 2016; 61(6):513-521 . DOI 10.1007/s12223-016-0464-9.
  11. AL-Fatlawy, H.N.K and Al-Ammar, M.H. Study of Some Virulence Factors of *Aeromonas Hydrophila* Isolated from Clinical Samples (Iraq). *International Journal of Science and Engineering Investigations*, Volume 2, Issue 21, October 2013. Paper ID: 22113-16.
  12. Yang Q-H, Zhou C, Lin Q, Lu Z, He L-B, Guo S-L. (2017). Draft genome sequence of *Aeromonas sobria* strain 08005, isolated from sick *Rana catesbeiana*. *Genome Announc*, 2017; 5(2): e01352-16.
  13. Igbinsosa, I. H.; Igbinsosa, E.O. and Okoh, A.I. “Virulence gene markers and biofilm formation of *Aeromonas* species recovered from cow faeces.” *Journal of Clinical and Cell Immunology*, 2014; 5(5) 184.
  14. Usui, M.; Tagaki, C.; Fukuda, A.; Okubo, T.; Boonla, C.; Suzuki, S.; Seki, K.; Takada, H.; and Yutaka Tamura, Y. Use of *Aeromonas* spp. as General Indicators of Antimicrobial Susceptibility among Bacteria in Aquatic Environments in Thailand. *Frontiers in Microbiology*, 2016; 7 | Article 710 7:710. doi: 10.3389/fmicb.2016.00710.
  15. Janda, J.M. and Sharon, L. The genus *Aeromonas*: taxonomy, pathogenicity, and infection. *Clin Microbiol Rev*, 2010; 23:35–73.
  16. Deng, Y.; Bao, X.; Ji, L.; Chen, L.; Liu, J.; Miao, J.; Chen, D.; Bian, H.; Li, Y. and Yu, G. Resistance integrons: class 1, 2 and 3 Integrons. *Ann Clin Microbiol Antimicrob*(2015) 14:45.
  17. Malek, M.M., Amer, F.A., Allam, A.A., El-Sokkary, R. H., Gheith, T., and Arafa, M. A. Occurrence of classes I and II integrons in Enterobacteriaceae collected from Zagazig University Hospitals, Egypt. *Front. Microbiol*, 2015; 6:601. doi: 10.3389/fmicb.2015.00601.
  18. Al-Hadrawi, H.; Al-Harmoosh R.; Al-Fatlawy, H.N.K. Isolation and Identification of *Streptococcus pneumoniae* Causing Respiratory and Thoracic Diseases in Najaf Province. *J Pure Appl Microbiol*, 2019; 13(4).doi 10.22207/JPAM.13.4.

# Comparative Study of Children with/without Iron Deficiency Anemia Based on Parents' Knowledge, Attitude and Practice in Basra/Al-Madinah City

Haydar Mohsin Abdulhussein<sup>1</sup>, Jabbar Taresh Ahmed<sup>2</sup>,  
Abbas Ali AL-Kinani<sup>3</sup>, Faiz hussien ali<sup>4</sup>, Rasha Mohammed Jumaah<sup>5</sup>

<sup>1</sup>Postgraduate Student Iraqi at Community Health Techniques, Health and Medical Technical College, Southern Technical University, Iraq, <sup>2</sup>Assistant Professor, Community Health Techniques, Health and Medical Technical College, Southern Technical University, Iraq, <sup>3</sup>Specialist in Epidemiology & Biostatistics, Wasit Health Department, Iraqi Ministry of Health, Iraq, <sup>4</sup>Specialist in Pediatrics Medicine, Al Madinah General Hospital, Basra Health Department, Iraqi Ministry of Health, Iraq, <sup>5</sup>Scolar Researcher, Specialist in Communicable Diseases, Wasit Health Department, Iraqi Ministry of Health, Iraq

## Abstract

**Background:** Children under five years of age suffer from anemia is a common medical problem worldwide. Iron deficiency anemia is the most prevalent in infants and has proven to be a public health issue. Many studies have been conducted on anemia among infants but the scope of the studies focused on anemia prevalence with less emphasis on anemia knowledge and parental practice.

**Objective:** To explore the level of parental knowledge, attitude, and practice towards iron deficiency anemia.

**Method:** A cross-sectional study in the first taken 150 children that attended to Children's Counseling at Madinah General Hospital from these in the second case control study show only 30 children that effect with IDA and 30 children without IDA.

**Results:** In this study, the prevalence of anemia in less than two years is 46.7%. knowledge answers near half study sample with their children previously diagnosed with IDA was 16 (53 %), the attitude of parents about IDA between two groups not there is a significant relationship and most answers of parents with their children previously diagnosed with IDA was between Fair 17 (57%) and Poor 11(36%), not there is a smaller study in this article to refuse or accepted. Practices show a significant association between (case with IDA) and (control without IDA) because (65% poor) practice About IDA in the case in other side control was (26%) poor only About IDA in the differential in practice refer more vulnerable to the effect of children to IDA.

**Conclusion:** Anemia is prevalent in infants 24 months old with substantial differences in parents' knowledge and practices.

**Keywords:** Comparative study, Iron deficiency anemia, Knowledge, Basra.

## Introduction

Anemia is one of the most widely held audiences Problems with health, in particular in developing countries. Its health, social and economic importance Following. Anemia According to WHO the most common nutritional deficiency due to iron is Worldwide disorder. Two billion people – more than 30 per cent

---

### Corresponding Author:

Abbas Ali AL-Kinani

Specialist in Epidemiology & Biostatistics, Wasit Health Department, Iraqi Ministry of Health, Iraq  
e-mail: abbasalkanani08@gmail.com

The world's population – anemic, mostly because of iron Deficit <sup>1</sup>

Children under five years of age suffer from anemia is a common medical problem worldwide. Iron deficiency anemia is the most prevalent in infants and has proven to be a public health issue. Many studies have been conducted on anemia among infants but the scope of the studies focused on anemia prevalence with less emphasis on anemia knowledge and parental practice. In Iraq, iron deficiency (ID) prevalence in children under the age of five is 14.4%, and IDA prevalence is 6.8%. <sup>2</sup>

**Aim of the Study:** To explore the level of parental knowledge, attitude and practice towards iron deficiency anemia.

## Method

- 1. Study Settings:** In the Basra/Iraq, Children with clinical signs of undernutrition were randomly selected from the Children's Counseling at Madinah General Hospital by a pediatrician and newborn specialist in the Al-Madinah areas, north of Basra Governorate, and laboratory investigation doing for him including hemoglobin (Hb) and serum ferritin measurement at nine months to 83 months.
- 2. Study Design:** This is case control study.
- 3. Data Collection:** Data was collected over three months, from 7<sup>st</sup> January to 18<sup>nd</sup> April, 2020. Data (using a structured questionnaire tool) was obtained from the parents of eligible infants through interview (face to face).
- 4. Data Collection Tool:** The data collection tool was based on medical references and previous researches. The content validity was tested via ten pediatric consultants working in Ministry of Health. The questionnaire is composed of three parts: the first part is about the sociodemographic data of the parents. The second part includes questions to explore the knowledge of parents about iron deficiency anemia,

### Part Two: Laboratory measurements

This part of the questionnaire consists of questions related to child-related measures such as hemoglobin level, serum ferritin level according Normal findings <sup>3</sup>

Hemoglobin = 1-6 years: 9.5-14 g/dL

Ferritin = Newborn: 25-200 ng/mL

≤ 1 month: 200-600 ng/mL

2-5 months: 50-200 ng/mL

6 months-15 years: 7-142 ng/mL

Iron deficiency was defined as serum ferritin levels of below 31 ng/ml, while iron-deficiency anemia was defined as hemoglobin of less than 11 g/dl and serum ferritin of less than 31 ng/ml <sup>4</sup>

**5. Exclusion criteria:** Children with hereditary blood diseases: thalassemia, sickle cell anemia and macular (G6PD) glucose 6 phosphate dehydrogenase deficiency excluded from this study.

### 6. Measures and Parameters of KAP study

**Regarding the Knowledge:** The scale of the three levels was rated on the 3 points (likert respondent scale) it was scored as a scoring of agreed about by assigning a score of (3) for yes, (1) for (no) and score of (2) for I don't know.

Number of questions: 27

Minimum =27, Maximum = 81, Medium =64

The medium was calculated for each participant and those score below the medium (score < 64) consider poor score, (score > 64) good and acceptable score.

Questions was about Do you know what iron deficiency, symptoms of iron deficiency, causes of iron deficiency, iron rich food, the negative effects of iron deficiency, the source of your information about iron deficiency anemia, Tea, coffee and milk are among the substances that reduce the body's proper absorption of iron, A balanced diet should contain the following nutrients, Iron deficiency anemia is one of the most common types and dietary anemia types.

**Regarding Attitude:** A scoring of attitude divided into two score agreed about by assigning a score of (2) for the answer by (agree), (1) for the answer by (disagree).

Number of question: 10

Minimum =10, Maximum = 20, Medium =15

The medium was calculated for each participant and those score below the medium (score <15) consider poor score, (score > 15) good and acceptable score.

Attitude was about are you with a child drinking tea with a meal, the child to drink iron drink after eating,



iron drink children before eating, the child eating fruits regularly, eating red meat, eating ready-made juices, drinking cola and soft drinks, eating crackers (chips and derivatives), eating breakfast daily, eating lunches daily and eating dinner every day.

**Regarding Practices:** A scoring of practices agreed about by assigning a score of (2) for the answer by (yes) and (1) for the answer by (no).

Number of question: 13

Minimum =13, Maximum = 26, Medium =24

The medium was calculated for each participant and those score below the medium (score <24) consider poor score, (score > 24) good and acceptable score.

Practice question was about does the child have tea, drink tea with food or immediately after eating, eat vegetables (spinach, parsley, radish, basil), eat fruits regularly, eat red meat, eat chicken, eat eggs, eat ready-made juices, drink cola and soft drinks weekly, eat crackers (chips and derivatives), eat breakfast daily, eat lunch daily and eat dinner every day

**Statistical analysis:** Descriptive, frequencies, central tendency, ANOVA, chi-square, correlation have been used to clarify the relationship between the research variables. The Statistical Package for the Social Sciences (SPSS) version 24 was used in the statistical analysis and treatments.

The significance of different percentages (qualitative data). Statistical significance was considered whenever the P value was equal or less than 0.05.

## Results

Data are collected orally by an interviewer using a standardized questionnaire. The age group of children of

the study was 46.7 between (9-23) month was suffering from IDA, and 43.3 control group, 72-83 month with high significant association between age group and study sample. This differential may be because of a split of age group to categories.



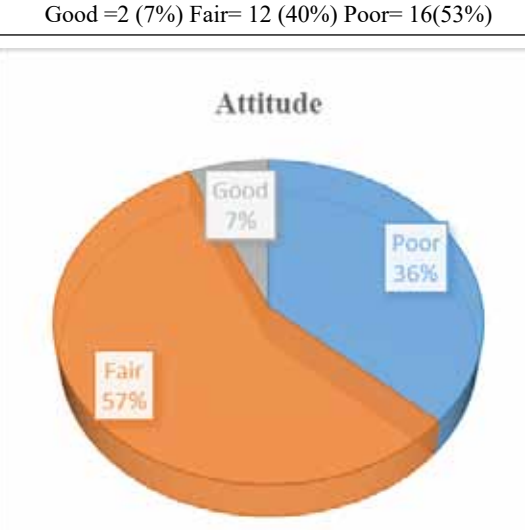
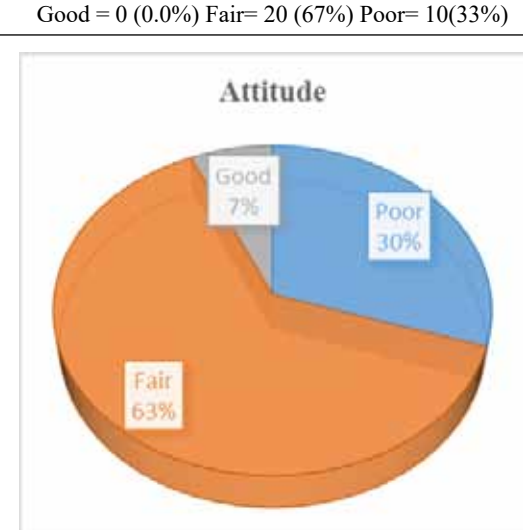
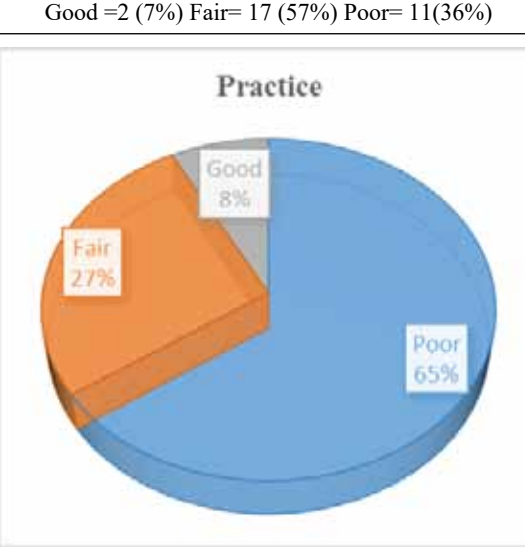
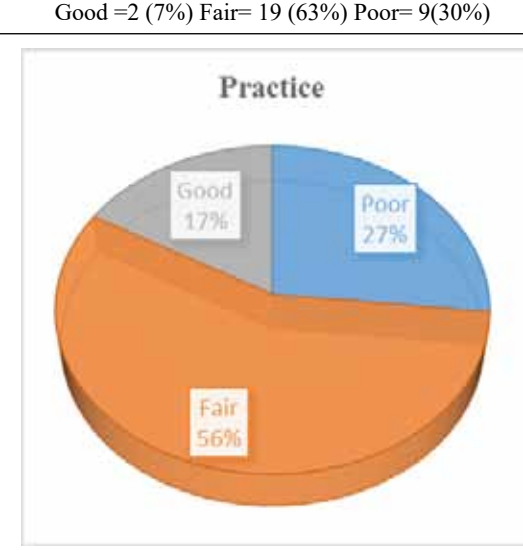
In another variable from DGDVs show not has the association between group (case & control) but only was weak a significant association in variable crowding index P.Value < 0.05 half of the crowding index case was (2.1- 4) and in control was (4.1- >5) person per bed in the room.

KAP study shown in figure (1) compressed between parents of children that attend to children's constitution asked about KAP about IDA.

Show in figures of knowledge does not have a significant association because the answer to the question nearing.

Also in figure attitude show non-significant association P. Value > 0.05 because their attitude about IDA was smaller PV (0.024), but figure practice show a significant association between (case with IDA) and (control without IDA) because (65% poor) practice About IDA in the case in other side control was 26%poor only About IDA in the differential in practice refer more vulnerable to the effect of children to IDA.

In table (1) show correlations between DGVs and KAP study show a positive association between practices age group, occupation of father, and knowledge (P. Value < 0.05) respectively, also show a significant association between knowledge and SES (P.Value < 0.05) and gender (P.Value < 0.05).

With IDA	Without IDA	P. Value
<p style="text-align: center;"><b>Knowledge</b></p>  <p style="text-align: center;">Good =2 (7%) Fair= 12 (40%) Poor= 16(53%)</p>	<p style="text-align: center;"><b>Knowledge</b></p>  <p style="text-align: center;">Good = 0 (0.0%) Fair= 20 (67%) Poor= 10(33%)</p>	<p>P. V = 0.068 <math>\chi^2 = 5.385</math></p>
<p style="text-align: center;"><b>Attitude</b></p>  <p style="text-align: center;">Good =2 (7%) Fair= 17 (57%) Poor= 11(36%)</p>	<p style="text-align: center;"><b>Attitude</b></p>  <p style="text-align: center;">Good =2 (7%) Fair= 19 (63%) Poor= 9(30%)</p>	<p>P. V = 0.856 <math>\chi^2 = 0.311</math></p>
<p style="text-align: center;"><b>Practice</b></p>  <p style="text-align: center;">Good =6 (8%) Fair= 7 (27%) Poor= 17(65%)</p>	<p style="text-align: center;"><b>Practice</b></p>  <p style="text-align: center;">Good =5 (17%) Fair= 17 (56%) Poor= 8(26%)</p>	<p>P. V = 0.024 <math>\chi^2 = 7.498</math></p>

**Figure (1)**

**Table (1): Correlations between Demographic and socioeconomic characteristics with KAP study**

Correlations		Age group	Gender	Residence	Educational of mother	Educational of father	Occupational of father	Crowding index	S.E.S	Knowledge	Attitude	Practice	
Spearman's rho	Sex	C.C	.202										
		Sig.	.061										
	Residence	C.C	.018	.114									
		Sig.	.445	.193									
	Educational of mother	C.C	.034	-.120-	.101								
		Sig.	.397	.180	.221								
	Educational of father	C.C	-.219-*	-.278-*	-.083-	.304**							
		Sig.	.047	.016	.265	.009							
	Occupational of father	C.C	-.060-	-.099-	-.035-	-.121-	.104						
		Sig.	.323	.226	.397	.178	.214						
	Crowding index	C.C	.138	.521**	.171	-.049-	-.266-*	.029					
		Sig.	.146	.000	.096	.355	.020	.412					
	S.E.S	C.C	-.129-	-.371-**	-.202-	.493**	.707**	-.189-	-.530-**				
		Sig.	.163	.002	.061	.000	.000	.074	.000				
	Knowledge	C.C	.040	-.236-*	-.110-	-.113-	.170	.110	-.179-	.227*			
		Sig.	.381	.035	.202	.195	.097	.201	.086	.040			
	Attitude	C.C	-.146-	.081	.194	.212	.041	.010	.022	.054	.071		
		Sig.	.133	.268	.068	.052	.379	.470	.434	.340	.295		
	Practice	C.C	.268*	-.140-	-.079-	.125	.169	.408**	.086	.007	.307**	.016	
		Sig.	.019	.143	.273	.171	.098	.001	.258	.478	.009	.453	
IDA	C.C	.647**	.237*	.156	.090	.098	-.168-	.243*	.034	.154	.062	.211	
	Sig.	.000	.034	.117	.248	.228	.099	.031	.399	.120	.318	.050	

\*Correlation is significant at the 0.05 level (1-tailed). (C.C= Correlation Coefficient)

\*\*Correlation is significant at the 0.05 level (1-tailed).

### Discussion

Our study showed that the prevalence of anemia in infants aged 9 months who took part in this research was 46.7%, which is in concordance with previous statistics and local studies Al-jamri A. <sup>5</sup>

Residence distribution of the sample mostly lives in rural, because the hospital locating in rural and most of attended to hospital from this area. Show the high affected with a decrease in was 28 (93.3) from the total study, this accepted with Saaka M. and Gebreweld A. <sup>6,7</sup>

In your articles, it was found that children with anemia in rural and urban areas had a high rate of (73.0) & (59.5) respectively.

Occupation of the parent that have children affected with IDA most distribution in side father was unemployed 18 (60.0), in other side occupation of the mother was housewives 60 in total study sample, this agree with Gebreweld A. <sup>7</sup>In his article it was found that occupation a high percentage among housewives was (43.1).

Overcrowding has affected many health problems one of these nutrition status of children show in our study crowding index most distribution between (2.1-4) that has children affected with IDA was 15 (50.0), this disagree with Abdel-Rasoul G. <sup>8</sup> Most distribution is between  $\leq 2$  they have IDA 36 (76.6).

This study was mostly on children with low-socioeconomic status. Low socioeconomic status has been known to be a risk factor of IDA. However, we found that our prevalence of IDA is 18 (60.0) suffering from low scale of S.E.S this study accepted with Andriastuti M. <sup>9</sup> The overall prevalence of IDA in them study was 14.0.

**Knowledge:** Show in our results knowledge answers near half study sample with their children previously diagnose with IDA was 16 (53) this results accepted with Al-jamri A. <sup>5</sup> 32.5% of parents correctly answered half or more of the questions regarding IDA complications.

**Attitude:** Funding attitude of parents about IDA between two group not there is significant relationship and most answers of parents with their children previously diagnose with IDA was between Fair 17 (57%) and Poor 11(36%), not there is smaller study in this project to refuse or accepted.

**Practices:** Show a significant association between (case with IDA) and (control without IDA) because (65% poor) practice About IDA in the case in other side control was 26%poor only About IDA in the differential in practice refer more vulnerable to the effect of children to IDA, this result different with Abdallah R. <sup>10</sup> demonstrates the mean values of food habits of the anemic cases and the normal control. It can be noticed that there were no statistically significant differences between cases and the normal control in food habits as, the *P* value > 0.05.

### Conclusion

This finding from this study suggested that PARENTS of children had less awareness of iron deficiency anemia and significant difference in practice between groups of study.

Practice will play a significant role in enhancing anemia and positive correlation between Knowledge, occupation of father, and age group with practice towards iron deficiency anemia.

**Ethical Consideration:** The Science Ethical Committee of the Ministries of Environmental and Health and Higher Education and Scientific Study in Iraq, by ethical approval.

**Conflict of Interest:** The writers claim no conflict of interest.

**Funding:** Self

### Reference

1. Abdel GM, Elgendy FM, Abd ML. Iron deficiency anemia among preschool children (2 – 6 years) in a slum area (Alexandria, Egypt): an intervention study. 2015;213-220. doi:10.4103/1110-2098.211534
2. Jaber RZ, Al-salait SK. Microcytosis in children and adolescents with the sickle cell trait in. 2019;54(1).
3. Pagana KDPTJPTN. MOSBY'S DIAGNOSTIC AND LABORATORY TEST REFERENCE, FOURTEENTH EDITION. (Pagana KDPTJPTN, ed.). St. Louis, Missouri 63043: Elsevier
4. AishatOluwatoyin Sakaa, Ayodele I. Ojuawoa, Mohammed Jimoh Sakab, S. Abayomi Biliaminuc LO. Assessment of iron deficiency in malnutrition: the value of serum ferritin. Tanta Med J. 2019;239-244. doi:10.4103/tmj.tmj
5. Al-jamri A, Al-awainati F, Ali M, Jaafar M, Hussain M, Jassim G. Parents' Knowledge and Practice of Iron Therapy for Anemic Infants in Primary Health Care in Bahrain. 2017;9(8). doi:10.5539/gjhs.v9n8p99
6. Saaka M, Galaa SZ. How is dietary diversity related to haematological status of preschool children in Ghana? Food Nutr Res. 2017;61(1). doi:10.1080/16546628.2017.1333389
7. Gebreweld A, Ali N, Ali R, Fisha T. Prevalence of anemia and its associated factors among children under five years of age attending at Gugufu health center, South Wollo, Northeast Ethiopia. PLoS One. 2019;14(7):1-13. doi:10.1371/journal.pone.0218961
8. Abdel-Rasoul G, Elgendy F, Abd Elrazek M. Iron deficiency anemia among preschool children (2–6 years) in a slum area (Alexandria, Egypt): an intervention study. Menoufia Med J. 2017;30(1):213. doi:10.4103/1110-2098.211534

9. Andriastuti M, Ilmana G, Nawangwulan SA, Kosasih KA. Prevalence of anemia and iron profile among children and adolescent with low socio-economic status. *Int J Pediatr Adolesc Med.* 2019;(xxxx). doi:10.1016/j.ijpam.2019.11.001
10. Ya, Ghi AR and MS, bn Gaza A-AU-, et al. Iron Deficiency Anemia Among Kindergarten Children Living in Marginalized Areas in Gaza Strip Submitted by/Abdallah R . Yaghi. thesis. 2013.

# Effect of Allogenic Omental Graft on Esophagectomy Incision in Dogs Models

Hayder Hussein Abd<sup>1</sup>, Montaser Mohammede Hellal<sup>2</sup>, Ammar Maatoq Hashim<sup>3</sup>

<sup>1</sup>Research Scholar, Department of Surgery, College of veterinary medicine, Al Qassim green University, Baghdad, Iraq, <sup>2</sup>Research Scholar, Department of Surgery, College of veterinary medicine, Tikrit University, Tikrit, Iraq, <sup>3</sup>Research Scholar, Department of Surgery, College of veterinary medicine, Basrah University, Basrah, Iraq.

## Abstract

The study aimed to evaluate the beneficial effect of allogenic omental graft on esophageal healing in dogs. Twenty healthy male adult dogs were used they were randomly divided into two equal groups (control group 10, treated group 10). Under aseptic technique 4 cm skin incision was made in the midline of the cervical(ventral) of animal by scalpel, after that the incision was sutured immediately by polyglycolic acid suture materials 0.3 USP used simple continuous technique, and the omental graft extracted from same animals by laprotomy piece of greater omentum was then placed over the oesophagectomy incision of the experiment group and secured in place with tacks sutures, In the control group, the esophagectomy suture line was left without graft. Esophageal healing process follow up 1,2 and 3 weeks post operation by histopathological examination, the result display in treated group on the first week post operation development of collagen and lamina propria contain congested blood vessels with epithelial regeneration. 2 weeks post operation show the epithelium of the mucosa of the esophagus was formed by hyperplasia of squamous cells. The surface of these epithelia was covered by keratin with present of bundle of collagen and fibroblasts. 3 weeks post operation showed the epithelium of esophagus was covered by keratin, with the presence of blood capillaries and also, there was lymphocytic infiltration in the lamina propria with RBC. The tunica muscularis was consisting of skeletal muscle fibers, inner longitudinal, and outer circular, proliferation of fibroblast with deposition of collagen, while in control group histopathological examination in the first week show The epithelium of the esophagus was stratified squamous with the presence of keratin on its surface, 2 weeks post operation show The mucosa of the esophagus consisted of stratified squamous epithelium with a keratin layer on its surface. The lamina propria was composed of loose connective tissue with infiltration of many WBC and blood vessels, 3 weeks post operation show the basal layer of epithelium had many folds which are interdigitation with the underlying lamina propria, which appeared loose connective tissue with few numbers of fibroblasts and lymphocytes, the healing of treated group better than control group.

**Keywords:** *Allogenic Omental Graft, Esophagectomy Incision, Dogs Models.*

## Introduction

Esophagectomy remains one among the foremost strict surgical procedures with considerably associated morbidity and mortality conjugation leak when esophagectomy remains a vital explanation for patient morbidity and impaired quality of life<sup>(14)</sup>. The treatment of muscle system disorders, such as, inherent anomalies and muscle system cancer, ends up in circumferential, full-thickness, extended section loss of the muscle system. Internal organ pull-up conduits or colon interpositions are wont to re-establish the sodium

thiopental continuity. However, the utilization of those muscle system substitutes will cause numerous surgical morbidities and mortality<sup>(7,8)</sup>. Muscle system injuries like partial-thickness defects from membrane resections may result in pathology and refractory strictures. Similarly, full-thickness patch defects like perforations will cause leaks and fistulae. Esophagectomy finished malignant and benign conditions will cause full-thickness, long-segment, circumferential defects. These need colon or internal organ conduits to take care of sodium thiopental continuity resulting in poor quality of life<sup>(16)</sup>. However,

involved in conjugation leak anatomic factors like a scarcity of membrane, inadequate blood offer, and fragile many factors might contribute to the high complication rate, together with lack of a membrane, the segmental nature of the blood offer, lack of peritoneum, the constant motion of swallowing and respiration and tension at the surgical web site<sup>(10)</sup>. Additionally muscle layers lying longwise that build it tough to realize watertight stitching of the esophagogastric conjugation<sup>(6)</sup>. Numerous ways examining a way to stop conjugation leak are delineated antecedently. These techniques embrace buttress the conjugation with encompassing tissue like peritoneum, pleura, or pericardiac fat<sup>(5)</sup>. Therefore Augmentation of oesophagotomy web site with peritoneum, serous membrane, native muscle flap, abdomen or gut will aid healing by supporting protection and revascularizing the surgical web site<sup>(11)</sup>.

### Materials and Method

Twenty male adult mixed breed dogs, 12 to 14 months old and weighing 14-18 kg, were used. Health status was determined by physical and hematological examinations. The dogs were randomly designed to two groups experimental and a control group, ten dogs in each group. All ethical considerations using animals were considered, and the experimental protocol was approved by the Ethics Committee of Basrah University. The animals were premedicated with 0.02 mg/kg atropine (KELA Laboratoria, Belgium) intramuscularly. After 10 minutes, a mixture of 5mg/kg, of 2% Xylazine Hydrochloride (VMD-Belgium), and 15 mg/kg, of 10% Ketamine (Alfasan-Holland), were given intramuscularly as general anesthesia. After induction of anesthesia, surgical preparation was carried out in a standard method. In this study, all dogs underwent esophagotomy and laparotomy operation. To perform the cervical oesophagotomy, an incision was made at the midline on the ventral surface of the neck, beginning at the larynx and extending caudally to the manubrium. After separation and retraction of local muscles, the trachea was retracted to the right, and the cervical esophagus was exposed. After this, a stab incision was made into the lumen of the esophagus, and a 4-cm linear incision was extended longitudinally. The surgical site was rinsed using normal saline and the oesophagotomy incision was closed using 3-0 polyglycolic acid (Demetech, England) with a simple continuous pattern in both groups. To perform the laparotomy, the abdominal cavity was approached through a 7-10-cm ventral midline incision midway between the umbilicus and pelvic inlet. A 2×2-

cm<sup>2</sup> piece of the omentum was isolated by two ligatures and cut free from the remaining parts. This piece of greater omentum was then cut and placed over the oesophagotomy incision of the experiment group and secured in place with tacks sutures. In the control group, the esophagotomy suture line was left without graft, and the isolated omentum was discarded. Finally, all surgical sites were closed routinely. Postoperative management consisted of withholding of oral intake for 24 h, and give all animals soft food during period of experiment, antibiotic (ceftiofur-Vietnam), at dose 0.1 mg/kg, IM, for 3 days postoperatively).

### Results

**Clinical Evaluation:** Based on the clinical examinations, no significant postoperative complications such as dysphasia, regurgitation, and vomiting were observed in any of the dogs during the study. All dogs had incisional swellings to some degree which resolved in a few days. All dogs were depressed and lost their appetite for 48 h post-surgery and regained their appetite after that. They were fed with liquid food and gruel during the first seven days after surgery and then gradually returned to their regular diet until the end of the study. All animals remained healthy throughout the study.

**Macroscopic Evaluations:** The macroscopic assessment of the surgical site revealed that in all dogs, the esophagus adhered to the surrounding soft tissue, and there was no noticeable difference in the extent of adhesion between the two groups. No complications such as infection, dehiscence, stricture, and fistula were observed in the surgical site of all dogs. In the experiment group, the greater omentum was completely attached to the incision site.

### Histopathological Results in Control Group:

**7 day:** The epithelium of the esophagus was stratified squamous with the presence of keratin on its surface. The lamina propria was containing blood vessels with blood congestion surrounded by lymphocytic infiltration, which also extended along the lamina propria. The muscular coat formed by skeletal muscle fibers (fig. 1).

**14 day:** The mucosa of the esophagus consisted of stratified squamous epithelium with a keratin layer on its surface. The lamina propria was composed of loose connective tissue with infiltration of many WBC and blood vessels, and the submucosa was continuing with

lamina propria. The muscular coat was skeletal muscle fibers arranged into two layers, inner longitudinal and outer circular direction. The tunica adventitia was loose connective tissue with blood vessels and wbc.(fig.2).

**21 day results:** The epithelium of the esophagus was stratified squamous epithelium with strands of keratin on its surface. The basal layer of epithelium had many folds which are interdigitation with the underlying lamina propria, which appeared loose connective tissue with few numbers of problasts and lymphocytes (figure 1), which these cells extended to the submucosa. The muscular layer was formed by a bundle of skeletal muscle fibers with the presence of many lymphocytes in between these muscle fibers.(Fig2,fig 3). The tunica adventitia was containing loose connective tissue fat cells and blood vessels, which appeared engorged with a moderate amount of blood.

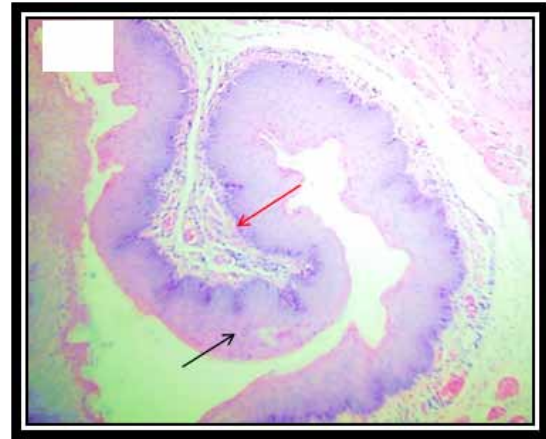
**Histopathological Results in Treated Group:**

The histopathological evaluation on day 7 shows the epithelium of the esophagus was stratified squamous with the presence of keratin on its surface. The keratin in certain areas was desquamated from the surface of the epithelium. The lamina propria was containing loose connective tissue with the presence of congested blood vessels, and individual WBCs were scattered in this area. The skeletal muscle fibers were encircling the esophagus. There was an area of this muscle containing atrophied skeletal muscle fiber with the presence of RBC in between skeletal muscle fibers. These skeletal muscle fibers were surrounded by collagen fibers (4).

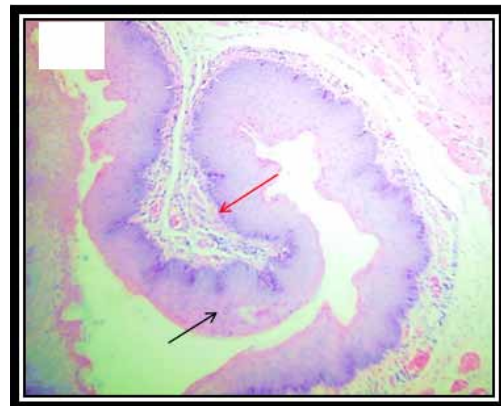
On day 14. The epithelium of the mucosa of the esophagus was formed by hyperplasia of squamous cells which present with increasing of its thickness. The surface of these epithelia was covered by keratin with present of bundle of collagen and fibroblasts. The lamina propria was infiltrated with heavy population of lymphocytes and other wbc with many blood capillaries and larger congested blood vessels. The muscular coat was formed by skeletal muscle fibers, these was an area was devoid for these muscle but replaced by collagen fibers of skeletal muscle and many blood capillaries without blood, also present of many lymphocytes and plasma cells (fig. 5).

On day 21. The epithelium of esophagus was covered by keratin. The lamina propria was contained many congested blood vessels, with the presence of blood capillaries and newly formed vessels. Also, there

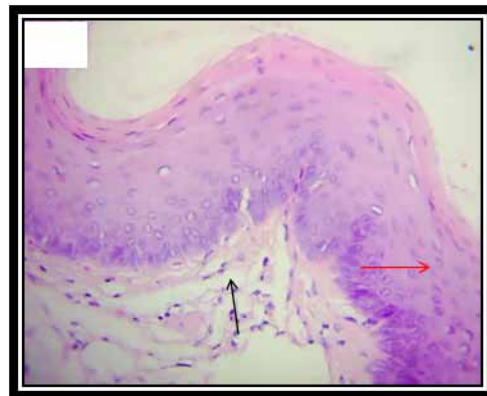
was lymphocytic infiltration in the lamina propria with RBC. The tunica muscularis was consisting of skeletal muscle fibers, inner longitudinal, and outer circular. (fig. 6).



**Figure 1 A Lymphocytic aggregation of lamina propria (red arrow). Congested blood vessels of esophaguse (black arrow),**



**Figure 2: Stratified sequemous epithelium of esophaguse (black arrow). lamina propria (red arrow). (H&E X100)**

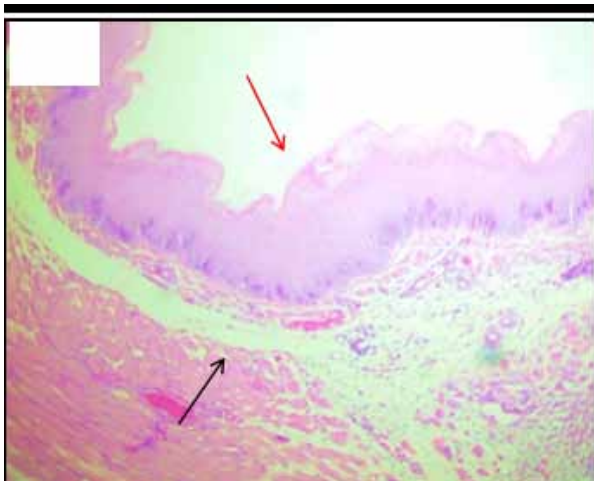


**Figure 3: A. stratified sequemous epithelium (red arrow) of esophagus. Lamina propria (black arrow).**

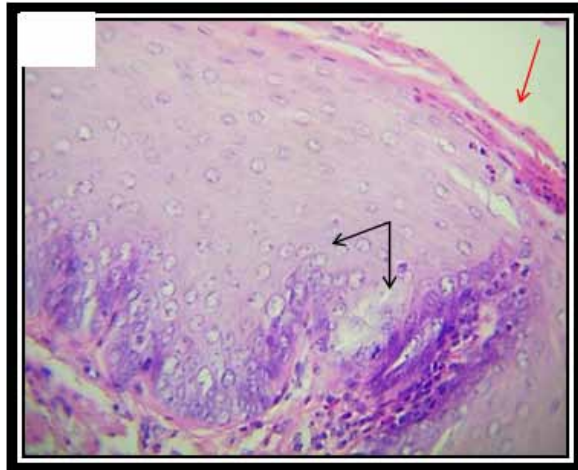


## Discussion

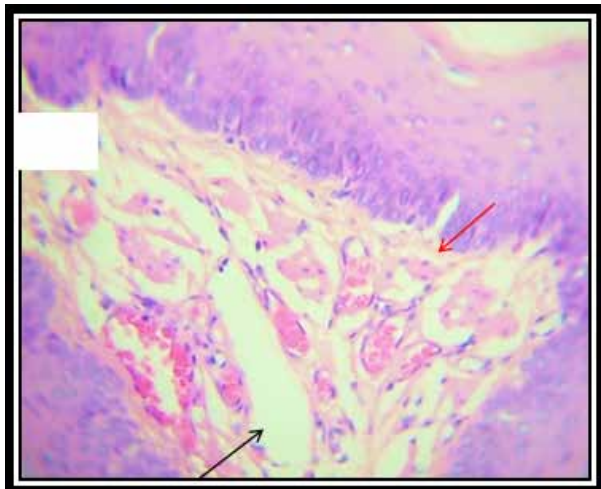
The cervical approach was chosen in this study because we believed it is the easiest way to reach the esophagus. Trans-abdominal approach and thoracotomy in dogs are technically very difficult and accompanied by high morbidity [9]. In esophageal surgery, there is a higher risk of complications than in any other portion of the digestive tract [10,11]. One explanation could be that mesothelial cells are needed to promote anastomotic healing [9, 12]. In the current study, the addition of NOA to the esophageal suture line in an extra-abdominal position might have provided the necessary mesothelial cells and consequently promote healing. Some surgeons decided to use the pedicle omentum transposition for reinforcing the anastomotic suture line to reduce the incidence of leak significantly after esophagectomy and to decrease the morbidity and mortality of the procedure [11]. The well-vascularized flap of omentum provides oxygen and nutrient for improving healing. Moreover, the omentum delivers vascular endothelial growth factor and potent angiogenic growth factor (3); this substance gives the ability to accelerate a neovascularization cross anastomosis line [13]. The exact mechanisms are not completely understood, and there is some evidence to suggest that neovascularization increases through a process that is mediated by a lipid angiogenic factor liberated by the omentum [14]. Goldsmith et al. [15, 16] described the angiogenic properties of the omental lipid factor and its ability to increase revascularization and neovascularization. Accordingly, in our study, it has been postulated that the transplanted NOA induced neovascularization, which is beneficial for esophageal suture line reinforcement [9], possibly through the release of its lipid angiogenic factors (particularly vascular endothelial growth factor, VEGF). Nevertheless, it should be noted that we did not use more rigorous, accurate method, such as immunohistochemistry, to quantify neovascularization. Another possible role for the transplanted NOA in our study might be related to its mechanical function. As a matter of fact, an explanation for the impaired healing of cervical esophagotomies is its close proximity to another fresh wound. Collagenase levels might be higher in such an environment leading to the weaker suture line and, therefore, leakage [9]. Hence, we assume that NOA, as a mechanical covering, could keep esophagotomy suture line away from more superficial fresh wounds in the region. Furthermore, it has been presumed that the transplanted NOA played another role as a space-occupying structure, exerting its enhancing function by diminishing regional dead



**Figure 4: Stratified squamous epithelium of esophagus (red arrow), Lamina propria (black arrow X20.**



**Figure 5: Hyperplasia of epithelium (black arrows), Desquamated keratin (red arrow). X40.**



**Figure 6: Stratified squamous epithelium (red arrow), (red arrow), blood vessels congestion (red arrow). X40.**

space from observation of experimental animals in post-operational animals did not exhibit any signs of anastomosis leak, and when euthanized the animals to take the specimen, it showed that's all anastomotic site was normally healed without any dehiscence this study agree with <sup>(19)</sup>. Also, all animals have no adhesion and stricture this agree with <sup>(17)</sup> who showed no any adhesion or stenosis at the site of anastomosis that used omental pedicle, but its record increase in the thickness of esophagus at the anastomosis site and it related with the presence of omental pedicle. And disagree with <sup>(18)</sup> that refer not to happen stricture in his study when used omentoplasty with diaphragmatic muscle in esophageal reconstruction. Our study 21 days post-operation histopathologically showed formation of fibrous connective tissue with infiltrated of fibroblast this agree with <sup>(19)</sup> that refer in histopathological result showed the formation of fibrous connective tissue in adipose tissue of omentum which infiltrated by inflammatory cells at 15 days post-operation in the treated group.

**Conflict of Interest:** None

**Funding:** Self

**Ethical Clearance:** Not required

### References

1. Donington JS. Functional conduit disorders after esophagectomy. *Thor Surg Clin* 2006;16:53-62
2. Flanagan, J.C., Batz, R., Saboo, S.S., Nordeck, S.M., Abbara, S., Kernstine, K., and Vasani, V. Esophagectomy and Gastric Pull-through Procedures: Surgical Techniques, Imaging Features, and Potential Complications. *Radiographics* 36, 107, 2016
3. Zhang QX, Magovern CJ, Mack CA, Budenbender KT, Ko W, Rosengart TK. Vascular endothelial growth factor is the major angiogenic factor in omentum: mechanism of omentum-mediated angiogenesis. *J Surg Res.* 1997;67:147-54.
4. Hall JC, Heel KA, Papadimitriou JM, Platell C. The pathobiology of peritonitis. *Gastroenterology* 1998; 114:185e 96
5. AE. Oesophagus. In: Slatter D (ed) *Text book of small animal surgery*, 3rd edn. Saunders, Philadelphia, 2003 pp 573–575
6. Irino, T., Tsekrekos, A., Coppola, A., Scandavini, C.M., Shetye, A., Lundell, L., and Rouvelas, I. Long-term functional outcomes after replacement of the esophagus with gastric, colonic, or jejunal conduits: a systematic literature review. *Dis Esophagus* 30, 1, 2017.
7. Urschel JD. Esophagogastrostomy anastomotic leaks complicating esophagectomy: a review. *Am J Surg* 1995;169: 634-40
8. Di Nicola, V. Omentum a powerful biological source in regenerative surgery. *Regenerative Therapy*, 2019. 11, 182-191.
9. Jansen PL, Klinge U, Anurov M, et al. Surgical mesh as a scaffold for tissue regeneration in the esophagus. *Eur Surg Res.* 2004;36:104–111.
10. Flanders JA. Problems and complications associated with oesophageal surgery. *Probl Vet Med.* 1989;1:183–194.
11. Lerut T, Coosemans W, Decker G, et al. Anastomotic complications after oesophagectomy. *Dig Surg.* 2002;19:92–98.
12. Athar MT, Chaudhry NL, Shako RK, Khan MA. Studies on end to end colonic anastomosis in the dog: A comparison of technique. *Acta Vet Hung.* 1996;44:349- 354.
13. Morgan E, Lima O, Goldberg M, Ferdman A, Luk S, Cooper J. Successful revascularization of totally ischemic bronchial autografts with omental pedicle flap in dogs. *J Thora Cardiovasc Surg.* 1982;84:204-210.
14. Goldsmith, H.S.; Griffith, A.L. and Catsimpoilas, N. Increased vascular perfusion after administration of an omental lipid fraction. *Surg Gynecol Obstet.* 1986. 162:579–583.
15. Goldsmith, M.S.; Griffith, A.L. and Kuperman, A. Lipid angiogenic factor from omentum. *J Am Med Assoc.* 1984. 252:2034–2046.
16. Goldsmith, H.S. *The Omentum. Research and Clinical Applications.* Berlin: Springer. 1988.
17. Zieren HU, Muller JM, Pichlmaier H. Prospective randomized study of one or two - layer anastomosis following esophageal resection and cervical esophagostomy. *Br J Surg.* 1993;80:608-611.
18. Younis, B.Y. (2002). Esophageal anastomosis comparative study with or without use omental pedicle in dog. [master's thesis]. College of vet Med, Univ of Baghdad.

# The *ITGB3* Genevariant among Sample of Glanzmannthrombasthenia Iraqi Patients

Hayderkareemkataa AL-Aidy<sup>1</sup>, Ehab Dawood Salman<sup>2</sup>, Safa A Faraj<sup>3</sup>, Zaid Jamal Mahmood<sup>4</sup>

<sup>1</sup>MSC Molecular Biology, Wassit Health Department, Ministry of Health, Iraq, <sup>2</sup>Ph.D Molecular Biology Department of Biotechnology, College of Science, University of Baghdad, Iraq, <sup>3</sup>MD Pediatrics Hema-oncologist, Wasit University, College of Medicine, Iraq, <sup>4</sup>M.B.Ch.B . FIBMS, Congenital Bleeding, Children Welfare Hospital, Medical City

## Abstract

Case control study was used, with Glanzmann's thrombasthenia (GT) patients (n=15) and healthy individual control (n=20).

It was successfully identified three SNP in *ITGB3* gene by using PCR technique and direct sequencing. The first SNP c. \* 1479T> C (rs115310198) was presented with three genotypes (TT, TC and CC). The genotype frequencies of TT in control group (87.6 vs. 95 %) show non-significant difference (p>0.05) compared with GT patients. It was also noticed the frequency of mutant allele (C) revealed non-significant difference (p > 0.05) in GT patients compared with controls group (13.3 vs. 2.5%; OR = 6; EF = 0.03; 95% C.I. = 0.65 to 55.05) that mean (C) allele is risk factor associated with GT patients.

The c.\*713A>G (rs2317676) was given with three genotypes (AA, AG and GG). The frequencies of these genotypes show non-significant difference (p>0.05) between control and GT patient, while the mutant allele (G) show non-significant difference (p > 0.05) in GT patients compared with controls group (16.6 vs. 5%; OR = 3.8; EF = 0.4; 95% C.I. = 0.70 to 20.63) and it was risk factors of patient GT. The c.\*1016T>A (rs3809865) showed three genotypes (TT, TA and AA) with two alleles (T and A). The frequencies of these genotypes TT (87.6 vs. 85 %), TA (6.6 vs. 15 %) and the third genotype AA (6.6 vs. 0%) show non-significant difference (p>0.05) between control and GT patient but the genotype (AA) (OR= 4.24) was considered as risk factors with GT patients. It was also found the mutant allele (A) revealed non-significant difference (p > 0.05) in GT patients compared with controls group (10 vs. 7.5%; OR = 1.37; EF = 0.11; 95% C.I. = 0.26 to 7.14). (A) allele (OR = 1.37) is positively associated with GT patients and negatively associated with healthy subject.

**Keywords:** Glanzmann's thrombasthenia, *ITGB3* Gene Polymorphisms, rs115310198, rs2317676, rs3809865.

## Introduction

Glanzmann's thrombasthenia (GT) can be inherited in an autosomal recessive manner<sup>(1,2)</sup> or acquired as

an autoimmune disorder<sup>(1,3)</sup>. GT is an abnormality of the platelets in which the platelets contain defective or low levels of integrin  $\alpha_{IIb}\beta_3$  formerly known as glycoprotein IIb/IIIa (GpIIb/IIIa) which is a receptor for fibrinogen. As a result, no fibrinogen bind of platelets to other platelets can occur, and the bleeding time is significantly prolonged<sup>(3)</sup>. The Clinical manifestations of GT including lifelong bleeding, menorrhagia, gastrointestinal bleeding, and easy fall injury<sup>(4)</sup>.

The prevalence of GT is markedly different among different ethnic groups, indicating that the difference in

---

### Corresponding Author:

Hayderkareemkataa AL-Aidy

Wassit health department, Ministry of Health, Iraq  
MSC Molecular Biology, Wassit Health Department,  
Ministry of Health, Iraq, Kut, Iraq  
e-mail: dr.haidarkareem@gmail.com

genetic background contributes to GT susceptibility, so recent genome-wide association studies reported strong and reproducible associations of multiple genetic variants in *ITGB3* ([MIM] 173470) gene with GT susceptibility (Gabriele, Canaliet *al.* 2019).

The *ITGB3* (Integrin Subunit Beta 3) is a protein coding gene. The *ITGB3* protein product is the integrin beta chain beta 3. Integrins are integral cell-surface proteins composed of an alpha chain and a beta chain. A given chain may combine with multiple partners resulting in different integrins. Integrin beta 3 is found along with the alpha IIb chain in platelets. Integrins are known to participate in cell adhesion as well as cell-surface mediated signalling<sup>(5)</sup>.

By demonstrating the response to phorbol esters, various other factors and biological processes can regulate the expression of  $\beta 3$  and control the expression of  $\beta 3$  at the transcription level. <sup>(6)</sup> Most commonly, the expression of GPIIb/IIIa on the surface of platelets is very low or absent, which is caused by mutations that lead to reduced mRNA stability or defects in post-translational processing <sup>(7)</sup>.

The molecular and functional characterization of the mutations has provided important insights to the better understanding of the biosynthesis and structure-function relationships of the GPIIb/IIIa complex with the disease. It also adds important knowledge about the biology of other molecules of the integrin family <sup>(8, 9)</sup>.

Genetic testing in GT patients is very important in the quality of life of the affected individuals and it facilitates prenatal diagnosis (PND) or pre-implantation genetic diagnosis (PGD) for at-risk families. The identified mutations will span the current database of the mutations of GT, so this study aimed at identifying mutations in *ITGB3* gene associated with GT in sample of Iraqi patients.

## Materials and Method

**Subjects:** Fifty two GT patients were enrolled in the case control study during the period of March 2019 - September 2020. these Patients suffering from dysfunction of platelets were taken from iraqi populations with ages range from 2 to 50 years including 30 woman and 22 man from pediatric teaching hospital in Baghdad city . Sixty healthy Iraqi population samples were collected as a control group, whose ages ranged between 3 and 50 years, including 30 woman and 30 men.

**Sample Collection:** From each participating subject, 5 ml of venous blood was collected using 5ml disposable syringe. The blood was distributed into two aliquots. For the first, 3 ml of blood was dispensed in plain tube, and after clotting, the tube was centrifuged (2000-3000 rpm for 20 minutes) to collect serum. The serum was distributed into aliquots in 0.5ml eppendorf tubes, and the tubes were used to detection of human Platelet Membrane Glycoprotein IIBIIIA (also known as GPIIb/IIIa) in serum. The remaining blood (2 ml) was dispensed in EDTA tube, and frozen at -20 C until extraction of DNA for single nucleotide polymorphism (SNP) genotyping of *ITGB3* gene .

**Measurement of Glycoprotein IIBIIIA Serum Levels:** The quantitative of human Platelet Membrane Glycoprotein IIBIIIA was assessed in serum of GT patients and controls by means of ELISA (enzyme linked immunosorbent assay) principles. The assessment was carried out by using Human Platelet Membrane GPIIb/IIIa ELISA Kit that was produced by bioassay technology laboratory Company (china.), and the manufacturer instructions were followed. The sample results were calculated by interpolation from a standard curve that was performed in the same assay as that for the samples by using standard curve fitting equations for GPIIb/IIIa.

**DNA isolation:** Fifteen patient samples were selected based on the results of the ELISA examination and clinical signs and beside Twenty healthy individual subject were used as control group . Genomic DNA was isolated from blood sample for fifteen patient and twenty healthy subjects as control group according to the protocol of kit (ReliaPrep™ Blood gDNAMiniprep System, Promega).

**Primers and optimization of PCR reaction:** Regions of *ITGB3* gene were selected and amplified by PCR using primers (designed by the program PRIMER3) . PCR reaction system contained 12  $\mu$ M of Master Mix, 10  $\mu$ M each of oligonucleotide primers, 8.5 $\mu$ M Nuclease Free Water, 2  $\mu$ M Taq DNA Polymerase . Thermocycling conditions of primers *ITGB3* -(F5`-TCCATAGCACCTCCACATA-3` and R5`-GGGTTTGGAGAGAGGATAGA-3`, and primers -F5`-TGAGCAGGTGTTCTTCATTAC-3` and -R5`-CTGTGGCCTCTCAGATTAAG-3`) were as follows: an initial denaturation at 95 °C for 5 min, followed by 30 cycles of denaturation, annealing, and extension at 95 °C for 45 s, 60 °C for 45 s, and 72 °C for 45 s Respectively.

A final extension step (72 °C, 7 min) was performed at the end.

**Direct Sequencing analysis:** PCR products were directly sequenced using by Macrogen Corporation of Korea, and the results were analyzed using a genious program. according to the manufacturer's protocol. The samples were then run on the ABI3730XL genetic analyzer (TF). The sequence is compared with the cDNA sequence of the human genome and gene, and its accession number is *ITGB3* (NM:000212, NC:000017).

**Statistical analysis:** Allele frequencies of *ITGB3* gene and significant departure from Hardy-Weinberg (H-W) equilibrium were calculated using H-W calculator for two alleles, which is available free online at (<https://wpcalc.com/en/equilibrium-hardy-weinberg/>) . A Significant differences between the observed and expected frequencies were assessed by Pearson's Chi-square test (10). Alleles and genotypes of SNPs of *ITGB3* gene were presented as percentage frequencies, and significant differences between their distributions in GT patients and controls were assessed by two-tailed Fisher's exact probability (P). In addition, odd ratio (OR), etiological fraction (EF) and preventive fraction (PF) were also estimated to define the association between SNPs GPIIb/IIIa alleles and genotypes with the disease, and these estimations were calculated by using the WINPEPI computer programs for epidemiologists<sup>(11)</sup>.

## Result

Form total of fifty-two patient with dysfunction of platelets ELISA test show fifteen patients with GT disease.

The product of PCR amplification was showed after staining with ethidium bromide, Where a main band (904bp in length) appeared on the gel, representing the amplification of the restriction region of the *ITGB3* gene from chr17: 47310522-47311425, and the amplification between chr17: 47311191-47312137 was showed a region which represented (947bp) on the gel (Figure 1).

The direct DNA sequencing result revealed three mutations were found (c. \* 1479T> C, c.\*713A>G, and c.\*1016T>A) of an *ITGB3* gene .

The c. \* 1479T> C (rs115310198) mutation, replace the nucleotide T at chr17:47311683 (GRCh38.p12) with C, which is located in the 3'UTR region of the integrin  $\beta 3$  gene (figure 2). The genotyping of c.\*713A>G (rs2317676) changed A>G in three samples (one homozygotes and two heterozygotes) of *ITGB3* gene chr17:47310917 (GRCh38.p12) show in (figure 3) . c.\*1016T>A (rs3809865) is located in the 3'UTR region of the *ITGB3* gene, and T> A changes at position chr17:47311220 (GRCh38.p12) (figure 4) .

The genotype distribution of these three variants is consistent with Hardy-Weinberg balance (P>0.05). The SNP c.\*1016T>A (rs3809865) at position-chr17:47311220 (GRCh38.p12) was presented with two alleles (T and A) and three genotypes (TT, TA and AA). These genotypes showed deviation from HWE in GT patients and control group respectively, because there was a significant difference between the observed and expected genotype frequencies (p  $\leq$  0.05). Comparing GT patients to controls revealed that genotype frequencies of TT (87.6 vs. 85 %) and TA (6.6 vs. 15%), while the third genotype (AA) was observed with a frequency 6.6 vs. 0% in patients and control group respectively, The genotypes AA, AT and TT in control group was non-significant difference (P>0.05) compared to GT patient but the genotype (AA) (OR= 4.24) was considered as risk factors with GT patients .It was also noticed the frequency of mutant allele (A) show a non-significant difference (p > 0.05) in GT patients compared to controls (10 vs. 7.5%; OR = 1.37; EF = 0.11; 95% C.I. = 0.26 to 7.14) that mean (A) allele (OR = 1.37) is positively associated with GT patients and negatively associated with healthy subject, while in the control group the frequency of (T) allele show a non-significant difference (p > 0.05) compared to GT patients (90 vs. 92.5%; reciprocal OR= 1.37; EF = 0.71; 95% C.I. = 0.14 to 3.80) . In this case the (T) allele associated with healthy subject, but in GT patients group was negatively associated with reciprocal OR= 1.37 (Table).

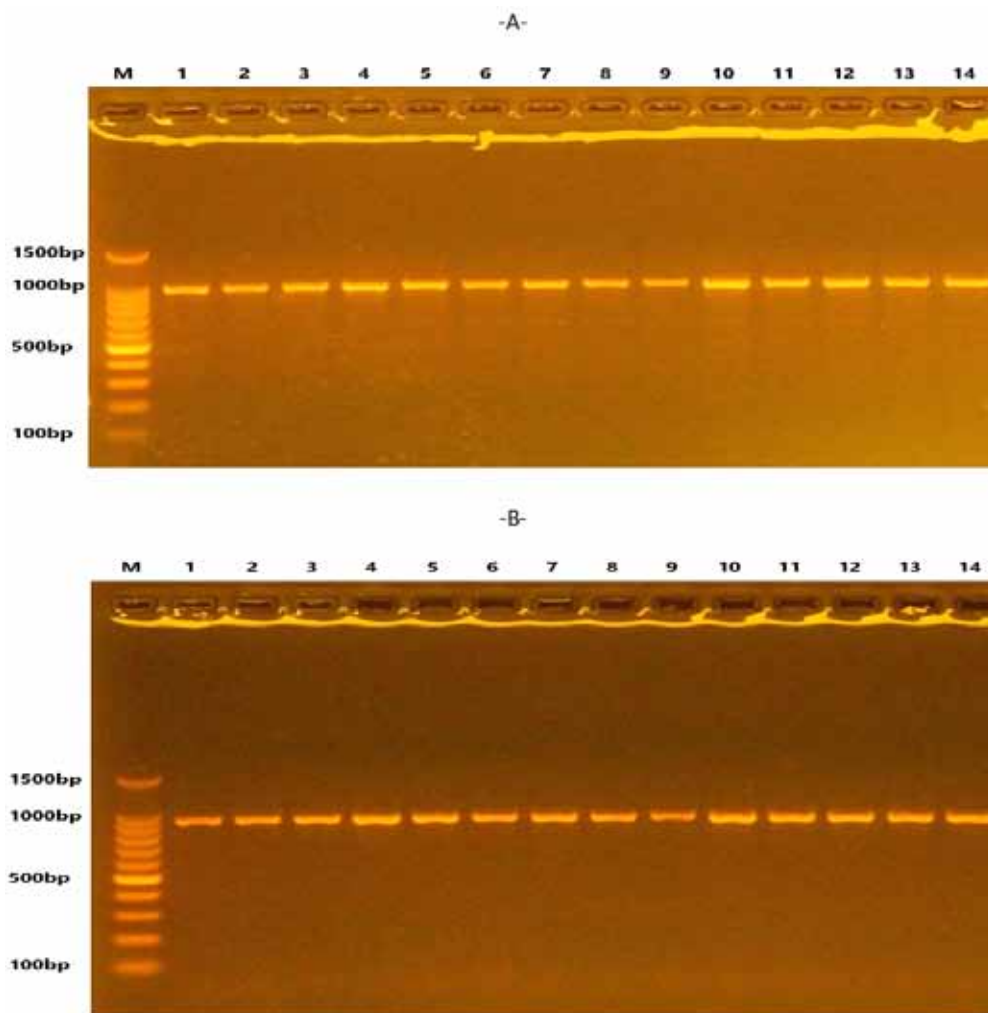


Figure 1 : The amplicon for *ITGB3* gene : A- from chr17 :47310522-47311425 which contains part from 3' UTR of *GT* patients with band have 904 bp . B- from chr17: 47311191-47312137 which contains part from 3' UTR of *GT* patients with band have 947 bp . The 2% agarose gel was assay by using at 7C voltages for one hour

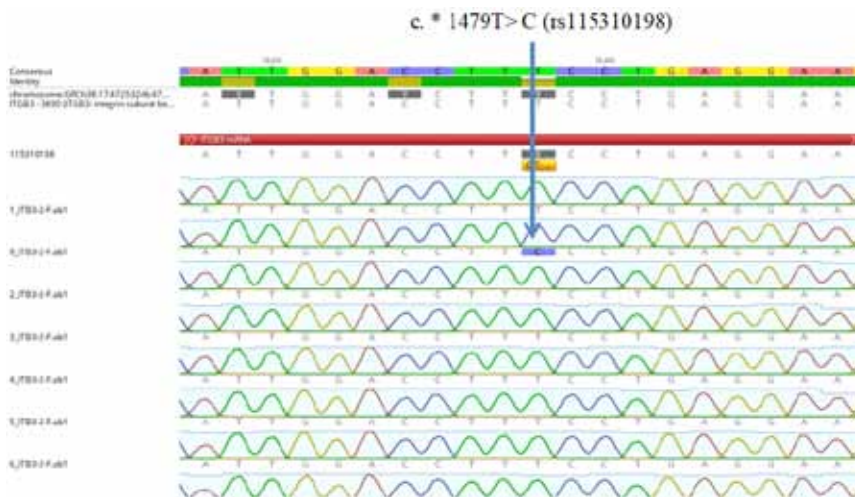


Figure 2 : The DNA direct sequencing for *GT* patients show the nucleotide substitution T>C at position 1479 in 3'UTR region for *ITGB3* gene .

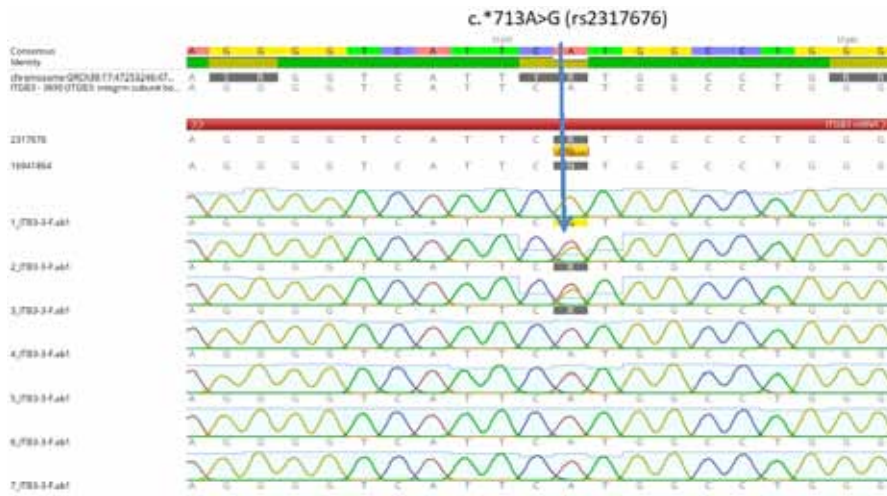


Figure 3 : The DNA direct sequencing for GT patients show the nucleotide substitution A>G at position 713 in 3UTR region for *ITGB3* gene .

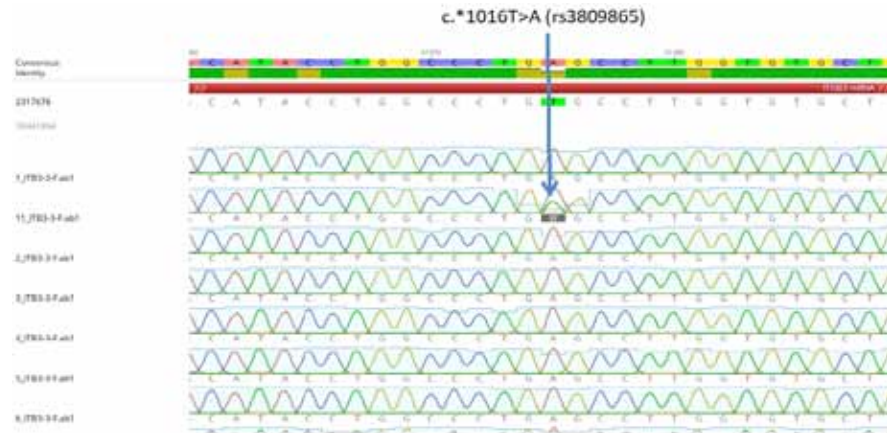


Figure 4: The DNA direct sequencing for GT patients show the nucleotide substitution T>A at position 1016 in 3UTR region for *ITGB3* gene .

The SNP rs2317676 (c.\*713A>G) at a place: 47310917 for chromosome (GRCh38.p12) was presented with two alleles (A and G) and three genotypes (AA, AG and GG). These genotypes showed deviation from HWE in GT patients, because there was a significant difference between the observed and expected genotype frequencies ( $p \leq 0.05$ ), it was also noticed the genotypes frequencies (AA, AG and GG) show deviation from HWE in controls group with significant difference ( $p \leq 0.05$ ). Comparing controls to GT patients revealed that genotype frequencies of AA (80.6 vs. 90%), AG (6.6 vs. 5%), and The third genotype (GG) 13.3 vs. 0% . These genotypes were non-significant difference ( $P > 0.05$ ) compared between control and GT patient. it was also noticed the frequency of mutant allele (G) show non-significant difference ( $p > 0.05$ ) in GT patients compared with controls (16.6 vs. 5 %; OR = 3.8; EF = 0.4; 95%

C.I. = 0.70 to 20.63), while in the control group the frequency of (A) allele show a non-significant difference ( $p > 0.05$ ) compared to GT patients (83.3 vs. 95%; EF 0.71; 95% C.I. 0.05 to 1.43) . In this case the (A) allele associated with healthy subject and non-associated with GT patients (reciprocal OR = 3.8) and considered as protective factor (Table).

The rs115310198 at position 47311683 for chromosome 17 (GRCh38.p12) was presented with three genotypes (TT, TC and CC), and two alleles (T and C) .These genotypes showed deviation from HWE in GT patients, because there was a significant difference between the observed and expected genotype frequencies ( $p \leq 0.001$ ), it was also noticed a deviation from HWE in controls treatment with non-significant difference ( $p > 0.05$ ). Comparing controls to GT patients revealed that

genotype frequencies of TT (87.6 vs. 95 %), TC (0 vs. 5 %), and The third genotype (CC) 13.3 vs. 0% . The TT, TC, and CC genotypes were show non-significant difference( $p>0.05$ ) between healthy subject and GT patient . The CC genotype (OR= 7.5) was considered as risk factors . it was also noticed the frequency of mutant allele (C) show non- significant difference ( $p > 0.05$ ) in GT patients compared to controls (13.3 vs. 2.5%; OR = 6; EF = 0.03; 95% C.I. = 0.65 to 55.05) that mean

(C) allele is risk factor associated with GT patients and negatively associated of healthy, while in the control group the frequency of (T) allele show non-significant difference ( $p>0.05$ ) compared to GT patients (86.6 vs. 97.5; OR = 0.17; EF 0.37; 95% C.I. = 0.02 to 1.53) and it (OR = 6 reciprocal) was considered as protective factor of health subject (positively associated of health and negatively associated of GT patients) (Table).

Table : Genotype and allele frequencies and epidemiological parameters for Iraqi GT patients and controls.

ITGB3 gene	GT patients(n=15)			Control(n=20)			Epidemiological parameters				
	Observed N (%)	Expected N (%)	HWE p-value =0.05	Observed N (%)	Expected N (%)	HWE p-value =0.05	OR	EF	PF	$\chi^2$ p-value	CI 95%
<b>rs3809865</b>											
TT	13 (87.6)	12.1 (81)	0.05	17 (85)	17.1(85.5)	0.05	1.15	0.78	0.11	1	0.18 to 7.45
TA	1(6.6)	2.7 (18)		3(15)	2.7(13.8)		0.4	0.12	0.08	0.6	0.04 to 4.02
AA	1(6.6)	0.15 (1)		0(0)	0.11 (0.5)?		4.24	0.09	0.07	0.4	0.18 to 102.5
T	27(90)			37(92.5)			1.37*	0.71	0.25	1	0.14 to 3.80
A	3 (10)			3(7.5)			1.37	0.11	0.02	1	0.26 to 7.14
<b>rs2317676</b>											
AA	12(80)	10.4(69.4)	0.05	18(90)	19(95.)	0.05	0.44	0.61	0.5	0.6	0.07 to 2.90
AG	1(6.6)	4.16(27.7)		2(5)	0.9(4.8)		0.64	0.15	0.03	1	0.06 to 7.25
GG	2(13.3)	0.41(2.7)		0(0)	0.1(0.6)?		7.59	0.07	0.13	0.1	0.37to 157.72
A	25(83.3)			38(95)			3.8*	0.3	0.7	0.13	0.05 to 1.43
G	5(16.6)			2(5)			3.8	0.4	0.12	0.13	0.70 to 20.63
<b>rs115310198</b>											
TT	13(87.6)	11.2(75.1)	0.001	19. (95)	19(95)	N.S.	0.34	0.73	0.62	0.5	0.03 to 3.89
TC	0(0)	3.4 (23.1)		1(5)	0.9(4.8)		0.42	0.1	0.04	1	0.02 to 10.00
CC	2(13.3)	0.26 (1.7)		0(0)	0.01(0.06)		7.5	0.07	0.13	0.1	0.37 to 157.72
T	26(86.6)			39(97.5)			6*	0.37	0.81	0.1	0.02 to 1.53
C				1(2.5)			6	0.03	0.11	0.1	0.65 to 55.05

EF: Etiological fraction , PF: Preventive Fraction , OR :Odd ratio , C.I. : Confidence interval ,HWE :Hardy-Weinberg Equilibrium , \* : odds ratio (Reciprocal) , N.S :non-significant .  $\chi^2$  p-value : Fishers Exact probability .

### Desiccation

Glanzmann's thrombasthenia laboratory diagnosis depends on a series of studies on platelet aggregation, molecular biology, elisa, and flow cytometry<sup>(4)</sup>.

In this study, the ELISA technique was used to

differentiate between Glanzmann's patients and other patients with platelet dysfunction based on a comparison with the control group.

The use of ELISA technology can identify platelet diseases by determining the amount of reaction between



the antigen and the receptor, so that it is possible to diagnose the presence of platelet dysfunction and the severity of the disease. the receptor GPIIb/IIIa on the platelets act as the target antigen. The use of ELISA technique for detection of cases in GT and also which is effective cost, easy, sensitive, and specific perform diagnosis<sup>(4)</sup>.

c.\*1016T>A (rs3809865) and c. \* 1479T> C (rs115310198) are located in the 3'UTR region of the *ITGB3* gene. The 3'UTR region regulates the expression and regulation of  $\beta 3$  integrin gene at the mRNA level, and interacts with miRNA (1). rs3809865 and rs115310198 may functionally affect the binding of miRNA, therefore, the protein expression level of integrin  $\beta 3$  subunit<sup>(12)(13)</sup>.

c.\*713A>G (rs2317676) is located in the 3'UTR region of the *ITGB3* gene. SNP can affect the expression of integrin by affecting the stability of microRNA. (MiRNA) and gene binding, this is the mechanism proposed by rs2317676 (A/G) for the *ITGB3*miRNA binding site, which can affect the residual amount of a *Ibb3* in the presence of other causal mutations, but this remains to be proven in GT<sup>(14)</sup>.

**Conflict of Interest:** There is no conflict of interest among the authors.

**Funding:** Self

**Ethical Clearance:** This study is ethically approved by the Institutional ethical Committee.

## Reference

1. Kaushansky K, Lichtman MA, Beutler E, Kipps TJ, Seligsohn U, Prchal JT. Williams hematology. 8 ed: McGraw-Hill; 2010.
2. Seligsohn U. Glanzmann Thrombasthenia: A model disease which paved the way to powerful therapeutic agents. Pathophysiology of haemostasis and thrombosis. 2002;32:216-7.
3. Tholouli E, Hay CR, O'Gorman P, Makris M. Acquired Glanzmann's thrombasthenia without thrombocytopenia: a severe acquired autoimmune bleeding disorder. Br J Haematol. 2004;127(2):209-13.
4. Lobo V, Shetty S, Kulkarni B, Ghosh K. A novel ELISA for diagnosis of Glanzmann's thrombasthenia and the heterozygote carriers. Annals of hematology. 2012;91(6):917-21.
5. Bennett JS. Structure and function of the platelet integrin alpha IIb beta3. J Clin Invest. 2005;115(12):3363-9.
6. Jin Y, Wilhide CC, Dang C, Li L, Li S-X, Villa-Garcia M, et al. Human integrin  $\beta 3$  gene expression: evidence for a megakaryocytic cell-specific cis-acting element. Blood, The Journal of the American Society of Hematology. 1998;92(8):2777-90.
7. Jayo A, Conde I, Lastres P, Martínez C, Rivera J, Vicente V, et al. L718P mutation in the membrane-proximal cytoplasmic tail of beta 3 promotes abnormal alpha IIb beta 3 clustering and lipid microdomain coalescence, and associates with a thrombasthenia-like phenotype. Haematologica. 2010;95(7):1158-66.
8. Motlagh F, Fallah M-S, Bagherian H, Shirzadeh T, Ghasri S, Dabbagh S, et al. Molecular genetic diagnosis of Glanzmann syndrome in Iranian population; Reporting novel and recurrent mutations. Orphanet Journal of Rare Diseases. 2019;14.
9. Bellucci S, Caen J. Molecular basis of Glanzmann's Thrombasthenia and current strategies in treatment. Blood reviews. 2002;16(3):193-202.
10. Ad'Hiah AH. Immunogenetic studies in selected human diseases: University of Newcastle upon Tyne; 1990.
11. Abramson JH. WINPEPI updated: computer programs for epidemiologists, and their teaching potential. Epidemiologic perspectives & innovations: EP+I. 2011;8(1):1.
12. Bianconi D, Schuler A, Pausz C, Geroldinger A, Kaider A, Lenz H-J, et al. Integrin beta-3 genetic variants and risk of venous thromboembolism in colorectal cancer patients. Thrombosis Research. 2015;136(5):865-9.
13. Müller D, Bosserhoff A. Integrin  $\beta 3$  expression is regulated by let-7a miRNA in malignant melanoma. Oncogene. 2008;27(52):6698-706.
14. Pillois X, Nurden AT. Linkage disequilibrium amongst ITGA2B and ITGB3 gene variants in patients with Glanzmann thrombasthenia confirms that most disease-causing mutations are recent. British journal of haematology. 2016;175(4):686-95.

# The Role of P53 Serine 46, Burkitt Cell Lymphoma 2 (BCL-2), and Cysteinyl Aspartate Specific Proteinase 3 (Caspase 3) Proteins as Risk Factors in Abortion

Herlambang Herlambang<sup>1</sup>, Firman F. Wirakusumah<sup>2</sup>, Jusuf S. Effendi<sup>2</sup>,  
Ida Parwati<sup>3</sup>, Leri Septiani<sup>4</sup>, Ahmad Faried<sup>5</sup>, Hiroyuki Kuwano<sup>6</sup>

<sup>1</sup>Senior Lecturer, Department of Obstetrics and Gynecology, Faculty of Medicine and Health Science, Universitas Jambi/Raden Mattaher Hospital, Jambi, Indonesia, <sup>2</sup>Professor, Division of Fetomaternal, Obstetric and Gynecology Department, Universitas Padjadjaran/Hasan Sadikin Hospital, Bandung, Indonesia, <sup>3</sup>Professor, Pathology Clinics Department, Universitas Padjadjaran/Hasan Sadikin Hospital, Bandung, Indonesia, <sup>4</sup>Researcher, Obstetric and Gynecology Department, Universitas Padjadjaran/Hasan Sadikin Hospital, Bandung, Indonesia, <sup>5</sup>Associate Professor, Neurosurgery Department, Universitas Padjadjaran/Hasan Sadikin Hospital, Bandung, Indonesia, <sup>6</sup>Professor, Department of General Surgical Science, Gunma University, Graduate School of Medicine, Japan

## Abstract

An Incomplete abortion is one of the complications that often occur during pregnancy, but the biomolecular mechanism is still unknown. It has proven to be an increase in apoptosis activity that is controlled by a variety of proteins, including p53 Ser 46, Bcl-2, and caspase 3, in uteroplacenta and reproductive organs. The aim of the study is to measure the level of protein p54 Ser 46, Bcl-2, and caspase 3 in abortion and normal pregnancy. A case control study conducted in 38 cases of incomplete abortion and 38 normal pregnancies as a control. The level of protein of Ser 46, Bcl-2, and caspase 3 examined by ELISA independent/Duplo. The higher level of p53 Ser 46 ( $> 0,09$  U/mL) led to higher risks of abortion with OR 8.52; 95% CI, 2.65 to 28.6. The higher level of Bcl-2 led to higher risks of abortion with OR 3.75; 95% CI, 1.24 to 11.68. The higher level of caspase 3 ( $> 7$  mg/mL) and p53 Ser 46 ( $> 0,09$  U/mL) led to higher risks of abortion with OR 71.15; 95% CI, 8.74 to 578.92; with the result of series p, p, 0.001; p  $< 0.008$ ; and p = 0.001. Level of protein p53 Ser 46 and caspase 3 in abortion is higher than normal pregnancies, while the Bcl-2 protein levels in abortion is lower than normal pregnancies.

**Keywords:** *Burkitt cell lymphoma, cysteinyl aspartate specific proteinase 3, risk factors in abortion*

## Introduction

Abortion is the termination of pregnancy before 20 weeks pregnancy or fetal weighs less than 500 grams. It is still an obstetric problem that has not been uncovered<sup>[1-3]</sup>. Abortion is one of the causes of maternal

and fetal mortality today. The causes of abortion have been reported are due to genetic disorders such as abnormalities of the conceptus as a result of chromosomal abnormalities<sup>[4-6]</sup>. Other causes include developmental abnormalities of the zygote, embryo of placenta, infection, endocrines disorders and immunological disorders. Abortion is also influenced by maternal age, parity, and history of recurrent abortion<sup>[2,7-10]</sup>. Abortion is a highly complex process, controlled by variety of genes, including the gene p53, cl-2, and the caspase of cysteinyl aspartate specific proteinase (caspase). All of the genes play a role in the regulation of apoptosis either in a normal or abnormal circumstance which results in pregnancy failure. The involvement of apoptosis activator can cause excessive apoptosis. The presence of excessive

---

### Corresponding Author:

#### Herlambang Herlambang

Senior Lecturer, Department of Obstetrics and Gynecology, Faculty of Medicine and Health Science, Universitas Jambi/Raden Mattaher Hospital, Jambi, Indonesia

e-mail: herlambang07@yahoo.co.id

apoptosis will continue with cell death characterized by caspase 3, ended with abortion [11-17].

The excessive apoptosis in syncytiotrophoblast will result in failure of pregnancy, in addition to the role of the decidua and plasenta to give support and protect embryo development. Result of human studies has not found an association between the gene p53 through the protein p53 expression on Ser 46 and Bcl-2 against caspase 3 in the first trimester and the association with the incidence of abortion. Based on that, we were interested to investigate [17-19].

### Research Method

The subjects were pregnant women with gestational age between 10-20 weeks who diagnosed with incomplete abortion (as the case group), whereas normal pregnancy as a control group. The inclusion criteria are 10 – 20 weeks of gestational age and maternal age between 16 – 35 years. We excluded subjects with abnormal uterine; kidney disorders, heart disease, hypertension, diabetes mellitus, lung, thyroid, and other chronic diseases, malignancy; pregnant with help medication or taking hormonal drugs.

This is a comparative analytic study with case control design. The sample size was determined based on the formula to test the hypothesis by using a correlation coefficient  $r$  ( $n = \frac{1}{r^2}, 5 \approx 3$  people per group). The research activities carried out in the Section/SMF Obstetrics and Gynecology FKUP/RSHS, Cibabat Cimahi Hospital, dr . Slamet Garut Hospital, and Gunma University, Japan. The independent variables are levels of protein p53 Ser 46, Bcl - 2 and caspase 3; the dependent variables are an incomplete abortion

and normal pregnancy; by confounding variables that maternal age, gestational age, and parity.

We examined the levels of protein p53 Ser 46, Bcl-2 and caspase 3 at the Laboratory of the Department of General Surgical Science, Graduate School of Medicine Gunma University, Maebashi, Gunma, Japan. The Shapiro-Wilk used for normality test data, the T test is used to compare two values average normal distribution of data, X2 test (Chi squared) was used to test for differences in percentage to the data presented in contingency tables, Mann-Whitney test was used to compare differences in 2 the middle value the data which are not normally distributed, Rank Spearman correlation test is used to find relationship between two numerical variables, Odd ratio: in the case-control study pointed to the ratio between the odds at-risk and non-risk groups, logistic regression aims to analyze data in multiple independent variables and nominal numeric scale, the nominal scale dichotomous dependent variable. Significance based on the value of meaningful when  $p \leq 0,05$ , very meaningful  $p \leq 0,01$ .

All of the subjects involved voluntary after receiving explanation of the advantages and disadvantages (informed consent), the subject were also free to resign at any time for any reason without causing changes in the quality of service.

### Result

Characteristics of the study subjects according to maternal age, parity, and gestational age in normal pregnancy and abortion can be seen in Table 1. Range of ages between from 19 to 35 years, parity ranges from 1 to 4, while for gestational age ranged from 10 to 14 weeks.

**Table: 1. Characteristics of Subjects Research by Maternal Age, Total Parity and Gestational Age in Normal Pregnancy and Abortion**

Characteristics	Gestation		Significance
	Abortus (n=38)	Normal (n=38)	
Maternal age (year)			$Z_{M-W} = 1.282$ $p = 0.200$
< 20	2 (5.3%)	1 (2.6%)	
20–24	4 (10.5%)	5 (13.2%)	
25-29	18 (47.4%)	13 (34.2%)	
30–35	14 (36.8%)	19 (50.0%)	
$\bar{X}$ (SD)	27.6 (4.2)	28.8 (4.6)	
Median	28	29.5	
Range	19-35	19-35	

Characteristics	Gestation		Significance
	Abortus (n=38)	Normal (n=38)	
Parity			$X^2 = 0.234$ p = 0.629
1-2	26 (68.4%)	24 (63.2%)	
≥3	12 (31.6%)	14 (36.8%)	
Range	19-35	19-35	
Gestational Age			$X^2 = 0.290$ p = 0.990
10 week	9 (23.7%)	8 (21.1%)	
11 week	7 (18.4%)	6 (15.8%)	
12 week	10 (26.3%)	10 (26.3%)	
13 week	6 (15.8%)	7 (18.4%)	
14 week	6 (15.8%)	7 (18.4%)	

**Explanation:** The p – value is calculated based on the Chi Square test or Mann-Whitney test

Meaningful when  $p \leq 0.05$ , very significant if  $p \leq 0.01$ ;

ZM – W = Mann-Whitney

**Table: 2. Comparative Levels of Protein p53 Ser 46, Bcl-2 and Caspase 3 between Normal Pregnancy and Abortion**

Variable	Gestation		$Z_{M-W}$	p-value
	Abortus (n=38)	Normal (n=38)		
p53 Ser 46 (U/mL)			4.413	<0.001**
$\bar{X}$ (SD)	0.114 (0.023)	0.095 (0.013)		
Median	0.11	0.09		
Range	0.09–0.17	0.08–0.14		
Bcl-2 (ng/mL)			1.928	0.027*
$\bar{X}$ (SD)	7.265 (1.712)	7.493 (3.939)		
Median	7.115	6.445		
Range	2.60–11.15	5.58–29.44		
Caspase 3 (mg/mL)			5.913	<0.001**
$\bar{X}$ (SD)	112.74 (152.73)	14.94 (23.18)		
Median	76.5	12.62		
Range	6.50–707.75	0–76		

**Explanation:** \* = significant ( $p \leq 0.05$ ), \*\* = very significant ( $p \leq 0.01$ );

$Z_{M-W}$  = Mann-Whitney test

**Table: 3. Abortion Risks Based on Value Cut-off Levels of Protein p53 Ser 46, Bcl-2 and Caspase 3**

Variable	Gestation		P-values *	OR (95% CI)
	Abortus (n=38)	Normal (n=38)		
p53 Ser 46 (U/mL)			< 0.001	8.52 (2.65–28.6)
> 0.09	31 (81.6%)	13 (34.2%)		
≤ 0.09	7 (18.4%)	25 (65.8%)		
Bcl-2 (ng/mL)			0.008	3.75 (1.24–11.68)
> 6.44	30 (78.9%)	19 (50%)		
≤ 6.44	8 (21.1%)	19 (50%)		
Caspase 3 (mg/mL)			<0.001	71.15 (8.74–578.92)
> 7	37 (97.4%)	13 (34.2%)		
≤ 7	1 (2.6%)	25 (65.8%)		

**Explanation:** \* based on Chi-Square test

**Table 4. Logistic Regression Analysis of Multiple Protein p53 Ser 46, Bcl - 2 and Caspase 3 with Incident abortion**

Variable	Koef $\beta$	SE	p-Values	OR <sub>adj</sub> (95% CI)
p53 Ser 46 (U/mL) ( $> 0.09$ vs $\leq 0.09$ )	1.744	0.695	0.012	5.72 (1.46–22.33)
Bcl-2 (ng/mL) ( $> 6.44$ vs $\leq 6.44$ )	1.227	0.711	0.084	3.41 (1.06–11.02)*
Caspase 3 (mg/mL) ( $> 7$ vs $\leq 7$ )	3.963	1.11	$<0.001$	52.60 (5.97–463.15)
Constanta	-4.855			

**Explanation:** The accuracy of the model = 88.2  
OR adj adjusted odds ratio = value; \*) Test of the parties

**Table 5: Opportunities occurrence of abortion based Risk Factors Levels of Protein p53 Ser 46, Bcl-2 and Caspase 3**

p53 Ser 46 (U/mL)	Bcl-2 (ng/mL)	Caspase 3 (mg/mL)	Incident Abortion P (Y) <sup>x</sup>
$\leq 0.09$	$\leq 6.44$	$\leq 7$	0.008
$\leq 0.09$	$\leq 6.44$	$>7$	0.291
$\leq 0.09$	$> 6.44$	$\leq 7$	0.026
$\leq 0.09$	$> 6.44$	$>7$	0.583
$> 0.09$	$\leq 6.44$	$\leq 7$	0.043
$> 0.09$	$\leq 6.44$	$>7$	0.701
$> 0.09$	$> 6.44$	$\leq 7$	0.132
$> 0.09$	$> 6.44$	$>7$	0.889

**Explanation:** <sup>x</sup> calculated as logistic regression model

## Discussion

The characteristics of the study subjects included were maternal age, parity, and gestational age because these characters act as a risk factor for abortion potentially confounding variables that could affect the validity of the study. Characteristics of study subjects Ser 46 levels of p53 protein, Bcl - 2 and caspase 3 compared between cases, ie an incomplete abortion and the control group, which is a normal pregnancy. To reduce the confusion, we used cases and controls with homogeneous characteristics. Abortion happens to gestational age less than 10 weeks allegedly influenced by immunological factors and chromosomes, whereas at 10 weeks gestation or more influenced by external factors, such as infections, malnutrition, trauma, or systemic disease [2, 7, 10]. In this study, only women with gestational age of 10 weeks or more are included so that it can be removed possibility immunological factors and chromosomes that can cause abortion.

It was generally agreed that the state of maternal age  $\geq 35$  years and with the increasing number of parity would be associated with an increase in the number of abortus [7, 20]. Therefore, in this study only mothers aged less than 35 years were included in the study, considering maternal age  $\geq 35$  years found an increase in the number of abortions. Based on Table 2 showed levels of Bcl - 2 in the abortion group had a mean lower than in the normal group and differ very significantly ( $p < 0.01$ ), whereas for protein levels of p53 Ser 46 and caspase 3 in the abortion group had a mean higher compared with the normal group different highly significant ( $p < 0.01$ ). Savion et al reported a decrease in Bcl-2 associated with apoptosis and ends with abortion in animal experiments [18]. Bcl-2 protein is an anti-apoptotic protein strong measure to prevent the cells from death and levels remain high in the outer mitochondrial membrane. Bcl-2 protein can also be used as an early detection apoptosis. Abortion in the first trimester of pregnancy is closely linked to an

increase in apoptosis in syncytiotrophoblast compared to normal pregnancy.<sup>[22]</sup> Unlike immunohistochemistry examination, in this study with ELISA examination the serum sample derived from an unknown where the apoptosis takes place. In this study, a decrease in the levels of Bcl-2 in abortion patients compared with normal pregnancy. It shows the mitochondrial pathway plays a role apoptosis in pregnancy failure induced by regulation of Bcl-2 [12, 17, 21, 22].

In this study, table 3, 4, and 5 showed increased levels of caspase 3 was very significant in abortion patients compared with normal pregnancy ( $p < 0.001$ ). This supports the theory that the higher the levels of caspase 3 in the first trimester of pregnancy will be more at risk of pregnancy failure. Involvement proapoptosis activators can cause excessive apoptosis, followed by cell death characterized by increased levels of caspase-3, and finally continue with abortion. Increased fetal resistance to stress teratogen is an outcomes of maternal immunopotentiating associated with a decrease in the intensity of apoptosis induced teratogenic substances on fetal structure targets. These findings indicate maternal immunopotentiating effect can be produced through the modification of the expression of molecular regulation of apoptosis induced teratogenic substances. P53 expression increase significantly in pregnancies with fetal growth retardation, but did not get a reduction in the expression of Bcl - 2 meaningful, The different results shown in this study despite the increased levels of p53 Ser 46 on abortion, the result the average levels of Bcl-2 in the study subjects who experienced abortion is lower compared with normal pregnancy were significantly different [12, 16, 17, 21, 22].

The protein p53 Ser 46, Bcl-2 and caspase 3 was significantly associated with the incidence of abortion. Multivariable sequence of the protein was strongly correlated with the incidence of abortion is caspase 3, following the protein p53 Ser 46, and last Bcl-2. Caspase 3 has the strongest risk for abortion because caspase 3 serves as the main effectors in both basic apoptotic pathway, namely receptor-mediated pathway (extrinsic) and pathways mediated mitochondrial (intrinsic). Abnormal embryonic development involves several important things, namely: 1) apoptosis induced teratogenic substances can cause structural abnormalities; 2) the effect is obviously accompanied by increased expression of TNF- $\alpha$  and TNFR 1 in embryonic organ; 3) resistance/sensitivity of the various structures of the embryo to the substances teratogen depends on

the interaction between positive regulators of apoptosis such as caspase 3, 8 and p53, while a negative regulator of apoptosis such as NF-kB and Bcl-2; 4) maternal immunopotentiating can affect the activity of molecules that cause apoptosis in the embryo as a response to adverse stimuli and modulate the sensitivity of embryos to teratogens substances. Similar results were obtained in our study, although not further investigated what factors are causing the failure of the pregnancy [12, 17, 21, 22].

**Conflict of Interest:** The authors reported no conflicts of interest.

**Funding:** This study is self-funding research.

**Ethical Clearance:** The study was approved by the Research Ethics Committee at the Faculty of Medicine Universitas Padjadjaran/Hasan Sadikin Hospital, Bandung, Indonesia

## References

1. Kurjak A, Chervenak FA. Donald School Textbook of Ultrasound in Obstetrics and.
2. Gabbe SG, Niebyl JR, Simpson JL, Landon MB, Galan HL, Jauniaux ER, et al. *Obstetrics: normal and problem pregnancies e-book*: Elsevier Health Sciences; 2016.
3. Crum CP, Lee KR, Nucci MR, Granter SR, Howitt BE, Parast MM, et al. *Diagnostic Gynecologic and Obstetric Pathology E-Book*: Elsevier Health Sciences; 2017.
4. Catt JW, Henman M. Toxic effects of oxygen on human embryo development. *Human Reproduction*. 2000;15(suppl\_2):199-206.
5. Kurjak A, Chervenak FA, Carrera JM. *The embryo as a patient*: Parthenon Publishing; 2001.
6. Jauniaux E, Farquharson RG, Christiansen OB, Exalto N. Evidence-based guidelines for the investigation and medical treatment of recurrent miscarriage. *Human reproduction*. 2006;21(9):2216-22.
7. Sara H, Garmel M. *Early Pregnancy Risks; Current Obstetric and Gynecologic Diagnosis & Treatment*. McGraw-Hill Companies; 2003.
8. Lashen H, Fear K, Sturdee D. Obesity is associated with increased risk of first trimester and recurrent miscarriage: matched case-control study. *Human reproduction*. 2004;19(7):1644-6.
9. Speroff L, Fritz MA. *Clinical gynecologic*

- endocrinology and infertility: lippincott Williams & wilkins; 2005.
10. Tomassetti C, Meuleman C, Pexsters A, Mihalyi A, Kyama C, Simsa P, et al. Endometriosis, recurrent miscarriage and implantation failure: is there an immunological link? *Reproductive biomedicine online*. 2006;13(1):58-64.
  11. Pérez-Pérez A, Toro AR, Vilarino-Garcia T, Guadix P, Maymó JL, Dueñas JL, et al. Leptin reduces apoptosis triggered by high temperature in human placental villous explants: The role of the p53 pathway. *Placenta*. 2016;42:106-13.
  12. Liu G-P, Wei W, Zhou X, Zhang Y, Shi H-H, Yin J, et al. I2PP2A regulates p53 and Akt correlatively and leads the neurons to abort apoptosis. *Neurobiology of aging*. 2012;33(2):254-64.
  13. Leber B, Lin J, Andrews DW. Embedded together: the life and death consequences of interaction of the Bcl-2 family with membranes. *Apoptosis*. 2007;12(5):897-911.
  14. Lea RG, Riley SC, Antipatis C, Hannah L, Ashworth CJ, Clark DA, et al. Cytokines and the regulation of apoptosis in reproductive tissues: a review. *American Journal of Reproductive Immunology*. 1999;42(2):100-9.
  15. Brill A, Torchinsky A, Carp H, Toder V. The role of apoptosis in normal and abnormal embryonic development. *Journal of assisted reproduction and genetics*. 1999;16(10):512-9.
  16. Torchinsky A, Toder V. To Die or Not to Die: the Function of the Transcription Factor NF- $\kappa$ B in Embryos Exposed to Stress. *American Journal of Reproductive Immunology*. 2004;51(2):138-43.
  17. Toder V, Carp H, Fein A, Torchinsky A. The role of pro-and anti-apoptotic molecular interactions in embryonic maldevelopment. *American journal of reproductive immunology*. 2002;48(4):235-44.
  18. Savion S, Lepsky E, Orenstein H, Carp H, Shepshelovich J, Torchinsky A, et al. Apoptosis in the uterus of mice with pregnancy loss. *American Journal of Reproductive Immunology*. 2002;47(2):118-27.
  19. Jerzak M, Bischof P. Apoptosis in the first trimester human placenta: the role in maintaining immune privilege at the maternal-foetal interface and in the trophoblast remodelling. *European Journal of Obstetrics & Gynecology and Reproductive Biology*. 2002;100(2):138-42.
  20. Marchetti T, Cohen M, De Moerloose P. Obstetrical antiphospholipid syndrome: from the pathogenesis to the clinical and therapeutic implications. *Clinical and Developmental Immunology*. 2013;2013.
  21. Reed JC. Bcl-2-family proteins and hematologic malignancies: history and future prospects. *Blood, The Journal of the American Society of Hematology*. 2008;111(7):3322-30.
  22. Nurdianto AR, Suryokusumo MG. Elevation of Bcl2 Expression in Spiralis Artery of Pregnant Rattus norvegicus Infected with tachyzoite of Toxoplasma gondii with Hyperbaric Oxygen Therapy. *Qanun Medika Jurnal Kedokteran FK UM Surabaya*. 2019;3(2):157-67.

# Healthy Home Concept According to Javanese Ethnic Panaragan Society: An Ethnolinguistic Study

Hujaefa Hi Muhamad<sup>1</sup>, Titi Rapini<sup>2</sup>, Sri Sugiharti<sup>3</sup>, Alip Sugianto<sup>4</sup>, Siska Diana Sari<sup>5</sup>

<sup>1</sup>Lecturer, Universitas Khairun, <sup>2</sup>Lecturer, Universitas Muhammadiyah Ponorogo, <sup>3</sup>Lecturer, Universitas Riau Kepulauan, <sup>4</sup>Lecturer, Universitas Muhammadiyah Ponorogo, <sup>5</sup>Lecturer, Universitas PGRI Madiun

## Abstract

Javanese ethnic Panaragan culture is very diverse. One of them is the traditional Javanese ethnic Panaragan home. The home as a shelter is expected to bring outer and inner health to its inhabitants. The concept of a healthy house can be known to the mindset of the people contained in language. The theory used is ethnolinguistics which views language tends to reflect the mindset of a society. The method is used ethnoscience by analyzing linguistic utterances in the realm of building a healthy house. As a result, there are outer and inner concepts before building construction, healthy house space and griyowingking concept that reflects a healthy home mindset for the comfort and safety of a residence which is summarized in language patterns.

**Keywords:** *Home, healthy, and ethnolinguistics.*

## Introduction

East Java region according to the culturalist Sutarto is divided into ten cultural regions consisting of Arek Culture, Samin (SeduluSikep), Osing (Using), Pandalungan, Madura Kangean, Madura, Pulau and Madura Bawean, Jawa Mataraman, Java Panaragan. <sup>(1)</sup> From the ten cultural regions, they have distinctive characteristics, and cultural style between regions. One of the cultures of East Java in the western region that has cultural diversity is the Panaragan Javanese Ethnic Culture.

The traditional Javanese Panaragan ethnic home, has its own way of expressing a place of staying and shelter for the Panaragan community which reflects the mindset of the society regarding concepts and mythology in building a home. To building a home, the society still has confidence in the determination of a good day that takes into account aspects of the Javanese calendar

calculation (petungandino) providing earth surgical offerings (ndudokris) and geographical calculation of the layout with the hope that the homes built will become safe, comfortable, and peaceful for its inhabitants.



**Figure 1. Traditional Home of Ethnic Java Panaragan (Reyog Ponorogo Document Archive)**

In building a Javanese ethnic Panaragan home is guided by a calculation of days (numerology) which is learned from the ancestors based on life experiences that are adjusted to the events on a daily basis based on the day character (watakding). In other words, the Panaragan Javanese Ethnic society adheres to the science of tit

---

### Corresponding Author:

**Hujaefa Hi Muhamad**

Ternate, North Maluku

e-mail: hujaefamuhammad@gmail.com



(ngelmutiten), in order to be more vigilant, cautious and careful in carrying out an action so that events that are considered not good, will not happen again in the future, avoid something that is not desirable and always get good every day from a house that is inhabited.

Daldini and Wistodiyono state that houses are not only a building for shelter and rest but according to Javanese ancestors used as a symbol of worship to Sang Hyang MahaWasesa.<sup>(2)</sup> Thus it can be understood that Javanese society has a close relationship with mindset with a belief that expresses a form of gratitude to the creator of the universe, with the hope of life in the household ark in a house always in His shade. For this reason, the Panaragan Ethnic Javanese Society before setting up a house usually determines the best day, among other good days. On that day held a celebration of thanksgiving to God through the ritual selamatan by presenting the neighbors led by warok (figure of society) or kyai (traditional religious scholar) as selamatan ritual leaders who are believed to have closeness to the strength believed. This activity, carried out in the hope of obtaining the safety of the Almighty.

Besides that, in building a house, avoid locations called sunduk sate (like satay) or just in front of the three way intersection (totokan). This perception is based, because of the safety factor which is of course the location of the sunduk sate is worrying if there is an accident that usually occurs due to someone's negligence in driving a vehicle. In addition, this assumption also underlies psychologically it can disrupt the peace and tranquility of the soul for residents because every day they are faced with a vehicle that seems to go to the end of the road or called a taboo so that it is not good for the health of the owner's soul because his heart is likened to every day crash (sunduki).

Abstinence (Pantangan) in building a home in the Panaragan Javanese Ethnic society, of course has a consequence that will occur if these restrictions are violated by the society. Even though this belief is increasingly fading, some people avoid it as a precaution. Therefore, in building a house, requires some consideration of certain aspects in maintaining harmony between physical and mental health. That is, the house that will be built gives comfort and tranquility in terms of physical buildings that affect the health aspects of the householder's inner, but also gives spiritual health to the residents of the home because it brings peace and tranquility to the inhabitants. This study aims to

find the relationship between language and culture in Javanese Panaragan society, especially the relationship of language and mindset that reflects the view of life in the realm of building a healthy home. Thus, the hope of the purpose of this study is expected to be achieved.

## Theory and Method

The theory used in this study refers to the adjusted Sapir-Whorf hypothesis, namely, that basically language tends to reflect the mindset of a society. In other words, the language tends to reflect the ethnic mindset as contained in the knowledge system.<sup>(3)</sup> This study uses an ethnoscience approach. The focus of attention is the principles of classification as expressed.<sup>(4)(5)</sup> This method is applied in an effort to find activities that apply to the Panaragan Javanese society in order to find patterns related to how to build a healthy home, ways before building healthy homes, patterns of form and architecture that reflect their world view and other empirical concepts that apply on the Javanese Panaragan society.

## Results and Discussion

**(a) The Concept of Ethnic Panaragan Inner Healthy Home:** To create an inner healthy atmosphere, in building a house, the Javanese Panaragan ethnic society first saw the place to be used which included the location and type of land. The location that is used is safe from various possible disaster threats, such as landslides and floods that can occur naturally. These considerations are chosen carefully, so that in the future there is no unwanted thing that can harm materially and immaterially. Although every human disaster does not want, alert is the main road. The calculation of the location is an important factor because many people experience material losses in the form of assets in the event of a natural disaster or immaterial in the form of psychological psychology such as traumatic, especially if left by a loved family

Experience the history of land by the Panaragan ethnic society as one of the important elements in building a home or buying a home. Therefore, you must first know the origin and history. In building a home, the Panaragan ethnic society after determining the location and history is free from the problems, then the next step is usually by holding calculate the day (pitungdino) with the use of the Javanese calendar. The person appointed is usually called pujonggo or a friend who is believed to be smart and has the accuracy in determining the

best day between good days or called the expression of linguistic nagadino.

After the process of determining the day is good, the next step is the process of surgical earth (ndudukris) in modern terms now known as the laying of the first stone by holding selamatan inviting relatives and tonggoteparo to run the hajadan and prayer together to make a circular formation in the place of the house to be built like a pager with the purpose of the home to be built is to avoid danger through prayer pagers in a circle sitting cross-legged in the middle of uborampe in the form of chicken, banana, jenangsengkolo, money and eggs. This concept then becomes a life guideline for some Javanese people in building a home that is very concerned about the harmony of inner and outer, because the house is used for a long period of the time, so keeping the house into a comfortable residence is a must even though in the form of a home that is not too luxurious, but it's more important to live happily and always bring blessings.

**b) The concept of Physic Panaragan Ethnic Healthy Home:** The home is a physical structure consisting of room, yard and surrounding area that is used as a place of residence and means of family formation.<sup>(6)</sup> While the understanding of houses according to WHO (World Health Organization) is a physical structure or building for shelter, where the environment is useful for physical and spiritual health and social conditions both for family and individual health.<sup>(7)</sup> The function of the house is as a place to let go of fatigue, socializing, fostering a sense of kinship between family members, sheltering and storing valuables, and as a symbol of social status.<sup>(8)</sup>

A healthy home is a physical structure of the building as a shelter or shelter and a place to rest so that it grows a perfect life both physically, spiritually and socially culture and free from illness or weakness (Disability). In general, the house is said to be healthy if it meets the following criteria.<sup>(7)</sup>

Physical aspects of the building for the Panaragan ethnic society have several elements of a standard healthy home. A healthy home must have several important components. Among other things are the components or structure of the house, sanitation and healthy behavior of the occupants, which are then elaborated in the form of more indicators, namely components, structure and condition of the ceiling, walls, floors, windows, bedrooms, living room windows, ventilation, holes

kitchen smoke, lighting, cages, and yard utilization. From these elements, above the construction structure of the shape and space of the Javanese Panaragan ethnic house is generally the same as the other traditional Javanese traditional houses.

According to Yunitathe main home is at least composed of three masses of this building, surrounded by a wide yard.<sup>(9)</sup> The yard consists of latarngarep, on the front, latarmburi, in the back and latarwetan and latarkulon on the side. Ngarep or front yard is an average of 10 m to 15 meters of roadside, serves to dry the harvest. The background (latarmburi) is large to occupy sumur, jedhingblandhong (bathroom), kakus (WC), and pawuhan (trash bins) tegalan and stables. side yard of the latarwetan is on the east side, while the latarkulon is on the west side, serves for moor or gardens and places blumbang or fish pond

**c. The Variety of Ornaments: Art of Architecture and symbolic meaning:** The shape of the roof of a traditional Javanese Panaragan ethnic home has an interesting variety of decoration and architecture from a certain point of view. The variety, among others, is found in the upper part of wuwungan in the Panaraganjoglo house. The position of wuwungan which has an angle and aesthetic value is a symbol of the service of the crown of the king. The ornament, sometimes resembling a tiger's ear, symbolizes the strength and dignity of a house.

The decorative model is in the form of decorations with various shapes and motifs. Soko is a foundation that serves to support the roof. Soko on the upper end usually has ornate carvings in the form of lists and carvings and at the bottom there is a umpaktampak that supports the mighty. This Soko is often in the belief of the ancients given a rope bond as a tight binding symbol of a single entity, if someone who comes then feels comfortable, like there is a brotherhood among guests who present with the home owner as a symbol of brotherly ties by visiting each other. Tumpangsari is an ornament as a form of aesthetic creation by placing tumpangsari towards the outer midhangan and overlapping towards the midhangan. According to Susilo The number of tumpangsari levels varies.<sup>(10)</sup> The number of levels is no provision, depending on the availability of materials. which means showing the level of ability of homeowners. The use of overlapping is not mandatory, but when using overlapping the number of levels must be odd, three levels or five levels or not at all.

The difference between tumpang and tumpangsari in addition to its position, as well as its structural aspects. Tumpangsari supports the roof, its function is related to the function of the other elements, so it cannot be replaced at any time. Tumpang functions only as a cover of the bottom roof cavity, do not support the structural system. Then tumpang can be replaced, added or reduced the level. Even carving decorations can also be given, of course the other elements of the carving must be adjusted.

**d. The Healthy Space: Expression of forms of air ventilation and lighting functions:** Ventilation is a process of circulating air that enters the room naturally. Air ventilation serves to keep oxygen levels intact and affect the level of humidity in a room. Inside the traditional Panaragan ethnic home there are usually two windows consisting of one window on the west side and one window on the east side. This ventilation, has a philosophy of air entering from one side can come out on the other side so that the air in the room will continue to experience change and freshness for the occupants in it. In addition this ventilation also functions as lighting in the morning and evening so that at that time there is no artificial lighting as it is now, the room will remain bright even though there are no lights because the sun in the morning and evening can enter the room. This concept indirectly has implications for the health of the residents of the house because in addition to maintaining the circulation of air freshness in helping breathing can also avoid moisture which can lead to susceptibility to disease seeds.<sup>(11)</sup> This simple concept influences the pattern of action in the expression of embodiment of a healthy home according to the Panaragan ethnic community. Therefore, usually on the side of the house there are *emperkiwo* and *empertengen*. *Emperkiwo* as the road to *pasucen* is a place to clean yourself or the bathroom and toilet. As for *empertengen* as the road to the *pawon* and storing agricultural products such as grain, *casava*, and corn

### Conclusion

The concept of a healthy home according to the Panaragan Javanese community is that there are two standards that become unity, namely the concept of inner health and outer health. The concept of inner health is reflected in the expression of language in determining the day before building a house by determining the best

day by performing a *petungandino* tradition at the time of the earth in the hope that the house to be built brings blessing. During this process, the Ponorogo society also held a salvation as a form of gratitude to God by holding a prayer together inviting the brothers, relatives and neighbors to join together to win the divine blessing of God. As for outwardly the concept of healthy ethnic panoramic house is reflected in the safe construction, ornamental variety as a form of symbolization that reflects hope and prayer, healthy space with adequate ventilation and lighting, clean floors, and sanitation facilities that are protected from pollution and landfills which is adequate as a form of behavior to maintain the health of its inhabitants. The concept that is actualized becomes an integral unity to realize a healthy home avoiding various kinds of hazards, and diseases that can be caused by lack of concern for health factors.

**Conflict of Interest:** No

**Ethical Clearance:** Yes

**Source of Funding:** Authors

### References

1. Sutarto A. *Studipemetaankebudayaan Jawa Timur studideskriptifpembagian 10 sub kebudayaan Jawa Timur* (The mapping study of the cultures in East Java: The descriptive study on the 10 sub-culture divisions in East Java). Jember: Program Studi-Antropologi, FisipUnej;2004.
2. Wistodiyono & Daldini. *IlmuIslamet (Merangkaimutiarafilasafat Jawa di era moderinisasi dan globalisasi)* (The knowledge of safety: The Javanese philosophy in the modernization and globalization era). Jakarta: PT Bhuana IlmuPopuler; 2010.
3. Fernandez IY. *Sakit dan sehatdalam pandangan orang Bantik dan Tonsawang: Studietnolingustik di Sulawesi Utara* (Sick and healthy in the perspective of Bantik and Tonsawang people: The ethno-linguistic study in North Sulawesi). Yogyakarta: Universitas Gadjah Mada; 1998.
4. Frake CO. Culture ecology and ethnography. *American Antropologist*. 1962;5(64):53-59.
5. Sturtevant WC. *Studies in ethnoscience*. In: Romhey AK and D'Antrate RGD. *Anthropologist: Social Publication*. 1964;67(5).
6. Mukono HJ. *Prinsipdasarkesehatanlingkungan* (The basic principles of environmental health). Surabaya: Airlangga University Press; 2000.

7. The Republic of Indonesia's Department of Health. Pedomanteknispenilaianrumahsehat (The technical assessment guide of the healthy home. Jakarta: The Republic of Indonesia's Department of Health; 2007.
8. Maru'fi I. Rumahadat Using: Pembacaandarisudut-pandangrumahsehat (Using customary home assessment from the perspective of a healthy home). Yogyakarta: Penerbit Ombak; 2016.
9. Yunita, et al. Perubahanruangberbasistradisirumah-JawaPanaragan di desa Kaponan (Room rearrangement based on the Panaragan Javanese home tradition in Kaponan village). *J Langkau Bentang*. 2017;4(1).
10. Susilo GA. Ragam Hias Joglo Ponorogo (Decorations of Ponorogo Houses). *Jurna ITesa Arsitektur*. 2014;12(1).
11. Sugianto A. Eksotikapariwisata Ponorogo (The exotics of Ponorogo tourism). Yogyakarta: Samudra Biru; 2015.

# Strengthen the Authoritative Function of the Regional Representative Councils in Legislation

I Gusti Bagus Suryawan

Lecturer at Warmadewa University, Indonesia

## Abstract

The existence of the Regional Representative Council (DPD) in the constitutional structure in Indonesia can strengthen the parliamentary system which in turn can strengthen democracy. The substance of regional representation in the DPD is the accommodation of regional interests which is guaranteed constitutionally and elaborated with laws and regulations. This study is to analyze the reconstruction of DPD's regulatory functions in the fields of legislation, supervision and consideration. The regulation of DPD functions in the field of legislation, supervision, must be reconstructed in the 1945 Constitution of the Republic of Indonesia with the formulation of "legislative and oversight power exercised by the DPR and DPD" which is to replace the regulation of the DPD function in the legislative field which is limited to filing bills and participating in discussions at level I, but do not have authority for the decision making stage. Also the DPD does not have a supervisory function, because the DPD cannot follow up on the results of supervision and the follow-up to the results of supervision is a political and legal determination by the DPR (House of Representatives).

**Keywords:** *Legal Reconstruction, Function, Regional Representative Council, Legislation.*

## Introduction

The existence of the Regional Representative Council (DPD) in the constitutional structure in Indonesia can strengthen the parliamentary system which in turn can strengthen democracy. The constitutional basis of the DPD's power is regulated in Article 22 D of the 1945 Constitution of the Republic of Indonesia. The constitutional foundation as the basis for the formation of the DPD can be found in Article 22 C and Article 22 of the 1945 Constitution of the Republic of Indonesia. The authority of the DPD as regulated in the provisions of Article 22 D paragraph (1) and paragraph (1) 2) The 1945 Constitution of the Republic of Indonesia regulates that the DPD can submit to the House of Representatives a draft law relating to regional autonomy, central and regional relations, the formation and expansion and merging of regions, management of natural resources

and other economic resources, as well as those relating to central and regional financial balance. In addition, the DPD also discussed the draft law relating to regional autonomy; central and regional relations; formation, expansion, and merging of regions; management of natural resources and other economic resources, as well as central and regional financial balance; and giving consideration to the House of Representatives on the draft budget law for state income and expenditure and the draft law relating to tax, education and religion.

As a translation of Article 22 C and Article 22 D of the 1945 Constitution relating to the DPD, is regulated in Law Number 27 of 2009 as last amended through Law Number 17 of 2014 concerning the People's Consultative Assembly, the People's Representative Council, the Regional Representative Council and the Regional House of Representatives (hereinafter abbreviated as MD3 Law). The substance of regional representation in the DPD is the accommodation of regional interests which is guaranteed constitutionally and elaborated with laws and regulations. Legislation as a legal product is the basis for making state administrative decisions; be the basis for the formation of legislation; become the basis of legal relations between citizens and the

---

### Corresponding Author:

I Gusti Bagus Suryawan

Jl. Terompong No.24, SumertaKelod, Denpasar Tim.,  
Denpasar, Bali 80239

e-mail: [igbsuryawan.warmadewa@gmail.com](mailto:igbsuryawan.warmadewa@gmail.com)

resolution of social problems. In this context, legislation as a legal product becomes a very important tool in the administration of state life.<sup>1</sup>

Even though the DPD was born, it was not yet fully present.<sup>2</sup> Meaning, DPD can be considered between 'there' and 'none'. The DPD is 'there' because of its relatively strong legitimacy and its members are elected directly through the multi-district district election system. The DPD is also 'absent', because the strength of the legitimacy of the election results does not go hand in hand with its relatively minimal authority, especially when compared to the authority of the DPR. This study formulates a problem that will become a central point regarding the reconstruction of the DPD's regulatory functions in the fields of legislation.

### Research Method

This type of research is sociological normative legal research that examines and examines statutory provisions relating to the function and authority of the DPD. The study includes 3 layers of legal science namely legal philosophy (right philosophy), legal theory (right theory) and legal dogmatics (right dogmatics). This study uses several approaches, namely the historical approach (historical approach), conceptual approach (conceptual approach), statutory approach, comparative approach, and sociological approach.

**Position of the Regional Representative Council in the Constitution and State Administration:** The existence of the DPD is expected to strengthen the parliamentary system which in turn can strengthen democracy. The constitutional basis of the DPD's power is regulated in Article 22 D of the 1945 Constitution of the Republic of Indonesia. Furthermore, the function and authority of the DPD is regulated in the MD3 Law and P3 Law. According to MD3 Law, the DPD can submit a bill proposal to the DPR. If a bill is approved or approved with amendments, the bill will become a bill proposed by the DPR. Furthermore, the DPD proposal bill which has been adopted as the DPR proposal bill, the DPR leadership will ask the DPD leadership to appoint a tool that will discuss the bill in the DPR. Discussions on a bill in the DPR are conducted in two stages of discussion. First-level talks are held in commission meetings, joint commission meetings, Baleg meetings, Banggar meetings, or special committee meetings. Meanwhile, the second level talks were held in a plenary meeting which was a forum for decision making. Of the

two levels of discussion, the DPD RI can only take part in the level I discussion. It is also only done in the form of a mini-opinion submission delivered at the end of the level-1 discussion. The illegality of the first level of discussion so that the discussion of a bill can continue at the second level.

Based on the results of interviews with Syamsul Bachrie (Monday August 15 2016) related to the absence of DPD's participation in decision making in the sense of participating in a joint agreement between the DPR and the President after the Constitutional Court's Decision, it will cause the law to be legally flawed. That the judicial law is flawed when the DPD does not participate in the decision making process of a bill under discussion.

In the legislation process, this imbalance is increasingly seen in Law P3 and MD3 Law. Article 20 paragraph (1) of Law P3 regulates: "Preparation of National Legislation Program shall be carried out by the DPR and the Government". The norm of Article 20 paragraph (1) is not in line with the purpose of Article 22 D of the 1945 Constitution of the Republic of Indonesia that "the DPD can submit to the DPR a draft law relating to regional autonomy". Likewise the provisions of Article 20 Paragraph (3) of Law P3 "Preparation of Prolegnas within the DPR as referred to in paragraph (2) is carried out by considering proposals from factions, commissions, members of the DPR, DPD, and/or the public.

This arrangement seems to indicate that the function of the DPD to submit a bill is distorted as if it were the authority of the factions and commissions as the DPR's completeness instruments. The DPD is only authorized to propose a bill to be submitted to the DPR, then the proposal for the DPD bill will depend on the DPR's follow-up actions in the parliament. In other words, the DPD is a sub-ordinate of the DPR or only a supplementary organ of the DPR in the two-chamber parliamentary system.

The regulation of DPD functions in Law P3 as explained above, is not in accordance with the principle of rating norms. Law as a translation of norms in the Constitution, regulates norms that are not in accordance with what is ordered by the Constitution. Which is why the DPD does not carry out its constitutionality function optimally. Likewise, looking at the provisions of Article 65 paragraph (3) of Law P3, the participation of the DPD in the discussion of the Draft Bill is carried out only at

the level 1 discussion. Article 150 paragraph (3) of the MD3 Law also excludes the DPD from being involved in the DIM discussion as the DPR and the Government, whereas the submission and discussion DIM is precisely the core of the discussion of the bill and determine the legal politics of a bill.

Kelsen's teachings describe the process of forming a system that originates from a set of norms, including the inclusion of a norm into a particular system so that the construction of Kelsen's teachings also explains the validity of a norm. The existence of a norm is formed as a result of the formation of a norm is to regulate the procedure for someone's behavior towards other people or the environment. A norm applies because it has conductability or because it has validity (validity/geltrung).

Basic principles for understanding thinking if there are more than one person in the same space and time. Because the legal validity of Hans Kelsen who must especially understand the keywords against the validity of norms according to him; "The reason for the validity of a norm is always a norm, not a fact".<sup>3</sup> Here Kelsen has given a basic principle regarding the norm's sequence. A norm cannot be based on a factual event because a norm can only be pursued with fellow norms to its basic norms where there are no norms forming on it. As continued on the second basic principle; "a norm of validity of which cannot be derived from a superior norm we call a" basic "norm" (norms whose validity cannot be obtained from other higher norms, we refer to as "basic norms"). Kelsen absolutely states that norms must be tested with norms, norm hierarchies if pulled up until no more norms are found so the last norm is referred to as the basic norm.

Gaffar (2004) stated that the formation of the DPD is inseparable from two things. First, there is a demand for democratization to fill members of representative institutions so that they always include the voters.<sup>4</sup> There was a demand that the representation system be a two-room system. The DPD and the House of Representatives are described similarly to the representative system as in the United States which consists of the Senate as the state representative (DPD), and the House of Represents as the representative of the whole people (the DPR). In the United States, these two elements of representation are called the Congress. Article 1 paragraph (1) of the United States Constitution of 1787 states: All legislative powers here in granted shall be vested in a Congress of the United States, which shall consist of a Senate and

House of Representatives.<sup>5</sup>

One consequence of the idea of the two chambers is that names are needed for the representative body that reflects these two elements of representation. In the Netherlands the representative body is the Staten Generaal which consists of de Eerste Kamer (representative from the region) and de Tweede Kamer (representative of all the people). In Britain, the Parliamentary representative body consisting of the House of Lords (representative of the group) and the House of Commons (representative of the whole people).

The name of a two-room representative body in Indonesia in accordance with the above construction, was named MPR. As a consequence of the use of the MPR as the name of the two-room system, the MPR should not be an office environment that has its own authority environment. The authority of the MPR is inherent in the authority of the DPR and DPD. In the United States Constitution which is determined is the authority of the Congress and its implementation is carried out by its representative chambers.

The function of parliament is as representative and deliberative assemblies. Parliament in a modern state not only represents the will of the people, but is also a deliberate place, especially in the field of legislation to oversee regional interests in government administration and government policy. Legislative power is power that reflects the sovereignty of the people, to regulate life together. There are three important things that must be regulated by the people's representatives through parliament, namely arrangements that can reduce the rights and freedoms of citizens, which can burden the assets of citizens; and regarding expenses by state administrators.

**Authoritative Function of the Regional Representative Council in Legislation:** There are 4 forms of legislative function activities in the formation of laws, namely law making initiatives, discussion of bills, approval of the ratification of bills and granting approval of binding or ratification of international treaties or agreements and other binding legal documents.

In the formation of laws based on the 1945 Constitution of the Republic of Indonesia, the House of Representatives participates in all stages of the implementation of the legislative function, whereas the DPD is only entitled to propose, participate in discussion, and also give consideration to certain bills.

Because it is not complete in following the four forms of activity, it can be interpreted that the DPD does not have a legislative function.

Every legislator is obliged to understand the applicable laws and regulations. Proper mastery of statutory law will contribute highly relevant to the law-making profession.<sup>6</sup> Inaccuracy in mastering the applicable laws and regulations can be a cause of flawed legal rules that are formed both formally and materially. In addition, it is known that legislation has a very strategic function for the administration of the state. There are two functions of legislation, namely the protection function and the restriction function.<sup>7</sup> The function of protection is the function of legislation to provide guarantees for the protection of the relationship of rights and obligations in a shared life. In addition, legislation also plays a role to limit the use of rights and obligations themselves so as not to harm the rights of others.<sup>8</sup>

A very strategic part in the stages of drafting legislation is to fill in the formulation of legislation with the choice of norms or guidelines for appropriate and proportional behavior. The drafting of the legislation must be able to distinguish the notion of rules from norms. Bruggink gives a firmer term, the rules and rules of law.<sup>9</sup> It shows that the regulation of the functions of the DPD in the 1945 Constitution of the Republic of Indonesia with the MD3 Law and P3 Law shows the asynchronous norm. This has implications for the accommodation of regional interests through the field of legislation that cannot be fought for optimally.<sup>10</sup>

### Conclusion

The regulation of DPD functions in the field of legislation, supervision, must be reconstructed in the 1945 Constitution of the Republic of Indonesia with the formulation of “legislative and oversight power exercised by the DPR and DPD” which is to replace the regulation of the DPD function in the legislative field which is limited to filing bills and participating in discussions at level I, but do not have authority for the decision making stage. Also the DPD does not have a supervisory function, because the DPD cannot follow up on the results of supervision and the follow-up to the results of supervision is a political and legal

determination by the DPR.

**Ethical Clearance:** This research was ethically approved by Faculty of Law, Warmadewa University, Indonesia

**Funding:** This research receives no external funding.

**Conflict of Interests:** There are no conflict of interests

### References

1. Ruslan A. Peraturan Perundang-Undangan Sebagai Sarana Hukum Penyelenggaraan Negara. Universitas Hasanuddin; 2011.
2. Indrayana D. Negara antara ada dan tiada: reformasi hukum ketatanegaraan. Penerbit Buku Kompas; 2008.
3. Kelsen H. General theory of law and state. The Lawbook Exchange; 1999.
4. Gaffar JM. Kedudukan, Fungsi dan Peran Mahkamah Konstitusidalam Sistem Ketatanegaraan Republik Indonesia. Jurnal Mahkamah Konstitusi, Jakarta. 2009 Oct.
5. Manan B. Dpr, Dpd, Dan Mpr Dalam Uud 1945 Baru. FH-Uii Press; 2003.
6. Limahelu, F. Law: professional, leadership, based upon skill and value. Surabaya: Unair; 2000.
7. Burkens MC, Kummeling HR, Vermeulen BP, Widdershoven RJ. Beginselen van de democratischerechtsstaat. Tjeenk Willink, Zwolle. 1990.
8. Hadjon PM. Fungsi Normatif Hukum Administrasidalam Mewujudkan Pemerintahan yang Bersih. Pidatodalam Peresmian Penerimaan Guru Besar dalam Ilmu Hukum pada Fakultas Hukum Universitas Airlangga, Surabaya. 1994 Oct;10.
9. Bruggink JJ. Reflections on the Law. Arief translation Sidhartha, Citra Aditya, Bandung. 1999.
10. Ulum MB. How Democracy is Election? Reassessing Article 18 (4) of the 1945 Constitution and its Implication to the Regional Head Election in Indonesia. Jurnal Hukum dan Peradilan. 2019 Aug 5;8(2):315-32.



# Knowledge, Attitude and Quality of Life among Type 2 Diabetic Patients in Palestine

Imad Thultheen<sup>1</sup>, Ayman M. Hamdan Mansour<sup>2</sup>, Ward Zandeeq<sup>3</sup>,  
Maysam Ewesat<sup>3</sup>, Saleem Razek<sup>3</sup>, Diana Jabareen<sup>3</sup>

<sup>1</sup>RN, MSN, PhD. Assistant Professor, Clinical Nursing. Faculty of Medicine and Health Sciences, Department of Nursing An-Najah National University, Nablus, Palestine, <sup>2</sup>PhD. Professor, School of Nursing, the University of Jordan. Amman-Jordan, <sup>3</sup>RN, BSN. Research Assistant, An-Najah National University, Nablus, Palestine

## Abstract

The purpose of this study is to investigate the association between knowledge and attitude on quality of life among diabetic patients type 2 in Palestine.

**Method:** A cross-sectional quantitative descriptive study that contains a sample of 120 diabetic patients were selected from Nablus hospitals and outpatient clinics to assess the level of knowledge and attitudes toward self-care and health-related quality of life.

**Results:** The mean score of Michigan Diabetic Knowledge Test was  $8.04 \pm 2.48$  and this consider a moderate level. Of 120 diabetic patients, 27.5% had poor knowledge; 65.5% had moderate knowledge, and only 6.6 % had good knowledge. The mean for attitude score of all respondents was  $125.4 \pm 10.57$  and this consider a positive attitude. There was a significant positive association between knowledge, attitude with HRQoL ( $P=0.00$ ). The mean for HRQoL score was 0.72 and it represented a moderate level of quality of life. Conclusion: Level of knowledge scores and HRQoL were moderate and attitude toward the disease was positive in type 2 diabetic patients in Palestine, and there was a strong association between knowledge, attitude on HRQoL.

**Keywords:** Type 2 diabetes mellitus, knowledge, attitudes, health-related quality of life.

## Introduction

Diabetes mellitus (DM) is a common chronic disease of global epidemic proportions and considered as a metabolic disorder that may be caused by disturbances of the body essential ingredients such as carbohydrate, fats, proteins metabolism that result from a defect of insulin secretion, its function or both<sup>[1-2]</sup>. The World Health Organization reported that the prevalence of diabetes was

171 million; this number is predicted to reach 300 million by 2030<sup>[1]</sup>. Findings. Nowadays International Diabetes Federation offers that each year 5,000,000 deaths are because of diabetes, which is more than the HIV/AIDS, tuberculosis, and malaria combined<sup>[3-4]</sup>. Knowledge and attitudes toward DM is the first step to be taken to formulate prevention programs for diabetes patients<sup>[5]</sup>, and the impact of education among diabetic patients will be more beneficial and more effective<sup>[6]</sup>. Health-related quality of life (HRQoL) has also been recognized as an essential health outcome, it is represented as the ultimate goal among various health outcomes. It is characterized as patient-perceived physical, emotional, and social well-being<sup>[7]</sup>. Understanding the factors that associated with poor quality of life (QOL) has a benefit in terms of promoting the physical and psychosocial burden associated with DM, eventually minimize costs, morbidity, and mortality<sup>[8]</sup>.

---

### Correspondence Author:

**Imad N. Thultheen RN, MSN, PhD**

Assistant Professor, Clinical Nursing. Faculty of Medicine and Health Sciences, Department of Nursing An-Najah National University, Nablus, Palestine  
e-mail: imad.t@najah.edu  
Tel: 00972592708853

Knowledge and HRQoL alone is not enough for diabetic patients to affect changes in their lifestyle, the attitude is influencing factor that affected in the relationship between knowledge and lifestyle changes. However, there are limited studies in worldwide and no studies in Palestine discussing knowledge among diabetic patients and the effects of diabetic patients' knowledge and attitudes on HRQoL. So, in this study aimed to assess present knowledge, attitudes, and quality of life among diabetic patients type 2 in Palestine.

## Materials and Method

**Design:** A cross-sectional quantitative descriptive design was used to identify relationship between the knowledge and attitude on quality of life among diabetic patients type 2 in Palestine, using structured interview with 120 diabetics 2 patients.

**Settings:** Sample recruited from, hospitals and outpatients' units of Nablus, Palestine.

**Sample and Population:** a sample of 120 Patients aged 18 years and above, with a confirmed diagnosis of DM-II and willing to participate were included in this study. While patients who were pregnant, documented psychological problems, mental illness and who have diabetic complications renal failure, retinopathy, and diabetic foot were excluded.

**Data collection Procedures:** Data collection started after ensuring ethical approval from the Institutional Review Board (IRB) Committee of the College of Medicine, An- Najah University. Arabic versions of the tools were used adopting the WHO guideline in translation.

**Instrumentation:** The data collected using the following instruments

1. Demographic data that include gender, age, marital status, type of treatment, HbA1C, and duration of the disease.
2. Michigan diabetic knowledge test (MDKT) to assess level of knowledge, it consists of 14 multiple-choice items. Each one of the patients was asked to choose only one answer for each question, the correct answer scored one point, and the false answer scored zero. The range of the knowledge test was from 0 to 14 where the higher score of the test, the higher level

of knowledge about diabetes and the zero represents the low level of knowledge about diabetes. The score of <7 considered as poor knowledge, 7-11 considered moderate knowledge about the disease, 12-14 considered to be a good score for knowledge.

1. Diabetic self-care profile was used from the University of Michigan. It used to assess the attitude of diabetic patients, the questionnaire contains from 33 questions. All items were scored: strongly disagree, disagree, neutral agree, agree, and strongly agree. The range of score from 33 to 165 the higher the score the positive the attitude toward diabetes care. This scale divided to 5 subscales: Need for special training to provide diabetes care, Seriousness of type 2 diabetes, Value of tight glucose control, Psychosocial impact of diabetes and attitude toward patient autonomy.
2. EuroQol five-dimensional (EQ-5D) to assess HRQOL, it consists from two parts. The first part talks about self-reporting their health status, it talks about 5 dimensions: mobility, self care, usual activities, pain/discomfort, anxiety/depression, Each dimension contains from five levels of severity, (no problems, slight problems, moderate problems, severe problems, unable problems). The range of the each dimension was formed from 1 to 5, where the five is the highest score of the item known as the highest level of quality of life and the 1 represents the low level of quality of life. The second part that was conducted contain a visual analog scale (VAS), with endpoint were 0 represent bad health status and 100 represent excellent health status, that was conducted to assess and record each of the subjects about their perception on her or his quality of life.

## Findings:

**Demographic Characteristics:** 140 patients approached and 120 questionnaires completed, with response rate of 85%. the mean age (SD) was (57.83± 12.69) years; Mean HbA1c was (8.41±1.55) and the mean duration of diabetes was (10.24± 8.28) years, 52.5% were female, 65.8% (n = 79) of the participants were married. About 60.8% (n =73) had average income, About 36.7% (n = 44) had a High school level of education.

**Table 1: Characteristic of the patients (N = 120)**

Variable	Frequency	Percentages
<b>Gender</b>		
Male	57	47.5%
Female	63	52.5%
<b>Marital status</b>		
Married	79	65.8%
Single	11	9.2%
Divorce	9	7.5%
Separated	3	2.5%
Widowed	18	15%
<b>Economic status</b>		
Low income	39	32.5%
Moderate income	73	60.8%
High income	8	6.7%
<b>Educational level</b>		
Elementary	41	34.2%
High school	44	36.7%
Diploma	7	5.8%
Bachelor	17	14.2%
Master	2	1.7%
Another thing " illiterate"	9	7.5%
<b>Are you under diabetic treatment?</b>		
Yes	118	98.3%
No	2	1.7%
<b>Type of treatment</b>		
Medication/insulin	69	57.5%
Diet	4	3.3%
Insulin+diet	47	39.2%
<b>How much the last HbA1c</b>		
<7"acceptable"	53	44.2%
7-8"good"	16	13.3%
> 8"poor"	51	42.5%
<b>Duration of diabetes years 5 years or less</b>		
5-10	42	35%
11-15	42	35%
16-20	14	11.7%
More than 20	9	7.5%
	13	10.8%

**Knowledge of DM:** The mean score of the MDKT was (8.04±2.48), indicating that, the patients had a moderate level of knowledge about diabetes, good knowledge was most apparent in response to the questions related to the problems that usually not associated with diabetes (80.8% were correct) and the effect of exercise on blood glucose (80.8% were correct), Poor knowledge was most apparent in response to the questions related

to food that should not be used when blood glucose was low(68.3% were incorrect). Questions regarding the effect of unsweetened fruit juice on blood sugar (62.5% were incorrect), which foods contained the fattest also tended to be answered incorrectly (60% were incorrect).

**Differences in knowledge and attitude related to socio-demographic characteristics:** According to knowledge among female and male patients, it wasn't significant (p=0.5) also the attitude score wasn't significant (p=0.081), The age wasn't significant for both attitude (p=0.11) and knowledge score (p=0.081), According to marital status, it was only significant for the knowledge score (p=0.005), divorced females slightly more knowledgeable toward DM (8.44±2.4), according to attitude score it wasn't significant. According to economic status, it was significant both for knowledge (p=0.007) and attitude score (p=0.001), patients who had moderate-income has better knowledge(8.54±2.39) and better attitude (128±9.5). According to the education level it was significant for the knowledge score (p=0.01) the patient who has a master's degree is more knowledgeable about DM for the score of(11±0.00). But the attitude score wasn't significant, for those who receive a different type of treatment, it show only significance for attitude score (p=0.014), and the highest score was for those who receive diet treatment (126.2±11.6), the knowledge score wasn't significant (p=0.107). According to the result of the last HbA1c, it was significant for the knowledge score p= (0.028) and attitude score (p=0.02) the highest result was for a patient with HbA1c 7-8(128+-8.40), According to the duration of DM it was significant for the attitude score with (p=0.02), those who have DM between 6-10 years, have a better attitude(129.9±7.5) but it wasn't significant for knowledge score.

**Differences in wellness scale related to socio-demographic characteristics:** According to gender, there was no significance for the wellness score (EQ-VAS) (p=0.88) and the (EQ-5D)(p=0.8). The marital status showed that there was significance in QoL, single Patients had higher scores than married (20±5.6 vs. 19.7±5.8) for (EQ-5D). According to the economic status, it shows significance for both EQ-VAS (P=0.000) and EQ-5D (p=0.00), the patient who has moderate income present the highest score for wellness (75.44±17.6) for EQ-VAS. The education level shows significance for the EQ-VAS (p=0.000) and EQ-5D (p=0.000), for those patients who have a master and bachelor's degree, they have the highest QOL (24±1) for (EQ-5D). According to

the duration time of DM, it show significant for the EQ-VAS ( $p=0.012$ ) and the EQ-5D( $p=0.006$ ), for those who had DM duration of 5 years or less, show the highest wellness score ( $73\pm 22.4$ ) for(EQ-VAS). For 5-

### Discussion

In this study the mean score of knowledge was ( $8.04\pm 2.48$ ), while using the Michigan diabetic knowledge test (MDKT), that was an indication of moderate knowledge. The results are is consisted with previous report<sup>[1, 11-15]</sup>. Also, 60% of the patients were incorrect regarding the food that contain most fat and this consist with indicating that patients with DM-II had poor knowledge about the effect of unsweetened fruit juice on blood sugar and the food that contain most fat. In this study, we found that there is a relationship between educational level and knowledge score in which those participants with master degree got the highest score( $11\pm 00$ ) and this consist with these studies<sup>[16-20]</sup>. It is obvious from previous studies that type 2 diabetic patients have lower scores of HRQoL than rest of populations of similar age. In this study, the mean of EQ-5D score in type 2 diabetic patients was 0.72, which is considered a moderate score, and this consistent with other studies that reported mean EQ-5D scores as 0.74, 0.69, 0.70, 0.71 and 0.70<sup>[21-23]</sup>.

### Conclusion

In this study, level of knowledge was a moderate, attitude was positive, and the level of HRQOL was also moderate level. Patients who receive diet management had high attitude score, high score of knowledge and attitude reported in 7-8 HbA1c. It is recommended to conduct a longitudinal study that address consequences of poor knowledge and low quality of life.

**Conflict of Interest:** The authors declare no conflict of interest related to publication of this article.

**Financial Disclosure:** There is no financial disclosure.

**Ethical Clearance:** the study has been approved by the ethics and research committee at An-Najah National University

### References

1. Al-Aboudi, I.S., M.A. Hassali, and A.A. Shafie, Knowledge, attitudes, and quality of life of type 2 diabetes patients in Riyadh, Saudi Arabia. *Journal of pharmacy & bioallied sciences*, 2016. 8(3): p. 195.
2. Adepoju, O.E., The triad of diabetes, hospitalization and work-productivity losses. 2013, The Texas A & M University System Health Science Center.
3. Abu-Rmeileh, N.M., et al., Forecasting prevalence of type 2 diabetes mellitus in Palestinians to 2030: validation of a predictive model. *The Lancet*, 2012. 380: p. S21.
4. Guariguata, L., et al., Global estimates of diabetes prevalence for 2013 and projections for 2035. *Diabetes research and clinical practice*, 2014. 103(2): p. 137-149.
5. Hamdan-Mansour A, Marmash L, Elayyan R, Hyarat S. Difference in perception between nurses and patients related to patients' health locus of control. *Int J NursPract* 2014; 20: 242-249.
6. Ansari, T., et al., Assessment of knowledge, attitude, and practice of dietary pattern in patients with type 2 diabetes mellitus: a locality-based perspective study. *International Journal of Medicine in Developing Countries*, 2019. 3(7): p. 581-585.
7. Rubin, R.R. and M. Peyrot, Quality of life and diabetes. *Diabetes/metabolism research and reviews*, 1999. 15(3): p. 205-218.
8. Saleem, F., M.A. Hassali, and A.A. Shafie, A cross-sectional assessment of health-related quality of life (HRQoL) among hypertensive patients in Pakistan. *Health Expectations*, 2014. 17(3): p. 388-395.
9. Rwegerera, G.M., et al., Health-related quality of life and associated factors among patients with diabetes mellitus in Botswana. *Alexandria journal of medicine*, 2018. 54(2): p. 111-118.
10. Hamdan-Mansour A. Sociodemographic correlates of somatic symptoms of older persons in Jordan. *Jordan Med J* 2017; 51 (3): 119-130.
11. Hamdan-Mansour AM, Al Abeiat DD, Alzohaibi IN, Ghannam BM, Hanouneh S I. Psychosocial and sociodemographic correlates of life satisfaction among patients diagnosed with cancer in Jordan. *J Cancer Edu* 2015; 30(1): 31-36.
12. Darawad MW, Hammad S, Mosleh S, Samarkandi OA, Hamdan-Mansour A, Khalil AA, Arabiat D. Psychosocial correlates of diabetes self-management practices. *Iran J Public Health* 2017; 46(6): 771.
13. Al Khatib A, Hamdan-Mansour A, BaniHani M.

- Theoretical perspectives of hospitalized older patients and their health-related problems and quality of care: systematic literature review. *The Open Public Health Journal* 2017; 10: 215-225.
14. Khatib A, Hamdan- Mansour A, Ratrou H, Alenezi A, Chahien T. Testing the effectiveness of integrated elderly care model on quality of care and health outcomes among hospitalized elderlies in West Bank. *Malaysia Journal of Public Health Medicine* 2020; 20(1): 82-89.
  15. Mahadeen A, Hamdan-Mansour A, Halabi J, Habashneh S, Bani Kenanah A. Psychosocial wellbeing of infertile couples in Jordan. *East Mediterr Health J.* 2018; 4(2):169-176.
  16. Mufunda, E., et al., Level and determinants of diabetes knowledge in patients with diabetes in Zimbabwe: a cross-sectional study. *The Pan African Medical Journal*, 2012.
  17. Dreidi H, Hamdan-Mansour A. Pain, Sleep Disturbance, and Quality of Life Among Palestinian Patients Diagnosed with Cancer. *J Cancer Edu* 2016; 31 (4): 796–803.
  18. Zowgar, A.M., M.I. Siddiqui, and K.M. Alattas, Level of diabetes knowledge among adult patients with diabetes using diabetes knowledge test. *Saudi medical journal*, 2018. 39(2): p. 161.
  19. Hamdan-Mansour AM, Dardas LA, Nawafleh H, Abu-Asba MH. Psychosocial predictors of anger among university students. *Children and Youth Services Review.* 2012 Feb 1;34(2):474-9.
  20. Ghannam B, Hamdan-Mansour A, Al Abaiat D. Psychosocial predictors of burden among caregivers of patients with serious mental illness in Jordan. *Perspectives in Psychiatric Care.* 2017;53(4):299-306.
  21. Hamdan-Mansour AM, Constantino RE, Farrell M, Doswell W, Gallagher ME, Safadi R, Shishani KR, Banimustafa R. Evaluating the mental health of Jordanian women in relationships with intimate partner abuse. *Issues in Mental Health Nursing.* 2011 Sep 23;32(10):614-23.
  22. Hamdan-Mansour A, Shehadeh J, Puskar K, El-Hneiti M, M Haourani E. Investigating physical, psychological and social well-being of older persons in Jordan. *Current Aging Science.* 2017 Aug 1;10(3):217-23.
  23. Hamdan-Mansour A, Nawafleh D, Hanouneh S, Al Omari H. Psychosocial aspects of patients diagnosed with Diabetes mellitus type-II in Jordan. *International Journal of Diabetes in the Developing Countries.* 2015; 36:65-9.

# Education as Predictor of Low Birth Weight among Female Worker in Indonesia

Ina Kusrini<sup>1</sup>, Noviati Fuada<sup>1</sup>, Sri Supadmi<sup>1</sup>, Agung Dwi Laksono<sup>2</sup>

<sup>1</sup>Researcher, Unit of Health Research and Development Magelang, Indonesia Ministry of Health, Central Java, Indonesia, <sup>2</sup>Researcher, Center of Research and Development of Humanities and Health Management, Indonesia Ministry of Health, Jakarta, Indonesia

## Abstract

Female workers are a vulnerable group in Indonesia because in addition to working to help their husbands earn a living, they also still have to be responsible for domestic affairs. This study aimed to analyze the effect of the level of education on the incidence of LBW in female workers in Indonesia. The analysis uses the 2017 Indonesian Demographic and Health Survey data. Stratification and multistage random sampling method get 18,061 female workers as respondents. The final stage was done using binary logistic regression. The results found that there was no difference between primary education female workers and no education female workers at the risk of giving birth to LBW babies. Secondary education female workers have a 0.561 times chance compared to no education female workers to give birth to LBW babies. Meanwhile, higher education female workers have a possibility of 0.414 times compared to no education female workers to give birth to LBW babies. Apart from the education level, the results of the analysis also found two other variables as predictors of LBW among female workers, namely wealth status and ANC visits. It was concluded that the education level is a predictor of LBW among female workers in Indonesia. The higher the education level, the lower the possibility of female workers to have LBW babies in Indonesia.

**Keywords:** *Low birth weight, female worker, education, maternal health, nutrition.*

## Introduction

Female workers are a group that is prone to various health-related risks<sup>1</sup>. In addition to exposure in the workplace, women who are also of childbearing age need optimal health conditions because it is a key element of intergenerational health<sup>2,3</sup>. Adequacy of nutrition for women, whether they are still in the status of young women, pre-pregnant adults, and even more so during pregnancy, are factors that directly contribute to the nutritional status of the children they will be born with<sup>4</sup>. A study conducted in several developing countries

states that three socio-economic factors can explain the problem of child malnutrition, namely women's social status, sanitation, and urbanization. The positive influence of children's nutritional status is related to the role of women in decision-making and gender equality in society, in addition to caring for children and providing nutrition directly from mother to fetus<sup>5</sup>.

For this reason, the health of female workers is an important factor in achieving the goals of global health development. Globally, the female labor force participation rate is quite high (% of female population ages 15+), in 2019 it is estimated at 47.14%. Meanwhile in Indonesia, the percentage of female workers is greater, namely 53% in 2019 it is estimated at 47.14%. Meanwhile in Indonesia, the percentage of female workers is greater, namely 53%<sup>6</sup>. This means that most women in Indonesia are female workers, both in the formal and informal sectors. In general, women workers work in three sectors, namely education, health, and

---

### Corresponding Author:

#### Agung Dwi Laksono

Researcher, Center of Research and Development of Humanities and Health Management, Indonesia Ministry of Health, Jakarta, Indonesia  
e-mail: agung.dwi.laksono-2016@fkm.unair.ac.id

social workers<sup>7</sup>. The average profile of housewives in Indonesia is also a worker, although not as the main support for family economic activities. They work in agriculture, services, and trade with the status of helping their husbands or families.

Among the risk factors for women in the workplace were revealed by previous studies. A high workload and a lower wage than men are experienced by female workers on average. On average, women dedicate 3.2 times more working hours per day than men to unpaid work<sup>8</sup>. The International Labor Organization states that 76.2% of women do unpaid care work. Besides, exposure to environmental hazards, stress, and nutritional insufficiency. Various risks experienced by women have an impact on public health if they cannot be controlled optimally<sup>7</sup>. Previous studies revealed that 81% of children to working mothers have a higher risk of neonatal death when compared to children born to non-working mothers<sup>9</sup>. Female workers who experience malnutrition are at risk of producing malnourished babies. One of the indicators of malnutrition is the low birth weight (LBW), a previous study stated the relationship between female workers and the occurrence of LBW<sup>10,11</sup>.

LBW is currently the main cause of child mortality and mortality. Every year nearly 1.1 million babies die from complications of preterm birth. LBW is not only a major predictor of prenatal mortality and morbidity but also increases the risk of slower cognitive development, non-communicable diseases such as diabetes and cardiovascular disease later in life<sup>7</sup>. Several studies suggest that LBW is associated with poverty and education indicators<sup>12,13</sup>. LBW had the consequence that they had to spend the first few days or weeks of life in the NICU. This is to ensure the baby's life is guaranteed with an artificial uterus. The risks of complications that can be suffered by LBW babies are the health consequences of LBW infants, thermoregulation, hypoglycemia, fluid and electrolyte imbalance, nutrition, hyperbilirubinemia, chronic lung disease, patent ductus arteritis, infections, necrotizing enterocolitis, intraventricular hemorrhage, apnea of prematurity, anemia, hearing and adult health problems<sup>14</sup>. Based on the background description, this study aims to analyze the effect of the level of education on the incidence of LBW in female workers in Indonesia.

## Materials and Method

This research was employed with secondary data

from the 2017 Indonesian Demographic Data Survey (IDHS). The analysis unit was female workers aged 15-49 years old who had given birth in the last 5 years. The 2017 IDHS sampling method was done by stratification and multistage random sampling so that there were 18,061 female workers as respondents.

LBW is a birth weight of fewer than 2,500 grams (or 5.5 pounds). LBW is determined regardless of gestational age. Birth weight is the first birth weight of a newborn measured after birth<sup>15</sup>. The education level is the last certificate the respondent has. Other independent variables analyzed in this study were age group, marital status, wealth status, ANC visits, and smoking behavior.

The final stage for determining the education level as a predictor of LBW was done using binary logistic regression because of the nature of the dependent variable. All statistical analyzes were carried out using SPSS 22 software.

## Results and Discussion

Table 1 shows descriptive statistics of the education level of female workers in Indonesia. It can be seen that all categories of education level are dominated by female workers who give birth to LBW babies, except for female workers who have higher education. Based on the age group, all education level categories were dominated by the 35-39 age group, except for female workers who had higher education, which was dominated by the 30-34 age group.

Based on marital status, all education level categories are dominated by female workers who are married/living with partners. Meanwhile, based on wealth status, all categories of education level were dominated by the poorest female workers, except for female workers who had higher education, which was dominated by the richest. Based on the ANC visits, all education level categories were dominated by female workers who made complete ANC visits ( $\geq 4$  times) during pregnancy. Finally, based on smoking behavior, all education level categories are dominated by female worker smokers.

Table 2 shows the results of the binary logistic regression of LBW among female workers in Indonesia. It was found that there was no difference between primary education female workers and no education female workers at the risk of giving birth to LBW babies. Secondary education female workers are 0.561 times

more likely than no education female workers to give birth to LBW babies (OR 0.561; 95% CI 0.370-0.850). Meanwhile, higher education female workers have a 0.414 times chance compared to no education female

workers to give birth to LBW babies (OR 0.414; 95% CI 0.265-0.645). This information shows that the higher the education level, the lower the possibility of female workers to produce LBW babies in Indonesia.

**Table 1. The descriptive statistics of the education level of the female workers who had given birth in the last 5 years in Indonesia(n=18,061)**

Variables	Education Level								P
	No Education		Primary		Secondary		Higher		
	n	%	n	%	n	%	n	%	
Low Birth Weight									***0.000
No	129	22.4%	1524	28.5%	3404	41.0%	2047	53.6%	
Yes	448	77.6%	3831	71.5%	4905	59.0%	1773	46.4%	
Age group									***0.000
15-19	3	0.5%	20	0.4%	72	0.9%	0	0.0%	
20-24	24	4.2%	209	3.9%	693	8.3%	95	2.5%	
25-29	51	8.8%	635	11.9%	1523	18.3%	797	20.9%	
30-34	104	18.0%	1192	22.3%	2190	26.4%	1338	35.0%	
35-39	157	27.2%	1710	31.9%	2215	26.7%	1067	27.9%	
40-44	157	27.2%	1235	23.1%	1318	15.9%	413	10.8%	
45-49	81	14.0%	354	6.6%	298	3.6%	110	2.9%	
Marital status									***0.000
Never in union/Divorced/Widowed	24	4.2%	291	5.4%	382	4.6%	75	2.0%	
Married/Living with partner	553	95.8%	5064	94.6%	7927	95.4%	3745	98.0%	
Wealth status									***0.000
Poorest	481	83.4%	2953	55.1%	1833	22.1%	268	7.0%	
Poorer	53	9.2%	979	18.3%	1694	20.4%	386	10.1%	
Middle	25	4.3%	731	13.7%	1721	20.7%	519	13.6%	
Richer	13	2.3%	467	8.7%	1706	20.5%	866	22.7%	
Richest	5	0.9%	225	4.2%	1355	16.3%	1781	46.6%	
ANC visits									***0.000
< 4 times	56	42.7%	307	18.2%	303	8.5%	99	5.1%	
≥ 4 times	75	57.3%	1383	81.8%	3244	91.5%	1826	94.9%	
Smoking Behavior									
No	516	89.9%	5134	95.9%	8115	97.7%	3790	99.2%	
Yes	58	10.1%	218	4.1%	192	2.3%	30	0.8%	

**Note:** \*p <0.05; \*\*p <0.01; \*\*\*p <0.001.



**Table 2. Results of binary logistic regression of LBW among female worker who had given birth in the last 5 years in Indonesia (n=18,061)**

Predictor	Low Birth Weight			
	P	OR	Lower Bound	Upper Bound
Education Level: No education	-	-	-	-
Education Level: Primary	0.163	0.747	0.496	10.126
Education Level: Secondary	**0.006	0.561	0.370	0.850
Education Level: Higher	***0.000	0.414	0.265	0.645
Age group of respondents: 15-19	-	-	-	-
Age group of respondents: 20-24	0.409	1.292	0.704	2.369
Age group of respondents: 25-29	0.814	1.074	0.592	1.950
Age group of respondents: 30-34	0.711	1.119	0.617	2.027
Age group of respondents: 35-39	0.970	0.989	0.543	1.799
Age group of respondents: 40-44	0.604	1.176	0.638	2.166
Age group of respondents: 45-49	0.398	1.348	0.674	2.698
Marital status: Never in union/Divorced/Widowed	-	-	-	-
Marital status: Married/Living with partner	0.627	1.080	0.791	1.474
Wealth status: Poorest	-	-	-	-
Wealth status: Poorer	0.152	0.863	0.705	1.056
Wealth status: Middle	0.103	0.841	0.684	1.035
Wealth status: Richer	**0.002	0.708	0.568	0.882
Wealth status: Richest	**0.006	0.722	0.572	0.912
ANC visits: < 4 times	-	-	-	-
ANC visits: ≥ 4 times	***0.000	0.603	0.497	0.730
Smoking behavior: No	-	-	-	-
Smoking behavior: Yes	0.727	1.081	0.699	1.672

Note: \*p <0.05; \*\*p <0.01; \*\*\*p <0.001.

A high level of education is one of the outputs of women's empowerment. Better education has an impact on maternal nutrition and reduces the incidence of LBW<sup>16,17</sup>. Several previous studies have informed that a good level of education is a major predictor of performance in the health sector<sup>18,19</sup>. On the other hand, poor education is an obstacle for the health sector to produce quality output<sup>20,21</sup>.

Apart from the education level, the analysis also found two other variables as predictors of LBW among female workers in Indonesia. First, wealth status. The richer female worker has a 0.708 times chance compared to the poorest female worker to give birth to LBW babies (OR 0.708; 95% CI 0.568-0.882). The richest female worker has a probability of 0.722 times

compared to the poorest female worker to give birth to LBW babies (OR 0.722; 95% CI 0.572-0.912). Wealth status as a predictor of LBW because it relates to food availability in the household. The poorer a family, the lower the food availability<sup>22</sup>. Several studies provide consistent findings. Some of them were carried out in India, Ethiopia, Bangladesh, and Pakistan<sup>23-26</sup>.

The second, ANC visits. Female workers who made complete ANC visits (≥ 4 times) during their pregnancy were 0.603 times more likely than female workers who made incomplete ANC visits (<4 times) to deliver LBW babies (OR 0.603; 95% CI 0.497-0.730). The results of this analysis inform that carrying out complete ANC visits is a protective factor for LBW among female workers in Indonesia.

Conducting ANC visits as recommended by the Ministry of Health at least 4 times during pregnancy will monitor the health of pregnant women properly<sup>27</sup>. If there is a risk of pregnancy, for example, the mother is underweight, interventions can be immediately carried out to provide the best delivery output for the mother and the baby<sup>28</sup>.

### Conclusions

Based on the research results, it can be concluded that the education level is a predictor of LBW among female workers in Indonesia. The higher the education level, the lower the possibility of female workers to have LBW babies in Indonesia.

**Acknowledgments:** The author would like to thank the ICF International, who has agreed to allow the 2017 IDHS data to be analyzed in this article.

**Source of Funding:** Self-funding

**Conflict of Interest:** The authors declare no conflict of interest, financial or otherwise.

**Ethical Clearance:** The 2017 IDHS has received ethical clearance from the National Ethics Commission. Utilization of the 2017 IDHS data in this study has been permitted by ICF International through its website: <https://dhsprogram.com/data/new-user-registration.cfm>.

### References

1. European Agency for Safety, at Work (EU-OSHA) H. Risks and trends in the safety and health of women at work. EU-OSH. 2011;1–8.
2. Davidson PM, McGrath SJ, Meleis AI, Stern P, DiGiacomo M, Dharmendra T, et al. The Health of Women and Girls Determines the Health and Well-Being of Our Modern World: A White Paper From the International Council on Women's Health Issues. *Health Care Women Int.* 2011 Oct;32(10):870–86.
3. Bartley KA, Underwood BA, Deckelbaum RJ. A life cycle micronutrient perspective for women's health. *Am J Clin Nutr.* 2005 May;81(5):1188S–1193S.
4. Banerjee B. Physical hazards in employment and pregnancy outcome. *Indian J Community Med.* 2009;34(2):89–93.
5. Smith LC, Ramakrishnan U, Ndiaye A, Haddad L, Martorell R. The importance of women's status for child nutrition in developing countries. *Research Report of the International Food Policy Research Institute.* 2003. 1–164 p.
6. Worldbank. Labor force participation rate, female (% of female population ages 15+) (modeled ILO estimate).
7. Organization IL. Care Work And Care Jobs For The Future Of Decent Work. *Care Work and Class: Domestic Workers' Struggle for Equal Rights in Latin America.* 2012. 1–10 p.
8. UNICEF. Women Work UNICEF's approach to women's paid and unpaid work. 2019;1–9.
9. Suparmi S, Chiera B, Pradono J. Low birth weights and risk of neonatal mortality in Indonesia. *Heal Sci J Indones.* 2016;7(2):113–7.
10. Mahmoodi Z, Karimlou M, Sajjadi H, Dejman M, Vameghi M, Dolatian M, et al. Association of maternal working condition with low birth weight: The social determinants of health approach. *Ann Med Health Sci Res.* 2015;5(6):385.
11. Xu X, Ding M, Li B, Christiani DC. Association of rotating shiftwork with preterm births and low birth weight among never smoking women textile workers in China. *Occup Environ Med.* 1994 Jul;51(7):470–4.
12. Khan JR, Islam MM, Awan N, Muurlink O. Analysis of low birth weight and its co-variants in Bangladesh based on a sub-sample from nationally representative survey. *BMC Pediatr.* 2018;18(1):1–9.
13. Mahumud RA, Sultana M, Sarker AR. Distribution and determinants of low birth weight in developing countries. *J Prev Med Public Heal.* 2017;50(1):18–28.
14. Sharma M, Mishra S. Maternal risk factors and consequences of low birth weight in Infants. *IOSR J Humanit Soc Sci.* 2013;13(4):39–45.
15. World Health Organization. *Global Nutrition Targets 2025: Low birth weight policy brief* [Internet]. Geneva; 2014. Available from: [https://www.who.int/nutrition/publications/globaltargets2025\\_policybrief\\_lbwn/en/](https://www.who.int/nutrition/publications/globaltargets2025_policybrief_lbwn/en/)
16. Kabir A, Rashid MM, Hossain K, Khan A, Sikder SS, Gidding HF. Women's empowerment is associated with maternal nutrition and low birth weight: Evidence from Bangladesh Demographic Health Survey. *BMC Womens Health.* 2020;20(1):Article number 93.

17. Shome S, Pal M, Bharati P. Influence of maternal autonomy and socioeconomic factors on birth weight of infants in India. *Malays J Nutr.* 2018;24(1):35–46.
18. Ipa M, Widawati M, Laksono AD, Kusriani I, Dhewantara PW. Variation of preventive practices and its association with malaria infection in eastern Indonesia: Findings from community-based survey. *PLoS One.* 2020;15(5):e0232909.
19. Wulandari RD, Laksono AD. Education as predictor of the knowledge of pregnancy danger signs in Rural Indonesia. *Int J Innov Creat Chang.* 2020;13(1):1037–51.
20. Laksono AD, Wulandari RD. The Barrier to Maternity Care in Rural Indonesia. *J Public Heal From Theory to Pract.* 2020;Online First.
21. Rohmah N, Yusuf A, Hargono R, Laksono AD, Masruroh, Ibrahim I, et al. Determinants of teenage pregnancy in Indonesia. *Indian J Forensic Med Toxicol.* 2020;14(3):2080–5.
22. Laksono AD, Ibad M, Mursita A, Kusriani I, Wulandari RD. Characteristics of mother as predictors of stunting in toddler. *Pakistan J Nutr.* 2019;18(12):1101–6.
23. Banerjee A, Singh AK, Chaurasia H. An exploratory spatial analysis of low birth weight and its determinants in India. *Clin Epidemiol Glob Heal.* 2020;8(3):702–11.
24. Alemayehu GM, Chernet AG, Dumga KT. Determinants of child size at birth and associated maternal factor in gurage zone. *J Reprod Infertil.* 2020;21(2):138–45.
25. Karim MR, Mondal MNI, Rana MM, Karmaker H, Bharati P, Hossain MG. Maternal factors are important predictors of low birth weight: Evidence from Bangladesh demographic & health survey-2011. *Malays J Nutr.* 2016;22(2):257–65.
26. Khan A, Nasrullah FD, Jaleel R. Frequency and risk factors of low birth weight in term pregnancy. *Pakistan J Med Sci.* 2016;32(1):138–42.
27. Laksono AD, Rukmini R, Wulandari RD. Regional disparities in antenatal care utilization in Indonesia. *PLoS One.* 2020;15(2):e0224006.
28. Siramaneerat I, Agushyana F, Meebunmak Y. Maternal risk factors associated with low birth weight in Indonesia. *Open Public Health J.* 2018 Aug;11(1):376–83.

# Dental Care Interventions as Efforts to Reduce PUFA Index and Improve Nutritional Status in Children aged 9-12 Years in Orphanages

Indrayati Fadjeri<sup>1</sup>, Rahaju Budiarti<sup>1</sup>, Tedi Purnama<sup>1</sup>

<sup>1</sup>Assistant Professor, Department of Dental Health, Health Polytechnic of Jakarta I, Indonesia

## Abstract

The main problem in the child's oral cavity to date is dental caries. Untreated dental caries could cause difficulty eating and sleeping, experience pain, and need continuous care, so that it impacts on poor quality of life, and health problems arise one of which is the condition of the child's nutritional status. This research aims at effectiveness Dental Care Interventions as Efforts to Reduce PUFA Index and Improve Nutritional Status in Children aged 9-12 Years in Orphanages. Method: this study used a quasy experiment with a pretest and posttest with control group design. This research was conducted at the Mizan Amanah Orphanage in Cinere District, Depok City. Independent variable: Dental care intervention and dependent variable: PUPA index and children's nutritional status. Data tested using Wilcoxon/paired sample t-test and independent t-test/mann whitney test and linear regression. Results: Dental care interventions were effective in reducing PUPA index ( $p < 0.001$ ) and were effective in improving the status of children aged 9-12 years ( $p < 0.011$ ). Conclusion: effective dental care interventions as efforts to reduce PUPA index and nutritional status of children aged 9-12 years in orphanages

**Keywords:** *Dental care interventions, PUFA Index, nutritional status.*

## Introduction

The main problem in the child's oral cavity to date is dental caries. This was proven by Nelwan research (2015) in Yataama Al Firdausi orphanage Semarang, showing the prevalence of dental caries by 69.7% while the results of the 2013 Basic Health Research reported the prevalence of Indonesian population with oral and dental health problems of 25.9%. So it can mean the orphanage children have higher caries.<sup>2-4</sup>In some countries the prevalence of dental caries has decreased in the last twenty-five years, but in developing countries, including Indonesia, the disease is still a major problem in adults and especially in children.<sup>5</sup>

A study in Delhi India of 520 children aged 9-12 years published in 2011 showed a caries prevalence of 52.3%, the mean def-t for children aged 9 years was 2.17 and age 12 years was 0.27; while the average DMF-t of 9-year-old children is 1.1 and the age of 12 years is 0.8. Other studies in Peru showed the mean DMF-T of 12-year-old children was 3.92 with a caries prevalence of 83.8%.<sup>6-7</sup>

Caries is an infectious disease that results from bacterial interactions. Dental caries occurs due to the demineralization process of bacterial interactions on the tooth surface. Bacteria are acidic so that within a certain period of time, acids will damage tooth enamel and cause cavities. The etiological factors for caries are plaque microorganisms, diet and time.<sup>8</sup>

Untreated dental caries can cause difficulty eating and sleeping, experience pain, and need continuous care, thus impacting on poor quality of life, and health problems arise. One of them is the condition of the nutritional status of children. Children who experience dental caries will experience pain in the hole, so that it

---

### Corresponding Author:

**Tedi Purnama**

Department of Dental Health, Health Polytechnic of Jakarta I, Wijaya Kusuma Raya Street, No. 47, Jakarta, Indonesia

e-mail: tedypurnama23@yahoo.com

will reduce consumption of food. Children who reduce food consumption in the long term, will have an impact on the nutritional status of children.<sup>9</sup>

According Rohmawati (2016) dental caries is a disease that can interfere with the nutritional conditions of children so that it can cause nutritional problems. Dental caries is a disease that can interfere with the nutritional condition of children so that it can cause nutritional problems, with nutritional status but can also be related to the severity of dental caries.<sup>10</sup>

Some problems that arise in untreated caries such as pulpitis, ulceration, fistula, abscess and pulp necrosis. The index used to calculate the severity of untreated dental caries is known as the PUFA index. In permanent teeth, this index is written using capital letters (PUFA) while milk teeth are written using lowercase letters (pufa).<sup>11, 12</sup>

Siregar research (2019) showed the severity of untreated dental caries that had caused an open pulp (P/p) of 1.54; traumatic ulceration around soft tissue (U/u) on average by 0.06; there is no severity of untreated dental caries that has caused fistulas (F/f); and has caused inflammation or abscess (A/a) of 0.07 on average. Another study by Pratiwi (2013) also proved the overall prevalence of caries at the age of 6 years by 62% with the highest component of caries in deciduous teeth and 8 permanent teeth had caries with pulp involvement. For the age of 9 years 65.8% with permanent dental caries 10% and children aged 12 years the highest caries prevalence in permanent teeth, which is 25.3%.<sup>5, 11</sup>

Efforts are made to overcome the problem of dental and oral diseases by approaching health workers and dentists in the form of dental and oral health services in the form of activities with promotive, preventive, curative approaches, which are carried out in an integrated, comprehensive, and sustainable manner. Dental care interventions to reduce PUPA index are dental fillings and extractions. It is expected that the pain caused by dental caries can be overcome and the function of chewing can function optimally so that the intake of nutrients is good and can affect the nutritional status of children.<sup>3</sup>

Based on background above author interested in conducting research under the title “Dental Care Interventions as an Effort to Reduce PUFA Index and Improve Nutritional Status in Children Aged 9-12 Years in Orphanages”

## Method

The method used in this research is quasi experiment with pre and post-test with control group design. This research was conducted at Amanah Mizan Orphanage in Cinere District, Depok City. The data collection was carried out in August - September 2019. The research sample was taken using a purposive sampling technique, consisting of 62 respondents consisting of an intervention group of 32 respondents and a control of 32 respondents. The independent variables in this study were dental care interventions and the dependent variables were PUPA index and children's nutritional status. Research data using ratio scale, statistical tests using Wilcoxon/paired sample t-test and independent t-test/Mann Whitney test and linear regression. The research stages are as follows:

1. Respondents were selected according to criteria
2. Samples were divided into 2 groups, the intervention group was given dental care measures and the control group was only given mouth rinses.
3. Before examining the oral cavity we provide counseling on how to maintain healthy teeth and what are the effects if cavities are not treated.
4. The next step is to conduct a pre-test in the form of examination of PUFA index and nutritional status in the form of body mass index measurement.
5. Then the research intervention was carried out, in the intervention group the form of treatment performed was tooth extraction and dental fillings using mashed garlic and covered with temporary fillings. Whereas the control group gargled with warm salt solution.
6. After 30 days, a post-test was conducted to examine the PUFA index and nutritional status in the form of a body mass index measurement.

## Result

**Table 1. Frequency distribution of respondent characteristics**

Variable	Intervention		Control	
	N	%	N	%
<b>Gender</b>				
Men	15	46.9	17	53.1
Women	17	53.1	15	46.9
<b>Age (Years)</b>				
9-10	15	46.9	14	43.8
11-12	17	53.1	18	56.3

Table 1 shows the respondents in this study consisted of 34 men (53.12%) and 30 women (46.88%). The intervention group consisted of 15 men (46.9%) and 17 women (53.1%) while the control group consisted of 17 men (53.1%) and 15 women (46.9%). The age

variable found that children aged 9-10 years amounted to 15 people in the intervention group and 14 people in the control group. While respondents aged 11-12 years there were 17 people in the intervention group and 18 people in the control group.

**Table 2. Average PUPA index values and Nutrition Status**

No	Variable	Intervention		Control	
		Pre-test	Post-test	Pre-test	Post-test
1	<b>PUPA index</b>				
	Mean	1.44	0.47	1.28	1.09
	SD	1,076	089	1,746	1,532
	Min-Max	0 - 5	0 - 4	0 - 7	0 - 6
2	<b>Nutritional status</b>				
	Mean	17.55	17.77	16.14	16.36
	SD	2,363	2,295	2,462	2,250
	Min-Max	13.2 - 22.4	13.5 - 22.8	9.8 - 21.1	10 - 20.8

Table 2 shows, the average PUPA index in the intervention group was 1.44 before treatment and in the control group was 1.28, which means that there were an average of 2 cavities that were not treated. After dental treatment in the form of dental fillings and extractions, the average PUPA was found to decrease to 0.47 in the intervention group while in the control group it

was 1.09. This table also shows changes in nutritional status in the intervention group on average 17.55 before treatment and there is an increase in nutritional status to an average of 17.77. Whereas in the control group the average nutritional status was 16.14 and after treatment it was 16.36.

**Table 3. Test the effectiveness of the PUPA index and nutritional status before and after dental care interventions**

Group		PUPA Index *		Nutritional status**	
		Mean + SD	P-value	Mean + SD	P-value
Intervention	Pre-test	1.44 + 1,076	0.001	17.55 + 2,363	0.011
	Post-test	0.47 + 0.879		17.77 + 2,295	
Control	Pre-test	1.28 + 1.746	0.064	16.14 + 2.462	0.168
	Post-test	1.09 + 1.532		16.36 + 2.250	

\* Wilcoxon, \*\* Paired Test Samples

The results of effectiveness test data before and after dental treatment showed PUPA index p-value of the intervention group was 0.003 (p <0.05) and the control group's p-value was 0.064 (p > 0.05) while the nutritional status showed the intervention group's p-value was

0.011 (p <0.05) and the p-value of the control group was 0.168 (p > 0.05) meaning that the administration of dental care interventions effectively increased the PUPA index of nutritional status in children of the Mizan Amanah orphanage.

**Table 4. Different tests of PUPA index and Nutrition Status in the intervention and control groups**

Group		PUPA Index *		Nutritional status**	
		Mean + SD	P-value	Mean + SD	P-value
Intervention	Pre-test	0.47 + 0.879	0.050	17.77 + 2,295	0.015
	Post-test				
Control	Pre-test	1.09 + 1.532			
	Post-test				

\* Mann-Whitney, \*\* Independent Sample Test

The results of the PUPA index difference test showed the p-value between the intervention group and the control group was 0.050 ( $p < 0.05$ ), meaning that the provision of dental care interventions was more effective in increasing the PUPA index than the control group.

While the nutritional status shows the p-value between the intervention and control groups is 0.015 ( $p > 0.05$ ) meaning that the provision of dental care interventions is more effective in improving nutritional status compared to the control group.

**Table 5. Dental care most influential on nutritional status**

Variable	B	P value	R Square	C	Annova P-value
Dental filling	1,083	0.145	0.177	19.28	0.05
Tooth extraction	1,502	0.025			

\* Linear regression

Based on table 5, it can be seen that the constant value is 19.28 with a dental filling coefficient of 1.083 meaning that a 1% dental filling intervention will increase nutritional status by 1,083. The tooth extraction coefficient value of 1.502 means that the 1% tooth extraction intervention will increase the nutritional status by 1,502. The results of the analysis show the results of R<sup>2</sup> (R Square) of 0.177 or (17.7%), meaning that dental filling and tooth extraction interventions have a 17.7% effect on improving nutritional status. The analysis showed that the value of  $p = 0.05$  means that the influence of dental filling intervention and tooth extraction has an increase in nutritional status.

## Discussion

Nutrition is food intake related to the body's need for food. Adequate nutrition includes quality, quantity, and the body's ability to use it carefully to meet the body's metabolic needs. With many cases of cavities that are not treated immediately will cause pain and discomfort when eating which can result in decreased appetite that will affect body mass index.<sup>13, 14</sup>

The results of the test of the effectiveness of data before and after being given dental care showed a value of  $p < 0.05$ . This situation shows that by decreasing cases of untreated caries (PUFA index) by treating dental problems can improve the nutritional status of children. This situation is in line with research conducted by Rohmawati (2016), which states that there is a significant relationship between the caries index that is not treated with nutritional status. This can happen because if a tooth is damaged or disrupted it will interfere with the function of mastication and will tend to choose soft foods so that it will reduce the intake of nutrients that will affect the child's weight.<sup>10, 13</sup>

The results of the analysis of the types of treatments that are most effective for obtaining nutritional status show that both dental care interventions, either tooth extraction or dental fillings can reduce the pain that may

arise when they consume food so that there is no more interference when teeth are used for masticatory function, this condition allows increased food intake which can improve nutritional status. In accordance with secondary factors that affect nutritional status,

namely the presence of impaired digestive function of food such as tooth decay/disease, the digestive apparatus that causes food cannot be digested properly, so that incoming nutrients cannot be absorbed properly resulting in insufficient body needs.<sup>10, 15</sup>

Judging from the type of treatment, dental filling interventions provide changes in nutritional status better when compared to treatment of extraction. In the case of filling most of the cavities are already on the pulp, causing pain when used for chewing and after filling the pain is reduced so that it can perform mastication function is better and there is an increase in nutritional status. Patches made to close cavities using garlic ingredients to reduce pain and were quite effective for a while, because it can also improve the nutritional status of children.<sup>16</sup> Nevertheless dental care must be continued for permanent fillings.

### Conclusion

**Based on the results of the study, it can be concluded that:**

1. Dental care interventions were proven to be significantly ( $p < 0.001$ ) effective in increasing the PUPA index of children in the Mizan Amanah orphanage.
2. Dental care interventions were shown to be significantly ( $p < 0.001$ ) effective in improving the nutritional status of Mizan Amanah orphanages.
3. Dental care interventions in the form of dental fillings and extractions have a 17.7% effect on improving nutritional status.

**Source Funding:** This study was funded by Ministry of Health Polytechnic Jakarta I.

**Conflict of Interest:** The authors declare that they have no conflict interests.

**Ethical Clearance:** The ethical clearance taken from Ethical Committee of Health Research, Health Polytechnic of Jakarta I.

### Reference

- 1 Gultom E, Sormin T. Analysis of Dental Health Status and Dental Care Needs of Elementary School Students in Bandar Lampung City. *Sai Betik's Scientific Nursing Journal*. 2018; 13 (1): 67-74.
- 2 Purnama T, Rasipin R, Santoso B. Effects of Tedi's Behavior Change Model Training on Teachers and Parents on Teeth Brushing Skills of Preschoolers. *Journal of Health Quality*. 2019; 13 (2): 75-81.
- 3 Nelwan J. Factors - Factors That Influence the High Case of Dental Caries in Children of Yataama AL-Firdausi Orphanage in the Work Area of the Ngesrep Health Center in 2011. *Journal of Dental Health*. 2015; 3 (2): 106-12.
- 4 Ministry of Health. Basic health research (Riskesdas) 2013. 2013.
- 5 Pratiwi R, Mutmainah R. A description of the Severity of Caries in Children Ages 6, 9 and 12 Years in Pinrang Regency, South Sulawesi Using the PUFA/pufa index. *A Dentofacial*. 2013; 2.
- 6 Mathur A, Mathur A, Jain M, Shah P, Pareek V, Prabu D, et al. Dental caries experience among kindergarten school going children of, India. *Pediatric Dental Journal*. 2011; 21 (1): 1-5.
- 7 Delgado-Angulo EK, Hobdell MH, Bernabe E. Poverty, social exclusion and dental caries of 12-year-old children: a cross-sectional study in Lima, Peru. *BMC oral health*. 2009; 9 (1): 16.
- 8 Mustika MD. Incidence of Dental Caries in Preschoolers in Red Kindergarten Meranggi Marta Pura. *Dentino Journal of Dentistry*. 2014; 2 (2).
- 9 Putri RM, Maemunah N, Rahayu W. The Relationship of Dental Caries with the Nutritional Status of Preschoolers. *Care: Scientific Journal of Health Sciences*. 2017; 5 (1): 28-40.
- 10 Rohmawati N. Dental Caries and Child Nutritional Status. *Stomatognathic-Journal of Dentistry*. 2017; 13 (1): 32-36.
- 11 Siregar SNA, Molek K. Severity of Untreated Caries in Class 1, 2, and 3 Children in Parulian 2 Elementary School in Medan Based on PUFA Index/puff. *Prima Journal of Oral and Dental Sciences*. 2019; 2 (6): 1-6
- 12 Jotlely FB, Wowor VN, Gunawan PN. The caries status is based on the DMF-T index and the PUFA index for Papuans in the Cendrawasih hostel in the city of Manado. *Journal of e-Dentistry*. 2017; 5 (2).
- 13 Asmawati PF, Pasolon F. Analysis of the relationship of dental caries and nutritional status of children aged 10-11 years in Athirah Elementary School, SDN 1 Bawakaraeng and SDN 3 Bangkala. *Dentofacial Journal*. 2007; 6 (2): 78-84.
- 14 Fankari F. Relationship between Dental Caries



- Occurrence Rate and Nutritional Status of Children 6-7 Years at SD Inpres Kaniti, Kupang Tengah District, Kupang Regency. *Journal of Health Info.* 2018; 16 (1): 32-43.
- 15 Par'i H, Wiyono S, Harjatmo T. Nutrition teaching materials: assessment of nutritional status. Ministry of Health of the Republic of Indonesia. 2017.
- 16 Soraya C, Chismirina S, Novita R. Effect of Garlic Juice (*Allium sativum* L.) As Root Canal Irrigation In Inhibiting Growth of *Enterococcus faecalis* In Vitro. *Cakradonya Dental Journal.* 2018; 10 (1): 1

# Psychological and Personality Development Supports to the Prisoners in Correctional Institution in Indonesia

Irma Cahyaningtyas<sup>1</sup>, Nur Rochaeti<sup>1</sup>

<sup>1</sup>Lecturer at Faculty of Law, Universitas Diponegoro, Semarang, Indonesia

## Abstract

The correctional institution is a place for treatment the prisoners. The current condition, the responsibility for treatment prisoners lies with the state, carried out by one institution without assistance from other institutions, namely the Correctional Institution. The problems in this paper are first, what is the current form of treatment for prisoners in Correctional Institution; second, how to reconstruct the form of treatment for prisoners in Correctional Institutions in the future. This paper uses an empirical juridical research method using the socio-legal approach. The results in this paper are first; the treatment aimed at current prisoners is personality treatment and independence treatment. In practice, both of these treatments found obstacles in the form of inadequate facilities and infrastructure and overcapacity of the Correctional Institution conditions, which resulted in no ideal coaching; second; based on this, it is necessary to reconstruct treatment of prisoners in the Correctional Institution. Reconstruction was carried out by developing a form of community-based correction and the existence of cooperation from the private sector in the form of partnerships. If this is realized, the purpose of the treatment process can be achieved, and the prisoner, after finished treatment, can return to the community properly.

**Keywords:** *Legal reconstruction, psychological treatment, correctional institution.*

## Introduction

Penitentiary is a place to foster prisoners. Penitentiary is a criminal system that has moved far away from the philosophy of retaliation, detention, and resocialization. In other words, punishment is not intended to make suffering as a form of retaliation, it is not intended to deter suffering, nor does it assume the convict is someone who lacks socialization. Penalization is also in line with the social reintegration philosophy which assumes crime is a conflict that occurs between the convicted person and the community so that punishment is intended to restore conflict or reunite the convicted person with his community<sup>1</sup>.

Article 1 point 2 of Law No.12 of 1995 concerning Corrections states that the correctional system is an arrangement regarding the direction and boundaries and method of fostering prisoners based on Pancasila which is carried out in an integrated manner between the supervisor, the fostered, and the community to improve the quality of the assisted citizens. Correctional facilities in order to realize mistakes, improve themselves, and not repeat criminal acts so that they can be accepted back by the community, can actively play a role in development, and can live naturally as good and responsible citizens.

The working of the penitentiary system requires an approach. This approach can be done through a coaching stage process. In connection with the development of prisoners, in undergoing the prison process, prisoners are given guidance which is essentially to return the prisoner to a good, confident, independent, active and productive society. Thus, these coaching activities must pay attention to various aspects of the life of prisoners in order to have independence and strong self-confidence<sup>2</sup>.

---

### Corresponding Author:

**Irma Cahyaningtyas**

Lecturer at Faculty of Law, Universitas Diponegoro, Jl.  
Prof Sudarto, S.H Central Java  
e-mail: irmafjr83@gmail.com

Guidance and guidance for inmates is carried out by special functional officers, namely Correctional Officers or supervisors. Thus, the implementation of the correctional requires professionalism of human resources who will understand well the objectives of the correctional and how to achieve these goals, and to avoid inhuman treatments. In fact, at this time, the development process is the responsibility of the state which is carried out by the correctional institutions only. Of course, this situation is not comparable to the situation in prisons that are over capacity<sup>3</sup>. One of the countermeasures is the presence of the role of other parties in the process of coaching prisoners. This role is not only in the form of collaboration with related government agencies and social institutions to support effectiveness but also a role to participate in the process of coaching prisoners.

Several papers that have previously discussed about the development of prisoners, including a paper that discusses the development of prisoners in a correctional perspective which in practice leads to the development of each individual prisoner<sup>4</sup>. Another paper discusses several criminal acts committed by inmates, including murder, theft, robbery, sexual violence, and illegal arms sales<sup>5</sup>. Another paper examines efforts to reduce the density of prisoners in correctional institutions, where one of them is to provide jobs to inmates and reward inmates for the success of the work<sup>6</sup>. The next paper discusses the fulfillment of health for prisoners where prisoners are often affected by mental disorders and infectious diseases. Therefore, meeting health needs needs to be well accommodated<sup>7</sup>. In this paper, we will discuss the form of training for prisoners in correctional institutions and efforts to reconstruct in relation to the development of prisoners in the future.

## Research Method

This paper uses the empirical juridical research method, which examines the applicable legal provisions and what happens in reality in society or research is carried out on the actual situation that occurs in society, with the intention of finding the facts that are used as research data which are then analyzed to identify problems which in turn lead to problem solving<sup>8</sup>. The research specification in this paper is descriptive analytical<sup>9</sup>. So that it can describe the conditions of coaching for prisoners in correctional institutions and the description is analyzed with the help of theories and opinions from the results of other papers in relation to an effort to reconstruct the development of prisoners.

The approach used in this paper is socio-legal. Socio-legal study is a study of law using the approach of legal science and social sciences<sup>10</sup>. The socio-legal approach is used in this paper to explain the efforts to reconstruct the development of prisoners by emphasizing legal and non-legal aspects so that ideal prison development is created.

### Social and Psychic Rehabilitation of Prisoners:

According to Article 1 paragraph 3 of Law no. 12 of 1995 concerning Corrections, which states that penitentiary is a place to carry out the development of prisoners. The prison system in Indonesia is actually a substitute for the prison system which is a colonial legacy. In 1964 in Indonesia, a correctional system emerged which was the idea of Sahardjo, in relation to the Treatment of Offenders. The conception of correctionalization is not merely formulating the objectives of imprisonment, but is a system of guidance, a method in Treatment of Offenders which is multilateral oriented by focusing on the potentials that exist in the individual concerned, as well as those in the midst of society as a whole. The correctional system has a very important meaning, because it changes the direction of the aim of imprisonment, which is a way to guide and foster prisoners<sup>11</sup>. Several aspects that need to be emphasized in the coaching process include:<sup>12</sup>

- a. **Social rehabilitation:** In the coaching process, there must be social guidance in the form of counseling, direction and personality development, so that they will live as human beings with personality and faith.
- b. **Vocational rehabilitation:** In the coaching process there must be an emphasis on effective and effective skills. This is because inmates after completing their sentence can return to work in society. Therefore, it requires preparation in order to live in a new social environment. If you do not have this provision, there is the possibility of relapse.
- c. **Education rehabilitation:** In the coaching process there must be practical education. This is because there may be prisoners who are illiterate and drop out of school.
- d. **Medical rehabilitation:** In the coaching process, it is necessary to have health/mental medication to treat various background problems of prisoners, for example due to stress, frustration, and others.

The process of coaching prisoners is currently regulated in the Decree of the Minister of Justice of the Republic of Indonesia Number: M.02-PK.04.10 of 1990

concerning the Guidance Pattern of Prisoners. Coaching is divided into 2 areas, namely personality development and independence development.

First, personality development includes, among others: development of religious awareness; development of the nation and state; development of intellectual abilities (intelligence); development of legal awareness; and development of integrating with the community.

Second, development of independence is provided through programs, namely skills to support independent businesses; skills to support small industrial enterprises; the skills are developed according to the talents of each prisoner; and skills to support industrial businesses or agricultural (plantation) activities using intermediate technology or high technology

Hence, the guidance given to prisoners must be an integral part of the correctional system. Correctional that is seen as a system must have an ultimate goal that must be achieved so that in its implementation it requires assistance from parties other than the state which is responsible for the functioning of the guidance process.

**Psychological and Personality Development Supports for Prisoners:** Penal reform is part of the criminal law policy/politics (penal policy). According to Barda Nawawi Arief, Criminal law reform essentially contains meaning, an effort to reorient and reform criminal law in accordance with the central values of socio-political, socio-philosophical and socio-cultural Indonesian society which underlie social policies, criminal policies and law enforcement policies in Indonesia<sup>13</sup>. In essence, criminal law reform must be pursued with a policy-oriented approach and at the same time a value-oriented approach<sup>14</sup>.

Efforts to reconstruct the development of prisoners cannot be separated from the problem of value, because crime is used as a means of achieving correctional objectives, namely in the implementation of criminal sanctions it does not mean that the punishment imposed on prisoners must be in accordance with human values but must also be able to raise awareness of prisoners of value, human values and social values in society.

Reconstruction specifically regarding the formation of prisoners must be carried out. The reconstruction is expected to realize an effective, efficient and effective process of guiding prisoners. This is quite reasonable, given the ideal purpose of the prison system. However,

in practice there are many obstacles that exist in the development of prisoners at this time so that it can affect the granting of prisoners' rights.

The reconstruction of the development of prisoners in prisons in the future can be carried out by developing ideas so that punishment leads to de-institutionalization or non-institutionalization of punishment in the form of community-based correction and assistance from the private sector in the form of partnerships. Developments towards deinstitutionalization, such as social work, probation and diversion and restorative justice have been practiced in a number of countries for humanitarian considerations as well as to avoid the bad effects of imprisonment for children, women who still have child dependents, and first offender crime categories light. According to this article, philosophically, this development does not contradict the basic idea of correctionalism. Partnerships are needed to help from the aspects of coaching, financing, partnerships as well as supporting the formulation of a more effective strategy. Therefore, partnerships are needed both with other government agencies and elements of society.

The current situation, the training of prisoners carried out in the Correctional Institutions is too bureaucratic, so this creates an impression of being unfriendly and inhuman. The presence of a third party, in this case the private sector, is expected to be able to solve the problems of coaching prisoners. This paper describes the form of private participation in the prisoner development program, which can include providing skilled professionals such as psychologists, pedagogists, social workers; providing trainers and work equipment to support training for prisoners, including in the provision of raw materials and the throwing of products produced by prisoners; after the convicts have finished serving their sentences, the private sector is expected to distribute the labor of ex-convicts who are deemed eligible; contributing funds to finance the basic needs of inmates while serving their sentences; providing reports on the development of prisoners to the government.

According to this paper, the presence of the private sector in the process of coaching prisoners can be seen from two sides. The first side, if the private sector helps ease the duties of correctional institutions in fostering prisoners, it is hoped that it can focus on making inmates as citizens of society who are aware of illegal acts to become skilled in certain jobs and obey the law after they are in society; the second side, there are advantages

for the government, namely constraints, both funds and facilities and infrastructure can be overcome so that the correctional institution can be a place to foster inmates without retaliation; benefits for the private sector, namely developing company work programs, increasing the workforce for the development of the company's business progress, as the moral responsibility of Pancasila Indonesian citizens.

It is hoped that the presence of the private sector in the process of coaching prisoners can make the Penitentiary a productive institution in preparing prisoners to return to society as working people who comply with the law<sup>15</sup>. In the end, the coaching process in the future can achieve the goal of the correctional system, namely to restore the life relationship between prisoners and the community.

### Conclusions and Recommendations

The form of guidance given to prisoners in correctional institutions today is personality development and independence development. In practice, this guidance encountered obstacles, among others, conditions in prisons that were over capacity, limited facilities and infrastructure so that they could affect the provision of guidance to prisoners to which the prisoners were entitled. On the basis of constraints in the process of guiding prisoners, it is necessary to reconstruct the development of prisoners in correctional institutions in the future, namely by developing ideas so that punishment leads to de-institutionalization or non-institutionalization of punishment in the form of community based correction and partnership assistance from the private sector.

The suggestions put forward in this paper are as soon as possible the development program in reconstruction through various forms of guidance so that the private sector can help directly and increase the existence of the open prison. If this is realized, the role of the correctional institution can be helped in the process of developing a more humane and can produce productive prisoners so that when they have finished undergoing guidance, the prisoners can return to the community properly.

**Ethical Clearance:** This research was ethically approved by Faculty of Law, Universitas Diponegoro, Semarang, Indonesia

**Funding:** This research receives funding from by Faculty of Law, Universitas Diponegoro, Semarang, Indonesia.

**Conflict of Interests:** There are no conflict of interests

### References

1. Sujatno A. Sistem Pemasyarakatan Indonesia: membangun manusia mandiri. Directorate General of Corrections, Ministry of Justice and Human Rights; 2004.
2. Harsono CI. Sistem Baru Pembinaan Narapidana. Djambatan; 1995.
3. Nuraeny H, Utami T. The Impact Of Over Capacity On Fulfilling The Basic Rights Of The Assisted Citizen In Prison In The Perspective Of Human Right. InFirst International Conference on Progressive Civil Society (Iconprocs 2019) 2019 May. Atlantis Press.
4. Panjaitan PI. Pembinaan Narapidana Menurut Sistem Pemasyarakatan. to-ra. 2018;4(3):111-6.
- 5]. Langan PA, Levin DJ. Recidivism of prisoners released in 1994. Federal Sentencing Reporter. 2002 Oct 1;15(1):58-65.
6. Mulyono GP, Arief BN. Upaya mengurangi kepadatan narapidana dalam Lembaga Pemasyarakatan di Indonesia. Law Reform. 2016;12(1):1-6.
7. Fazel S, Baillargeon J. The health of prisoners. The Lancet. 2011 Mar 12;377(9769):956-65.
8. Benuf K, Azhar M. Metodologi Penelitian Hukum sebagai Instrumen Mengurai Permasalahan Hukum Kontemporer. Gema Keadilan. 2020 Apr 1;7(1):20-33.
9. Asikin, Z. Amiruddin. Pengantar Metode Penelitian Hukum. Jakarta: Raja Grafindo Persada; 2004.
10. Irianto S. Sidharta, Metode Penelitian Hukum: Konstelasi dan Refleksi. Yayasan Pustaka Obor Indonesia;2009.
11. Irawati D. Menuju Lembaga Pemasyarakatan Berwawasan Hak Asasi Manusia. UKI Press;2006.
12. Priyatno D. Sistem pelaksanaan pidana penjara di Indonesia. Refika Aditama; 2006.
13. Arief BN. Kapita Selektta Hukum pidana. Citra Aditya Bakti; 2003.
14. Jaya NS. Pembaharuan Hukum Pidana. Semarang: Pustaka Rizki Putra. 2017.
15. Holsinger AM, Hughes TT. Correctional Services Corporation v. Malesko: Boss, "They Can't Hurt You Now". Criminal Justice Policy Review. 2003 Dec;14(4):451-63.

# Dispute Resolution through Mediation in Endowments Cases in the Legal Effectiveness Theoretical Perspective

Islamiyati<sup>1</sup>, Rofah Setyowati<sup>1</sup>, Dewi Hendrawati<sup>1</sup>, Aisyah Ayu Musyafah<sup>1</sup>, Ahmad Rofiq<sup>2</sup>

<sup>1</sup>Lecturer at Diponegoro University, Semarang, Indonesia,

<sup>2</sup>Professor at Universitas Islam Negeri Walisongo, Semarang, Indonesia

## Abstract

The development of endowment land in Indonesia is very rapid which is directly proportional to the problems that occur regarding endowment. The resolution of this endowment dispute is based on the charity law, carried out by deliberation and mediation. In some cases, the mediation conducted was not following the existing mediation rules so that eventually the resolution of the endowment dispute became ineffective. It is important to study the problem of the resolution of endowment disputes through mediation from the perspective of the theory of legal effectiveness. This study aims to understand and analyze the problematic of endowment dispute resolution through mediation from the perspective of the theory of legal effectiveness in Central Java. The research method used is socio-legal research, with an empirical juridical approach and includes qualitative research. The results of this study are the settlement of endowment disputes through mediation outside the court according to the theory of legal effectiveness, not yet effective, because there are no formal legal rules. It is necessary to make regulations for the implementation of non-litigation mediation, to provide practical guidance for the implementation of mediation in the community.

**Keywords:** *Charity, Mediation, Dispute Revolution.*

## Introduction

The endowment is developed or empowered by the community<sup>1</sup>. Land Endowment is always associated with public interests and economic value. This is what often causes problems that cannot be resolved internally, thus becoming a dispute. Objects that are used as land endowment disputes, usually associated with the legality status, management, and changes in the function and use of land endowment assets including buildings on it, which are adjusted to the needs of the community in utilizing endowment property. The parties to the dispute can occur between the community and *nadzir* (endowment manager), *waqif* (people with endowment)

with *nadzir*, and *nadzir* with the heirs<sup>2</sup>. Factors causing the appearance of endowment disputes, among others; there is a misunderstanding about the understanding of endowment between *nadzir*, *waqif* and *waqif* heirs, there is a conflict of interest between *nadzir* and *waqif* heirs, the economic value of land prices is higher so that *waqif* heirs sometimes try to seize it, there is no charity land certificate, there is a conflict between religious law and *waqif* and state law regarding the legality of endowment land, *nadzir* defaults (breaking promises and irresponsibility)<sup>3</sup>.

The resolution of endowment dispute has been explained in Article 62 of the Endowment Law No. 41/2004, that is, through deliberations to reach consensus, if it cannot be resolved, then it can be resolved through mediation, if mediation is not successful, then use arbitration or through the Religious Courts. According to Article 49 of Law No. 3/2006 explains that the Religious Courts has the competence to resolve endowment disputes submitted by the disputing parties. This study may be a fairly original study in presenting and examining aspects of endowment and actual problems in the context

---

### Corresponding Author:

#### Islamiyati

Lecturer at Faculty of Law, Diponegoro University, Jl. Prof. Soedarto, Tembalang, Semarang, Central Java 50275, Indonesia

e-mail: islamiyati.undip@yahoo.com

of resolution by involving the religious community and arbitration and ADR. Although this relates to the field of business law, very few previous studies have reviewed ADR in this endowment issue<sup>4,5,6,7,8,9</sup>. This study aims to understand and analyze the problematic of endowment dispute resolution through mediation in the perspective of the theory of legal effectiveness in Central Java. In addition, also to find out the practice of the implementation of mediation in society and its legal problems. The benefit is that it can be used as an effort to develop legal settlement of endowment disputes through effective and optimal mediation in the community.

**Resolution of Endowment Disputes:** Research conducted by<sup>10</sup> explains that the resolution of endowment disputes in the coastal communities of Central Java, uses two pathways, namely the non-litigation route, such as; deliberation (23%) and mediation (60.8%), and litigation path in the Religious Courts (16.2%). According to these data shows that the majority of the people of the coastal regions of Central Java use non-litigation in the resolution of endowment disputes. This is because; faster process, lower cost, informal and final nature, confidentiality guaranteed, can maintain good relations, there is freedom of choice of third parties, certain face-to-face implementation, easier to make improvements, the parties can arrange procedures for dispute resolution. It can be understood that mediation outside the judiciary is the most widely used way of resolving endowment disputes by the parties to the dispute. However, after being criticized, it turned out that mediation was carried out by the parties to the dispute, many of which did not comply with the correct mediation rules, for example; the mediator acts as the party that resolves the problem, the mediator does not know the main tasks and functions so that it is not optimal in resolving disputes, and the parties are not given the opportunity to express their opinions. Thus, this study shows that the implementation of mediation in the resolution of endowment disputes has not been effective.

Research conducted by<sup>11</sup> about the Effectiveness of Mediation in the Settlement of Endowment Disputes (Case Study of the Endowment Land of the Baitul Qudus Mosque on Gebanganom Genuk Sari Semarang Central Java) explains that the effectiveness of mediation depends on the type of endowment dispute, the motivation of the parties to form the Baitul Qudus Mosque Endowment Case on Gebanganom Genuk Sari Semarang Central Java), agreement in dispute resolution, relating to basic/ideological values, the ability of mediators to assist in

the resolution of disputes, and the availability of funds<sup>11</sup>. Furthermore, the research shows that the implementation of mediation in the resolution of endowment disputes in the above case has not been effective, because the mediators are not sincere in helping the parties resolve endowment disputes and there is no awareness of the parties in having a good commitment to resolving endowment disputes.

The effectiveness of the resolution of endowment land disputes through mediation is an attempt to explain whether the rules of mediation law can apply or be implemented by the community in the resolution of endowment disputes. If the rules of mediation law can be carried out by the community in the settlement of endowment disputes, then the law is effective. In this study, what is used as a benchmark for the effectiveness of mediation in the resolution of endowment disputes are five factors as stated by<sup>14</sup> in the theory of legal effectiveness. Five factors that influence the effectiveness of law in society are; statutory regulations (formal juridical), law enforcement (institutional), facilities or facilities for law enforcement (human resources), society (degree of community compliance with law), legal culture (customary law that applies in society). By using the theory of legal effectiveness is used as a benchmark for the implementation of the effectiveness of mediation in the resolution of endowment disputes in Central Java society, it is revealed that factors of statutory regulations, which means rules in written form (legal formal). Rules for the resolution of endowment disputes through mediation have been explained in Article 62 Paragraph (2) of Law No. 41 of 2004 concerning Endowment, ie if the resolution of an endowment dispute cannot be resolved by deliberation, then it can be resolved through mediation. Mediation is a dispute resolution mechanism that cannot be resolved internally by parties, thus requiring other parties to resolve it<sup>15</sup>. Law no. 30 of 1999 concerning Arbitration and ADR are often used by parties in dispute resolution in general, but for the resolution of endowment disputes it still needs to be tested, whether the law can be used as a guideline or not, given the act of endowment has characteristics.<sup>16</sup> The characteristics of endowment acts are the responsibility of endowment property is intended for the community and endowment property must not be lost, damaged, but preserved for the benefit of eternity. If there is a change in objectives and benefits, it must be licensed by PPAIW and BWI as an institution responsible for endowment acts in Indonesia.

## Research Method

This is a field research, its object in the Central Java region, which took samples in the cities of Semarang, Demak, Kendal and Klaten. This type of research includes socio-legal research, because it analyzes the problem of implementing procedures for the resolution of endowment disputes through mediation in the community and legal problems, so that its effectiveness can be known. This research is a qualitative research which aims to develop theoretical concepts based on data and research sources. The approach method uses empirical juridical. Juridical means research that seeks to examine matters concerning the legal basis of the legislation used, namely Law No. 41/2004 Regarding Endowment, Gor. Reg. No. 42/2006 concerning Regulations for Implementing Endowment. Empirical is research on the application of legal rules for the resolution of endowment disputes in the community, legal relations with the community. The research data needed is primary and secondary data. Primary data come from interviews with endowment service agencies in the community, namely; PPAIW (3 people), District BWI (4 people), Provincial BWI (2 people), and Religious Court judges (2 people). Secondary data obtained through literature study and documentation, secondary data includes primary, secondary and tertiary legal materials. This study uses a case study analysis that occurred in the research object area, drawing conclusions using the inductive method and the data was analyzed descriptively and analytically.

## Research Result

The results showed that the resolution of endowment disputes through mediation really helped the parties in realizing a peace agreement, because mediation has several advantages, namely; there is no coercion for the parties to the dispute, instead they are protected and directed so that the dispute is quickly resolved, saves time and money, is flexible and does not seem formal/rigid, confidential is guaranteed, and creates good relations after the dispute.

However, in the practice of resolving endowment disputes, mediation has legal issues that disrupt the existence of endowment law enforcement. Legal problems/problems in the resolution of the endowment dispute in Central Java. Mediation of endowment disputes using the rule of law as contained in Article 62 of the Endowment Law No. 41/2004. However, the mediation rules in the Endowment Law only explain

globally/generally, do not explain in detail about the technical rules of mediation. Rules for mediation through justice/litigation have been explained in PERMA No. 2/2008 jo PERMA No. 1/2016, but the legal rules for the resolution of endowment disputes through non-litigation mediation have no legal rules. So far, the state has non-litigation dispute resolution rules, namely Law no. 30/1999 concerning Arbitration and ADR (Alternative Dispute Resolution). Article 1 (10) of this Law explains that the settlement of disputes through non-litigation channels is carried out by means of consultation, negotiation, mediation, conciliation, or expert judgment. However, this Act does not specifically mention clauses in the settlement of endowment disputes. Though endowments have their own characteristics, such as; endowment property is eternal must not be lost, the use of endowment property for social purposes, endowments of worship and social value. Thus Law No. 30/1999 cannot be applied in the resolution of endowment disputes. Meanwhile, the community has its own pattern in the resolution of endowment disputes based on Islamic law. Islamic law explains that the resolution of endowment disputes is carried out through deliberations towards peace, mediation and judicial judges<sup>12,13</sup>. The pattern used comes from the practice of Islamic scholars (in the organization of PPAIW) in the resolution of endowment disputes. However, the rules of Islamic law above are still global in nature, not yet explaining the detailed rules, so far there are no written rules established by state institutions, so the rules used are based on local customs that do not conflict with Islamic law. This is what makes the rules for the resolution of endowment disputes through mediation, do not yet have the legal force to protect the parties to the dispute.

In the settlement of endowment disputes, the mediator is usually PPAIW, because PPAIW is seen by the public as an expert in endowment law. If there is an endowment dispute, the task is to resolve the endowment dispute, so that the endowment dispute can be resolved fairly and the endowment property can be saved and the endowment law can be upheld in the community. So, the law in force in society is the law that lives in society. The role of the mediator in mediation is very important, because the success of the resolution of endowment disputes through mediation is very dependent on the mediator. Therefore, the mediator must understand the main tasks and functions so that they are professional so that they can direct the parties to a win-win solution. However, in practice what happens in the community



shows that, the mediator is chosen by the parties because it has close social, religious, kinship relations, and is not based on professionalism. This is what causes problems in mediation, because the mediator does not yet know and understand his position, what must be done and how to manage endowment dispute problems so that they can be quickly resolved.

Legal issues for the resolution of endowment disputes, namely; Article 62 of the Endowment Law only explains globally/generally about the procedure for the resolution of endowment disputes through mediation. Mediation that is carried out in the court already has a rule of law namely PERMA No. 1/2006. However, mediation that is carried out outside the court/non-litigation, there is no legal rule regarding practical instructions, so there is no legal certainty. In addition, the dispute resolution rules contained in Law No. 30/1999 concerning Arbitration and ADR, there are no clauses regarding endowment actions. This is what makes the Act cannot be applied in the resolution of endowment disputes in the community. During this time the community uses a living law derived from Islamic law obeyed by its adherents. However, Islamic law still explains globally it has not been detailed.

### Conclusions and Suggestions

The resolution of endowment disputes through mediation outside the court according to the theory of legal effectiveness has not been effective, because there are no formal legal rules. Although Article 62 Paragraph (2) of the Endowment Law has explained the procedures for the resolution of endowment disputes, but there are no facilities or facilities in the law enforcement for the resolution of endowment disputes, both physical facilities, human resources and their supporters, such as good organization, adequate equipment and legal culture in the community. Based on the conclusions above, it is very urgent if the government makes regulations on the implementation of non-litigation mediation, to provide practical guidance on the implementation of mediation in the community. In addition, it also sets policies in facilitating the main and supporting facilities. This is done so that endowment disputes in the community can be resolved fairly and protect the parties to the dispute and save the endowment assets used by the community.

**Ethical Clearance:** This research was ethically approved by Faculty of Law, Universitas Diponegoro, Semarang, Indonesia.

**Funding:** This research was funded by Research Grant Funds at the Faculty of Law of Diponegoro University in the 2020 budget year.

**Conflict of Interests:** There are no conflict of interests

### References

1. Ismawati, I. *Penyelesaian Sengketa Tanah Wakaf Studi Terhadap Tanah Wakaf Banda Masjid Agung Semarang* (Doctoral dissertation, program Pascasarjana Universitas Diponegoro). 2007.
2. Islamiyati I, Rofiq A, Hendrawati D. Implementasi wakaf dalam penyelesaian sengketa wakaf di wilayah pesisir Jawa Tengah. *Masalah-Masalah Hukum*. 2019;48(4):331-40.
- 3] Fadhilah N. *Sengketa Tanah Wakaf dan Strategi Penyelesaiannya*. *De Jure: Jurnal Hukum dan Syar'iah*. 2011 Jun 1;3(1).
4. Ariyanto A, Saraswati R, Sukirno S. Asymmetric election of protecting the voting of the token system in selecting the regional head in Papua. *Test Engineering and Management*. 2020;83(2):3229-3237
5. Saraswati R, Ristyawati A, Basworo RS. Recent developments and changes in the governance of regional legal products in Indonesia: Supervision, evaluation and clarification mechanisms. *International Journal of Innovation, Creativity and Change*. 2020;12(7): 1-9
6. Waridin W, Dwiyanto BM., Saraswati R, Mafruhah I. Formulation of problem-solving design for Indonesian informal sector migrant workers towards post-placement independence: Case study in Malaysia. *Research in World Economy*. 2020;11(1):115-122
7. Utami NS, Prasetyoningsih N, Hidayat A, (...), Saraswati R, Budiono A. Equality of the political rights of people with mental disorders (PWMD) in general elections. *Indian Journal of Forensic Medicine and Toxicology*. 2019;13(4): 1571-1575
8. Azhar M, Solechan S, Saraswati R, Suharso P, Suhartoyo S, Ispriyarso B. The New Renewable Energy Consumption Policy of Rare Earth Metals to Build Indonesia's National Energy Security. *InE3S Web of Conferences 2018* (Vol. 68, p. 03008). EDP Sciences.
9. Ristyawati A, Saraswati R. An Effort of Political

- Party Simplification for the Effective Government Realization. IOP Conference Series: Earth and Environmental Science. 2018;175(1),012170
10. Hendrawati D, Islamiyati I. Penyelesaian Sengketa Tanah Wakaf Yang Tidak Tersertifikasi Di Wilayah Pesisir Utara Jawa Tengah. *Masalah-Masalah Hukum*. 2018;47(1):71-80.
  - 11] Annisa IR. Efektivitas mediasi dalam penyelesaian sengketa wakaf: studi kasus tanah wakaf Masjid Baitul Qudus di Jalan Gebanganom Kelurahan Genuk Sari Kecamatan Genuk (Doctoral dissertation, UIN Walisongo). 2018
  12. Rohman AN, Sugeng S. Probabilitas mekanisme small claim court dalam penyelesaian sengketa waris di pengadilan agama/probability of small claim court mechanism in resolving inheritance disputes in religious court. *Jurnal Hukum dan Peradilan*. 2018 Dec 18;7(3):387-404.
  13. Harahap P. Eksekutabilitas putusan arbitrase oleh lembaga peradilan/the executability of arbitration award by judicial institutions. *Jurnal Hukum dan Peradilan*. 2018 Mar 21;7(1):127-50.
  14. Soekanto S. Efektivitas Hukum dan Penerapan Sanksi. Bandung: Ramadja Karya. 1988.
  15. Abbas S. Mediasi dalam Perspektif Hukum Syariah, Hukum Adat, dan Hukum Nasional, Jakarta: Kencana. 2009.
  16. Roisah K, Utama YJ, Saraswati R, Whidari Y. Status and contemporary development of employee inventions ownership in G-20 countries. *European Research Studies Journal*. 2018;21(2):214-224.

# An Observational Study to Compare the Effect of Two Different Doses of Dexmedetomidine on Hemodynamic Response to Laryngoscopy and Endotracheal Intubation

Jatin B. Patel<sup>1</sup>, Riddhi Agrawal<sup>2</sup>, Malini Mehta<sup>3</sup>

<sup>1</sup>Associate Professor, <sup>3</sup>Professor, Department of Anaesthesiology, Dhiraj Hospital, SBKS MI & RC, Sumandeep Vidyapeeth, Piparia, Waghodia, Vadodara, Gujarat, India, <sup>2</sup>Registrar, University hospitals of North Midlands, Stoke on Trent, Staffordshire, United Kingdom

## Abstract

**Background:** Laryngoscopy and intubation are associated with intense sympathoadrenal stimulation resulting in hypertension, tachycardia & arrhythmias consequent to the release of catecholamines. Various drug regimens and techniques have been used from time to time for attenuating the stress response to laryngoscopy and intubation, including opioids, barbiturates, benzodiazepines, beta blockers, calcium channel blockers, vasodilators etc. Dexmedetomidine is a highly selective alpha 2 receptor agonist having eight times higher affinity and alpha 2 selectivity compared to clonidine and has a shorter duration of action than clonidine.

**Material and Method:** 60 patients scheduled for elective surgical procedures under general anaesthesia belonging to ASA Grade I and II, in the age group of 18 to 60 years were divided into two study groups, D1 and D0.5 received dexmedetomidine 1 µg/kg and 0.5 µg/kg intravenously (iv) over 10 minutes before induction. Hemodynamic responses were compared in both groups by measuring Heart rate (HR), Systolic blood pressure (SBP), Diastolic blood pressure (DBP), Mean arterial pressure (MAP) and SpO<sub>2</sub> before giving the test drug (base line values), just before induction, during intubation and at 1 minute, 3 minutes, 5 minutes, 10 minutes after intubation. Statistical data were analyzed by using student's unpaired t test.

**Observation and Results:** Group D1 had 4.70% rise in HR and Group D0.5 had 9.59% rise during intubation which was statistically significant (p<0.05). Maximum rise in SBP and DBP in Group D0.5 was 14.53% and 12.84% respectively, whereas in Group D1 it was 5.55% and 8.90% respectively. In Group D0.5, rise in BP lasted longer after intubation compared to Group D1.

**Conclusion:** The present study demonstrated that iv dexmedetomidine 1 µg/kg was better than dexmedetomidine 0.5 µg/kg in attenuation of the pressor response of laryngoscopy and intubation without any significant side effects.

**Keywords:** Dexmedetomidine, laryngoscopy, Intubation.

## Introduction

Laryngoscopy and intubation are associated with intense sympathoadrenal stimulation resulting in hypertension, tachycardia & arrhythmias consequent to the release of catecholamine.<sup>(1)</sup> Patients with limited myocardial reserve, tachycardia and hypertension may result in myocardial ischemia, infarction (MI); arrhythmias or precipitate cardiac failure.<sup>(2)</sup> The hypertensive response may produce deleterious effects

---

### Corresponding Author:

**Dr. Riddhi Agrawal**

Registrar, University Hospitals of North Midlands,  
Stoke on Trent, Staffordshire, United Kingdom,  
Department of Anaesthesiology, Dhiraj Hospital, SBKS  
MI & RC, Sumandeep Vidyapeeth, Piparia, Waghodia,  
Vadodara, Gujarat, India  
e-mail: dr\_jatinpatel@yahoo.co.in

in patients with raised intracranial pressures (ICP) or intraocular pressures (IOP), pheochromocytomas and vascular lesions such as intracranial arterio-venous malformations or those with aortic aneurysms and dissection.<sup>(2,3)</sup>

Various drug regimens and techniques have been used from time to time for attenuating the stress response to laryngoscopy and intubation, including opioids, barbiturates, benzodiazepines, beta blockers, calcium channel blockers, vasodilators etc.<sup>(4,5,6,7,8)</sup>

$\alpha_2$  adrenergic agonists namely clonidine and dexmedetomidine decrease sympathetic tone and preoperative use of clonidine has been shown to blunt the hemodynamic responses to noxious stimulation and to prevent overall hemodynamic variability.<sup>(9,10)</sup>

Dexmedetomidine is a highly selective  $\alpha_2$  receptor agonist having eight times higher affinity and  $\alpha_2$  selectivity and has a shorter duration of action than clonidine.<sup>(11,12)</sup>

## Materials and Method

The study was conducted after obtaining permission from ethical committee in Dhiraj Hospital, S.B.K.S.M.I. & R.C. in department of anesthesiology. 60 patients of ASA I and II were allocated in 2 groups (n=30 in each group). They were included in the study only after obtaining a written informed consent. **Group D1**(n=30) received 1 $\mu$ g/kg and **Group D0.5**(n=30) received 0.5 $\mu$ g/kg body weight of dexmedetomidine iv over a period of 10 minutes.

### Inclusion Criteria:

- Age between 18 years & 60 years
- ASA I and II.
- No known history of allergy, sensitivity to the study drugs
- Patient willing to sign informed consent.
- Mallampatti class I and II

### Exclusion Criteria:

- Patient's refusal.
- ASA III and IV
- Known case of heart blocks, sinus bradycardia and hypotension, autonomic neuropathy
- Patients on beta blocker drugs

- Mallampatti class III, IV & V
- Allergy to trial drugs.
- Nasogastric tube insertion
- Patient undergoing procedures requiring head and neck manipulation

Patients were explained about the procedure of general anaesthesia and a written informed consent was obtained from them. Pre-operatively patient's history, systemic examinations and routine investigations were carried out. HR, SBP and DBP were recorded preoperatively.

Tab alprazolam 0.5 mg was given on the previous night of surgery and patients were kept nil by mouth overnight. In operation theatre multipara monitor was applied and baseline HR, SBP, DBP, SpO<sub>2</sub> and ECG were recorded. Intravenous line was secured and iv fluid was started.

All patients were premedicated with inj. ondansetron 0.08mg/kg, inj. glycopyrrolate 0.004 mg/kg and inj. midazolam 0.05mg/kg iv. Group D1 received dexmedetomidine 1 $\mu$ g/kg iv diluted in 50 ml normal saline using syringe infusion pump over 10 minutes. Group D0.5 patients were given intravenous dexmedetomidine 0.5  $\mu$ g/kg iv diluted in 50 ml normal saline, using syringe infusion pump over 10 minutes.

After completion of dexmedetomidine infusion, patients were pre-oxygenated with 100% oxygen for 3 minutes. They were induced with 2.5% thiopentone sodium 5-7 mg/kg iv till the loss of eyelash reflex. Inj. succinylcholine 2mg/kg iv was given. Patients were intubated with appropriate sized cuffed endotracheal tubes. After checking the equal bilateral air entry endotracheal tube was fixed. Anaesthesia was maintained with oxygen and nitrous oxide (50%-50%), isoflurane and loading dose of inj. Atracurium iv 0.5mg/kg and after that intermittent dose of 0.1mg/kg.

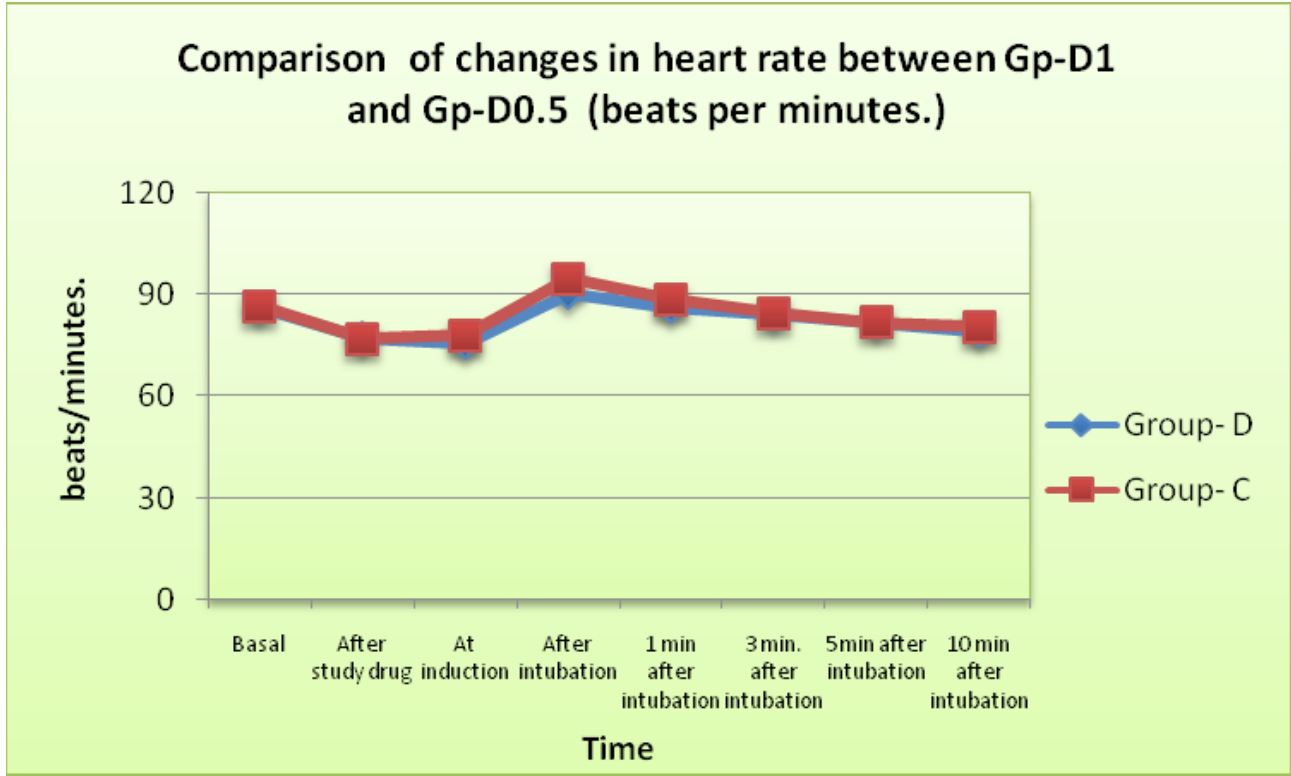
HR, SBP, DBP were recorded before giving the drug, just before induction of anaesthesia, during intubation and at 1 minutes, 3 minutes, 5 minutes, 10 minutes after intubation. After the surgical procedure was over, neuromuscular blockade was reversed with inj. neostigmine 0.05 mg/kg and inj. glycopyrrolate 0.008mg/kg iv. Once all recovery criteria were fulfilled trachea was extubated. Patients were monitored in the post-operative recovery room for 24 hours. They were observed for analgesia and side effects like nausea,

vomiting, sedation, respiratory depression, bradycardia and hypotension.

For age, weight, gender and ASA grade there was no statistically significant difference in patients of Group D1 and Group D0.5 ( $p > 0.05$ )

**Observation and Results**

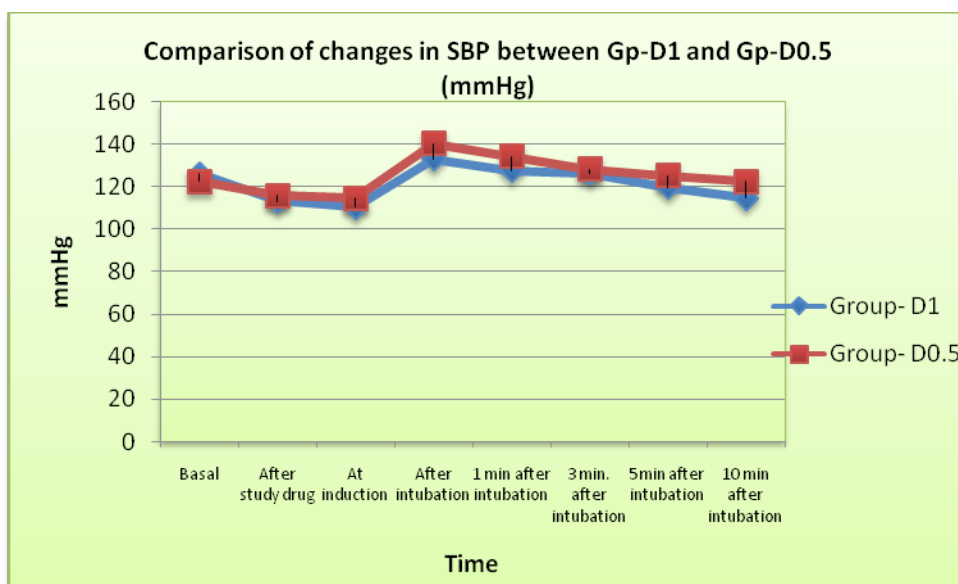
Statistical data were analyzed by using student’s unpaired t test.



**Graph 1: Showing Heart Rate at different time intervals in Group D1 and Group D0.5**

Mean HR in Group D1 was 86.27±1.447 per minutes and in Group D0.5 it was 86.23±2.027 per minutes at baseline level, which was comparable ( $p > 0.05$ ). There was fall in HR in both Group D1 and Group D0.5. HR further decreased at induction in both groups. Group D1 had 12.36% fall whereas Group D0.5 had 9.74% fall from baseline value. In Group D1 at intubation mean HR was 90.33±1.431 per minutes showing 4.70% rise, whereas in Group D0.5 it was 94.50±0.5023 per minutes with 9.59% rise. The difference in mean HR between two groups was statistically significant ( $p < 0.05$ ). Both groups

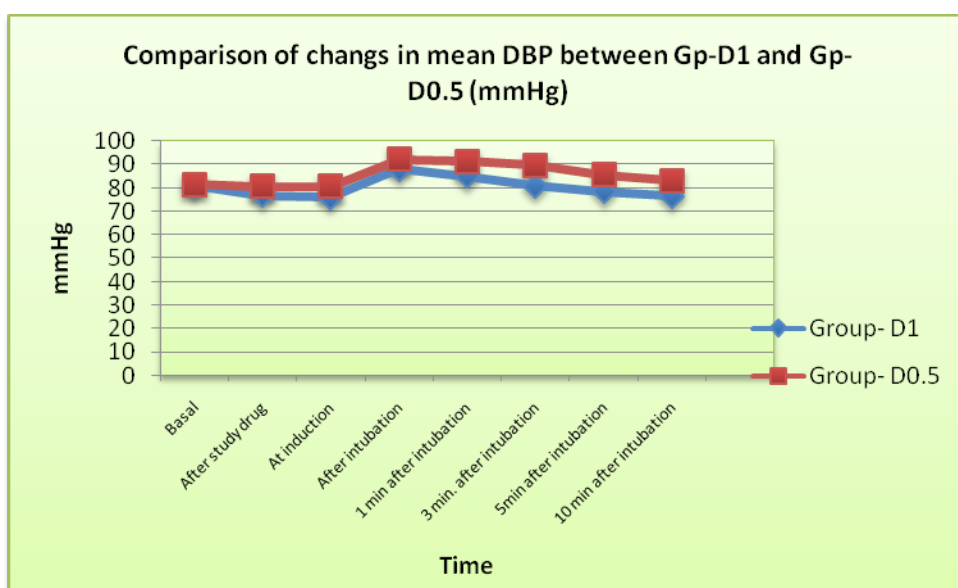
showed maximum rise in HR during intubation but immediately after intubation it started decreasing. Rate of fall was almost equal in both groups till 5 minutes post intubation. At 10 minutes after intubation HR reached to 79.10±1.892 per minutes in Group D1 with 9.06% fall and in Group D0.5 80.40±1.650 per minutes with 6.76% fall. Difference in mean HR between two groups at any time interval was statistically insignificant ( $p > 0.05$ ) except during intubation which was statistically significantly higher in group D1 than in group D0.5 ( $p < 0.05$ ).



**Graph 2: Mean SBP at different time interval in Group D1 and Group D0.5**

At baseline mean SBP in Group D1 was  $126.1 \pm 1.281$  mmHg and in Group D0.5 was  $122.5 \pm 1.189$  mmHg. There was fall in SBP from baseline value in both groups after study drug infusion and at induction but Group D1 had significant fall (12.7%) compared to Group D0.5 (6.19%) ( $p < 0.05$ ). During intubation in Group D1, it increased from  $126.1 \pm 1.281$  mmHg to  $133.1 \pm 0.913$  mmHg (5.55%) whereas in Group D0.5 it rose to  $140.3 \pm 1.283$  mmHg from  $122.5 \pm 1.189$  mmHg (14.53%). Difference in mean SBP between two groups

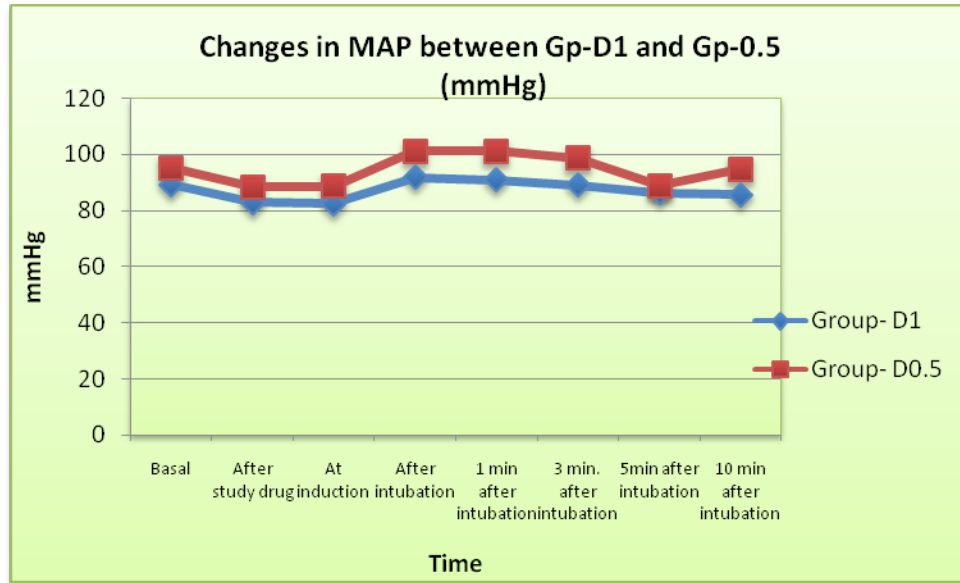
was statistically highly significant ( $p < 0.001$ ). SBP in both groups started falling immediately after intubation from its maximum level. In Group D1, at 5 minutes after intubation, SBP was below baseline value, whereas in Group D0.5 SBP remained higher than baseline value at 5 minutes and took 10 minutes to reach baseline value. Difference in SBP from 1 minute after intubation till 10 minutes post-intubation was statistically significant ( $p < 0.05$ ).



**Graph 3: Mean DBP at different time interval in Group D1 and Group D0.5**

At baseline mean DBP in Group D1 was  $80.87 \pm 1.679$  mmHg and in Group D0.5 it was  $81.53 \pm 1.049$  mmHg. DBP in both groups decreased after study drug infusion and after induction. The difference was statistically significant ( $p < 0.05$ ). There was maximum rise in DBP in both groups at intubation. In Group D1 it increased to  $88.07 \pm 1.270$  mmHg from its baseline value showing 8.9% rise whereas in Group D0.5 it went to  $92.00 \pm 0.996$  mmHg from basal DBP with 12.84% rise. This difference was statistically significant ( $p < 0.05$ ). Immediately after

intubation DBP in both groups started decreasing but the rate of fall in DBP in Group D1 was faster compared to Group D0.5 and at 3 minutes after intubation DBP in Group D1 was nearly same as baseline value. At 10 minutes post intubation DBP was  $76.53 \pm 1.028$  mmHg that was 5.36% lower than basal DBP, whereas in Group D0.5, DBP even at 10 minutes after intubation was higher than baseline DBP ( $83.13 \pm 1.137$  mmHg). Difference in mean DBP between two groups at any time interval except at baseline was statistically significant ( $p < 0.05$ ).



**Graph 4: Mean Arterial Pressure At Different Time Intervals Between Group D1 and Group D0.5**

Mean arterial pressure at baseline in Group D1 was  $95.94 \pm 0.848$  mmHg and in Group D0.5 it was  $95.52 \pm 0.925$  mmHg which was comparable ( $p > 0.05$ ). There was fall in MAP in both groups after study drug infusion and after induction, which was statistically highly significant ( $p < 0.001$ ). In Group D1 MAP increased to  $103.08 \pm 1.004$  mmHg during intubation with rise of 7.00% from baseline value whereas in Group D0.5, the rise was 13.17%. The difference was statistically highly significant ( $p < 0.0001$ ). In both groups after intubation MAP decreased from its maximum rise and in Group D1 at 3 minutes post intubation it reached to baseline level and at 10 minutes post intubation 7% lower than baseline level but in Group D0.5, it remained above basal value even 10 minutes after intubation. Difference in MAP between two groups remained highly significant from time of intubation, till 10 minutes after intubation ( $p < 0.0001$ ). Average dose of thiopentone used in Group D1 was  $412.5 \pm 26.0$  mg and in Group D0.5 it was

$448.3 \pm 30.9$  mg. The difference between two groups was statistically insignificant ( $p > 0.05$ ).

No side effects or complication were seen in any patients of either group.

### Discussion

Laryngoscopy and endotracheal intubation are perceived as intense events during general anaesthesia. They give rise to a transient, but marked sympathoadrenal response. Therefore controlling this perioperative stress response is pivotal goal of anaesthesia practice<sup>(13)</sup>. Various pharmacological & non pharmacological method were evaluated either in premedication or during induction to attenuate these adverse stress responses but no single anaesthetic technique is effective in completely abolishing these responses. The drugs used were either partially effective or were with adverse effects.<sup>(14)</sup>

Dexmedetomidine offers a unique pharmacological profile with sedation, sympatholysis, analgesia, cardiovascular stability by altering the stress induced sympathoadrenal responses to intubation during surgery & during emergence from anaesthesia. Presynaptic activation of  $\alpha_2$  adrenoceptor in the locus ceruleus in brain inhibits the release of nor epinephrine. In addition, the locus ceruleus is the site of origin for descending medullospinal noradrenergic pathway, known to be an important modulator of nociceptive neurotransmitter. Also, postsynaptic activation of  $\alpha_2$  receptors in the CNS results in decrease in sympathetic activity leading to fall in heart rate.

We compared the efficacy of dexmedetomidine at a dose of  $1\mu\text{g}/\text{kg}$  (Group D1) with  $0.5\mu\text{g}/\text{kg}$  (Group D0.5) when administered over 10 minutes before induction of anesthesia in 30 patients of each group. The groups were comparable with respect to demographic factors like age, weight, gender. Baseline heart rate was comparable in both the groups. After 10 minutes of dexmedetomidine infusion, there was fall in heart rate in both the groups, Group D1 > group D0.5. The fall continued even after induction in both the groups except during intubation. During intubation there was rise in heart rate in both the groups, Group D0.5 > Group D1. The difference being statistically significant ( $p < 0.05$ ).

**Sagiroglu A et al<sup>(15)</sup> in 2009 and Sunil et al<sup>(16)</sup> in 2012** compared the effect of dexmedetomidine at two different doses i.e.  $0.5\mu\text{g}/\text{kg}$  vs  $1\mu\text{g}/\text{kg}$  on attenuation of haemodynamic responses to laryngoscopy & intubation. They concluded that  $1\mu\text{g}/\text{kg}$  is better in obtunding hemodynamic response to laryngoscopy. **Thus** comparable with our study.

Our study results were also in accordance with the results of **Yildiz et al.<sup>(17)</sup> and Bijoy kumar panda et al<sup>(18)</sup>**. They too observed that dexmedetomidine when administered at a dose of  $1\mu\text{g}/\text{kg}$  was able to suppress the heart rate response to laryngoscopy. SBP, DBP and MAP were better managed in the group receiving dexmedetomidine  $1\mu\text{g}/\text{kg}$ .

**Sagiroglu A et al<sup>(15)</sup>** similarly observed that SBP, DBP and MAP values were lower post induction in both the groups of dexmedetomidine  $1\mu\text{g}/\text{kg}$  and  $0.5\mu\text{g}/\text{kg}$ , similar to the findings of our study. SBP and DBP were significantly lower at 60 seconds post intubation in dexmedetomidine  $1\mu\text{g}/\text{kg}$  as compared to dexmedetomidine  $0.5\mu\text{g}/\text{kg}$ .

**Yildiz et al<sup>(17)</sup>** also observed maximum increase in blood pressure immediately after intubation. During intubation increase in SBP in placebo group was 40% compared to 8% in the group of dexmedetomidine  $1\mu\text{g}/\text{kg}$ . Also increase in DBP was 25% in placebo group as compared to 11% in the group of dexmedetomidine  $1\mu\text{g}/\text{kg}$ .

The initial fall in blood pressure can be explained by peripheral  $\alpha_2$  adrenoceptors stimulation of vascular smooth muscles. The initial response is followed by further decrease in blood pressure. Both these effects are caused by inhibition of central sympathetic outflow overriding the direct stimulant effects.

Average requirement of thiopentone was noted during our study. The requirement was 8% less in the group receiving dexmedetomidine  $1\mu\text{g}/\text{kg}$  when compared to dexmedetomidine  $0.5\mu\text{g}/\text{kg}$ . The difference being not statistically significant ( $p > 0.05$ ). Similar to our findings, **Bijoykumar panda et al<sup>(18)</sup>** has also observed statistically insignificant reduced requirement of thiopentone in dexmedetomidine group ( $1\mu\text{g}/\text{kg}$ ) as compared to clonidine group ( $1\mu\text{g}/\text{kg}$ ).

There was no side effect noted in our study.

Similarly, **Shirsedu et al<sup>(19)</sup>** have also not found any instability of vitals either with clonidine or dexmedetomidine. They compared clonidine at  $2\mu\text{g}/\text{kg}$  with dexmedetomidine at  $1\mu\text{g}/\text{kg}$  given over 10 minutes, in patients undergoing general surgery.

**Bijoykumar panda et al<sup>(18)</sup>** found bradycardia in only 2 patients out of 60 patients, using dexmedetomidine  $1\mu\text{g}/\text{kg}$  when given over 10 minutes.

**Belleville et al<sup>(20)</sup>** found that dexmedetomidine which was given in 2 minutes at doses of  $1-2\mu\text{g}/\text{kg}$  cause irregular ventilation and apnea episodes. Irregular breathing seen with high dose of  $1-2\mu\text{g}/\text{kg}$  probably related to deep sedation and anatomical features of the patient.

Such side effects were not seen in our study thus making dexmedetomidine at dose of  $1\mu\text{g}/\text{kg}$  and  $0.5\mu\text{g}/\text{kg}$  when given over 10 minutes to be free of side effects.

## Conclusion

Dexmedetomidine at dose of  $1\mu\text{g}/\text{kg}$  significantly attenuated the sympathetic response of laryngoscopy and intubation and also at dose of  $0.5\mu\text{g}/\text{kg}$  reduced the



pressor response, but its effect was lesser than that of dexmedetomidine 1 µg/kg. Thus this study showed that dexmedetomidine 1 µg/kg is superior to dexmedetomidine 0.5 µg/kg in the attenuation of hemodynamic response to laryngoscopy and endotracheal intubation with no side effects. Dexmedetomidine is helpful in decreasing the requirement of anaesthetic agent for induction.

**Conflict of Interest:** Nil

**Source of Funding:** Self

**Ethical Clearance:** Taken from Sumandeep Vidyapeeth Institutional Ethics Committee (SVIEC).

### References

- Derbyshire DR, Chmielewski A, Fell D, Vater M, Achola K, Smith G. Plasma catecholamine responses to tracheal intubation. *BJA*, 1983; 55: 855-60
- Fox EJ, Sklar GS, Hill CH, et al. Complications related to pressor response to endotracheal intubation. *Anesthesiology*, 1977; 47: 524-25
- King BD, Harris LC, et al. Reflex circulatory responses to direct laryngoscopy and tracheal intubation performed during general anaesthesia. *Anesthesiology*, 1951; 12:556-566
- Charuluxananan S, Kyokong O, Somboonviboon W, Balmongkon B, Chaisomboonpan S. Nicardipine versus lidocaine for attenuating the cardiovascular response to endotracheal intubation. *J Anesth* 2000;14:77-81.
- Menda F, Koner O, Sayin M, Ture H, Imer P, Aykac B. Dexmedetomidine as an adjunct to anesthetic induction to attenuate hemodynamic response to endotracheal intubation in patients undergoing fast-track CABG. *Ann Card Anaesth* 2010;13:16-21.
- Gunes Y, Gunduz M, Ozcengiz D, Ozbek H, Isik G. Dexmedetomidine-remifentanyl or propofol-remifentanyl anesthesia in patients undergoing intracranial surgery. *Neurosurg Q* 2005;15:122-6.
- Powroznyk A, Vuylsteke A, Naughton C, Misso S, Holloway J, Jolin-Mellgard A, et al. Comparison of clevidipine with sodium nitroprusside in the control of blood pressure after coronary artery surgery. *Eur J Anaesth* 2003;20:697-703.
- Abou-Arab MH, Heier T, Caldwell JE. Dose of alfentanil needed to obtain optimal intubation conditions during rapid-sequence induction of anaesthesia with thiopentone and rocuronium. *Br J Anaesth* 2007;98:604-10.
- Aantaa R, Scheinin M.  $\alpha$ -2-adrenergic agents in anesthesiology. *Acta Anaesthesiol Scand* 1993;37:433-48.
- Quintin L, Bonnet F, Macquin I. Aortic surgery: Effect of clonidine on intraoperative catecholaminergic and circulatory stability. *Acta Anaesthesiol Scand* 1990;34:132-7.
- Virtanen R, Savola J, Nyman L. Characterization of the selectivity, specificity and potency of medetomidine as an  $\alpha$ -2 adrenoceptor agonist. *Eur J Pharmacol* 1988:9-14.
- Scheinin H, Virtanen R, MacDonald E, Lammintausta R, Scheinin M. Medetomidine-a novel  $\alpha$ -2-adrenoceptor agonist: A review of its pharmacological effects. *Prog Neuro-Psychopharmacol Biol Psychiatry* 1989;13:635-51.
- Kunisawa T, Nagata O, Nagashima M, Mitamura S, Ueno M, Suzuki A, et al. Dexmedetomidine suppresses the decrease in blood pressure during anaesthetic induction and blunts the cardiovascular responses to tracheal intubation. *Journal of Clin Anaesth* 2009; 21:194-9.
- Sukhminatesder JS, Kaur J, Singh A, Parmar SS, Singh G, Kulshrestha A, et al. Effects of Dexmedetomidine on hemodynamic response to intubation, surgery and extubation and effects on dose of opioids and isoflurane during anaesthesia. *Indian Journal of Anaesthesia* May 2012;56(2) 123-128.
- Sagiroglu A, Celik M, Orhonv Z, Yüzer S, Sen B. Different doses of Dexmedetomidine on controlling haemodynamic responses to tracheal intubation. *The Internet Journal of Anesthesiology*. 2009;27:2.
- Sunil N., Dhanpal R. The effect of intravenously administered dexmedetomidine on hemodynamic response to intubation in patients undergoing surgery under general anesthesia.
- Yildize M, Tavlan A, Tuncer S, Reisli R, Yosunkaya A, Otelcioglu. Effect of dexmedetomidine on haemodynamic responses to laryngoscopy and intubation: perioperative haemodynamics and anaesthetic requirements. *Drugs RD* 2006; 7(1):43-52.
- Bijoy Kumar Panda, Priyanka Singh, Sourabh Marne, Atmaram Pawar, Varshali Keniya,

- Sushma Ladi, Sarita Swami. A Comparison study of Dexmedetomidine vs Clonidine for sympathoadrenal response, perioperative drug requirements and cost analysis. *Asian Pacific Journal of Tropical Disease*(2012);1-6
19. Shirsendu Mondal, Hindol Mondal, Ritaban Sarkar, Musfikur Rahaman. Comparison of dexmedetomidine and clonidine for attenuation of sympathoadrenal responses and anesthetic requirements to laryngoscopy and endotracheal intubation. *Int J Basic Clin Pharmacol.* 2014; 3(3): 501-506.
20. Bellevillie JP, Ward DS, Bloor BC, Maze M. Effects of intravenous dexmedetomidine in humans in sedation, ventilation and metabolic rate. *Anaesthesiology* 1992; 77:1134-42.

# Favipiravir, will it be the Answer for the Specific Management of COVID-19?: A Review

Jayant Patharkar<sup>1</sup>, Maulin Mehta<sup>2</sup>, Janhavi Patharkar<sup>3</sup>

<sup>1</sup>Assistant Professor, <sup>2</sup>Associate Professor, Department of Pharmacology, Smt. B.K. Shah Medical Institute & Research Centre, Sumandeep Vidyapeeth Deemed to be University, At. & Post. PIPARIA, Tal. Waghodia, Dist. Vadodara-391760, Gujarat State, <sup>3</sup>Assistant Professor, Department of Kayachikitsa, Parul Institute of Ayurved, At. & Post. Limda, Tal. Waghodia, Dist. Vadodara-391760, Gujarat state.

## Abstract

**Background:** The COVID-19 has created havoc all over the world as no specific treatment available till date. Total COVID-19 cases had crossed 11,125,245 including 528,204 deaths as per the WHO data till 5 July 2020. Unfortunately, India secured third place in total tally of COVID-19 cases with 6,77,719 total cases including 19693 deaths as of 5<sup>th</sup> July 2020. The antiviral drug, Favipiravir, previously known as T-705 approved in Japan for treatment of Influenza. It is selective & potent inhibitor of viral RNA polymerase. It is promising drug for treatment of wide range of RNA viruses including SARSCoV-2.

**Method:** The systematic review of Articles was done with the help of search engines like Embase, Medline, PubMed & Google Scholar, clinicaltrials.gov. The Peer reviewed articles published through 6<sup>th</sup> of July 2020 were included in the study. This review was done to establish clinical evidence for use of Favipiravir in COVID-19.

**Conclusion:** It was found that due to lack of conclusive evidence, Favipiravir cannot be included in main armamentarium for COVID-19.

**Keywords:** COVID-19 management, clinical trials review, Favipiravir, repurpose drug.

## Introduction

The COVID-19 has created havoc all over the world as no specific treatment available till date. Total COVID-19 cases had crossed 11,125,245 including 528,204 deaths as per the WHO data till 5 July 2020<sup>[1]</sup>. Unfortunately, India secured third place in total tally of COVID-19 cases with 6,77,719 total cases including 19693 deaths as of 5<sup>th</sup> July 2020<sup>[2]</sup>.

The antiviral drug, Favipiravir, previously known as T-705 approved in Japan for treatment of Influenza. It is prodrug of a purine nucleotide i.e. Favipiravir ribofuranosyl-5'-triphosphate. It is selective & potent inhibitor of viral RNA polymerase. Thus, it halts the viral replication. It is effective against all strains of influenza viruses. It is promising drug for treatment of wide range of RNA viruses including SARSCoV-2<sup>[3,4]</sup>.

At present, there is no robust evidence from randomised clinical trials (RCTs), that specific drug or treatment will improve the patient outcome of COVID-19. Thus, various treatment modalities, repurposed or experimental drugs are under the clinical trials for establishing evidence based specific treatment for novel corona virus epidemic. The repurposed drugs under such clinical trials are Chloroquine phosphate, hydroxychloroquine sulfate, Lopinavir/ritonavir, Umifenovir (Arbidol), Remdesivir, Favipiravir, Tocilizumab<sup>[5]</sup>.

---

### Corresponding Author:

#### Dr Jayant T Patharkar

Assistant Professor, Department of Pharmacology,  
Smt. B.K. Shah Medical Institute & Research Centre,  
Sumandeep Vidyapeeth Deemed to be University, At.  
& Post. Piparia, Tal. Waghodia, Dist. Vadodara-391760,  
Gujarat State

e-mail: jayant.patharkar@gmail.com

Mob No.: 7046519567

Hence, this review was proposed for Favipiravir, to understand current & future prospect of this promising antiviral drug by summarizing various clinical trials, studies & analysing the outcome of these studies.

### Method

The systematic review of Articles was done with the help of search engines like Embase, Medline, PubMed & Google Scholar, clinicaltrials.gov. The Peer reviewed articles published through 6<sup>th</sup> of July 2020 were included in the study. The Search words used in combinations included; COVID-19, Favipiravir, Antiviral, COVID-19 specific treatment options, repurposed drugs, Randomized Clinical Trials (RCTs)

All the studies, randomized clinical trials, cohort, prospective, metanalysis, review was included in for the review, keeping the goal as to ascertain the role of Favipiravir in the management of COVID-19.

### Results

#### Various studies conducted for COVID-19 patients treated with Favipiravir:

1. The Clinical Trials gov Identifier: NCT04349241 by Hany Dabbous, Ain Shams University in 2020, sample size was 100 & intervention was Favipiravir. The out come of this trial is not available
2. A Randomized Clinical Trial: Favipiravir versus Arbidol for COVID conducted by Chang Chen, Ping Yin, Yi Zhang, Jianying Huang et al. in 240, sample size was 240 & intervention was Favipiravir, Arbidol. In this trial they found that Favipiravir significantly improved the latency to relief for fever and cough.
3. An Open-Label Control Study for COVID: Experimental Treatment with Favipiravir by Cai a Qingxian,y, Minghui Yang a,y, Dongjing Liu a,y, Jun Chen a,y, Dan Shu a, Junxia Xia a, Xuejiao in the year 2020. The sample size was 80 with intervention used Favipiravir (FPV) versus Lopinavir (LPV)/ritonavir (RTV). In this study significant difference observed ( $p=0.004$ ) in radiological parameters like chest imaging when favipiravir used against control group.
4. The ClinicalTrials.gov Identifier: NCT01068912 conducted by MDVI, LLC in year 2015, in sample of 530, wherein they used Favipiravir against placebo comparator. In this trial they found that the Adverse

drug reactions, deaths were not seen in influenza patients when favipiravir used & it was proved to be effective for different doses.

5. The ClinicalTrials.gov Identifier: NCT02026349 by MDVI, LLC in 2015 among 860 patients found that the patients of influenza were cured of symptoms like temperature without any untoward side effects with favipiravir.
6. The Clinical trial, Identifier: NCT04376814 conducted by Baqiyatallah Medical Sciences University among 40 patients, wherein favipiravir compared with another arm having Hydroxychloroquine, Lopinavir/Ritonavir. The result of this trail was not reported.
7. The Bioequivalence Study of Favir 200 mg Film Tablet Kocak Under Fasting conditions, Clinical trials gov Identifier NCT04444986 by Kocakfarma in 2020 among 30 patients using Favir 200 mg FT against Avigan 200 mg FT. The result of study was not reported.
8. A Review: Pharmacologic Treatments for Coronavirus Disease 2019 was conducted by James M. Sanders, L. Monogue, Marguerite et al. in 2020 found that no therapies have been shown effective to date.
9. A systematic review and meta-analysis: Efficacy and safety of antiviral treatment for COVID-19 from evidence in studies of SARSCoV-2 and other acute viral infections conducted by Wei Liu, Pengxiang Zhou, Ken Chen, Zhikang Ye, Fang Liu, et al. in 2020 found that presently no existing antiviral treatment beneficial.
10. A Review Pharmacological Therapeutics Targeting RNA-Dependent RNA Polymerase, Proteinase and Spike Protein: From Mechanistic Studies to Clinical Trials by JianshengHuang, Hui Huang Wenliang Song in 2020 commented that with the development of potent & effective RdRp inhibitors will be useful in SARS-CoV-2 therapy.

### Discussion

The Favipiravir, repurposed drug for COVID-19 treatment. It has been the approved drug for use in the influenza in Japan. Favipiravir is a prodrug which is converted intracellularly into phosphoribosylated form-active form. This active form is recognized as a substrate by the viral RNA-dependent RNA polymerase. & replication of virus can be prevented<sup>[6]</sup>.

In the Clinical trials registries, total 21 studies have been registered for use of Favipiravir in COVID-19 patients. Out of these studies three studies are completed & only two studies result has been published. Out of these two studies, the multi-centric phase II trial (NCT01068912), has shown clinical efficacy of Favipiravir in Influenza. This study also posted that the clinical efficacy can be seen in low-dose as well as high-dose regimens, no serious adverse events has been witnessed<sup>[7]</sup>. In another study, which posted result (NCT02026349), it was noted that favipiravir could reduce symptoms and fever could be subsided without any adverse events<sup>[8]</sup>.

In the randomized controlled trial conducted by Chang Chen et al. in March 2020, found that the patient had relieved of pyrexia & cough in short span of time with Favipiravir significantly, but no significant change has been seen in clinical recovery rate as compared to Arbidol.

An Open-Label Control Study conducted with favipiravir & control arm with Lopinavir/ritonavir in COVID-19 patients elucidated that radiological improvement seen when viral load was reduced early. It is noteworthy that less adverse events occurred with Favipiravir than control arm having Lopinavir (LPV)/ritonavir (RTV). In this trial treatment Favipiravir given orally (200 mg per tablet), dose 1600 mg two times in a day on first day & two times in a day for next thirteen days. The Lopinavir (200 mg)/Ritonavir (50 mg) were taken through enteral route, two tablets each two times in a day. On first day & then maintained for next thirteen days two times in a day<sup>[9]</sup>. Thus, in this study, efficacy in reducing viral load as well as safety of favipiravir over Lopinavir/ritonavir can be ascertained in the patients of COVID-19.

A treatment review by James M. Sanders et al. of Coronavirus disease found that, the preclinical data obtained about favipiravir was from its activity against influenza & Ebola virus. In Vero E6 cells, in vitro studies, the EC<sub>50</sub> of favipiravir against SARSCoV-2 was 61.88 µM/L<sup>[10]</sup>. The doses would differ according to type of infection. Thus, for COVID-19, higher dosing range was selected i.e. a maintenance dose (1200 mg to 1800 mg every 12 hours) after loading dose (2400 mg to 3000 mg every 12 hours × 2 doses)<sup>[11,12]</sup>. Favipiravir is being used in influenza in Japan but it is not available in the united states. Thus, to establish the evidence for use of favipiravir in the SARSCo-2, more RCTs has to be conducted in near future<sup>[5]</sup>.

A systematic review & meta-analysis about the efficacy & safety of antiviral drugs in COVID-19, stated that there is no evidence present currently to confirm important benefits of antiviral treatment but still did not strike out important benefits of individual antiviral agent<sup>[13]</sup>.

Jiansheng Huang revived about target proteins like RNA-Dependent RNA Polymerase, spike proteins & proteinase in various clinical trials and studies being conducted during this COVID-19 pandemic and on the basis of mechanism of replication of SARS-CoV-2 RNA-Dependent RNA Polymerase, found that effective & potent RdRp inhibitors may play key role in the treatment of COVID-19<sup>[14]</sup>. At present Favipiravir, inhibitor of RNA polymerase is used for influenza in Japan. However, the safety issue about favipiravir should be kept in mind because of its teratogenic risk though this broad-spectrum antiviral seems promising.

## Conclusion

The Favipiravir, repurpose drug, had shown promising results in COVID-19 in few of the studies but vast majority of clinical trials are ongoing. Hence at this juncture, it will be overambitious to put Favipiravir as front warrior against COVID-19. Thus, due to lack of conclusive evidence, Favipiravir cannot be included in main armamentarium for COVID-19.

**Research funding:** None

**Financial support and sponsorship:** Nil

**Conflict of Interest:** None

**Ethical Clearance:** It was obtained from Sumandeep Vidyapeeth Institutional Ethics Committee before starting the study.

## References

1. The current cases of COVID-19 in the world, <https://covid19.who.int/> (Accessed on 6<sup>th</sup> July 2020)
2. The current cases of COVID-19 in India, <https://www.mygov.in/covid-19> (Accessed on 6<sup>th</sup> July 2020)
3. Furuta Y, Takahashi K, Kuno-Maekawa M, Sangawa H, Uehara S, Kozaki K, Nomura N, Egawa H, Shiraki K. (2005) Mechanism of action of T-705 against influenza virus. *Antimicrobial agents and chemotherapy.*;49(3):981-986.

4. Furuta Y, Gowen BB, Takahashi K, Shiraki K, Smee DF, Barnard DL.(2013) Favipiravir (T-705), a novel viral RNA polymerase inhibitor. *Antiviral research.* 2013 Nov 1;100(2):446-54.
5. Sanders JM, Monogue ML, Jodlowski TZ, Cutrell JB. Pharmacologic treatments for coronavirus disease 2019 (COVID-19): a review. *Jama.* 2020 May 12;323(18):1824-36.
6. Delang L, Abdelnabi R, Neyts J. Favipiravir as a potential countermeasure against neglected and emerging RNA viruses. *Antiviral research.* 2018 May 1; 153:85-94.
7. [https://clinicaltrials.gov/ct2/results?cond=COVID-19 & term=Favipiravir](https://clinicaltrials.gov/ct2/results?cond=COVID-19&term=Favipiravir) (Accessed on 7<sup>th</sup> july 2020)
8. Khambholja K, Asudani D. Potential repurposing of Favipiravir in COVID-19 outbreak based on current evidence. *Travel Medicine and Infectious Disease.* 2020 Apr 28, 35: 101710.
9. Cai Q, Yang M, Liu D, Chen J, Shu D, Xia J, Liao X, Gu Y, Cai Q, Yang Y, Shen C. Experimental treatment with favipiravir for COVID-19: an open-label control study. *Engineering.* 2020 Mar 18.
10. Wang M, Cao R, Zhang L. Remdesivir and chloroquine effectively inhibit the recently emerged novel coronavirus (2019 nCoV) in vitro [published online February 4, 2020]. *Cell Res.*30;pages269–271
11. Mentré F, Taburet AM, Guedj J, Anglaret X, Keïta S, de Lamballerie X, Malvy D. Dose regimen of favipiravir for Ebola virus disease. *The Lancet Infectious Diseases.* 2015 Feb 1;15(2):150-1.
12. Sissoko D, Laouenan C, Folkesson E, M'lebing AB, Beavogui AH, Baize S, Camara AM, Maes P, Shepherd S, Danel C, Carazo S. Experimental treatment with favipiravir for Ebola virus disease (the JIKI Trial): a historically controlled, single-arm proof-of-concept trial in Guinea. *PLoS medicine.* 2016 Mar 1;13(3):e1001967.
13. Liu W, Zhou P, Chen K, Ye Z, Liu F, Li X, He N, Wu Z, Zhang Q, Gong X, Tang Q. Efficacy and safety of antiviral treatment for COVID-19 from evidence in studies of SARSCoV-2 and other acute viral infections: a systematic review and meta-analysis. *CMAJ.* July 06, 2020 192 (27) E734-E744
14. Huang J, Song W, Huang H, Sun Q. Pharmacological therapeutics targeting RNA-dependent RNA polymerase, proteinase and spike protein: from mechanistic studies to clinical trials for COVID-19. *Journal of Clinical Medicine.* 2020 Apr;9(4):1131.

# Glycemic Control of Non-Hodgkin Lymphoma (NHL) Non-Diabetes Mellitus (DM) Patient in the First CHOP Chemotherapy

Jualita Heidy Saputri<sup>1</sup>, Hermina Novida<sup>2</sup>, Ami Ashariati<sup>3</sup>

<sup>1</sup>Resident, Department of Internal Medicine, Dr. Soetomo Teaching Hospital, Airlangga University Faculty of Medicine, Indonesia, <sup>2</sup>Lecturer, Division of Endocrinology, Diabetes, and Metabolism, Department of Internal Medicine, Dr. Soetomo Teaching Hospital, Airlangga University Faculty of Medicine, Indonesia, <sup>3</sup>Professor, Division of Medical Oncology, and Hematology, Department of Internal Medicine, Dr. Soetomo Teaching Hospital, Airlangga University Faculty of Medicine, Indonesia

## Abstract

Non-Hodgkin's lymphoma (NHL) chemotherapy is cyclophosphamide, doxorubicin, vincristine, and prednisone (CHOP) have hyperglycemia side effects that affect the success of chemotherapy. Improved glycemic control decreases morbidity and mortality. Determine the glycemic control changes in non-DM NHL patients before and the sixth day after the first CHOP chemotherapy.

**Method:** Prospective longitudinal observational analytic study in the Internal Medicine Inpatient Unit Dr. Soetomo Teaching Hospital Surabaya, involved all the first CHOP chemotherapy NHL patients during November 2019-February 2020. A total of 21 patients met chemotherapy requirements and were not DM. The glycemic control check uses the hexokinase method and a glucometer (Easy Touch®). Data analysis using the Wilcoxon test was considered significant if  $p < 0.05$ .

**Results:** Total research subjects were 21 people, female domination (66.7%), mean age  $49.24 \pm 13.96$  years, clinical stage 3 dominance (52.38%), mean HbA1C  $5.75 \pm 0.49\%$ , average FBG  $90.86 \pm 13.13$  mg/dL, the mean PPBG  $114.33 \pm 20.16$  mg/dL. Daily blood glucose levels during chemotherapy were highest on the first day's pre-dinner. There were significant differences in FBG and PPBG before chemotherapy and the sixth day after chemotherapy ( $p$ -values 0.032 and 0.002). The incidence of new-onset DM on the sixth day after the first CHOP chemotherapy was 2 subjects (9.53%).

**Conclusion:** There was an increase in FBG and PPBG of NHL non-DM patients before and the sixth day after the first CHOP chemotherapy.

**Keywords:** NHL, DM, CHOP.

## Introduction

Malignant lymphoma is the primary malignancy of lymph nodes and lymphoid tissue. Based on the presence

of Reed-Sternberg cells, they are divided into Hodgkin's lymphoma (HL) and non-Hodgkin's lymphoma (NHL)<sup>1</sup>. One of the ten most severe malignancies in the world is malignant lymphoma with a prevalence of 3.37%. Its incidence worldwide has increased by 3-4% in the last 4 decades with the incidence of NHL 6% in men and 4.1% in women<sup>1-2</sup>. In America there are 74,200 new cases (4.2%), 19,970 (3.3%) of whom died from NHL, and life expectancy for the next 5 years by 72%<sup>3</sup>. Ministry of Health of the Republic of Indonesia in 2013, the incidence of lymphoma in Indonesia was 0.06% with an estimated 14,905 patients and 2,296 of them were

---

### Corresponding Author:

**Dr. Hermina Novida**

Lecturer, Division of Endocrinology, Diabetes, and Metabolism, Department of Internal Medicine, Dr. Soetomo Teaching Hospital, Airlangga University Faculty of Medicine, Indonesia  
e-mail: herminanovida@gmail.com

from East Java Province<sup>1</sup>. This data shows that NHL is a common malignancy with sufficient mortality and high life expectancy. Therapeutic modalities in NHL patients are chemotherapy and radiation. The choice of first-line chemotherapy is a combination of cyclophosphamide, doxorubicin, vincristine, and prednisone (CHOP)<sup>4-5</sup>.

One of side effect CHOP chemotherapy is hyperglycemia<sup>5-6</sup>. Hyperglycemia is a condition of an increase in blood glucose more than normal that can progressively become a metabolic disease (diabetes mellitus/DM). A 2013 Japanese study stated that 32.5% of patients with NHL without a history of DM who received CHOP chemotherapy will become DM<sup>7</sup>. In the same year, a study in Mexico revealed 40.6% of the DM's incidence in NHL patients and acute lymphoblastic leukemia due to the use of high-dose glucocorticoids associated with chemotherapy<sup>8</sup>. In 2018, research in the USA stated that 47% of NHL patients experienced episodes of hyperglycemia in the first week after RCHOP or REPOCH chemotherapy<sup>9</sup>.

Hyperglycemia is influential on the quality of human resources and has an impact on a significant increase in health costs<sup>10-11</sup>. Chemotherapy-related hyperglycemia can cause acute complications in the form of infections, sepsis, ketoacidosis (3.6%), hyperosmolar non-ketotic (7.2%), acute hyperglycemia syndrome, and dehydration<sup>11-15</sup>. In addition, hyperglycemia can affect the result of chemotherapy, the rate of cancer recurrence, and resistance to chemotherapy agents. Blood glucose control during chemotherapy is important in terms of success chemotherapy, life expectancy of cancer patients, reducing morbidity, mortality, and affects decreasing health insurance financing<sup>13-14,17</sup>. Components assessed were glycemic control in the form of fasting blood glucose (FBG) and 2 hours postprandial blood glucose (PPBG) when the patient was before chemotherapy and evaluated after getting the first CHOP chemotherapy.

## Material and Method

This was a prospective observational study with pre and posttest design. The population of this study was NHL patients who have been diagnosed and come for chemotherapy in the internal medicine ward of Dr. Soetomo general hospital, Surabaya. Sample size

calculated from the following formula:  $n = \left[ \frac{(Z_{\alpha} + Z_{\beta})s}{x_1 - x_2} \right]^2$ , which standard deviation from the previous study was 0.64 and a confidence interval of 95% therefore, a minimum of 17 subjects needed. Subjects were recruited

totally. Subjects with DM type 2 in the first screening, under certain medication (corticosteroid, antioxidant), had an adverse event or serious adverse event during the procedure, or refuse to join this study were excluded from this study. All cases included in this study were subjected to complete informed consent, clinical history, clinical evaluation, sampling blood vein, and capillary blood. Three mL blood vein samples were collected from the subjects in the morning (8 – 10 a.m.), under fasting conditions for at least 8 hours for FBG, lipid profile, and HbA1C. Then subjects had breakfast, fasting again in 2 hours, and 3 mL blood vein samples were collected again for PPBG. This procedure in a day before chemotherapy (the first-day) and the sixth-day chemotherapy. During the procedure of chemotherapy, the subject had capillary blood sampling 15-30 minutes before breakfast, lunch, dinner, and bedtime.

Glycemic control was an examination of glucose levels consisting of fasting blood glucose (FBG) and 2-hour postprandial blood glucose (PPBG)<sup>10</sup>. Pre-meal (before breakfast, lunch, and dinner) and bedtime glucose were also components of glycemic control will be examined in this study. If in the duration of the study an increase in blood glucose is found, it will be consulted to the endocrine, metabolic, and diabetic divisions to determine whether DM or not and to determine whether interventions that are following the IEA 2019 standards are to be followed throughout the study period.

Fasting blood glucose (FBG) is a glucose level that is checked in fasting for 8 hours. Normal result if less than 100 mg/dL. Postprandial blood glucose (PPBG) is a glucose level that is checked in the condition after eating in regular portions (equivalent to 75 grams of glucose) and followed by fasting for 2 hours. Normal result if it is less than 140 mg/dL. HbA1C is the level of glycated hemoglobin in the blood that is examined in a state of fasting for 8 hours. Normal result if it is less than 5.7%. Prediabetes if obtained FBG 100-125 mg/dL, PPBG 140-199 mg/dL, and/or HbA1C 5.7-6.4%. DM if FBG > 126 mg/dL, PPBG > = 200 mg/dL, and/or HbA1C > = 6.5%<sup>10</sup>. Venous blood sampling was around 3 mL and processed using a *Dimension Exl* device with the hexokinase method in the clinical pathology laboratory Dr. Soetomo Surabaya.

Pre-meal glucose levels are glucose levels that are checked 15-30 minutes before a large meal in the morning, afternoon, and evening. Glucose bedtime is a glucose level that is checked before going to bed at



night. Results are considered normal when 80-99 mg/dL in non-DM individuals<sup>18</sup>. Data were obtained from supporting examinations in the form of capillary blood collection which were processed using an *Easy Touch*<sup>®</sup> glucometer.

CHOP chemotherapy (cyclophosphamide/doxorubicin/vincristine/prednisone) is the first-line regimen for NHL patients recommended by the Ministry of Health and/or NCCN for NHL patients for the first time. Doses given cyclophosphamide 750 mg/m<sup>2</sup> body surface area (BSA)/day/intravenously, doxorubicin 50 mg/m<sup>2</sup> BSA/day/intravenously, vincristine 1.4 mg/m<sup>2</sup> BSA/day/intravenously for the first day, and prednisone 60 mg/m<sup>2</sup> BSA/day/orally for 5 days per cycle<sup>4-5</sup>. Premedication was given before chemotherapy includes dexamethasone 10 mg intravenously, diphenhydramine 10 mg intravenously, and ondansetron 8 mg intravenously. Intravenous chemotherapy agents are given in the afternoon. Prednisone is given on the first day at 5.00 p.m. On days 2, 3, 4, and 5 prednisone is given at 7.00 a.m.

Chemotherapy requirements include performance status with a karnofsky score of more than 60%, hemoglobin more than 10 g/dL, leukocytes more than 4,000/mL, platelets more than 100,000/mL, serum transaminases are not more than 1.5 times the normal price, albumin is more than or equal to 2.5 g/dL, creatinine clearance of more than 70 mL/min<sup>19</sup>. Besides, research subjects were also screened for HIV infection, hepatitis B and Cvirusesinfection, and tuberculosis infections.

Statistical analysis performed using SPSS for Windows version 22.0. Univariate analysis performed to describe the characteristics of the subjects. Bivariate analysis performed using T-tests if data is normally distributed otherwise, the Wilcoxon test will be used. The normality test performed using the Shapiro-Wilk test.

## Results

The total number of NHL patients who received the first CHOP chemotherapy during the period November 2019 - February 2020 and met the inclusion criteria was 21 patients. Subjects were dominated by female sex (66.7%), while male sex was 33.3%. The average age of the study subjects was 49.24 ± 13.96 years. In men, the average waist circumference is 86 ± 5.89 cm. In women, the average waist circumference was 94.14 ± 16.31 cm. The average body mass index (BMI) was 23.45 ± 4.72 kg/m<sup>2</sup> with the domination of normal BMI was 7 subjects (33.3%). The dominance of NHL clinical stage 3 based on Ann Arbor was 11 people (52.38%). Median total cholesterol is 163 mg/dL, median triglyceride is 136 mg/dL, median HDL is 34 mg/dL, and mean LDL is 108.52 ± 20.92 mg/dL. Characteristics of HbA1C with an average of 5.75 ± 0.49%. The average research subject's FBG and PPBG was 90.86 ± 13.13 mg/dL and 114.33 ± 20.16 mg/dL. Risk factors for increased glycemic control include overweight - obesity by 8 subjects, dyslipidemia by 15 subjects, hypertension by 5 subjects, and smokers by 3 subjects.

**Table 1. General characteristics of the subjects**

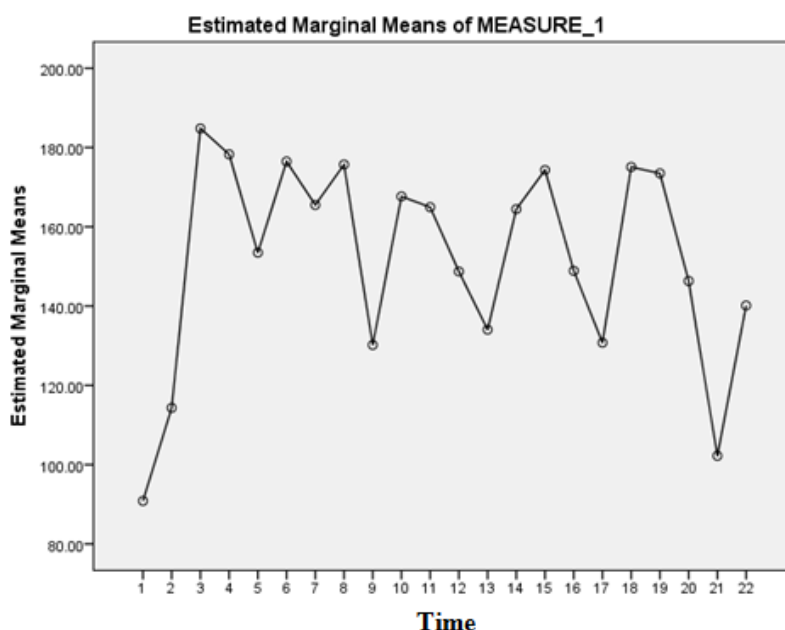
Characteristic		n (%)	Average ± SD*	Median**	Range
Gender*	Male	14 (66,7)			
	Female	7 (33,3)			
Age**	18-60 years	18 (85,7)	49,24 ± 13,96		27-77
	More than 60 years	3 (14,3)			
Waist Circumferences*	Female		94,14 ± 16,31		65-122
	Less than 80 cm	2 (14,3)			
	More than 80 cm	12 (85,7)			
	Male		86 ± 5,89		80-96
	Less than 90 cm	5 (71,4)			
	More than 90 cm	2 (28,6)			

Characteristic		n (%)	Average ± SD*	Median**	Range
Body Mass Index (BMI)*	Less than 18,5 Kg/m <sup>2</sup>	5 (23,8)	23,45 ± 4,72		16-35,4
	18,5 – 25,0 Kg/m <sup>2</sup>	8 (38,1)			
	25,0 – 30,0 Kg/m <sup>2</sup>	7 (33,3)			
	More than 30 Kg/m <sup>2</sup>	1 (4,8)			
Clinical Staging of NHL*	Stage I	2 (9,52)			
	Stage II	7 (33,33)			
	Stage III	11 (52,38)			
	Stage IV	1 (4,76)			
Lipid Profile	Choleteroltotal*			163	121-304
	Trigliserida*			136	45-478
	HDL*			34	14-156
	LDL**		108,52 ± 20,92		74-140
HbA1C**			5,75 ± 0,49		4,6-6,4
FBG**			90,86 ± 13,13		73-122
PPBG**			114,33 ± 20,16		85-155

The effect of chemotherapy on FBG and PPBG levels in this study was statistically significant (p = 0.032 and p = 0.002) with a significance level of 5%. In our study, the average increase in FBG was 177.5 ± 28.99 mg/dL and PPBG 239.5 ± 58.69 mg/dL.

**Table 2. Characteristics of the subjects associated with glycemic control**

Blood Glucose		Median (Minimum- Maksimum)	P-Value
FBG	Day 1	87 (73-122)	0,032
	Day 6	96 (76-198)	
PPBG	Day 1	113 (85-155)	0,002
	Day 6	126 (98-281)	



**Figure 1. Trend analysis of Anova Repeated Measurement glycemic control's subjects**

Figure 1 shows a trend graph analysis of Anova Repeated Measurement glycemic control of subjects. The graph above shows the peak increase in blood glucose levels during the first day's pre-dinner. Daily glycemic control is dominated by an increase in pre-lunch blood glucose levels which is then followed by a decrease at pre-dinner, bedtime, and pre-breakfast the next day.

Figure 2 shows the number of subjects who had diabetes, pre-diabetes, and normally based on FBG, PPBG, and/or HbA1C before chemotherapy and the sixth day of chemotherapy. Before chemotherapy, there were 5 subjects with pre-diabetes and 16 non-diabetic. On the 6th day of chemotherapy, there were 2 new DM incidents (9.53%) and 7 with prediabetes (33.33%).

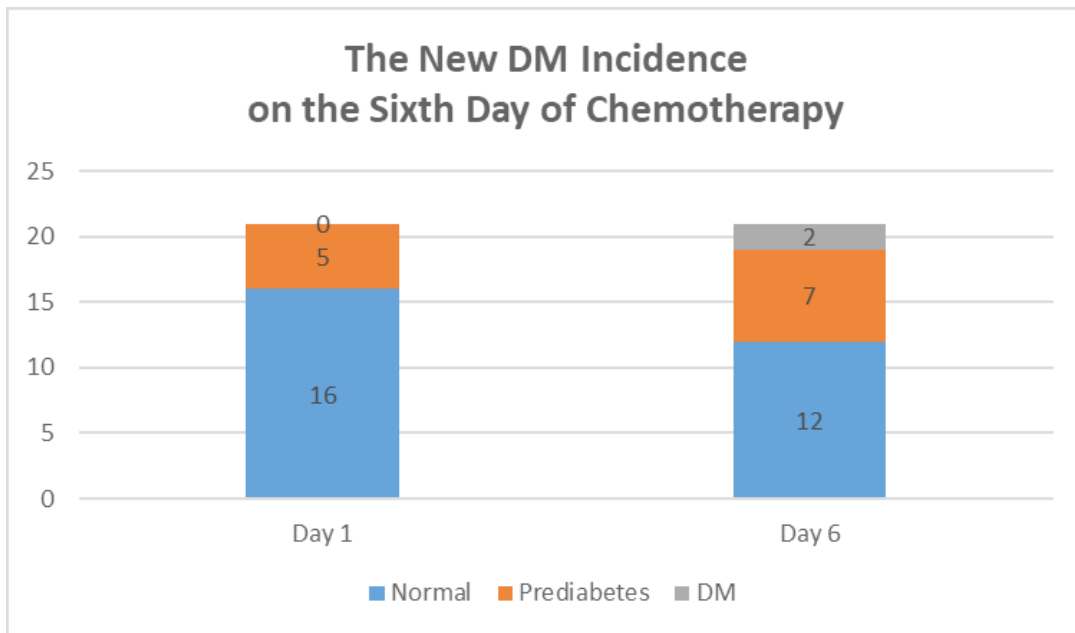


Figure 2. Incidence of DM in the sixth day of chemotherapy

### Discussion

Glycemic control on the first day until the fifth day of chemotherapy was varied on the subjects. The examination is carried out to determine the peak increase in blood glucose levels so that early detection and intervention can be done. The peak during pre-dinner the first day of chemotherapy-related to the administration of CHOP agents and premedication in the form of dexamethasone. The dominance of increased daily blood glucose levels at pre-lunch and pre-dinner and back down at bedtime and pre-breakfast the next day. This shows the predominance of an increase in blood glucose levels after the administration of chemotherapy agents at 7.00 am on the second to the fifth chemotherapy day. The results of this study are in line with the theory presented in the study of Lee et al (2013) that an increase in glucose occurs after 6-8 hours after the chemotherapy agent is given and dominate more on increasing PPBG. Prednisone has a medium service life, peak concentration

in plasma at 1 hour after administration, the half-life of 2.5 hours, can give a hyperglycemic effect with an onset of 4 hours, reaches a peak at the 8th hour of administration, and working duration of 12-24 hours<sup>20</sup>. Dexamethasone has a longer working time of 36-72 hours so that the effects of hyperglycemia can extend to the time of the next glucose level examination. This causes dexamethasone to dominate more on increasing FBG<sup>21-22</sup>.

The effect of chemotherapy on FBG and PPBG levels in this study was statistically significant ( $p = 0.032$  and  $p = 0.002$ ) with a significance level of 5%. This is in line with research by Gonzales et al (2013), an increase in FBG in 50% of subjects and PPBG in 20% of subjects. The average increase in FBG was  $7.08 \pm 3.04$  mmol/L and PPBG was  $11.33 \pm 0.3$  mmol/L<sup>8</sup>. In our study, the average increase in FBG was  $177.5 \pm 28.99$  mg/dL and PPBG  $239.5 \pm 58.69$  mg/dL.

In this study, we found 2 subjects (9.53%) had new DM after getting chemotherapy. The two subjects did not experience acute complications of DM and were referred to Diabetes Mellitus Polyclinic of Dr. Soetomo Teaching Hospital Surabaya. Both of these subjects had comorbid factors such as for overweight, dyslipidemia, hypertension, and pre-diabetes. Subjects who had risk factors for pre-diabetes, had hyperglycemia up to 414 mg/dL, febrile neutropenia, and were given insulin therapy. Whereas subjects who did not have pre-diabetes risk factors received anti-diabetes drug therapy orally. Both subjects experienced a peak increase in glucose levels at the fourth and fifth pre-lunch in accordance with previous studies that mentioned an increase in the dominant glucose level at pre-lunch and depending on the dose accumulation of agents that cause hyperglycemia<sup>7,9</sup>.

Some chemotherapy agents affect insulin resistance and  $\beta$  cells. This is exacerbated by the presence of comorbidities in patients such as obesity, hypertension, and metabolic syndrome. Risk factors in this study included overweight - obesity (8 subjects), dyslipidemia (15 subjects), hypertension (5 subjects), and smokers (3 subjects). The accumulation of the duration and dose of the chemotherapy agent also influences the incidence of DM<sup>7</sup>. In addition, according to Lamar et al (2018), hyperglycemia can be induced by drugs through the mechanism of pancreatic  $\beta$  cell destruction which causes a decrease in insulin secretion and sensitivity to insulin<sup>9</sup>.

Cyclophosphamide and epirubicin can cause immunologically destructive  $\beta$  cells through induction of secretion of alpha interferon and lymphocytes cytokines<sup>23</sup>. Doxorubicin causes worsening of insulin signaling, muscle atrophy induces pro-inflammation and induces anaerobic glycolytic metabolism in skeletal muscle<sup>24</sup>. Corticosteroids induce hyperglycemia through decreased glucose transporter type 4 (GLUT-4) regulation in cell membranes, increased gluconeogenesis, insulin resistance in muscle cells and adipose tissue,  $\beta$  cell dysfunction, increased proteolysis and lipolysis, and inhibition of the enzyme 11- $\beta$  hydroxysteroid dehydrogenase type 1<sup>12,15,25-26</sup>.

Hyperglycemia contributes to the phenotype of cancer cell malignancy such as increased proliferation ability, apoptosis inhibition, metastasis, perineural invasion, resistance to chemotherapy through reducing the sensitivity of cancer cells to chemotherapy agents, and intolerance to chemotherapy<sup>27-28</sup>. The condition

of hyperglycemia in malignant patients can affect the outcome of malignant therapy, complications related to malignancy and treatment of malignancy, length of stay, recurrence, and mortality<sup>29-30</sup>. Regulation of blood glucose levels is important in malignant patients<sup>13-14,17</sup>. It's related to the success of chemotherapy given, reducing the complications that may occur, reducing hospitalization days, reducing mortality, increasing the success rate of therapy, and life expectancy of cancer patients<sup>7,8,9</sup>.

## Conclusion

The peak of blood glucose during the first CHOP chemotherapy was in pre-dinner in the first day of chemotherapy. There was an increase in FBG and PPBG of NHL non-DM patients before and the sixth day the first CHOP chemotherapy. Incidence of new DM in the first CHOP chemotherapy was 9.53%.

**Conflict of Interest:** No conflict of interest regarding the publication.

**Source of Funding:** This research was fund by author.

**Ethical Clearance:** Taken from Ethical Committee in Dr. Soetomo Teaching Hospital, Surabaya, Indonesia (1624/KEPK/XI/2019).

## References

1. Indonesian Ministry of Health. Lymphoma Disease Data and Conditions in Indonesia. Jakarta: Indonesian Ministry of Health; 2015. 1-8.
2. Pufall. Glucocorticoids and Cancer. *Adv Exp Med Biol.* 2015; 872: 315–333.
3. American Cancer Society. Key Statistics for Non-Hodgkin Lymphoma. [Internet]. 2019. Available from: <https://www.cancer.org/cancer/non-hodgkin-lymphoma/about/key-statistics.html>
4. Indonesian Ministry of Health. Guidelines for Management of Non-Hodgkin's Lymphoma. Jakarta: Indonesian Ministry of Health; 2015. 1-38.
5. National Comprehensive Cancer Network. B-Cell Lymphomas. [Internet]. 2019. Available from: <https://www.NCCN.org>
6. National Cancer Institute. Common Terminology Criteria for Adverse Events (CTCAE) Version 5.0. [Internet]. 2017. Available from: <https://www.meddra.org/>

7. Lee AY, Kurita N, Yokoyama Y, Seki M, Hasegawa Y, Okoshi Y, Chiba S. Glucocorticoid-Induced Diabetes Mellitus in Patients with Lymphoma Treated with CHOP Chemotherapy. *Support Care Cancer*. 2013; 22: 1385-1390.
8. Gonzalez JGG, Zavala LGM, Gutierrez RR, Almaguer DG, Gonzalez FJL, Perez HET, Saldivar GG, Perez JZV. Hyperglycemia Related to High-Dose Glucocorticoid Use in Non-critically Ill Patients. *Diabetology & Metabolic Syndrome*. 2013; 5(18): 1-7.
9. Lamar ZS, Dothard A, Kennedy L, Isom S, Robinson M, Vaidya R, Hurd D, McClain D, Lesser G. Hyperglycemia During First-Line R-CHOP or Dose Adjusted R-EPOCH Chemotherapy for Non-Hodgkin Lymphoma is Prevalent and Associated with Chemotherapy Alteration – A Retrospective Study. *Leuk Lymphoma*. 2018; 59(8): 1871-1877.
10. Indonesian Endocrinology Association. Guidelines for the Management of Dyslipidemia in Indonesia. Jakarta: IEA; 2019. 1-74.
11. Internasional Diabetes Federation. IDF Diabetes Atlas. 8<sup>th</sup> Edition. 2017.
12. Harris D, Barts A, Connors J, Dahl M, Elliott T, Kong J, Keane T, Thompson D, Stafford S, Ur E, Sirrs S. Glucocorticoid-Induced Hyperglycemia is Prevalent and Unpredictable for Patients Undergoing Cancer Therapy: An Observational Cohort Study. *Current Oncology*. 2013; 20(6): e532-538.
13. Brady VJ, Grimes A, Amstrong T, Wood GL. Management of Steroid-Induced Hyperglycemia in Hospitalized Patients with Cancer: A Review. *Oncology Nursing Forum*. 2014; 41(6): E355-E365.
14. Rowbottom L, Stinson J, McDonald R, Emmenegger U, Cheng S, Lowe J, Giotis A, Cheon P, Chow R, Pasetka M, Thavarajah N, Pulezas N, Chow E, DeAngelis C. Retrospective Review of the Incidence of Monitoring Blood Glucose Levels in Patients Receiving Corticosteroid with Systemic Anti-Cancer Therapy. *Ann Palliat Med*. 2015; 4(2): 70-77.
15. Jeong Y, Han HS, Lee HD, Yang J, Jeong J, Choi MK, Kwon J, Jeon HJ, Oh TK, Lee KH, & Kim SK. A Pilot Study Evaluating Steroid-Induced Diabetes after Antiemetic Dexamethasone Therapy in Chemotherapy-Treated Cancer Patients. *Cancer Res Treat* 2016; 48(8): 1429-1437.
16. Farooki A, Flory J. Diabetes Management in Cancer Patients. [Internet]. 2016. Available from: <https://www.cancernetwork.com/oncology-journal/diabetes-management-cancer-patients>
17. Yang J, Jia B, Qiao Y, Chen W, Qi X. Variations of Blood Glucose in Cancer Patients during Chemotherapy. *Nigerian Journal of Clinical Practice*. 2016; 19(6): 704-708.
18. American Diabetes Association. Standards of Medical Care in Diabetes. Volume 42. 2019.
19. Ashariati A. Chemotherapy. In: *Textbook of Internal Medicine*. 2<sup>nd</sup> Edition. Surabaya: Airlangga University Press; 2015. 433-436.
20. Katzung BG, Hall MK, Trevor AJ. *Pharmacology Examination & Board Review*. Mc Graw Hill, Lange. 2019.
21. Gupta, Bhatia. Corticosteroid Physiology and Principles of Therapy. *Indian Journal of Pediatrics*. 2008; 75: 1039-1044.
22. Niema L. Pharmacologic Use of Glucocorticoids. [Internet]. 2019. Available from: <https://www.UptoDate.com>
23. Sharma PK, Misra AK, Singh V, Gupta A, Saroha S, Singh S. Cyclophosphamide and Epirubicin-induced Diabetes Mellitus in Breast Cancer: A Rare Occurrence. *Journal of Pharmacology and Pharmacotherapeutics*. 2016; 7(3): 146-148.
24. Supriya R, Tam BT, Pei XM, Lai CW, Chan LW, Yung BY, Siu PM. Doxorubicin Induces Inflammatory Modulation and Metabolic Dysregulation in Diabetic Skeletal Muscle. *Frontiers in Physiology*. 2016; 7(323): 1-13.
25. Raalte DHV, Diamant M. Steroid diabetes: from mechanism to treatment?. *The Journal of Medicine*. 2014; 72(2): 62-72.
26. Suh S, Park MK. Glucocorticoid-Induced Diabetes Mellitus: An Important but Overlooked Problem. *Endocrinology and Metabolism*. 2017; 32: 180-189.
27. Duan W, Shen X, Lei J, Xu Q, Yu Y, Li R, Wu E, Ma Q. Hyperglycemia, a Neglected Factor during Cancer Progression. *BioMed Research International*. 2014: 1-10.
28. Mitri J, Castillo J, Pittas A. Non-Hodgkin Lymphoma in Patients with Diabetes Mellitus: A Meta-Analysis. *Diabetes Care*. 2008; 31(12): 2391-2397.

29. Srokowski TP, Fang S, Hortobagyi GN, Giordano SH. Impact of Diabetes Mellitus on Complications and Outcomes of Adjuvant Chemotherapy in Older Patients with Breast Cancer. *Journal of Clinical Oncology*. 2009; 27(13): 2170-2176.
30. Schultz H, Bjergaard UP, Jensen AK, Engelholm SA, Kristensen PL. The Influence on Survival of Glucocorticoid Induced Diabetes in Cancer Patients with Metastatic Spinal Cord Compression. *Clinical and Translational Oncology*. 2018; 11: 19-25.

# Reformulation of Medical Rehabilitation against Victims of Narcotics Abuse in Indonesia

Jumriani Nawawi<sup>1</sup>, Slamet Sampurno<sup>2</sup>, M. Syukri Akub<sup>2</sup>, Nur Azisa<sup>3</sup>

<sup>1</sup>Lecturer at Institut Agama Islam Negeri Bone (IAIN) Bone, South Sulawesi, Indonesia, <sup>2</sup>Professor, Department of Criminal Law, Faculty of Law, Hasanuddin University, Indonesia, <sup>3</sup>Associate Professor, Department of Criminal Law, Faculty of Law, Hasanuddin University, Indonesia

## Abstract

The criminal sanction that occurred against the perpetrators of narcotic users is still inclined to apply imprisonment rather than rehabilitation measures. The research is a normative legal research using a statute, case, and conceptual approaches. The results show that The essence of medical rehabilitation sanctions imposing against victims of narcotics abusers who adhere to the double track system which is oriented to criminal and action sanction. Rehabilitation of narcotics abusers and addicts the purpose to cure the narcotics dependence against abusers and addicts so that the abusers and addicts recover from narcotics. In order to realize a narcotics-free State, the implementation of medical rehabilitation sanction imposing must reflect philosophical, juridical and sociological values while considers the legal development and needs of the community in implementing narcotics crime eradication.

**Keywords:** *Drugs; Narcotics; Rehabilitation; Victims.*

## Introduction

Indonesia affirms firmly through its commitment to combat narcotics abuse and illicit trafficking, various specific regulations regarding narcotics in the form of laws have been made with the aim of combating narcotic crimes.<sup>1</sup> Although narcotics are substances or drugs that come from plants or not plants, synthetic and semi-synthetic that can cause a decrease and change of consciousness, loss of pain and can cause dependence.<sup>2</sup> On the one hand, the availability of narcotics is a useful drug in the field of medicine or health services and the development of science, but on the other hand it creates a very detrimental dependency if it is misused. To prevent and eradicate the misuse and illicit trafficking of narcotics that have been detrimental to and endanger the lives of the people, the assertion of the need for crime prevention is integrated with the overall social policy and national development planning.<sup>3</sup>

The role of rehabilitation in healing addictions for narcotics addicts is very important, because of the increasing number of narcotics addicts.<sup>4</sup> The effectiveness of rehabilitation to cure victims of narcotics is very necessary, given the difficulty of victims or users

of narcotics to be separated from narcotics addiction individually. In rehabilitating drug addicts, the National Narcotics Agency cooperates with various parties includes foundations, hospitals and health centers. The addicts are rehabilitated so they can be free from the snare of drugs and return to normal life. Rehabilitation is important to do because the abuse of narcotics will have a negative impact on health, such as HIV-AIDS, hepatitis, infections, heart disease, blood vessel disorders in pregnancy and other health problems to death.

Based on previous research, it was found that neighboring country, Malaysia had first placed its citizens categorized as drug users as victims and no longer as perpetrators of crime. In Malaysia, drug users or addicts receive verdicts for rehabilitation even with a maximum limit of 3 times. Another example is Portugal, the country has decided that drug addicts who are intended as drug owners for their own use remain prohibited, but violations of this rule will be considered administrative violations, and no longer considered crimes. From various writings, it is known that in these two countries, there was then a decrease in the number of drug users, a decrease in mortality due to drug use

and a decrease in HIV-AIDS cases. This is precisely the case with Indonesia, where each year there is an increase in the number of drug use, the overload of correctional facilities with prisoners related to drug use.<sup>5</sup>

Protection of narcotics addicts and abusers is achieved with the promulgation of Act No. 35 of 2009 concerning Narcotics. The Narcotics Act adheres to the *Double Track System*, which is a criminal law policy in the formulation of the provisions governing sanctions given to narcotics abuse offenders, namely in the form of criminal sanctions and sanctions for acts considering that narcotics abusers have a slightly different position from other. One side of the narcotics user is a criminal offender who must be punished, but on the other hand is a victim of a criminal offense he committed himself, so an action in the form of rehabilitation is necessary.<sup>6</sup>

The National Narcotics Agency of South Sulawesi Province noted the number of drug users and illegal drugs in South Sulawesi are still quite high. So that with rehabilitation as an effort or the best way to save people from the drugs.<sup>7</sup> Rehabilitation of narcotics addicts is also a form of social protection that integrates narcotics addicts in a social order so that no longer commits drug abuse. However, as it turns out into practice, rehabilitation of abusers is considered unsuccessful.<sup>8</sup> Many cases of narcotics abuse experienced by Indonesian public figures are an example of the ineffectiveness of rehabilitation as one of the ways implemented in combating narcotics crimes. Where in some cases, the public figures that were decided by the judge undergoing rehabilitation even re-used. As if rehabilitation is only to stop the abuse of narcotics for a while and still less able to treat and make peoples to free from narcotics addiction.

In addition, because not a few of the abusers who are caught must lose their right to undergo rehabilitation as they should so the right to obtain access to essential health is not obtained especially for drug addicts, because the addict will be sentenced to prison. While it is common knowledge that prison is no longer a safe place from these illicit goods. Hence, rehabilitation sanctions should be *premium remidium* and imprisonment as *ultimum remidium* in the prevention and eradication of narcotics crime so that the narcotics circle can be broken down to its roots.

## Method

The research is a normative legal research using a statute, case, and conceptual approaches.<sup>9</sup> The research

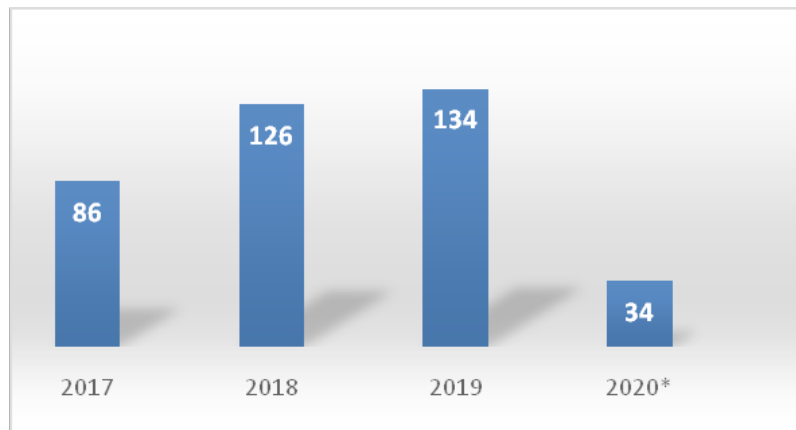
location was centered on the National Narcotics Agency of South Sulawesi Province and the District Narcotics Agency. In this research, we uses direct interviews with narcotics abusers, the parties to the National Narcotics Agency, the parties to the Provincial National Narcotics Agency and the rehabilitation institutions.

**The Essence of Medical Rehabilitation Sanction Imposing against Narcotics Abuse Victims:** At this time, inevitably that the development of narcotics use is increasing rapidly and not for medicinal purposes or scientific development, but to gain large profits, namely by conducting illegal drug trafficking in various countries.<sup>10</sup> This raises concern for the international community, given the impact caused by the misuse of narcotics which is very dangerous for the life of the nation and country, especially for the continued growth and development of the younger generation. Based on these considerations, several international conventions have been issued to deal with the development of the illegal narcotics trade.

Prevention of narcotics abuse is intended to fortify the public so as not to get involved in narcotics abuse, the target is people who have never been involved with narcotics abuse so as not to become abusers and not to become dealers.<sup>11</sup> Rehabilitation of narcotics abusers and addicts to cures the conditions of narcotics dependence against abusers and addicts so that the abusers and addicts recover from addiction/narcotics dependence. Abusers are prohibited and threatened with prison sentences as well as narcotics addicts who do not report themselves to recover are also threatened with criminal penalties, but forced efforts and punishment in the form of rehabilitation.

The phase of assessment at the Institution of Compulsory Reporting as described in the table is a phase that is general in nature and applies to all addicts and victims of narcotics abusers. This stage is also in accordance with what is regulated in Government Regulation No. 25 of 2011 concerning the implementation of the Compulsory Reporting on Narcotics Addicts. According to the author, this phase is still incomplete if it only reaches the rehabilitation phase. It is better to avoid the relapse of addicts and victims of narcotics abusers that there must be progress monitoring after following the rehabilitation phase to monitor the situation of the former addict. As for the number of addicts and victims of narcotics abuse that run the compulsory reporting at the research location, can be seen in Chart 1.





Source: Primary data, edited (March 16, 2020).

**Chart 1. Number of addicts and victims of narcotics abuse to compulsory reporting at BNNK Watampone, South Sulawesi, Indonesia. (\*Updates for January - March)**

Based on the result of interview with Mrs. Eni as the Division Head of Rehabilitation of BNNK Bone as place to receive the compulsory reporting, as the result of reporting, it will be processed by conducting an assessment to determine the condition of the addict. Accordingly, the intended assessment includes:

- a. Interview is to find out the medical history of addicts, the extent of narcotics use, the psychological state, the social background and to explore whether there is involvement with the network.
- b. Observation is to see the behavior of addicts, whether there are things that are hidden.
- c. Physical examination is to find out the vital signs in the body of an addict.

As result of assessment can be seen whether the addict has a connection with the network. If an indication of involvement with the network is found then this will be a reference for the Sub-Section of BNNK Bone for immediate action. Regarding the identity of the addict who is obliged to report will be guaranteed confidentiality. As a consequence, if not obey the rule of this compulsory reporting, the parents or guardians will be threatened with imprisonment as stipulated further in Article 128 of Act No. 35 of 2009 concerning narcotics.

Based on the narcotics laws, narcotics users can be seen from 2 (two) points of view. The first is the use of narcotics legally or in accordance with applicable legal requirements. The second is the use of narcotics illegally or contrary to the law referred to as narcotics abuse. Narcotics can be used legally and not against the law if it

is done for medical purposes and scientific development. The Narcotics law also has two approaches to those who use narcotics illegally or against the law, or in other words misuse narcotics.

The first approach is to see narcotics users as victims so that they must be rehabilitated and the second is to see narcotic users as criminals. As in the explanation section of the narcotics law, it also regulates criminal sanctions for the abuse of narcotics precursors for narcotics manufacturing. To create a deterrent effect on the perpetrators of narcotics abuse and illicit trafficking of narcotics precursors, it is regulated regarding the imposition of criminal sanctions, both in the form of special minimum penalties, 20 (twenty years) imprisonment, life imprisonment, and capital punishment based on the group, type, size, and number of narcotics.

The policy in combating criminal acts of narcotics abuse is a positive legal policy which in essence is not merely the implementation of normative juridical laws. Besides the normative juridical approach, criminal law policy also requires a comprehensive and integral factual juridical approach. The law has provided sufficient legal umbrella and has regulated everything from suppliers, importers or producers to users, but at the level of implementation of law enforcement efforts still need to be improved. This is related to the performance of the legal apparatus itself.

The policy of crime eradication through the making of criminal law is an integral part of the community

protection policy and is an integral part of social politics. Social politics can be interpreted as all rational efforts to achieve the welfare of society and at the same time include community protection. One function of the imposition of rehabilitation sanctions is to carry out extra countermeasures against the problem of narcotics abuse which resolves the problem from its roots, namely from abusers in this case is abusers for themselves, addicts and victims of narcotics abuse.

**Legal reform on Medical Rehabilitation against Narcotics Abuse:** Legal renewal is defined as a process of conducting review on various formulations of applicable laws and regulations, and to which are implemented a number of changes in order to achieve efficiency, fairness and also the opportunity to obtain justice according to applicable law. It is generally understood that the actual legal reform takes place, when the body of authority forms the law, namely the judiciary and the legislators, the government and the legislative authority in power or authority in a country take a number of steps (legal policy) which is required to test the applicable law.<sup>12</sup> The legal policy was made in the context of legal reform.

The criminal justice system is a system in a society to overcoming the problem of crime. This system is considered successful if the majority of public reports as crime victims can be resolved by bringing the perpetrators to court and convicted.<sup>13</sup> The components that work together in the system of sanctions imposing against victims of narcotics abusers are the police, prosecutors, courts, prisons, the National Narcotic Agency. The four components are expected to work together to form what is known as the “*integrated criminal justice system*”.

Hence, to be able to guarantee abusers as perpetrators of narcotics misuse in accordance with the purpose of making the Act, the Narcotics Act contains or adheres to the rehabilitation justice system in addition to criminal justice. Therefore, the Narcotics Law adheres to the Double Track Criminal System. The dealer follows the criminal justice track while the abuser follows the rehabilitation justice track. The rehabilitation justice system is a judicial system in which sanctions out of criminal sanctions become rehabilitation sanctions with the purpose that the suspect is cured and does not become a further abuser.<sup>14</sup>

The justice system that has been in effect mostly focuses only on the criminal justice system. Where, the

abusers are victims and not free from prison sentences. From those who undergone prison sentences, not a few are returning to abuse narcotics (*relapse*). As well with those who undergo rehabilitation either through legal step or compulsory reporting, not a few who return to abuse narcotics (*relapse*). For this reason, according to the author, the imposition of sanctions that have been there needs to be reformulated again, where in the narcotics justice system that has been adhering to a dual track system independently between criminal and rehabilitation can be cumulative. In the sense that the imposition of sanctions against abusers is given a double sanction namely rehabilitation and prison sanction altogether. Rehabilitation sanction were imposed by considering the position of the abuser as a victim who should have received special treatment (medical) in order to be able to eliminate detox which could trigger the return of relapse.

For this reason, there are several articles in Act No. 35 of 2009 concerning narcotics which should be reformulated so that it can be imposed on abusers so that the purpose of this law can be achieved optimally, such as the narcotics addicts and victims of narcotics abuse must undergo medical and social rehabilitation, this article only allows imposed on those who are addicted and those who are persuaded, tricked, deceived, forced and threatened with using narcotics. While, many of abusers who first used narcotics because they were persuaded and deceived, because it is difficult to prove that Article 54 cannot be imposed on him as a victim.

## Conclusion

The essence of medical rehabilitation sanctions imposing against victims of narcotics abusers who adhere to the double track system which is oriented to criminal and action sanction. In order to realize a narcotics-free State, the implementation of medical rehabilitation sanction imposing must reflect philosophical, juridical and sociological values, while considers the legal development and needs of the community in implementing narcotics crime eradication. The ideal concept of medical rehabilitation sanctions imposing against on victims of narcotics abuse can be done by reformulating several articles in Act No. 35 of 2009 concerning Narcotics which should be reformulated so that it can be imposed on abusers so that the purpose of this law can be achieved optimally.

**Ethical Clearance:** No ethical approval is needed.

**Source of Funding:** Self

**Conflict of Interest:** Nil

### References

1. Fellner, J. Race, drugs, and law enforcement in the United States. *Stanford Law and Policy Review*, 2009;20 (1) 257-264.
2. Lisa, J., and Sutrisna, N. *Narkoba, Psikotropika, dan Gangguan Jiwa (Tinjauan Kesehatan dan Hukum)*. NuhaMedika. Yogyakarta, 2019;4.
3. Arif, B.N. *Bunga Rampai Kebijakan Hukum Pidana*. Semarang. Kencana, 2010;6.
4. Ariyanti, V. Indonesia's criminal law policy on the victim of narcotics abuse in the perspective of victimology. *Veteran Law Review*, 2018; 1(1), 32-49.
5. Triadi, R. Level of compliance of narcotics victims in turning medical and social rehabilitation. *Journal of Islamic Studies*, 2018; 1(2): 23-41
6. Febriana, M., Soewondo, S. S., Hamid, M. A., & Heryani, W. Legal Protection of Narcotic Abusers: A Restorative Justice Perspective. *J. LPol'y & Globalization*, 2019; 88 (1) 64.
7. *Tribun News*. Available online at: <http://makassar.tribunnews.com/2018/11/16/bnn-sulsel-jika-kecanduan-narkoba-jangan-malu-dan-takut-melapor-ke-bnn-anda-tidak-akan-dipenjara>, accessed on 17 November 2018
8. *Liputan 6 News*. Available online at: <https://www.liputan6.com/news/read/3391765/bnn-pecandu-yang-kembali-konsumsi-narkoba-usai-rehabilitasi-70-persen>, accessed on 23 November 2018
9. Fajar, M., and Ahmad, Y. *Dualisme Penelitian Hukum Normatif dan Empiris*. Pustaka Pelajar. Yogyakarta, 2017; 34
10. Adi, K. *Diversi Tindak Pidana Narkotika Anak*. Malang: Setara Press, 2015; 31
11. Iskandar, A. *Penegakan Hukum Narkotika (Rehabilitatif Terhadap Penyalah Guna Dan Pecandu Represif Terhadap Pengedar)*. Jakarta: PT Elex Media Komputindo. 2019; 7
12. Prasetyo, T. *Pembaharuan Hukum Perspektif Teori Keadilan Bermartabat*. Malang: Setara Press, 2017; 26.
13. Reksodiputro. M. *Sistem Peradilan Pidana Indonesia (Peran Penegak Hukum Melawan Kejahatan)*. Jakarta: Pusat Pelayanan Keadilan dan Pengabdian Hukum. 1997; 84.
14. Idaiani, S. *Relapse in Drugs, Psychotropic, Addictive Abuse Post Rehabilitation: "Policy and Prevention Programs"*. 4th International Symposium on Health Research, 2019; 56-59.

# Impact of COVID-19 Pandemic and National Lockdown on Mental Health among General Urban Indian Population: An Online based Cross-Sectional Survey

Jyoti Sharma<sup>1</sup>, Irshad Ahmad<sup>2</sup>, Shahin Naz Jamali<sup>3</sup>, Yamini Sharma<sup>1</sup>,  
Megha Yadav<sup>1</sup>, Sakhshi Arora<sup>1</sup>, Mangalam Kumari<sup>1</sup>

<sup>1</sup>Assistant Professor, School of Medical and Allied Sciences, Galgotias University, Greater Noida, Uttar Pradesh,

<sup>2</sup>Assistant Professor, Faculty of Allied Health Sciences, Manav Rachna International Institute of Research and Studies, Faridabad, Haryana, <sup>3</sup>Assistant Professor, School of Health Sciences, Noida International University,

Greater Noida, Uttar Pradesh

## Abstract

**Purpose:** The aim of the study is to assess the prevalence of anxiety and depression among the urban Indian population during the period of national lockdown imposed by the government of India to combat the COVID-19 pandemic

**Method:** Total 278 participants were participated in an online, cross-sectional survey. Anxiety and depression was assessed. Gender, age, occupation and average time spent on gathering information on COVID-19 was assessed.

**Results:** less than 30 years of age and students showed higher prevalence of depression. Participants spending more than three hours on COVID-19 information showed that 18.2%, 42.4% and 37.9% were mildly, moderately and severely affected by anxiety symptoms, respectively and 19.7%, 47% and 24.2% were mildly, moderately and severely affected with depression. Further, more than three hours of time spent on COVID-19 showed strong association with mild, moderate and severe anxiety ( $p < 0.001$ ) as well as mild, moderate and severe depression ( $p \leq 0.01$ ).

**Conclusions:** Participants, less than 30 years of age and students were found more likely to have anxiety and depression symptoms. Participants who have been spending more than three hours on COVID-19 information were strongly affected with mild, moderate and severe anxiety as well as depression.

**Keywords:** Anxiety, Depression, GAD-7, PHQ-9, Psychological Illness, Mental Illness.

## Introduction

World health organization (WHO) declared the novel coronavirus disease 2019 (COVID-19) a health emergency in January 2020 and declared it a pandemic

in March 2020. On 02<sup>nd</sup> April 2020, the total number of confirmed cases of COVID-19 were estimated at 938,348 with 48,571 deaths around the world due to the disease<sup>(1)</sup>. In India, the first confirmed case of COVID-19 was reported on 30 January 2020. The number of confirmed cases increased to 1027 by 29 February 2020 which further increased to 2192 confirmed cases by 02 April 2020 and the count is rapidly increasing<sup>(2)</sup>.

---

### Corresponding Author:

**Irshad Ahmad**

Assistant Professor, Faculty of Allied Health Sciences,  
Manav Rachna International Institute of Research and  
Studies, Faridabad, Haryana

e-mail: irshad.ahmadjmi10@gmail.com

Previous study has reported on mental health crisis in China due to COVID-19, and said a health emergency occurring due to an epidemic of an infectious disease can prompt unfavorable situations and lead to long

lasting psychological consequences<sup>(3)</sup>. Any epidemic or outbreak of infectious disease can have a wide range of psychiatric comorbidities like stress, panic attacks, fear, depression and anxiety<sup>(4-6)</sup>. In addition, quarantine has been associated with high stress levels, depression, irritability and insomnia<sup>(7,8)</sup>. An investigation concerning COVID-19 pandemic reported a rate of 20.8-34% anxiety and 17.3-18.1% depression among general population<sup>(10-12)</sup>. In India, a study conducted on the effect of pandemic of COVID-19 and resultant lockdown also suggests a significant adverse effect on the mental status of the population<sup>(12)</sup>.

Therefore, the aim of the present study is to explore the prevalence and potential factors associated with anxiety and depression during the initial 21 days of national lockdown, imposed due to the spread of COVID-19 pandemic, among the urban Indian population.

## Materials and Method

**Study Design and Participants:** A cross-sectional survey was conducted to assess the immediate psychological response of anxiety and depression during the epidemic of COVID-19 by using snowball sampling. Ethical approval was obtained and the study was conducted in accordance with the Helsinki Declaration.

Out of total 294 respondents, response of 278 participants were included on the basis of inclusion and exclusion criteria. Inclusion criteria were Indian participants, both gender, above 18 years of age and able to understand the English language. Health-care workers, sanitation workers, security professionals and delivery professionals were excluded. An online consent was taken from each participant before they answered the questionnaire. The participation was completely voluntary and non-commercial.

**Procedure:** An online survey was done using the questionnaire developed through 'Google forms' with attached consent form. The web link was circulated through e-mails and social networking mediums. Participants were encouraged to circulate the survey. On clicking the web link, participants were auto directed to a page containing demographic information, average time spent on gathering information on COVID-19, followed by the Generalized Anxiety Disorder (GAD-7) questionnaire and Patient Health Questionnaire (PHQ-9). Data collection, initiated on 29<sup>th</sup> march 2020 and culminated on 2<sup>nd</sup> April 2020, that is, during the initial

phase of national lockdown.

**Demographic Characteristics:** The variables of demographic data included gender (male and female), age (<30 years and ≥30 years), and occupation which was categorized into (a) public sector employees, (b) private sector employees, (c) students and (d) others

**Average time spent on COVID-19 information everyday:** This section questioned the participants on the average time they spent each day on electronic, print, and social media for gathering information on COVID-19. Average time spent to gather information on COVID-19 was divided into three categories: (a) less than one hour (<1 hour), (b) one to three hours (1-3 hours), and (c) more than three hours (>3 hours).

**Generalized Anxiety:** The GAD-7 questionnaire is a 7-item self-assessment scale developed to assess the defining symptoms of general anxiety disorder<sup>(13)</sup>. Items in the scale were rated on a 4-point Likert scale. According to GAD-7, a score ranging from 0-4, 5-9, 10-14 and 14-21 represents absent, mild, moderate and severe anxiety, respectively<sup>(13)</sup>.

**Depression:** PHQ-9 is also a self-assessment tool for depression with a 4-point Likert scale. PHQ-9 scores ranging from 0-4, 5-9, 10-19 and 20-27 represent absent, mild, moderate and severe depression symptoms, respectively<sup>(14)</sup>.

**Statistical analysis:** All statistical analyses were carried out using SPSS version 24. Descriptive statistics were calculated for demographic characteristics including gender, age, occupation and average time spent on COVID-19 information every day. Prevalence of generalized anxiety and depression was stratified according to above characteristics, and chi-square test was used to compare the differences in responses between different groups. Univariate and multivariate logistic regression were performed to explore potential factors associated with generalized anxiety and depression. Statistical significance was indicated if  $p \leq 0.05$  and confidence interval was set at 95%. The scores of the GAD-7 and PHQ-9 were expressed in frequency.

## Results

Absolute and frequency distribution of generalized anxiety and depression has been reported in Table 1 and 2.

**Prevalence of Generalized Anxiety and Depression Stratified by Gender, Age, Occupation and Time Spent Gathering Information on COVID-19 Pandemic:** Prevalence of generalized anxiety and depression is illustrated in Table 1 and Table 2, respectively. There was no statistical significant difference in the prevalence of anxiety between males and females, <30 years and ≥30 years, or the participants involved in different occupations. However, significant difference was in the prevalence of anxiety between participants who spent <1 hour, 1-3 hours and >3 hours of average time spent on gathering information on COVID 19 (p<0.001) Table 1.

There was no significant difference in the prevalence of depression between males and females. The prevalence of depression was significantly higher (p=0.015) in participants of <30 years than ≥30 years of age (Table 2). There was significant difference found in the prevalence of depression between participants belonging to different occupations groups (p=0.01). Students showed higher prevalence of depression than public and private sector employees (Table 2). Similarly, significant difference was found in the prevalence of depression between different time spent on COVID-19 (p<0.001). >3 hours of time spent showed higher prevalence of depression

than 1-3 hours and <1 hours of time spent on COVID-19 (Table 2).

**Factors Associated with Generalized Anxiety and Depression during COVID-19 Pandemic:** Univariate and multivariate logistic regressions revealed that only average time spent on COVID-19 (p<0.001) showed significant association with the severity of generalized anxiety. >3 hours of time spent on COVID-19 showed strong association with mild (p<0.001), moderate (p<0.001) and severe (p<0.001) anxiety (Table 3). Also, multivariate logistic regression analysis showed the significant association of students (p=0.04) with only mild anxiety during COVID-19 pandemic (Table 3).

The univariate logistic regression analysis showed a significant association of age (p<0.04) and average time spent on COVID-19 (p<0.001) with severity of depression. Participants <30 years of age showed strong association with mild (p=0.008), moderate (p=0.03) and severe (p=0.04) depression (Table 4). Similarly, >3 hours of time spent on COVID-19 was found to have strong association with mild (p=0.01), moderate (p<0.001) and severe (p<0.001) depression (Table 4). Additionally, there was significant association of students with moderate depression (p=0.02) even after adjusting other factors (p = 0.01) (Table 4).

**Table 1. Prevalence of generalize anxiety (GAD-7) stratified by gender, age, occupation and average time spent on COVID-19 in the participants.**

Variables	Anxiety Absent n(%)	Anxiety Present			$\chi^2$	p-value
		Mild n(%)	Moderate n(%)	Severe n(%)		
Total (N=278)	139 (50.0)	76 (27.3)	37 (13.3)	26 (9.4)		
<b>Gender</b>					2.86	0.413
Male (N=122)	67 (54.9)	28 (23.0)	16 (13.1)	11 (9.0)		
Female (N=156)	71 (45.5)	48 (30.8)	21 (13.5)	16 (10.3)		
<b>Age</b>					3.68	0.297
<30 year (N=181)	85 (47.0)	50 (27.6)	29 (16.0)	17 (9.4)		
≥30 year (N=97)	53 (54.6)	26 (26.8)	8 (8.2)	10 (10.3)		
<b>Occupation</b>					9.14	0.429
Public sector (N=17)	10 (58.8)	5 (29.4)	1 (5.9)	1 (5.9)		
Private sector (N=73)	38 (52.1)	17 (23.3)	9 (12.3)	9 (12.3)		
Students (N=160)	71 (44.4)	48 (30.0)	26 (16.3)	15 (9.4)		
Others (N=28)	19 (67.9)	6 (21.4)	1 (3.6)	2 (7.1)		



Variables	Mild Anxiety		Moderate Anxiety		Severe Anxiety	
	OR (95% CI)	AOR (95%CI)	OR (95% CI)	AOR (95%CI)	OR (95% CI)	AOR (95%CI)
<b>Age</b>						
<30 year	1.19(0.66-2.15)	0.52(0.19-1.39)	2.26(0.96-5.31)	1.02(0.21-4.98)	1.06(0.45-2.48)	0.52(0.08-3.27)
≥30 year	1.00	1.00	1.00	1.00	1.00	1.00
<b>Occupation</b>						
Public sector	1.58(0.38-6.5)	2.13(0.48-9.43)	1.9(0.1-33.7)	5.1(0.2-127.64)	0.95(0.07-11.8)	4.72(0.16-132.31)
Private sector	1.41(0.48-4.17)	1.87(0.58-5.97)	4.5(0.53-38.17)	5.78(0.46-71.9)	2.25(0.44-11.46)	3.81(0.37-38.78)
Students	2.14(0.79-5.75)	4.41(1.01-19.12)*	6.95(0.88-54.61)	5.51(0.32-93.72)	2(0.42-9.55)	2.66(0.15-45.11)
Others	1.00	1.00	1.00	1.00	1.00	1.00
<b>Average Time Spent on COVID-19</b>						
<1 hours	1.00	1.00	1.00	1.00	1.00	1.00
1-3 hours	2.48(0.972-6.34)	2.38(0.92-6.17)	2.05(0.24-17.12)	2.06(0.24-17.33)	0.25(0.01-4.23)	0.23(0.01-3.88)
>3 hours	56(6.06-516.84)**	53.59(5.75-499.5)**	784(46.69-13164.49)**	755.31(44.85-12720.11)**	700(41.56-11788)**	711.52(41.85-12097.1)**

n: number of participants; %: percentage; <30 years: less than 30 years of age; ≥30 years: more than or equal to 30 years of age; <1 hours: less than 1 hour time spent; 1-3 hours: one to three hour of time spent; >3 hours: more than three hours of time spent; OR: odds ratio; AOR: adjusted odds ratio; 95% CI: confidence interval at 95%; \*: p<0.05; \*\*: p<0.01

**Table 4. Univariate and multivariate logistic regression analysis of potential factors for severity of depression (PHQ-9).**

Variables	Mild Depression		Moderate Depression		Severe Depression	
	OR (95% CI)	AOR (95%CI)	OR (95% CI)	AOR (95%CI)	OR (95% CI)	AOR (95%CI)
<b>Gender</b>						
Male	0.9(0.5-1.63)	0.97(0.52-1.8)	0.57(0.31-1.06)	0.57(0.29-1.12)	0.58(0.23-1.43)	0.6(0.23-1.59)
Female	1.00	1.00	1.00	1.00	1.00	1.00
<b>Age</b>						
<30 year	2.37(1.25-4.48)**	1.36(0.52-3.58)	2.01(1.06-3.79)*	0.76(0.25-2.24)	2.73(1.01-7.36)*	2.15(0.46-9.94)
≥30 year	1.00	1.00	1.00	1.00	1.00	1.00
<b>Occupation</b>						
Public sector	0.77(0.18-3.33)	0.74(0.16-3.28)	0.34(0.03-3.48)	0.45(0.04-4.94)	0.68(0.05-8.5)	0.98(0.06-13.97)
Private sector	0.75(0.25-2.25)	0.68(0.21-2.17)	1.72(0.49-5.97)	1.93(0.5-7.37)	1.21(0.22-6.71)	0.86(0.12-5.81)
Students	2.42(0.9-6.48)	2.22(0.54-9.14)	4(1.23-12.95)*	8.19(1.48-45.09)*	2.66(0.54-12.97)	1.25(0.13-11.57)
Others	1.00	1.00	1.00	1.00	1.00	1.00
<b>Average Time Spent on COVID-19</b>						
<1 hours	1.00	1.00	1.00	1.00	1.00	1.00
1-3 hours	1.34(0.56-3.2)	1.41(0.58-3.43)	1.25(0.46-3.43)	1.23(0.44-3.46)	0.8(0.15-4.16)	0.84(0.16-4.45)
>3 hours	4.57(1.3-15.97)*	4.48(1.26-15.94)*	16.36(4.6-58.11)**	15.82(4.35-57.53)**	25.33(4.47-143.32)**	25.64(4.46-147.32)**

n: number of participants; %: percentage; <30 years: less than 30 years of age; ≥30 years: more than or equal to 30 years of age; <1 hours: less than 1 hour time spent; 1-3 hours: one to three hour of time spent; >3 hours: more than three hours of time spent; OR: odds ratio; AOR: adjusted odds ratio; 95% CI: confidence interval at 95%; \*: p<0.05; \*\*: p<0.01



## Discussion

Results of present survey indicated that 50% participants were affected with anxiety symptoms because of the COVID-19 outbreak and lockdown, out of which 27.3% have mild, 13.3% have moderate and 9.4% have severe symptoms of anxiety. Similarly, 61.2% participants experienced depression, out of which 27% reported mild, 25.2% reported moderate and 9% reported severe symptoms of depression.

The present study found equal prevalence of anxiety and depression symptoms in male and female. We found similar results as the study conducted in China<sup>(10)</sup>, whereas, the study conducted in Italy and hardest hit areas of China showed that women are more anxious than men due to the COVID-19 pandemic<sup>(11,15)</sup>. An epidemic of any infectious disease leads to an increase in the prevalence of mental illness<sup>(9-11)</sup>, due to fear or apprehension of getting infected<sup>(16)</sup>. In the same context, people also avoid seeking medical help in case of common symptoms of cold or flu (which has overlapping symptoms of COVID-19) fearing screening and a positive COVID-19 diagnosis results in social exclusion, unwanted public attention and the stigma attached with the disease.

Age and occupation have similar prevalence rate of severity of general anxiety, whereas, a different prevalence rate of severity of symptoms of depression (Table 1 and 2). Younger participants showed higher prevalence of moderate to severe anxiety (statistically not significant) and depression symptoms when compared to the participants aged more than or equal to 30 years. Huang et al. and Rossi et al. also found similar results<sup>(10,11)</sup>. However, Wang et al. analyzed various different age groups ranging from 12 to 60 years and found no difference between these groups<sup>(9)</sup>. Increased depressive symptoms might be due to social isolation, limitation of outdoor activities and avoidance behaviour to limit socialization. Younger population tends to be more socially-interactive than the middle-age population<sup>(17)</sup>, therefore, it might be stressful for them to sit at home during the lockdown. Also, poor coping strategies or immature defence mechanism among the younger population combined with the stressful situation may lead to maladaptive behaviour<sup>(18)</sup>.

Our study also found that students are more prone to mild anxiety and moderate depression. Wang et al. also found the association of students with presence of anxiety and depression during the COVID-19 pandemic<sup>(9)</sup>.

Increase in depression is due to uneasiness experienced of risk exposure to the virus and thoughts about family and friends contracting the virus or suspected of being infected by the virus<sup>(19)</sup>. Our study recruited mostly under-graduate or post-graduate students from different universities. We believe that sudden implementation of virtual online classes at universities can result in a negative mental effect due to unfamiliarity with online teaching methodologies. Uncertainty regarding duration of quarantine, frustration and boredom due to disruption of usual routine, loss of social networks and confinement within the four walls leads to a sense of isolation<sup>(20)</sup> which further leads to deteriorating mental health.

Our study also found that the severity of anxiety and depression symptoms depended upon the time spent on gathering information regarding COVID-19. We found that participants who spent >3 hours on COVID-19 information were strongly associated with mild, moderate or severe anxiety as well as depression. Roy et al. reported that the stress related to COVID-19 in India is mostly due to seeing COVID-19 related posts on social media, discussion on news channels and print media and rampant spread of rumors via social media platforms<sup>(12)</sup>. They reported that the participants want to talk about the anxieties and stress related to COVID-19 with someone, but have to rely on electronic, social media and internet information which reduces the opportunities to de-stress. Also, media reporting about the shortage of resources and essential things for daily living further increased panic buying. As a result, people are not able to cope with the situation and feel emotionally exhausted.

Therefore few recommendations from this study are listed herein: First, limit the time spent on COVID-19 information to maximum one hour per day since excessive exposure to information. Second, minimize watching, reading or listening to news about COVID-19 and seeking information about the pandemic once or twice a day and it was further recommended that people should seek information only from trusted sources to get the true facts instead of rumors or misinformation<sup>(21)</sup>. Third, control over rumors, clear overview of authorities on the pandemic, health education and spread of knowledge of preventive measures could be implemented to reduce the negative mental impact of the pandemic.

This study had several limitations. The sample size is small which may limit the power of results. Snowball sampling techniques resulted in self-selection bias due to which an unbalanced occupation ratio

was seen. A major percentage (58%) of respondents were students. The study was conducted during the outbreak of COVID-19 in India, so participants' prior history of psychological state was not known and moreover, the anxiety and depression revealed in the study is self-reported and may not always clinically align with the diagnosis by mental health professionals. Future studies should be conducted during different phases of lockdown including rural population. Further studies are required to monitor the impact of mental health outcomes in order to define mental health interventions for the general population level.

### Conclusions

Participants with <30 years of age were found to be associated with mild, moderate and severe depression. Students were more likely to have mild anxiety and moderate depressive symptoms. Participants who were spending more than three hours on gathering information on COVID-19 were strongly associated with mild, moderate and severe anxiety as well as depression.

**Conflict of Interest:** None

**Source of Funding:** Authors are self-contributor as a source of funding. Present study was not funded by any organization or agency.

**Ethical Clearance:** Expedited ethical approval was taken from the local ethical board, Galgotias University, Noida, Uttar Pradesh.

### References

1. Worldometer. Coronavirus Cases. Worldometer [Internet]. 2020 [cited 2020 Apr 29];164:1–22.
2. Statista. Coronavirus (COVID-19) in India - Statistics & Facts. 2020. <https://www.statista.com/topics/6135/coronavirus-covid-19-outbreak-in-india/>
3. Dong L, Bouey J. Public Mental Health Crisis during COVID-19 Pandemic, China. *Emerg Infect Dis.* 2020;26(7).
4. Liu R, Wu J, Zhu H. Media/psychological impact on multiple outbreaks of emerging infectious diseases. *Comput Math Method Med.* 2007;8(3):153–64.
5. Strong P. Epidemic psychology: a model. *Sociol Heal Illn.* 1990;12(3):249–59.
6. Person B, Sy F, Holton K, Govert B, Liang A, NCID/SARS T, et al. Fear and Stigma: The Epidemic within the SARS Outbreak. *Emerg Infect Dis.* 2004;10(2):358.
7. DiGiovanni C, Conley J, Chiu D, Zaborski J. Factors Influencing Compliance with Quarantine in Toronto During the 2003 SARS Outbreak. *Biosecurity Bioterrorism Biodefense Strateg Pract Sci.* 2004;2(4):265–72.
8. Hawryluck L, Gold WL, Robinson S, Pogorski S, Galea S, Styra R. SARS control and psychological effects of quarantine, Toronto, Canada. *Emerg Infect Dis.* 2004;10(7):1206–12.
9. Wang C, Pan R, Wan X, Tan Y, Xu L, Ho CS, et al. Immediate psychological responses and associated factors during the initial stage of the 2019 coronavirus disease (COVID-19) epidemic among the general population in China. *Int J Environ Res Public Health.* 2020;17(5).
10. Huang Y, Zhao N. Generalized anxiety disorder, depressive symptoms and sleep quality during COVID-19 epidemic in China: a web-based cross-sectional survey 2 3. *Psychiatry Res.* 2020;112954.
11. Rossi R, Socci V, Talevi D, Mensi S, Ntoliu C, Di Marco A, et al. COVID-19 pandemic and lockdown measures impact on mental health among the general population in Italy. An N= 18147 web-based survey. *medRxiv.* 2020.
12. Roy D, Tripathy S, Kumar Kar S, Sharma N, Kumar Verma S, Kaushal V. Study of knowledge, attitude, anxiety & perceived mental healthcare need in Indian population during COVID-19 pandemic. *Asian J Psychiatr.* 2020;51:102083.
13. Spitzer RL, Kroenke K, Williams JB. Generalized anxiety disorder 7-item (GAD-7) scale. *Arch Intern Med.* 2006;166:1092–7.
14. Martin A, Rief W, Klaiberg A, Braehler E. Validity of the Brief Patient Health Questionnaire Mood Scale (PHQ-9) in the general population. *Gen Hosp Psychiatry.* 2006;28(1):71–7.
15. Liu N, Zhang F, Wei C, Jia Y, Shang Z, Sun L, et al. Prevalence and predictors of PTSS during COVID-19 Outbreak in China Hardest-hit Areas: Gender differences matter. *Psychiatry Res.* 2020;112921.
16. Su T-P, Lien T-C, Yang C-Y, Su L, Wang J-H, Tsai S-L, et al. Prevalence of psychiatric morbidity and psychological adaptation of the nurses in a structured SARS caring unit during outbreak:

- A prospective and periodic assessment study in Taiwan q. *J Psychiatr Res.* 2007;41(1-2):119-30.
17. Ybarra O, Burnstein E, Winkielman P, Keller MC, Manis M, Chan E, et al. Mental Exercising Through Simple Socializing: Social Interaction Promotes General Cognitive functioning. 2008;34(2):248-59.
  18. Whitty MT. Coping and defending: Age differences in maturity of defence mechanisms and coping strategies. *Aging Ment Health.* 2003;7(2):123-32.
  19. Liu X, Liu J, Zhong X. Psychological State of College Students During COVID-19 Epidemic. *Lancet.* 2020;SSRN 3552814.
  20. Blendon RJ, Benson JM, DesRoches CM, Raleigh E, Taylor-Clark K. The public's response to severe acute respiratory syndrome in Toronto and the United States. *Clin Infect Dis.* 2004;38(7):925-31.
  21. Mental health and psychosocial considerations during the COVID-19 outbreak, 18 March 2020. World Health Organization; 2020.

# Information Disclosure and Control on Online Social Network Sites among Medical Undergraduates

K. Sudha<sup>1</sup>, Sangeetha A.<sup>2</sup>, Kumaresan M.<sup>3</sup>, Paarthasarathy B.<sup>4</sup>

<sup>1</sup>Associate Professor, Department of Anatomy, SRM Medical College, SRM Institute of Science and Technology, Potheri, Kattankulathur 603203, Chengalpattu District, Tamilnadu, India, <sup>2</sup>Assistant Professor, Department of Physiology, Saveetha Medical College and Hospitals, Thandalam, Chennai-602105, <sup>3</sup>Assistant Professor, Department of Anatomy, Saveetha Medical College and Hospitals, Thandalam, Chennai-602105, <sup>4</sup>IIMBBS, Department of Physiology, Saveetha Medical College and Hospitals, Thandalam, Chennai – 602105

## Abstract

**Introduction:** Internet usage has become a big part of many people's lives, and among the many uses Social Networking Sites (SNS) which became very prevalent. How privacy concerns, trust and control are affecting SNS usage and self-disclosure has become an important question for many people.

**Aim:** Aim of the study is to assess the information disclosure and control on online social network sites among medical undergraduates.

**Methodology:** The study was conducted at Saveetha medical college and hospital among medical undergraduates. A questionnaire on usage of online social networks and information disclosures was administered and analysed it for reliability, social network site usage, privacy concerns, and disclosure of autobiographical memories.

**Result:** Almost 81.1% of the people feel that their browsing history were tracked by social networking sites. Instagram is mainly used app by medical undergraduates (40%).

**Conclusion:** There is an excess usage of social networking sites and easy information disclosure is seen in the population.

**Keywords:** Social networking sites, information disclosure, online

## Introduction

Internet usage has become an integral part of many people's daily lives. The uses are abundant: jobs, research, games, starting new relationships, maintaining old relationships, etc. Social networking sites are a prevalent use of the internet. According to a survey

conducted by Pew Research Center, roughly 85% of American adults use the internet and of these users about 67% use social networking sites<sup>(1)</sup>. Social networking sites have many benefits including allowing individuals to maintain contact without having to meet face to face, which allows people to maintain old relationships and start new relationships without having to meet in person with these other people. On the other hand, there are also possible problems associated with social networking sites, such as breaches of privacy.

Privacy is an individual's right to maintain editorial control and distributional control over personal information. Privacy is the right to determine how personal information is conveyed and who gets to know that information. There are privacy risks associated

---

### Corresponding Author:

**Dr. A. Sangeetha**

Assistant Professor, Department of Physiology,  
Saveetha Medical College and Hospitals, Thandalam,  
Chennai-602105

Mobile: +919444686966

e-mail id: sangeethasrmc@yahoo.com

with disclosing information that are affecting privacy concerns, even online. Privacy risks refer to one's personal information being accessed, used, or shared without any permission<sup>(3)</sup>. Identity theft and bullying are major online privacy risks. When it comes to sharing information on the internet, trust in others plays a central role. Online site trust is the expectation that one's vulnerabilities will not be taken advantage of in an online situation<sup>(2)</sup>.

Control is another important aspect of internet usage. Control refers to one's perception that through one's own actions one is able to cause positive outcomes and avoid negative outcomes. Perception is very important for this variable. Although actual levels of control are not always increased, most social network sites are trying to increase the perception of control. An increased perception of control has been shown to correlate with decreased estimates of personal risk<sup>(3)</sup>. This evidence supports control having an effect on social network site usage and self-disclosure, because decreased levels of personal risk should correlate with increased social network site usage and self-disclosure.

Self-disclosure is an important topic of research in the area of computer-mediated communication. Self-disclosure is a broad category which includes any self-relevant information which one discloses about themselves, including autobiographical memories and future plans. Autobiographical memories are memories for personal life experiences. Autobiographical memories are especially important for research studies on relationships and the management of privacy online<sup>(4)</sup>. There are two main types of autobiographical memories<sup>(5)</sup>. The first type is general autobiographical memories and these are points of general self-knowledge<sup>(6)</sup>. The second type is specific autobiographical memories and these are specific episodes lasting for less than a day<sup>(6)</sup>. The study aims to understand the use of social networking sites by the under-graduate medical students.

## Materials and Method

This study was conducted among a group (110) of medical undergraduate adolescents. Study participants were above 18 and below 23. The study was carried out after getting ethical committee approval (SMC/IEC/2018/11/337). In order to obtain the most accurate results, 50% (55) of the students have been selected through systematic random sampling method. Later, the survey method of research was applied to conduct the

study and questionnaire was used as a data collection tool. The purpose of the research is to explain the information disclosure and usage of various social networking sites and to validate it more accurately; a questionnaire has been prepared and circulated among the adolescent medical students. Participants rated these self-report questions on a Likert-type scale from 1 to 5 (never to always or strongly disagree to strongly agree). The questionnaire also included self-report questions assessing general and specific autobiographical memory disclosures online (e.g. Will you share bank details through social media) also using a Likert-type scale from 1 to 5 (strongly disagree to strongly agree). These questions were compiled into the self-disclosure scale.

## Results

Demographic distribution of respondents (N = 110). Majority (66%) of the population are willing to share their bank details only very rarely while a small fraction of 11.3% are willing to share it more often. Almost 81.1% of the people felt that their browsing history was tracked by social networking sites. Instagram is mainly used app by medical undergraduates. The next preferred app is facebook (50%) followed by snapchat. Majority of the people are willing to share to information online (66%) while (34%) are not willing to share their information online. About 71.7% of the participants feel safe in downloading stuff from unauthorised websites. A small proportion of 28.3% are not interested in it. A large number of the participants (50.9%) are downloading from unauthorised websites rarely while about 18.9% are downloading very often. Majority of the participants (56.6%) maintain anonymity in social media sites and about 43.4% are not doing so. Around 54.7% have the security software installed and about 45.3% do not have the required security software installed. About 77.4% of the participants are a victim of online frauds.

Around 81% of students were willing to share their residential address in the social networking sites. Only 18% of students were not willing to share. Fortunately, 66% of students were not willing to share the bank details and they want to keep it confidential. As stated above, only 22.4% of students were the victims of online banking frauds. Most of the students felt (81%) that their browsing history was tracked by social networking sites.

## Discussion

Numerous studies have been conducted on social networking sites all over the world due to the exponential

use of social networking sites globally in recent years. According to a researcher, social networking sites have become the most heavily used websites, and they are ranked as one of the top sites visited globally<sup>(6)</sup>. These sites have become an integral part of the daily personal, social and business lives of many people<sup>(7)</sup>. The students at large have started to widely make use of social networking sites; however, few students have shown reservations. Few don't show interest, few others don't have time, few have privacy concerns while few don't have the facility and others think that it isn't beneficial to use social networking sites. The privacy is one of the obstacles in social networking highlighted by many scholars all over the world<sup>(8)</sup>. Facebook was the first social network to surpass 1 billion registered accounts and currently sits at 1.59 billion monthly active users. Eighth-ranked photo-sharing app Instagram had over 400 million monthly active accounts<sup>(9)</sup>. The present study clearly states that around 40% of medical students are using Instagram as most common social networking site.

Social networking is everywhere today and is being used by people of all ages and for the widest variety of purposes<sup>(10)</sup>. Social networking tools are commonly used by individuals of all ages, but are used especially by young people and college students<sup>(11)</sup>. The demographic profile of social networking sites users varies, with junior and younger researchers more likely to be frequent users of social networking sites<sup>(12)</sup>. A study to assess the use of online social networking sites among the college students of a large urban university in Los Angeles has revealed that the students often used social networking sites to connect and reconnect with their friends and family members<sup>(13)</sup>.

### Conclusion

The results of this study examine many aspects related to the usage of SNSs by students; however, there are several areas that need to be addressed in future research. Further studies are needed to examine additional issues of SNSs such as legal, ethical and intellectual aspects. The potential risks of the research are minimal. Additionally, future studies can be conducted on academic use of SNSs in educational institutions.

**Conflict of Interest:** No conflict of interest

**Funding:** This is Self-funded

### Reference

1. Pew Research Center. Pew Internet & American Life Project Tracking. Retrieved October 22, 2013, from [http://pewinternet.org/Trend-Data-\(Adults\)/OnlineActivites-Total.aspx](http://pewinternet.org/Trend-Data-(Adults)/OnlineActivites-Total.aspx)
2. Beldad, A., Jong, M. d., & Steehouder, M. How shall I trust the faceless and the intangible? A literature review on the antecedents of online trust. *Computers in Human Behavior*, 2010; 26, 857-869.
3. Cho, H., Lee, J., & Chung, S. Optimistic bias about online privacy risks: Testing the moderating effects of perceived controllability and prior experience. *Computers in Human Behavior*, 2010; 26, 987-995.
4. Taddei, S. & Contena, B. Privacy, trust and control: Which relationships with online self-disclosure? *Computers in Human Behavior*, 2013; 29, 821-826.
5. Klein, S. B., Robertson, T. E., Gangi, C. E., & Loftus, J. The functional independence of trait self-knowledge: commentary on sakaki Memory, 2008; 16, 556-565.
6. Conway, M. A. Memory and the self. *Journal of Memory and Language*, 2005; 53, 594- 628.
7. Elena Lidia Alexa, M. A. a. C. M. S. The Use of online marketing and social media in highereducation institutions in Romania. *Journal of Marketing Research & Case Studies*, 2012; Vol. 2012
8. Hussain, Dr & Loan, Fayaz. The use of social networking sites (SNS) by the post-graduate students. 2017; 7, 72-84.
9. Statista. Leading social networks worldwide as of April 2016, ranked by number of active users (in millions). 2016.
10. Perryman, B.E. Use of social networking as an instructional aide in higher education. PhD dissertation, OK State University, Stillwater, OK. 2011.
11. Bhardwaj, R. K. Use of Social Networking Sites by LIS Professionals in Higher Education Institutions in India: A Study. *The Reference Librarian*, 2014, 55(1), 74-88,
12. Na'ndez, G. and Borrego, A. Use of social networks for academic purposes: a case study. *The Electronic Library*, 2012, 31(6), 781-791.
13. Subrahmanyam, K., Reich, S. M., Waechter, N., & Espinoza, G. Online and offline social networks: Use of social networking sites by emerging adults. *J. App. Dev. Psych.*, 2008, 29(6), 420-33.

# Factors Related to Deaths Due to Suicides in Females Aged 12-24 Years

Kandagatla Krishnamurthy<sup>1</sup>, Shruthi Reddy Jillella<sup>2</sup>, Abhijith Subedhar<sup>3</sup>

<sup>1</sup>Tutor, Department of Forensic Medicine, Government Medical College, Nalgonda, Telangana, <sup>2</sup>Senior Resident, Department of Forensic Medicine, Gandhi Medical College, Secunderabad, Telangana, <sup>3</sup>Professor, Department of Forensic Medicine, Osmania Medical College, Hyderabad, Telangana

## Abstract

**Background:** Suicide is a global health problem occurring in all parts of the world. It was the second leading cause of death among 15-29 year olds in 2016. Hence, an understanding of specific factors related to suicide would enable prevention strategies to be more sensitive.

**Method:** A cross sectional study was conducted in Department of Forensic Medicine, Gandhi Medical College, Secunderabad, which included all cases of suicidal deaths in females in the age group of 12-24 years in the period of January 2017 to November 2018.

**Results:** Majority cases belonged to the age group of 19-24 years (49%). Many victims were from rural area (60%), belonging to middle socioeconomic status (57%) and unmarried (80%). Majority of the victims were graduates i.e. 32% and 55% of them were students. The leading motive behind the suicides was emotional disturbances (21%). Hanging is the most commonly adopted method to commit suicide i.e. 53% of deaths.

**Conclusions:** Most of the factors related to suicide are preventable. Suicides among the young can be prevented by starting student guidance clinics and should also incorporate woman specific strategies like providing education, economic security and empowerment of women.

**Keywords:** *Suicides, females, adolescents, method of suicide, socio-economic factors.*

## Introduction

Suicide is a willful and voluntary act of a person who understands the physical nature of the act, and intends by it to accomplish the result of self-destruction. It is the deliberate termination of one's existence, while in the possession and enjoyment of his mental faculties.<sup>1</sup> Suicidal behavior includes thinking about suicide (or Ideation), planning for suicide, attempting suicide and suicide itself.<sup>2</sup>

Suicide is a major public health problem all over the world. The world health organization (WHO) reports that every year more than 8,00,000 people die from suicide and it was the second leading cause of death among 15-29 year-olds globally in 2016.<sup>2</sup> The results of a 2012 Lancet study on death by suicide in India exposed a shocking trend of suicide among adolescents, which showed that a large proportion of suicidal deaths occurred between the ages of 15 years and 29 years, especially in women.<sup>3</sup> Adolescence is a stage of transition which needs mental capability, personality building and social adaptation. It has been observed that there is often a pressure to succeed over academics, relationship and self-identity during adolescence. Failure to overcome these challenges may lead to psychological distress and suicide.<sup>4</sup> A greater understanding of region-specific factors related to suicide would enable prevention strategies to be more culturally sensitive.<sup>5</sup>

---

### Corresponding Author:

**Dr. Shruthi Reddy Jillella**

Senior Resident, Department of Forensic Medicine,  
Gandhi Medical College, Secunderabad, Telangana  
e-mail: jillella.reddy9@gmail.com  
Mobile Number: 9177694382

The female suicidal behaviour in terms of total burden of morbidity and mortality combined is more in women than in men.<sup>6</sup> Women's greater vulnerability may be due to gender related vulnerability to various psychopathology and psychosocial stressors. Current data fails to accurately depict the major female contribution to this public health problem.<sup>6</sup> This study aims to identify the factors and precipitating causes that are responsible for suicidal deaths in females in 12-24 years age group.

### Materials and Method

This was a cross sectional study done in the Department of Forensic Medicine Gandhi Medical College and Hospital, Secunderabad. The study included all cases of suicidal deaths in the age group of 12-24 years which were brought to mortuary for post mortem examination over a study period of 22 months (January 2017- November 2018). In cases where there was advanced decomposition and the cause of death could not be determined and in suspected poisoning cases where Chemical Analysis Report of Forensic Science Laboratory was negative, were excluded from the study. Socio-demographic variables and details about manner

of death were obtained from reliable attendants of the deceased, hospital records, police records and inquest reports. Other details were obtained from the Post-mortem examination and Forensic Science Laboratory and Histopathologyreports. The family members, relatives and friends were fully explained about the questionnaire and then verbal consent was taken from each individual before asking about the relevant details pertaining to the study and thus a total of 100 cases were analysed. Data was analysed using SPSS software and descriptive analysis was done. Data are presented in the form of text, tables and figures.

### Results

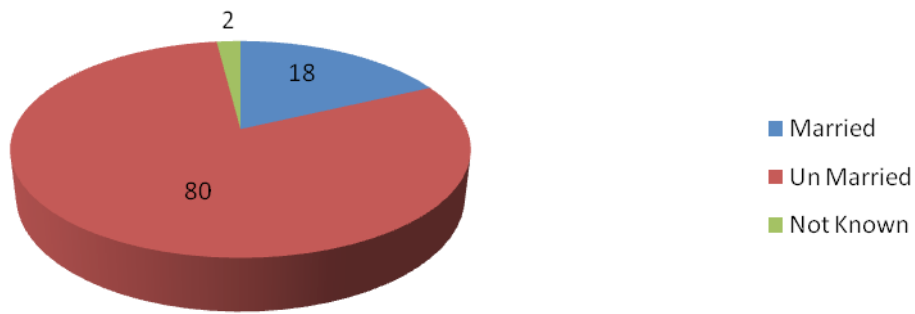
The Total study group has been divided into 3 sub-groups i.e., 12- 15 years, 16-18 years and 19-24 years. The highest number of cases were recorded in the age group of 19-24 group i.e. 49 cases (49%), followed by 16-18 years group which recorded 38 Cases (38%) and the least number of cases were seen in 12-15 age group with 13 Cases (13%). In this study, the highest number of cases were recorded in the Hindus i.e. 94 cases (94%) followed by, Muslims which recorded 6 Cases (6%).

**Table 1: Socio-economic factors related to suicide**

Factors		Number of deaths	% of deaths
Geographical Area	Urban	40	40
	Rural	60	60
Socio-Economic Status	Upper Class	1	1
	Lower Class	40	40
	Middle Class	57	57
	Not Known	2	2
Educational Status	School	19	19
	Intermediate(10+2)	22	22
	Graduate	32	32
	Illiterate	9	9
	Not Known	18	18
Occupation	Student	55	55
	Employee	13	13
	House Wife	13	13
	Laborer	9	9
	No Occupation	7	7
	Not Known	3	3



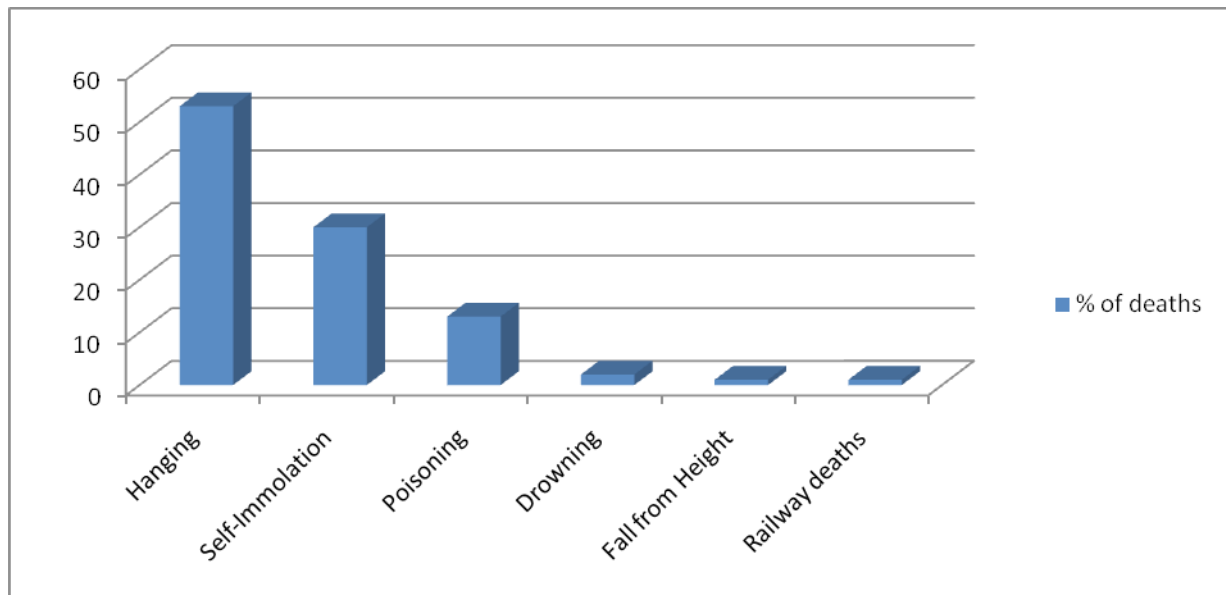
### Marital Status



**Fig 1: Marital status victims in deaths due to suicide in females aged 12-24 years**

In this study group, 7(7%) cases of suicidal deaths occurred during menstruation. 1 (1%) victim who committed suicide was pregnant. In 92 (92%) of the cases, hormonal status of the victim was not known. According to the present study, in 24(24%)deaths, the motive behind the suicide was not known. In the remaining deaths, the leading motive behind the suicide was emotional disturbances amounting to 21 (21%)

deaths. The other motives in the decreasing order of frequency were illness and love related issues sharing 13(13%) each, failure in exams and economic problems sharing same percentage i.e. 9(9%) each, marriage related issues i.e. 6(6%) of deaths, harassment for dowry i.e. 4(4%) deaths and the least motive behind the suicide was death of a family member i.e. 1(1%) of deaths.



**Fig 2: Cause of death due to suicide in females aged 12-24 years**

### Discussion

This study was conducted for over a period of 22 months in the mortuary of a Tertiary care centre i.e. Gandhi Medical College and Hospital, Secunderbad, Telangana, India.

According to the present study, the age group that constituted majority of deaths belonged to 19-24 years (49%) subgroup, similar to study conducted by Khan et alin 2005.<sup>7</sup> This was followed by 16-18 years age group which recorded 38% and the least number of cases

were seen in 12-15 age group i.e. 13%. Subjects from early study age groups (12-15 years) recorded deaths in lesser numbers. This may be due to unawareness of the suicide or submissiveness of the adolescent to their parents and society. Whereas it was more common in the late teenagers and young adults group (16-24 years), because of their short temperedness, social adjustment and hormonal surge issues, they became vulnerable for committing suicide. A study conducted by Aaron Ret al in southern India, concluded that youth is a period of increased risk of suicide and it is a leading cause of death among young people in India.<sup>8</sup> As per the study, suicides accounted for 75% of all deaths in young women.<sup>8</sup> A study by Omigbodun OO et al highlighted the role of media in providing information about various method of suicide among the youth.<sup>9</sup> In the present study, the highest number of cases were recorded in the Hindus i.e. 94 cases (94%) due to a higher percentage of Hindus in general population. Followed by, Muslims which recorded 6 Cases (6%). The findings were similar to study by Kanchan T et al conducted in 2008 at Manipal, Karnataka.<sup>10</sup>

There is a major impact of various socio-economic factors in the risk of suicides. As per this study, it is observed that the victims predominantly belonged to the Rural group i.e. 60 cases (60%), followed by Urban group which recorded 40 Cases (40%), which is similar to study conducted by Sachinanda et al in 2003, where majority of the victims also belonged to the rural background.<sup>11</sup> The higher incidence in rural areas is due to poverty, low education level, easy availability of poisonous substances like pesticides and lack of emergency care. In the current study, most of the deaths were noted in the Middle Class category accounting up to 57%, followed by Lower class category (40%) and least deaths were seen among the upper class category (1%) but study by Sachinanda et al, showed majority of cases belonged to a lower socio-economic class.<sup>11</sup> Majority of the deaths in middle and lower class population were due to lack of awareness and social stigma related with mental health disorders.

According to the present study, most deaths were noted in Graduates (32%) which is followed by Intermediate students (22%) and the least percentage of victims were seen in Illiterate category (9%). The findings are comparable to study that was conducted by Chavan et al in 2008, where majority of the cases were matriculates.<sup>12</sup> In the current study, majority of the deaths were noted among students (55%) followed

by Employees & House wives, who were at the same rate i.e., 13%. In this study, the students were most vulnerable group to commit suicide as they were under pressure to excel in studies. Sexual challenges, emotional issues, low self-esteem or insecurities, family or financial problems and even substance addiction may play an important part.

A study by Owens SA et al stated that some phases in menstrual cycle are linked to suicidal risk, predominantly among hormone-sensitive women, such as those with premenstrual dysphoric disorder or premenstrual exacerbation of a psychiatric disorder.<sup>13</sup> In this study group, 7% of the suicides were committed during their menstruation phase. 1% suicidal deaths were seen in pregnant women. Majority of the deaths were seen among the unmarried women (80%) when compared to married women (18%), similar to studies by Chavan et al and Sarkar et al.<sup>12,14</sup> Unmarried and single women are usually more prone to depression.

The most common motives behind suicide as per study conducted by Bastia B.K. et al were marriage related issues followed by failure in examinations.<sup>15</sup> In the present study, in 24% of the death cases, the motive behind the suicide is not known. But, in the remaining deaths, the leading motive behind the suicide is emotional disturbances triggered by arguments at home, amounting to 21% deaths. The other motives were illness and love related issues, failure in exams, economic problems, marriage related issues, harassment for dowry and death of a close family member.

According to the current study, Hanging is the most commonly adopted method to commit suicide i.e. 53% of deaths. This is consistent with findings of other similar studies by Sachinanda et al, Chavan et al and Shaw et al, where hanging was the most common cause of suicidal death.<sup>11,12,16</sup> The other means adopted to commit suicide in the decreasing order of percentage of deaths are Self Immolation which constituted 30% of the deaths, 13% of the deaths were due to poisoning, 2% were due to drowning, and 1% each for fall from height and railway injuries.

## Conclusion

Though suicide is a multi-factorial problem, most of these factors are either preventable or controllable. According to this study, students belonging to middle and lower socioeconomic status and residing in rural areas formed the most vulnerable group for suicides.

Suicides among the young can be prevented by setting up of student guidance clinics not only to improve their psychological well-being, but also to enable them to explore their own potential to engage themselves in today's world with immense avenues. The educational system must be changed to promote holistic development of the child, rather than giving undue emphasis on academic achievements alone. Various mental health training programs must be conducted periodically for the medical officers and paramedical personnel of district hospitals and primary health care centers especially in rural areas, so that they can be trained in early detection and preliminary management of mental illnesses.

Suicide prevention programmes should also incorporate woman specific strategies which include providing education, economic security and empowerment of women. Proper assessment of the symptoms and prompt treatment for women suffering from physical illness and mood disorders should be done.

**Ethical Clearance:** Taken from Institutional Ethical Committee, Gandhi Medical College.

**Conflict of Interest:** Nil

**Source of Funding:** Nil

### References

1. Ping NY, Panirselvam RR. The Endgame of Section 309? An Appeal for Decriminalisation of Suicide. *Malaysian Journal Of Psychiatry*. 2019; 28(1): 1-4.
2. World Health Organization 2014. Preventing suicide: a global imperative. World Health Organization. Available at: <https://apps.who.int/iris/handle/10665/131056>
3. Patel V, Ramasundarahettige C, Vijayakumar L, Thakur JS, et al. Suicide mortality in India: A nationally representative survey. *Lancet* 2012; 379(9834):2343-51. [https://doi.org/10.1016/S0140-6736\(12\)60606-0](https://doi.org/10.1016/S0140-6736(12)60606-0)
4. Pisani AR, Schmeelk-Cone K, Gunzler D, Petrova M, et al. Associations between suicidal high school students' help-seeking and their attitudes and perceptions of social environment. *J Youth Adolesc*. 2012; 41(10):1312-24. doi: 10.1007/s10964-012-9766-7.
5. Radhakrishnan R, Andrade C. Suicide: An Indian perspective. *Indian J Psychiatry*. 2012; 54(4): 304-19. doi: 10.4103/0019-5545.104793
6. Vijayakumar L. Suicide in women. *Indian J Psychiatry*. 2015; 57(2): 233-8.
7. Khan FA, Anand B, Devi MG, Murthy KK. Psychological autopsy of suicide-a cross-sectional study. *Indian J Psychiatry*. 2005;47:73-8.
8. Aaron R, Joseph A, Abraham S, Muliyl J, et al. Suicides in young people in rural southern India. *Lancet* 2004; 363(9415):1117-8. doi: 10.1016/S0140-6736(04)15896-0.
9. Omigbodun OO, Adejumo OA, Babalola OO. Suicide attempt by Hanging in preadolescent children: a case series. *West Afr j Med*. 2008;27(4):259-62.
10. Kanchan T, Menezes RG. Suicidal hanging in Manipal, South India – Victim profile and gender differences. *Journal of Forensic and Legal Medicine*. 2008 Nov; 8(15):493-6
11. Sachidananda M, Sahu M, Mohanty MK, Patnaik M. Suicide in India: A four year retrospective study. *J. Forensic Leg Med*. 2007; 14(4):185-9.
12. Chavan BS, Singh GP, Kaur J, Kochar R. Psychological autopsy of 101 suicide cases from northwest region of India. *Indian J Psychiatry*. 2008;50:34-8.
13. Owens SA, Eisenlohr-Moul T. Suicide Risk and the Menstrual Cycle: A Review of Candidate RDoC Mechanisms. *Curr Psychiatry Rep*. 2018 Oct; 20(11): 106. doi: 10.1007/s11920-018-0962-3.
14. Sarkar P, Sattar PA, Gode N, Basannar DR. Failed suicide and deliberate self-harm: A need for specific nomenclature. *Indian J Psychiatry*. 2006; 48(2):78-83. doi: 10.4103/0019-5545.31594
15. Bastia BK, Kar N. A Psychological Autopsy Study of Suicidal Hanging from Cuttack, India: focus on stressful life situations. *Arch Suicide Res*. 2009;13(1):100-4.
16. Shaw D, Fernandes JR, Rao C. Suicide in children and adolescents: A 10 year retrospective review. *J Forensic Med Pathol*. 2005;26(4):309-15.

# Method of Ventral Hernia Repair: Our Experience

Ketul Shah<sup>1</sup>, Ankur Jain<sup>2</sup>, Vipul Gurjar<sup>3</sup>, Anant Shah<sup>3</sup>

<sup>1</sup>Assistant Professor, <sup>2</sup>PG Resident, <sup>3</sup>Professor, Department of General Surgery, Dhiraj General Hospital, Smt. B.K. Shah Medical Institute and Research Centre. Sumandeep Vidyspeeth Deemed to be University (An Institution), Pipariya, Vadodara

## Abstract

**Background:** Ventral hernias result from weakness in the musculofascial layer of the anterior abdominal wall. Ventral hernia can be operated through open or laparoscopic approach. Moreover, there are various options available for mesh placement during the repair. We here report our experience in surgical management of ventral hernias along with review of published literature along with laparoscopic repair of ventral hernias.

**Method:** It was a retrospective study of patients who were operated for ventral hernias over a period of 4 years in a teaching hospital of Vadodara SBKS research institute Dhiraj Hospital. All patients irrespective of age and sex were included. All patients were evaluated by obtaining proper history and performing detailed physical examination and routine blood investigations. Various intra operative and postoperative parameters were observed and reported.

**Conclusions:** The ventral hernia repair can be done by open and laparoscopic technique. Each has its own advantages and disadvantages. There is no conclusively guidelines about the superiority of one technique over the other and also no conclusively guidelines for the proper position of mesh placement. The clear advantages of open technique is avoidance of general anesthesia in many cases (as many ventral hernia repairs can be done under local anaesthesia), lesser learning curve, cheap meshes can be used, easy to learn, no requirement of any sophisticated instruments or OT setup and trained staff. The disadvantage of laparoscopic technique includes the requirement for general anaesthesia (as many ventral hernias can be performed with local anaesthesia in open technique), need to transverse the abdominal cavity, prolonged learning curves, requirement of costly meshes and sophisticated equipment and technical staff. However, laparoscopy has advantage over open hernia repair in terms of reduced postoperative pain, decreased postoperative complications, reduced length of hospital stays, less time for return to normal activity and bettercosmesis.

**Keywords:** *Hernia repair, Incisional hernia, Laparoscopic, Open, Ventral hernia.*

## Introduction

Ventral hernia are happening because of shortcoming in the musculofascial layer of the foremost stomach

divider<sup>[1]</sup>. The evaluated occurrence of ventral hernia is 15-20%<sup>[2]</sup>. They are grouped into incisional, umbilical, paraumbilical, epigastric and spigelian hernia<sup>[3, 4]</sup>. Most normal are incisional hernia after a stomach activity<sup>[5]</sup>. It is assessed that 2-10% of every single stomach activity result in incisional hernia<sup>[2]</sup>. Essential tissue fix should be possible in little hernias (<2.5 cms distance across). In any case, odds of repeat increments if essential tissue fix is accomplished for bigger hernias (> 2.5 cms in breadth). Thusly, the possibility of strain free fix utilizing prosthetic work is generally acknowledged. Prosthetic work has diminished repeat to irrelevant rates.<sup>[6]</sup>

---

### Corresponding Author:

**Dr. Ketul Shah**

Assistant Professor, Department of General Surgery, Dhiraj General Hospital, Smt. B.K Shah Medical Institute and Research Centre. Sumandeep Vidyspeeth Deemed to be University (An Institution), Pipariya, Vadodara

Phone: 9724507634

For laparoscopic ventral hernia repair, the mesh

is routinely placed in the intra-peritoneal position. However, for open surgery, there are numerous options for mesh placement [7]. Only repair places the mesh on the anterior fascia which typically involves the dissection of flaps and primary closure of the fascia below the mesh. Inlay repair places the mesh in the hernia defect and secure the mesh circumferentially to the edges of the fascia. Sublay repair refers to retro-rectus preperitoneal mesh placement. Finally in underlay repair mesh is placed in intraperitoneal position and secured to the anterior abdominal wall, a technique popularized with the advent of laparoscopy [7].

The ideal position for placement of mesh has not been conclusively established [8, 9]. Polypropylene mesh is regarded as the implant of choice for repairing abdominal wall defects [8, 10]. Here we report our experience in surgical management of ventral hernias. We also reviewed our results with other studies, along with laparoscopic repair of ventral hernias.

### Methodology

It was a retrospective study of patients who were operated for ventral hernias over a period of 2.5 years in a teaching hospital of vadodra SBKS research institute Dhiraj Hospital. All patients irrespective of age and sex were included. All patients were evaluated by obtaining proper history and performing detailed physical examination and routine blood investigations. All patients received antibiotic prophylaxis half an hour before surgery. Most patients were operated under spinal anesthesia. Foleys catheterization and nasogastric tube were occasionally used. Anatomical repair was done for smaller hernias (<2.5 cms in diameter) whereas mesh repair was done for larger hernias (>2.5 cms in diameter). In onlay repair, polypropylene mesh was sutured over the anterior rectus sheath, whereas in sublay technique, the mesh was placed in the preperitoneal space. The mesh was fixed with nonabsorbable sutures. Anterior rectus sheath was closed over the mesh by nonabsorbable sutures. Suction drain was placed based on the surgeon's choice.

The patients were started on oral liquids 8 to 12 hours after the surgery in open mesh repair. Soft diet was started thereafter. Good analgesic coverage was provided with injection diclofenac/injection tramadol in early postoperative period which helped in early ambulation and recovery. Patients were encouraged for sitting up in the bed and advised early movements

and activity. The wound was inspected for any seroma, hematoma, or infection. The drains were removed when the collection was less than 30 ml for 2 consecutive days. Patients were discharged after complete ambulation and tolerating normal diet.

### Results and Observations

The study included 95 patients with 46 males (48.42%) and 49 females (51.58%) with male: female ratio of 1:1.07. The commonest type of hernias encountered were incisional hernias (76.84%), followed by paraumbilical (11.58%), epigastric (8.42%), umbilical (3.16%) Table-1. The common index surgeries were gynecological and obstetrical surgeries

**Table-1: Demographic parameters.**

Variables	Open ventral hernia repair (n=95)
Mean age (range) in years	36.2(14-78) yrs
<b>Gender Distribution</b>	
Males	46(48.42%)
Females	49(51.58%)
Male : Female	1 : 1.07
<b>Types of hernia</b>	
Umbilical	3(3.16%)
Incisional	73(76.84%)
Epigastric	8(8.42%)
Paraumbilical	11(11.58%)
<b>Total</b>	<b>95(100%)</b>

**Table 2: Index of Surgery**

Index surgery	No. of Patients
Peptic perforation	11
Cholecystectomy (kocher's)	7
Enteric perforation	9
Tubercular perforation	9
Ruptured liver abscess	2
Prostatectomy	2
Pyelolithotomy	2
Appendectomy	7
Hysterectomy	10
Caesarean section	8
Post-tubectomy	4
Ovarian cystectomy	2
<b>Total</b>	<b>73</b>

The mean size of defect was 3.36 cm<sup>2</sup>. The mean number of defects encountered were 1.4 (1-3). The content of most hernias was bowel loops (56.84%), followed by omentum (43.16%). Anatomical repair was done in 18.95% of patients and mesh repair was done in 81.05% of patients. Polypropylene was used in all the cases. Onlay fixation was done in 67.53% and sublay in 32.47% patients. Suction drain was used in 85.26% patients. We met with single episode of accidental enterotomy (1.05%) while dissection which was primarily closed, mesh was placed & postoperative period was unremarkable. The average operative time was 98.30 minutes in our study Table-3.

Table-3: Intra-operative parameters

<b>Mean defect size</b>	<b>3.36 cm<sup>2</sup></b>
No. of defects	1.4(1-3)
<b>Contents of hernia</b>	
Omentum	41(43.16%)
Bowel loops	54(56.84%)
<b>Technique of repair</b>	
Anatomical	18/95(18.95%)
Hernioplasty	77/95(81.05%)
Type of mesh used	Polypropylene
<b>Site of mesh placement</b>	
Onlay	52/77(67.53%)
sublay	25/77(32.47%)
Drain used (no. of patients)	81/95 (85.26%)
<b>Intra-operative complications</b>	
Enterotomy	1/95 (1.05%)
Operative time(in minutes)	98.30 min

Table-4: Post-operative parameters.

<b>Mean Analgesia required (in terms of no. of times analgesic drug administered)</b>	<b>6.4(2-10)</b>
<b>Post-operative complications.</b>	
Overall	23/95,(24.21%)
Superficial woundinfection	9/95,(9.47%)
Deep woundinfection	5/95,(5.26%)
Meshinfection	1/95,(1.05%)
Flap necrosis	1/95,(1.05%)
Seroma	7/95,(7.37%)
Mean Post-operative hospital stay (in days)	4.22 (1-18)

The average requirement of analgesia was 6.4 times in our study. Overall postoperative complication rate was 24.21%. Most of them were superficial wound infections (9.47%) and seroma formation (7.37%). All

of which were managed conservatively. One of the patient developed mesh infection, but it was successfully managed with regular wound toileting with betadine, hydrogen peroxide and metrogyl-soaked gauze packing of the wound. The mean length of the post-operative hospital stay was 4.22 days (1-18 days) (table 4).

“The overall recurrence rate was 7.37% in our study at an average follow-up period of 12.02 months (3-28 months)”. Anatomical repair showed more recurrence rate (22.22%) than those with mesh hernioplasty (3.9%) Table-5.

Table-5: Follow-up and recurrences

Follow-up (in months)	12.02(3-28 months)
<b>Recurrence rate</b>	
Overall	7/95(7.37%)
Anatomicalrepair	4/18(22.22%)
Hernioplasty	3/77(3.90%)



Figure 1: Onlay repair with suction drain

### Discussion

Ventral hernia in the anterior abdominal wall includes both spontaneous and most commonly, incisional hernia after an abdominal surgery<sup>5</sup>. Since the success of hernia repair surgery is usually reflected in terms of hernia recurrence after the repair, hernia recurrence is distressing to the patient and embarrassing to surgeons. The use of prosthetic mesh has revolutionized the field of hernia repair by providing tension free repair. More recently with introduction of laparoscopy in the field of surgery, the trend of laparoscopic ventral hernia repair is on rise. But with disadvantages of requirement for general anesthesia (as many ventral hernias can be performed with local anesthesia in open technique), need to transverse the abdominal cavity, prolonged learning curves, requirement of costly meshes and sophisticated equipment and technical staff makes laparoscopic hernia repair account for minority of cases performed

worldwide [11]. However, laparoscopy has advantage over open hernia repair in terms of reduced postoperative pain, decreased postoperative complications, reduced length of hospital stay, less time for return to normal activity and bettercosmesis<sup>12</sup>.

The present study consisted of 95 patients, 46 males and 49 females with male: female ratio of 1:1.07. The commonest index surgery reported was gynaecological/obstetrical operation. Most common site of ventral hernia was lower abdominal, again reflecting higher incidence of gynaecological obstetrical operation. The mean surgerytime in our study was 98.30 minutes, which is longer than that published in literature for laparoscopic ventral hernia repair surgery, which reflects the more time involved in dissection and securing haemostasis (95 minutes in Park *et al.*,<sup>[13]</sup> 87 minutes in Carbaja *et al.*,<sup>[14]</sup> 56 minutes in Rameshaw *et al.*,<sup>[15]</sup> 55 minutes in Badiger S *et al.*,<sup>[16]</sup>. With respect to intraoperative complications, there was single episode of inadvert enterotomy while dissection which was primarily closed as it involved no spillage, mesh was placed and later postoperative period was uneventful.

The overall incidence of wound infection in our study was 24.21%. Since the amount of tissue dissection needed in open ventral hernia repair is more, the chances of wound related complications is more. Such complications are lower in laparoscopic ventral hernia repair as it does not need much of abdominal wall dissection. Most of the wound infections can be managed conservatively by local wound toilets and antibiotics. Removal of mesh is rarely required. For open mesh repair, the wound related complications range from 3.5%-18%<sup>[17-29]</sup>, with an average of 8.1%; whereas for laparoscopic repair it is overall 2%<sup>[11,17]</sup>.

The average number of times the analgesic drug administered in our study was 6.4. The literature<sup>[11, 17]</sup> reported a lower rate of requirement for analgesia in laparoscopic hernia repair than open technique as it involves lesser tissue dissection and avoidance of sutures as done in open ventral hernia repair. For the similar reason the early ambulation and hospital stay is prolonged in open ventral hernia repair then in laparoscopic repair.

Our study reported an average of 4.22 days as mean length of postoperative hospital stay for open ventral hernia repair. Syed JF Qadri *et al.*,<sup>[17]</sup> reported

1.53 days as mean hospital stay in laparoscopic

incisional hernia repair group compared to 4.33 days in open hernia repair group. Similarly, Park *et al.*,<sup>[14]</sup> reported 3.4 days for laparoscopic repair group and 6.5 days for open hernia group; Rameshaw *et al.*,<sup>[15]</sup> reported 1.7 days for laparoscopic repair group and 2.8 days for open hernia repair; and Badiger S *et al.*,<sup>[16]</sup> reported 2.6 days for laparoscopic repair group and 6.8 days for open repair group.

In various studies of open and laparoscopic incisional hernia repair, the recurrence rate reported is 0-12.5%.for.laparoscopic.repair,.with.an.average.of

5.97 %; and 0-13% for open technique,17 an average of 6.22 %<sup>[12]</sup>. Ramshaw *et al.*, reported a recurrence rate of 7% in open group and 0% in laparoscopic group at an average follow up for 21 months for each group. Pringet *et al.*, reported a recurrence rate of 4.16 in open group and 3.3% in laparoscopic group at an average follow-up. period of 27.5 months for each group. Itani *et al.*, reported a recurrence rate of 8.2 % in open group and 12.5% in laparoscopic group at an average follow-up period of 24 months Thota *et al.*,<sup>[12]</sup> reported a recurrence rate of 0% in both open and laparoscopic repair group at an average follow-up period of 13.25 months in open group and 10.5 5 months laparoscopicgroup.

## Conclusion

Thus, in conclusion, the ventral hernia repair can be done by open and laparoscopic technique. Each has its own advantages and disadvantages. There is no conclusively guidelines about the superiority of one technique over the other and also no conclusively guidelines for the proper position of mesh placement. It was rightly mentioned in Author's previous article<sup>[11]</sup> that surgeons should not perform laparoscopic hernia procedure simply because it is relatively new or potentially economic; they should perform only when convinced that it is anatomically and physiologically correct and logical. Surgeons must be proficient in laparoscopic techniques and must have a precise knowledge of anatomy.

The advantages of open technique is to avoid of general anaesthesia in many cases (as many ventral hernia repairs could be done under local anaesthesia), lesser learning curve, cheap meshes can be used, easy to learn, no requirement of any sophisticated instruments or OT setup and trained staff. The disadvantage of laparoscopic technique includes the requirement for general anaesthesia (as many ventral hernias can be performed with local anaesthesia in open technique),

need to transverse the abdominal cavity, prolonged learning curves, requirement of costly meshes and sophisticated equipment and technical staff. However, laparoscopy has advantage over open hernia repair in terms of reduced postoperative pain, decreased postoperative complications, reduced length of hospital stay, less time for return to normal activity and better cosmesis.

**Ethical Clearance:** Taken from sumandeep vidyapeeth institutional ethics committee

**Source of Funding:** Self

**Conflict of Interest:** Nil.

### References

1. Stumpf M, Conze J, Klinge U, Rosch R, Schumpelick V. Open mesh repair. *Eur Surg.* 2003;35(1):21-24.
2. de Vries Reilingh TS, van Geldere D, Langenhorst BL, de Jong D, van der Wilt GJ, van Goor H, Bleichrodt RP. Repair of large midline incisional hernias with polypropylene mesh: comparison of three operative techniques. *Hernia.* 2004 Feb 1;8(1):56-9.
3. Holihan JL, Nguyen DH, Nguyen MT, Mo J, Kao LS, Liang MK. Mesh location in open ventral hernia repair: a systematic review and network meta-analysis. *World journal of surgery.* 2016 Jan 1;40(1):89-99.
4. Raghuvveer MN, Muralidhar S, Shetty H, Veena V. Onlay versus sublay mesh repair for ventral hernia. *International Surgery Journal.* 2018 Feb 26;5(3):823-6.
5. Strâmbu V, Radu P, Bratucu M, Garofil D, Iorga C, Iorga R, Popa F. Rives technique, a gold standard for incisional hernias—our experience. *Chirurgia (Bucur).* 2013 Jan1;108(1):46-50.
6. Petro CC, Posielski NM, Raigani S, Criss CN, Orenstein SB, Novitsky YW. Risk factors for wound morbidity after open retromuscular (sublay) hernia repair. *Surgery.* 2015 Dec 1;158(6):1658-68.
7. Naikoo GM, Singh B, Jeelani Shaukat, Rajput N, Sofi IA, Choudhary MH, Banotra A. Open And Laparoscopic Inguinal Hernia Repair: Our Experience. *IJSR;* 2018May;7(5):3-4.
8. Thota A, Ravishankar KS, Rao KV, Ramesh BS, Ananda BB. Comparative study between open and laparoscopic ventral hernia repair: A prospective non-randomized single institutional study. *Journal of Dr. NTR University of Health Sciences.* 2017 Oct1;6(4):217-23.
9. Park A, Birch DW, Lovrics P. Laparoscopic and open incisional hernia repair: a comparison study. *Surgery.* 1998 Oct 1;124(4):816-22.
10. Carbajo MA, Del Olmo JM, Blanco JI, De la Cuesta C, Toledano M, Martin F, Vaquero C, Inglada L. Laparoscopic treatment vs open surgery in the solution of major incisional and abdominal wall hernias with mesh. *Surgical endoscopy.* 1999 Mar1;13(3):250-252.
11. Ramshaw BJ, Esartia P, Schwab J, Mason EM. Comparison of laparoscopic and open ventral herniorrhapy. *The American Surgeon.* 1999 Sep 1;65(9):827-31.
12. Badiger S, Koppad SN, Kulkarni A, Kodliwadmath H. Comparative analysis of open versus laparoscopic ventral hernia repair. *International Surgery Journal.* 2016 Dec 9;3(3):1167-72.
13. Qadri SJ, Khan M, Wani SN, Nazir SS, Rather A. Laparoscopic and open incisional hernia repair using polypropylene mesh-A comparative single centre study. *International Journal of Surgery.* 2010 Jan1;8(6):479-83.
14. Carbajo MA, Del Olmo JM, Blanco JI, De la Cuesta C, Toledano M, Martin F, Vaquero C, Inglada L. Laparoscopic treatment vs open surgery in the solution of major incisional and abdominal wall hernias with mesh. *Surgical endoscopy.* 1999 Mar 1;13(3):250-252.
15. Ramshaw BJ, Esartia P, Schwab J, Mason EM. Comparison of laparoscopic and open ventral herniorrhapy. *The American Surgeon.* 1999 Sep 1;65(9):827-31.
16. Badiger S, Koppad SN, Kulkarni A, Kodliwadmath H. Comparative analysis of open versus laparoscopic ventral hernia repair. *International Surgery Journal.* 2016 Dec 9;3(3):1167-72.
17. Qadri SJ, Khan M, Wani SN, Nazir SS, Rather A. Laparoscopic and open incisional hernia repair using polypropylene mesh-A comparative single centrestudy. *International Journal of Surgery.* 2010 Jan 1;8(6):479-83AA



# Molecular Characterization of Sewage Bacteriophage and Their Efficiency in Treatment of Antibiotic Resistant Bacteria

Khalid Ibrahim Mahmood<sup>1</sup>, Ahmed Mohammed Turki<sup>2</sup>

<sup>1</sup>Scholar Researcher, Ministry of Health, Anbar Health Office, Anbar, Iraq,

<sup>2</sup>Scholar Researcher, Biology Department, College of Science, University of Anbar, Iraq

## Abstract

**Background:** The increasing prevalence of multi-drug resistant of bacteria strains, has become a global problem and therefore alternative method to antibiotics must be found. Bacteriophages are considered an alternative agent to control infection and contamination of the bacteria. **Method:** We used RAPD-PCR technique in present study, and used restriction endonuclease conformed presence unknown DNA fragments. **Results:** In this study, we described the isolation and character development of lytic bacteriophages capable of infecting bacteria specifically. Lytic bacteriophages, specific to *Escherichia coli*, *Klebsiella pneumonia*, *Salmonella typhi*, clinical strains, was first isolated from sewage. We have analyzed the DNA (RAPD)-PCR technique to produce unique and reproducible band from 21 different bacteriophages infecting *E.coli*, *K. pneumonia*, *S. typhi*. Used restriction endonuclease conformed presence unknown DNA fragments. **Conclusion:** Phages was capable of eliciting efficient lysis of studied bacteria, revealing its potential as a non-toxic sanitizer for controlling bacterial infection and contamination in both hospital and other public environments.

**Keywords:** Bacteriophages, phage therapy, RAPD-PCR, Restriction endonuclease.

## Introduction

The discovery of antibiotics has revolutionized the treatment of infectious diseases, and because of their overuse, resistance to antibiotics has increased and has become a global problem that must be paid attention to, and to continue to follow the side effects of antibiotics, as at least (2) million people are infected with bacteria that are resistant to some antibiotics every year in The United States alone, and at least 23,000 patients die every year from infection<sup>[1]</sup>. The danger of these antibiotics do not distinguish or differentiate between beneficial bacteria and bacteria harmful to human. the misuse of these antibiotic enables bacteria to strengthen their resistance against these antibiotic, and they become

stronger and more resistant to them<sup>[2]</sup>. Therefore, the scientists tended to phage therapy. Bacteriophages are viruses found naturally in the environment and have been studied to treat bacterial infections nearly 100 years ago. These phages invade and kill target bacteria by decomposition and do not attack mammalian cells. Phages are specialized for different bacteria. They bind to receptors on the bacterial cell walls to inject the phage DNA into the cell and eventually the cell lysis this in lytic phages<sup>[3]</sup>. During the lifecycle of the lysogenic bacteriophages, the DNA phage integrate into their host genome and evolve to coexist with bacteria. RAPD-PCR uses a randomized, purified DNA technique for extracted and purified DNA to help describe bacteriophages. RAPD-PCR is also used to assess the genetic diversity of phages<sup>[4]</sup>.

The RAPD reaction is a PCR technique that works to duplicate DNA segments that are unknown and random, using one short primer (8-12 nucleotides), and does not require any prior knowledge of the genome sequence. It also uses very low amounts of DNA, moreover, it is very sensitive, allowing the discovery of a variety of DNA

---

### Corresponding Author:

**Khalid Ibrahim Mahmood**

Scholar Researcher, Ministry of Health, Anbar Health Office, Anbar, Iraq

e-mail: khalidibrahim361@gmail.com

as well as mutations. This technique is widely applied in various fields of research (medicine, forensic science, genetically modified organisms, genetic diversity, taxonomy). In addition, the RAPD technique was also applied to detect genetic instability in tumors and DNA changes caused by toxic compounds in animals, bacteria, and plants [5].

The aim of study: Isolation of bacteriophages and study of their genetic content.

## Materials and Method

**Microbiological culture media and chemicals.** The main microbiological culture media we used in this research were BHA (Oxoid,UK), BHI (Oxoid,UK), EMB agar (Oxoid, UK) MacConkey's agar (Oxoid,UK) and Blood agar (Oxoid,UK). The SM buffer [(Tris-HCL, 10 Mm & pH = 7.6; MgSO 4 7H 2 O, 10 Mm; NaCl, 100 Mm and gelatin solution 2%(w/v), 5mL; distilled water, up to 1000 mL] (Merck, Germany). The chemicals we used were Methyl red, SIM, Urea agar, TSI and Simmon's citrate agar that provided from (Syrbio/Syria).

**Sample Collection:** Collected samples from various sources including wounds, burns, urine, stool, spinal fluid and blood, were collected under aseptic conditions from Al- Anbar hospitals during the period (September to December 2019). The bacterial samples were carried immediately to the laboratory complex, Microbiology Branch, College of Science, Anbar University, Anbar, Iraq at 4°C.

Isolation of bacterial species and their characterization

Isolated bacterial strains and examined by the compact vitek2 automated method according [6].

**Antibiotic Sensitivity Test:** Bacteria strains was subjected to antibiotic resistance evaluation against a set of antibiotic discs including: Tetracycline(TE;10µg), imipenem (IPM;10µg), Meropenem (MEM;10µg), Ciprofloxacin (CiP;10µg), Ceftriaxone(CRO;10µg), Piperacillen (PRL;100µg), Gentamicin (GN;10µg), Chloramphenicol (C;10µg), Trimethoprim(T;12.5µg), and Nitrofurantion(F;100µg) all from(Bio analyses/Turkey). Antimicrobial sensitivity testing was performed for strains of *K. pneumoniae*, *E.coli* and *S. typhi* using the disk diffusion method in accordance with National Committee for Clinical Standards guidelines (Clinical and Laboratory Standards Institute, 2019). The

antibiotics chosen are usually used for the treatment the multi-drug resistance of bacteria.

**Enrichment and isolation of bacteriophages:** To isolate bacteriophages, public wastewater of Al-Anbar, Iraq was used as a possible resource .A total of 10 mL of wastewater for 20 min at 3000 g was centrifuged, and the supernatant was filtered using a 0.45µL syringe filter. For the enrichment of bacteriophages, 100 µL overnight bacterial culture and 10 mL wastewater filtrates were applied to 40 mL of BHI flask and then incubated for 24 h at 37°C at 120 rpm shaking pace. In the same conditions, 10mL of BHI broth flask was centrifuged and filtered after 24 h. Then for the next stage the supernatant was stored at 4°C. In order to confirm the presence of phages, 10 µL of phage filtrate was dropped on BHA 's bacterial lawns and then incubated for 24 hours at 37°C.[7].

**Plaques purification and bacteriophage titting:** Double-layer agar method was used to purify the isolated phages and determine the phage titer. Briefly, phage filtrate was diluted to 10<sup>-12</sup> using SM buffer then mixed 100 µL of each dilution and 100 µL of overnight bacterial culture and added to 5mL of 45bhc molten BHA top agar (0.5% agar). Then the mixture vortexed and quickly overlaid with 1.5 % agar on BHA media plates. The plates were incubated for 24 h at 37°C and the plaques of bacteriophage were enumerated on each plate. This method was executed in triplicates [8].

**Phage DNA isolation:** Phage DNA was extracted as described previously from 100 mL of purified phage stocks previously dialyzed against SM buffer [9].

**Genomic fingerprinting by RAPD analysis:** Random amplification of polymorphic DNA was carried out according to a modification of the method described previously (Johansson et al., 1995). Primers OPL5(50-ACGCAGGCAC-30) and RAPD5 (50-AACGCGCAAC-30) were assayed at concentration (8 mM). PCR reactions were performed using PureTaq TM Ready To-Go TM PCR Beads (GE Healthcare, Munich, Germany) adding 10ng of purified phage DNA. Reactions were supplemented with 3 mM magnesium oxalacetate and/or 5% v/v dimethyl sulfoxide (DMSO). PCR was performed in a thermocycler (Bio-Rad, Hercules) under the following thermal cycling conditions: one cycles at 94 1 C for 180 s; 40 cycles at 94 1 C for 30 s, 35 1 C for 45 s and 72 1 C for 30 s (the extension step was increased by 1 s for every new cycle); and a final step of 5 min at 72 1 C.

## Results

The identity of bacteria strains was confirmed to be *E.coli*, *S.typhi* and *K.pneumoniae* by VITEK2 compact system . The antibiotic sensitivity of *E.coli*, *S.typhi* and *K.pneumoniae* isolate was tested using the disc diffusion method and the results showed that all bacteria isolate was sensitive to Meropenem, imipenem but resistant to Ciprofloxacin, Ceftriaxone, and Nitrofurantion .

In Fig.1,2 showed 50 water samples were collected from different sources and 21 isolates of Bacteriophages specific for 9 *S.typhi*, 7 *K.pneumoniae* and 5 *E.coli* bacteria were isolated .by spotted method on solid media and double layer agar method. And the liquid media method.

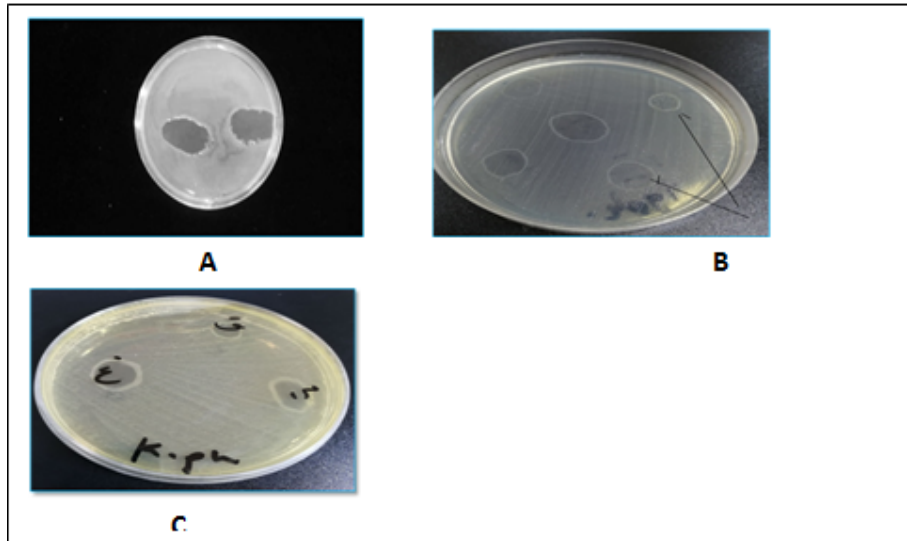


Figure 1. Plaque formation of (A) *E.coli*, (B) *S.typhi*, (C) *K.pneumonia* phages after 24h incubation at 37 °C on BHA

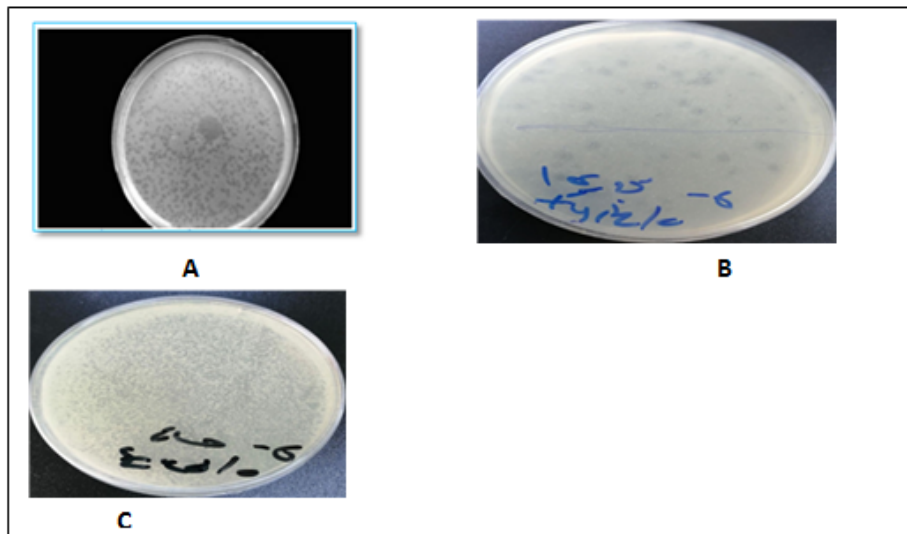


Figure 2. The total titer of (A) *K.pneumonia*, (B) *S.typhi*, (C) *E.coli* specific phages after 24h incubation at 37°C on BHA.

**Extraction genomic DNA:** DNA was extracted for all selected bacteriophages with 21 phages, which were isolated from sewage from various sources. The extraction results highlights the presence of DNA bands

for all studied phages . The integrity of the extracted DNA was confirmed after gel electrophoresis 1.5%. Fig. 3.

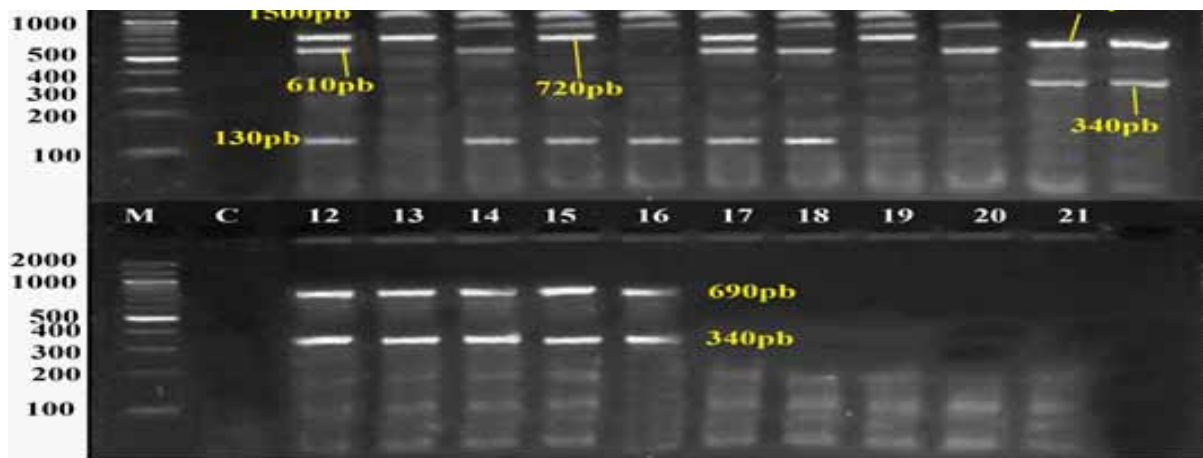
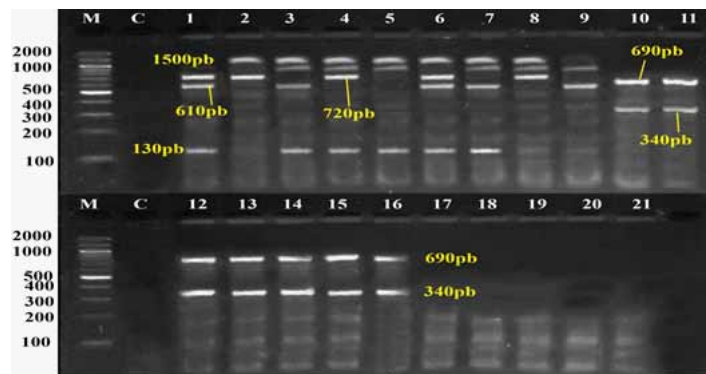


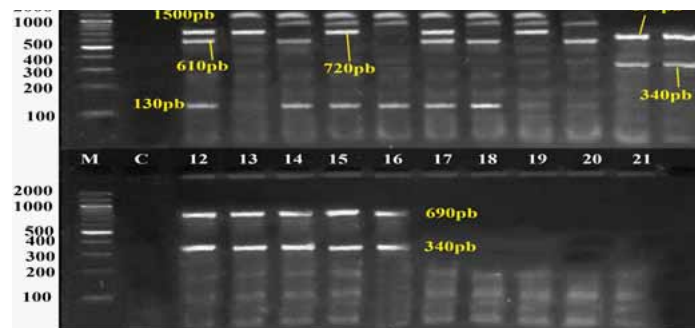
Figure 3. 21 Bands of genomic DNA and (M): DNA ladder (100 bp), agarose 1.5%, at 70 volt for 1 hr.

**Random amplification of polymorphic DNA (RAPD-PCR) technique:** Fig. 4 shows RAPD-PCR random amplification technique was performed using two primers OPL5, RAPD5 for all phages. This technique showed obvious difference in the number of DNA bands and a marked variation in their molecular

weights according to the primer used. In Fig.4a, *S. typhi* phages (1-9) and *K. pneumonia* phages (10-16) showed positive results with OPL5 primer, while *E.coli* phages (17-21) showed negative results. But when using RAPD5 primer showed positive results of all the phages, Fig. 4b.



A

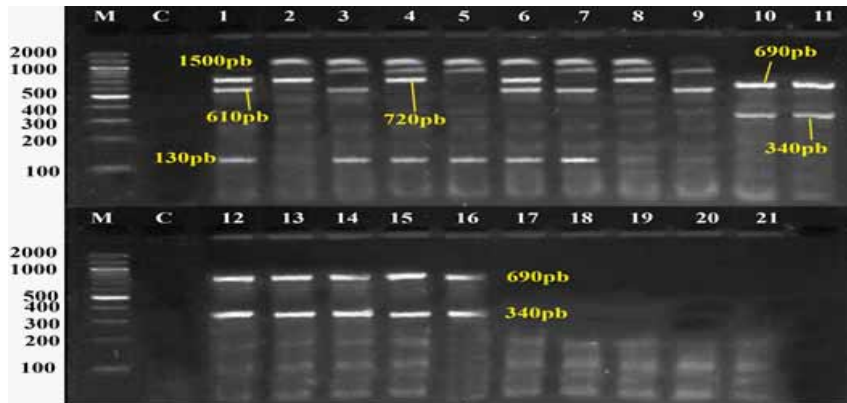


B

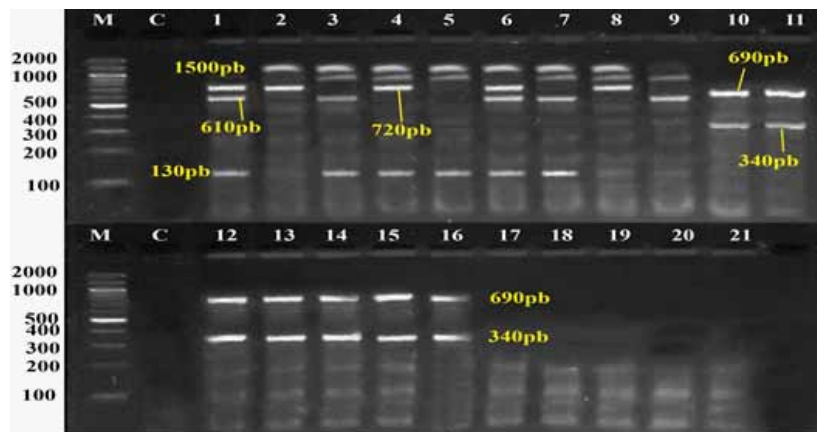
Figure 4. RAPD PCR products, Gel electrophoresis at 70 volt and 1h on 1.5% agarose gel showing [A] using OPL5 primer lanes positive of *S. typhi* phages(1-9), lanes positive *K.pneumonia* phages (10-16), negative lanes of *E.coli* phages(17-21). [B] using RAPD5 primer, lanes positive of *S. typhi* phages (1-9), lanes positive *K.pneumonia* phages (10-16), positive lanes of *E.coli* phages(17-21). Lane M: DNA ladder (100bp), C: negative control.

**Restriction endonuclease enzymes:** Four Restriction endonuclease enzymes (NdeI, SspI, Swa I, TaqI) were performed for all phages. The enzymes (Swa I, TaqI) did not produce positive result, while the enzymes (NdeI, SspI,) digested the DNA at more than one site and showed different bands and different weights as positive results. Fig5a, showed *S.typhi* phages(1-9)

similar due to similar DNA bands and also similar all *E.coli* phages(17-21), while showed *K.pneumonia* phages (10-16) negative results with using NdeI enzyme. As shown Fig4b *S.typhi* phages(1-9) and *E.coli* phages(17-21) positive results, and negative results of *K.pneumonia* phages (10-16) after using SspI enzyme.



A



B

**Figure 5. Restriction endonuclease products, Gel electrophoresis at 70 volt and 1h on1% agarose gel showing [A]using NdeI enzyme lanes positive of *S.typhi* phages(1-9), lanes negative *K.pneumonia* phages (10-16), positive lanes of *E.coli* phages(17-21). [B] using SspI enzyme, lanes positive of *S. typhi* phages (1-9), lanes negative *K.pneumonia* phages (10-16), positive lanes of *E.coli* phages (17-21). Lane M: DNA ladder (100bp). C: negative control.**

**Discussion**

Increase of multidrug-resistant bacteria and other losses, supporting alternative therapy development. Phage therapy may be seen as an effective method for the prevention and control of bacterial infection [11] . The current study, the lytic and specific phages

to the bacterial strains were isolated from different environmental sources; sewage was the main source; this finding is consistent with other studies[12].

The phages are the most abundant organisms in water, feces, soil and sewage water, therefore they are considered good indicators of bacteria presence[13].

RAPD-based method do not require sequence information when designing the PCR primers. We are therefore highly dependent on laboratory conditions such as DNA template concentration, PCR and electrophoretic environments, were selected to test several experimental conditions in order to produce reproducible RAPD patterns and gain a preliminary insight into the power of this approach to discrimination<sup>[14]</sup>.

As shown in Fig. 4 OPL5, RAPD5 primer produced distinct amplicon band patterns . in current study Fig.4a shown *S.typhi* phages were different among them Whereas, *K.pneumonia* phages were similar these results are disagree with the researchers' findings <sup>[15]</sup>. The results shown in Fig.4b showed *S.typhi* phages (1-6) were similar after use RAPD5 primer in the RAPD-PCR technique . The phages of *S.typhi* (7,5,3) was similar too. *S.typhi* phages 4,8 differed from the other phages, The results of the current study are consistent with the findings <sup>[16]</sup> .

Fig.5a, Restriction endonuclease (NdeI, SspI) showed the enzyme's effectiveness in digesting the phage DNA fragments, SspI was more efficient and producing DNA bands. Enzymes can digest DNA at Recognition site or more than in the same strand. NdeI was digested of DNA in the same site and bands of the same molecular weight appeared for *S.typhi* phages lanes(1-9) and *E.coli* phages lanes (17-21), which means that the phages are similar. But *K.pneumonia* phages(10-16) was negative results with using NdeI enzyme, these results disagree with results <sup>[17]</sup> .

In Fig.5b Endonuclease SspI digesting the DNA phages of *S.typhi*(1-9) and *E.coli* phages(17-21) and produces different bands pattern,which means that the phages are different among them. These results are consistent with <sup>[18]</sup>. *K.pneumonia* phages(10-16) was negative results after digesting with SspI enzyme.

## Conclusions

Phages characterization has shown that it has been very successful in lysing *E.coli*, *K.pneumonia*, *S.typhi*, it can be a good candidate for use as an alternative non-toxic green sanitizer. Host range research, however, revealed that phages did not infect other clinical strains of *E.coli*, *K.pneumonia*, *S.typhi* included in this review, indicating that more virulent bacteriophages unique to various bacterial strains will be screened and collected in the future. In potential phage applications a pool of lytic phages may be more effective against *E.coli*, *K.pneumonia*, *S.typhi* strains.

**Acknowledgements:** We would like to thank the Department of Biology, College of Science, Anbar University, Iraq and Anbar Health office for their technical assistance. We thank Assit. Prof. Ahmed Abdul Jabbar Suleiman, Biotechnology Department, College of Science, University of Anbar, for his help in this study.

**Conflict of Interest:** None

**Funding:** Self

**Ethical Clearance:** Not required

## References

1. LaVergne S, Hamilton T, Biswas B, Kumaraswamy M, Schooley RT, Wooten D. Phage therapy for a multidrug-resistant *Acinetobacter baumannii* craniectomy site infection. In: Open forum infectious diseases. Oxford University Press US; 2018. p. ofy064.
2. Zaman S Bin, Hussain MA, Nye R, Mehta V, Mamun KT, Hossain N. A review on antibiotic resistance: alarm bells are ringing. *Cureus*. 2017;9(6).
3. Clokie MR, Millard AD, Letarov A V, Heaphy S. Phages in nature. *Bacteriophage* 1: 31–45. 2011.
4. Stalin N, Srinivasan P. Efficacy of potential phage cocktails against *Vibrio harveyi* and closely related *Vibrio* species isolated from shrimp aquaculture environment in the south east coast of India. *Vet Microbiol*. 2017;207:83–96.
5. Lanzone V, Tofalo R, Fasoli G, Perpetuini G, Suzzi G, Sergi M, et al. Food borne bacterial models for detection of benzo [a] pyrene-DNA adducts formation using RAPD-PCR. *Microb Biotechnol*. 2016;9(3):400–7.
6. Preethirani PL, Isloor S, Sundareshan S, Nuthanalakshmi V, Deepthikiran K, Sinha AY, et al. Isolation, biochemical and molecular identification, and in-vitro antimicrobial resistance patterns of bacteria isolated from bubaline subclinical mastitis in South India. *PLoS One*. 2015;10(11):e0142717.
7. Amiri Fahliyani S, Beheshti-Maal K, Ghandehari F. Novel lytic bacteriophages of *Klebsiella oxytoca* ABG-IAUF-1 as the potential agents for mastitis phage therapy. *FEMS Microbiol Lett*. 2018;365(20):fny223.
8. Ghasemi SM, Bouzari M, Emtiazi G. Preliminary characterization of *Lactococcus garvieae*

- bacteriophage isolated from wastewater as a potential agent for biological control of lactococcosis in aquaculture. *Aquac Int.* 2014;22(4):1469–80.
9. Garcia P, Ladero V, Suarez JE. Analysis of the morphogenetic cluster and genome of the temperate *Lactobacillus casei* bacteriophage A2. *Arch Virol.* 2003;148(6):1051–70.
  10. Johansson P-O. Evaluating health risks. Cambridge Books. 1995;
  11. Maal KB, Delfan AS, Salmanizadeh S. Isolation identification of *Klebsiella pneumoniae* and *Klebsiella oxytoca* bacteriophages and their applications in waste water treatment and coliform's phage therapy. *Res J Env Sci.* 2014;8(3):123–33.
  12. Junn HJ, Youn J, Suh KH, Lee SS. Cloning and expression of *Klebsiella* phage K11 lysozyme gene. *Protein Expr Purif.* 2005;42(1):78–84.
  13. Aprea G, D'Angelo AR, Prencipe VA, Migliorati G. Bacteriophage morphological characterization by using transmission electron microscopy. *J Life Sci.* 2015;9(1):214–20.
  14. Gutiérrez D, Martín-Platero AM, Rodríguez A, Martínez-Bueno M, García P, Martínez B. Typing of bacteriophages by randomly amplified polymorphic DNA (RAPD)-PCR to assess genetic diversity. *FEMS Microbiol Lett.* 2011;322(1):90–7.
  15. Comeau AM, Short S, Suttle CA. The use of degenerate-primed random amplification of polymorphic DNA (DP-RAPD) for strain-typing and inferring the genetic similarity among closely related viruses. *J Virol Method.* 2004;118(2):95–100.
  16. Cucic S. Development of a prototype rapid method for the detection of *Escherichia coli* and *Salmonella enterica* subspecies *enterica* serovar Newport based on phage amplification and detection of progeny phage by Loop Mediated Isothermal Amplification. 2017.
  17. Kumari S, Harjai K, Chhibber S. Isolation and characterization of *Klebsiella pneumoniae* specific bacteriophages from sewage samples. *Folia Microbiol (Praha).* 2010;55(3):221–7.

# Assessment of Awareness on COVID-19 among Adults by Using an Online Platform: 26 Countries View

**Kogila Palanimuthu<sup>1</sup>, Birhanu Gutu<sup>2</sup>, Leta Tesfaye<sup>3</sup>, BuliYohannis Tasisa<sup>4</sup>,  
Yoseph Shiferaw Belayneh<sup>5</sup>, Melkamu Tamiru<sup>6</sup>, Desalegn Shiferaw<sup>7</sup>**

<sup>1</sup>Assistant Professor, Department of Nursing, College of Medicine and health sciences, Dambi Dollo University, Oromia, Ethiopia, <sup>2</sup>Lecturer, Department of Public Health, College of Medicine and health sciences, Dambi Dollo University, Oromia, Ethiopia, <sup>3</sup>Assistant Professor, Department of Physics, College of Natural and Computational sciences, Dambi Dollo University, Oromia, Ethiopia, <sup>4&6</sup>Assistant Professor, Department of Biology, College of Natural and Computational sciences, Dambi Dollo University, Oromia, Ethiopia, <sup>5</sup>Assistant Professor, Department of Chemistry, College of Natural and Computational sciences, Dambi Dollo University, Oromia, Ethiopia, <sup>7</sup>Assistant Professor, Department of Public Health, College of Medicine and health sciences, Dambi Dollo University, Oromia, Ethiopia

## Abstract

A study was conducted to assess the awareness on covid-19 by using online platform among global community. The objectives were to assess the socio demographic characteristics, to determine the relationship between levels of awareness of COVID-19 with their selected demographic variables.

A global community based cross sectional study was conducted by internet survey design with 2857 respondents. Data were collected by online Google form, researcher administered a questionnaires' awareness on COVID 19 through goggle link to the online platform and receive responses from the respondents,. The collected data was tabulated and analyzed. Descriptive and inferential statistics were used.

Researchers observed that 29.1% of the respondents reported high levels of awareness, 48.5% of the respondents reported moderate levels of awareness and 23.4% of the respondents reported low levels of awareness on COVID-19 respectively. It is very essential to create the awareness on COVID 19 among global population and protect the global community from deadly disease.

**Keywords:** *Cognizance, COVID-19, Online Platform, Global Community.*

## Introduction

The coronavirus belongs to a family of viruses that may cause various symptoms such as pneumonia, fever,

breathing difficulty, and lung infection<sup>1</sup>. These viruses are common in animals worldwide, but very few cases have been known to affect humans.

The World Health Organization (WHO) used the term 2019 novel corona virus to refer to a coronavirus that affected the lower respiratory tract of patients with pneumonia in Wuhan, China on 29 December 2019<sup>2,3</sup>. The WHO announced that the official name of the 2019 novel coronavirus is coronavirus disease (COVID-19)<sup>4</sup>. And the current reference name for the virus is severe acute respiratory syndrome coronavirus 2 (SARS-CoV-2)<sup>5</sup>.

However, current treatment on COVID-19 worldwide has mainly focused on infection control,

---

### Corresponding Author:

#### **Kogila Palanimuthu**

Assistant Professor, Department of Nursing, College of Medicine and Health Sciences, Dambi Dollo University (Government of Ethiopia), KellemWollega Zone, Oromia, Ethiopia-260

e-mail: kogila@dadu.edu.et

Phone:+251946266424,

Whats app Number: 09791868988



effective vaccine, and treatment cure rate (Dong et al. 2020; Wang et al. 2020), as countries worldwide have to work on reducing the transmission rate of COVID-19 by creating awareness<sup>6-9</sup>. In this COVID-19 pandemic, timely access to accurate information can be the difference between life and death (UNICEF Ethiopia April 2020)<sup>10</sup>.

As COVID-19 is a pandemic communicable disease, few things are known about the infection and from day today new updates and all what we heard about the infection to date are liable to updates/modification as the epidemiological study of the disease is underway. The basic awareness on COVID-19 among the Global community is acceptable. Timely dissemination of information by the Ministry of Health, WHO, UNICEF are very use full for the general public on the COVID-19. Here we are utilizing the online platform to assess the cognizance on COVID-19 IN Global community<sup>6-10</sup>.

This study was conducted to determine the public response on Cognizance on COVID-19 by using online platform. This study surely helps the local, national and international organization to identify the awareness on COVID-19 and prevent further transmission

### Objectives:

**General Objective:** The aim of this study is to assess the level of awareness on COVID-19 by using online platform in Global community, 2020.

### Specific Objectives:

1. To assess the respondents socio-demographic characteristics.
2. To determine the relationship between level of awareness of COVID-19 with their selected demographic variables.

## Materials and Method

Non-experimental evaluative approach was used. A community based cross sectional study internet survey design was adopted. The source population was all the stages of people across the global community during the study period. Person who satisfying the inclusion criteria such as age group 18 years and above were voluntarily participated in the study during the study period.

**Sample Size Determination:** The minimum sample size for online survey should be 100, required sample

size was based on the estimated response rate, and at the time of proposal presentation tentative sample size was 2000 respondents.

**Sampling Procedure:** Received 2857 responses from various parts of country, respondents who were responded by using voluntary response sampling technique. All the stages of peoples across the world '26 different countries' were participated in the study.

### Variables:

#### Dependent Variable:

- Awareness on COVID-19

#### Independent Variables:

- Socio-demographic factors

Data collection instrument and Questionnaires development

The questionnaire was prepared by the researchers, there were socio demographic questionnaire and 15 awareness questions on COVID-19 with the sources adopted from WHO, UNICEF and NHS. The questionnaire was translated from English into Afan Oromo and Amharic again translated back in to English, and comparisons were made on the consistency of the three versions.

**Data Collection Procedure:** Data was instinctively collected by using online platform. Respondents were filled the Google form for basic details voluntarily and also given the online consent to participate in the internet survey followed by respondents were filled the awareness questionnaire on COVID 19. Once who were successfully complete and submit the Google form instantly received their score by given email ID.

**Data Processing and Analysis:** Data was copied from Google spread sheet filled questionnaires' were checked manually for completeness and then coded. Entered and cleaned using Epidata version 3.11. Double entry made to minimize entry error and exported to SPSS version 23.0 for analysis. Descriptive analysis was used to describe the percentages and number distributions of the respondents by socio-demographic and socio economic characteristics. Inferential statistics like 't' test and ANOVA test were used to analyze the data. P-Value < 0.05 was considered to be declared statistically significant.

### Results

The cross sectional study internet survey was carried out to assess the awareness on COVID-19 among peoples from worldwide. The total of 2857 respondents was participated from 26 countries from the throughout the world as denoted in Figure-1.

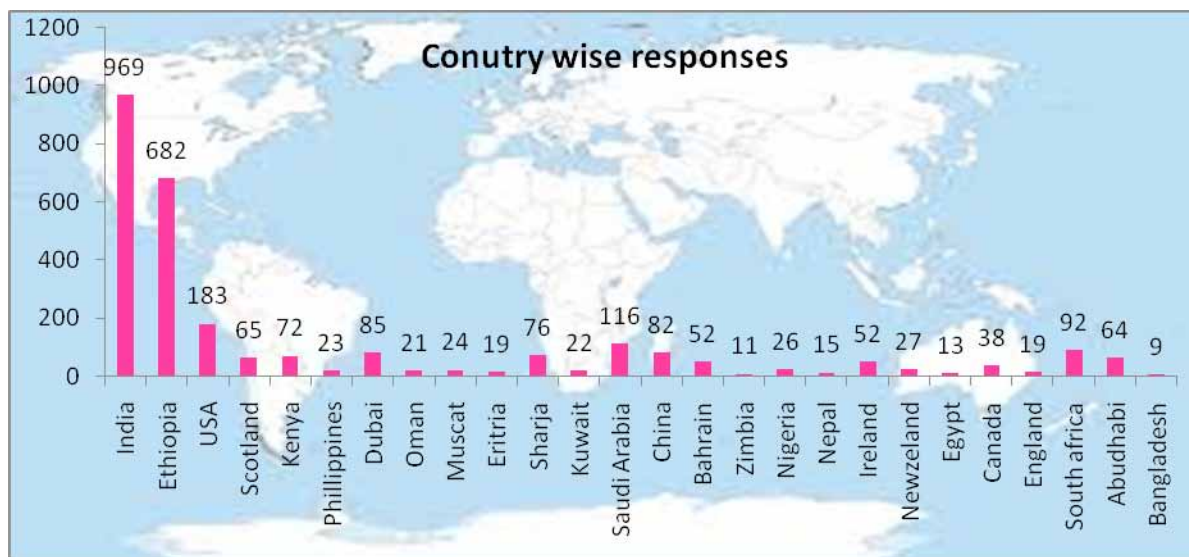


Figure-1: Country wise respondents on awareness on COVID19.

Socio demographic characteristics of the study respondents 1431 (50.05%) were belongs to 18-30 years, 756 (26.46%) belongs 40 31-40 years, 417 (14.60%) were 41-50 years and very few reporte in the age groups above 51 years as 253 (8.86%), in this 1236(43.26%) participants were male and 1621 (56.74%) belongs to female.

Significant difference between male and female with respect to awareness on COVID19 among the respondents were presented in Table 1 and it is revealed that significance difference between male and female of respondents. Based on means core, the female respondents (1.843) have high level of perception on awareness than male respondents (1.656). Field of education is presented in Table 2.

Table 1: t-test for significant difference between Male and Female with respect to Factors of awareness on COVID19 among the Respondents N=2857

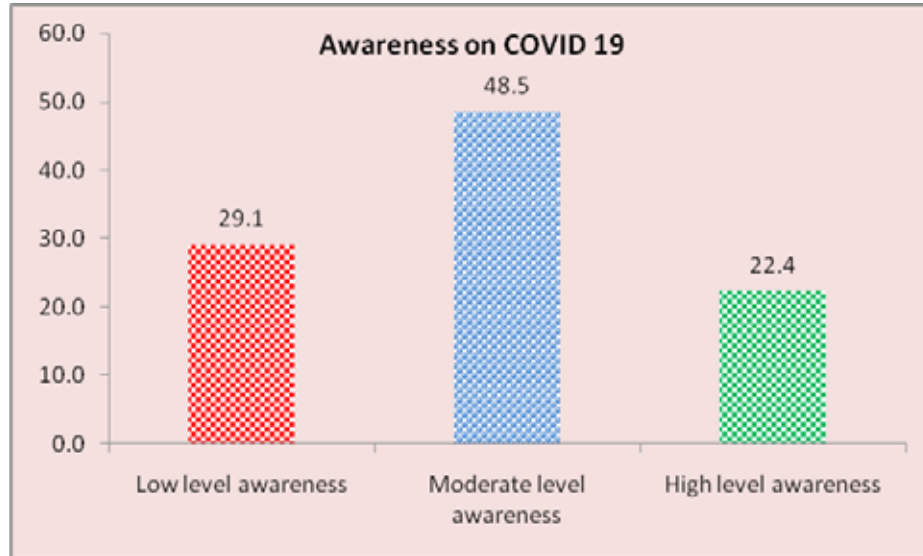
Factors of perception on COVID19	Gender				t-value	P-value
	Male		Female			
	Mean	SD	Mean	SD		
Awareness	1.6569	0.7272	1.8435	0.7943	2.849	0.005*

Note:\*Denotes significant at 5%level

Since P value is less than 0.05, null hypothesis is rejected at 5% level regard to Factors of awareness. Hence there is significance difference between male and female of respondents with regard to the Factors of awareness. Based on means core, the female respondents have high level of awareness on COVID 19 than male respondents.

Among 1236 (43.26) respondents were belongs to male, 1621 (56.74) respondents were belongs to female and their awareness on COVID 19 as follows: 832 (29.12), 1386 (48.51), 639 (22.36) low, moderate and high level of awareness respectively mentioned in Figure 2.

**Figure-2: Percentage of level of awareness on COVID19 among the Respondents.**



**Table 2: ANOVA for significant difference among field of education with respect to Factors of awareness on COVID19 among Respondents**

Perception on COVID19	Field of education		F value	P value
Awareness	Paramedical	1.98(0.78)	2.499	0.05*
	Arts and science	1.86(0.76)		
	Law	1.72(0.74)		
	Medical	1.82(0.76)		
	Engineering	1.79(0.74)		

**Note:** The value within bracket refers to SD, \*denotes significant at 5%level

**Table 3 Chi-square test for association between Gender and Level of awareness on COVID19 among respondents**

Gender	Level of awareness			Total	Chi-square	P value
	Low	Moderate	High			
Male	356 (42.8) [28.8]	591 (42.6) [47.8]	281 (44.0) [22.7]	1236 (43.3) [100.0]	8.028	<0.005*
Female	476 (57.2) [29.4]	795 (57.4) [49.0]	350 (54.8) [21.6]	1621 (56.7) [100.0]		
Total	832 (29.1) [100]	1386 (48.5) [100]	639 (22.4) [100]	2857 (100) [100]		

**Note:** The value within() refers to column Percentage, The value within [ ] refers to row Percentage, \*Denotes significant at 5%level

Since P value is less than 0.05, the null hypothesis is rejected at 5% level of significance. Hence concluded that there is association between Gender and Level of perception of awareness on COVID 19 among the

respondents. Based on row percentage, 28.8% of male have low level of awareness, and 22.7% of male have high level of awareness whereas for female 29.4% belongs to low level of awareness and 21.6% belongs

to high level of awareness. Hence majority of female respondents have high level of awareness and majority of males have low level of awareness as denoted in table 3.

## Discussion

The study was aimed to assess the awareness of on COVID 19. It was supposed that, this study provided important information and created overall image on awareness on COVID 19 in global community.

Present online study with 2857 responses from 26 different countries, 969 (33.9) were from India, 682 (22.9) responses from Ethiopia and responses from others countries as follows: USA 183 (6.4) Scotland 65 (2.3) Kenya 72 (2.5) Philippines 23 (0.8) Dubai 85 (3.0) Oman 21 (0.7) Muscat 24 (0.8) Eretria 19 (0.7) Sharjah 76 (2.7) Kuwait 22 (0.8) Saudi Arabia 116 (4.1) China 82 (2.9) Bahrain 52 (1.8) Zambia 11 (0.4) Nigeria 26 (0.9) Nepal 15 (0.5) Ireland 52 (1.8) Newzeland 27 (0.9) Egypt 13 (0.5) Canada 38 (1.3) England 19 (0.7) South Africa 92 (3.2) Abu Dhabi 64 (2.2) Bangladesh 9 (0.3)

In this 1236 (43.26) respondents were belongs to male, 1621 (56.74) respondents were belongs to female and their awareness on COVID 19 as follows: 832 (29.12), 1386 (48.51), 639 (22.36) low, moderate and high level of awareness respectively.

## Conclusion and Recommendations

As the researchers observed and concluded that the present study of awareness on COVID 19 among global community was most of respondents exhibited moderate level of awareness on COVID 19, few had high level awareness and around 30% of the respondents are reported low level awareness. So, need to create the awareness on COVID 19 throughout the world with the aim to reduce the spread of infection and also protect the global community from deadly disease.

Recommendations- Many Awareness program, Pamphlets on COVID 19 are created by the organizations like WHO and circulated. But it can be possible only by the common public, responsible persons should take initiatives in each country like ambassador's to spread the awareness to each and every individuals of the world. It is very essential and important to create the awareness on pandemic disease to protect the global population from the Coronavirus and to lead healthy life.

**Acknowledgement:** The authors wholeheartedly wish to thank the university heads, Dambi Dollo University, Oromia, Ethiopia for their support for completing the research and also extending the sincere acknowledgement to all the respondents from different part of the world.

**Conflict of Interest:** Nil

**Source of Funding:** The Corresponding Author received funding from the Dambi Dollo University for conducting the this global community research through online platform and obtained Permission for authorship and Publication of this article.

**Ethical Clearance:** Official ethical clearance letter was received from Research and Technology Innovative directorate office, Dambi Dollo University. After receiving the official letter from the University, seeking for the consent and voluntary response from the participants followed by they were recruited as study participant. Confidentiality, anonymity and privacy were maintained by excluding the name and ID of study participants from the questionnaire. Autonomous was maintained for recruited respondents. Justice was maintained by voluntary response to select all the participants and veracity also maintained by truthfulness in each stage of the study.

## References

1. WMHC. Wuhan Municipal Health and Health Commission's Briefing on the Current Pneumonia Epidemic Situation in Our City. 2020.
2. Li Q, Guan X, Wu P, Wang X, Zhou L, Tong Y, et al. Early transmission dynamics in Wuhan, China, of novel coronavirus-infected pneumonia. *N Engl J Med.* 2020.
3. Centers for Diseases Control and Prevention Coronavirus disease (COVID-19) outbreak (2020)
4. WHO. Novel Coronavirus, awareness-China. 2020.
5. Zhu N, Zhang D, Wang W, Li X, Yang B, Song J, et al. A novel coronavirus from patients with pneumonia in China, 2019. *N Engl J Med.* 2020.
6. WHO. Novel Coronavirus-Japan (ex-China). 2020.
7. Virological.org. Novel 2019 Coronavirus Genome 2020.
8. Fehr AR, Channappanavar R, Perlman S. Middle East respiratory syndrome: emergence of a

pathogenic human coronavirus. *Annu Rev Med.* 2017; 68:387–99.

9. WHO. Statement on the second meeting of the International Health Regulations (2020)
10. UNICEF, Coronavirus disease, awareness on COVID-19, (2020)

# Assessment of Stress, Fear, Anxiety and Depression on COVID-19 Outbreak among Adults in South-Western Ethiopia

Kogila Palanimuthu<sup>1</sup>, Hamba Yigazu<sup>2</sup>, Eshetu Fikadu<sup>3</sup>,  
Gemechu Gelalcha<sup>4</sup>, Yirgalem Bekele<sup>5</sup>, Getachew Birhanu<sup>6</sup>, Birhanu Gutu<sup>7</sup>

<sup>1</sup>Assistant Professor, Department of Nursing, College of Medicine and health sciences, Dambi Dollo University, Oromia, Ethiopia, <sup>2</sup>Lecturer, Department of Public Health, College of Medicine and health sciences, Dambi Dollo University, Oromia, Ethiopia, <sup>3</sup>Graduate Assistant, Department of Public Health, College of Medicine and health sciences, Dambi Dollo University, Oromia, Ethiopia, <sup>4</sup>Graduate Assistant, Department of Psychology, School of Education and Behavioral Sciences, Dambi Dollo University, Oromia, Ethiopia, <sup>5</sup>Lecturer, Department of Psychology, School of Education and Behavioral Sciences, Dambi Dollo University, Oromia, Ethiopia, <sup>6</sup>Graduate Assistant, Department of Public Health, Dambi Dollo University, Oromia, Ethiopia, <sup>7</sup>Lecturer, Department of Public Health, College of Medicine and health sciences, Dambi Dollo University, Oromia, Ethiopia.

## Abstract

A study was conducted to assess the level of stress, fear, anxiety and depression among adults in residing in selected area. The objectives were to assess the socio demographic characteristics of adults, to find out the association between level of Stress, fear, anxiety and depression of the respondents with selected demographic variables.

A community based cross sectional study was conducted with 634 adults were selected by the multistage random sampling technique. The data were collected by using standardized questionnaires, fear on COVID 19 and Stress, anxiety and depression on COVID 19. The collected data was tabulated and analyzed. Descriptive and inferential statistics were used.

Researchers observed that 35.5%, 4.1%, 13.2%, 8.2% of the respondents reported moderate levels of fear, stress, anxiety and depression respectively and 21.3%, 1.1%, 1.7%, 1.3% of the respondents reported extreme levels of fear, stress, anxiety and depression respectively. It is essential and inevitable to alleviate the stress, fear, anxiety and depression among general population and provide positive mental health.

**Keywords:** *Anxiety, COVID-19, Depression, Fear, Stress, South- Western Ethiopia.*

## Introduction

Till date many studies were conducted on COVID-19 like knowledge, attitude, practice, studies

---

### Corresponding Author:

#### Kogila Palanimuthu

Assistant Professor, Department of Nursing, College of Medicine and Health Sciences, Dambi Dollo University (Government of Ethiopia), Kellem Wollega Zone, Oromia, Ethiopia-260

e-mail: kogila@dadu.edu.et

Phone: +251946266424

Whats app Number: 09791868988

but psychological aspects of COVID-19 studies are very less in numbers. Therefore, this study is aimed to assess the level of Stress, fear, anxiety and depression (SFAD) status of our community on COVID-19 to help the local and national planners to identify the gap in public response to develop a protocol to overcome the SFAD from pandemic outbreak<sup>1</sup>.

One characteristic nature of infectious disease compared with other conditions is fear. Fear is directly associated with its transmission rate and medium (rapidly and invisibly) as well as its morbidity and mortality. This further leads to other psychosocial challenges including stigmatization, discrimination, and loss<sup>2</sup>.

Morbidity and mortality statistics of Corona virus in 52 African countries are 13,600 and more infected cases, 742 deaths, recovered 2, 3583<sup>6</sup>. Many of the ill people had contact with a seafood and animal market in Wuhan, a large city in eastern China, though it has since become clear that the virus can spread from person to person<sup>7-10</sup>.

An individual's personality characteristics, genetics, and childhood experiences with major stressors and traumas may also dictate their response to stressors. Acute Respiratory Syndrome (SARS) and Middle East respiratory syndrome (MERS) coronaviruses. Susceptibility seems to be associated with age and other health conditions<sup>8</sup>. COVID-19 has now been declared as a Public Health Emergency of International Concern by the WHO<sup>11, 12</sup>.

In a cross-sectional study, Wang et al (2020) evaluated psychological impacts, depression, stress, and anxiety at the beginning of the COVID-19 outbreak. In this study, 1210 participants from 194 cities in China answered an online questionnaire. The author showed that 53.8% of these people experienced severe psychological impacts of the outbreak. Moreover, 16.5%, 28.8%, and 8.1% of the respondents reported moderate to severe levels of depression, anxiety, and stress, respectively<sup>13</sup>.

### Objectives:

**General Objective:** The aim of this study is to assess the level of Stress, fear, anxiety and depression on COVID-19 in Kelem Wollega Zone, Oromia, 2020.

### Specific Objectives:

- To assess the respondents socio-demographic characteristics
- To determine the relationship between level of Stress, fear, anxiety and depression of the respondents with their selected demographic variables.
- To correlate the level of Stress, fear, anxiety and depression of the urban and rural respondents with their selected demographic variables.

### Materials and Method

Non-experimental evaluative approach was used. A community based cross sectional study design was adopted. The source population was all the adults living in Kelem Wollega Zone during the study period. Adults who satisfying the inclusion criteria such as age group between 21-50 years with a multistage random sampling

technique participants were chosen for the study during the study period.

**Sample Size Determination:** The required sample size was calculated by using single population proportion formula and *open source Epidemiologic statistics for Public health* (version 3.01) assuming that 50% of the community is having **Stress, fear, anxiety and depression (SFAD)** on COVID-19.

$$n = \frac{(Z\alpha/2)^2 p(1-p)}{d^2}$$

where; n = sample size

P = by taking the calculated prevalence rate of 50%,  $Z\alpha/2 = 95\%$  confidence level which is (1.96), d = 5% marginal error, Sample size as per openepi and formula results as 384, Design effect is  $1.5(384 \times 1.5=576)$  and after adding 10% none response, final sample size 634.

**Sampling Procedure:** In the first stage, three out of 12 woredas (25% of the total area) was selected by simple random sampling technique. In the second stage kebeles was selected from the woredas again using simple random sampling technique. In the third stage, a total of 634 households were selected using a systematic random sampling method. In this process sample was proportionally allocated to each selected kebele. Total number of households were obtained from the respective administrative areas and used to calculate the sampling fraction. Only one eligible individual was interviewed from the selected household. When two or more individuals are eligible in a household, only one was selected by lottery method.

**Data collection instrument and Questionnaires development:** The questionnaire was adapted from Structured standardized Five point likert Scale on Fear of COVID-19 (FCV 19S) and DASS Scale to assess the Depression, anxiety Stress on COVID-19 (2<sup>nd</sup> edition Sydney psychology foundation) were used by Structured Interview Schedule. The questionnaire was translated into Afan Oromo and again translated back in to English, and comparisons was made on the consistency of the two versions.

**Data Collection Procedure:** Data collectors were trained on the objective of the study and techniques of interviewing the participants. Totally 15 diploma holders midwives who were working in the area was deployed as data collectors on each selected kebeles. Data collection was conducted face to face interview

with structured questionnaire along with proper personal protective equipment. Respondent's doubts and queries also clarified by health workers. Supervisors followed the activities of data collectors daily and investigators guided the overall activities. Respondents were received pamphlets on coping tips to protect from covid-19 stress, fear, anxiety and depression.

**Data Processing and Analysis:** After the data was collected, filled questionnaires' were checked manually for completeness and then coded. Entered and cleaned using Epidata version 3.11. Double entry made to minimize entry error and exported to SPSS version 23.0 for analysis. Descriptive statistics like frequency distribution, percentage, mean, standard deviation & inferential statistics like 't' test and fried man test were used to analyze the data. P- Value < 0.05 was considered to be declared statistically significant.

## Results

The community based cross sectional study was carried out to assess the level of stress, fear, anxiety and depression on COVID-19 among study participants. The total of 634 participants participated in this study.

Socio demographic characteristics of the study participants were 238(37.5%) were belongs to 21-30 years. 177(27.9%) rural and 457(72.1%) were from urban, in this 420(66.2%) participants were male and 214(33.8%) belongs to female.

Significant difference between male and female with respect to Factors of fear, stress, anxiety and depression on COVID19 among the respondents were presented in Table 1 and it is revealed that significance difference between male and female of respondents with regard tot he Factors of fear. Based on means core, the male respondents (1.8429) have high level of perception on fear than female respondents (1.6589).

**Table: 1: t-test for significant difference between Male and Female with respect to Factors of fear, stress, anxiety and depression on COVID19 among the Respondents**

Factors of perception on COVID19	Gender				t value	P value
	Male		Female			
	Mean	SD	Mean	SD		
Fear	1.8429	0.7841	1.6589	0.7382	2.849	0.005*
Stress	1.2167	0.6008	1.2009	0.6293	0.307	0.759
Anxiety	1.5690	0.9879	1.4720	0.9770	1.174	0.241
Depression	1.4000	0.7889	1.3785	0.7701	0.327	0.744
Overall SFAD	6.0286	3.1617	5.7103	3.1146	4.657	<0.001** <0.001**

Fried man test for significant difference among mean ranks towards factors of fear, stress, anxiety and depression on COVID19 among the respondents represented in Table: 2 and it concluded that there

is significant difference among mean ranks towards Factors of SFAD. Based on mean rank, Fear (2.79) is the most important factor, followed by anxiety (2.52), Stress (2.37) and Depression(2.13).

**Table: 2: Fried man test for significant difference among mean ranks towards Factors of fear, stress, anxiety and depression on COVID19 among the respondents**

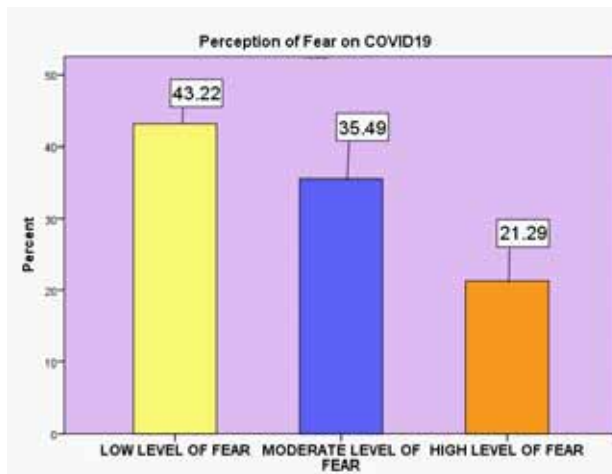
Factors of perception on COVID19	Mean Rank	Chi-Square value	P value
Fear	2.79	311.969	<0.001**
Stress	2.37		
Anxiety	2.52		
Depression	2.13		



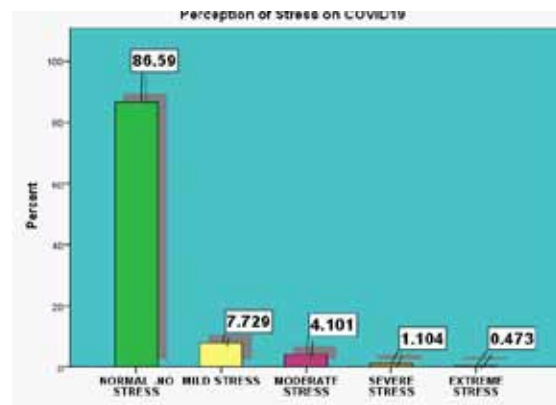
Figure 1-4 presents perception of fear on covid19 among 634 participants 274 (43.2%) exhibits low level of fear and 135 (21.3%) exhibits high level of fear and perception of stress on covid19, 49 (7.7%) exhibits low level of stress and 07 (1.1%) exhibits high level of stress.

Perception of anxiety on covid19, 50 (7.9%) exhibits low level of anxiety and 26 (4.1%) exhibits high level of anxiety and perception of depression on covid19, 93 (14.7%) exhibits low level of depression and 07(1.1%) exhibits high level of depression.

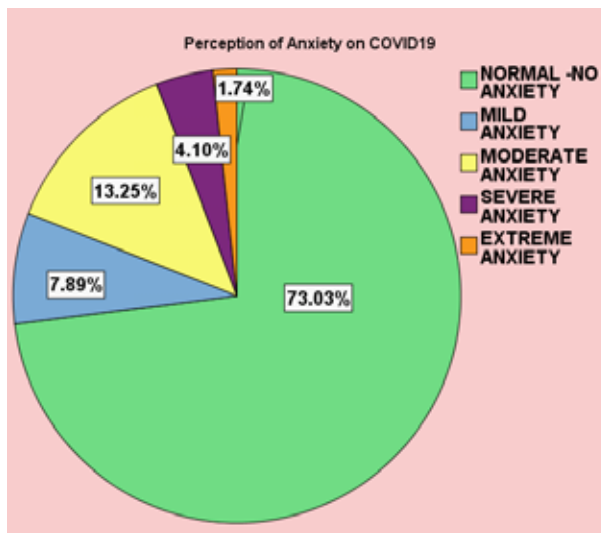
**Figure: 1: perception of fear on COVID19 among the study respondents**



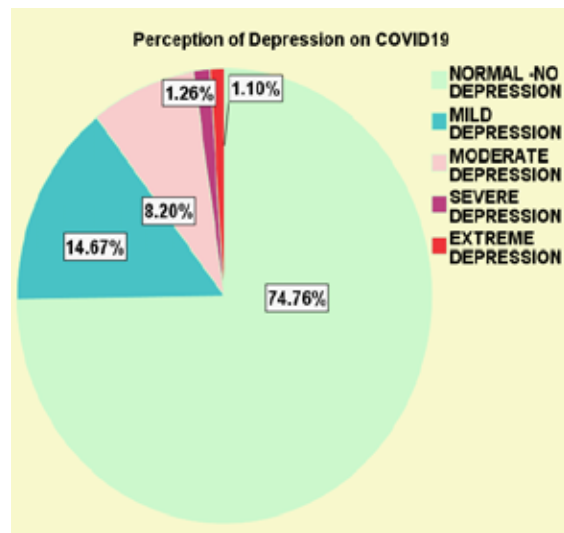
**Figure: 2: perception of stress on COVID19 among the study respondents**



**Figure: 3: perception of anxiety on COVID19 among the study respondents**



**Figure: 4: perception of Depression on COVID19 among the study respondents**



### Discussion

Stress is a feeling of strain and pressure. It is a type of psychological pain. Small amounts of stress may be desired, beneficial, and even healthy. Positive stress helps improve athletic performance. It also plays a factor in

motivation, adaptation, and reaction to the environment. Excessive amounts of stress, however, may lead to bodily harm. Stress can increase the risk of strokes, heart attacks, ulcers and mental illnesses. With the high levels Stress, fear, anxiety and depression (SFAD) of

individuals may not think clearly and rationally when reacting to COVID-19. However, current treatment on COVID-19 worldwide has mainly focused on infection control, effective vaccine, and treatment cure rate (Dong et al. 2020; Wang et al. 2020).

The study was aimed to assess the stress, fear, anxiety and depression on COVID 19 on kellewolloge zone. It was supposed that, this study provided important information and created overall image on stress, fear, anxiety and depression on COVID 19 in kellewolloge zone.

In a cross-sectional study, Wang et al (2020) evaluated psychological impacts, depression, stress, and anxiety at the beginning of the COVID-19 outbreak, 1210 participants from 194 cities in China answered an online questionnaire. The author showed that 53.8% of these people experienced severe psychological impacts of the outbreak. Moreover, 16.5%, 28.8%, and 8.1% of the respondents reported moderate to severe levels of depression, anxiety and stress, respectively<sup>13</sup>.

On the other hand the researchers conducted the present study with 634 participants in different woredas 177(27.9%) rural and 457(72.1%) were from urban, in this 420(66.2%) participants were male and 214(33.8%) belongs to female and observed that 35.5%, 4.1%, 13.2%, 8.2% of the respondents reported moderate levels of fear, stress, anxiety and depression respectively and also observed that 21.3%, 1.1%, 1.7%, 1.3% of the respondents reported extreme levels of fear, stress, anxiety and depression respectively. In present study 3 woredas were participated from that one woreda is exhibiting high level of fear on COVID-19 110 (33%) comparing to all other woredas as follows: 10(6.7%), 15 (10%). These study results resembling the study results of other country.

### Conclusion

Our study revealed that the majority of study participants had high level of fear, moderate level of stress and anxiety and very few showed that low level of depression. Researchers strongly recommending the Psychological first Aid training for health professionals and followed by psychological first aid to concern woreda respondents to help them to stabilize the mental health by reducing the fear on deadly pandemic disease COVID-19. It is essential and in evitable to alleviate the stress, fear, anxiety and depression among general population and provide positive mental health.

**Acknowledgement:** The authors wholeheartedly wish to thank Dr. Leta Tesfaye, President, Dr. Buli Yohanis Tasisa, Academic vice President, Prof. Yoseph Shiferaw Belayneh, Research and Community service vice President, Prof. Malkamu Tamiru, Research and Technology innovation Directorate Director, Dambi Dollo University, Oromia, Ethiopia for their support for completing the activities in a timely manner.

**Conflict of Interest:** Nil

**Source of Funding:** The Corresponding Author received funding from the Dambi Dollo University for conducting the research in 3 woredas and also obtained Permission for authorship and Publication of this article

**Ethical Clearance:** Official ethical clearance Letter was received from Research and Technology Innovative directorate office, Dambi Dollo University and it was presented to Kelem Wollega health department. All the information regarding the study, Researchers contact information, participants rights were provided in the first page of questionnaire. Written consent was obtained from each participant. Confidentiality, anonymity and privacy were maintained by excluding the name and ID of study participants from the questionnaire. Autonomous were maintained for both recruited & non recruited Participants by who are not willing to participate in the study was respected and they were not recruited in the study. All the enrolled participants were informed about the rights to withdraw from the study at any point of time. Justice was maintained by randomization to select the participants and veracity were maintained by truthfulness in each stage of the study.

### References

1. WMHC. Wuhan Municipal Health and Health Commission's Briefing on the Current Pneumonia Epidemic Situation in Our City. 2020.
2. Li Q, Guan X, Wu P, Wang X, Zhou L, Tong Y, et al. Early transmission dynamics in Wuhan, China, of novel coronavirus-infected pneumonia. *N Engl J Med*. 2020.
3. Centers for Diseases Control and Prevention Coronavirus disease (COVID-19) outbreak (2020)
4. CDC. 2019 Novel coronavirus, Wuhan, China. 2020.
5. UNICEF, Coronavirus disease, strategies to overcome the stress and fear (COVID-19), (2020).

6. WHO. Novel Coronavirus, fear and stress—China. 2020.
7. Zhu N, Zhang D, Wang W, Li X, Yang B, Song J, et al. A novel coronavirus from patients with pneumonia in China, 2019. *N Engl J Med.* 2020.
8. WHO. Novel Coronavirus-Japan (ex-China). 2020.
9. Virological.org. Novel 2019 Coronavirus Genome 2020.
10. Fehr AR, Channappanavar R, Perlman S. Middle East respiratory syndrome: emergence of a pathogenic human coronavirus. *Annu Rev Med.* 2017;68:387–99.
11. WHO. Statement on the second meeting of the International Health Regulations (2005) Emergency Committee regarding the outbreak of novel coronavirus (2019-nCoV). 2020.
12. Weijie Guan et all (February 28,2020) ‘Clinical Characteristics of Coronavirus Disease 2019 in China’, *The New England Journal of Medicine.*
13. Wang C, Pan R, Wan X, Tan Y, Xu L, Ho CS, et al. Immediate psycho-logical responses and associated factors during the initial stage of the 2019 coronavirus disease (COVID-19) Epidemic among the general population in China. *Int J Environ Res Public Health.* 2020;17(5).

# Prevalence of Overweight and Obesity among School Going Adolescent in Patna

Kumari Mangalam<sup>1</sup>, Chauhan Muneesh<sup>2</sup>, Anand Akshay<sup>3</sup>, Fatima Ambreen<sup>1</sup>, Saho Pramod<sup>1</sup>

<sup>1</sup>Assistant Professor, Galgotias University, Greater Noida, <sup>2</sup>Student, Galgotias University, Greater Noida,

<sup>3</sup>Assistant Professor, Manav Rachna International University, Faridabad

## Abstract

**Introduction:** Now a day's Obesity has become pandemic concern globally and the prevention of later stage obesity will require elimination and management of childhood obesity. Childhood obesity and overweight are linked with hypertension, dyslipidemia and decreased metabolism of glucose that ultimately affects our quality of life and physical health and further can lead to increment in the risk of early disease and death.

**Aims and Objectives:** The current investigation was conducted to find out the prevalence of overweight and obesity in school going adolescents.

**Material and Method:** The present study was a cross-sectional, school-based study conducted in four urban schools of Patna from June, 2019 to, February 2020 with sample size of 660 adolescents (380 boys and 280 girls). The study design was approved by the institutional ethical committee. Three schools accepted our proposal out of 5 schools selected through systematic random sampling. A predesigned and pretested questionnaire was used to collect data on sociodemographic, dietary intake, physical activity and anthropometric measurements.

**Result and Discussions:** The pervasiveness of overweight and obesity was found to be 18.18%(120) and 10.9% (72), respectively in our study. The prevalence of overweight and obesity was 11.3% and 5.5%, respectively among the males. Males are more affectionate to Non Vegan-compared to females where the number of vegetarian supersedes the animal eater. Calories deficiency is 71.2% in the whole population on the other hand overeating was seen more in male candidates than females. More than 20% of the population was found to dine out once or more than once a week .Fast food intake found to be ingested in 44.6% population once or twice a week on the other hand there is a huge population of 37.8 % who are consuming 3-5 times a week. Mehta *et al.* revealed the predominance of obesity and overweight as 5.3% and 15.2%, respectively in his cross-sectional study which was directed in schools of Delhi. Sharma et al demonstrated that 6.4% school children are obese in Delhi.

**Conclusions:** The current study suggests that juvenile overweight and obesity is a issue of serious concern in urban community as well as all over. We can prevent this epidemic by doing lifestyle modifications and spreading awareness among people. To achieve this appropriate health education training and awareness program should be imparted to guardians, school authority and children.

**Keywords:** Obesity, Adolescents, overweight, WHO, Dietary Habits, physical Activity level.

## Introduction

Presently, Obesity has become a serious and genuine unavoidable concern in all generation groups. Obesity is characterised as a condition wherein there is abnormal or uncurbed accumulation of fat in adipose tissue occurs, to the degree that health may be compromised<sup>1</sup>. This

---

### Corresponding Author:

**Akshay Anand**

Assistant Professor (Manav Rachna International University, Faridabad) Tuglakabad Extension Delhi  
e-mail: akshayaanad.anand25@gmail.com

worldwide pandemic of excessive weight and obesity -collectively termed as “globesity” - is quickly turning into a significant public health concern in all over the globe.

Obesity has outreached epidemic extent globally, and is a remarkable patron to the chronic ailment and disability having more than 1 billion adults overweight and around 300 million clinically obese<sup>1</sup>. progressively it is perceived as a critical issues in both developing and countries experiencing financial transition<sup>2</sup>.

These issues are not only limited to adults but also being accounted among the children and adolescents of developed<sup>3,4</sup> as well as developing nations of the world<sup>5</sup>. This new drifting concern lead to various consequences in both adolescence<sup>6</sup> and adult life<sup>7</sup> especially increased rate of coronary artery diseases, hypertension, diabetes, dyslipidaemia<sup>8</sup>, obstructive sleep apnoea<sup>9</sup>, esophageal reflux & gastric emptying disturbances, osteoarthritis & flat feet<sup>10</sup>, psychological dysfunction, self esteem & social isolation<sup>6</sup>, and overall increase in morbidity and mortality in later life<sup>11</sup>.

Epidemiological studies have reported that about a third of preschool children and a half of school-age children become obese adults<sup>12</sup>. The effective prevention of adult obesity will require the prevention and management of childhood obesity<sup>1</sup>. India has also witnessed a gradual and continuous rise in trends of childhood and adolescent overweight and obesity<sup>13</sup>. Taking this into consideration of these realities, the present study was conducted to the prevalence of Overweight and Obesity in Adolescent School Children of “Patna”, capital of Bihar.

### Material and Method

The current study was a cross-sectional, school-based study conducted in four urban schools of Patna from June, 2019 to, February 2020 with sample size of 660 adolescents (380 boys and 280 girls) with the aims and objectives to determine the prevalence of overweight and obesity in adolescent school children. The study design was approved by the institutional ethical committee. In this study Three schools accepted our proposal out of 5 schools selected through systematic random sampling. Informed consent were taken from

the parents prior to the study. Apparently Adolescents school children of Vth to Xth standard, in the range of 8-15 years of age were included in the study. Following Children having Chronic illness, Severe malnutrition, any type of Endocrinal problems, Physical & Mental disorders and Children with apparent obesity induced or associated with any syndrome were excluded from the study.

The data was collected by using the pre-structured questionnaire to assess total food intake, Type of diet, dietary habits, anthropometric measurement and physical activity.

Information on socio-demographic particulars, dietary habits and usual physical activity, time spent in watching TV and with computer and in other sedentary activities during the past one month, was assessed. Physical activity level (PAL) of the Children were assessed by using Global Physical Activity Questionnaire (GPAQ). Anthropometric measurements of weight (kg) and standing height (cm), waist circumference (cm), were taken by using standard equipment and procedures. Utilizing the weight and height, Body mass index (BMI) was calculated in Kg/m<sup>2</sup>, for each subject.

For overweight and obesity - IOTF classification was considered for calculation of overweight and obese subjects values between 85th -95th percentile were defined under overweight. values above 95th percentile were considered as obese subjects.

### Result and Discussion

Ms Excel was used for Data entry. Statistical Analysis was done using SPSS version 22.0 software for Windows (SPSS Inc., Chicago, IL, USA) and P < 0.05 was considered as statistically significant. Descriptive statistics were calculated in the form of percentages, mean and standard deviation for the demographic data. A total of 660 adolescent school children were recruited. Out of 660 adolescents interviewed, 53.03(n=350) were males and 46.9% (n=310) were females. The pervasiveness of overweight and obesity was found to be 18.18%(120) and 10.9% (72), respectively in our study. The prevalence of overweight and obesity was 11.3% and 5.5%, respectively among the males.

**Table 1. Mean±S.D. Weight, Height, BMI and WC of Females**

Age Group	n	Weight (kg)	Height (cm)	BMI (kg/m <sup>2</sup> )	WC (cm)
10-11	49	32.10 ± 6.53	146.78 ± 9.46	14.90 ± 2.61	62.36 ± 7.48
>11-12	51	37.75 ± 9.57	152.62 ± 9.60	16.17 ± 3.56	64.36 ± 12.86
>12-13	71	40.81 ± 8.96	154.96 ± 7.49	16.98 ± 3.57	67.76 ± 9.87
>13-14	68	44.81 ± 11.16	157.14 ± 8.14	18.11 ± 4.10	69.87 ± 9.05
>14-15	50	48.34 ± 9.27	160.32 ± 8.09	18.83 ± 3.40	72.65 ± 8.95
>15-16	21	51.65 ± 11.42	162.91 ± 6.27	19.42 ± 3.96	75.30 ± 12.35
<b>Total</b>	<b>310</b>	<b>41.67 ± 10.98</b>	<b>155.10 ± 9.47</b>	<b>17.21 ± 3.79</b>	<b>68.04 ± 10.56</b>

**Table 2. MEAN±S.D. Weight, Height, BMI and WC of Males**

Age Group	N	Weight (kg)	Height (cm)	BMI (kg/m <sup>2</sup> )	WC (cm)
10-Nov	40	32.90 ± 11.46	144.35	15.5	63.15
			± 9.54	± 4.04	± 11.52
>11-12	50	35.18	147.14	15.79	63.78
			± 7.01	± 16.11	± 2.31
>12-13	67	41.9	152.05	17.96	70.5
			± 10.44	± 9.64	± 3.63
>13-14	83	45.88	159.33	17.94	70.17
			± 11.84	± 10.28	± 3.53
>14-15	80	53.14	164.27	19.53	74.29
			± 13.35	± 6.68	± 3.98
>15-16	30	54.16	164.88	19.77	75.68
			± 14.50	± 6.68	± 4.46
Total	350	44.62	156.23	17.91	70.03
			± 13.72	± 12.77	± 3.94

**Table 3. Distribution of Study Population According to Age Group, Sex and Type of School**

Background Characteristic	Male		Female		Total	
	n	%	n	%	n	%
Age Group (Years)						
8-9 Yr	40	11.42857143	44	14.19354839	84	12.72727273
>9-10	50	14.28571429	46	14.83870968	96	14.54545455
>10-11	73	20.85714286	66	21.29032258	139	21.06060606
>11-12	70	20	63	20.32258065	133	20.15151515
>12-13	70	20	45	14.51612903	115	17.42424242
>13-14	20	5.714285714	16	5.161290323	36	5.454545455
14-15	27	7.714285714	30	9.677419355	57	8.636363636
<b>Total</b>	<b>350</b>	<b>53</b>	<b>310</b>	<b>47</b>	<b>660</b>	<b>100</b>

Among the females, we found the prevalence of overweight was 7.2% and that of obesity was 5.4%. The prevalence of overweight and obesity was found to high among males.

Among the females, we found the prevalence of overweight was 7.2% and that of obesity was 5.4%. The prevalence was found to high among the males. Males are more affectionate to Non Vegan-compared to

females where the number of vegetarian supersedes the animal eater. Calories deficiency is 71.2% in the whole population on the other hand overeating was seen more in male candidates than females. More than 20% of the population was found to dine out once or more than once a week. Fast food intake found to be ingested in 44.6% population once or twice a week on the other hand there is a huge population of 37.8 % who are consuming 3-5 times a week. Only 36.3 % candidates were consuming fruits 5 times a week. Around 43% of Population in our study were performing moderate/vigorous activities remaining were performing the same activity level and they are 56% of the population. 50% of Population were performing moderate PA, while 28.4% were stuck on Low PA, Only 20.7% were performing High PA. 13.3% of candidates uses mobile phone more than 2 hours a day while 42.7% of population still uses 1 hours every day. A major section of population doesn't uses computer i.e. 50.4% while 12.5% uses more than a hour.

Total sedentary time was 56.3% in 6-10 hours user. While 35.7% is the percentage of least user.

### Discussion

India, considered as an ethnic group are mainly at greater risk for insulin resistance and central obesity, Prompting to diabetes, Heart Disease and other "life style" disorders. Over nutrition and sedentary lifestyle predisposes to various metabolic syndrome and type 2 DM. various investigations have demonstrated that these problems begins in childhood and manifest due to interactions and accumulation of multiple risk factors, throughout the life span. Mehta *et al.* revealed the predominance of obesity and overweight as 5.3% and 15.2%, respectively in his cross-sectional study which was directed in schools of Delhi<sup>14</sup>. Sharma *et al* demonstrated that 6.4% school children are obese in Delhi<sup>15</sup>.

In our study the event of overweight and obesity was found to be 18.18% and 10.9%, respectively. Perhaps this is on the ground that in Patna city there is accessibility of wide range of fast/junk food corners, modern electronic gadgets, games and transport facilities which are contributing for the increased prevalence of overweight and obesity in adolescents.

Similar finding were accounted by Goyal *et al.* with 12% of overweight and obesity among adolescents (aged 12-18 years) in addition to this It was also reported that the prevalence was higher in children who belongs

to high socioeconomic class as compared to those who belongs to the lower socioeconomic class<sup>16</sup>.

The predominance of overweight and obesity among the school-going adolescents of Patna was seen as high. Raj *et al* indicated a gradual increment pattern transition in health concerning with overweight and obesity<sup>13</sup>. Among all sedentary actions, TV viewing has received unique attention, and in this study, it was seen as to be a significant independent factor influencing overweight and obesity.

Overweight is characterized as a BMI between the 85th and 95th percentile for age and sex, and obesity—as a BMI greater than the 95th percentile. BMI is utilized as a particular pointer of abundance adiposity among children.

The prevalence rates of adolescents overweight and obesity in our region (Patna) were higher as compared to previously reported data from other areas in Bihar.

### Conclusion and Recommendations

We Concluded that whether the city is enormous or small this is a genuine concern to be dealt with. It is very essential to take preventive measures such as awareness programs school based and community based to avoid this crucial issue of overweight and obesity. To sum up, our study also conclude that restricted physical movement, undisciplined and detrimental food tendency and increment in stationary and inactive way of life are turning out to be major contributing element for overweight and obesity. The current study suggests that juvenile overweight and obesity is a issue of serious concern in urban community as well as all over. We can prevent this epidemic by doing lifestyle modifications and spreading awareness among people. To achieve this appropriate health education training and awareness program should be imparted to guardians, school authority and children.

**Limitations:** For more vital and precise information larger sample size could have taken. however due to lockdown same could not be achieved. Information about the dietary habits, intake and others must be taken in front of guardian for accurate information.

**Acknowledgment:** We would like to thank all the participants of the study for their cooperation. **Financial support and sponsorship** Nil. **Conflicts of interest** There are no conflicts of interest.

**Ethical Clearance:** Institutional ethical committee

## References

1. World Health Organization. Obesity: preventing and managing the global epidemic. World Health Organization; 2000.
2. Popkin BM. The nutrition transition and obesity in the developing world. *The Journal of nutrition*. 2001 Mar;131(3):871S-3S.
3. Popkin BM, Gordon-Larsen P. The nutrition transition: worldwide obesity dynamics and their determinants. *International journal of obesity*. 2004 Nov;28(3):S2-9.
4. Ogden CL, Carroll MD, Curtin LR, McDowell MA, Tabak CJ, Flegal KM. Prevalence of overweight and obesity in the United States, 1999-2004. *Jama*. 2006 Apr 5;295(13):1549-55.
5. Wang Y, Lobstein TI. Worldwide trends in childhood overweight and obesity. *International journal of pediatric obesity*. 2006 Jan 1;1(1):11-25.
6. Dietz WH. Health consequences of obesity in youth: childhood predictors of adult disease. *Pediatrics*. 1998 Mar 1;101(Supplement 2):518-25.
7. Must A, Jacques PF, Dallal GE, Bajema CJ, Dietz WH. Long-term morbidity and mortality of overweight adolescents: a follow-up of the Harvard Growth Study of 1922 to 1935. *New England journal of medicine*. 1992 Nov 5;327(19):1350-5. Lauer RM, Clarke WR, Mahoney LT, Witt J. Childhood predictors for high adult blood pressure: The Muscatine Study. *Pediatric Clin North Am* 1993; 40: 23-40.
8. Roland C, Baur LA, Donaghue KC, Waters KA. Metabolic correlates with obstructive sleep apnea in obese subjects. *The Journal of pediatrics*. 2002 Jun 1;140(6):654-9.
9. Dowling AM, Steele JR, Baur LA. Does obesity influence foot structure and plantar pressure patterns in prepubescent children?. *International journal of obesity*. 2001 Jun;25(6):845-52.
10. Burton BT, Foster WR. Health implications of obesity: an NIH Consensus Development Conference. *Journal of the American Dietetic Association*. 1985 Sep;85(9):1117-21.
11. Serdula MK, Ivery D, Coates RJ, Freedman DS, Williamson DF, Byers T. Do obese children become obese adults? A review of the literature. *Preventive medicine*. 1993 Mar 1;22(2):167-77.
12. Raj M, Sundaram KR, Paul M, Deepa AS, Kumar RK. Obesity in Indian children: time trends and relationship with hypertension. *National Medical Journal of India*. 2007 Nov 1;20(6):288.
13. Mehta M, Bhasin SK, Agrawal K, Dwivedi S. Obesity amongst affluent adolescent girls. *Indian JPediatr*. 2007;74:619-22.
14. Sharma A, Sharma K, Mathur KP. Growth pattern and prevalence of obesity in affluent schoolchildren of Delhi. *Public Health Nutr*. 2007;10:485-91.
15. Prasad RV, Bazroy J, Singh Z. Prevalence of overweight and obesity among adolescent students in Pondicherry, South India. *International Journal of Nutrition, Pharmacology, Neurological Diseases*. 2016 Apr 1;6(2):72.
16. Goyal JP, Kumar N, Parmar I, Shah VB, Patel B. Determinants of overweight and obesity in affluent adolescent in Surat City, South Gujarat region, India. *Indian J Community Med*. 2011;36:296-300



# Relationship between Coronavirus (COVID-19) and Social Factors: Evidence from 24 Countries Over the World During 88-Day Period from Jan 31 to April 27, 2020

Lien Nguyen-Phuong<sup>1</sup>, Hang Thu Thi Dang<sup>2</sup>, Nhung Phuong Thi Nguyen<sup>3</sup>

<sup>1</sup>A PhD and lecturer, Business Administration Department, Faculty of Business Administration, Van Lang University, Viet Nam. Address: 45 Nguyen Khac Nhu Street, Co Giang Ward, District 1, Ho Chi Minh City-70000, <sup>2</sup>A MBA and lecturer, Accounting-Finance Department, Faculty of Economics and Business, Hoa Sen University, Ho Chi Minh City, Viet Nam, <sup>3</sup>A PhD and lecturer, Business Administration Department, Faculty of Economics and Business, Hoa Sen University, Ho Chi Minh City, Viet Nam

## Abstract

The paper investigates the relationship among social and demographic factors and a new case of spreading coronavirus in 24 countries over 88-day period from Jan 31, 2020 to April 27, 2020. This study collected second data from World Health Organisation (WHO)'s and World Bank's database, applied Co-integration test and Causality test for a panel data set.

The research provides crucial finding: there is causality between new cases of spreading coronavirus and time to close school too late. Moreover, Asian region, where the studied countries are being increases, new case of spreading coronavirus decrease. Furthermore, classification of income of the research countries is statistically insignificant to new case equivalent to absent association between the changes in the new case of spreading coronavirus and classification of income of the research countries.

The spreading COVID – 19 can happen everywhere from high income, middle income to low-income countries. Another finding is that late closing school will enhance spreading COVID – 19 goes more than one thousand cases.

**Keywords:** COVID – 19, causality relationship and Asian region.

## Introduction

For years, people around the world have been facing many devastating disease relating to immunodeficiency syndrome such as HIV/AIDS, severe acute respiratory

syndrome coronavirus SARS-COV and coronavirus (COVID – 19)... Wherever the epidemic strikes, human and society are affected. In December of 2019, some cases of unknown diseases are reported in Wuhan City, Hubei Province of China. From December 31, 2019 to January 3, 2020, there was 44 cases of patients with pneumonia of unknown etiology<sup>1</sup>. Until now, updated to 29 April 2020, in global scale, it is detected exceeded 3 million cases. Specifically, European and American regions are both reported with highest infectious cases: 1.4 million cases and 1.2 million cases respectively. With the urgent cases of COVID – 19, there are many studies investigate the impact and treatment of this virus. Researchers have found that COVID – 19 has the same origin with former SARS – COV, MERS, specifically  $R_0$  – refers to the basic reproductive number of new cases for SARS in the late 2000is in the range between

---

### Corresponding Author:

#### Lien Nguyen-Phuong

A PhD and Lecturer, Business Administration Department, Faculty of Business Administration, Van Lang University, Viet Nam. Address: 45 Nguyen Khac Nhu Street, Co Giang Ward, District 1, Ho Chi Minh City-70000

e-mail: [nguyenphuonglien@vanlanguni.edu.vn](mailto:nguyenphuonglien@vanlanguni.edu.vn)

Phone: +84918604066

2–5, that is resemble with the range of the mean  $R_0$  for COVID – 19<sup>2</sup>. These papers focus on the medical nature, origin of COVID – 19 and how to treat COVID – 19 medically. The outbreak of COVID – 19 is an urgent issue therefore the research tends to investigate the linkage among new cases of COVID – 19 and social, demographic factors. Our paper primarily aims to trace the relationship of new case of spreading coronavirus and social & demographic factors such as time to close school too late, classification of income in 24 countries in four areas including European, Asian, American and African regions from January 31, 2020 to 27 April, 2020.

**Literature Review:** Contact networks models likely refers to interpersonal contacts then easily lead to diffusion diseases in a community. Specifically, contact networks may happen within schools, workplaces, hospitals, households, therefore people in community can easily transmit the diseases if they are infectious. A group of previous authors generated a stimulated contact networks for the small city in Vancouver, British Columbia for the dataset approximately 1000 households equivalent to 2600 people<sup>3</sup>. In general, the contact networks model shows the crucial of contact patterns to the pandemic, especially, with different contact networks may share resemble the basic reproductive number of new cases ( $R_0$ ), may have different epidemiological outbreaks results.

Regarding to medical geography, it is considered a spatial analytic method to evaluate the linkage between geographic determinant and illness people, in addition, can be used to identify the geographic processess affect pandemic dispersion. Traced back to the former cases to get involve in the sustantial role of spatial diffusion of deases, if we consider the impact of disease on global scale, the impacts of pandemic outbreaks in one part of the world will rapidly spread to the rest of the world. SARS outbreaks in Hong Kong and mainland China, then transmit rapidly to Toronto, the rest of the world. Gatrell<sup>4</sup> emphasized that diseases occur in specific location then by transportation or travel will enhance the diffusion. Whereby, group authors identified that if infectious people are barred at borders and if the Hong Kong as well as other continents did not leave their nation, there will not be a significant outcome as recognized until now<sup>5</sup>.

At the beginning with the influenza pandemic, there is not available vaccine or antiviral medicine to treat diseases, therefore, social distance with a community

is considered the vital method to protect itself. Some researchers indicated that this designed strategy is acknowledged effectively mitigate the diffusion of pandemic influenza without the use of vaccine<sup>6</sup>. Specifically, these authors at the first stage described how social contact network-focused mitigation can be constructed, then a stimulation model for the influenza outbreak, hence, built a model in which there is a population of 10.000 of a small US town, the result showed that children and adolescents are subject of the flu therefore keeping them at home will reduce the attack rate (90%), moreover, with higher infectious strains, tailored to specific communities such as quarantine, closing schools, social contact network, working from home, etc. are suitable local defenses against pandemic in the absence of vaccine or antiviral medicine<sup>6</sup>. Gumel et al.<sup>7</sup> indicated that reducing the contact rate between susceptible and diseased individuals by isolating, is critical importance in order to reduce the diffusion of SARS.

With respect of temperature, the outbreaks of SARS in the 2000s and the spread of COVID – 19 recently are caused by impact of weather. However, there are few studies investigate relation between diseases with region and why diseases refer outbreaks in countries with low temperatures. A few researchers used ecological analysis to demonstrate the significant relation between daily numbers of SARS infected people with environmental temperature, whereby, temperature in the range 16 – 28 Celsius degree is likely associated with SARS cases, which may increase the virus growth. It is proved that during the outbreak of SARS in Guangzhou, Hong Kong, Beijing and Taiyuan, the temperature subsequently approximately from 16.5°C to 25°C<sup>8</sup>.

## Material and Methodology

The data was extracted from World Health Organisation (WHO)'s database for the new cases variable and World Bank database for three remain variables: Time to close school to late, Income and Region from 24 countries in European, American, African and Asian regions. The study collects the panel data with the long time series characteristic. There are four key variables:

- New case of spreading coronavirus (NEWCASE)
- Time to close school too late (TCSCH). This is a dummy variable (early close (closing Schools before March, 2000) = 0 and too late (closing from

1<sup>st</sup> March) = 1). This indicator represents the level of social distance of a country.

- Classification of income of the research countries (INCOME). This is dummy variable (high income = 1 and the other = 0), which shows the one of demographic variables.
- Region where the studied country are being (REG). This is dummy variable (Asian region = 1, the other region = 0). This vector confirms the different climate, cultural and society in cross-country.

The reason for choosing this period because although the disease appeared at Wuhan, Hubei, China ever since December 2019 but the disease pandemic started on global scale from January 2020 to April 2020. Furthermore, the research period provides evidence of the long-data for investigating causality link between COVID – 19 and social-demographic factors in long-term. Besides, the reason for selecting these 24 countries due to available data daily. The table 1 also notes that the panel data has outlier so the paper has to deal with this phenomenon.

The research applies four – step method to analyze the relationships of Coronavirus and social & demographic factors as follows:

First, due to outlier data so we check the Gini coefficient to ensure the equality value of the frequency distribution data. Owing to the outlier characteristic of NEWCASE (see table 1) so the research conducts the

Gini coefficient correlation check that is appropriate with outlier phenomenon. Second, the research data is a panel with large T and small L, with outlier data so that we apply the Levin-Lin-Chu(LLC)<sup>9</sup> test (see table 3), which assumes that all panels have the same autoregressive parameter, that is, that  $\rho_i = \rho$  for all i. Then the alternative hypothesis is simply that  $\rho < 1$ . The hypotheses (H) are that  $H_0$ : Panels contain unit roots and  $H_a$ : Panels are stationary. The LLC test requires that the panels be strongly balanced. Third, we apply the Westerlund and Edgerton<sup>10</sup> cointegration test with hypotheses that  $H_0$ : No cointegration and  $H_a$ : Some panels are cointegrated. Rejection of  $H_0$  is thus substantial to validate an existence of co-integration given the entire the panel<sup>10</sup>. Finally, the study applies the causality test among all of the four variables to identify the direction of the relationship among COVID – 19 and other social factors following Ka and Mussard<sup>11</sup> for fixing outlier issue.

### Results

Before conducting the main results, we carry out the descriptive and correlation analyses. Table 1 reports the results of descriptive statistics. There are 2112 observations during 88- days research period from January 31, 2020 to April 27 2020. The mean of NEWCASE is 989.70 cases while the standard deviation is too large. The new case of spreading coronavirus gets a peak when the United States of America was on the epidemic top of 38509 case in April 26, 2020.

**Table 1: Description variables**

Variables	Observation	Mean	Std. Dev.	Min	Max
New Case	2112	989.70	3675.29	0	38509 (United States of America April 26)
TCSCH	2112	0.52	0.50	0	1
Income	2112	0.58	0.49	0	1
REG	2112	0.58	0.49	0	1

Source: WHO and World Bank’s database.

**Table 2: Unit root test results**

t-statistic	New Case		TCSCH		Income		REG	
	Statistic	p-value	Statistic	p-value	Statistic	p-value	Statistic	p-value
Unadjusted t	-8.37	0.00***	-6.16	0.00***	-7.08	0.39	-8.50	0.00***
Adjusted t*	-4.46		-2.96		-0.29		-3.82	

Note: t statistics in parentheses: \*  $p < 0.1$ , \*\*  $p < 0.05$ , \*\*\*  $p < 0.01$ .

We check and know that the research data is a strongly balanced panel. The Gini coefficient correlation check shows that among independent variables (TCSCH, INCOME, REG) exist equality correlation excepts NEWCASE and among independent variable does not exist the correlation.

Table 2 confirms that almost variables stay, only variable “INCOME” is non-stationary. Next, we apply

the co-integration test following the Westerlund and Edgerton<sup>10</sup> test to check the co-integration between dependent stationary variable and INCOME variable that does not stay. Table 3 below confirm the appearance of co-integration between these two variables. The results indicate that to reduce the new case of Coronavirus, the Government should focus on the effects of social factors: time to close the school, the high-income countries, and the area, whether the country belongs to.

**Table 3: Results of cointegration test**

	New Case – Income with outlier		New Case – Income without outlier	
	Statistic	P-value	Statistic	P-value
Variance ratio	1.51	0.07*	3.21	0.00***

Before running the causality test we check the outlier and get the results for exception of outlier during running regression for the lest bias later.

Having examined the long-run equilibrium relationship, we turn to the causality test among all

considered variables, as shown in Table 4. The study conducts OLS and Gini regression with and without outlier to check robust of the model and get the results as seen as below.

**Table 4: Results of causality**

Variables	Gini with outlier		OLS with outlier		Gini without outlier		OLS without outlier	
	Coef Std. Err	z P>z	Coef Std. Err	t P> t	Coef Std. Err	z P>z	Coef Std. Err	t P> t
TCSCH	1984.51 (151.02)	13.14 (0.00***)	2552.05 (139.55)	18.29 (0.00***)	1051.29 (51.33)	20.48 (0.00***)	1252.34 (49.53)	25.29 (0.00***)
Income	371.53 (180.53)	2.06 (0.04**)	332.34 (1048.08)	0.32 (0.75)	215.20 (60.78)	3.54 (0.00***)	203.10 (329.33)	0.62 (0.54)
REG	-1834.38 (182.13)	-10.07 (0.00***)	-1933.04 (1048.32)	-10.07 (0.07*)	-803.95 (61.85)	-13.00 (0.00***)	-834.75 (329.55)	-2.53 (0.01***)
Constant	805.68 (207.33)	3.89 (0.00***)	589.42 (1159.49)	0.51 (0.61)	353.70 (69.86)	5.06 (0.00***)	273.57 (364.43)	0.75 (0.45)
No. Obs.	2112		2112		2073		2073	
R <sup>2</sup> /GR	0.80		0.13		0.75		0.24	
Gamma YYhat	0.73				0.76			
Gamma YhatY	0.58				0.57			
MSE			3429.3				1151.9	
Wald chi2			338.69 (0.00***)				647.07 (0.00***)	

Table 4 notes that both Gini and OLS regression with and without outlier points to the existence of direct effects on the new case of spreading coronavirus associated with time to close school too late. However, Gini regression

also provides evidence of the positive effect of INCOME on the NEWCASE. This means the INCOME causes a new case of spreading coronavirus, the COVID – 19 has a positive link with the high-income countries. Besides,

their negative causality between REG and NEWCASE. The difference of region except ASIA will lead to a new case of spreading coronavirus. The model of Gini without outlier provides the better robust than OLS and Gini with outlier<sup>11</sup>. All P-value and coefficients are statistically significant at 1% level except for INCOME variable. A positive coefficient of TCSCH indicates that the time to close school too late increases one day, the new case of spreading coronavirus goes up more than one thousand cases. Moreover, a negative coefficient of REG suggests that Asian region where the studied country are being increases, the new case of spreading corona virus decrease around eight hundred cases daily in Asia. This means the COVID – 19 pandemic is different across countries and social distance. Furthermore, INCOME is statistically insignificant to NEWCASE which means that there is no association between the changes in the new case of spreading coronavirus and classification of income of the research countries. Actually, the spreading COVID–19 can happen everywhere especially high income countries such as Italy, USA, Singapore or even low-income country such as Nepal. The result also supports and confirms the previous findings.<sup>6,7</sup>

### Discussion

The pandemic COVID–19 virus outbreaks recently need to be discussed urgently for its effect on every society and economy globally. Applying both co-integration test and causality test, the research result indicates that there is a bi-directional causality between new cases of spreading coronavirus and time to close the schools too late as well as region where the studied country are being. Close schools are important factor to avoid infection and protect the young generation. Furthermore, with the studied countries, located in Asian region, the new cases of COVID – 19 can be easily down to around eight hundred cases daily. Next, the classification of income of the research countries is statistically insignificant to new case of spreading coronavirus. Actually, from January 31, 2020 to April 27, 2020, the coronavirus has been spreading in global scale and in all classification of economics from high income to middle and low–income countries. Therefore, all governments should take highly consideration in social isolation in preventing the COVID – 19 in the absence of vaccine or antiviral medicine.

**Source of Funding:** The researchers do not get any research funding.

**Conflict of Interest:** We hereby confirm that the manuscript has no any actual or potential conflict of interest with any parties, including any financial, personal or other relationships with other people or organizations within three years of beginning the submitted work. Our paper has not been published previously, it is not under consideration for publication elsewhere.

**Ethical Clearance:** Taken research from secondary data through World Bank and WHO’s database following the COPE’s ethical committee.

### References

1. World Health Organization (WHO): Novel Coronavirus Situation Report - 1 21 January 2020; 1–7.
2. Wilder-Smith, A., Chiew, C. J., & Lee, V. J: Can we contain the COVID-19 outbreak with the same measures as for SARS? 2020;102–107.
3. Meyers, L. A., Pourbohloul, B., Newman, M. E. J., Skowronski, D. M., & Brunham, R. C: Network theory and SARS: Predicting outbreak diversity. 2005;71–81.
4. Gatrell, A. C: Complexity theory and geographies of health: A critical assessment. 2005;2661–2671.
5. Ruan, S., Wang, W., & Levin, S. A: The effect of global travel on the spread of SARS. 2006;205–218.
6. Glass, R. J., Glass, L. M., Beyeler, W. E., & Min, H. J: Targeted social distancing design for pandemic influenza. 2006;1671–1681.
7. Gumel, A. B., Ruan, S., Day, T., Watmough, J., Brauer, F., Van Den Driessche, P., ... Sahai, B. M: Modelling strategies for controlling SARS outbreaks. 2004;2223–2232.
8. Tan, J., Mu, L., Huang, J., Yu, S., Chen, B., & Yin, J: An initial investigation of the association between the SARS outbreak and weather: With the view of the environmental temperature and its variation. 2005;186–192.
9. Levin, A., C.-F. Lin, and C.-S. J. Chu: Unit root tests in panel data: Asymptotic and finite-sample properties. 2002;108, 1-24.
10. Westerlund, J., & Edgerton, D. L: Simple tests for cointegration in panels with structural breaks. 2008;665–704.
11. Ka, N., & Mussard, S:  $\ell_1$  regressions: Gini estimators for fixed effects panel data. 2016;1436–1446.

# Satisfaction and Complaints of Patients with Removable Partial Dentures: In Sample at Baghdad City, Iraq

Luma Musa Ibrahim

*Assistant Lecturer, Ms.C. Prosthodontics, College of Dentistry, Alfarahidi University, Baghdad, Iraq*

## Abstract

**Objective:** This study examined patients' complain regarding pain on eating, esthetic and speech problems and gag reflex with various types of removable partial dentures (RPDs).

**Method:** The study sample included 60 RPD wearers (36 females and 24 males) aged between (25-60) years old. Sex, age, occupation, any experience with previous RPDs, and the complaint with RPDs were recorded. Data were analyzed using Chi-square test was applied for comparison among different variables of oral complaints related to removable prosthesis; an independent a sample *t*-test was utilized. A *P*-value < 0.01 was the criterion for rejection of the invalid hypothesis.

**Results:** the results show 60 patients, 16 (47.05%) were satisfied on acrylic and 14 (77.77%) were satisfied on flexible. And 6 (75%) were satisfied on metallic. The mean level of satisfaction among the three types of RPDs was significantly different ( $P < 0.01$ ). In cases satisfaction between flexible and acrylic RPDs was significantly different. But, between either metal or acrylic, or metal and flexible RPDs no significant differences ( $P < 0.01$ ) were recognized.

**Conclusions:** Within the limitations of this study, approximately half of cases that took a removable partial dentures treatment were satisfied with it, showing that the quality of RPDs (in Iraq/Baghdad city) was suitable for patients. Pain in eating is the most common complaint that shows that dental treatments with RPDs should be provided with care when patients have pain in eating.

**Keywords:** *Patient satisfaction, Removable partial denture, oral complaint, Aesthetics, Dental prosthesis.*

## Introduction

The missing tooth structure either carries attacks or injury or other pathological conditions makes researchers and scientists strive to find a suitable material or dental prosthesis to replace the tooth structure in terms of both function and esthetics<sup>(1)</sup>. This is because tooth loss has a negative consequence on facial appearance, speaking and masticatory function and still one of the major oral health problems in the world.<sup>(2,3)</sup>

Now a day, there has been an increase in the number of patients who need prosthodontics treatments<sup>(4)</sup>. As a consequence, the demand for complete or partial dentures also has been raised. This is because of increasing the number of older people among the population as the result of rising life expectancy<sup>(5)</sup>. Thus; there are various alternative treatment modalities available for replacement for partially edentate patients. These treatment involve prosthesis supported by implants, bridges supported by teeth, and removable partial dentures (RPDs)<sup>(6,7)</sup>.

Therefore, choices, like as dental implants, can be not easy to apply because of general and/or patient preferences, oral limitations and financial issues.<sup>(8,9)</sup>

Many studies in different countries have found that the cost of treatments plays a crucial role during the construction of dental prosthesis for partially edentate

---

### Corresponding Author:

**Luma Musa Ibrahim**

Assistant lecturer, MsC Prosthodontics, College of Dentistry, Alfarahidi University, Baghdad, Iraq

e-mail: luma.musa@gmail.com

patients<sup>(10,11)</sup>. For these reasons, the removable partial denture is still the most common way of restoring the missing teeth<sup>(12,13)</sup>.

A survey of 260 Iraqi volunteers based on 2018, whose loosening teeth had been effectively restored with RPDs, It is believed that the quality of prosthodontics treatments may affect significantly on quality of life related to oral health<sup>(14)</sup>.

Despite easy construction, managing (RPDs), minimally invasive treatment choice, reasonably low cost but (RPDs) are still related to many oral complaints such as mastication, speaking difficulties, pain and esthetic concerns<sup>(15)</sup>. The satisfaction of patients with a prosthesis therapy has become an increasingly significant factor in prosthetic treatment<sup>(16)</sup>. Thus, many studies have examined the relation between RPDs and cases satisfaction and their dentures quality<sup>(16,17)</sup>. It is believed that the quality of prosthodontic treatments may affect significantly on quality of life related to oral health<sup>(18,19)</sup>.

It is not easy to expect the patient's satisfaction with RPDs therapy because it is a multifactor characteristic. It has been reported that patients' attitude towards RPDs, patient's personality, any contact with the previous RPD, patients believe the RPDs therapy or forced to do this treatment as well as denture design and fabrication procedures are related to RPDs satisfaction. In addition, there are other important factors, which are strongly correlated with RPDs acceptance by the patients such as, retention, stability, chewing ability and esthetics<sup>(20)</sup>. However, there is a gap in the information on patients' satisfaction and complaint among (RPDs) wearers in

Baghdad city, Iraq. This study aims to explore the patient's satisfaction with comfort or presence of pain, esthetic, retention, mastication, as well as speaking with RPDs.

Various bases have been progressed forming RPD. Flexible, acrylic polymers (polymethyl methacrylate [PMMA]) and metallic (chrome cobalt alloys) materials. And due to the noticeably cheap, manipulated easily with utilization of low-price tools, acrylic RPDs are the

most accepted material for denture framework creation. Therefore, in flexibility term, nylon-derived denture base material make a revolution as a functional alternative material to overcome some restriction and came back to acrylic dentures.<sup>(21,22)</sup>

Correspondingly, in interview by telephone with 260 Iraqi male and female cases who had got RPDs at College of dentistry/Baghdad University, college of dentistry/Al-Anbar University and private clinics.

Even though RPDs are a reversible and a non-invasive therapy, with a suitable price and easy oral hygiene method in most cases, they are related to number of oral complaints, like speech problem, pain, mastication, as well as esthetic issues.<sup>(23,24,25)</sup> Therefore, this survey aimed to detect the complaints and satisfaction level among patients using the three types of RPDs in Baghdad/Iraq.

## Materials and Method

This survey done at three places (College of dentistry/Baghdad University, College of dentistry/Al-Anbar University, private clinics) the dental data was searched for surveying (cases) participants the following criteria for cases included: the age group was (from 25 to 60), telephonic communication, complete and accurate dental data, and available therapy plan of action details. Cases with chronic disorder or systemic diseases which could give an effect oral health, like oral cancer and uncontrolled diabetes, were excluded.

All of 260 cases treated with RPDs from January 2018 to January 2019, these cases got interviewed by phone. 100 cases of them took a call. Of the 100, sixty cases (24 female and 36 male cases) agreed to be a participant in this study as seen in Figure 1. two questions were asked to each participant over the phone interview to detect their complaints and satisfaction levels of with RPD wearers, speaking, eating as well as esthetics. The first question is "Do you have any complaints (comments)" The second question was: "how satisfied are you with the RPD?" cases (sex and age) and information on the type of RPD (acrylic, flexible, or metal) demographics were obtained from the cases dental data.

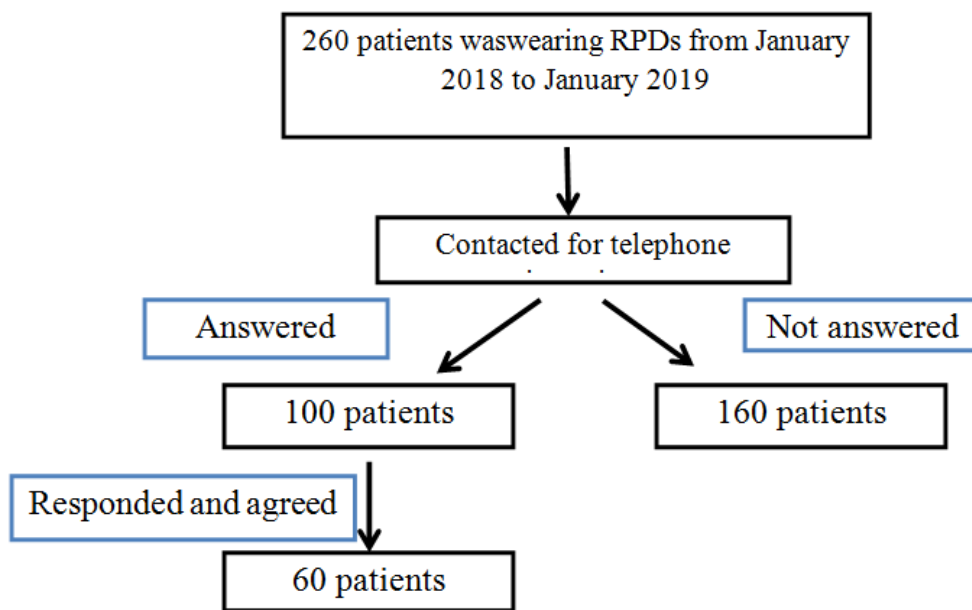


Figure (1) Patient’s participation in study.

**Statistical Analysis:** The resulting data were entered into a statistical software program (Statistical Package for the Social Sciences, version 16.0; SPSS), which was used for all the statistical analyses. Mean ± standard deviation (SD) counts and percentages are used for recording variables. Chi-square test was applied for comparison among different variables of oral complaints related to removable prosthesis; a sample *t*-test was utilized. A *P*-value < 0.01 was the criterion for rejection of the invalid hypothesis. Data were collected from cases electronic files into a Microsoft Excel 2010.

**Results**

For the 260 patients who wear RPD from the three places from January 2018 to January 2019. Sixty cases (24 male and 36 female cases) participated in this survey with three types of RPDs. 34(56.66%) wore acrylic RPDs, 18 (30%) had flexible RPDs, and 8 (13.33%) wore metallic RPDs; variable information was obtained

from all patients. The mean ± SD age of the cases was 49.8 ± 8.3 years for wore acrylic, 47.8 ± 8.9 years for wore flexible and 47.2 ± 7.7 years for wore metallic (range: 25–60 years) as shown in Table 1.

In table 2 Shows, the symptoms were: 23(38%) pain in eating,6(10%) esthetic problems, 16(26.66%) problems in speech, and 10(16.66%) gag reflex where 5(8.33) only had no complaint.

Table 3 shows 60 patients, 16(47.05%) were satisfied on acrylic and 14 (77.77%) were satisfied on flexible. And 6 (75%) were satisfied on metallic.

The mean level of satisfaction among the three types of RPDs was significantly different (*P* < 0.01). In cases satisfaction between flexible and acrylic RPDs was significantly different. But,between either metal or acrylic, or metal and flexible RPDs no significant differences (*P* < 0.01) were recognized.

Table 1 Patient’s demographics

Type of RPD	No. of Patients	Gender		Age (Mean±SD)
		Female	Male	
Acrylic	34	19	13	49.8 ± 8.3
Flexible	18	12	8	47.8 ± 8.9
Metal	8	5	5	47.2 ± 7.7
<b>Total</b>	<b>60</b>	<b>36</b>	<b>24</b>	-



**Table 2 Patient's symptoms and complaint**

Type of RPD	Symptoms				
	Pain on eating	Esthetic problems	Speech problems	Gag reflex	No complaint
Acrylic	14 (41%)	3 (9%)	10 (30%)	7 (20%)	0
Flexible	8 (44%)	3 (17%)	5 (28%)	2 (11%)	0
Metal	1 (12.5%)	0	1 (12.5%)	1 (12.5%)	5 (62.5%)
<b>Total</b>	<b>23</b>	<b>6</b>	<b>16</b>	<b>10</b>	<b>5</b>

**Table 3 Patient's satisfaction**

Type of RPD	No. of patients satisfied	P values	
		Flexible	Metal
Acrylic	16/34	0.03	0.15
Flexible	14/18	-	0.87
Metal	6/8	-	-

\*P value < 0.01.

## Discussion

In this study observed the rate of complaints and satisfaction among sixty cases wearing three kinds of RPDs in Baghdad city/Iraq. According to the result of this survey indicates that the approximately half of cases were fulfilled with their RPDs. That result was in agreement with other surveys on RPDs.<sup>(26, 27)</sup> the mean age of RPD wearers in this study was 48.2 years (range: 25–60). Others studies also had the same age range.<sup>(28,18,19)</sup>

Flexible RPDs are a good therapy choice for partially edentulous cases due to their definitely better esthetics given by bases that copy gums and teeth, also due to them being more comfortable for cases with changing oral tissue, severe cases with microstomia, as well as decrease of function.<sup>(22)</sup> and because of that, flexible RPDs can appropriately satisfy patients displeased with the common recovery therapy since they give an excellent fix for the cases esthetics or physical limitations.<sup>(29)</sup> It is in agreement with Sharma & Shashidhara (2014), flexible RPDs produce acceptable outcomes but short duration.<sup>(22)</sup> due to that flexible RPDs haven't been commonly used as a substitute material for denture fabrication as shown in this survey .

It is observed that patient satisfaction between different RPDs materials was varied. Acrylic resin (PMMA) RPDs were had a lowest satisfaction level,

followed by metallic (chrome cobalt alloys), while the higher level of satisfaction was shown inflexible nylon-base material. These results are in agreement with those of Yoshida et al. (2011), who indicate that cases with acrylic RPDs have had a lower satisfaction levels than of those with flexible nylon-base material RPDs.<sup>(30)</sup> in spite of these results the Iraqi samples not prefer flexible RPDs because of its low duration.

Moreover, shown that a low satisfaction levels with acrylic resin base in comparison with metallic base, acrylic resin base RPDs were frequently used in this survey 34 (56.66%). These results are similar to other studies in countries in Middle East. Ismail and Hussien (2009) proposed that over 97% of Iraqi patients wore acrylic RPDs.<sup>(31)</sup> in agreement with Rahdi et al. the Kingdom of Bahrain Indicates that 89% of RPDs determine were acrylics.<sup>(15)</sup>

Although, RPDs are commonly used for the substitute of losing teeth, The most frequent complication have been reported among different countries .<sup>(27)</sup> In this survey, pain during eating followed by speech problems are the most common complaints for RPD wearers in Iraqi cases, that are in agreement with Akeel, in KSA, (2010).

Additionally, this survey was managed within one year of RPD utilization, that may be seen as not enough time to predict the accurate levels of case

satisfaction. a sample of KSA cases, Akeel et al. (2010) indicated that 36% of RPD wearers discontinued using the RPDs one year after wearing it.<sup>(23)</sup> It was proposed that an observational study based on frequent recall time had to be developed.

### Conclusion

Within the limitations of this study, approximately half of cases that took removable partial dentures treatment were satisfied with it, showing that the quality of RPDs (in Iraq/Baghdad city) was suitable for patients. Pain in eating is the most common complaint that shows that dental treatments with RPDs should be provided with care when patients have pain in eating.

Ethical Clearance was obtained from Alfarahidi University, Baghdad, Iraq.

**Conflict of Interest:** None

**Funding:** None

### Reference

- Hewa A. Salih, Jwan R. Abdulazeez, Tanya H. Hama Faiq, Mohammed A. Mahmood, Rukhosh H. Abdalrahim,- Patient Complaints and Satisfaction with Removable Partial Dentures Therapy in Sulaimani City, Iraq, *Sulaimani Dent J.* December 2019 Vol 6(2)
- Gil-Montoya JA, de Mello AL, Barrios R, Gonzalez-Moles MA, Bravo M. Oral health in the elderly patient and its impact on general wellbeing: a nonsystematic review. *Clin Interv Aging.* 2015;10:461-67.
- Kassebaum NJ, Bernabe E, Dahiya M, Bhandari B, Murray CJ, Marcenes W. Global burden of severe tooth loss: a systematic review and metaanalysis. *J Dent Res.* 2014;93(7):20S-28S.
- United Nations Population Division. *World Population Aging. The 2015 Revision.* New York: United Nations, 2015.
- Yang Y, Zhang H, Chai Z, Chen J, Zhang S. Multiple logistic regression analysis of risk factors associated with denture plaque and staining in chinese removable denture wearers over 40 years old in Xi'an – a cross-sectional study. *PLoS ONE.* 2014;9(2):e87749.
- Stilwell C. Risk management in clinical practice. Part 6b. Identifying and avoiding medico-legal risks in removable dentures. *Br Dent J.* 2010;209(7):339-50.
- Furuyama C, Takaba M, Inukai M, Mulligan R, Igarashi Y, Baba K. Oral health-related quality of life in patients treated by implant-supported fixed dentures and removable partial dentures. *Clin Oral Implants Res.* 2012;23(8): 958-62.
- Stilwell C. Risk management in clinical practice. Part 6b. Identifying and avoiding medico-legal risks in removable dentures. *BDJ.* 2010;209(7):339–350.
- Furuyama C., Takaba M., Inukai M., Mulligan R., Igarashi Y., Baba K. Oral health-related quality of life in patients treated by implant-supported fixed dentures and removable partial dentures. *Clin Oral Implants Res.* 2012;23(8):958–962.
- Sakka S., Baroudi K., Nassani M.Z. Factors associated with early and late failure of dental implants. *J Investig Clin Dent.* 2012;3(4):258–261.
- Leles CR, Martins RR, Silva ET, Nunes MF. Discriminant analysis of patients' reasons for choosing or refusing treatments for partial edentulism. *J Oral Rehabil.* 2009;36(12):909-15.
- Özkurt-Kayahan Z, Tomruk CÖ, Kazazoğlu E. Partial edentulism and treatment options. *7 tepe klinik.* 2016:31-36.
- Charyeva OO, Altynbekov KD, Nysanova BZ. Kennedy Classification and treatment options: A study of partially edentulous patients being treated in a specialized prosthetic clinic. *J Prosthodont.* 2012;21(3):177-80.
- Shafaei A. Correlation between socioeconomic status and different types of prosthetic modalities in hail region, Saudi Arabia. *Dent Oral Craniofacial Res.* 2016;2(5):344–348.
- Radhi A., Lynch C.D., Hannigan A. Quality of written communication and master impressions for fabrication of removable partial prostheses in the Kingdom of Bahrain. *J Oral Rehabil.* 2007;34(2):153–157.
- Yeung A., Lo E., Clark R., Chow T. Usage and status of cobalt-chromium removable partial dentures 5-6 years after placement. *J Oral Rehabil.* 2002;29(2):127–132.
- Mohsen K. Aljabri, BDS, Tamer O. Ibrahim, MD and Rayan M. Sharka, BDS, Removable partial dentures: Patient satisfaction and complaints in Makkah City, KSA Received 20 December 2016; revised 27 February 2017; accepted 7 March 2017;

Available online 25 April 2017

18. Pellizzer E.P., Almeida D.A., Falcón-Antenucci R.M., Sánchez D.M., Zuim P.R., Verri F.R. Prevalence of removable partial dentures users treated at the Aracatuba Dental School -UNESP. *Gerodontology*. 2012;29(2):140–144. [PubMed] [Google Scholar]
19. AL-Dwairi Z. Need and demand of removable dentures by Jordanian adults and relationship to socioeconomic factors. *J Oral Hyg Health*. 2013;1(2):113. [Google Scholar]
20. Shala KS, Dula LJ, Pustina-Krasniqi T, Bicaj T, Ahmedi EF, Lila-Krasniqi Z, Tmava-Dragusha A. Patient's satisfaction with removable partial dentures: retrospective case series. *Open Denti J*. 2016;10:656-63.
21. Singh J., Dhiman R., Bedi R., Girish S. Flexible denture base material: a viable alternative to conventional acrylic denture base material. *Contemp Clin Dent*. 2011;2(4):313.
22. Sharma A., Shashidhara H.S. A review: flexible removable partial dentures. *J Dent Med Sci*. 2014;13(12):58–62.
23. Akeel R. Usage of removable partial dentures in Saudi male patients after 1 year telephone interview. *Saudi Dent J*. 2010;22(3):125–128.
24. Khan M., Khan A. Oral complaints and level of satisfaction among the removable denture wearers. *Pak Oral Dent J*. 2015;35(1)
25. Shams A., Tavanafar S., Dastjerdi M.R., Chaijan K.A. Patient satisfaction and complication rates after delivery of removable partial dentures: a 4-year retrospective study. *SRM J Res Dent Sci*. 2015;6(4):225–229.
26. -Wu J., Yang Y., Wang C., Lee H., Du J. Effects of denture maintenance on satisfaction levels of Taiwanese elderly using removable partial dentures: a pilot study. *Gerodontology*. 2011;29(2):458–463.
27. Knezović Zlatarić D., Čelebić A., Valentić-Peruzović M., Čelić R., Filipović-Zore I., Baučić M. The satisfaction with the removable partial denture therapy in the Croatian adult population. *Coll Antropol*. 2000;24(2):485–494.
28. Siqueira G.P., Dos Santos M.B., Santos J.F., Marchini L. Patients' expectation and satisfaction with removable dental prosthesis therapy and correlation with patients' evaluation of the dentists. *Acta Odontol Scand*. 2013;71(1):210–214.
29. Simone Guimarães Farias, Altair Antoninha Del Bel; Flexible resins: an esthetic option for partially edentulous patients, RGO, Rev Gaúch Odontol, Porto Alegre, v.63, n.1, p. 81-86, jan./mar., 2015.
30. Yoshida E., Fueki K., Igarashi Y. A follow-up study on removable partial dentures in undergraduate program: Part I. Participants and denture use by telephone survey. *J Med Dent Sci*. 2011;58:61–67.
31. Ismail I.J., Hussein B.M. Frequency and suppliers of removable partial dentures among group of Iraqi population. *J Bagh Coll Dent*. 2009;21(2):49–54.

# Deep Learning Classification Method to Detect and Diagnose the Cancer Regions in Oral MRI Images

M. Praveena Kirubabai<sup>1</sup>, G. Arumugam<sup>2</sup>

<sup>1</sup>Research Scholar, <sup>2</sup>Head of the Department (Retd), Senior Professor, Madurai Kamaraj University, Madurai-21, Tamil Nadu, India

## Abstract

The paper proposes deep learning algorithm used to classify the oral images into either normal or abnormal images. The cancer regions are segmented using morphological operations. The segmented cancer regions are further diagnosed into 'Mild' or 'Severe' using deep learning algorithm. The main advantage of the deep learning algorithm is that it requires minimum number of oral images for both classification and diagnosis stages of the proposed work. In this paper, the total number of cancers affected oral images used is about 160 and the proposed oral cancer detection system using CNN classification approach classifies 159 cancer affected oral images correctly and achieves 99.3% of detection rate.

**Keywords:** *Deep learning, cancer, oral images, detection system, detection rate.*

## Introduction

The term cancer, means "crab" in Latin, was coined by Hippocrates in the fifth century to describe a family of diseases. The tissues grow and spread unrestrained throughout the body, eventually choking of life. Cancer, in simple terms, is the disease caused by malfunctioning of cells, lost their control on proliferation. The cluster of cells, called a tumor or a neoplasm, constantly expands in size. Occasionally, cells might spread throughout the body, forming new tumors at distant sites, and the process of dissemination is called metastasis. Cancer, a multifactorial disorder, arises due to the defect in genetic makeup and exposure to environmental insult. Oral cancer, a life-threatening cancer worldwide, arises in the oral cavity due to ill-habits such as tobacco smoking and chewing. Cancer might occur anywhere in the body and a common strategy is to name them based on the organ or the type of cell they originate; the net result is more than 100 types of cancer. Among them, oral cancer is one of the most common malignancies present in the head and neck region.

Oral cancer, a malignant neoplasm of the mouth, is the fifth most frequent cancer in occurrence and eighth most common cause of cancer related deaths worldwide. The burden of oral cancer, worldwide, is drastically increasing despite of the advanced procedures available

for early diagnosis and treatment. Oral cancer rates are rising in several countries dramatically. The mortality rate due to oral cancer worldwide is 30% and 12% in male and female respectively. Tobacco smoking and chewing are considered as the major predisposing factors for the development of oral cancer. All forms of tobacco habits are significantly associated with the development of oral cancer. Smokeless Tobacco (SLT) has been accepted as one of the strongest risk factors for the development of oral carcinoma.

In this paper, deep learning algorithm such as Convolutional Neural Networks (CNN) is used to classify the oral images into either normal or abnormal images. The cancer regions are segmented using morphological operations. The segmented cancer regions are further diagnosed into 'Mild' or 'Severe' using deep learning algorithm.

**Literature Survey:** A hybrid method was used by combining Fuzzy C-Means and neutrosophic algorithm for segmentation of tumors in the oral panoramic image proposed by Alsmadi (2016)<sup>4</sup>. It used speckle reduction by  $3 \times 3$  size median filter to reduce the speckle noise, using neutrosophy algorithm. This approach provided a significant improvement in segmenting oral lesions. The accuracy comes from the use of indeterminacy degree to cluster the region and determination of the

tumor. However, as this study was based on cluster calculation and image boundary location, shadow areas on the panoramic image will be a concern in terms of false detection. A study utilized variants of Support Vector Machine (SVM), such as Linear SVM, Quadratic SVM and Cubic SVM, were used to classify tumors on optical coherence tomography images. They compared the sensitivity, specificity and accuracy in six different classification conditions (Banerjee et al. 2016)<sup>5</sup>. Tanupriya Choudhury et al. (2016)<sup>6</sup> proposed the Intelligent Classification of Lung and Oral Cancer through diverse data mining algorithms. Logistic regression was a powerful tool modeling and also used for generalization of the linear regression. The optimal quantity of the Logic Boost iterations was performed and cross validated, taken to the selection of the attribute was automatic. Yi-Ying Wang et al. (2016)<sup>7</sup> presented a new color-based approach for automated segmentation and classification of tumor tissues from microscopic images. The procedure consists of a three-stage Color-Based Feature Extraction (CBFE) system. It normalized all the acquired images to the same color distribution by color transformation. Computerized selection of training samples was used for Automatic feature extraction. A similar study was made by Chang et al. (2016)<sup>8</sup> using hybrid feature extraction and machine learning classification algorithm with biomarkers. They proposed and tested five tumor classification method. The method, Adaptive Neuro Fuzzy Inference System (ANFIS), achieved the highest classification rate of 93.81% by combining the clinical pathologic dataset and biopsy images. This study considered patient's case as a whole. However, if the clinic pathologic dataset or images were considered as a separate sample, the result might not be achieved over 90% accuracy rate. In other words, the accuracy of the method rely on the patient's information.

An automated oral lesion detection method was studied by Galib et al. (2015)<sup>2</sup>. They discussed two systems to discover the two types of common lesions in the oral cavity. It achieved 92% sensitivity with 32% of false positives on average in close border lesions and 85% sensitivity with no false positives in open border lesions. Moreover, it had also discussed the possibility of improvement in open border lesion algorithm to 100% sensitivity with only 13% of false positives. Belvin Thomas et al. (2013)<sup>3</sup> proposed Texture Analysis Based Segmentation and Classification of Oral Cancer Lesions in Color Images using ANN. The objective was to select a reduced set of features that clearly distinguish between different groups of malignancy caused by

carcinoma of different areas of oral cavity. They proposed the use of textural and run-length features of camera images. Hobdell et al. (2003)<sup>1</sup> investigated the relationship between socioeconomic status variables and oral health in an attempt to determine the association between social, economic and behavioral risk factors and the incidence of oral cancer among other oral health concerns. Their results described a marked gradient in oral diseases between the most highly and the least socio-economically developed countries and there was an apparent association between oral cancer and the socioeconomic status variables.

**Proposed Methodology:** In this paper, deep learning algorithm is used to classify the oral images into either normal or abnormal images. The cancer regions are then segmented using morphological operations. The segmented cancer regions are further diagnosed into 'Mild' or 'Severe' using deep learning algorithm. The main advantage of this deep learning algorithm is that it requires minimum number of oral images for both classification and diagnosis stages of the proposed work. Figure 1 shows the proposed oral cancer classification and diagnosis system using Convolutional Neural Network (CNN) classification approach.

**Enhancement:** In this paper, adaptive local histogram equalization framework is applied on the low-resolution oral MRI image for improving the intensity level of each pixel in the source image. In this section, the following steps are used to detect and remove the noisy pixels in oral MRI images.

**Step 1:** The source oral MRI image is divided into  $n \times n$  non-overlapping sub blocks, where,  $n$  is the odd number value.

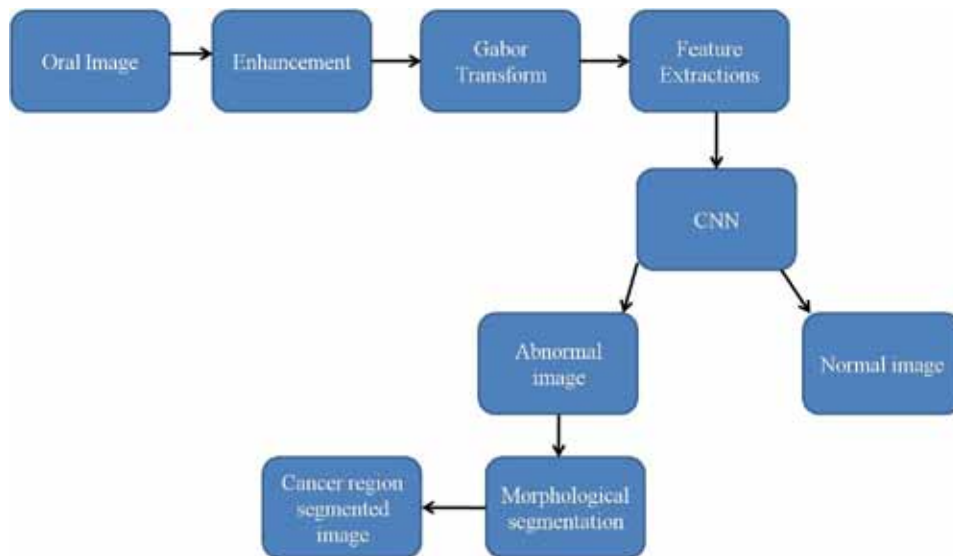
**Step 2:** In each  $n \times n$  non-overlapping sub blocks, place the pixels in horizontal, vertical and two diagonal direction into P1, P2, P3 and P4 sets, respectively.

**Step 3:** Make order of pixels in P1, P2, P3 and P4 sets and eliminate the lower and higher order pixel from each set.

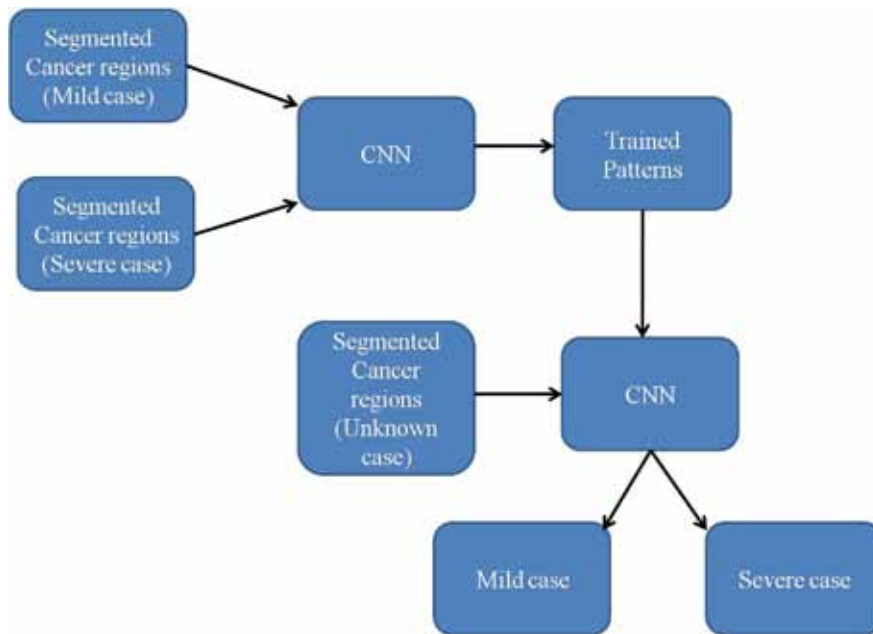
**Step 4:** Find standard deviation of each pixel set and find similarity index of each pixel.

**Step 5:** Consider the sub pixel set which has low value of standard deviation.

**Step 6:** Apply adaptive mean filter in the final sub pixel set in order to remove the noisy content.



(a)



(b)

**Figure 1 Proposed oral cancer classification and diagnosis system using CNN classification approach (a) Classification method (b) Diagnosis method**

**Gabor Transform:** In this paper, Gabor transform is used for spatial into multi oriented image conversion. The Gabor kernel is multiplied with enhanced oral image and the Gabor kernel is given as,

$$G(x, y) = e^{-\frac{(x^2 + y^2)^2}{2 \cdot \sigma^2}} * \cos(2 * \pi * f * \frac{x}{\lambda} + \varphi)$$

where,  
 $\sigma$ : Standard deviation.  
 $\gamma$ : Spatial aspect factor is a constant set to 1.  
 $\lambda$ : Spatial wavelength.

$$y^i = -x * \sin \theta + y * \cos \theta$$

The frequency of the Gabor kernel is assigned by ‘f’ and it is shifted from 1 to 5 concerning spatial angle factor. Consequently, five quantities of Gabor kernels are created by duplicating the Gabor kernel with Oral picture concerning distinctive frequencies. These Gabor multiplied pictures comprises of real and imaginary terms. Further, Gabor magnitude image is built by choosing the maximum pixel value at each position

in the Gabor multiplied pictures ( $Y(x,y)$ ) utilizing the condition.

$$Y(x, y) = I(x, y) * G(x, y)$$

where,

$I(x, y)$ : Oral image;

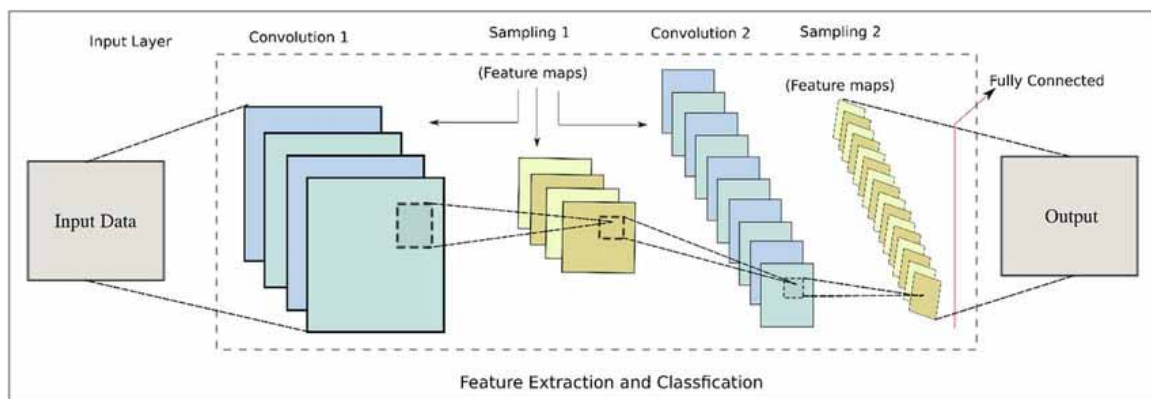
$G(x, y)$ : Gabor kernel

$Y(x, y)$ : Output response of the Gabor multiplication;

$$|Y(x, y)| = \sqrt{\text{Real}(Y(x, y))^2 + \text{Imaginary}(Y(x, y))^2}$$

**Feature Extractions:** It is one type of texture features used for classifying the various regions in a Gabor transformed magnitude image. It encodes one feature value for one pixel in a Gabor magnitude oral image. The 3\*3 window is placed on the Gabor transformed oral image and it computes LBP (Local Binary Pattern) for each pixel using its surrounding pixels. The size of Gabor magnitude oral image and its extracted LBP images are same.

**Classification:** The machine learning algorithms for cancer region detection in oral images requires number of external features. These machine learning method are not suitable for further severity diagnosis process. In order to overcome such drawbacks the conventional machine learning method called deep learning method - Convolutional Neural Networks (CNN) is used in this work to detect and diagnose the cancer regions in oral images. As in machine learning algorithm, CNN also have both training and testing phases. During the training phase of the CNN classifier, the normal oral images and abnormal oral images are trained by the CNN producing the trained patterns. During the testing phase of the CNN classifier, the source oral image is tested with respect to the trained patterns. The response from this CNN classifier is either normal or abnormal. The CNN architecture used in this research work is depicted in Figure 5.



**Figure 5 CNN architecture**

The CNN architecture includes Convolutional layers, pooling layers, and fully connected layers. The Convolutional layer consists of a number of convolution kernels, which is a two-dimensional matrix of weights  $W$ . The convolution kernel convolves an input image (also a two-dimensional matrix) in the form of a sliding window with a matrix called feature map is obtained. Each Convolutional layer has Convolutional kernel itself and it is convolved with the oral image. The pooling layer is also called the sampling layer, uses the sliding window to convolve the input or the feature map so that it might reduce the feature dimension and the amount of calculation. Pooling layer has two different types as "Average" and "maximum" pooling. Different from the Convolutional layer, the pooled layer (maximum pooling is adopted in this paper) does not depend on

weights and parameters. In general, each feature map of the input is pooled in the same way and the number of features of the original input remains unchanged. Then, the fully connected layer is used to map the feature representations from the Convolutional layer to the sample space in order for classification, composed of a group of neurons and connections with weighted values. Since the number of the parameters of the fully connected layers is very large, some networks use the Convolutional neural networks to take place in the fully connected layers. The proposed CNN method for oral cancer image detection and classification is depicted in the following algorithm.

**Input:** Oral image;

**Output:** Classification response;

Start;

Step 1: The input oral image is convolved with kernel of first Convolutional layer and the response is produced.

Step 2: The size of the convolved sequences are reduced by passing these values through the pooling layer 1.

Step 3: The size reduced sequences are now passed through the Convolutional layer 2.

Step 4: The response from the second Convolutional layer is passed through the second pooling layer.

Step 5: The output response from the second Convolutional layer is feed into neural network architecture to produce the classification pattern.

End;

Further, mathematical morphological operations are used to segment the cancer regions in classified oral images. The morphological parameters such as area, width and height are computed for its diagnostic process. The segmented oral cancer regions are analyzed for the mild and severity of the cancerous regions using CNN classification.

### Results and Discussions

The proposed fully automated oral cancer detection and diagnosis system is divided into two different sections as cancer region detection or segmentation and cancer region diagnosis. This automated cancer region detection and segmentation approach on oral images is applied on the oral images obtained from the open access dataset. The performance of the proposed oral cancer region segmentation on oral images using classification method is evaluated in terms of sensitivity, specificity and accuracy. These performance evaluation metrics are given in the following equations.

$$Sensitivity = \frac{TP}{TP + FN}$$

$$Specificity = \frac{TN}{TN + FP}$$

$$Accuracy (Acc) = \frac{TP + TN}{TP + TN + FP + FN}$$

The number of correctly detected cancer pixels in the classified abnormal oral image is noted by True Positive (TP), the number of correctly detected non-cancer pixels in the classified abnormal oral image are noted by True Negative (TN). The number of incorrectly detected cancer pixels in the classified abnormal oral image is noted by False Positive (FP), the number of incorrectly detected non- cancer pixels in the classified abnormal oral image are noted by False Negative (FN).

Table 1 shows the performance evaluation of oral cancer detection and segmentation using CNN classification method and it achieves 98.6% of sensitivity, 99.1% of specificity and 99.7% of oral cancer segmentation accuracy.

**Table 1 Performance evaluation of oral cancer segmentation using CNN classification methodology**

Parameters	Simulation results (%)
Sensitivity	98.6
Specificity	99.1
Accuracy	99.7

Table 2 shows the analysis of data augmentation method in CNN architecture on proposed oral cancer detection and segmentation.

**Table 2 Analysis of data augmentation method in CNN architecture on proposed oral cancer detection and segmentation**

Performance parameters	With Data Augmentation	Without Data Augmentation
Se (%)	98.6	93.7
Sp (%)	99.1	94.1
Acc (%)	99.7	95.6

Table 3 shows the comparisons of proposed oral cancer segmentation with various method. The proposed oral cancer detection system using CNN classification approach achieves 99.3% of detection rate, whereas Muzakkir Ahmed et al. (2017) achieved 90.1% of detection rate, Anuradha et al. (2015) achieved 89.5% of detection rate and Konstantinos et al. (2012) achieved 87.9% of detection rate.



**Table 3 Comparisons of proposed oral cancer segmentation with other method**

Authors	Methodologies	Detection Rate (%)
Proposed work	CNN classifier	99.3
Muzakkir Ahmed et al. (2017)	Thresholding technique	90.1
Anuradha et al. (2015)	Watershed segmentation algorithm	89.5
Konstantinos et al. (2012)	Decision Support System	87.9

Table 4 shows the comparisons of proposed oral cancer diagnosis system with other method. The total number of mild case oral images used in this work is 100 and the total number of severe case oral images used in this work is 150 as illustrated in Table 4. This proposed

diagnosis method using CNN classification method classified 100 mild images as mild case category and the proposed method classified 150 severe case images as severe case category (99.3%).

**Table 4 Comparisons of proposed oral cancer diagnosis system with other method**

Authors	Number of Mild case images tested	Number of Mild case images correctly classified	Number of Severe case images tested	Number of Severe case images correctly classified
Proposed work	100	99	150	150
Zeeba Shamim Jairajpuri et al. (2019)	100	96	150	147
Muzakkir Ahmed et al. (2017)	100	72	150	142
Anuradha et al. (2015)	100	84	150	139
Konstantinos et al. (2012)	100	71	150	135

## Conclusions

This paper develops a methodology using deep learning algorithm to classify the oral images into either normal or abnormal images. The cancer regions are segmented using morphological operations. The segmented cancer regions are further diagnosed into 'Mild' or 'Severe' using deep learning algorithm. The main advantage of this deep learning algorithm is that it requires minimum number of oral images for both classification and diagnosis stages of the proposed work. In this paper, the total number of cancers affected oral images used is about 160 and the proposed oral cancer detection system using CNN classification approach correctly classifies 159 cancer affected oral images correctly and achieves 99.6% of detection rate.

**Conflict of Interest:** Nil

**Ethical Clearance:** Nil

**Source of Funding:** Nil

## References

- Hobdell MH, Oliveria ER, Bautista R, Myburgh NG, Lalloo R, et al. "Oral diseases and socio-economic status (SES)". *Br Dent J.*(2003);194(2):91-96.
- Galib, S., F. Islam, M. Abir & H.K. Lee. "Computer aided detection of oral lesions on CT images," *Journal of Instrumentation*, (2015);10(12).
- Belvin Thomas, Vinod Kumar, Sunil Saini. "Texture Analysis Based Segmentation and Classification of Oral Cancer Lesions in Color Images Using ANN, *IEEE International Conference on Signal Processing Computing and Control (ISPCC)*,(2013): 1-5.
- Alsmadi, M.K. "A hybrid Fuzzy C-Means and Neutrosophic for jaw lesions segmentation," [Press release], Retrieved from <https://doi.org/10.1016/j.asej.2016.03.016>.(2016).
- Banerjee, S., Chatterjee, S., Anura, A., Chakrabarty, J., Pal, M., Ghosh, B., Chatterjee, J. "Global spectral and local molecular connects for optical coherence tomography features to classify oral

lesions towards unravelling quantitative imaging biomarkers,” *RSC Advances*. (2016); 6(9):7511-7520.

6. Tanupriya Choudhury, Vivek Kumar, Darshika Nigam, Bhaskar Mandal. “Intelligent Classification of Lung Oral Cancer through diverse data mining algorithms”, *International Conference on Micro-Electronics and Telecommunication Engineering*. (2016).
7. Yi-Ying Wang, Shao-Chien Chang, Li-Wha Wu, SenTien Tsai and Yung-Nien Sun. “A Color-Based Approach for Automated Segmentation in Tumor Tissue Classification”, *Conference of the IEEE EMBS CitéInternationale, Lyon, France*. (2016).
8. Chang, S.W., Abdul-Kareem, S., Merican, A.F., Zain, R.B. “Oral cancer prognosis based on clinicopathologic and genomic markers using a hybrid of feature selection and machine learning method,” *BMC Bioinformatics*,(2016); 14(1).

# Chalk and Talk Versus Powerpoint: Perception among Medical Students

Mahanta Putul<sup>1</sup>, Lahkar Babita<sup>2</sup>, Borah Pollov<sup>3</sup>, Das D.K.<sup>4</sup>, Choudhury Manoj Kumar<sup>5</sup>

<sup>1</sup>Professor, Forensic Medicine and Toxicology, Assam, India, <sup>2</sup>Associate Professor of Anesthesiology FAA Medical College, Barpeta, Assam, India, <sup>3</sup>Associate Professor of Anesthesiology Jorhat Medical College and Hospital, Jorhat, Assam, India, <sup>4</sup>Professor of Microbiology Diphu Medical College, Diphu, Assam, <sup>5</sup>Additional Director of Medical Education and Executive Director of National Health Mission Assam

## Abstract

**Introduction:** The emerging technologies made by day changing the techniques of teaching medical education. The teaching technique has changed since the last decade from the old traditional technique of chalk and talk (CNT) to a newer technique of Power-point presentation (PPT) to the video classrooms converting the whole traditional environment of the classrooms. This paper aims to access the perception of the medical students about these two instructional method.

**Materials and Method:** In this study cross-sectional descriptive survey was used. Medical students were selected through non-probability convenient sampling. The data were collected using a questionnaire-based survey about their views and perception of two method of lecture delivery, viz., PPT presentation, and using a chalkboard. For each of the two method, the students were asked to rank twelve comments on a four-point scale: strongly agree, agree, disagree, or strongly disagree. The data was analyzed using SPSS version 16 and the results expressed as proportions.

**Results:** In our study where more than 97% of our study respondents emphasized the value of chalk and talk and declared it as the more effective and useful teaching tool in their learning experience compared to PowerPoint (86%) and recommended it for teaching.

**Conclusion:** Both CNT, as well as PPT, are the effective method for medical education and both can be used in combination for the effective delivery of classroom sessions.

**Keywords:** Teaching method; medical education; classroom techniques.

## Introduction

Lectures have been the most common form of teaching and learning since ancient times.<sup>1</sup> Although discussion method in small groups appear to be a superior method of attaining higher-level intellectual learning.<sup>2</sup>

During the past few decades, the presentation method in the classrooms have changed from the traditional CNT to the modern technique of PPT. The most accepted criterion for measuring good teaching technique, however, is the amount of student learning.

Students often have little expertise in knowing if the technique selected by an individual instructor was the best teaching technique or just 'a technique' or simply the technique with which the teacher was most comfortable.<sup>3</sup>

During a lecture, both the visual and auditory senses are used to absorb information and here assistance in the form of the visual aid is useful.<sup>4</sup> A chalkboard is

---

### Corresponding Author:

**Das D.K.**

Professor of Microbiology Diphu Medical College,  
Diphu, Assam

e-mail: drdipakdad606@gmail.com

Mobile: +919401252269

uniquely effective as a medium of classroom instruction and has been used commonly in lectures, while the use of transparencies with an overhead projector (TOHP) is also popular.<sup>5</sup>

In traditional classrooms, a teacher's basic instructional tools for displaying information are chalkboards, multipurpose boards, pegboards, bulletin boards, and flip charts.<sup>6</sup> To project instructional materials, overhead transparencies displayed via an overhead projector are still a commonly used classroom presentation method.<sup>3</sup> Recently the use of electronic presentations has become common and PPT is now the most popular instructional aid.<sup>7</sup>

The impact of technology has led to the increased use of computers for presenting information in many of today's classrooms. PPT hailed as an easy-to-use means of creating professional presentations teachers for creating classroom presentations.<sup>8</sup> A study found PPT to be one of the most widely used software programs in both an area educator preparation program and local public schools.<sup>9</sup> It is seen that "more than 400 million copies of the program are currently in circulation, and somewhere between 20 and 30 million PPT-based presentations are given around the globe each day".<sup>10</sup>

Various studies have been conducted to assess the effectiveness of lectures using PPT or other such media in comparison to lectures using the chalkboard, or the use of TOHP. According to one study, traditional classes with blackboard presentation were the most favoured by students from biomedicine and medicine courses.<sup>11</sup>

Recently the use of electronic presentations has become common and PPT is now the most popular package used out of all electronic presentations.<sup>12</sup>

Therefore, the present study was aimed, to assess the student's perceptions of the impact of PPT presentations in lectures compared with the traditional CNT.

## Materials and Method

This is a cross-sectional descriptive study. Medical students were selected through non-probability convenient sampling. The data were collected during 2017 from the undergraduate medical students at Gauhati Medical College and hospital using a questionnaire-based survey about their views and perception of two method of lecture delivery, viz., PPT presentation, and using a chalkboard. For each of the two method, the students were asked to rank twelve comments on a four-point scale: strongly agree, agree, disagree, or strongly disagree. The data was analyzed using SPSS version 16 and the results expressed as proportions. As this study is on classroom technique and has not revealed the identity of any of the participants, so ethical clearance from the ethics committee is not required. However, informed consent was taken before the collection of the data.

## Results

Distribution of perception of undergraduate medical students regarding the method of the CNT is narrated in **Table 1**.

**Table 1 Distribution of perception of UG medical students regarding the method of chalk and talk**

Sl.No.	Statements regarding perception	Strongly Agree	Agree	Disagree	Strongly disagree
		%	%	%	%
1.	I understand the lecture better when the teacher uses this technique	26	71	2	1
2.	I feel the student interaction is better with the teacher	33	53	12	2
3.	Eye contact between teacher and student is less	14	41	36	9
4.	The lecture advances the understanding	20	67	12	1
5.	This technique helps me to concentrate and remember better	38	50	10	2
6.	The quality and quantity of my lecture notes can't be maintained	12	48	30	10
7.	The delivery of lecture is interesting	26	51	20	3
8.	The content of the lecture informative	19	68	11	2
9.	The lecture is audible	28	65	7	0

Sl.No.	Statements regarding perception	Strongly Agree	Agree	Disagree	Strongly disagree
		%	%	%	%
10.	The lecture content was well organized	30	47	20	3
11.	The teacher remains more professional	25	59	15	1
12.	The teacher needs more preparation for the class	30	50	18	2

The distribution of perception among the undergraduate medical student regarding PPT as a method of teaching is narrated in **Table 2**.

**Table 2 Perception of undergraduate medical students regarding PPT**

Sl.No.	Statements regarding perception	Strongly Agree	Agree	Disagree	Strongly disagree
		%	%	%	%
1.	I understand the lecture better when the teacher uses this technique	30	56	12	2
2.	I feel the student interaction is better with the teacher	29	45	24	2
3.	Eye contact between teacher and student is less	14	47	34	5
4.	The lecture advances the understanding	19	65	16	0
5.	This technique helps me to concentrate and remember better	30	46	21	3
6.	The quality and quantity of my lecture notes can't be maintained	12	48	37	3
7.	The delivery of lecture is interesting	20	58	22	0
8.	The content of the lecture informative	20	71	7	2
9.	The lecture is audible	24	64	12	0
10.	The lecture content was well organized	35	50	10	5
11.	The teacher remains more professional	27	52	20	1
12.	The teacher needs more preparation for the class	31	42	23	4

In the present study, 97% of the participants emphasized the value of chalk and talk and declared it as the more effective and useful teaching tool in their learning experience as compared to PowerPoint (86%) and recommended it for teaching.

### Discussion

Teaching is an art. This study highlights the fact that the favourite technique of lecture delivery for students by different faculties in the classroom can vary so much within the same college.

Different technologies are available in classrooms for teaching in the present day scenario. The use of better teaching technique aid allows students to understand better. This also allows more time for interaction and further understanding. Use of technology can be a very beneficial and time-saving tool for all teachers.

An evaluation by the students can provide the teacher with the best user feedback regarding the best teaching method.

In the present study, medical students favoured a combination of teaching aids rather than single teaching support. Regarding the preference of medical students, the order of priority of combined teaching aids they have opted was PPT+CNT using blackboard.

This preference may probably be because the inherent deficiency of each method is compensated by the other. While CNT using blackboard teaching is deficient in showing the three dimensional (3-D) diagrams, animated videos and real-time sounds. However, the same can be demonstrated using a PPT. Furthermore, PPTs take less time to present the same information as compared to CNT using blackboard teaching. CNT teaching allows the students to take down the notes and diagrams which

is difficult with PPTs as there is a tendency to deliver the lecture fast.<sup>13</sup>

The current results agree with Chaudhary R et al.<sup>14</sup> Here the author revealed that the majority of the students (67.1%) favoured the combined teaching aids. With the CNT using blackboard, the student pointed the drawback, is that it takes time to draw a labelled diagram on the board and during that time teacher's eye contact with the students get interrupted.

SN Baxi et al.,<sup>15</sup> in their study, revealed that an equal number of students preferred CNT and multimedia-based lectures. Seth et al.,<sup>16</sup> also compared the preference for teaching aid between medical students versus dental students. The medical students have preferred PPT whereas the dental students preferred the Chalkboard in their study.

Some participating students opined that the effectiveness of the teaching lecture depends upon the teacher, regardless of the teaching aid used. What is fundamentally important in university teaching is not the quality of the technology but the quality of the teacher as revealed in a study<sup>17</sup> agree the current results. Besides, a good teacher knows to start at a basic point of the course, which students can understand and then lead them gradually through the new and more difficult points.<sup>18</sup>

### Conclusion

In conclusion, combined teaching support is considered as most satisfying teaching support because the inherent deficiency of one aid is compensated by the other. If single teaching assistances is to consider then the blackboard teaching aid is the most pleased by the undergraduate medical students as they can follow the teacher well with a deep understanding of the concept effectively.

The present study, as well as the previous studies, does not bring out the superiority of any single support system of the teaching method. It seems that with the hands of a trained teacher any teaching technique would be suitable and effective. This highlights the need for formal training of the teachers in teaching in the classroom to develop a perfect skill to motivate students.

**Source of Funding:** None declared.

**Conflict of Interest:** None declared.

### References

1. Brown G, Atkins M. *Effective teaching in higher education*. London, UK: Routledge; 1988. [cited 2017 March 13]; Available from: URL:<http://www.itl.usyd.edu/supervision.org/>
2. Cannon R. *Lecturing*, Kensington, NSW: Higher education research and development society of Australia; 1988. [cited 2017 March 13]; Available from: URL:<http://www.rsc.org/>
3. Hithesh Mishra, Vipin Kumar, Pankaj Kumar. Comparison of different teaching methodologies in a medical college in North India. *IJBAMR* 2013 March;6(2):464-469.
4. Sahu DR, Supe AN. The art and science of presentation: 35-mm slides. *J Postgrad Med* 2000;46:280-285.
5. Estes A, Ressler S, Welch R, Hanus J. Seminar on communication skills. Exceed teaching workshop 2009. [cited 2017 March 13]; Available from: URL:<http://www.asce.org/>
6. Yoa, J. E., Ouyang, J. R., and Wang, H. A farewell to the traditional instructional media and technologies in the new millennium. 2000, [cited 2017 March 13]; Available from: URL:<http://www.unfi.edu/>
7. Prasad S, Roy B, Smith M. The art and science of presentation: Electronic presentations. *J Postgrad Med* 2000;46:193-198.
8. Pedras, MJ, Horton, J. Using technology to enhance teacher preparation. Paper presented at the annual meeting of the Northwest Association of Teacher Educators 2009. [cited 2017 March 13]; 1996. Available from: URL:<http://www.apbr.edu/SRATE>
9. Ljungdahl RT. Technology integration in the teacher preparation program and public schools in samhouston center for professional development and educational partnerships at samhouston state university. *Dissertation Abstracts International* 61(8):3133.
10. Does PowerPoint make you stupid? [cited 2017 March 13]; Available from: URL:<http://www.sociable-media.com/PDF/>
11. Novelli ELB, Fernandes AAH. Student's preferred teaching techniques for biochemistry in biomedicine and medicine courses. *Biochem Mol Biol Educ* 2007;35:263-266.

12. Prasad S, Roy B, Smith M. The art and science of presentation: electronic presentations. *J Postgrad Med* 2000;46:193–198.
13. Vikas Seth, Perna Upadhyaya, Mushtaq Ahmad, Virendra Kumar. Impact of various lecture delivery method in pharmacology. *EXCLI Journal* 2010;9:96-101.
14. Chaudry R, Dullo P, Gupta U. 2009. Attitude of 1<sup>st</sup> MBBS medical students about two different visual aids in physiology lectures. *Pak Journal Physiology* 2005;5(2):94-96.
15. SN Baxi, CJ Shah, RD Parmar, Parmar, CB Tripathi. Student's perception of different teaching aids in a medical college. *AJHPE* 2009;1(1):15-16.
16. Vikas S, Perna U, Mushtaq A, Vijay M. PowerPoint or chalk and talk: perceptions of medical students versus dental students in a medical college in India. *Advances in Medical Education and Practice* 2012;1:11-16.
17. Ahmed C. PowerPoint versus traditional overheads. Which is more effective for learning? Paper presented at conference for the South Dakota Association for Health, Physical Education and Recreation; 1998.
18. Shallcross DE, Harrison TG. Lectures: electronic presentations versus chalk and talk – a chemist's view. *Chem Educ Res Pract* 2007;8:73–79.

# ***In-vitro* Cytotoxic Activity of *E. coli* Outer Membrane Vesicles (OMVs) Against Breast Cancer (MCF-7) Cell Line**

**Mahmood Abed Hamzah<sup>1</sup>, Ali Husain Alwan<sup>2</sup>, Suzan Saadi Hussain<sup>2</sup>**

<sup>1</sup>PhD Student, <sup>2</sup>Prof., Department of Biology, College of Science, Al-Mustansiriyah University, Iraq

## **Abstract**

Twenty-five samples of urine were collected from patients suffering Urinary Tract Infection (UTI) from hospital in Baghdad, twenty-two bacterial isolated (88%) were identified. From our result showed the *E. coli* number 5 is the best bacterial virulence factor for producing OMV, Tumor cells ( $1 \times 10^4 - 1 \times 10^6$  cells/ml) have been grown in 96 flat well micro-titre plates, with a final volume of 200 cells per well. The microplate was gently shackled and covered by sterilized parafilm then incubation of the plates at 37°C, 5 % CO<sub>2</sub> for 24hrs. Two folded serial dilutions of the desired compound (12.5, 25, 50, 100, 200, 400 μg/mL) were added to the wells after incubation. Triplicates were used per each concentration as well as controls (serum-free medium treated cells). Plates were incubated for specified exposure time (24 hours) at 37°C, 5 percent CO<sub>2</sub>. Applied 10 μ liters of MTT solution to each well after exposure. The absorbance was determined by a wavelength of 575 nm using an ELISA reader. Statistical analysis was performed on the optical density data to calculate the compound concentration required to cause a 50 percent reduction in cell viability for each cell line. The rate of cell growth inhibition (the cytotoxicity percentage) was calculated and plot of % cytotoxicity against sample concentrations assisted to calculate the concentration which exhibited 50% cytotoxicity (IC<sub>50</sub>). Calculate: cell number: determine cells per milliliter.

**Keywords:** Cytotoxic Activity; *E. coli*; outer Membrane Vesicles (OMVs); breast cancer (MCF-7).

## **Introduction**

Outer membranes vesicles (OMVs) can to transfer biological molecules to host cells and their development among gram-negative bacteria is intended. Apart from their role in the communication of bacteria, virulence factors are transferred to the host for cargoes to OMVs to boost bacterial survival<sup>(1)</sup>.

Outer membranes vesicles have properties which permit the transmission of DNA fragments, autolysins, cytotoxins, virulence factors, and various other biomolecules to be mediated by them and their secretion allows bacteria to interact with and within the species

and also strengthens their contact with the host. OMVs were recognized for their role in nutrient procurement, stress reactions and toxin transmission, adherence to and virulence factors in avoiding host defense systems among the prominent roles in various pathological and physiological <sup>(2,3)</sup>.

Cancer is an uncontrolled cellular development and spreading disease, where cells do not respond to the normal controls and cause the tumor to grow and to metastasize<sup>(4)</sup>. However, chemotherapy does not target drugs directly in cancer sites, which ensures that healthy cells are susceptible to adverse reactions. Also because of its fast removal and nonspecific distribution, a large dose is needed<sup>(5)</sup>. The goal of nanomedicine is to identify cost-effective molecules with high cell specificities and susceptibility<sup>(6)</sup>.

Cancers' immunotherapy may be categorized as immunotherapeutic therapies with the goal of utilizing innate or adaptive immunity in oncology<sup>(7)</sup>.

---

### **Corresponding Author:**

**Mahmood Abed Hamzah**

PhD Student, Department of Biology, College of Science, Al-Mustansiriyah University, Iraq  
e-mail: bellnancy651@gmail.com



Nevertheless, the successful treatment and eradication of cancer tumors have been avoidable due to inadequate induction of immune responses using conventional vaccination approaches, despite the tremendous potential of cancer vaccines<sup>(8)</sup>. It highlights the need for new vaccine approaches, in which tumor antigens and APC adjuvants are administered effectively and with a good enough immune response to kill tumor cells. Over the past three decades, nanoparticles have been intensively studied as a delivery method of modern chemotherapy over firm tumors<sup>(9,10)</sup>.

## Material and Method

**Method for preparation of outer membrane vesicles (OMV):** Overnight on lysogeny broth, bacterial cells were cultivated with shaking at 37 °C (150rp.m.) until the OD600 reached 1.5 (1 percent tryptone, 0 percent yeast extract, 1 percent NaCl, 7.0 pH). At 5000rpm twice for 20min, at 4°C, the cultivated cells were pelleted. The supernatant was filtered with a 0.4 5 µm pore filter and then applied supernatant to cold absolute ethanol at 4°C (twice the volume of supernatant), which lasted 24 hours. This resulted in rough precipitation isolation. The precipitation was dissolved in deionized water and dialysed using a 14000D tubular dialyzis membrane for 24-48 hours with Spectra/Por molecular pore. At 15000rpm twice for 20min, at 4°C, the precept cells were pelleted by using high speed centrifuge. A filter with a pore size of 0,22µm and the OMV pellet were filtered again into water and held at -80 °C for further experiments.

**Gel chromatography purification:** The Pharmacia Fine Chemicals Company has prepared Sephadex G-200 as recommended. A quantity of Sephadex G-200 has been suspended, degassed, and wrapped in 0.1 M Tris-HCl buffer pH8 (1.5x80 cm), the gel has been preserved for 72 hours. Then balanced with the same buffer at room temperatures for swelling. Elution was done at a flow rate of 30 ml/hr and the same control buffer was used. At 280 nm, absorbance was measured for each fraction.

**In-vitro cell line design:** From the National Center for Cell Sciences (NCCS) Pune, breast cancer MCF-7 cell lines were obtained. The cells were maintained in a humidified atmosphere of 50 lg/ml CO<sub>2</sub> at 37 LC in Limited Essential Media supplemented with 10 percent FBS, penicillin (100 U/ml), and streptomycin (100 lg/ml).

### Cell Preparation:

1. The medium EMEM containing: 10% bovine serum fetal, 1mM pyruvate, 100 units of penicillin, and 100µg/ml streptomycin (EPEM full solution), 1X non-essential amino acids. It was used to treat the following compounds.
2. When 90% confluence was reached at a dilution of 1:4, MCF7 cells were divided. Using several of cells at passage = 10.
3. Tripsinisation of MCF7 cells, diluting to EMEM, was conducted on a complete medium and cell density. In complete EMEM, cells have been diluted into 7.5 to 104 cells/ml.
4. In each 96-well-microplate well the cell suspension (100 µl) has been added to achieve 7.500cells/well (7.500cells/well- recommended planting density).
5. Overnight the cells have been incubated at 37 °C with 5 % CO<sub>2</sub>.

### Cell Line Maintenance<sup>(11)</sup>.

The following protocol was performed when the cells in the vessel formed confluent monolayer:

The cell sheet was washed with PBS.

- A. The growth medium was drained.
- B. The cell has been given two to three ml of tetraacetic ethylene diamine (EDTA) solution. The ship was transformed into a soft rocking cover for the monolayer. The vessel allowed incubation of the cells at 37 °C for between 1 to 2 minutes.
- C. The cells were dispersed from the wedding surface into the pipetting medium for production. This medium was applied to the Fresh RPMI medium (15-20 mL).

Incubated at 37 °C and distributed in 5% of the CO<sub>2</sub> incubator D- cells were redistributed in cultivated vessels, flasks or plates whatever is required.

By using the hemocytometer and using the formula, cell concentration was determined by counting the cells:

**Total Cell Count/ml:** Cell count x dilution factor (sample volume) x 10<sup>4</sup>

**MTT Protocol:** The cytotoxic effect of different compounds isolated from Ag Nanoparticles, OMVs, and combination of OMVs and Ag Nanoparticles was performed using MTT ready to use the kit. Tumor cells (1x10<sup>4</sup> – 1x10<sup>6</sup> cells/ml) have been grown in 96 flat well

micro-titre plates, with a final volume of 200 cells per well. The microplate was gently shackled and covered by sterilized parafilm. Incubation of the plates at 37°C, 5 % CO<sub>2</sub> for 24hrs. then two folded serial dilutions of the desired compound (12.5, 25, 50, 100, 200, 400µ g/mL) were added to the wells after incubation. Triplicates were used per each concentration as well as controls (serum-free medium treated cells). Plates were incubated for specified exposure time (24 hours) at 37°C, 5 percent CO<sub>2</sub>. 10µ liters of MTT solution was applied to each well after exposure. Plates were further incubated for 4 hours at 37 °C, 5 % CO<sub>2</sub>. Carefully removed media and added 100µl of solubilization solution per well for 5 minutes. The absorbance was determined by a wavelength of 575 nm using an ELISA reader. Statistical analysis was performed on the optical density data to calculate the compound concentration required to cause a 50 percent reduction in cell viability for each cell line. The rate of cell growth inhibition (the cytotoxicity percentage) was calculated as the following equation:-

**% Cell viability** = (Absorbance of treated cell/ Absorbance of the non-treated cell) x 100.

**% Cytotoxicity** = 100 – cell viability.

**IC50** (Dose concentration that inhibited cell growth by 50%) values were calculated by the linear and logarithmic correlation equation.

A plot of % cytotoxicity against sample concentrations assisted to calculate the concentration which exhibited 50% cytotoxicity (IC<sub>50</sub>).

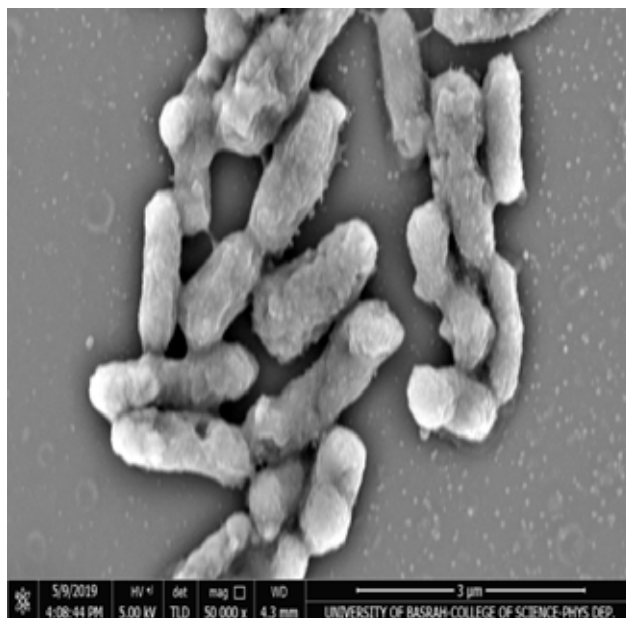
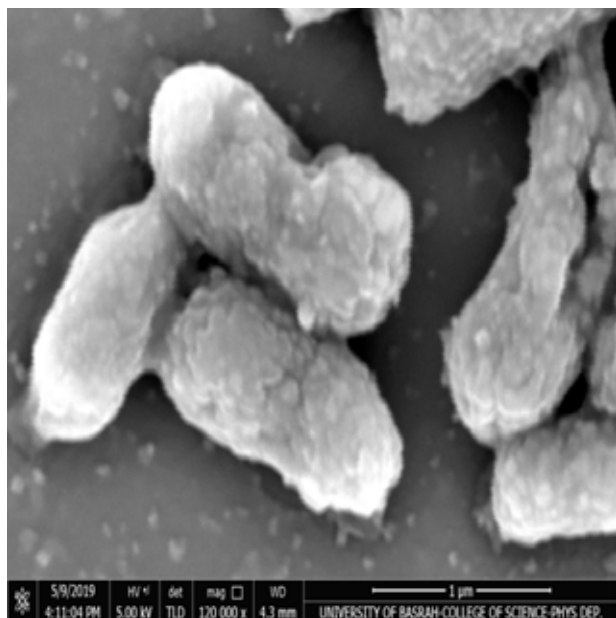
Calculate cell number: determine cells per milliliter by the following calculation:

**Cells/mL** = average count each square × dilution factor × 10<sup>4</sup> total cells = Cells/mL × total unique volume of cell suspension from which sample was occupied. The number 10<sup>4</sup> is the volume correction factor for the hemocytometer: each square is 1 × 1 mm also the depth is 0.1 mm.

## Results and Discussion

The results of screening the highest and best bacterial virulence factors isolates for producing OMV showed that isolate number five 5 is the best for the ability to produce OMV Figure (3-6) and (3-7) with an average diameter of 61.08 – 103.2 nm.

**Isolation OMV:** The results of screening the highest and best bacterial virulence factors isolates for producing OMV showed that isolate number five 5 is the best for the ability to produce OMV Figure (1 & 2) with an average diameter of 61.08 – 103.2 nm.



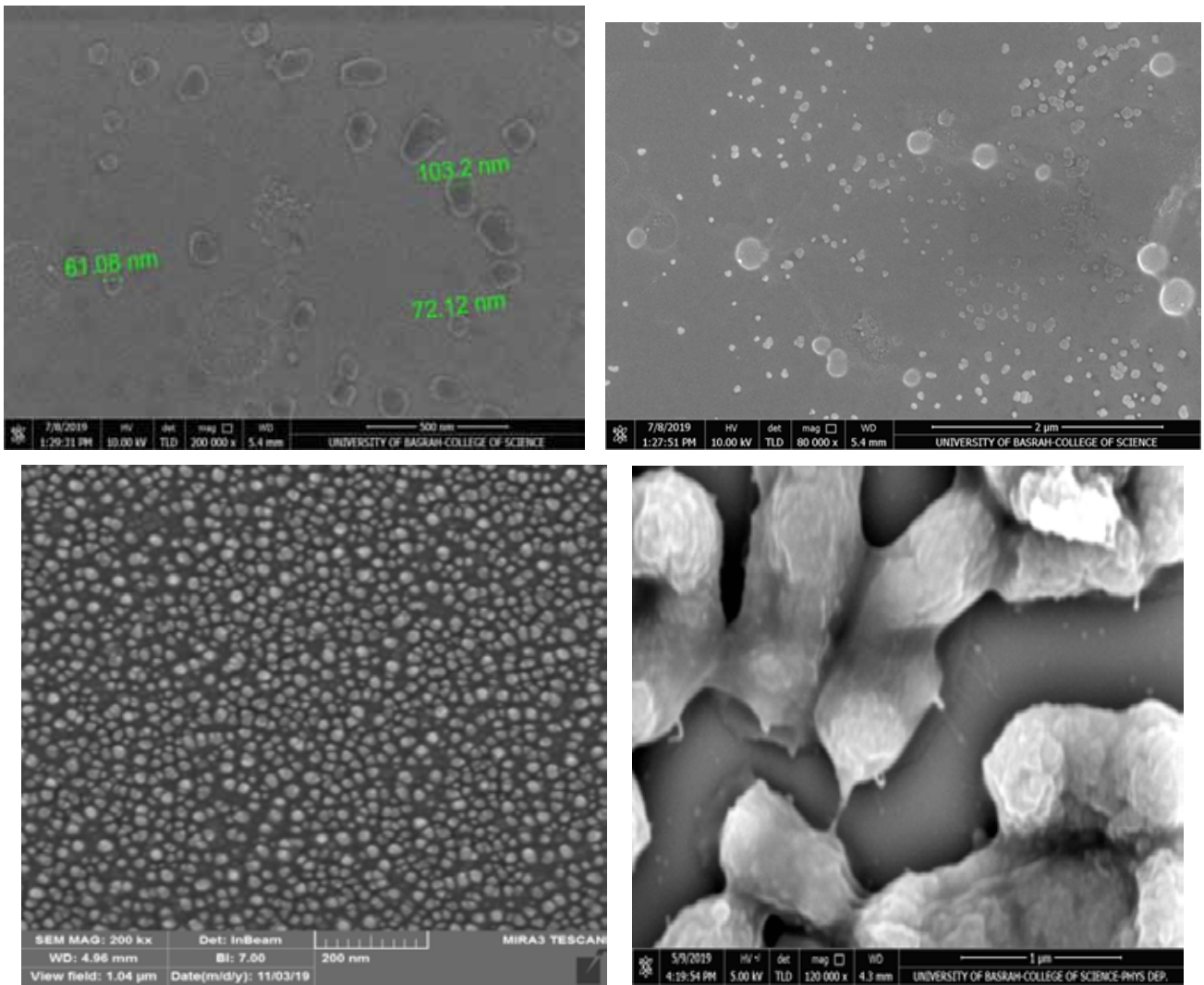


Figure (1): SEM shows the ability of isolate no. 5 to produce outer membrane vesicles (OMV)

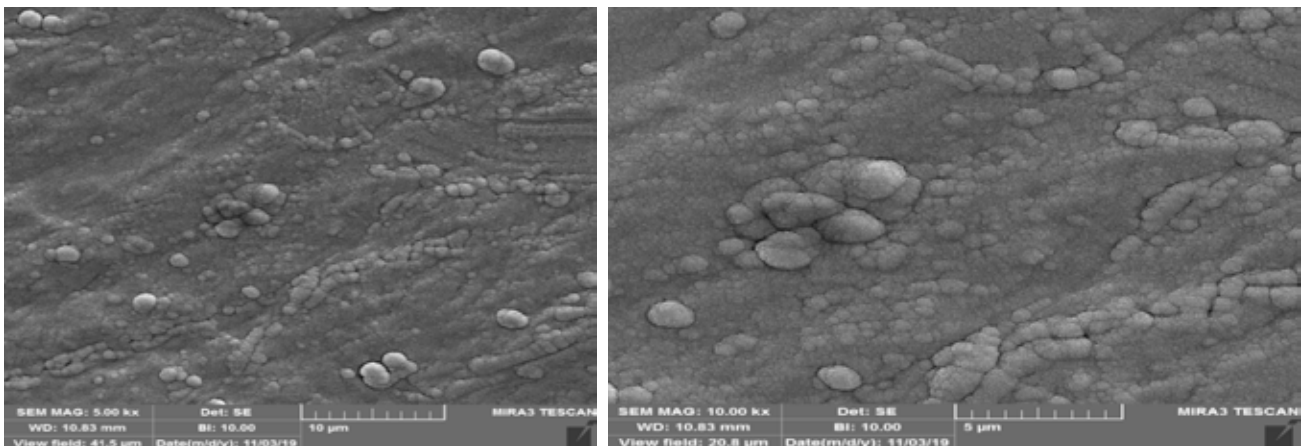


Figure (2): SEM shows the ability of isolate no. 5 to produce outer membrane vesicles(OMVs) by gel filtration chromatography method

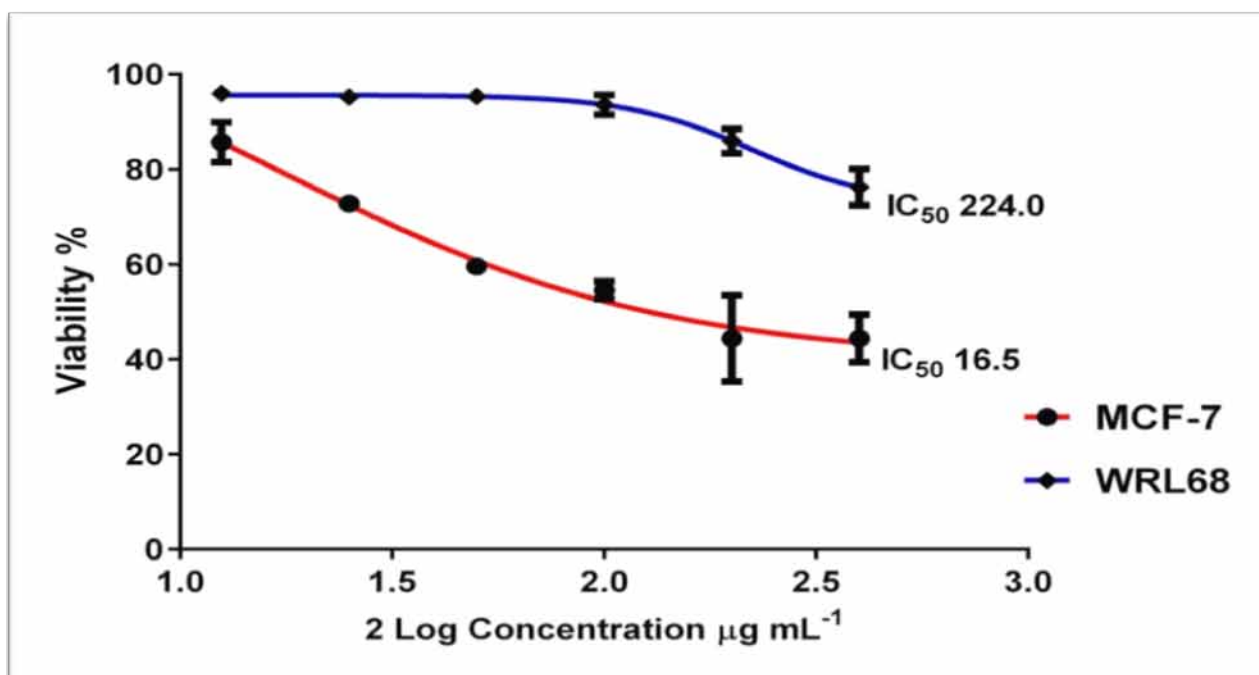
Kim *et al.* (2017) have shown both *E. coli* wild type and mutant bacteria-derived OMVs have nano-dimensional lipid-bilayer vesicular structures, both *E.coli* of which showed with an average diameter of 38.6±3.6 and 38.7±4.2 nm along with the wild-type *E. coli*, OMVs had a higher range of production. OMV *E.coli*, giving an extra advantage of OMVs, as naturally generated OMVs have low productivity issues<sup>(12)</sup>.

Behrouzi *et al.*, (2018) showed that the extracted OMV was 20–75 nm from the disease strain, whereas the

OMV was 45–270 nm from the non-pathogenic strain<sup>(13)</sup>. Rolhion *et al.*, (2005) showed that the pathogenic strain may produce significantly smaller vesicles than the non-pathogenic strain<sup>(14)</sup>, they demonstrated that adequate-invasivity *Escherichia coli* strain LF82 can invade the cultivated intestinal epithelial cells recovered from chronic injury of a patient with Crohn's disease. Anand and Chaudhuri., (2016) have shown that both pathogenic and nonpathogenic bacteria are made of outer membrane vesicles (OMVs) (50-250 nm in diameter) as the canonical result of secretion<sup>(15)</sup>.

**Table (1): Percentage of cell viability MCF-7cancer cell line to E.coli Outer Membrane Vesicles (OMV) at different concentrations**

Row Stats	X Title	A		B	
		MCF-7		WRL68	
	X	Mean ±SD	N	Mean ±SD	N
1	400.000	44.414±5.048	3	76.196±3.855	3
2	200.000	44.421±9.090	3	85.957±2.609	3
3	100.000	54.553±1.860	3	93.596±2.100	3
4	50.000	59.568±0.821	3	95.332±1.183	3
5	25.000	72.801±0.904	3	95.216±0.821	3
6	12.500	85.687±4.186	3	95.949±1.028	3



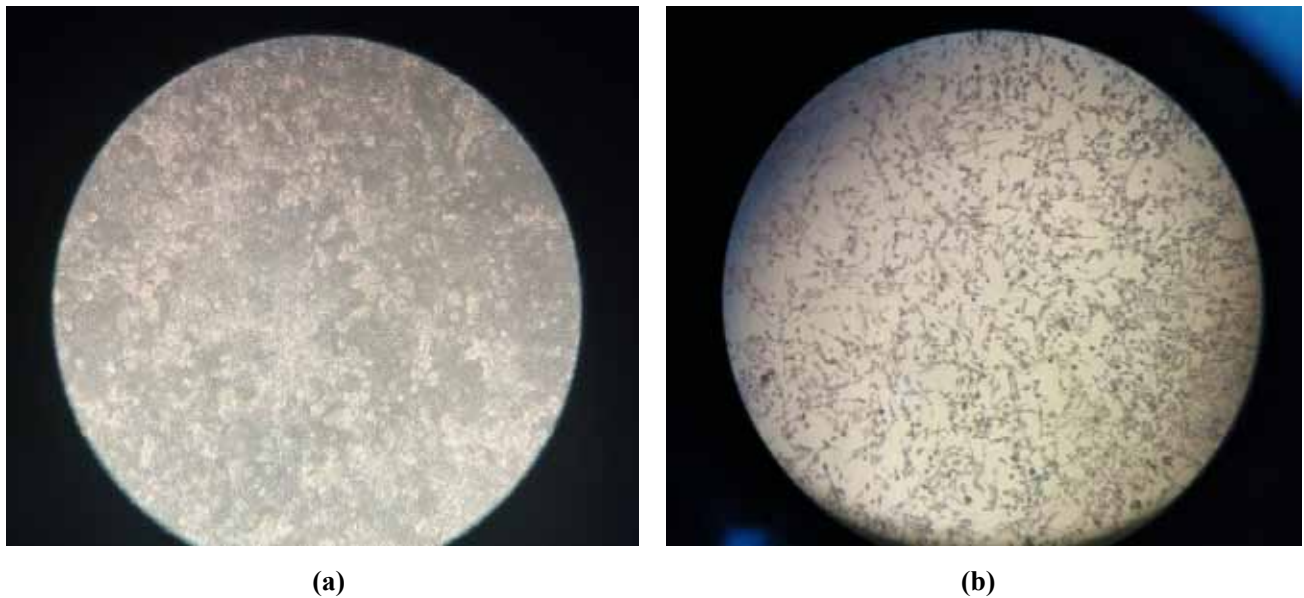
**Figure (3): Shows Cytotoxic activity of isolate no.5 outer membrane vesicles against Breast cancer (MCF-7) using MTT test after 24 h. and 37o C.**

The IC<sub>50</sub> which is the half- maximal inhibitory concentration for cell growth constructing adose response curve was measured. outer membrane vesicles showed IC<sub>50</sub> 16.5 µg/ml compared with WRL68 showed IC<sub>50</sub> 224µg/ml.

At a concentration of 12.5 µg/ml, 85.687% cell viability was observed after treatment with OMVs. However, cell viability reached to 44.414% using 400Mg/ml concentration with OMVs.

Zhang *et al.*,2019 demonstrated in many studies the propensity for immunization with OMV components can be caused by OMV <sup>(16)</sup>. Toxins can act as adhesives for OMVs and thus enable vesicles to enter cells via

the endocytic pathway through a receptor. The host cell input could also be supplemented by common components of vesicles, such as outer membrane protein A (OmpA), this adhesive is fully activated in the OMV membrane rather than as a mixture of purified vesicle components, when it is presented. OMVs are sized (20-200 nm) and can present a variety of surface antigens in a native conformed that enables them to be introduced to lymph vessels and taken up by APCs. The natural features of OMVs like immunogenicity, the ability to act as self-adjuvants, and the ability of immune cells also make them appealing for use as pathogenic bacterial vaccinations.



**Figure (4):** Showed the (a) untreated MCF-7 tumors cell mass showing the proliferating tumor cell (b) treated MCF-7 tumors cell showing massive area of MCF-7

Bélteky *et al.*, (2019) showed that cell viability assays on human A549 adenocarcinoma as well as on non-cancerous MRC-5 fibroblast cells<sup>(17)</sup>. The aggregation dependent toxicity of both AgNP samples was investigated at nanoparticle concentrations corresponding to the respective cell line-specific IC<sub>50</sub> (A549: IC<sub>50</sub>AgNPC =72.2±4.1 ppm; IC<sub>50</sub>AgNPGT =63.1±3.8 ppm; MRC-5: IC<sub>50</sub>AgNPC =17.6±3.0 ppm; IC<sub>50</sub>AgNPGT =1.3±0.2 ppm).

Nazir *et al.*, (2011) reported that for both cell lines Human cancer cell lines HT144 (malignant melanoma of skin) and H157 (squamous cell lung carcinoma) against silver nanoparticles, cytotoxic activity was

observed<sup>(18)</sup>. The 50% inhibition dose of growth (ID<sub>50</sub>) at 3.6 µM was observed. It was further observed that the nanoparticles had an immediate effect as observed under the Inverted Light Microscope following treatment with silver nanoparticles. There was a clear morphological change in cells under the microscope when they lost their attached nature and got rounded.

## Conclusion

*In vitro* experiment showed the OMV optimum cytotoxic activity against breast cancer(MCF- 7) cell line by MTT method, the result showed 44.414% cell viability.

**Conflict of Interest:** Non

**Source of Findings:** Self-findings.

**Ethical Clearance:** Non

### References

1. I hattopadhyay, M. K., & Jaganandham, M. V. Vesicles-mediated resistance to antibiotics in bacteria. *Front. Microbiol.*2015. 6:758.
2. Biller, S. J., Schubotz, F., Roggensack, S. E., Thompson, A. W., Summons, R. E., & Chisholm, S. W. Bacterial vesicles in marine ecosystems. *science*, 2014.343(6167), 183-186.
3. Fulsundar, S., Harms, K., Flaten, G. E., Johnsen, P. J., Chopade, B. A., & Nielsen, K. M. Gene transfer potential of outer membrane vesicles of *Acinetobacter baylyi* and effects of stress on vesiculation. *Appl. Environ. Microbiol.*,2014. 80(11), 3469-3483.
4. Jurj, A., Braicu, C., Pop, L. A., Tomuleasa, C., Gherman, C. D., & Berindan-Neagoe, I. The new era of nanotechnology, an alternative to change cancer treatment. *Drug design, development and therapy*, 2017.11, 2871.
5. Rai, M., Kon, K., Ingle, A., Duran, N., Galdiero, S., & Galdiero, M. Broad-spectrum bioactivities of silver nanoparticles: the emerging trends and future prospects. *Applied microbiology and biotechnology*, 2014.98(5), 1951-1961.
6. Riehemann, K., Schneider, S. W., Luger, T. A., Godin, B., Ferrari, M., & Fuchs, H. Nanomedicine—challenge and perspectives. *Angewandte Chemie International Edition*, 2009.48(5), 872-897.
7. Adams, J. L., Smothers, J., Srinivasan, R., & Hoos, A. Big opportunities for small molecules in immuno-oncology. *Nature reviews Drug discovery*,2015. 14(9), 603-622.
8. Rosenberg, S. A., Yang, J. C., & Restifo, N. P. Cancer immunotherapy: moving beyond current vaccines. *Nature medicine*, 2004.10(9), 909-915.
9. Wang, X., Li, S., Shi, Y., Chuan, X., Li, J., Zhong, T., ... & Zhang, Q. The development of site-specific drug delivery nanocarriers based on receptor mediation. *Journal of controlled release*, 2014.193, 139-153.
10. He, Z., Schulz, A., Wan, X., Seitz, J., Bludau, H., Alakhova, D. Y. & Kabanov, A. V. Poly (2-oxazoline) based micelles with high capacity for 3rd generation taxoids: Preparation, in vitro and in vivo evaluation. *Journal of controlled release*,2015. 208, 67-75.
11. Al-Shammari A.; Yaseen Y.; Alwan, M. Establishment and characterization of AMN3 first murine mammary adenocarcinoma transplantable tumor line in Iraq. *Journal of Iraqi Cancer*. 2008.1(2):1.
12. Kim, O. Y., Park, H. T., Dinh, N. T. H., Choi, S. J., Lee, J., Kim, J. H., ... & Gho, Y. S. Bacterial outer membrane vesicles suppress tumor by interferon- $\gamma$ -mediated antitumor response. *Nature communications*, 2017.8(1), 1-9.
13. Behrouzi, A., Vaziri, F., Rad, F. R., Amanzadeh, A., Fateh, A., Moshiri, A., & Siadat, S. D. Comparative study of pathogenic and non-pathogenic *Escherichia coli* outer membrane vesicles and prediction of host-interactions with TLR signaling pathways. *BMC research notes*, 2018.11(1), 539.
14. Rolhion, N., Barnich, N., Claret, L., & Darfeuille-Michaud, A. Strong decrease in invasive ability and outer membrane vesicle release in Crohn's disease-associated adherent-invasive *Escherichia coli* strain LF82 with the *yfgL* gene deleted. *Journal of bacteriology*,2005. 187(7), 2286-2296.
15. Anand, D., & Chaudhuri, A. Bacterial outer membrane vesicles: New insights and applications. *Molecular membrane biology*, 2016.33(6-8), 125-137.
16. Zhang, Y., Fang, Z., Li, R., Huang, X., & Liu, Q. Design of Outer Membrane Vesicles as Cancer Vaccines: A New Toolkit for Cancer Therapy. *Cancers*, 2019.11(9), 1314.
17. Bélteky, P., Rónavári, A., Igaz, N., Szerencsés, B., Tóth, I. Y., Pfeiffer, I. & Kónya, Z. Silver nanoparticles: Aggregation behavior in biorelevant conditions and its impact on biological activity. *International journal of nanomedicine*, 2019.14, 667.
18. Nazir, S., Hussain, T., Iqbal Md, M. K., Muazzam, A. G., & Ismail, J. M. Novel and cost-effective green synthesis of silver nano particles and their in vivo antitumor properties against human cancer cell lines. *Biosci Tech*,2011. 2(6), 425-430.

# The Predictive Value of Serum Progesterone and Estrogen Receptors as Diagnostic Tool for Premature Ovarian Failure

Mahmood Khalil Ibraheem<sup>1</sup>, Mutazsabahahmied<sup>2</sup>, Firas Shawqi Algburi<sup>3</sup>, Amina Hamed Alobaidi<sup>4</sup>

<sup>1</sup>Clinical Biochemistry Specialist, Tikrit University College of Medicine, Tikrit Iraq, <sup>2</sup>Assistant Professor, Tikrit University College of Medicine, Tikrit Iraq, <sup>3</sup>Assistant Professor, Tikrit University College of Science, Tikrit Iraq,

<sup>4</sup>Assistant Professor, Kirkuk University College of Veterinary Medicine, Kirkuk

## Abstract

**Background:** Premature ovarian insufficiency (POI) is a delicate medical problem in young women. This condition is not unchangeable and permanent but is associated with intermittent and unpredictable ovarian activity, resulting in low conception rate. Over the period of 8 years, the evaluation of secondary amenorrhea was conducted in 90 patients below the age of 40 who wished to restore fertility and is characterized by irregular or absent periods and reduced fertility. Symptoms include those associated with the natural menopause (night sweats and vaginal dryness), and with the long-term adverse effects of estrogen deficiency (osteoporosis and cardiovascular disease): The latter is believed to explain the shorter life expectancy associated with POI.

**Aim:** To illustrate the predictive value of progesterone receptors (PRs), estrogen receptors (ERs), progesterone (PRG), estradiol (E2), Luteinizing hormones (LH), Follicle stimulating hormones (FSH) and Anti mullerian hormones (AMH) serum levels as diagnostic approach for POI.

**Method:** Sixty (60) women with idiopathic POF with thirty (30) women as control groups were included in the study. Baseline investigation in all subjects included serum progesterone receptors (PRs), estrogen receptors (ERs), progesterone (PRG), estradiol (E2), Luteinizing hormones (LH), Follicle stimulating hormones (FSH) and Anti mullerian hormones (AMH) levels were estimated using appropriate assays in biochemistry laboratory.

**Results:** There was statistically significant differences in the serum progesterone receptors, estrogen receptors, progesterone, estradiol, LH, FSH and AMH in POI cases when compared with healthy control ( $P < 0.05$ ).

**Conclusion:** These results indicate that serum progesterone and estrogen receptors levels, is high in POI cases as a result of lack progesterone and estradiol hormones as a result of loss negative feedback inhibition, this result may be used to primary diagnosis of premature ovarian failure.

**Keywords:** Premature ovarian failure (POF), Anti mullerian hormones (AMH), progesterone receptors (PRs), Estrogen receptors (ERs).

## Introduction

Premature ovarian insufficiency (POI) is an early event in the reproductive life span with a significant impact on several dimensions of women's well-being and general health<sup>(1)</sup>. It affects 1% of women under age 40 years, 0.1% of women under age 30 years, and 0.01% of women under 20 years of age<sup>(2)</sup>. POI

prevalence appears to vary by ethnicity, being higher in women from African and Latin American countries<sup>(3)</sup>. Such terminology describes the spectrum of conditions associated with the loss of ovarian function prior to the natural age of menopause. It includes both spontaneous POI and those situations in which POI derives from iatrogenic interventions such as radiation therapy, chemotherapy, or surgery. Women with POI may

display established premature menopause or present with intermittent residual ovarian function<sup>(4)</sup>. The premature hormonal deficiency may be of unknown origin or may be the result of several etiologies, including genetic, autoimmune, metabolic, and infective causes, which lead to ovarian follicular dysfunction or depletion of functional primordial follicles<sup>(5)</sup>. Spontaneous early menopause affects approximately another 5% of women between ages 40 and 45 years<sup>(6)</sup>. Moreover, even though the rate of bilateral oophorectomies routinely performed at the time of hysterectomy is declining, a significantly high number of women still enter menopause earlier due to bilateral oophorectomy performed for treatment of ovarian pathology or for prophylactic purpose in women genetically predisposed to breast and ovarian cancer<sup>(7)</sup>. The percentage of cancer survivors has also increased over time because of improved success in the treatment of cancer in children, adolescents, and reproductive-age women<sup>(8)</sup>. Therefore, early hormonal deprivation occurs in a large number of women and the short-term and long-term consequences are variable, depending mainly on age at onset and type of POI<sup>(9,10)</sup>. Importantly, these consequences may include the burden of infertility and the management of fertility preservation<sup>(11)</sup>. POI is usually diagnosed when two follicle stimulating hormone levels in the menopausal range (>30 U/l), at least 1 month apart in the setting of 4–6 months of amenorrhea, are documented<sup>(12)</sup>. A timely diagnosis and a tailored hormonal treatment at least until the average age at natural menopause occurring around 50 years are mandatory to relieve menopausal symptoms, and to prevent osteoporosis, cardiovascular risks, and neurocognitive disorders<sup>(13)</sup> and the increased risk of overall mortality in women with early experience of menopause<sup>(14)</sup>. On the other hand, POI requires adequate counseling at multiple levels, including psychosocial and sexual consequences, because there is an acceleration of the aging process. Indeed, hormonal replacement is not always entirely able to relieve the multitude of implications for women who have to move forward with their own lives in a POI state<sup>(15)</sup>.

Cytosol estrogen and progesterone receptors are present in many organs including the breasts, endometrium, myometrium, cervix, fallopian tubes and ovaries. The ovaries are not only a source of estrogen and progesterone but they appear to be targets for these hormones<sup>(16,17)</sup>. Estrogen is considered a primary culprit in the development of ovarian cancer as 70% of ovarian cancers express estrogen receptors (ERs),

whereas progesterone and its receptor are protective against ovarian cancer<sup>(18,19)</sup>. In patients with cancers of the breast and endometrium the relationship between tumor estrogen and progesterone receptor (PR) levels and prognosis is well documented. However, the clinical significance of ER and PR content in ovarian carcinomas has not been well established<sup>(16,20)</sup>. Anti-Müllerian hormone (AMH), also known as Müllerian inhibiting substance (MIS) or factor (MIF), has well defined roles in male sex differentiation. Across the female reproductive lifespan the role of AMH has, however, only more recently come to light. AMH is produced by granulosa cells (GCs) in small, growing ovarian follicles, and plays an important role in folliculogenesis. AMH correlates to functional ovarian reserve, and is, therefore, used as a diagnostic and prognostic marker in infertility and in reproductive disorders like polycystic ovary syndrome (PCOS)<sup>(21)</sup>, and primary ovarian insufficiency (POI)<sup>(22)</sup>. Understanding AMH actions may, therefore, provide insights into follicular development under normal as well as pathophysiological conditions.

Recent studies have indicated that follicular growth is regulated by subtle interactions between gonadotropins (FSH and LH) and local factors produced by the theca and granulosa cells<sup>(23)</sup>. FSH receptors are expressed in granulosa cells at the primary follicle stage, and they are required for follicular development into the pre-antral stage<sup>(24)</sup>. FSH activity also increased the primordial pool and enhanced the early follicle stock<sup>(25)</sup>. LH triggers granulosa wall dissociation and cumulus expansion as well as oocyte nuclear maturation<sup>(23)</sup>.

## Materials and Method

**Study population and sample collection:** The Women included in the present study were gathered from those attending Obstetrics and Gynecology Clinic in Kalar General Hospital, Kalar. The study conducted during the period from June 2019 to January 2020 and total of 60 POF women and 30 apparently healthy matched were included in the study. In this study, the eligibility criteria for POF cases included: (1) under 40 years of age at the first time of diagnosis; (2) amenorrhea for at least 4 months; (3) an increased FSH level >25 IU/L on two occasions >4 weeks apart; (4) patients with known causes of POF (such as karyotypic abnormalities, ovarian surgery, and autoimmune diseases etc.) were excluded. The eligibility criteria for the controls included: (1) healthy women with regular menstrual cycles; (2) without hormonal therapy in the last six months; (3)



without endocrine system diseases, such as polycystic ovary syndrome, thyroid, and hyperprolactinemia etc. Peripheral blood of patients was collected at the time of interview with a structured questionnaire. Venous blood of patient women was collected so that the control. The blood was centrifuged immediately at 3000 r/min for 10 min, and the serum was collected in a polypropylene tube. The samples were stored at 80 C for further chemical analysis and hormone measurement.

**Biochemical analysis:** The serum progesterone receptors (PRs), estrogen receptors (ERs), Lutealizing hormones (LH), Follicle stimulating hormones (FSH) and Anti mullerian hormones (AMH) progesterone (PRG), estradiol (E2), levels were measured by an automated Roche Modular Analytics E411 immunoassay system (Roche Diagnostics, Mannheim, Germany). Inter and intra-assay coefficient of variations (CVs) for all the tested hormones was less than 10%.

**Statistical analysis:** The obtained data were analyzed using IBM SPSS statistical package (version 20). Student's t test was applied to calculate significance of differences between patients and controls groups.

## Results

**Determination the serum progesterone and estrogen receptors:** The results of the present study showed significant elevation ( $P < 0.05$ ) in the mean serum level of progesterone receptor in women with POI ( $4.14 \pm 0.42$  ng/ml), when compared to control group ( $2.44 \pm 0.33$  ng/ml). The serum level of estradiol receptor demonstrated significant elevation in POI cases ( $4969.92 \pm 271.51$  pg/ml), when compared to control group ( $551.17 \pm 59.91$  pg/ml), Table (1).

**Table (1): Serum progesterone and estrogen receptors in patient cases and controls**

Parameter	Patient			Control			P
	Mean±Se	Max	Min	Mean±Se	Max	Min	
PRs ng/ml	4.14±0.42	13.27	0.11	2.44±0.33	8.32	0.15	0.001
ERs pg/ml	4969.92±271.51	8000	360	551.17±59.9	1198	50	0.003

**Determination the serum LH, FSH and AMH:** The LH and FSH mean serum levels were significantly ( $P < 0.05$ ) higher in women with POI, ( $43.36 \pm 3.01$ ,  $62.15 \pm 3.98$  mIU/ml) as compared to controls ( $6.06 \pm 0.40$ ,

$6.00 \pm 0.31$  mIU/ml,) respectively. However, AMH mean serum level ( $0.16 \pm 0.03$  ng/ml) was significantly ( $P < 0.05$ ) lower in women with POI than that in controls ( $2.72 \pm 0.16$ ), Table (2).

**Table (2): Serum LH,FSH and AMH in patient cases and controls**

Parameter	Patient			Control			P
	Mean±Se	Max	Min	Mean±Se	Max	Min	
LH mIU/ml	43.36 ±3.01	100.87	10.23	6.06±0.40	9.79	3.12	S
FSH mIU/ml	62.15±3.98	181.32	22.28	6.00±0.31	11.15	2.97	S
AMH ng/ml	0.16±0.03	0.91	0.01	2.72±0.16	4.55	1.29	S

**Determination the serum progesterone and estradiol:** Both Estradiol and progesterone mean serum values were significantly ( $P < 0.05$ ) lower in women with

POI ( $8.75 \pm 0.75$  pg/ml,  $0.23 \pm 0.03$  ng/ml) than in controls ( $56.06 \pm 4.11$  pg/ml,  $0.60 \pm 0.04$  ng/ml) respectively, Table (3).

**Table (3): Serum progesterone and estradiolin patient cases & cotrole**

Parameter	Patient			Control			P
	Mean±Se	Max	Min	Mean±Se	Max	Min	
Estrogen pg\ml	8.75±0.75	19.99	0.32	56.06±4.11	102.11	22.36	0.002
Pregesterone ng/ml	0.23±0.03	0.95	0.01	0.60±0.04	0.99	0.24	0.003

### Discussion

In the present study the mean serum level of progesterone (PR) and estradiol receptor (ER) was significantly higher in women with POI as compared to controls. This result was conflicting with the result of Kalpokas, Irene, et al<sup>(26)</sup>. The high levels of progesterone (PR) and estradiol receptors (ER) may be attributed to low serum levels of progesterone and estradiol which were as a result of ovarian dysfunction to produce this hormones. Additionally, the present study indicated a higher significant serum levels of FSH and LH in women with POI than in normal controls. Thus high serum levels of FSH and LH in clinical settings must take in consideration POI as the underlying aetiology. Reduced serum level of AMH in women added another tool for the diagnosis of POI. The result of present study was in agreement with the finding reported by YE, Xiaoqing, et al<sup>(27)</sup>. The high levels of LH and FSH may be as a result of loss the negative feedback inhibition that induced by progesterone and estradiol hormones.

The mean value of serum progesterone showed lower significant difference in POI cases when compared with healthy control. The present was in agreement with that reported by Czyzyk, Adam, et al<sup>(28)</sup> and Bernardi, F., et al.<sup>(29)</sup>. The low serum levels of progesterone and estradiol may be attributed to failure of the ovary to produce them.

### Conclusions

Women with POI patient demonstrated significantly high mean serum levels of progesterone and estrogen receptors than healthy control, suggesting possibility of their use as biomarkers for the diagnosis of POI.

**Conflict of Interest:** Nil

**Source of Funding:** Self, from Kalar Health Authority.

**Ethical Clearance:** The study design approved by the Ethical Committee of Tikrit University College of

Medicine and informed consent was taken from each participant before enrollment in the study

### Reference

1. Maclaran, Kate; Panay, Nick. Current Concepts In Premature Ovarian Insufficiency. *Women's Health*, 2015, 11.2: 169-182.
2. Coulam, Carolyn B.; Adamson, Steven C.; Annegers, John F. Incidence of Premature Ovarian Failure. *Obstetrics & Gynecology*, 1986, 67.4: 604-606.
3. Luborsky JI, Meyer P, Sowers Mf, Et Al. Premature Menopause In A Multi-Ethnic Population Study of the Menopause Transition. *Hum Reprod* 2003;18:199–206
4. Nelson Lm. Clinical Practice. Primary Ovarian Insufficiency. *N Engl J Med* 2009;360:606–14
5. Cox, Leticia; Liu, James H. Primary Ovarian Insufficiency: An Update. *International Journal of Women's Health*, 2014, 6: 235.
6. Santoro N. Mechanisms of Premature Ovarian Failure. *Ann Endocrinol (Paris)* 2003;64:87–92
7. Sarrel Pm, Sullivan Sd, Nelson Lm. Hormone Replacement Therapy In Young Women With Surgical Primary Ovarian Insufficiency. *FertilSteril* 2016;106:1580–7.
8. De Vos M, Devroey P, FauserBc. Primary Ovarian Insufficiency. *Lancet* 2010;376:911–21.
9. Allshouse, Amanda A.; Semple, Amy L.; Santoro, Nanette F. Evidence For Prolonged And Unique Amenorrhea-Related Symptoms In Women With Premature Ovarian Failure/Primary Ovarian Insufficiency. *Menopause*, 2015, 22.2: 166-174.
10. Faubion, Stephanie S., Et Al. Long-Term Health Consequences of Premature Or Early Menopause And Considerations For Management. *Climacteric*, 2015, 18.4: 483-491.
11. Ben-Nagi, J.; Panay, N. Premature Ovarian Insufficiency: How To Improve Reproductive

- Outcome?. *Climacteric*, 2014, 17.3: 242-246.
12. Panay, Nick; Kalu, Emmanuel. Management of Premature Ovarian Failure. *Best Practice & Research Clinical Obstetrics & Gynaecology*, 2009, 23.1: 129-140.
  13. Sullivan, Shannon D.; Sarrel, Philip M.; Nelson, Lawrence M. Hormone Replacement Therapy In Young Women With Primary Ovarian Insufficiency And Early Menopause. *Fertility And Sterility*, 2016, 106.7: 1588-1599.
  14. Muka, Taulant, Et Al. Association of Age At Onset of Menopause And Time Since Onset of Menopause With Cardiovascular Outcomes, Intermediate Vascular Traits, And All-Cause Mortality: A Systematic Review And Meta-Analysis. *Jama Cardiology*, 2016, 1.7: 767-776.
  15. Graziottin, Alessandra. Menopause And Sexuality: Key Issues In Premature Menopause And Beyond. *Annals of the New York Academy of Sciences*, 2010, 1205.1: 254-261.
  16. Masood, Shahla, Et Al. Clinical Correlation of Hormone Receptor Status In Epithelial Ovarian Cancer. *Gynecologic Oncology*, 1989, 34.1: 57-60.
  17. Jones, L. A., Et Al. Estrogen And Progesterone Receptor Titters In Primary Epithelial Ovarian Carcinomas. *International Journal of Cancer*, 1983, 32.5: 567-571.
  18. Lee, Peng, Et Al. Expression of Progesterone Receptor Is A Favorable Prognostic Marker In Ovarian Cancer. *Gynecologic Oncology*, 2005, 96.3: 671-677.
  19. Hall, Julie M.; Korach, Kenneth S. Stromal Cell-Derived Factor 1, A Novel Target of Estrogen Receptor Action, Mediates The Mitogenic Effects of Estradiol In Ovarian And Breast Cancer Cells. *Molecular Endocrinology*, 2003, 17.5: 792-803.
  20. Du, Fengkun, Et Al. Highly And Moderately Aggressive Mouse Ovarian Cancer Cell Lines Exhibit Differential Gene Expression. *Tumor Biology*, 2016, 37.8: 11147-11162.
  21. Fallat, Mary E., Et Al. Müllerian-Inhibiting Substance In Follicular Fluid And Serum: A Comparison of Patients With Tubal Factor Infertility, Polycystic Ovary Syndrome, And Endometriosis. *Fertility And Sterility*, 1997, 67.5: 962-965.
  22. Visser, Jenny A.; Themmen, Axel Pn. Role of Anti-Müllerian Hormone And Bone Morphogenetic Proteins In The Regulation of FshSensitivity. *Molecular And Cellular Endocrinology*, 2014, 382.1: 460-465.
  23. Gougeon, Alain. Human Ovarian Follicular Development: From Activation of Resting Follicles To Preovulatory Maturation. In: *Annales D'endocrinologie*. Elsevier Masson, 2010. P. 132-143.
  24. Oktay, Kutluk; Briggs, David; Gosden, Roger G. Ontogeny of Follicle-Stimulating Hormone Receptor Gene Expression In Isolated Human Ovarian Follicles. *The Journal of Clinical Endocrinology & Metabolism*, 1997, 82.11: 3748-3751.
  25. Allan, Charles M., Et Al. Follicle-Stimulating Hormone Increases Primordial Follicle Reserve In Mature Female Hypogonadal Mice. *Journal of Endocrinology*, 2006, 188.3: 549-557.
  26. Kalpokas, Irene, Et Al. Effect of Side of the Corpus Luteum And Pregnancy On Estrogen And Progesterone Receptor Expression And Localization In The Endometrium of Mares. *Theriogenology*, 2018, 114: 221-228.
  27. Ye, Xiaoqing, Et Al. Exposure To Polycyclic Aromatic Hydrocarbons And Risk For Premature Ovarian Failure And Reproductive Hormones Imbalance. *Journal of Environmental Sciences*, 2020, 91: 1-9.
  28. Czyzyk, Adam, Et Al. Brain-Derived Neurotrophic Factor (Bdnf) Plasma Concentration In Patients Diagnosed With Premature Ovarian Insufficiency (Poi). *Gynecological Endocrinology*, 2017, 33.5: 413.
  29. Bemardi, F., Et Al. High Levels of Serum Allopregnanolone In Women With Premature Ovarian Failure. *Gynecological Endocrinology*, 1998, 12.5: 339-345.

# The Predictive Value of Osteocalcin, Granulin, Cathepsin K and Some Other Biomarkers in Women with Premature Ovarian Failure

Mahmood Khalil Ibraheem<sup>1</sup>, Mutazsabahaahmied<sup>2</sup>, Firas Shawqi Algburi<sup>3</sup>, Amina Hamed Alobaidi<sup>4</sup>

<sup>1</sup>Clinical Biochemistry Specialist, Tikrit University College of Medicine, Tikrit Iraq, <sup>2</sup>Assistant Professor, Tikrit University College of Medicine, Tikrit Iraq, <sup>3</sup>Assistant Professor, Tikrit University College of Science, Tikrit Iraq, <sup>4</sup>Assistant Professor, Kirkuk University College of Veterinary Medicine, Kirkuk

## Abstract

**Background:** Premature ovarian failure (POF), often and misleadingly referred to as ‘premature menopause’, is defined as a loss of ovarian activity before the age of 40 years and is characterized by irregular or absent periods and reduced fertility. Symptoms include those associated with the natural menopause (night sweats and vaginal dryness), and with the long-term adverse effects of estrogen deficiency (osteoporosis and cardiovascular disease): the latter is believed to explain the shorter life expectancy associated with POF.

**Aim:** To determine the predictive value of serum osteocalcin(OC), granulin(GRN), cathepsin k (CTK), vitamin D, parathyroid hormones (PTH), calcium and phosphorus as biomarkers for POF.

**Method:** Sixty (60) women with idiopathic POF with thirty (30) women as control groups were included in the study. Baseline investigation in all subjects included serum Osteocalcin(OC), granulin(GRN), cathepsin k (CTK), vitamin D, parathyroid hormones (PTH), calcium and phosphorus levels were estimated using the appropriate assays for each.

**Results:** The mean serum levels of Osteocalcin, Granulin, Parathyroid hormones, vitamin D and phosphorus, were significantly higher in women with POF, when compared to healthy controls ( $P < 0.05$ ). However, mean serum levels of cathepsin k and calcium in POF group were non significant differences, when compared to healthy controls.

**Conclusion:** Osteocalcin and granulin serum levels may be used as new biomarker for the diagnosis of premature ovarian failure.

**Keywords:** *Premature ovarian failure, Vitamin D, parathyroid hormones. Osteocalcin, Granulin, Cathepsin k.*

## Introduction

Premature Ovarian Insufficiency (POI) can be spontaneous or iatrogenic and is defined as loss of ovarian function with development of hypergonadotropic hypogonadism in women under the age of 40 years<sup>(1)</sup>. Spontaneous POI affects approximately 1% of women and is associated with genetic defects, autoimmune disorders, environmental factors and infections, but is most commonly idiopathic<sup>(2,3)</sup>. Iatrogenic POI can occur secondary to surgical intervention (E.g. bilateral oophorectomy), chemotherapy and/or radiotherapy<sup>(2,4)</sup>. The effects of oestrogen deficiency include menopausal

symptoms such as: vasomotor symptoms, insomnia, mood lability, and vulvo-vaginal atrophy. Longer-term consequences of POI include an increased risk of cardiovascular disease and mortality, accelerated cognitive impairment, infertility and osteoporosis<sup>(2,4-6)</sup>.

Osteocalcin(OC), a bone-specific protein synthesized by the osteoblasts in bone, is the major non-collagen protein in the bone matrix. It has a molecular weight of 5,800 Da and contains 49 amino acids, including 3 gamma carboxyl glutamic acid residues that facilitate the binding of OC to hydroxyapatite in bone. The serum OC level, a sensitive marker of bone production, is associated

with a high bone turnover rate and decreased BMD, and correlates well with histomorphometric indices of bone formation<sup>(7)</sup>. Granulins are a large family of disulfide-rich proteins with diverse biological functions including wound healing, cell growth and proliferation modulation, and angiogenesis<sup>(8)</sup>. Cathepsin K is a papain-like cysteine protease member of the cathepsin family of lysosomal proteases, a family categorized as consisting of cysteine (cathepsins B, C, F, H, K, L, O, S, V, X, and W), aspartate (cathepsins D and E), or serine (cathepsins A and G) proteases depending on the active site amino acid which mediates each member's catalytic activity<sup>(9)</sup>. An important aspect of cathepsin biology is based on their cellular localization. While cathepsins have greatest activity in acidic environments such as occurs along the endosomal lysosomal continuum, cysteine cathepsins secretion into the extracellular space has also been shown to occur under normal physiologic conditions including skeletal remodeling, wound repair, and prohormone processing<sup>(10)</sup>.

Vitamin D is synthesized from 7-dehydrocholesterol in the skin via UV-B radiation from the sun. This is an inactive form of vitamin D and requires two enzymatic hydroxylation reactions before activation. These are 25-hydroxylation and 1- $\alpha$ -hydroxylation<sup>(11)</sup>. While the first reaction takes place mainly in the liver with 25-hydroxylase, the second one occurs primarily in the kidneys with 1- $\alpha$ -hydroxylase (1,25-dihydroxyvitamin D [1,25(OH)<sub>2</sub>D<sub>3</sub>]). This form of vitamin D has a high affinity for binding to vitamin D receptors in target tissue<sup>(12)</sup>. Renal 1- $\alpha$ -hydroxylase enzyme works under the control of sex hormones and endocrine factors<sup>(13)</sup>. Vitamin D is a major regulator of calcium phosphorus homeostasis and bone health. Recently, a number of non classical target organs including reproductive ones have been defined for vitamin D. This compilation study explores the potential effects of vitamin D on female reproductive functions. Vitamin D receptors are present in various tissue such as the immune system, endocrine system, and reproductive system<sup>(13)</sup>. Vitamin D receptors are present in both the cytoplasm or nucleus of granulosa cells in ovaries<sup>(14)</sup>. The presence of vitamin D receptors in female reproductive tissue suggests that vitamin D may have a role in female reproductive functions.

### Patient and Method

**Study population and sample collection:** The Women included in the present study were gathered from those attending Obstetrics and Gynecology Clinic

in Kalar General Hospital, Kalar. The study conducted during the period from June 2019 to January 2020 and total of 60 POF women and 30 apparently healthy matched were included in the study. In this study, the eligibility criteria for POF cases included: (1) under 40 years of age at the first time of diagnosis; (2) amenorrhea for at least 4 months; (3) an increased FSH level >25 IU/L on two occasions >4 weeks apart; (4) patients with known causes of POF (such as karyotypic abnormalities, ovarian surgery, and autoimmune diseases etc.) were excluded. The eligibility criteria for the controls included: (1) healthy women with regular menstrual cycles; (2) without hormonal therapy in the last six months; (3) without endocrine system diseases, such as polycystic ovary syndrome, thyroid, and hyperprolactinemia etc. Peripheral blood of patients was collected at the time of interview with a structured questionnaire. Venous blood of patient women was collected so that the control. The blood was centrifuged immediately at 3000 r/min for 10 min, and the serum was collected in a polypropylene tube. The samples were stored at 80 C for further chemical analysis and hormone measurement.

**Biochemical analysis:** The serum osteocalcin, granulins, cathepsin k, vitamin D and PTH levels were measured by an automated Roche Modular Analytics E411 immunoassay system (Roche Diagnostics, Mannheim, Germany). Inter and intra-assay coefficient of variations (CVs) for all the tested hormones was less than 10%. Total calcium and phosphorus were determined by Roche Cobas C111 Automatic Biochem Station (Roche Diagnostics, Germany).

**Statistical analysis:** The obtained data were analyzed using IBM SPSS statistical package (version 20). Student's t test was applied to calculate significance of differences between patients and controls groups.

### Results

**Determination the serum osteocalcin, granulins and cathepsin k:** Mean serum level of osteocalcin in patient (47.35 $\pm$  5.35 ng/ml) was significantly elevated (P=0.001) as compared with the concentration in the normal controls (17.21 $\pm$  3.07 ng/ml). However, the mean serum level of Cathepsin K in patient group (0.27 $\pm$  0.05 ng/ml) was not significantly (P=0.69) differ from that in control group (0.24 $\pm$  0.07 ng/ml). While, a significant elevation (P=0.002) in the mean serum level of Granulins in patients (7.87 $\pm$  0.53 ng/ml) than in controls (5.44 $\pm$  0.56 ng/ml), Table (1).

**Table (1): Serum Biochemical hormones in patient cases & control**

Parameter	Patient			Control			P
	Mean±Se	Min	Max	Mean±Se	Min	Max	
Osteocalcin ng/ml	47.35± 5.35	0.54	130.98	17.21± 3.07	0.54	60.21	00.001
Cathepsin K ng/ml	0.27± 0.05	0.01	1.61	0.24± 0.07	0.02	2.16	0.691
Granulin ng/ml	7.87± 0.53	2.55	20.00	5.44± 0.56	1.80	16.25	0.002

**Determination the serum PTH, vitamin D, calcium and phosphorus:** The Mean serum levels of parathyroid hormones and vitamin D were significantly lower ( $P < 0.01$ ) in patient ( $35.42 \pm 1.34, 12.43 \pm 0.90$  ng/ml), when compared with controls ( $46.53 \pm 1.77, 20.88 \pm 1.99$  ng/ml) respectively. While the mean serum

level of calcium showed a nonsignificant ( $P > 0.05$ ) in patient cases ( $9.63 \pm 0.07$ ), when compared with control group ( $9.85 \pm 0.09$ ), while the serum level of phosphorus demonstrated significant elevation ( $P = 0.001$ ), in patient cases ( $1.47 \pm 0.02$ ), when compared with control group ( $1.34 \pm 0.02$ ), Table (2).

**Table (2) : Serum bone hormones and maniralin patient cases & controle**

Parameter	Patient			Control			P
	Mean±Se	Max	Min	Mean±Se	Max	Min	
PTH ng/ml	35.42±1.34	56.98	15.16	46.53±1.77	62.43	28.69	0.001
Vitamin D ng/ml	12.43±0.90	33.12	3.08	20.88±1.99	41.21	5.36	0.003
Calcium mg/dl	9.63±0.07	10.98	8.22	9.85±0.09	10.73	8.81	0.06
Phosphurse mmol/l	1.47±0.02	1.74	1.22	1.34±0.02	1.53	1.16	0.001

## Discussion

In the present study, the mean serum osteocalcin level showed a statistically significant increase in women with POI when compared with apparently healthy control. This finding agreed the study of Singh, Sudhir; etal<sup>(15)</sup>. Additionally, the mean serum granulin level in POI cases was significantly increased in women with POF. This result in disagreement with that reported by Kan, Ozgur;etal<sup>(16)</sup>. While the mean serum value of cathepsin k did not shows a significant difference between patients and controls group.

Womens with POF show significant mean serum level of parathyroid hormones than in controls. In addition, VitD deficiency to be significantly more prevalent among POI patients than in controls. as well as the levels of phosphorus showing significantly highermean serum value in women with POI than in controls group. However, calcium mean serum level was not significantly different in women with POI as compared to controls group. This result in contrast with that reported by Ersoy, Ebru, et al<sup>(17)</sup>as they found no significant difference between Caucasian women POI

(n=48) as compared to Caucasian women as controls group.

The present study shows no significant difference in the mean serum levels of vitD, PTH, phosphorus and calcium in women with POI as compared with controls. However, Kurabayashi, etal<sup>(18)</sup>, reported a significant difference in serum PTH levels and non significant in the levels of serum calcium and phosphorus. Their finding was in agreement with the levels of PTH and conflicting with the levels of calcium and phosphorus when compared to controls group.

## Conclusions

Women with POI demonstrated significantly higher serum osteocalcin and granulin level than healthy control, suggesting their use as biomarker for the diagnosis premature ovarian insufficiency .

**Conflict of Interest:** Nil

**Source of Funding:** Self, from Kalar Health Authority.

**Ethical Clearance:** The study design approved by the Ethical Committee of Tikrit University College of Medicine and informed consent was taken from each participant before enrollment in the study

### Reference

1. Eshre Guideline Group On Poi, Et Al. Eshre Guideline: Management of Women With Premature Ovarian Insufficiency. *Human Reproduction*, 2016, 31.5: 926-937.
2. Nguyen, Hanh H., Et Al. Premature Ovarian Insufficiency In General Practice: Meeting The Needs of Women. *Australian Family Physician*, 2017, 46.6: 360.
3. Coulam, Carolyn B.; Adamson, Steven C.; Annegers, John F. Incidence of Premature Ovarian Failure. *Obstetrics & Gynecology*, 1986, 67.4: 604-606.
4. De Vos, Michel; Devroey, Paul; Fauser, Bart Cjm. Primary Ovarian Insufficiency. *The Lancet*, 2010, 376.9744: 911-921.
5. Pines, Amos, Et Al. Postmenopausal Status And Early Menopause As Independent Risk Factors For Cardiovascular Disease: A Meta-Analysis. *Climacteric*, 2013, 16.5: 601-608.
6. Kalantaridou, Sophia N., Et Al. Impaired Endothelial Function In Young Women With Premature Ovarian Failure: Normalization With Hormone Therapy. *The Journal of Clinical Endocrinology & Metabolism*, 2004, 89.8: 3907-3913.
7. Hlaing, Thinn Thinn; Compston, Juliet E. Biochemical Markers of Bone Turnover—Uses And Limitations. *Annals of Clinical Biochemistry*, 2014, 51.2: 189-202.
8. Haugen, Brandon, Et Al. Granulin Secreted By The Food-Borne Liver Fluke *Opisthorchis Viverrini* Promotes Angiogenesis In Human Endothelial Cells. *Frontiers In Medicine*, 2018, 5: 30.
9. Fonović, Marko; Turk, Boris. Cysteine Cathepsins And Extracellular Matrix Degradation. *Biochimica Et Biophysica Acta (Bba)-General Subjects*, 2014, 1840.8: 2560-2570.
10. Brix, Klaudia, Et Al. Cysteine Cathepsins: Cellular Roadmap To Different Functions. *Biochimie*, 2008, 90.2: 194-207.
11. Nandi, Anindita, Et Al. Is There A Role For Vitamin D In Human Reproduction?. *Hormone Molecular Biology And Clinical Investigation*, 2016, 25.1: 15-28.
12. Boisen, Ida Marie, Et Al. Possible Influence of Vitamin D On Male Reproduction. *The Journal of Steroid Biochemistry And Molecular Biology*, 2017, 173: 215-222.
13. Jensen, Martin Blomberg. Vitamin D And Male Reproduction. *Nature Reviews Endocrinology*, 2014, 10.3: 175.
14. Thill, Marc, Et Al. Expression of Prostaglandin Metabolising Enzymes Cox-2 And 15-Pgdh And Vdr In Human Granulosa Cells. *Anticancer Research*, 2009, 29.9: 3611-3618.
15. Schatz, Marc, Et Al. Osteocalcin, Ovarian Senescence, And Brain Health. *Frontiers In Neuroendocrinology*, 2020, 100861.
16. Kan, Ozgur; Gorkem, Umit. The Effects of Serum Granulin Levels On Anthropometric Measures And Glucose Metabolism In Infertile Women With Different Ovarian Reserve Status. *Endokrynologia Polska*, 2019, 70.3: 255-259.
17. Ersoy, Ebru, Et Al. Vitamin D Levels In Patients With Premature Ovarian Failure. *Ginekologia Polska*, 2016, 87.1: 32-36.
18. Kurabayashi, T., Et Al. Effect of Hormone Replacement Therapy On Spinal Bone Mineral Density And T Lymphocyte Subsets In Premature Ovarian Failure And Turner's Syndrome. *International Journal of Gynecology & Obstetrics*, 1993, 42.1: 25-31.

# Relation of Human Papilloma Virus Infection with Pre Malignant and Malignant Endometrial Lesions

Mahmoud Mohammed Mahmoud<sup>1</sup>, Aseel Ghazi Rifat<sup>2</sup>

<sup>1</sup>Assistant Professor in the Department of Pathology, College of Medicine, University of Kirkuk, Kirkuk, Iraq,

<sup>2</sup>Assistant Professor in the Department of Gynecology & Obstetrics, College of Medicine, University of Kirkuk, Kirkuk, Iraq

## Abstract

Endometrial carcinoma is the second most common gynecologic cancer worldwide. Hyperplasia is a precursor to endometrioid adenocarcinoma. There are few studies on the association of HPV with endometrial adenocarcinoma.

**Aim of the Study:** To determine the relation of HPV with premalignant and malignant endometrial lesions.

**Patients and Method:** This study achieved on a total number of 90 patients with histopathological examination revealing endometrial hyperplasia in 30 patient, endometrial carcinoma in 30 patient in addition to 30 cases who underwent hysterectomy, for all patients detection of HR-HPV done by RT-PCR.

**Results:** The HR-HPV positivity was recorded in 23 patients. For the studied cases with endometrial carcinoma, endometrial hyperplasia and controls the positivity rates were about (16.7%), (36.7%) and (23.3%) respectively. Highest rate of HR-HPV positivity for the studied patients was found in the age group (45-49). Highest rate of HR-HPV positivity in cases with endometrial carcinoma was reported in older age groups [(45-49) and (50-54)], compared to endometrial hyperplasia and controls [(40-44) and (45-49)]. The HR-HPV positivity was most frequently observed in cases with well-differentiated (22.2%). Higher HR-HPV positivity rate was reported in the hyperplasia without atypia.

**Conclusion:** No role of HR-HPV in the pathogenesis of endometrial carcinoma.

**Keywords:** HPV, endometrial carcinoma, hyperplasia.

## Introduction

Endometrial carcinoma is the most common gynecologic cancer in high-income countries and the second most common gynecologic cancer worldwide when both high and low-income countries are considered<sup>(1)</sup>. In Iraq although it is not within the top

ten cancers and it account for 0.56% of total malignant tumor<sup>(2)</sup>. Endometrial cancer is often detectable in the early stages due to the nature of the disease with the 5-year survival rate of 85-91%. About 73% of patients with endometrial cancer are diagnosed in stage I. It is, therefore, very important to identify risk factors followed by primary diagnostic interventions to modify the factors effective on cancer<sup>(3-8)</sup>. Human papilloma virus is one of the most obvious risk factors for cancer<sup>(9)</sup>. Since its recognition as the cause of cervical cancer, this infectious agent has been the focus of intensive researches<sup>(10)</sup>. Human papilloma virus is the most common sexually transmitted infection worldwide. It is also the causative agent for 1/3 of all the viral induced tumors and responsible for (5%) of human cancers<sup>(11)</sup>. Human papilloma virus is subdivided into two major

---

### Corresponding Author:

**Mahmoud Mohammed Mahmoud**

Assistant Professor in the Department of Pathology,  
College of Medicine, University of Kirkuk, Kirkuk,  
Iraq

e-mail: mahmoud\_mm1973@yahoo.com

Telephone No.: +9647701306008



subgroups, namely the low-risk HPVs which are mainly associated with development of warts and benign lesions and high-risk HPVs (e.g 16, 18, 31, 33, 45, 51, 52, 56, 58, 59, 68, 73 & 82) which are considered the main drivers of high-grade lesions and cancers<sup>(12,13,14)</sup>.

## Material and Method

This case-controlled observational study achieved during the period from January 2018 to January 2020 through which a total number of 90 patients were recruited between 30-71 years of age, who were admitted to the department of Gynecology and Obstetrics in Azadi teaching hospital and private hospitals in Kirkuk city for whom hystrectomy was done for various indications after full clinical assessment with histopathological examination of the hystrectomy specimens and were divided into three groups according to the results of the histopathology consisting of 30 patients with endometrial hyperplasia, 30 patients with endometrial carcinoma in addition to 30 cases with normal endometrium who underwent hystrectomy for catastrophic obstetric emergencies or for other benign conditions related to tubes, ovaries and uterine corpus like uterine prolapse and leiomyomas as a control group. For all the cases a full history was taken, general and pelvic examination was done, Pap smear was performed in addition to the routine laboratory investigations prior to surgery. Patients with previous history of malignant disease involving the genital tract or history of vulvar, vaginal or cervical HPV related lesions, intraepithelial neoplasia and carcinoma or abnormal pap smear results were excluded from the study.

Tissue sections were obtained from these patients biopsy specimens following hystrectomy in the histopathology laboratories. The histopathological types

of endometrial carcinoma and endometrial hyperplasia were classified according to WHO classification<sup>(17)</sup> and the endometrial carcinoma was staged according to FIGO staging system. For the three groups of endometrial carcinoma, hyperplasia and controls the detection of 12 types of HR-HPV DNA (types 16, 18, 31, 33, 35, 39, 45, 51, 52, 56, 58 & 59) using real time polymerase chain reaction in molecular laboratory was done. The variables were analyzed using stratified chi-square and Fisher's exact tests. A statistical test considered significant when the p-value was  $\leq 0.05$ .

**Findings:** The clinico-pathological data of the studied cases are summarized in table (1). The studied patients were categorized into nine groups according to the age. The mean age of participants was (53.96) years and the median was (56) years. There was no patient younger than 30 years or older than 71 years.

Most of endometrial carcinomas were in the age groups (65-69) years of age (9 cases), with absence of any cases in the age groups below 39 years while the endometrial hyperplasia cases were mostly distributed between the age groups (40-44), (45-49), (50-54) & (55-59) years.

All of endometrial carcinoma were of endometrioid type either well, moderately or poorly differentiated type. The well-differentiated endometrial carcinoma were presented in (60%) of cases, while moderate & poorly differentiated tumors were present in (33.3%) and (6.7%) of patients with carcinoma respectively, no any squamous differentiation was denoted in this study.

Of the 30 cases of endometrial hyperplasia, 18 (60%) of cases were hyperplasia without atypia while 12 (40%) of cases were atypical hyperplasia/endometrioid intraepithelial neoplasia as shown in (table 1).

**Table 1: Endometrial histology pattern according to the age groups.**

Endometrial histology		30-34	35-39	40-44	45-49	50-54	55-59	60-64	65-69	70+	Total
Endometrial carcinoma	Well-differentiated	0	0	1	2	2	4	4	4	1	18(60%)
	Moderately-differentiated	0	0	0	0	0	2	3	4	1	10(33.3%)
	Poorly-differentiated	0	0	0	0	0	0	0	1	1	2(6.7%)
Endometrial hyperplasia	Hyperplasia without atypia	2	3	5	4	2	2	0	0	0	18(60%)
	Atypical hyperplasia/ endometrioid intraepithelial neoplasia	0	0	1	1	3	4	2	1	0	12(40%)
Control cases		3	3	5	6	5	3	3	2	0	30(100%)
<b>Total</b>		<b>5</b>	<b>6</b>	<b>12</b>	<b>13</b>	<b>12</b>	<b>15</b>	<b>12</b>	<b>12</b>	<b>3</b>	<b>90</b>

Overall HR-HPV positivity was recorded in 25.6% (in 23 cases) of the patients included in the study. For the studied cases with endometrial carcinoma, endometrial hyperplasia and controls the positivity rates were about (16.7%), (36.7%) and (23.3%) respectively. Although

the HR-HPV positivity appear higher in endometrial hyperplasia group but the analysis did not identify any statistically significant difference between the three groups as shown in table (2).

**Table 2: Frequency distribution of HR-HPV in studied groups.**

Studied Groups	HR-HPV (+) No. (%)	HR-HPV (-) No (%)	Total	X <sup>2</sup>	P-value
Endometrial carcinoma	5 (16.7)	25 (83.3)	30	3.2706	0.194894
Endometrial hyperplasia	11 (36.7)	19 (63.3)	30		
Control	7 (23.3)	23 (76.7)	30		
<b>Total</b>	<b>23 (25.6)</b>	<b>67 (74.7)</b>	<b>90</b>		

Table (3) shows the distribution of HR-HPV positive cases in the three groups of endometrial carcinoma, hyperplasia and controls according to the age groups. Overall the highest rate of HR-HPV positivity for the studied patients was found in the age group (45-49). In cases with endometrial carcinoma higher rate of HR-

HPV positivity was reported in older age groups[(45-49) and (50-54)], compared to endometrial hyperplasia and controls[(40-44) and (45-49)], however this difference in the distribution of HR-HPV positivity according to age groups in the three studied groups was statistically insignificant.

**Table 3: Distribution of positive HR-HPV cases in different age groups .**

Age groups	Endometrial carcinoma No. (%)	Endometrial hyperplasia No. (%)	Control group No. (%)	Total No (%)	P-Value*
30-34	0 (0)	1 (9.1)	1 (14.3)	2 (8.7)	0.994
35-39	0 (0)	2 (18.2)	1 (14.3)	3 (13)	
40-44	1 (20)	3 (27.3)	2 (28.6)	6 (26)	
45-49	2 (40)	3 (27.3)	2 (28.6)	7 (30.4)	
50-54	2 (40)	1 (9.1)	1 (14.3)	4 (17.4)	
55-59	0 (0)	1 (9.1)	0 (0.0)	1 (4.3)	
60-64	0 (0)	0 (0)	0 (0.0)	0 (0.0)	
65-69	0 (0)	0 (0)	0 (0.0)	0 (0.0)	
70+	0 (0)	0 (0)	0 (0.0)	0 (0.0)	
<b>Total</b>	<b>5 (100)</b>	<b>11</b>	<b>7</b>	<b>23</b>	

\*Fisher-exact test. Regarding the association of HR-HPV positivity with the grade (differentiation) of endometrial carcinoma, the HR-HPV positivity was most frequently observed in cases with well-differentiated

(22.2%) compared to moderate and poorly-differentiated tumors, however this difference was statistically not significant as shown in table (4).

**Table 4: Frequency distribution of HR-HPV positivity in different grades of endometrial carcinoma.**

	Grade of differentiation	HR-HPV (+) No. (%)	HR-HPV (-) No (%)	Total No. (%)	X <sup>2</sup>	p-value
Endometrial carcinoma	Well-differentiated	4 (22.2%)	14(77.8%)	18 (100)	0.6547	0.418442
	Moderately-differentiated	1 (10%)	9(90)	10 (100)		
	Poorly-differentiated	0 (0.0%)	2(100%)	2 (100)		
<b>Total</b>		<b>5 (16.7)</b>	<b>25 (83.3)</b>	<b>30 (100)</b>		

In the current study 25 patients with endometrial carcinoma were of stage I and 5 patients were of stage II cancer and no cases with stage III and IV carcinoma were reported. In addition our data analysis did not observe any statistically significant differences between HR-HPV positivity and tumor staging as shown in table (5).

**Table 5: Frequency distribution of HR-HPV in different stages of endometrial carcinoma.**

	Stage (FIGO)	HR-HPV (+) No. (%)	HR-HPV (-) No (%)	Total No. (%)	X <sup>2</sup>	p-value
Endometrial carcinoma	I	4 (16)	21 (84)	25 (83.3)	0.048	0.82658
	II	1 (20)	4 (80)	5 (16.7)		
	III	0 (0.0)	0 (0.0)	0 (0.0)		
	IV	0 (0.0)	0 (0.0)	0 (0.0)		
<b>Total</b>		<b>5 (16.7)</b>	<b>25 (83.3)</b>	<b>30 (100)</b>		

In the correlation of HR-HPV positivity with the type of endometrial hyperplasia, higher HR-HPV positivity rate was reported in the hyperplasia without atypia compared to cases with atypical hyperplasia/endometrioid intraepithelial neoplasia however it was statistically non significant as shown in table (6).

**Table 6: Frequency distribution of HR-HPV in different types of endometrial hyperplasia.**

	Type of hyperplasia	HR-HPV (+) No. (%)	HR-HPV (-) No (%)	Total No. (%)	X <sup>2</sup>	P-value
Endometrial hyperplasia	Hyperplasia without atypia	7 (38.8)	11(61.1)	18 (100)	0.0957	0.75706
	Atypical hyperplasia/endometrioid intraepithelial neoplasia	4 (33.3)	8 (66.7)	12 (100)		
<b>Total</b>		<b>11 (36.7)</b>	<b>19 (63.3)</b>	<b>30 (100)</b>		

## Discussion

In the present study, the mean age for endometrial cancer cases was (57.6 yrs). Which was comparable with those reported worldwide revealing that endometrial carcinoma is usually affecting females over fifty years of age<sup>(18,19)</sup> also consistent with other local study<sup>(20)</sup>.

All the cases of endometrial carcinoma in our study were of endometrioid type with no any squamous differentiation was denoted. It is not clear “whether HPV infections can provide morphological changes in the endometrial glandular type epithelium” as far till now “koilocytic changes” have only been reported in the

squamous cell carcinoma, adenosquamous carcinoma or squamoid component of some endometrial carcinomas. Based on these changes, “HPV considered not only a traveler but can also stimulate squamous metaplasia in the endometrium”<sup>(21)</sup>.

Regarding histopathological tumor differentiation (grade), in the present study we found that the most prominent grade among endometrial carcinoma cases was the well-differentiated (60%), followed by (33%) and (6.7%) for moderate & poorly differentiated respectively this was comparable to results of studies from other countries that reported well-differentiated carcinoma in

(77%) of cases compared to (21%) and (3%) for moderate and poorly differentiated tumors respectively<sup>(22,23)</sup> While it was inconsistent with the findings of other national investigator<sup>(20)</sup> observing a well-differentiated carcinoma in just (3.3%) with (60%), (36.7%) in moderate and poorly-differentiated tumors respectively. The reason for this discrepancy may be related to the different sample size included in the studies.

Sixty percent of endometrial hyperplasia in the current study were without atypia while 40% were of atypical endometrial hyperplasia/endometrioid intraepithelial neoplasia type.

The correlation between HPV positivity and age groups in our work show overall, the highest rate of HR-HPV positivity for the patients studied was found in the age group (45-49) (30.4 %). In cases of endometrial carcinoma, higher levels of HR-HPV positivity have been identified in older age groups [(45-49) and (50-54)] relative to endometrial hyperplasia and controls [(40-44) and (45-49)], but this disparity in the distribution of HR-HPV positivity by age groups has been recorded, but unfortunately we didn't find any study to compare these data.

In the current work, HR-HPV was detected in all studied groups including endometrial carcinoma, endometrial hyperplasia and controls, with higher frequency among endometrial hyperplasia (36.7%), and to a lesser extent in the control (23.3%) and endometrial carcinoma (16.7%). These figures are close to those reported in Japanese and Brazilian women<sup>(26)</sup>

and comparable with the results of other studies recording low rate of HR-HPV positivity among patients with carcinoma suggesting non-significant association between HR-HPV infection and endometrial carcinoma<sup>(27,28,29)</sup> and even failure of detection of HR-HPV in endometrial carcinoma group in other studies<sup>(30,31,32)</sup>.

On the contrary other scientific investigators showed different results reporting higher incidence of HR-HPV positivity (63.3%-87.5%) in endometrial carcinoma patients<sup>(20, 25)</sup>. This discrepancy may be attributed to several factors including the actual methodology such as using different tissue preparation techniques in these studies like 'frozen section' or 'the choice of different detection method for HPV with high false positive results like CISH (chromogenic in situ hybridization) and southern blot hybridization analysis' compared with

the high-sensitivity detection method that is PCR<sup>(33)</sup> used in the current study. In addition to the difference in the studied populations in relation to non appraisal risk factors (low socioeconomic status, multiple sexual partners, interaction with other sexually transmitted infection, smoking) and to the different HPV genotype observed among populations in the different countries. Similarly in a recent study from a neighbour country held by Mohammed et al analyzing the association of HPV16 and 18 with the risk of development of invasive cervical and endometrial carcinoma observed a higher rate of HPV positivity (mainly HPV-18) in cases with endometrial carcinoma (60%) compared to controls (29.4%)<sup>(34)</sup> again this discrepancy with our study may be the impact of heterogeneity among the studied groups with regard to age and histological types of endometrial carcinoma and absence of squamous elements (adenocarcinoma with squamous differentiation and squamous cell carcinoma) in any cases of our series.

In the present study although higher HR-HPV positive cases found in endometrial carcinoma with well-differentiated tumors, there was no significant association between HPV positivity and tumor grade. In addition we failed to find any significant association of HPV infection with the progression and stage of the disease. This is consistent with observations of other studies<sup>(20,35, 36)</sup> finding that the presence of HPV in endometrial neoplasm was unrelated to histopathological differentiation, prognostic features and patient survival.

During the current study a higher HPV positive rate was observed in cases of "endometrial hyperplasia without atypia" (38.8%) compared to "atypical hyperplasia/endometrioid intraepithelial neoplasia" (33.3%) despite that the difference was not statistically significant. Given that HPV infection is speculated to precede the progression to cancer, it is interesting that HPV was detected with less frequency in endometrial hyperplasia at risk of progressing to endometrial carcinoma, namely atypical hyperplasia/endometrioid intraepithelial neoplasia, than those not known to bear such development risk, namely hyperplasia without atypia. This clearly means that HPV can not trigger the oncogenic events at the endometrium through the sequence of "atypical hyperplasia-neoplasia". In other words we can say that HR-HPV may play a little carcinogenic effect and this needs other factors like "life style, hormonal, genetic, environmental & immune deficient state" for progression into malignancy. Consistently a lower rate of HR-HPV infection

in “atypical hyperplasia” were reported earlier in other studies<sup>(37,38)</sup>.

### Conclusion

In conclusion these findings may suggest a limited or no role of HR-HPV in the pathogenesis of endometrial carcinoma at least those without squamous elements as the columnar epithelium of the endometrium may not be a convenient host for HR-HPV replication, maturation and neoplastic transformation process.

**Ethical Clearance:** Yes

**Conflict of Interest:** Authors declares none

**Funding:** Self-funded

### Reference

1. Bray F, Ferly J and Soerjomataram I et al. Global cancer incidence 2018: GLOBOCAN estimates of incidence and mortality worldwide for 36 cancer in 185 countries. *Cancer J Clin* 2018; 68:394.
2. Iraqi Cancer Board. Results of Iraqi cancer registry center, 2015. Ministry of Health (editor), Baghdad, Iraq 2015.
3. Aune D, Navarro Rosenblatt D, Chan D, Vingeliene S, Abar L, Vieira A, Greenwood D, Bandera E, Norat T. Anthropometric factors and endometrial cancer risk: a systematic review and dose–response meta-analysis of prospective studies. *Ann Oncol* 2015; 26: 1635-1648.
4. A Epidemiology of lung cancer in Iran: sex difference and geographical distribution. *Middle East J Cancer* 2017; 8: 223-228.
5. Zhang Y, Liu H, Yang S, Zhang J, Qian L, Chen X. Overweight, obesity and endometrial cancer risk: results from a systematic review and meta-analysis. *Int J Biol Markers* 2014; 29: 21-29.
6. Mirzaei M, Sharifnia G, Khazaei Z, Sadeghi E, Fallahzadeh H, Namayandeh SM. Prevalence of general obesity and central adiposity and its related factors in adult population of Yazd. *JSSU* 2017; 25: 736-47.
7. Chaichian S, Khateri S, Moradi Y, Shadmani FK, Mansori K, Khazaei Z, Moradpour F, Varse F. Trends in cervical cancer incidence in Iran from 2003 to 2009. *Middle East J Cancer* 2017; 9: 57-63.
8. Carlson MJ, Thiel KW, Leslie KK. Past, present, and future of hormonal therapy in recurrent endometrial cancer. *Int J Womens Health* 2014; 6: 429.
9. B. Serrano, M. Brotons, F.X. Bosch, L. Bruni, Epidemiology and burden of HPV-related disease, *Best Pract. Res. Clin. Obstet. Gynaecol.* 47 (2017) 14–26.
10. H. zur Hausen, Condylomata acuminata and human genital cancer, *Cancer Res.* 36 (2 pt 2) (1976) 794.
11. World HPV Information Center, Human papillomavirus and related diseases report, *ICO HPV Inf. Cent. Rep.* (July) (2017) 1–334.
12. N. Egawa, K. Egawa, H. Griffin, J. Doorbar, Human papillomaviruses; epithelial tropisms, and the development of neoplasia, *Viruses* 7 (7) (2015) 3863–3890.
13. K. Van Doorslaer, Evolution of the papillomaviridae, *Virology* 445 (1–2) (2013) 11–20.
14. S.R. Georgescu, C.I. Mitran, M.I. Mitran, et al., New insights in the pathogenesis of HPV infection and the associated carcinogenic processes: the role of chronic inflammation and oxidative stress, *J Immunol Res* 2018 (2018) 1–10.
15. Semczuk A, Stenzel A and Baranowski W et al: Detection of human papillomavirus types 16 and 18 in human neoplastic endometrium: lack of correlation with established prognostic factors. *Oncol Rep* 2000; 7:905-910.
16. Czerwenka K<sup>1</sup>, Lu Y, Heuss F, Manavi M, Kubista E. Human papillomavirus detection of endometrioid carcinoma with squamous differentiation of the uterine corpus. *Gynecol Oncol.* 1996 May;61(2):210-4.
17. R. Zaino, S.G. Carinell and L.H. Ellenson et al. *Who Classification of Tumours of Female Reproductive Organs*, 4<sup>th</sup> edition, 2014;5:125-128.
18. Colombo N, Preti E, Landoni F, et al. (2011). Endometrial cancer : ESMO clinical practice Guidelines for diagnosis, treatment and follow- up (2011) . *Ann of oncology* 22(suppl 6) vi 35- vi 39.
19. Amands S, Bruege MD. (2013). Evaluating the utility of clinical criteria for the identification of lynch syndrome among endometrial cancer patients. Master thesis submitted to university of Texas.
20. Athraa Zaidan hassan, Sajaa J . AL-Khalidi, Basher S. Mohammed, Ali Hussein Mohammed Ali AL- Khafaji. Detection Human Papilloma Virus

- genotype (16/18) in Iraqi Women Patients with endometrial carcinoma by using Chromogen-Insitu Hybridization (CISH) Technique. *Iraqi Journal of Cancer and Medical Genetics* 2016;9:74-81.
21. Kealy WF, Annis PG, Barry JA, Hogan JM. Adenoacanthoma of the endometrium: morphological changes induced by human papillomavirus. *J Clin Pathol.* 1990; 43:554-9.
  22. Omer Asmaa M.(2010). Immunohistochemical study of hormonal receptors, HER-2 INEN and ki-67 expression in endometrial hyperplasia and endometrioid adenocarcinoma. Master thesis.
  23. Sofie Leisby . (2013). The of PET/CT, MRI, Ultra sonography and biochemical analyses for pre operative staging of endometrial cancer pateints. Phd thesis submitted to university of copenttagen . faculty of health and medical science.
  24. Fedrizzi EN, Villa LL, de Souza IV, Sebastião AP, Urbanetz AA, De Carvalho NS.Does human papillomavirus play a role in endometrial carcinogenesis? *Int J GynecolPathol.* 2009; 28:322-7.
  25. Andera GE, Stefanie G, Ioa NM, et al. (2011). Expression of HPV, steroid Receptors (ER $\alpha$ , ER $\beta$ , PR-A and PR-B) and hibin/Actin subunits ( $\alpha$ , $\beta$ A and  $\beta$ B) in adenosquamous Endometrial carcinoma . *Anticancer research* 27:2011-2018.
  26. Fedrizzi EN, Villa LL, de Souza IV, Sebastião AP, Urbanetz AA, De Carvalho NS. Does human papillomavirus play a role in endometrial carcinogenesis? *Int J Gynecol Pathol.* 2009; 28:322-7.
  27. Giantromanolaki A, Sivridis E, Papazoglou D, et al. (2007). Human papillomavirus in endometrial adenocarcinoma: infectious agent or mere "passenger" ? *infect Dis obstet Gynecol.*; 31:60549-53.
  28. Frazer IH. (2009).Interaction of human papillomaviruses with the host immune system: a well evolved relationship. *Virology.* 384(1):410–414.
  29. Karadayi N, Gecer M, Kayahan S, et al. (2013). Association between human papilloma and endometrium adenocarcinoma. *Med oncol .* 30(3): 597.
  30. Karadayi N, Gecer M and Kayahan S. et al. Association between human papillomavirus and endometrial adenocarcinoma. *Med Oncol.* 2013; 30 (3):597.
  31. Hording U, Daugaard S, Visfeldt J. Adenocarcinoma of the cervix and adenocarcinoma of the endometrium: distinction with PCR-mediated detection of HPV DNA. *APMIS.* 1997;105(4):313-6.
  32. Olesen TB, Svahn MF and Faber MT et al. Prevalence of human papillomavirus in endometrial cancer: a systematic review and meta-analysis. *Gynecol Oncol.* 2014; 134:206 -15.
  33. W. Qu, G. Jiang, Y. Cruz, et al., "PCR detection of human papillomavirus: comparison between MY09/MY11 andGP5+/GP6+ primer systems," *Journal of Clinical Microbiology*,vol. 35, no. 6, pp. 1304–1310, 1997.
  34. Mohammed A. Abu-Lubad, Dua'a A. Jarajreh and Ghada F. Helaly et al. Human papillomavirus as an independent factor of invasive cervical and endometrial carcinomas in Jordan. *Journal of Infection and Public health*, 2020;13: 613-618.
  35. Saad H.Mohammed, Basim S. Ahmed and Sura D. Dawood et al. Association of CCND1 and HR-HPV16/18 in endometrial tumors.*Iraqi Journal of Cancer and Medical Genetics*, 2015;8:143-151.
  36. Giatromanolaki A, Sivridis E, Papazoglou D, Koukourakis MI, Maltezos E. Human papillomavirus in endometrial adenocarcinomas: infectious agent or a mere"passenger"? *Infect Dis Obstet Gynecol.* 2007; 2007:60549.
  37. M. Fujita, K. R. Shroyer, N. E. Markham, et al., "Association of human papillomavirus with malignant and premalignant lesions of the uterine endometrium," *Human Pathology*, vol. 26, no. 6, pp. 650–658, 1995.
  38. T. Zbroch, P. Knapp, and P. Knapp, "Human papillomavirus (HPV) infection in the pathology of the endometrium. Role of immunological activation in antiviral and antineoplastic defense," *Medycyna Wieku Rozwojowego*, vol. 6, no. 1, pp. 43–55, 2002.

# Differences between Bribery and Gratification: A Review of Anti-Corruption Act of Indonesia

Mahrus Ali<sup>1</sup>, Al Halim<sup>2</sup>, WahyuPriyanka Nata Permana<sup>3</sup>

<sup>1</sup>Senior Lecturer of Criminal Law Department, Faculty of Law Universitas Islam Indonesia and alumni of Diponegoro University, Indonesia, <sup>2</sup>Doctorat Program Student in Law Diponegoro University, Indonesia and a Public Notary, <sup>3</sup>Lecturer of Law of Criminal Procedure Department, Faculty of Law Universitas Islam Indonesia

## Abstract

This study analyzes the concepts of bribery and gratification and the distinguishing parameters between them as regulated in several Articles of the Anti-Corruption Law. This involved the application of the normative legal research supported by court decisions to clarify these differences. The results of this study showed that bribery requires a meeting of mind between the bribe givers and bribe recipients which is not found in gratification. The reporting mechanism and the reversal burden of proof do not apply to bribery while Operation Catching Hand does not apply to gratification due to its inability to satisfy the provisions of Article 1 point 19 of the Criminal Procedure Code. Criminal sanctions are also imposed on both the giver and the recipient of a bribe while the act of a giver in gratification is not considered as a criminal offense. The study also found the wrong application of these essential differences in court decisions.

**Keywords:** Meeting of mind, reversal burden of proof, caught hand, report mechanism.

## Introduction

Law Number 31 of 1999 and 20 of 2001 concerning Corruption (hereinafter called Anti-corruption Law) regulates 7 types of criminal acts of corruption including those associated with state financial losses, embezzlement in office, bribery, extortion, conflicts of interest in procurement, fraud, and gratification. In comparison with the others, the formulation of bribery offenses in the Anti-Corruption Law is at most regulated in Articles 5, 6, 11, 12 a, b, c, and d as well as Article 13. Moreover, the data released by the Corruption Eradication Commission (KPK) between 2014-2019 shows that 65% of corruption cases in Indonesia are bribery.<sup>1</sup> The Catching Hand (OTT) conducted by the KPK from 2016-2019 totaling 87 times was also all related to bribery.<sup>2</sup>

The Anti-Corruption Law does not provide a specific meaning or clear parameters related to the act of bribery despite its frequent occurrence and regulation in several offenses. This, therefore, affects the handling of bribery cases both by the KPK, the police, the prosecutor's office, and the court.<sup>3</sup> It also shifts the establishment of a legal norm from the legislators to law enforcement by providing them the power to declare an action as a bribe.<sup>4</sup>

This study was, therefore, conducted to explore the general concepts and parameters determining an act as a bribery and to analyze the difference between the concept and gratification. This is necessary due to the fact that the Anti-Corruption Law also prohibits the acceptance of gratuities. Some court decisions related to bribery and gratification cases were also reviewed and the result of this study is considered crucial and important for law enforcement official in applying bribery legal norms while handling corruption cases.

---

## Corresponding Author:

### Mr. Mahrus Ali

Senior Lecturer of Criminal Law Department Faculty of Law Universitas Islam Indonesia. Tamansiswa, 158 Yogyakarta 55151, Indonesia  
e-mail: mahrus\_ali@uii.ac.id

## Method

A normative legal research method was used to particularly examine the legal norms on bribery and gratification in the Anti-Corruption Law as promulgated

in Law Number 31 1999 and 20 of 2001 concerning Suppression of Corruption, Indonesia. These provisions were used as the primary source of this study using a statute and conceptual approach. Literature study as well as court decisions were also used to collect data based on the assumption that the essential natures and parameters between bribery and gratification as defined by scholars need to be clearly distinguished. The data were analyzed qualitatively through data reduction by focusing on the Articles of bribery and gratification in the Anti-Corruption Law after which findings were presented and conclusions were drawn.

## Results and Discussion

**The Nature of Bribery:** Bribery is generally defined as ‘the abuse of public office for private gain’.<sup>5</sup> It specifically means giving or promising a state administrator or public servant some certain privileges<sup>6</sup> due to the favor obtainable from the position<sup>7</sup> and has also been equated with the positional offense.<sup>8</sup> This study was, however, limited to public positions without the inclusion of the private sector<sup>9</sup> due to the fact that the Anti-Corruption Law does not include bribery in the private sector as a corruption criminal act<sup>10</sup> in line with the 2003 United Nations Convention against Corruption ratified by Indonesia with Law Number 7 of 2006.

The bribery offense in the Anti-Corruption Law is characterized by several natures such as the meeting of mind between the bribe giver and recipient. This means that bribe is not established except the two parties have the will and are aware of the action. This, in economics, requires the activities of supply and demand between them.<sup>11</sup> This means bribery case necessitates the use of Article 55 paragraph (1) of Criminal Code specifically concerning participation to crime (*medeplegen*) that requires two pieces of evidence of intention; intentional cooperation to commit an offense and performance of an offense together committed internationally.<sup>12</sup> It is, therefore, not appropriate to convict only the giver or recipient of a bribe. For example, in the Century Bank scandalous corruption case, the panel of judges convicted Budi Mulia, a former Governor of Central Bank of Indonesia, for participating in the act in a quo case based on Article 55 paragraph (1) of Criminal Code while Boediono, a former Vice President of Indonesia and the senior Governor at the time, was not suspected or even convicted even though the verdict proves that the century bailout decision can only be taken collectively and collegially.

The evil intention to conduct a prohibited act usually happens before a bribe offense is committed through the use of an object such as a gift or promise. The author, however, feels it is inappropriate to describe a gift as a bribery object due to the fact that it is allowed but proposed the use of the term ‘something’ instead which is further defined as anything of economic value. It is not necessary that the recipient has the bribery object in possession before a case is established as long as such an individual has sufficient control over the item. Promises are not in the form of goods but are generally related to actions of the giver in response to an activity conducted by the recipient. The bribe giver can be anyone including individuals, corporations, public servants, advocates, judges, or even state administrators while the recipients are limited to civil servants, state administrators, advocates, and judges.<sup>13</sup> This is necessary considering the fact that bribe is related to the position of the recipient which is usually public as observed with public servants or state administrators not doing anything in their position or found using their authority or position to conduct some activities.

The prohibited acts conducted by the bribe giver include ‘giving or promising something to the public servants or state administrators’ (Article 5 paragraph 1 letter a), ‘giving something to civil servants or state administrators’ (Article 5 paragraph 1 letter b), ‘giving or promising something to an advocate’ (Article 6 paragraph 1 letter a), ‘giving or promising something to a judge’ (Article 6 paragraph 1 letter b), and ‘giving gifts or promises to civil servants keeping in mind the power or authority attached to the position or his position’ (Article 13). Meanwhile, the prohibited conduct for the recipients is ‘accepting gifts or promises’ (Article 5 paragraph 2), ‘judges or advocates accepting gifts or promises’ (Article 6 paragraph 2), ‘public servants or state administrators receiving gifts or promises despite knowing they are provided in order to influence their decisions or actions is contrary to their obligations’ (Article 12 letter a), ‘public servants or state administrators receiving gifts even though they reasonably suspect the gifts are meant to influence their professional conduct is contrary to their obligations’ (Article 12 letter b), ‘the judge receiving a gift or promise’ (Article 12 letter c), and ‘the advocate receiving a gift or promise’ (Article 12 letter d). Article 12 letter a focuses on the bribe provided to the civil servants or state administrators to conduct a certain act while letter b emphasizes those provided after the action has been conducted.



The reversal burden of proof does not apply in bribery cases and this means neither the bribe giver nor the recipient is obliged to prove that the gift or promise has nothing to do with the public position of the recipient since it is the responsibility of the public prosecutor.<sup>14</sup> It is, however, possible to have catch hands/ caught operations (OTT) in bribes offenses as observed in KPK<sup>15</sup> where they are implemented in several corruption cases which are almost impossible to solve using conventional method. Even though it is possible to have OTT in bribery offenses, those conducted by KPK do not actually violate the four criteria of being caught red-handed as shown in Article 1 number 19 of Law Number 8 of 1981 concerning the Criminal Procedure Code (KUHAP). The criteria includes arresting a person, while committing a crime, immediately after the crime is committed, third, based on the confirmation of the general public, and the moment an object allegedly used in committing a crime indicates the perpetrator participated or assisted in the process.<sup>16</sup>

In a case of bribery offense, OTT is in the form of a promise to a civil servant or organizer to receive favor based on the position of such an individual contrary to obligations. For example, a defendant promises a judge a sum of Rp. 2 billion to acquit such person in a corruption case, bribery is established when there is an agreement between them. It is important to note that the offense is completed on the day where the agreement was made, assuming March 30, 2020, even though the promise was fulfilled on July 23, 2020, after the defendant has been acquitted by the judge, and KPK implemented OTT against both the defendant and the judge. The four criteria of being caught red-handed in Article 1 number 19 of the Criminal Procedure Code have not been met, therefore, the process is declared as illegal OTT due to the existence of 4 months between the period the offense was committed and OTT was implemented by KPK.

### **Gratification vs Bribery**

Gratification is determined to be an offense in Article 12B of the Anti-Corruption Law formulated to include the following:

1. Every gratification to a civil servant or a state administrator is considered a bribe as long as it relates to the position and contrary to the obligations or duties of such individual with the following conditions:
  - a. In the amount of IDR 10,000,000.00 (ten million

rupiahs) or more with proofs the gratuity is not a bribe made according to the recipient;

- b. The value less than IDR 10,000,000.00 (ten million rupiahs) with proofs the bribery is conducted by the public prosecutor.
2. Criminal punishment for civil servants or state administrators as referred to in paragraph (1) is life imprisonment or imprisonment for a minimum of 4 (four) years and a maximum of 20 (twenty) years, and a minimum fine of IDR 200,000,000.00 (two hundred million rupiahs) and a maximum of IDR 1,000,000,000.00 (one billion rupiahs).

This article defines 'gratification' as a gift in the broadest sense including the provision of money, goods, rebates (discounts), commissions, loans without interest, travel tickets, lodging facilities, tourist trips, free medical treatment, and other facilities which are received both domestically and abroad or conducted using electronic or non-electronic means. The acceptance of gratuities by civil servants or state administrators by virtue of their position and against their obligations or duties is known as gratification. There is usually no meeting of mind between the gratuity giver and the public servants or state administrators as the recipients. The existence of a meeting of mind makes the gift a bribe with the gratification objects broadly as previously explained in Article 12B paragraph (1).

The gratuity recipient is obliged to prove the gift received is not a bribe and has nothing to do with the position not contrary to the obligation if the value is IDR. 10,000,000 or more. Such cases also involve provisions or mechanisms of reporting as confirmed by Article 12C paragraph (1), (2), and (3) that the offense in Article 12B paragraph (1) does not apply if the recipient reports the gratification received to the Corruption Eradication Commission (KPK) no later than 30 (thirty) working days from the date where the gratuity is received to determine the gratuity belong to the recipient or the state.

The provision of Article 12C eliminates criminal prosecution against civil servants or State administrators receiving gratuities. It means that acceptance of gratuity itself is an offense but the prosecution process depends on whether or not a report has been filed by the recipient to the KPK no later than 30 working days from the date it was received after which the commission determines either the gratuity belongs to the recipient or the state. Even though the Anti-Corruption Law interprets

gratification broadly, it does not include sexual relations services provided by a person to a public servant or state administrator known as sexual gratification due to its ability to cause problems as well as the impracticality of determining either the action belongs to the recipient or state. Does the inclusion of sexual service in the meaning or form of gratification makes KPK confiscate ‘women’s goods’ as the property of the State and then auction it off? This is, of course, impossible and causes women dignity. Therefore, gratification needs to be limited to the material forms and types.

Another sign of gratuity is the emergence of evil intention precisely after civil servants or state administrators receive a gift because of their position.<sup>17</sup> They are, however, allowed to report such gift within

a 30-day work period to avoid being prosecuted based on Catching Hands Operation (OTT). KPK is not authorized to conduct OTT on corruption cases related to the acceptance of gratuities due to the fact that the four criteria of being caught red-handed previously described are not satisfied. For example, a civil servant receives gratuity between April 3 and 4, 2020 and, 30 working days later, the Corruption Eradication Commission is not authorized to conduct OTT due to the provision of Article 12C paragraph (1) and 12B paragraph (1) Anti-Corruption Law which prohibit the KPK to conduct OTT after 30 working days of receiving gratuities because it contradicts the criteria previously explained. To understand more clearly, the following table shows the difference between bribery and gratification:

**Table 1: Gratuity vs. Bribery**

Element	Gratuity	Bribery
Perpetrators/Actor	Civil servants/State administrators	Public servants/State administrators/individuals/advocates/corporation/private employees
Meeting of mind	No	Yes
Bad intention	After receiving gratuity	Before a bribe occurs
Reporting mechanism	The provisions/mechanisms of reporting to the KPK apply	The provisions/mechanisms of reporting are not applicable
Reversal burden of the proof	Apply	Not apply
OTT	Impossible	Possible

**The data are processed by the authors:** In the gratification case of Nur Alam, a former Governor of Southeast Sulawesi, the verdict of the first instance court, appeal, and casation stated that Nur Alam was proven to have received a gratuity considered a bribe from Richcorp International Ltd in the amount of IDR. 40,268,792,850 from illegal grounds and not reported to the KPK within the prescribed time limit. The decision was based on several legal considerations. The money borrowed by the defendant personally from Chen Linze certainly opened the opportunity for a conflict of interest to the defendant as the Southeast Sulawesi Governor. Besides, sending money to the defendant to buy an insurance policy at AXA Mandiri on behalf of the defendant using his biological children as beneficiaries also proves that the money is not a Chen Linze’s investment to advance Southeast Sulawesi but from Richcorp International Ltd for the defendant. In addition, all cancellation/disbursement of the three AXA Mandiri insurance policies on behalf of the defendant has

been accommodated in the Non-Customer Giro (GNC) account of IDR 30,481,436,261.00. At the defendant’s request, the money was transferred to the account of Timbel Mas Abadi Ltd. gradually with each transaction below the nominal value of IDR 500,000,000 to avoid suspicion from PPATK. Finally, the money in the Sultra Timbel Mas Abadi Ltd. account, at the defendant’s request to Bank Mandiri, was also transferred in batches with the value less than IDR 500,000,000 to avoid suspicion from PPATK with the destination account being Untung Anaugi Ltd, Gino Valentino Ltd, and Bososi Pratama Ltd.<sup>18</sup>

According to the researchers, the money received by the defendant was not a gratuity or a bribe and the defendant’s actions are purely considered a civil law in the form of investment placements and personal loans. It is strengthened by several facts that investment Agreement No. CI/NA/IA/2010/001 of 19 August 2010 conducted by Richcorp International Ltd and the

defendant in a personal capacity. Provisional Fund Provision Agreement No. PPDS/RC/NA/2010/002 dated August 19, 2010. Moreover, based on the investment agreement and personal loan in the amount of IDR 40,268,792,850, the defendant apparently returned the money to Richcorp International Ltd as observed from these two pieces of evidence. First, evidence of money transfers from Giofedi Rauf to Richcorp International Ltd totaling IDR 15,000,000,000 dated May 30, 2013, IDR 15,000,000,000 dated June 3, 2013, and IDR 10,750,000,000 dated June 4, 2013. A letter dated June 10, 2013, from Richcorp International Ltd to Geofedi Rauf regarding evidence of receipt of money transferred by the defendant in the amount of IDR. 40,750,229,110. This shows that the defendant returned the money to Richcorp International Ltd before the investigation was conducted by KPK. The money was also returned in accordance with the contents of Investment Agreement No. CI/NA/IA/2010/001 dated August 19, 2010, between Richcorp International Ltd and the defendant is in a personal capacity and Agreement of Temporary Funds Provision No. PPDS/RC/NA/2010/002 dated 19 August 2010.<sup>19</sup> This, therefore, means there is no connection between the defendant's position as the Southeast Sulawesi Governor and transactions. It is important to note that it is only possible to establish gratification as long as it is related to the defendant's position.

### Conclusion

Bribery and gratuity are *malversations*. Meanwhile, in bribery, the bribe giver and receiver need to agree to commit a crime before it happens and the existence of the word 'agreed' becomes the basis for the crime imposed on both of them. The Anti-Corruption Law shows the givers can be anybody from any background while the recipients are limited only to certain performers. Moreover, the OTT usually conducted by KPK are all related to bribery cases. It was also discovered that reversal burden of proof and reporting mechanism apply only to gratuities and this means that the recipients have 30 working days after gratification has been received to report to the KPK to avoid criminal prosecution. Failure to report means that the recipient is corrupt.

**Conflict of Interest:** Nil

**Source of Funding:** Faculty of Law Universitas Islam Indonesia

**Ethical Clearance:** Taken from Legal and Ethical Committee/Board, Universitas Islam Indonesia

### References

1. Media Indonesia, 8 November 2019
2. Annual Report of Corruption Eradication Commission of Indonesia, 2018 and 2019
3. Adalgiza A. N  n  ez, "International Business, Bribery, and Criminal Liability", New Jersey Lawyer, the Magazine, 2014; 288: 65.
4. William J. Stuntz, "The Pathological Politics of Criminal Law", Michigan Law Review, 2001; 100: 519-520.
5. David M. Fuhr, "Of Thieves and Repressors: The Interplay between Corruption and Human Rights Violations", Elon Law Review, 2013; 5: 273.
6. Eric C. Chaffee, "From Legalized Business Ethics to International Trade Regulation: The Role of the Foreign Corrupt Practices Act and Other Transnational Anti-Bribery Regulations in Fighting Corruption in International Trade", Mercer Law Review, 2014; 65: 712.
7. Lawrence J. Trautman and Kara Altenbaumer-Price, "Lawyers, Guns, and Money: The Bribery Problem and the U.K. Bribery Act", International Lawyer, 2013; 47: 485-486.
8. Marsha Z. Gerber & Elaine L. Lawson, "Business Entertainment "Texas Style" Here and Abroad What You Need to Know", Texas Bar Journal, 2012; 75: 536.
9. Leonce Ndikumana: The Private Sector as Culprit and Victim of Corruption in Africa. Political Economy and Research Institute, University of Massachusetts Amherst, 2013: 11.
10. Fariz Cahyana, "the Importance of Regulating Bribery in the Private Sector as Offense of Corruption in Indonesia", Juris-Diction, 2020; 3 (1): 63-67.
11. Lindsay B. Arrieta, "Attacking Bribery at its Core: Shifting Focus to the Demand Side of the Bribery Equation", Public Contract Law Journal, 2016; 45: 590-592.
12. Jan Remmelink: Criminal Law. Translated by Tristan, Jakarta: Gramedia Pustaka, 2003: 314-315.
13. Elizabeth K. Spahn. "Implementing Global Anti-Bribery Norms: From the Foreign Corrupt Practices Act to the OECD Anti-Bribery Convention to the U.N. Convention against Corruption", Indiana International & Comparative Law Review, 2013; 23: 25.

14. Muh. Arief Syahroni, M. Alpian, and Syofyan Hadi, "Reversal Burden of Proof of Corruption", *Jurnal Ilmu Hukum*, 2020: 126-128.
15. Lucinda A. Low, Sarah R. Lamoree, & John London, "The "Demand Side" of Transnational Bribery and Corruption: Why Leveling the Playing Field on The Supply Side isn't Enough", *Fordham Law Review*, 2015; 84: 583-584.
16. Rizky Oktavianto and Norin Mustika Rahadiri Abheseka, "Evaluation of Hand Arrest Operation of KPK", *Journal of Integrity*, 2019; 5(2): 119.
17. Nur Mauliddar, Mohd. Din, and Yanis Rinaldi, "The Gratification as Corruption in Regard with a Report from a Gratification Receiver ", *Kanun*, 2017; 19 (2): 162-164.
18. Court Decision of Central Jakarta, 123/Pid.Sus/TPK/2017
19. Supreme Court Decision No. 2933 K/Pid.Sus/2018

# Study to Assess the Level of Stress among Nursing Students

Mandeep Kaur<sup>1</sup>, Kanika Guleria<sup>2</sup>, Anisha<sup>3</sup>

<sup>1</sup>Nursing Tutor, Chitkara School of Health Sciences, Chitkara University, Punjab, India, <sup>2</sup>Assistant Professor, Chitkara School of Health Sciences, Chitkara University, Punjab, India, <sup>3</sup>Nursing Tutor, Chitkara School of Health Sciences, Chitkara University, Punjab, India

## Abstract

Stress is a state created by amendment in atmosphere that is damaging to the person's equilibrium and is mostly prevalent in nursing students. The study aims to measure the stress level of nursing students. Sample size consisted of 63 nursing students of GNM 1<sup>st</sup> year and B.Sc.(N) Post basic 1<sup>st</sup> year chosen by convenience non-probability sampling technique and informed consent were taken from subjects. The UN Management stress tool was used to collect data which was taken from UNO Management Booklet of series. The results of the study has revealed that 97% of GNM 1<sup>st</sup> year students and 67% of Post Basic B.Sc. Nursing students were in moderate stress. The stress level is high in GNM 1<sup>st</sup> year students as compare to post basic BSc Nursing 1<sup>st</sup> year. Mean stress score of Post Basic B.Sc.(N) 1<sup>st</sup> year and GNM 1<sup>st</sup> year was  $17 \pm 2.3$  &  $23 \pm 3.5$ .

**Keywords:** Prevalence, Stress, Nursing Students.

## Introduction

Stress is produced by varying environment. It disturbs the mental balance of any person. Nursing is training is one of the most stressing training. Numerous studies have shown that there are many reasons of stress throughout nursing training. The prevalent sources of stress felt by students and faculty that comprises curriculum requirements, assignments and examinations and combining clinical work with studies.<sup>1</sup>

According to the Oxford University, it is a state of affair involving on physical or mental energy. We can define stress as private state that is produced by physical requirements on the body or by atmosphere and social state of affairs that are evaluated as probably harmful, not under control or surpassing our resources for coping. Seyle has defined stress as excessive burning of energy resources.

Stress is a big problem in the society. 75% of bodily disease are said to be due to stress. There are many stressors like transitions in life, money problems, pressure of day-to-day life, no leisure time, problems in relationships and domestic problems. Nursing students face both academic as well as professional stress during their training period.<sup>2</sup> Academic stress is that stress which is faced by students during academic period. One study suggested that stress is linked with the type of institution in which the nursing student studies. For instance, Curriculum pattern of private college can be different from Government nursing College.<sup>3</sup> Professional stress is that which is caused during job.

### According to "UN Management Booklet" stress is of three types:

1. Basic stress: It is a minor stress which include in day-to-day situation that tension, frustration, anger & irritation.
2. Cumulative stress: It is a result of strain occurs too often, more severe and stays for longer period.
3. Traumatic stress: This stress threatens physically or psychologically.

Stress can have a positive and negative aspect, when it is positive it acts as motivator for growth but when it

---

### Corresponding Author:

**Ms. Mandeep Kaur**

Chitkara School of Health Sciences, Chitkara University, Punjab

Contact No.: 9878580276

e-mail: mandeep.kaur.n@chitkara.edu.in

is negative, it causes illness. Academic stress becomes serious mental health problem. Nursing students are important and beneficial human assists. Detection of stress is extremely important as it can be the reason of low productivity, decreased quality of life and suicidal thoughts which are due to examination, assignments submission, and assessment.

According to study done on nursing students in public university, more than 50% subjects had stress symptoms. This stress decreases quality of life of students.<sup>4</sup>

The study conducted on 455 nursing students in Nursing college, Brazil revealed that 64% of students were having stress<sup>5</sup>.

Study done at PGIMER Chandigarh on 43 Nursing students, revealed that the moderate stress level was 99.2 among 5 students, mild stress 72.33 among 21 students and no stress is 46.42 among 17 students. 11.62% subjects experienced moderate stress and 48.83% experienced mild stress, 39.53% experienced no stress.<sup>6</sup>

According to, one more study done at Seth Medical College to assess level of stress among medical students. Results of their study has shown that majority of students perceived 73% stress and high stress level was stress found in 2<sup>nd</sup> year rather in 1<sup>st</sup> or 3<sup>rd</sup> year.<sup>7</sup>

In the present scenario, stress has become a big problem especially among students. This condition can be witnessed among nursing students, so researcher has conducted a study to find out the stress level of nursing students of Nursing college of Punjab.

### Subjects and Method

A descriptive research design was adopted for the study. Study was conducted at Kular College of Nursing, Kishangarh. The sample of 63 students was chosen by convenience sampling technique. All the nursing students who were ready to give informed consent were included in the study. Those who did not give informed consent or who were not accessible at the time of compilation of data were excluded from the study. This study was approved by Advisory Committee of Nursing College and participants were included in the study after taking permission from Principal of College and students were assured of confidentiality. A

structured Performa containing socio demographic data including the basic information such as age, sex, marital status, nursing course, subjects was distributed to the participants. A standard questionnaire tool was taken from UNO Management of Stress *Management*: In this tool, 10 questions were given to assess stress and it had maximum score of 30 and minimum score of 15. Score upto 15 considered normal, 15 – 25 considered Moderate Stress level and 25 – 30 considered Severe Stress level. The descriptive and inferential statistical measures used for analysis for identifying the result of study.

### Results

Ninety-seven percent of the study population was Female and three percent were Male. Maximum respondents were from the rural background. 75% from rural area and 25% from urban area. Only 8% of subjects were married and rest 92% were unmarried. The subjects of 18 years of age or less than 18 years had more stress than subjects of more than 18-years-of-age. (Table 1).

**Table 1: Socio demographic variables of the subjects from both the groups. N=63**

Demographic Variables	N	%
<b>Age</b>		
<18 or 18	20	32%
19-22	24	38%
23 or >23	19	30%
<b>Marital status</b>		
Married	6	8%
Unmarried	57	92%
<b>Sex</b>		
Male	2	3%
Female	61	97%
<b>Resident</b>		
Rural	47	75%
Urban	16	25%
<b>Classes</b>		
GNM	36	57%
Post Basic B.Sc.(N)	27	43%

Table 1 depicted that, more than half of the subjects (38%) were from age group of 19-22. Majority of the females (97%) were unmarried (92%). Majority of the subjects (75%) were from rural area. More than half of the subjects (57%) were from GNM 1<sup>st</sup> year.

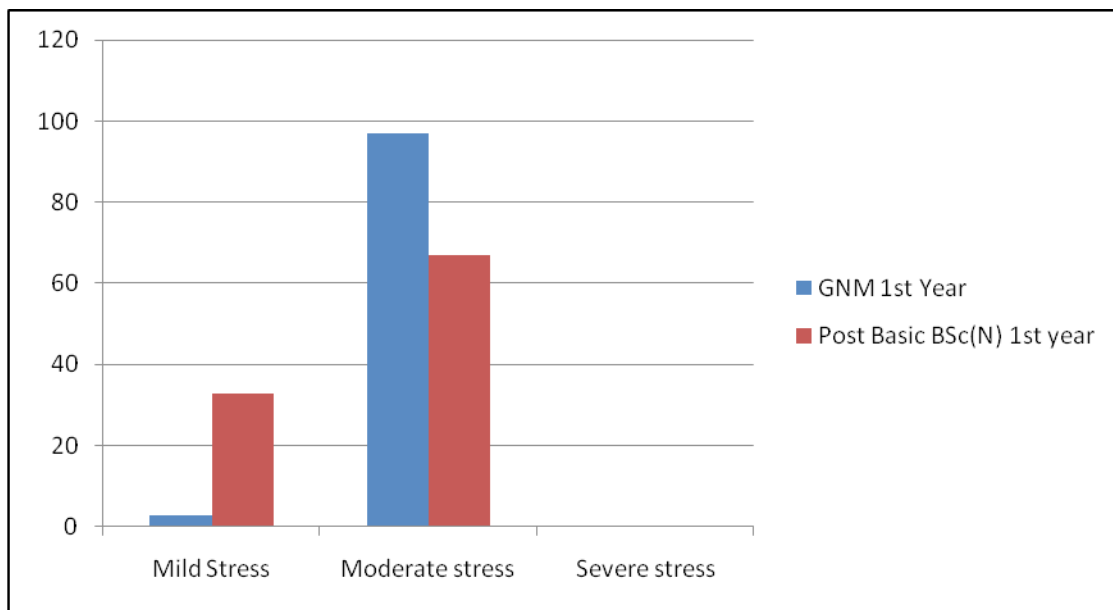
**Table 2: Mean score of stress levels among GNM 1<sup>st</sup> year and B.Sc (N) Post basic 1<sup>st</sup> year students**

Classes	GNM 1 <sup>st</sup> year	Post Basic B.Sc. Nursing 1 <sup>st</sup> year
Mild stress	1 (3%)	9 (33%)
Moderate stress	35 (97%)	18 (67%)
Mean ± SD	23 ± 3.5	17 ± 2.3

Table 2 depicted that moderate stress (97%) was more in GNM 1<sup>st</sup> year students and rest of the subjects had mild stress with a mean score of 23 ± 3.5 whereas in B.Sc (N) Post Basic 1<sup>st</sup> Year, more than half of subjects (67%) had moderate stress and rest of the subjects had

mild stress with a mean score 17 ± 2.3. The G.N.M 1<sup>st</sup> year subjects were having more stress than B.Sc. (N) Post Basic 1<sup>st</sup> Year as indicated by the higher mean score.

**Prevalence of Stress:** About 97% GNM 1<sup>st</sup> year students and 67% B.Sc (N) Post basic 1<sup>st</sup> year students had Moderate stress level. Mean stress score of GNM 1<sup>st</sup> year students came out 23 ± 3.5 and Mean stress score of Post basic 1<sup>st</sup> year students was 17 ± 2.3. The finding shows that the level of moderate stress is higher than mild stress & there is no case of severe stress. (Table 2 & Figure 1).



**Figure 1: Percentage distribution of stress level among both groups.**

Figure 1 depicts that 97% subjects of GNM 1<sup>st</sup> year and 67% subjects of Post basic B.Sc.(N) 1<sup>st</sup> year had moderate stress. And 3% subjects of GNM 1<sup>st</sup> year

and 33% of Post Basic BSc (N) 1<sup>st</sup> year had mild stress. None of the subjects has severe stress.

**Table 3: Association between stress scores and selected demographic variables.**

Demographic variables	Mild stress	Moderate stress	df	Table value	Chi square	p-value
<b>Age</b>						
<18 or 18	1	19	2	5.99	5.3536 <sup>S</sup>	0.0687
19-22	7	17				
23 or >23	2	17				
<b>Marital status</b>						
Married	4	2	1	3.84	12.812 <sup>S</sup>	0.002
Unmarried	6	51				

Demographic variables	Mild stress	Moderate stress	df	Table value	Chi square	p-value
<b>Sex</b>						
Male	1	1	1	3.84	1.8015 <sup>NS</sup>	0.1794
Female	9	52				
<b>Resident</b>						
Rural	9	38	1	3.84	1.4873 <sup>NS</sup>	0.2226
Urban	1	15				
<b>Classes</b>						
GNM	1	35	1	3.84	10.7873 <sup>S</sup>	0.0009
Post Basic B.Sc.(N)	9	18				

**Table 3** shows that the association between stress scores and socio demographic variable such as age, marital status and classes found significant, as calculated value is greater than tabulated value at the p level of significance  $< 0.05$ . It means stress scores were associated with age and marital status. And the association between stress scores and socio demographic variables such as sex and gender found non-significant, as calculated value is less than tabulated value at the p level of significance  $< 0.05$ .

### Discussion

The present study showed that level of moderate stress was higher than mild stress. The level of moderate stress among 35 students of GNM 1<sup>st</sup> year was 97% percentage and 67% among 18 students of B.Sc (N) Post basic 1<sup>st</sup> year. According to one study conducted among nursing students in Kathmandu university to assess the academic stress, the result came out with 75% students with academic stress [8]. Similar result was found in one study done on Nursing workers. It was a comparative study to determine job related stress, stress reaction, coping strategies adopted by nursing personnel working in critical and non-critical unit of selected hospital of Delhi. It was found that percentage of moderate stress was higher that is 59.65% than mild stress 22.81%. Most of them felt troubles in participation in social life due to institute's timings, living away from home, lack of time for self- study, strict rules and regulation in the hospital, unable to get leisure time for recreation. The finding of the research showed that the moderate stress was more in the age group of 18 or less than 18 (95%) as compare to other age group. Similar result was found in one study done on nursing students of B.Sc Nursing 1<sup>st</sup> year at PGI Chandigarh. The results of the study has shown that the stress level was greater in the age group of 17 – 22 years

& level of moderate stress was higher than mild stress. Mean of moderate stress is 99.2 & 72.33 in mild stress.

### Conclusion

Stress has become a never ending, continuous & prevalent condition in today's world. Present generation is marked as generation of stress. Everyone experiences various forms of stress in their lives. Stress has become very common among the students. In the present research, attempt was made to determine the stress among nursing students in Nursing College, Punjab following a descriptive design. This study has tried to assess the mental well-being or the lack thereof, of the students undergoing nursing training. The fact that these students are finding the subjects difficult, living in hostels, doing shift duties in hospitals, academic workload is reflected in the significantly higher incidence of stress that they experience, as compared to the general population. We suggest that an induction program at the start of the nursing course, and positive mental health training can go a long way toward reducing strain of nursing students and can provide betterment to their professional and personal well-being.

**Acknowledgement:** The researchers would like to express their special thanks to Mrs Aditya Sharma, Former Principal of Kular College of Nursing for permitting us to perform the study and all the participants of this study for their valuable responses.

**Financial Support & Sponsorship:** Nil

**Conflict of Interest:** There are no conflict of interest

**Ethical Clearance:** Taken from the ethical and research committee of Kular College of Nursing.



## References

1. Labrague LJ. Stress, stressors, and stress responses of student nurses in a government nursing school. *Heal Sci J*. 2013;7(4):424–35.
2. Pulido-Martos M, Augusto-Landa J-M, Lopez-Zafra E. Sources of stress in nursing students: a systematic review of quantitative studies. *Int Nurs Rev* [Internet]. 2012;59(1):15–25. Available from: [http://www.scopus.com/inward/record.url?eid=2-s2.0-84857037280 & partnerID=tZOTx3y1](http://www.scopus.com/inward/record.url?eid=2-s2.0-84857037280&partnerID=tZOTx3y1)
3. Sharma N, Kaur A. Factors associated with stress among nursing students. *Nurs Midwifery Res J*. 2011;7(1):12–21.
4. Mota NIF, Alves ERP, Leite GDO, Sousa BSMA de, Ferreira Filha M de O, Dias MD. Estresse entre graduandos de enfermagem de uma universidade pública. *SMAD Rev Eletrônica Saúde Ment Álcool e Drog (Edição em Port)* [Internet]. 2016;12(3):163. Available from: <http://www.revistas.usp.br/smad/article/view/120787>
5. Ribeiro V, Cestari F, Barbosa IV, Sampaio Florêncio R, Lúcia V, De M, et al. Stress in nursing students: study on sociodemographic and academic vulnerabilities. *Acta Paul Enferm Acta Paul Enferm*. 2017;30(302):190–6190.
6. Dhar R, Walia I, Das K. Descriptive study to assess the causes of stress and coping strategies used by the newly admitted basic BSc Nursing students. 2009;(1):31–7.
7. Supe AN. A study of stress in medical students at Seth G.S. Medical College, J Postgrad Med [Internet]. 1998;44(1):1–6. Available from: <http://www.jpgmonline.com/article.asp?issn=0022-3859;year=1998;volume=44;issue=1;page=1;epage=6;aulast=Supe>
8. Acharya Pandey R, Chalise HN. Self-Esteem and Academic Stress among Nursing Students. *Kathmandu Univ Med J (KUMJ)* [Internet]. 2015;13(52):298–302. Available from: [http://ovidsp.ovid.com/ovidweb.cgi?T=JS & PAGE=reference & D=prem & NEWS=N & AN=27423](http://ovidsp.ovid.com/ovidweb.cgi?T=JS&PAGE=reference&D=prem&NEWS=N&AN=27423)

# Methodical Learning on Organ Donation: Effect on Students Knowledge and Attitude

Maninder Singh<sup>1</sup>, Manpreet Kaur Grewal<sup>1</sup>, Amanpreet Kaur<sup>1</sup>,  
Yamini Chopra<sup>2</sup>, Aarti Bhatt<sup>2</sup>, Tenzin Choden<sup>2</sup>, Manisha Sharma<sup>2</sup>

<sup>1</sup>Assistant Professor, <sup>2</sup>B.Sc Nursing 4<sup>th</sup> Year Student, Chitkara School of Health Sciences,  
Chitkara University, Punjab, India

## Abstract

**Introduction:** Organ donation provides the recipient with a second chance to live. Inappropriate knowledge and attitude of individuals to organ donation are one of the most important barriers for organ donation.

**Aims and Objectives:** To determine the effectiveness of structured teaching program on knowledge and attitude regarding organ donation among students.

**Study Design:** Pre-experimental one group pre-test and post-test.

**Study Variables:** Age, Religion, Habitat, Family type, Education stream, and Information source.

**Result and Discussion:** It was found that after a structured teaching program knowledge level of students in post-test was increased that is 66% adequate knowledge whereas 34% of participants have moderate knowledge. Also, in pre-test 89% of the student had poor attitude and 79% student had satisfactory attitude in post-test. Significant association between the level score of knowledge with an information source had been found.

**Conclusion:** In the present study, a marked increase in knowledge and change in the attitude level of the students has been observed during the post test.

**Keywords:** *Organ donation, knowledge, attitude.*

## Introduction

Organ Donation is the caring demonstration of giving one's organs to someone else, who is in critical need of those organs. It is characterized by the WHO as "giving human cells, tissues, and organs proposed for human applications". Giving an organ can prompt

sparing as well as improving the quality of life of someone else. Shockingly, the quantity of individuals that need an organ incredibly outperforms the quantity of genuine givers.<sup>[1]</sup>

In the world, India's organ donation rate is the lowest rate that is 0.86 per million. In India, 500,000 individuals need organ transplantation every year and a large number of them pass on because of an absence of organs accessible for transplantation.<sup>[2]</sup> Lack of mindfulness alongside myths and misguided judgments adds to the low level of organ donation. Young adults address the inevitable destiny of society and effect family members and partners. A bit of good data on the young adults in this issue, not just method a constructive faculty disposition towards organ donation yet it can in like manner be the choosing part for supporting gifts when faced with the death of a relative.<sup>[3]</sup>

---

### Corresponding Author:

**Mr. Maninder Singh**

Assistant Professor, Department of Nursing, Chitkara School of Health Sciences, Chitkara University, Punjab, India

e-mail: manindersodhi87@gmail.com

Mob. No.: 9988263329

Along these lines, there is an incredible requirement for expanding mindfulness about the significance of organ donation and the lawful arrangements identified with it. Understudies are youngsters who spread information, deprived for mindfulness as a rule open intrigue. So an organized instructing program was intended to be regulated among the University understudies to expand the information level by mediations.

#### Aims and Objectives:

1. To assess the mean pre and post-test of Knowledge and attitude score regarding organ donation.
2. To determine the effectiveness of structured teaching program on the mean knowledge and attitude scores.
3. To determine the association between knowledge and attitude regarding organ donation with selected socio-demographic variables.
4. To find out the relationship between knowledge and attitude regarding organ donation among students.

#### Material and Method

**Study Design:** This was a Pre-experimental one group pre-test and post-test study conducted on 100 students studying at Chitkara University, Punjab, India. Sampling technique used for the data collection is Purposive sampling Technique. Structured knowledge Questionnaire used for assessing the knowledge of students and 3 point Likert's scale was used for assessing the Attitude of the students. First Pre-test was conducted on students after that organized instructing programme was administered to the students immediately after this. Post-test had been conducted after 7 days and the collected data was analyzed with the help of SPSS.

**Inclusion Criteria:** Students who were studying at Chitkara University and want to be a part in study.

**Exclusion Criteria:** Those were not present during data collection.

**Study Variables:** The variables were Age, Religion, Gender, Family type, Education stream, Habitat, Information source.

#### Results and Discussion

The total 100 students were participated in structured teaching program regarding organ donation at Chitkara University Punjab. Table-1 depicts maximum (90%) students were in the age of 18-21 years, followed by age up to -22 years (10%). Majority of the sample were found to be females (76%) whereas males were (24%). In religion wise distribution it was found that there were Hindu (57%), Muslim (6%) and Christian (4%). In relation to family it was found to be nuclear (65%) and joint (29%) and single parents (6%). Data presented in above table shows greater (73%) of students were form urban whereas (27%) rural area. Regarding previous board of school more than half (69%) of students were done schooling from private whereas (31%) were done from government. In case of experience of organ donation data presented in above table shows lesser have (7%) have experience of organ donation and greater have no personal/family experience of organ donation (93%). Table show bulk of students haven't attended any organ donation program previously (81%) and (19%) have attended. The sample were found to be getting information from internet/mass media (46%) and friends/family and health personnel (23%) and any other (8%).

**Table 1: Frequency distribution of the level of knowledge of participants in pre-test & post-test. N=100**

	Inadequate Knowledge (0-6)	Moderate Knowledge (7-12)	Adequate Knowledge (13-17)	Mean Score	SD
Pre Test	1(1%)	62(62%)	37(37%)	11.96	2.146
Post Test	0(0%)	34(34%)	66(66%)	12.91	1.531

Table 1 shows that there is difference between posttest mean (12.91) and pretest mean (11.96) knowledge regarding organ donation.

**Table 2: Association between Knowledge levels with demographic variables N=100**

Demographic Variables		Pre-Test Knowledge			Chi Test	P Value
Variables	Options	Adequate Knowledge	Moderate Knowledge	Inadequate Knowledge		
Gender	Male	12	12	0	2.492	0.288 <sup>NS</sup>
	Female	25	50	1		
Age (in years)	18 Years	6	15	0	5.985	0.649 <sup>NS</sup>
	19 Years	14	26	0		
	20 Years	13	15	1		
	21 Years	3	6	0		
	22 Years	1	0	0		
Religion	Hindu	19	38	0	3.968	0.681 <sup>NS</sup>
	Muslim	2	4	0		
	Christian	1	3	0		
	Sikh	15	17	1		
Family type	Joint Family	11	17	1	3.659	0.454 <sup>NS</sup>
	Nuclear Family	25	40	0		
	Single Parent	1	5	0		
Habitat	Urban	25	47	1	1.172	0.557 <sup>NS</sup>
	Rural	12	15	0		
Previous board of school	Government	10	21	0	0.961	0.618 <sup>NS</sup>
	Private	27	41	1		
Personal/family experience of organ donation	Yes	3	4	0	0.174	0.917 <sup>NS</sup>
	No	34	58	1		
Have you attended any organ donation program previously	Yes	6	12	1	4.455	0.108 <sup>NS</sup>
	No	31	50	0		
Information source of organ donation	Friends/family	7	16	0	14.799	0.022*

NS= non-significant at  $p < 0.05$  level

Table 2 describes that chi square test for association with the gender ( $\chi^2=2.492$ ), with age ( $\chi^2=5.985$ ), with religion ( $\chi^2=3.968$ ), with type of family ( $\chi^2=3.659$ ), with habitat ( $\chi^2=1.172$ ), with previous board of school, ( $\chi^2=0.961$ ) with personal/family experience of organ donation ( $\chi^2=0.174$ ), with have you attended any organ donation program previously related to knowledge ( $\chi^2=4.455$ ) and association with information of organ donation ( $\chi^2=14.799$ ).

The chi square value describes a significant association between level of knowledge score and information source ( $p < 0.05$ ). There is no significant association between level of knowledge score and other socio demographics profile.

**Table 3: Association between attitude score with their socio demographic variables of the subjects N=100**

Demographic Variables		Pre-Test Attitude			Chi Test	P Value
Variables	Options	Poor Attitude	Satisfactory Attitude	Good Attitude		
Gender	Male	19	5		3.119	0.07 <sup>NS</sup>
	Female	70	6			
Age (in years)	18 Years	19	2		1.606	0.808 <sup>NS</sup>
	19 Years	35	5			
	20 Years	25	4			
	21 Years	9	0			
	22 Years	1	0			
Religion	Hindu	52	5		3.883	0.274 <sup>NS</sup>
	Muslim	4	2			
	Christian	4	0			
	Sikh	29	4			
Family type	Joint Family	24	5		2.103	0.349 <sup>NS</sup>
	Nuclear Family	59	6			
	Single Parent	6	0			
Habitat	Urban	65	8		0.000	0.983 <sup>NS</sup>
	Rural	24	3			
Previous board of school	Government	25	6		3.203	0.073 <sup>NS</sup>
	Private	64	5			
Personal/family experience of organ donation	Yes	5	2		2.374	0.123 <sup>NS</sup>
	No	84	9			
Have you attended any organ donation program previously	Yes	18	1		0.789	0.375 <sup>NS</sup>
	No	71	10			
Information source of organ donation	Friends/family	23	0		5.405	0.144 <sup>NS</sup>

NS= non-significant at p<0.05 level

Table 3 delineates that chi square test for association with the gender ( $\chi^2 = 3.119$ ), with age ( $\chi^2 = 1.606$ ) with religion ( $\chi^2 = 3.883$ ), with type of family ( $\chi^2 = 2.103$ ), with habitat ( $\chi^2 = 0.000$ ), with previous board of school, ( $\chi^2 = 3.203$ ) with personal/family experience of organ donation ( $\chi^2 = 2.374$ ), with have you attended any organ donation program previously related to knowledge

( $\chi^2 = 0.789$ ) and association with information source of organ donation ( $\chi^2 = 5.405$ ).

The chi square value shows there is no any significant association between attitude score and other socio demographic profile.

**Table 4: Relationship between knowledge and attitude regarding organ donation among subjects N=100**

Pair 1	vs	Pair 1	r value	P value
Pre Knowledge	vs	Pre Attitude	0.025	0.803
Post Knowledge	vs	Post Attitude	0.244*	0.015

\*Correlation is significant at the 0.01 level (2-tailed).

Table 4 illustrates that there has been no relationship between pre knowledge and pre attitude but there is relationship between post knowledge and post attitude knowledge after structured teaching program.

### Conclusion

Based on the present study knowledge level of students increases after structured teaching and also change in attitude level. There was significant association between level score of knowledge with information source whereas no statistically significant association was found with demographic variables.

### References

1. Devi, S. and Jyothi, B., 2019. Effectiveness of Structured Teaching Programme on Knowledge and Attitude regarding Organ Donation and Transplantation among Adolescents in Selected Junior Colleges of Guntur (Dt), AP. *International Journal of Advances in Nursing Management*, 7(1), p.45.
2. Organ receiving and giving awareness network. Available from: <https://www.organindia.org/make-a-pledge/>[Accessed 19 March 2020].
3. Beth, M. Baby, A. and Bhula, M., 2018. Effectiveness of Planned Teaching Programme on Knowledge Regarding Organ Donation Among Under Graduate Students. *Journal of Advanced Health Informatics*, 4(1).

# Variation in Sleep Pattern Due to Lockdown among Collegiate Students

Manisha Bhandari<sup>1</sup>, Rabab Kaur<sup>2</sup>

<sup>1</sup>Student, Galgotias University, <sup>2</sup>Assistant Professor, Galgotias University, Plot No. 2, Yamuna Expy, Opposite, Buddha International Circuit, Sector 17A, Greater Noida, Uttar Pradesh 203201

## Abstract

**Background:** Due to the vast spread of corona virus, lockdown was announced in many countries, and hence many people are facing psychological, physical, economic and social changes. Students at the college experience a variety of sleep problems which can have a direct effect on academic success, health and mood. Sleep disruption and excessive daytime sleep are common problems for students.

**Subject and Method:** 141 college students between the age of 17 to 24 were taken from various colleges. The structured Pittsburgh Sleep Quality Index was used and was circulated amongst students through Google forms and the sleep log, and demographic sheet was used to test sleep length, daytime sleepiness and related sleep issues.

**Study Design:** A cross sectional study.

**Results:** The result, on the basis of the sleep pattern of college students, was classified into 5 categories: (healthy sleep pattern, mild, moderate, severe and worst). 53.90% out of 141 respondents had healthy sleep pattern range (0-5), 39.71% had mild sleep pattern range (6-10), 4.96% out of 141 respondents had moderate sleep pattern range (11-15), and 1.41% out of 141 respondents had severe sleep pattern range (16-20).

**Conclusion:** In our study we found that during the lockdown majority of college students had a healthy sleep pattern and least of the college students had a severe sleep pattern range.

**Keywords:** Pittsburgh Sleep Quality Index, Coronavirus, Lockdown, sleep pattern, college students.

## Introduction

Sleep is a physiological process that can alternate with internal and external stimulation between conscious stage and unconscious stage<sup>1</sup>. Sleep absorbs about one third of our lives and thus it plays a crucial role which is key to emotional, physical development and stability. A good sleep is needed for better growth and stability, if there is lack of sleep than it may decrease physical and mental capacities along with mental problem such as anxiety and depression, therefore sleep loss has tremendous impact on both society as well as individuals<sup>2</sup>. Now days the second most common symptom of mental distress is commonly known as sleep disturbance, according to many surveys now days one third of college students reports difficulty in sleeping<sup>3</sup>. Now days insufficient sleep and irregular sleep wake

schedule among the college student are becoming major health problem, which is directly related to decrease the quality of life, due to the hectic schedules college student suffer from sleep disturbance, fatigue and mood change<sup>4</sup>. Many research show that there is high chance of sleep disturbance in college student than the general population<sup>5</sup>.

Sleep disturbance for college students is directly associated with cognition, academic performance, emotional, intelligence, psychological and physical health. Still no research is available on the impact of sleep quality on college student's health and well-being. The main factor for sleep disturbance to the college students are all nightery parties, late-night studying and social obligation, work and alcohol/or drug abuse<sup>8</sup>. It's hard to fall asleep earlier in the evening for the college

students because they cannot wake up early. In addition, the college students sleep pattern is characterized by inadequate length of sleep, delayed onset of sleep and frequency of napping during the day that directly affect the study<sup>9</sup>.

The world health organization (WHO) confirmed in January 2020 the outbreak of a new corona disease, Covid-19 which had already reported that there is a potential high risk of covid-19 spreading to the entire world<sup>10</sup>. As a consequence of the spread of covid-19 disease, almost all countries form formulated the guidelines which include isolating, lockdown quarantining and social distancing at these times. Lockdown is the concept used for separation, or restriction of movement of the community during an epidemic of infectious disease. Because of a dramatic rise in covid19 incidents the government imposed an immediate lockdown to prevent the disease from spreading across the population<sup>11</sup>. Nowadays, the current situation is facing negative effect on many factors which influence sleep quality and almost all people are experiencing major changes in their daily life<sup>12</sup>. In lockdown college students increased the use of digital media to alter sleep habits at bedtime. The increased sleep pattern leads to higher levels of depression, anxiety, and stress in many people<sup>13</sup>. Sleep issue can be significant concern for all during the lockdown, but some individuals are at higher risk of experiencing sleep problems than others. Women experience poor sleep and insomnia more often than men. In addition, students can depend on their phone with the likelihood of mobile phones, which directly affects the sleep pattern. According to the national sleep foundation in the U.S. 2011 task force, 50 percent of young adults use their cell phones and the internet before they sleep. The improper use of computers and mobile devices in the bedroom thus delays bedtime and the raise time<sup>14</sup>.

### **Methodology**

This chapter discusses the process used for the analysis which provides explanation of the topics used in data collection and analysis and procedures. The research Sample consisted of 141 College Students based on the structured questionnaire respondents.

The subject of this study was 141 college students. The primary data was collected from college students by using stratified random sampling method. Universe of this present study was the college students in lockdown, India . Besides that, all of them were between 17 to 24

years of age. The data has been collected through college students by structured questionnaires using online Google form.

#### **Inclusion Criteria:**

1. Gender- male and female
2. College students
3. Subject should be between 17 to 24 years
4. Able to understand Hindi and English language
5. Individuals who were cooperative
6. Young healthy individuals

#### **Exclusion Criteria:**

1. Students with neurological issued
2. Non-cooperative subjects

### **Result**

In this survey study 141 subjects participated and answered all the questions of sleep quality questionnaire and also provided detailed demographic information including name, age, gender, contact number, address, and contact details for email.

The Pittsburgh sleep quality index (PSQI) was used. Table 1 shows subjective sleep quality and according to it 32.6% out of 141 respondents, sleep quality rate is very good, 48.9% out of 141 respondents, sleep quality rate is fairly good, 13.4% out of 141 respondents, sleep quality rate is fairly bad and 5 % out of 141 respondents, sleep quality rate is very bad. According to table 2 30.4% out of 141 respondents took less than 15 minutes to sleep at night, 42.5% out of 141 respondents took 16 -30 minutes to sleep at night, 14.1% out of 141 respondents took 31-60 minutes to sleep at night and 12.7% out of 141 respondents took more than 60 minutes to sleep at night. Table 2.1 shows that 56.7% out of 141 respondents had trouble sleeping in the past month because they could not sleep within 30 minutes, 17.02% out of 141 respondents had trouble sleeping less than once a week because they could not get sleep within 30 minutes, 14.8% out of 141 respondents had trouble sleeping once or twice a week because they could not get sleep within 30 minutes and 11.3% out of 141 respondents had trouble sleeping three or more times a week because they could not sleep within 30 minutes.

In table 2 and figure 2 we calculated the component in which we analyzed the responses of question 2 and 5a.



For component 3, 3 43.9% out of 141 respondents got 7 hours or more hours of actual sleep at night, 48.3% out of 141 respondents got 6 to 7 hours of actual sleep at night. 5.6% out of 141 respondents got 5 to 6 hours of actual sleep at night and 2.1 % out of 141 respondents received 5 hours of real night-time sleep. For component 4, sleep effectiveness of sleep is determined by using formula (hours slept ÷ hours in bed)×100. For component 5, 14.1% out of 141 respondents had sleep disturbance during the past month, 69.9% out of 141 respondents had sleep disturbance less than once a week, 16.3% out of 141 respondents had sleep disturbance once or twice a week and 0% out of 141 respondents had sleep disruption three times or more.

The component 6 shows that 83.6% out of 141 respondents have taken sleep medicine during past

month, 9.21% out of 141 took sleep medicine less than once a week, 6.38% out of 141 took sleep medicine once or twice a week and 0.70% out of 141 took sleep medicine three or more times a week. For component 7, 64.5% out of 141 respondents had trouble staying awake in the last month, 19.1% out of 141 respondents had trouble staying awake less than once a week, 12.7% out of 141 respondents had trouble staying awake less than once or twice a week and 3.5% out of 141 respondents had difficulty staying awake three or more days a week. Table 7.1 reveals that 51.0% out of 141 respondents had no issue at all in maintaining enthusiasm for doing things, 29.7% out of 141 respondents had only a very slight problem, 16.3% out of 141 respondents had somewhat of a problem and 2.8% out of 141 respondents had a very major problem.

**Table 1: Quality of Subjective sleep and Latency sleep**

Frequency (N)	Percentage	Sleep Quality Response	Component Score
46	32.6%	Very good	0
69	48.9%	Fairly good	1
19	13.4 %	Fairly bad	2
7	5%	Very bad	3
Frequency (N)	Percentage %	Time to fall asleep	Component score
43	30.4 %	≤ 15 minutes	0
60	42.5 %	16-30 minutes	1
20	14.1 %	31-60 minutes	2
18	12.7 %	>60 minutes	3

According to Table 1: 32.6% out of 141 respondents, sleep quality rate is very good, 48.9% out of 141 respondents sleep quality rate is fairly good, 13.4% out of 141 respondents sleep quality rate is fairly bad and 5 % out of 141 respondents sleep quality response, the percentage is very low.

30.4% out of 141 respondents take time to sleep at night in ≤ 15 minutes, 42.5% out of 141 respondents take time to sleep at night in 16 -30 minutes, 14.1% out of 141 respondents take time to sleep at night in 31-60 minutes, 12.7% out of 141 respondents take time to sleep at night in > 60 minutes.

**Table 2: Duration of sleep**

How many hours you have got to sleep at night during the last month?

Frequency	Percentage %	Sleep duration	Component score 3
62	43.9%	≥ 7 hours	0
68	48.3%	6-7 hours	1
8	5.6%	5-6 hours	2
3	2.1%	5 hours	3

**According to Table 2:** Among the 141 responses, 43.9% receive 7 hours among actual night-time sleep, 48.3% receive 6 to 7 hours of actual night-time sleep. Among the 141 responses, 5.6% receive 5 to 6 hours among real sleep at night and 2.1% receive 5 hours of actual night-time sleep.

**Table 3: Sleep efficiency**

Frequency (N)	Sleep efficiency	Component 4 score
101	>85%	0
15	75-84%	1
16	65-74%	2
9	<65%	3

According to **Table 3** sleep efficiency is calculated by using formula (hours slept ÷ hours in bed)×100

**Table 4: Sleep disorder and use of medication for sleep**

Frequency	Percentage	Sleep disturbance	Component 5 score
20	14.1%	Not during pass month	0
98	69.9%	Less than once in a week	1
23	16.3%	Twice or once a week	2
0	0	Three or more times per week	3
Frequency (N)	Percentage %	Use of medication for sleep	Component Score
118	83.6%	Not in the past month	0
13	9.21	Less than one week	1
9	6.38	Once or two times a week	2
1	0.7%	Three or more times per week	3

**According to Table 4:** 14.1% have sleep disturbance not during pass month, 69.9% out of have sleep disturbance less than once a week, 16.3% out of have sleep disturbance once or twice a week and 0% out have sleep disturbance have occurred three or more times per a week.

83.6% have taken sleep medicine not during past month, 9.21% have taken sleep medicine less than once a week, 6.38% have taken sleep medicine once or twice a week and 0.70% have taken sleep medicine three or more times per week.

**Table 5: Dysfunction on the day**

Frequency (N)	Percentage %	Over the past few month, how often have you had trouble staying awake while driving, eating, or socializing?	Score
91	64.5%	Not during the last month	0
27	19.1%	Less than one week	1
18	12.7%	Once or two times a week	2
5	3.5%	Three or more times per week	3

**According to Table 5:** 64.5% have trouble staying awake not during the past month, 19.1% have trouble staying awake less than once a week, 12.7% have trouble

staying awake once or two times a week and 3.5% have trouble staying up three or more times per week.

**Global PSQI Score: A total of seven components****Table 6**

Frequency (N)	Percentage %	Range (0-21)	Sleep Quality
76	53.90%	0-5	Healthy
56	39.71%	6-10	Mild
7	4.96%	11-15	Moderate
2	1.41%	16-20	Severe
0	0%	21-25	Worst

**According to the global PSQI score:** 53.90% have healthy sleep quality, 39.71% have mild sleep quality, 4.96% have moderate sleep quality and 1.41% have severe sleep quality.

**Result****Global PSQI Score: Sum of seven components:**

According to the global PSQI score 53.90% out of 141 respondents of college student have healthy sleep pattern, 39.71% have mild sleep pattern, 4.96% have moderate sleep pattern and 1.41% have severe sleep pattern.

**Discussion**

We investigated variation of the college students sleep pattern during lockdown in cross-sectional study. As expected, during lockdown college students sleep pattern may be changed. The information of the results must consider the limitations of the study mainly depend on self-reports regarding sleep schedule. The COVID-19 pandemic has created damaged millions of people to live under strict blackout conditions and people who go to bed and wake up late, spend more time in bed and record a poorer standard of sleep as well. Decreased sleep quality was stronger with high levels of depression, anxiety, and stress. Loss of sleep among college students poses a serious risk to academic performance, both physical and emotional health. For the study, a total of 141 college students were chosen, they were evaluated for the parameters of inclusion and exclusion criteria. College student sleep pattern is tested on the basis of the result of PSQI they were put under the five groups namely 1) Good Sleep quality, 2) Mild Sleep quality, 3) moderate Sleep quality, 4) Extreme Sleep quality, and 5) Worst Sleep quality.

In our study one questionnaire is used to determine the sleep pattern of college students during lockdown.

The questionnaire instruction analyzed the results. There are seven component scores in the scoring PSQI, each score 0 (no difficulty) to 3 (severe difficulty). Scores of the components are summed up to generate a global score (0 to 21) higher score mean poorer quality of sleep. Good and satisfied sleep is not only central to sound body health, but is also of primary importance to cognitive and social activities. Learning plays a significant part in learning and memory process for the students.

In our analysis we identified the characteristics of socio-demographic and lifestyle, nighttime behaviors and sleep habits and their results. Besides low sleep quality students also showed poor quality of sleep. Table 1 reveals that 32.6% out of 141 response of college have very good sleep pattern and 5% out of 141 responses have very disturbed sleep pattern. Poor sleep quality has been associated with negative moods reported to be significantly higher by themselves. Table 2 shows 42.5% out of 141 response of college student take 16 to 30-minute times to sleep at nights. 12.7% out of 141 response take more than 60 minutes to sleep at night so we should stick to the same sleep schedule and wake up time even on the weekends, so that it can help us sleep at right time. Comparing the previous study, we found that 43.9% had more than 7 hours of real night sleep and 16.3% had once or twice a week disrupted sleep. Sleep medicine is taken once or twice a week by 6.38% students.

According to this research we found global PSQI score is used to sum the seven components. In the current study, data shows that during lockdown majority of the college student had healthy sleep pattern (53.90%) range of the PSQI (0-5), 39.71% had mild sleep pattern range of the PSQI (6-10), 4.96% had moderate sleep pattern range of the PSQI (11-15) and 1.41% had severe sleep pattern range of the PSQI (16-20).

**Limitations of the study:**

- One of the limitations of this study is small sample size, study was of short duration, the interval between the age group is less and study is done on young healthy individuals only.
- Another drawback was that this analysis consisted of a one- time study, so it is difficult to determine the connection between sleep disturbance and poor sleep quality.

**Recommendations:**

- This analysis can be carried out on a larger sample size.
- The period of research can be longer.
- There may be variations in the age group used for study.

**Conclusion**

We assume there is need for more research into sleep cycle and their effect on the working. There should be a study of students with good sleep habits. Sleep requirements differ according to individual needs. Some need more than 7 hours of effective sleep, other may need as little as 5 hours of sleep. Further research can identify factors in lifestyle which promote good quality of sleep.

In the current study we found that during lockdown period most students had a healthy sleep pattern. Sleep disorder can have a huge effect on people lives. These findings support that there is no variation of sleep pattern during lockdown. Healthy sleep pattern decreases the anxiety, tension, depression and stress .

**Ethical Clearance:** Taken from University Ethical Committee

**Source of Funding:** Self

**Conflict of Interest:** Nil

**References**

1. Orsal O, Orsal O, Alparslan GB, Unsal A. Evaluation of the relation between quality of sleep and anxiety among university students. *HealthMED*. 2012 Jan 1;6(7):2244-55.
2. Ban DJ, Lee TJ. Sleep duration, subjective sleep disturbances and associated factors among university students in Korea. *Journal of Korean*

3. Heath AC, Eaves LJ, Kirk KM, Martin NG. Effects of lifestyle, personality, symptoms of anxiety and depression, and genetic predisposition on subjective sleep disturbance and sleep pattern. *Twin Research and Human Genetics*. 1998 Aug;1(4):176-88.
4. Singh R, Sharma R, Suri JC, Das S. Impact of sleep patterns on mood and academic performance of medical students. *Indian Journal of Sleep Medicine (IJSM)*. 2009;4(2).
5. Jenkins SM. Sleep habits and patterns of college students and their relationship to selected personality characteristics
6. MAHRAN DG, AHMED SM. Sleep Disorders among Female Students in Assiut University, Upper Egypt. *Med. J. Cairo Univ*. 2012;83(2):179-85.
7. Ishita M, Kuldeep S. Impact of Digital Media on Sleep Pattern Disturbance in Medical and Nursing students. *Science [ETEBMS-2016]*. 2016 Mar;5(6).
8. Kaur G, Sharma V, Singh A. Association of sleep quality with general health: an Indian college students’ study. *Int J Med Sci Public Health*. 2015 Dec 1;4(12):1767
9. Lowry M, Dean K, Manders K. The link between sleep quantity and academic performance for the college student. *Sentience*. 2010;3(2):16-9
10. Anjum A, Bajwa MA, Saeed R. SLEEP PATTERNS. *The Professional Medical Journal*. 2014;21(01):148-56.
11. World Health Organization. Mental health and psychosocial considerations during the COVID-19 outbreak, 18 March 2020. World Health Organization; 2020.
12. Altena E, Baglioni C, Espie CA, Ellis J, Gavrilloff D, Holzinger B, Schlarb A, Frase L, Jernelöv S, Riemann D. Dealing with sleep problems during home confinement due to the COVID-19 outbreak: practical recommendations from a task force of the European CBT-I Academy. *Journal of Sleep Research*. 2020 Apr 4.
13. Lund HG, Reider BD, Whiting AB, Prichard JR. Sleep patterns and predictors of disturbed sleep in a large population of college students. *Journal of adolescent health*. 2010 Feb 1;46(2):124-32.
14. Cellini N, Canale N, Mioni G, Costa S. Changes in sleep pattern, sense of time, and digital media use during COVID-19 lockdown in Italy. *Medical Science*. 2001 Aug; 16(4):475.

15. Saha S, Dutta T. A STUDY ON THE PSYCHOLOGICAL CRISIS DURING THE LOCKDOWN CAUSED DUE TO COVID-19 PANDEMIC.
16. Albhlal LA, Alanzi FG, Ghannam KB, Alqahtani A, Alenazi AQ, Alanazi MQ. Sleep Disturbance Patterns among Medical Students, Saudi Arabia. *Arch Med.* 2017;9:3.
17. Buboltz Jr WC, Brown F, Soper B. Sleep habits and patterns of college students: a preliminary study. *Journal of American college health.* 2001 Nov 1;50(3):131-5.

# Patient's Knowledge and Satisfaction with health Care of a Tertiary Care Hospital Situated in Rural area of Northern India (Haryana)

Manisha Rani<sup>1</sup>, Jyoti Phougat<sup>2</sup>, Manpreet Kaur<sup>3</sup>

<sup>1</sup>Former Assistant Professor, Pediatric Nursing Department, Maharishi Markandeshwar Institute of Nursing, Maharishi Markandeshwar (Deemed to be University), Mullana, Haryana, India (At Present: Nursing Officer Deputed as Nursing Tutor, Pediatric Nursing Department, Nursing College, All India Institute of Medical Sciences (AIIMS) Bhopal (M.P.), India), <sup>2</sup>Assistant Professor, Pediatric Nursing Department, M.M. Institute of Nursing, MMDU, Mullana, Haryana, India, <sup>3</sup>Assistant Professor, OBG Nursing Department, M.M. Institute of Nursing, MMDU, Mullana, Haryana, India

## Abstract

**Background:** Nowadays health care quality is a universal concern. The most appropriate method to measure a client's experiences about available hospital services is a patient satisfaction survey. Present study aimed to assess patient's knowledge and satisfaction regarding health care.

**Method:** 330 patients were selected by purposive sampling technique attending various outdoor and indoor departments of the selected hospital. Self-structured checklist and three-point rating scale each containing a total 50 sets of items used to assess knowledge and satisfaction. The reliability coefficient for the knowledge tool was 0.87 by KR 20 and satisfaction was found 0.85 by Cronbach's Alpha.

**Result:** Study results showed that more than half (52.4%) and (60.6%) patients had very good level of knowledge and 76.4% & 67.5% of patients were satisfied with overall health care. Item wise distribution of satisfaction among patients reveals that "physician gave follow up instructions to the patient properly (78.2%)", "OPD card facility (78.2%)" and "hospital food facility for patients (75.2%)" was found ranked 1<sup>st</sup> with the highest satisfaction, whereas "Free of cost availability of drugs", "long queues during OPD card registration process" was found ranked lowest. A significant low positive correlation found between mean knowledge and satisfaction scores regarding health care services as evident by computed 'r' value (0.38).

**Conclusion:** Using these necessary responses from the patients, various shortcomings can be pointed out and notify to hospital administration for improvement of the health care.

**Keywords:** Knowledge, satisfaction, Health care, Tertiary care hospital.

## Introduction

Satisfaction, like quality, is multifaceted construct<sup>20</sup>. Satisfaction of clients premised on multifarious strands

### Corresponding Author:

**Ms. Manisha Rani**

Address for Correspondence: Ms. Manisha Rani, Nursing Officer Deputed as Nursing Tutor, Pediatric Nursing Department, Nursing College, AIIMS Bhopal, Madhya Pradesh, India. PIN – 462020  
e-mail: manisharani.nursing@aiimsbhopal.edu.in  
Contact No. +91 9416429127

in a health care organization. Client's expectancy and his perception with health care and services are directly congruent<sup>21</sup>. Among all the method, assessment of client's satisfaction is the vital for the evaluation of Excellencies in a health care organization. It is important to assess the satisfaction rate of the services which will evaluate whether the services are useful or not<sup>22</sup>. In the recent epoch, many dimensions together with behaviour of employees, patient staff interaction along with administration issues of the hospital and diagnostic services are crucial aspects of patient satisfaction<sup>23</sup>. A happy patient has higher adherence to treatment

protocols and goes for routine follow up for his ill health<sup>24</sup>. Pragmatic evidences confirm that majority of health care organizations in India are measly involved in the assessment of satisfaction rate. The long queues in the OPD areas, little and unkempt waiting areas, poor condition of bathrooms, unsympathetic approach of health care workers bear articulate testimony to the current fact. Entire considerations make the assessment of patient's satisfaction with health system even highly necessary<sup>25</sup>. In recent years, patients have become a lot conscious to their rights and cognizant regarding their health. They demand best health care in each facet. Patient's feels unsatisfied when services received by them are not according to their expectations<sup>26</sup>. Developed countries have many research studies and literatures on satisfaction of patients with health care services but this number is very less in case of developing countries including India. Satisfaction assessment will offer valuable and exclusive insights into routine health care in hospital. It is broadly accepted as an autonomous dimension of quality of care as analysis of patient satisfaction includes "internal" (inward-looking) aspects of hospitalization, which frequently stay unrecorded, like communication, warmth or interaction<sup>7</sup>. Satisfaction of patient regarding health care facility situated in a rural area is of vital significance for providing quality services to patients, so keeping this point in consideration; the present research study was conducted to assess patient's knowledge and satisfaction with health care of a tertiary care hospital situated in a rural area of Northern India (Haryana).

## Material and Method

**Study Design and Study Area:** This was a cross-sectional study based on a descriptive survey design conducted in a tertiary care center situated in the rural area of northern India. The hospital is a center for undergraduate and postgraduate medical teaching and has an operational strength of 940 beds. Patients are mainly seen in the Outpatient Department casualty unit and special clinics. It receives patients from within Haryana, and the neighboring states of India (Uttar Pradesh, Himachal, Punjab, and Chandigarh). The majority of patients are indigenous Hindu, although the Muslim and Sikh ethnic groups also constitute a substantial proportion of the clientele. Clients with various occupational backgrounds like farmers, private, and govt. service holders, businessmen, etc get the benefit of services present over here.

Written informed consent was obtained from all the participants before starting the study. Data for the study was collected from clients in OPD (Out Patient Department) and IPDs i.e. admitted in medicine, surgery, orthopedics, neurosurgery, and gynecology ward of MMIMS & R hospital Mullana, Ambala, Haryana.

**Sample Size and Sampling Technique:** Using a Non-probability Purposive sampling technique a sample size of 330 was taken to detect the knowledge and satisfaction among the study participants regarding health care. However, patients referred or advised for or admitted to the Intensive care unit/cardiac care unit/emergency with conditions related to psychiatry or maternity, and those with critical health issues were excluded.

**Tools and Technique of Data Collection:** A structured knowledge checklist and rating scale were prepared to assess the knowledge and satisfaction regarding health care among outdoor and indoor patients. Both tool consisted of 50 items each divided into 2 parts according to areas of hospital services-physician services and basic services i.e OPD services, Diagnostic services, Admission & discharge services, Laundry and food services, Drug availability and administration.

In knowledge tool each item consist maximum 1 score and minimum score 0. The score obtained by the indoor patient were arbitrarily categorized into four levels- Very good (>75%), Good (61-75%), Average (50-60%), Poor (<50%).

Rating scale for level of satisfaction had a score of 3 point i.e., satisfied score as 3, partially satisfied as 2, dissatisfied as 1. The score obtained by the indoor patient were arbitrarily categorized into three levels -: Satisfied (>75%), partially satisfied (50-75%), Dissatisfied (<50%).

Reliability of the structured knowledge checklist and Rating scale was computed using Kuder Richardson 20 (KR-20) and Cronbach alpha method which was found 0.83 and 0.80 respectively. The tool was found valid, reliable, and feasible for the purpose of the study. Both tools were validated by 8 experts in the various nursing fields. An interview technique was used to collect the data of the present study.

Statistical analysis Collected data were entered into Microsoft Excel software and data cleansing was performed. Data were analyzed using SPSS

IBM Statistics version 20. Descriptive statistics were generated using mean, standard deviation (SD), frequency, and percentages. Analytical statistics like correlation coefficient and Chi-square test was used to see correlation and association. The value of  $P < 0.05$  was considered statistically significant.

## Results

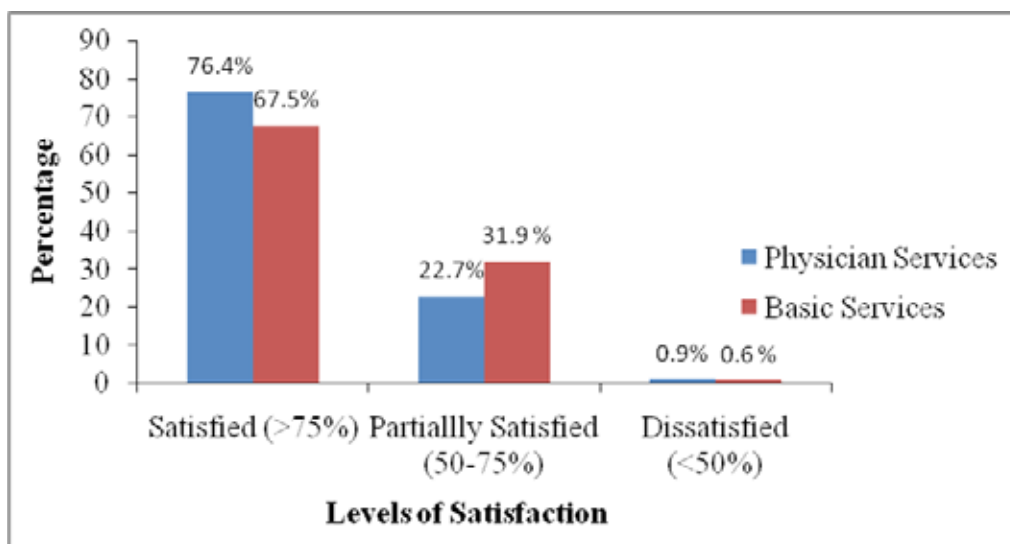
**Description of sample characteristics:** Frequency and percentage distribution was computed to describe the sample characteristics of the sample. The baseline sample characteristics of the participants showed that 47.9% patients were females and 52.1% were males and as regard to the religion 61.4%, 26.7% patients was Hindu and Muslim respectively, 11.6% was Sikh, and 0.3% belong to Christian religion.

Less than half, (35.2%) patients were having education upto primary school and, (3.6%) were having senior secondary education. Family income of 46.1% patients was Rs <5000 and only 5.5% were having Rs >20,001 & above per month. More than half patients (51.5%) were from joint family, and other 48.2% were from nuclear family. As regard to previous hospitalization 52.1% were admitted previously in hospital and 47.9% were not admitted previously and as regard to the type of

hospital 32.4% admitted in private hospitals previously and 19.7% admitted in government hospitals. More than half (68.8%) have less than 2 visits in hospital previously and, 3.9% has more than 4 visits. Nearly half number of patients, (42.4%) had 1-4 days length of stay and, 9.7% had more than 12 days length of stay in the hospital.

**Area wise frequency and percentage of levels of knowledge among indoor patients regarding health care services:** More than half (52.4%) & (60.6%) patients were having very good level of knowledge and 7.2% & 6% were with below average knowledge regarding availability of physician services and basic services i.e OPD services, Diagnostic services, Admission & discharge services, Laundry and food services, Drug availability and administration respectively.

**Frequency and percentage of level of satisfaction regarding Physician services, and basic services:** - Findings shows that more than half (76.4%) (67.5%) patients were satisfied with physician services and basic services (OPD services, Diagnostic services, Admission & discharge services, Laundry and food services, Drug availability and administration) of hospital respectively. (as shown in figure 1).



**Figure 1: Bar Graph Showing the Percentage of Level of Satisfaction among Indoor Patients Regarding Physician Services and Basic Services**

**Item wise distribution of level of satisfaction among patients regarding physician services:** Results reveal the frequency, percentage and rank order of level of satisfaction regarding various physician services.

Among these, “gave follow up instructions to the patient properly” was found 78.2% ranked 1<sup>st</sup>, “favoured patients over other.” was found 50.6% ranked lowest as shown in table no. 1



**Table No. 1: Item Wise Distribution of Level of Satisfaction among Patients Regarding Physician Services  
N=330**

Items	Satisfied (3)		Partially satisfied (2)		Dissatisfied (1)		Rank
	F	%	f	%	f	%	
<b>During this hospital stay, doctors/health providers</b>							
Hear you carefully	241	73	64	19.4	25	7.6	III
Treat you with respect and courtesy	245	74.2	72	21.8	13	3.9	II
Explain you things in a way you can understand.	235	71.2	72	21.8	23	7	IV
Explain procedure before doing it	231	70	72	21.8	27	8.2	V
Response to queries	224	67.9	75	22.7	31	9.4	VII
Provide aftercare instruction	220	66.7	85	25.8	25	7.6	X
Maintained personal privacy	218	66.1	69	20.9	43	13	XI
Comforted during physician care.	211	63.9	88	26.7	31	9.4	XIII
Discussed care option with you.	212	64.2	81	24.5	37	11.2	XII
Encouraged you to involve in one's own care plan	201	60.9	85	25.8	44	13.3	XV
Favoured patients over other.	167	50.6	82	24.8	81	24.5	XVII
Recognize patients need	208	63	82	24.8	40	12.1	XIV
Show attention and responsiveness to needs.	221	67	77	23.3	32	9.7	IX
Have helpful attitude	223	67.6	93	28.2	14	4.2	VIII
Easily provide information	190	57.6	103	31.2	37	11.2	XVI
Show professionalism	223	67.6	75	22.7	32	9.7	VIII
Have skill and competence	225	68.2	84	25.5	21	6.4	VI
Explain patient's condition to family.	245	74.2	67	20.3	18	5.5	II
Gave follow up instructions to the patient	209	78.2	48	14.5	24	7.3	I

**Item wise distribution of level of satisfaction among patients regarding basic services:** Findings reveal the frequency, percentage and rank order of level

of satisfaction regarding basic services which further include OPD services, Diagnostic services, Admission and discharge services.(as shown in table no. 2,3,4).

**Table No. 2: Item Wise Distribution of Level of Satisfaction among Patients Regarding Provision of OPD Services N=330**

Items	Satisfied (3)		Partially satisfied (2)		Dissatisfied (1)		Rank
	f	%	f	%	f	%	
Facility of OPD card	258	78.2	48	14.5	24	7.3	I
Proper management of patient gathering during OPD card registration process	183	55.5	87	26.4	60	18.2	IX
Enquiry services in OPD	228	69.1	69	20.9	33	10	IV
Availability of doctors during OPD hours	218	66.1	81	24.5	31	9.4	V
Attending the patient on time	235	71.2	60	18.2	35	10.6	III
Listening the problem told by patient	214	64.8	75	22.7	41	12.4	VI
Waiting area with sitting arrangements in OPD area	213	64.5	63	19.1	54	16.4	VII
Shifting of patient to indoor department for admission.	183	55.5	106	32.1	41	12.4	IX

Items	Satisfied (3)		Partially satisfied (2)		Dissatisfied (1)		Rank
	f	%	f	%	f	%	
Availability of safe drinking water	141	42.7	109	33	80	24.2	X
Availability cleanliness of toilets	106	32.1	108	32.7	116	35.2	XI
Availability of lift service	228	69.1	74	22.4	28	8.5	IV
Availability of wheel chair/comfort device while shifting	207	62.7	76	23	47	14.2	VIII
Availability of sign boards direction.	240	72.7	66	20	24	7.3	II

**Table No. 3: Item Wise Distribution of Level of Satisfaction among Patients Regarding Provision of Diagnostic Services N=330**

Items	Satisfied(3)		Partially satisfied (2)		Dissatisfied (1)		Rank
	f	%	f	%	f	%	
Sample collection in Laboratory	26	79.1	50	15.2	19	5.8	I
X Ray, ultrasound and others radio diagnosis	252	76.4	59	17.9	19	5.8	II
Waiting area with sitting arrangements	227	68.8	67	20.3	36	10.9	IV
Proper instruction while undergoing for any diagnostic procedure.	241	73	66	20	23	7	III

**Table No. 4: Item Wise Distribution of Level of Satisfaction among Patients Regarding Provision of Admission Discharge Services N=330**

Items	Satisfied(3)		Partially satisfied (2)		Dissatisfied (1)		Rank
	f	%	f	%	f	%	
Explanation of reason for admission	190	57.6	104	31.5	36	16.9	VII
Cooperative behaviour of admitting staff	190	57.6	104	31.5	36	10.9	VII
Information provided about billing process	206	62.4	91	27.6	33	10	VI
Proper facility for shifting in patient department.	222	67.3	78	23.6	30	9.1	I
Well-arranged bed/area for admission	208	63	72	21.8	50	15.2	V
Orientation to ward and ward staff on duty	187	56.7	74	22.4	69	20.9	VIII
Response to queries regarding disease, patient condition	216	65.3	75	22.7	39	11.8	IV
Availability of visiting hours for patient attendant/ family.	218	66.1	75	22.7	37	11.2	II
Clear and understandable instructions about medication during discharge	217	65.8	71	21.5	42	12.7	III

**Item wise distribution of satisfaction among patients regarding Laundry & food services and Drug availability and administration:** Frequency, percentage and rank order of satisfaction regarding Laundry and food services reveals that satisfaction for “Hospital food facility for patients (75.2%), Availability of clean bed sheets, Pillow and Blanket ranked (60%) ranked first and 2<sup>nd</sup> respectively whereas “Availability of laundry for washing personal clothing (33.4%)”

ranked lowest as hospital is not having laundry facility for washing personal clothing.

For Drug availability and administration, item wise distribution of satisfaction revealed that Patients were highly satisfied with “Administration of drug on right patient at right time (69.1%)” whereas “Free of cost availability of drugs (16.7%)” found at lowest rank.

A significant low positive correlation was found between mean knowledge and satisfaction scores of indoor patients regarding nursing services and physical infrastructure as evident by computed 'r' value of (0.38).

**Chi square value showing the association of knowledge score regarding availability of health care services of hospital with selected sample characteristics:** Results of Chi square association indicates that type of family (10.47) and present medical conditions (5.99) was found statically significant at 0.05 level which indicate that rate of scoring of knowledge was dependent on type of family and present medical condition, as most of the patient who belonged to joint family have more level of knowledge as they received information from family members and their relatives and the patient with acute illness were more oriented and able to receive information regarding available health care services.

The finding also revealed age, gender, religion, marital status, education, occupation, family income per month, number of visits, previous hospitalization was found statistically non significant at 0.05 level.

**Chi square value showing the association of satisfaction score regarding availability of health care services with selected sample characteristics:** A chi square association with level of satisfaction indicates that Religion (20.96), occupation (9.79), and type of hospital (6.48) were found statistically significant at 0.05 levels which indicate that satisfaction was dependent on religion, occupation and type of hospital previously admitted. The findings also revealed that age, gender, type of family, marital status, education, family income per month, number of visits, previous hospitalization was found statistically non significant at 0.05 level.

## Discussion

Results of our study shows that 76.4% patients have overall satisfaction regarding physician services. Among these, "gave follow up instructions to the patient properly" was found 78.2% ranked 1<sup>st</sup>, these results were found to be consistent with the study conducted by Kumari R to determine the areas and causes of low satisfaction among the patients and suggest method for improvement. Result shows that the overall satisfaction regarding the doctor-patient communication was more than 60% at health care facilities but for examination and consultation by physician was less than 60%<sup>27</sup>

Findings of our study revealed that satisfaction for "listening the problem told by patient" was found 64.8%, more than half patients (64.5%) were satisfied with waiting area with sitting arrangements in OPD area where as very less patients were satisfied with cleanliness of toilets(33.5%), These results were found to be consistent with the study conducted by Anteneh Asefa(2014) reveals that according to 71% patients, health care providers were very polite with patients, 64% said that there was convenient environment to ask question/s, 66% were satisfied with comfort of waiting area<sup>28</sup>. Study result also coincide with another study conducted by Kumari R, according to this less than half patients were satisfied with availability (44.7%) and cleanliness of the toilets (31.3%), for availability of seats in waiting area satisfaction rate was high(81.4%)<sup>8</sup>

Findings of our study further revealed that more than half (79.1%) patients were satisfied with Sample collection in Laboratory, according to 57.6% patients, admission process was satisfactory. Hospital food facility was satisfactory for 75.2% patients. 69.1% found "Administration of drug on right patient at right time" process acceptable. These results were found to be consistent with the study conducted by Bishwalata R (2020), findings reveals that (51.7%) found the waiting time and admission procedures acceptable, around 55.7% patients said that they always received medication in a timely manner. For 37.2% of the patients, all scheduled investigations were not done in the hospital. (24.9%) expressed dissatisfaction with the quality of the food served.<sup>29</sup>

**Ethical Clearance:** Taken from Maharishi Markandeshwar University institutional ethical committee.

## References

1. Maxwell RJ. Quality assessment in health. Br Med J (Clin Res Ed). 1984. 288:1470-72.
2. Haddad S, Fournier P, Machouf N, Yatara F. What does quality mean to lay people? Community perceptions of primary health care services in Guinea. Soc Sci Med. 1998. 47: 381-94.
3. Kumari Priyanka, Neetu, Rani Manisha. Satisfaction of women regarding availability of maternal and child health services in community health centre, ambala haryana, India. World Journal of Pharmacy and Pharmaceutical Sciences. 2017; 6: 962-70
4. Rapert MI, Babakus E. Linking quality and

- performance. Quality orientation can be a competitive strategy for health care providers. *J Health Care Mark.* 1996; 16:39-43.
5. Gombeski WR Jr, Miller PJ, Hahn JH, Gillette CM, Belinson JL, et al. Patient callback program: a quality improvement, customer service, and marketing tool. *J Health Care Mark.* 1993; 13:60-5.
  6. McKinley RK, Roberts C. Patient satisfaction with out of hours primary medical care. *Qual Health Care.* 2001; 10: 23-28
  7. Al-Emadi N, Falamarzi S, Al-Kuwari MG. Patients' satisfaction with primary health care services in Qatar. *Middle East J. Fam. Med.* 2009; 7: 4-9
  8. Kumari R, Idris MZ, Bhushan V, Khanna A, Agarwal M, Singh SK. Study on Patient Satisfaction in the Government Allopathic Health Facilities of Lucknow District, India. *Indian J Community Med.* Jan 2009; 34(1): 35–42. doi: 10.4103/0970-0218.45372: 10.4103/0970-0218.45372
  9. Anteneh Asefa<sup>1</sup>, Andargachew Kassa, Muluken Dessalegn. Patient satisfaction with outpatient health services in Hawassa University Teaching Hospital Southern Ethiopia. *Journal of Public Health and Epidemiology.* February 2014; Vol. 6(2): 101-110. doi: 10.5897/JPHE2013.0613
  10. Rajkumari B, Nula P. Patient's satisfaction with care in a government health facility in North East India: A cross-sectional study. *J Med Soc* 2017; 31:94-8.

# Stress in Working Women Due to Lockdown: A Cross Sectional Survey

Manjeet Singh<sup>1</sup>, Rabab Kaur<sup>2</sup>

<sup>1</sup>Student, Galgotias University, <sup>2</sup>Assistant Professor, Galgotias University, Plot No. 2, Yamuna Expy, Opposite, Buddha International Circuit, Sector 17A, Greater Noida, Uttar Pradesh 203201

## Abstract

**Background and Purpose:** Due to the vast spread of coronavirus, the lockdown has been announced in many countries, and hence many people are facing psychological, physical, economic and social issues. It has targeted all the population but this study focuses on the increased amount of perceived stress on women who are undergoing work from home pattern of occupation.

**Methodology:** Sample comprised of 110 working women. The structured questionnaire, Perceived Stress Questionnaire, was circulated through online google forms. Along with stress, demographic sheet was used to study stress in working women due to lock down.

**Result:** The outcome, view of the respondents based on feeling of anxiety of working ladies was classified into 3 categories (Mild, Moderate, Severe) and range. 7 persons of respondents are in 0.01 - 0.40 range i.e. 6.36%, 101 persons of respondents are in 0.40 – 0.70 range i.e. 91.81%, 2 persons of respondents are in 0.70 – 1.00 range i.e. 1.81%.

**Conclusion:** In this investigation we found that a large population of the females are under moderate pressure and are overstressed while carrying out work from home.

**Keywords:** Stress, PSQ (Perceived Stress Questionnaire), COVID 19, Lockdown, coronavirus.

## Introduction

‘Stress’ word has been subordinate from material science and mechanics where it is particularly portrayed as physical weight applied upon, and between different bits of body, when bending occurs as conclusive item it is called strain.<sup>1</sup> Stress is a disagreeable and widespread experience which influences every one of us in various manners and at various occasions in the present supercharged working environment. Ladies are additionally almost certain than men to be unfavorably influenced by mental clutters. Employment stress is characterized as the hurtful enthusiastic and physical reaction which happens because of prerequisites of the activity don't coordinate the abilities, assets, or requirements of the laborer. It is extensive proof that the worry because of double job of ladies at a work spot and home and that innate in contrarily impacts their personal satisfaction.<sup>2</sup>

After freedom, ladies in India have made some

amazing progress. From only a master homemaker/housewife, she not just has gained aptitudes and capacities to being an ideal housewife however being at same level with their companion or life accomplice. Presently, ladies need to catch up their fantasy vocation and this is the new proliferation of working ladies.<sup>3,1</sup> The Industrial Revolution to some degree was fuelled by the financial need of numerous ladies, single and wedded, they are found pursued work outside their home. Generally, ladies secured positions in local assistance, piece workshops, and material manufacturing plants. They are likewise worked in the coal mineshafts. For a few, the Industrial Revolution gave free wages, portability and a superior way of life.<sup>4</sup> In India, post globalization, there is unmistakable changes in perspectives of ladies and the general public's viewpoint towards them. In the course of recent decades that has been a continuous acknowledgment of work jobs in ladies. Over the globe, ladies are venturing out of the security of their homes to confront difficulties of more up to date sorts.<sup>5</sup> Along

these lines doing obligations and duties both at home and working environment overstrains a wedded working lady, in this manner prompting different mental issues like job struggle, work strain, mental weariness, stress, uneasiness, disappointment, sadness, outrage, fears, and other social and passionate pain. These issues can intelligently influence the psychological prosperity of working ladies and all the more so in wedded working ladies.<sup>6</sup>

Lockdown, a term routinely utilized as proxy for “mass isolate”, is normally founded on “stay-at-home” or “safe house set up” laws given by an open (either national or provincial) government or authority, for forcing social removing and subsequently constraining or totally canceling the development of the populace inside and outside a particular zone. It is consequently generally utilized with respect to balancing a progressing episode, ordering occupants to remain inside their homes, aside from doing basic exercises (wellbeing visits, keeping an eye on a helpless individual, buying prescriptions, food and drinks) or giving basic work (for example medicinal services and social consideration areas, police and military, firefighting, water and power flexibly, basic assembling). Other insignificant exercises are thus halted or done from home.<sup>7</sup> In a male driven culture like India it is as yet acknowledged that a man is the fundamental supplier of his family. But Indian women have started working outside their home yet simultaneously they have far to go both socially, socially and fiscally, to get productive attitudinal changes in the mindset of people.<sup>8</sup> Anxiety, stress and oppressive indications are normal in a combination of mental states (Kvaal et al. 2005). In connection with men, women are will undoubtedly make strain issue over their future (Bruce et al. 2012; Mclean and Hofmann 2012). According to the US National comorbidity review, the lifetime inescapability rates for any apprehension issue were 19.2% for men and 30.5% for women (Mclean and Hofmann 2012).<sup>9</sup> The conventional arrangement of male prevalence or male overwhelmed cultural set up makes various difficulties ladies at their work place. It is an inborn conviction that ladies’ work capacity and productivity is lesser than men. The youthful female age has changed the intrinsic male centric structure on ladies in the general public that was getting common until the finish of the twentieth century in India.<sup>10</sup> We conjectured that more significant levels of pressure and more manifestations of wretchedness or tension would be related with expanded normal cortisol levels and a

smoothed diurnal cortisol design.<sup>11</sup> At the point when everything is said in done, women are practically sure than men to experience physical appearances of worry, for instance, shortcoming, instability, cerebral agonies, and wretchedness. Women are furthermore more likely than men to adjust to work stress with bothersome practices, for instance, helpless dietary examples.<sup>12</sup> A significant issue in exploring the pressure issue connection is the contiguity between upsetting occasions and turmoil.<sup>13</sup> The lockdown – in full power as we compose – limits 1.3 billion individuals from leaving their homes. Transport administrations are suspended, instructive organizations are shut, and manufacturing plants are closed down. This is in accordance with the measures forced in most European nations and in the United States, however the sheer size of the measure – as on account of most approaches in India – is threatening.<sup>14</sup>

## Methodology

This chapter discussed the process used for the analysis which provides explanation of the topics used in data collection and analysis. A Cross- Sectional Survey was carried out. Sample size of 110 working females were taken. The data has been collected through structured questionnaire using online google form by working women. Stratified random sampling method.

### Inclusion Criteria:

1. Gender - Females
2. Age – 25 to 60 years
3. Able to understand English

### Exclusion Criteria:

1. Pregnant women
2. People who have difficulty in understanding English or other communication issues
3. The population having any neurological issues

**Data Analysis:** The essential information was gathered by conveying a poll among the working ladies by means of google structure, the individuals who are adhered at home because of lockdown in India. The investigation was led between April-May 2020. Information were gathered by various angles identified with the work environment, factors adding to pressure, indications and outcomes of stress and diverse adapting methodologies received by working ladies to manage pressure.<sup>1</sup>

**Understanding of Data:** The understanding of the information was investigated through rate as information has been accumulated from 110 respondents. It was done in the accompanying way:

**Table 1** Age assumes a significant job in worry among working ladies. The age of the respondents is arranged into three classifications. Table 4.1 shows that out of 110 respondents, 81% are in the age gathering of 30-40, 14.4% are in the age gathering of 40-50, 4.5% are in the age gathering of 50-60.

**Table 1: Age group of females**

Age	No. of Respondents	Percentage (in %)
25-40	89	81
40-50	16	14.4
50-60	5	4.5
<b>Total</b>	<b>110</b>	<b>99.9</b>

**Table 2: Mental and physiological side effects of worry among working ladies in Lockdown**

Total	Stress Symptoms	Almost	Sometimes	Often	Usually
110	You feel rested	15	75	17	3
110	You feel you are doing things you really like	24	38	45	3
110	You feel calm	32	48	26	4
110	You are full of energy	17	48	39	6
110	You feel safe and protected	19	46	31	14
110	You enjoy yourself	18	42	39	11
110	You are lighthearted	11	55	35	9
110	You have enough time for yourself	13	52	36	9

**Table 2** shows the consequence of information gathered from 110 respondents based on mental and physiological manifestations of worry among working ladies. 13.63% respondents said that they feel rested because of stress, while 68.18% said that occasionally and 15.45% feel regularly and 2.72% normally. 3.63% respondents said that they typically feel issue of quiet.

**Table 4: Stress Level of Working Women**

Description	Range	Person	Percentage (in %)
Mild	0.01-0.40	7	6.36
Moderate	0.40-0.70	101	91.81
Severe	0.70-1.00	0	1.81
<b>Total</b>		<b>110</b>	<b>99.9</b>

**Table 3: Qualification of women**

Qualification	Number of women	Percentage (in %)
Teacher	45	40.9
Engineer	18	16.3
Private limited company	30	27.2
Other service(s)	17	15.4
Total	110	100

**Table 3** shows the view of the respondents based on their capability. It is characterized into 4 classes. 40.9% of respondents are instructors, 16.3% of respondents are engineer, 27.2% of respondents are private constrained organization and rest 15.4% have other expert help.

**Table 4** shows the outcome, view of the respondents based on anxiety of working ladies. It is arranged into 3 classes (Mild, Moderate, Severe) and go. 7 man of respondents are in 0.01 - 0.40 territory and 6.36%, 101 man of respondents are in 0.40 – 0.70 territory and 91.81%, 2 man of respondents are in 0.70 – 1.00 territory and 1.81%.

**Discussion**

In the current investigation, while the privately settled working women uncovered more satisfaction than working women, the past scored lower on certainty (both saw and socially observed), which shows that working from home could be both liberating and restricting. Though privately arranged working ensured versatility,

it impacted the women's needs to develop themselves full-time into their callings, harden their financial self-rule and not wait behind their companions, which were as strong as that of their working accomplices (Rani, 1976). It was found that family stress, family difficulty, and work-family work over-trouble can transform into a grave issue for the working woman and can have a negative impact upon her general prosperity, work execution, and occupation satisfaction.<sup>4</sup> An investigation on data innovation area working ladies which utilized authoritative job pressure scale detailed higher feeling of anxiety as the age expanded, a finding rather than our examination. To restrict the apprehension issue, there should be a fine agreement between the quality and whole of information one needs to extend. Information from unconfirmed sources and web-based life stages make sure to cause furious and make you annoyed. Obliging on the web life use can in like manner be a guide to our mind and enthusiastic health.<sup>19</sup> This examination shows that high paces of depression, anxiety, insomnia and perceived pressure, with young ladies having higher chances of embracing a psychological well-being result. These results were related with various COVID-19-related hazard factors, including being under isolate, having a friend or family member perished by COVID-19, the working movement stopped because of lockdown gauges, or encountering other upsetting occasions (for example working, budgetary, relationship or lodging issues) because of the pandemic or lockdown measures.<sup>20</sup>

#### **Limitations of the study:**

1. Small sample size
2. Study was for a short span of time
3. The study was only a one-time survey

#### **Recommendations:**

1. This study can be performed on a larger sample size
2. The duration of the study can be longer

### **Conclusion**

Work related pressure is a major task for working ladies in the lockdown. As quantities of working ladies are expanding in training area, they need to manage difficulties like long working hours, job challenges, lack of oversight, poor relationship with partners, remaining task at hand, role struggle, lack of chance for development and progression and occupation disappointment. Also, it isn't just critical to distinguish

reasons of pressure and to bargain with them however to empower solid work and diminished dangerous parts of work. Instructive establishments need to consider the requests of adjusting worry among working ladies to make nature increasingly steady, which will be useful to hold gifted, able and experienced working ladies. The board must work for preparing and instructing, coaching, consistent picking up, directing, open doors for profession improvement, procedures of time the board to deal with their outstanding task at hand at home along with work spot to inspire them to take higher duties. The fundamental discoveries of the study show that all the respondents have trouble because of individual and hierarchical sources. Dealing with the everyday home exercises, kid care and caring for the family individuals are the central point which cause trouble among the working school ladies.<sup>1</sup>

**Ethical Clearance:** Taken from University Ethical Committee.

**Source of Funding:** Self

**Conflict of Interest:** Nil

### **References**

1. Sharma B, Nair M. A qualitative study on causes and effects of stress among working women in management colleges in Jaipur. *International Journal of Current Advanced Research*. 2015;(152).
2. MAMTA PARASHARA, MITASHA SINGHA,\*, JUGAL KISHOREB, RAMBHA PATHAKA, MEELY PANDA. Prevalence and correlates of stress among working women of a tertiary health center in Delhi, India (FEBRUARY 2017) (1)
3. PROF. PARUL TRIPATHI\*; PROF. SANDEEP BHATTACHARJEE\*\* A STUDY ON PSYCHOLOGICAL STRESS OF WORKING WOMEN Vol.2 Issue 2, February 2012, ISSN 2231 5780 (434(1))
4. MALAVIKA DESAI, BISHAKHA MAJUMDAR, TANUSREE CHAKRABORTY, KAMALIKA GHOSH Working women in INDIA, <https://doi.org/10.1108/17542411111164920> (2011) (432)
5. Panigrahi A, Padhy AP, Panigrahi M. Mental health status among married working women residing in Bhubaneswar City, India: a psychosocial survey. *BioMed research international*. 2014;2014.
6. PRIYANKA PULLA, Covid-19: India imposes lockdown for 21 days and cases rise, *BMJ*



- 2020;368:m1251 doi: 10.1136/bmj.m1251 (Published 26 March 2020) (1)
7. Lippi G, Henry BM, Bovo C, Sanchis-Gomar F. Health risks and potential remedies during prolonged lockdowns for coronavirus disease 2019 (COVID-19). *Diagnosis*. 2020 May 26;7(2):85-90..
  8. Kumari V. Problems and challenges faced by urban working women in India (Doctoral dissertation). 2014 (8)
  9. Patel PA, Patel PP, Khadilkar AV, Chiplonkar SA, Patel AD. Impact of occupation on stress and anxiety among Indian women. *Women & health*. 2017 March (2)
  10. Pratheep S, Dharmaraj A. An empirical study on stress levels among working women in export oriented units of Tirupur district. *Man In India*. 2016 (3079)
  11. Kurina LM, Schneider B, Waite LJ. Stress, symptoms of depression and anxiety, and cortisol patterns in working parents. *Stress and Health: Journal of the International Society for the Investigation of Stress*. 2004 Apr;20(54).
  12. Kermene MM. A psychological study on stress among employed women and housewives and its management through progressive muscular relaxation technique (PMRT) and mindfulness breathing. *J PsycholPsychother*. 2016 Jan (1).
  13. Brantley PJ, Dietz LS, McKnight GT, Jones GN, Tulley R. Convergence between the Daily Stress Inventory and endocrine measures of stress. *Journal of consulting and clinical psychology*. 1988 Aug; (549).
  14. World Health Organization. Mental health and psychosocial considerations during the COVID-19 outbreak, 18 March 2020. World Health Organization; 2020
  15. Lu J. A New, Simple Projection Model for COVID-19 Pandemic. *medRxiv*. 2020 Jan 1.
  16. Bakshi P, Kochhar V. A Study and Evaluation of Stress Role on Faculty: An Analysis of Professional Institutions in Haryana. *International Journal of Research in IT & Management*. 2012;2(6):71-9.
  17. Patel PA, Patel PP, Khadilkar AV, Chiplonkar SA, Patel AD. Impact of occupation on stress and anxiety among Indian women. *Women Health*. 2017;57(3):392-401. doi:10.1080/03630242.2016.1164273
  18. Melchior M, Caspi A, Milne BJ, Danese A, Poulton R, Moffitt TE. Work stress precipitates depression and anxiety in young, working women and men. *Psychological medicine*. 2007 Aug.
  19. Patnaik NM, Maji S. Psychological Issues and Stress on People in the Purview of COVID-19 Pandemic Lockdown. 2020 May (39)
  20. Rossi R, Succi V, Talevi D, Mensi S, Niolu C, Pacitti F, Di Marco A, Rossi A, Siracusano A, Di Lorenzo G. COVID-19 pandemic and lockdown measures impact on mental health among the general population in Italy. An N= 18147 web-based survey. *medRxiv*. 2020 Jan 1.

# Integration of Health Education and Cultural Value of Bimanesse Called “Maja Labo Dahu” toward the Intention to Stop Smoking of Smoker Student at Bima District-Indonesia

Martiningsih<sup>1</sup>, Nurul Inayati<sup>2</sup>, Rini Hendari<sup>1</sup>, Ade Wulandari<sup>1</sup>

<sup>1</sup>Mater of Science Nursing, Department of Medical Surgery Nursing Department, Mataram Health Polytechnic (Poltekkes Mataram), Bima 84112, West Nusa Tenggara-Indonesia, <sup>2</sup>Master of Health Analyst, Mataram Health Politechnic (Poltekkes Mataram), Mataram 83232, West Nusa Tenggara-Indonesia

## Abstract

Socio-cultural elements may affect someone to follow or leave a behavior. Cultural values in the Bima District-West Nusa Tenggara Province community that are in line with health behavior are the cultural values called “Maja Labo Dahu/MLD”, “Maja” means self-aware and “dahu” means carefulness. This study aims to determine the effect of integrating the cultural value of “MLD” and health education toward the intention of high school student to stop smoking in Bima district . This study is a quasy experiment with pre-post-test with control group design with purposiv sampling on 60 students of 5 Senior High School in Bima district. Self report was used to analyze the intention to stop smoking. Data analysis was examined by using Paired T-Test. The results showed 86.7% had strong intention to stop smoking and 13.3% had weak intention. The mean standard pre-post deviation in the treatment group was  $4,633 \pm 8,046$  with a p-value  $<0.001$ . It can be concluded that there was a significant effect of interventions integrating MLD cultural values and health education toward the intention of student to stop smoking. Therefore, “Smoking session” efforts are required by considering elements of local culture and family resources.

**Keywords:** *Education, Cultural Values, Intention to Stop Smoking.*

## Introduction

The overview Smoking behavior of adolescents in our country is very worrying. One-fifth of Indonesia’s population aged between 13-15 years have smoked and have tried cigarettes for the first time at the age of less than 10 years. Three out of five Indonesian students aged 13-15 have been exposed to cigarette advertisements and can easily buy cigarettes<sup>1</sup>. In the world, smoking is the highest cause of death and disability, because smoking

is the main behavioral risk factor associated with Cerebro Vascular Disease (CVD) besides hypertension, unhealthy diets, high cholesterol and air pollution<sup>2</sup>. Based on this, it is important for the government to try to stop the increase in new smokers/prevent the addition of new smokers if we want to reduce the number of teenage smoking and educate the younger generation about the effects/dangers of smoking.

It is important to make collaboration in order to educate young people such as students. The government through the Ministry of Health of the Republic of Indonesia with the youth health program has made various efforts but needs to be supported by various parties. The research suggests the need to promote health prevention of early smoking behavior among adolescents including involving the school. This becomes the basis for the need for literacy to bring up the intention to stop smoking for adolescents who have/just started smoking<sup>3</sup>. In line with research on high school students in the district of Bima,

---

### Corresponding Author:

**Martiningsih**

Mataram Health Polytechnic (Poltekkes Mataram),  
Prodi Keperawatan Bima, Jl. Soekarno Hatta 03-84112,  
Bima-West Nusa Tenggara-Indonesia  
e-mail: ningthahir@gmail.com  
Phone Number: 081237327111

the number of high school students who smoke is around 15% of the population. This figure is quite high besides it confirmed by the fact that the majority of teenagers start smoking since junior high school/junior high school and even elementary school/elementary school<sup>4</sup>. Therefore prevention of risk behavior and changing risk behavior into health-supporting behavior through education, especially for adolescents/adolescence, is important in the long-term preventive effort that is sustainable and synergizes with programs that support health and consider the elements of local cultural values.

Bimanesse society define culture as something that is associated with behavior, in this case health behavior is the cultural value of “*Maja LaboDahu/MLD*”. MLD cultural value contains two components which are interrelated and complementary<sup>5</sup>. Based on this, this study was conducted to analyze the effect of the integration of health education and the cultural value of Bimanesse culture “*Maja Labo Dahu*” on the intention to stop smoking in high school student smokers.

## Materials and Method

This research was a quasi-experimental conducted in the district of Bima West Nusa Tenggara Province in August-September 2019. The respondents were the 10-12 grader of high school students from 3 state high schools, 1 vocational high school, 1 madrasa

alياهو (Islamic high school) and the sample selection was purposive sampling with a total of 60 respondents divided into two groups. The treatment group was given health education using a booklet entitled “Self Confidence and Achievement without Smoking” which contained the integration of health education about the health hazards of smoking and the cultural value of MLD (ISBN 978-623-91626-7-2) while in the control group provided health education using the booklet of the Ministry of Health of the Republic of Indonesia in 2017 entitled “Healthy Living without Cigarettes”. Health education in each group was carried out for 4 meetings (1 meeting/week). The evaluation of quit smoking intention variables used quitting intention questionnaire and self report on smoking behavior. The research instrument consisted of 24 question items on the Linkert scale and validity and reliability tests were conducted. The results of the validity of the quitting intention questionnaire used in this study were  $0.855 > 0.4227$  with a Cronbach’s Alphareability test value of 0.734. Processing and data analysis used SPSS 16 software with paired T Test.

## Results and Discussion

**Results:** Characteristics all respondents were male as many as 60 people (100%) from locations in 5 High Schools (SMA). The others variables can be seen in the table below:

**Table 1. Characteristics of age and Risk Factor CVD Based on history of Alcohol use and family smoker Based on Groupbased on group (n = 60)**

Characteristics	Treatment group (n=30)		Control group (n=30)	
	n	%	n	%
<b>Age, year</b>				
15	8	26.7	4	13.3
16	15	50.0	12	40.0
17	6	20.0	12	40.0
18	1	3.3	2	6.7
Age; mean standard deviation, min-max, median (year)	16	0.79	15-18	16
<b>Do you have family member that is addicted of smoking?</b>				
No	15	50	14	46.7
Yes	15	50	16	53.3

Based on the data in table 1 all respondents with an average age of 16 years (age range 15-18 years). CVD risk in the treatment group: based on alcohol use

behavior 30% had tried and used alcohol and 53.3% had families smoked.

**Table 2. The intension of quitting of smoking before and after giving education on treatment and control group (n = 60)**

Variabel	Treatment group (n=30)				Control group (n=30)			
	Pre		Post		Pre		Post	
	n	%	N	%	n	%	n	%
<b>The intension to quit of smoking</b>								
Less	12	40	4	13.3	14	46.7	9	30
Good	18	60	26	86.7	16	53.3	21	70

Based on table 2. in the treatment group before MLD education showed that 12 people (40%) had less intention to stop smoking and 18 people (60%) had good smoking cessation intentions whereas after MLD

education there were still 4 (13.3%) with intention to quit smoking less smoking and 26 people (86.7%) with good smoking cessation intentions.

**Table 3. Distribution of mean the intension quit smoking of smoker student before and after giving education on treatment and control group in DISTRICT of Bima (n = 60).**

The intension quit smoking	Mean,SD	Min-Max	Mean pre-post, SD	95% CI	p-value
<b>Treatment Group</b>					
• Pre	76.27±5.452	65-88	4.633±8.046	74.23 – 78.30	<0.001
• Post	80.85±6.063	60-90		78.47 – 83.00	
<b>Control Group</b>					
• Pre	76.21±6.772	63-88	4.467±6.425	73.81-78.61	0.005
• Post	80.73±6.379	56-91		78.59-83.11	

Based on table 3, it shows that the difference in the mean of the first and second measurements in the treatment group is 4,467 with a standard deviation of 8.046. The p-value is < 0.001, so it can be concluded that there is a significant difference between pre and post education measurements in groups that get health education integrated with MLD cultural values.

### Discussion

In this study, risky behavior in intervened adolescents is smoking behavior by integrating the cultural values of MLD and health education “No smoking” so that it is expected that adolescents have the knowledge and awareness which further becomes a stimulus and has a strong intention to stop smoking. Findings The results of this study indicate that integrated health education with local cultural values in this case MLD cultural values have a significant influence on the strong intention to stop smoking in high school students in the district of Bima. This study is as relatively same as the results of Herawati, et al., 2017 research which suggests the need

for health promotion of adolescents who have/just started smoking. Thus, it is the basis for the need of literacy to bring up the intention to quit smoking. In line with the research of Akmal, et al., 2016 in high school students in the district of Bima entitle “Attitudes Influencing the Intention to Stop Smoking in High Schools students in the district of Bima” which suggest the need some efforts to prevent risk behaviors or change risk behaviors into health-supporting behaviors including through education especially in adolescents/adolescence. This becomes important in the long-term preventive efforts that continue to be sustainable and synergize with programs that support health and consider local cultural value elements.

The results of the bivariate analysis of the intention to quit smoking before the MLD education of adolescents with the intention to quit smoking less as much as 40% while after the MLD education decreased to 13.3% compared to the control group before the education of adolescents with the intention to quit smoking less as much as 46.7% while after education decreased to 30%.

This shows that although there was a similar decline, there were more smokers in the treatment group who had stronger smoking cessation intentions than in the control group. This means that health education integrated with the local cultural value of “MLD” which is the cultural value of the Bimanesse society influences the emergence of intentions and increases motivation to quit smoking. In accordance with the results of research that a person will follow or leave a behavior influenced by socio-cultural elements and a strong intention to stop smoking is influenced by subjective norms that are believed by individuals<sup>4</sup>.

Based on the Big Indonesian Dictionary/KBBI published by the Ministry of National Education, being ashamed means feeling very uncomfortable (despicable, inferior, etc.) for doing something that is not good (not right, different from the habit) and afraid that can be interpreted as piety; reluctant, not brave (doing something that is not appropriate<sup>6</sup>. The meaning according to KBBI is in line with the meaning of the word MLD in the Bimanesse society. The word “Maja” means shame and “Dahu” means Afraid. If we review the above words semantically or meaningfully, “Maja” (shame) means that people or people of Bima will be ashamed when doing something outside of God’s corridor, whether it is crime, sin, etc. whether related to humans or to God. “Dahu” (afraid), almost have the same interpretation process as the word Shame. Equally afraid when committing a crime or badness. In adolescent smokers who get integrated health education states that education with a health hazard approach to the effects of smoking alone is not enough to sensitize because of a sense “Excessive confidence” in his health status and adolescent age, so an additional approach cultural values as general values that apply in social life and society are more easily accepted and obeyed.

Characteristics of smoking behavior in this study 83.3%, were active smokers in the last 6 months with the age of the firstly smoking started at the age of 10 years -14 years and 16.7% started smoking at the age of less than 10 years. This is consistent with the results of research related to smoking behavior in Indonesia according to the Global Youth Tobacco Survey/GYTS, (WHO, 2015) that every year there are 16.4 million new smokers age between 10 and 19 years. So efforts to reduce the number of teenage smokers, prevent new smokers and educate young people about the effects and dangers of smoking are very important to save Indonesia’s future generations from cardiovascular

epidemics<sup>7</sup>. The age of first smoking at the age of 16-18 years, significantly increases the risk of the incidence of hypertension independently (people who smoke for the first time at the age of 16-18 years will immediately become regular smokers, ie people who smoke at least 1 cigarette/days, not smoking anymore as a trial and error. According to the results of research that shows that as much as 51.3% of CVD sufferers mostly start smoking at the age of adolescents. Based on these findings it is necessary to implement policies to promote healthy lifestyles in children and adolescents is very important for the prevention of CVD Healthy behavior is learned from childhood and continues into adulthood<sup>8</sup>.

In addition, it is necessary to strive to increase the role of the government in carrying out a strategy of cultural approach that is safe and acceptable to the community<sup>9</sup> and working with educational institutions and increasing the accessibility of adolescents to health promotion programs carried out using community approaches in educational institutions that proven to have a positive effect on changes in adolescent health behaviors<sup>10</sup>. The results of other studies indicate that Fear and Embarrassment or “Maja Labo Dahu” are values that need to be integrated in Education teaching materials. This will complement each other’s successful educational process in schools<sup>5</sup>. In the end all of the above efforts are expected to have a positive effect with changes in adolescent health behavior.

## Conclusion

Integrated the cultural values “MLD” and health education about the dangers of smoking affect the strong intention to stop smoking in high school students. Integrated and programmed education based on local cultural values in high school as an effort to initiate the intention to quit smoking influences giving stronger stimulation to increase smoking cessation intention so as to then can encourage efforts to to Intention Quit Smoking and avoid risky behavior among adolescents. Continued efforts are needed in the literacy of the prevention of smoking behavior in adolescents at an earlier age level (elementary school and junior high school) taking into account local cultural elements and the resources available at school.

**Acknowledgement:** Acknowledgments for the advice and input of the expert team of the Health Polytechnic research unit of the Ministry of Health of Mataram and to all those who have contributed morally and materially, which we are really appreciated.

**Source of Funding:** This research supported by financial assistance from the Ministry of Health PPSDM RI through the Ministry of Health of the Health Polytechnic of Mataram.

**Ethical Consideration:** This study has received Ethical approval from the Mataram University Health Research Ethics Committee No: 207/UN18.8/ETIK/2019.

**Conflict of Interest:** Nil

### References

1. WHO. (2015). Global Youth Tobacco Survey (GYTS): Indonesia report 2014. Who-Searo. [https://doi.org/http://www.searo.who.int/tobacco/documents/ino\\_gyts\\_report\\_2014.pdf](https://doi.org/http://www.searo.who.int/tobacco/documents/ino_gyts_report_2014.pdf)
2. Thomas, H., Diamond, J., Vieco, A., Chaudhuri, S., Shinnar, E., Cromer, S., Moran, A. E. (2018). Global Atlas of Cardiovascular Disease 2000-2016: The Path to Prevention and Control. *Global Heart*, 13(3), 143–163. <https://doi.org/10.1016/j.gheart.2018.09.511>
3. Herawati, L., Budiman, J. A., Haryono, W., & Mulyani, W. (2017). Jayapura Teenagers Smoking Behavior. *Journal of Community Health*, 42(1), 78–82. <https://doi.org/10.1007/s10900-016-0232-4>
4. Dzul Akmal, Bagoes Widjanarko, P. N. (2017). Sikap Mempengaruhi Niat Berhenti Merokok pada Remaja SMA di Kota Bima, 12.
5. Departemen Pendidikan Nasional. (2008). Kamus Bahasa Indonesia. Departemen Pendidikan Nasional. Jakarta.
6. Tan YL. and Dorotheo U. (2018). The Tobacco Control Atlas: ASEAN Region, Fourth Edition, September 2018. Southeast Asia Tobacco Control Alliance (SEATCA), Bangkok. Thailand. <https://seatca.org/dmdocuments/SEATCA/2018.pdf>
7. Mendis, S., Puska, P., Norrving, B., (2011). Global Atlas on Cardiovascular Disease Prevention and Control. World Health Organization, Geneva 2011. <https://www.ncbi.nlm.nih.gov/pubmed/30301680>. DOI:10.1016/j.gheart.2018.09.511
8. AN Maulidya, D Ayuningtyas (2018). Availability, Accessibility, And Acceptability of Health Services In Remote Indigenous Community of the Baduy Dalam Tribe. *Indian Journal of Public Health Research & Development* 9 (12), 513-518
9. Minary L, Cambon L, Martini H, et al. Efficacy of a smoking cessation program in a population of adolescent smokers in vocational schools: a public health evaluative controlled study. *BMC Public Health*. 2013;13:149. Published 2013 Feb 18. doi:10.1186/1471-2458-13-149.
10. Munir, A. (2018). Integrasi nilai-nilai budaya bima dalam bahan ajar pendidikan islam, 329–340.

# Application of Poskestren as Health Promotion Strategy for Improving Clean and Healthy Behavior of Pesantren in East Java Province

Maygi Restu Yang Esa<sup>1</sup>, Muhammad Baharuddin Wisudawan Putra<sup>2</sup>, Diyah Werdiningtyas, S.Gz<sup>3</sup>

<sup>1</sup>Undergraduate Student in Department Health Policy and Administration, Faculty of Public Health, Universitas Airlangga, Surabaya, Indonesia, <sup>2</sup>Undergraduate student in Department Health Promotion and Behavior, Faculty of Public Health, Universitas Airlangga, Surabaya, Indonesia, <sup>3</sup>Government employees in Sub Sector of Health Promotion and Community Empowerment, Field of Public Health, Health Department of East Java Province, Indonesia

## Abstract

Islamic boarding schools (Pesantren) are Islamic educational institutions in Indonesia. The Ministry of Health of the Republic of Indonesia has launched a concept to encourage people to care about their health, namely the Clean and Healthy Behavior (PHBS). Islamic boarding schools also have health problems so they need attention in efforts to improve public health. The health effort undertaken at the Pesantren is Poskestren (Pesantren Health Care). Based on the Health Department Data of East Java Provincial (2019), there are 3,965 islamic boarding schools with 1,284 Poskestren in East Java province. Poskestren can be a solution in solving health problems in Pesantren. Therefore the Poskestren must be arranged properly. In health promotion there are health promotion strategies which consist of advocacy, community development, community empowerment and partnerships. This health promotion strategy can be a reference in the implementation of the Poskestren in Pesantren.

**Keywords:** *Pesantren, Poskestren, PHBS, Health Promotion Strategy.*

## Introduction

Islamic boarding schools (Pesantren) are Islamic educational institutions in Indonesia. Pesantren can be said as one of the centers of gathering people who live together and carry out activities together so that it can be said to be an environment that is at risk of disease transmission. The highest diseases that can occur in pesantren include scabies, ARI, and gastritis.<sup>(1)</sup> This can occur due to personal hygiene and poor environmental sanitation.

The Government of Indonesia through the Ministry of Health has launched ten indicators of clean and healthy behavior (PHBS). PHBS covers five settings, one of which is PHBS in schools/educational institutions. Pesantren as one type of educational institution needs special attention in the implementation of PHBS as an effort to improve the health status of residents in their environment.

Community empowerment is one of the health promotion strategies. Poskestren is a manifestation of community-based health efforts (UKBM) carried out in Pesantren. Poskestren prioritizes promotive and preventive services without neglecting the curative and rehabilitative aspects with the guidance of the Primary health care (Puskesmas).

Based on the Health Department Data of East Java Province (2019), there are 3,965 boarding schools with 1,284 Poskestren in East Java province. The Governor of East Java Province launched the East Java Santri Healthy and Blessing Program (SAJADAH) which is an effort to assist the Pesantren. The aim is to increase the level of independence of the Poskestren and PHBS in the pesantren environment. This assistance involved various sectors ranging from the pesantren community, the health office, the puskesmas and other partnerships.

Based on the description above, the researchers conducted a study related to the effectiveness of the

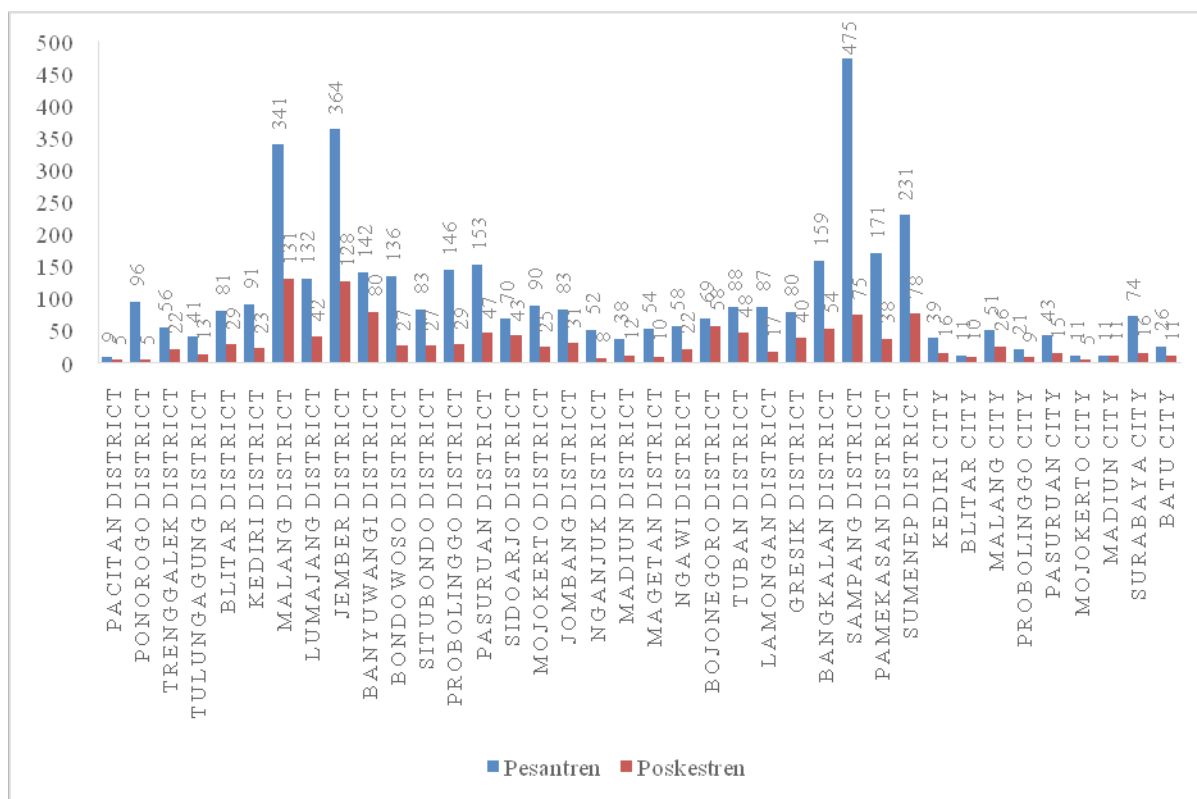
Poskestren assistance program in increasing PHBS in the Pesantren of East Java Province.

### Method

This research uses quantitative research method with a secondary data analysis approach. This study uses data sourced from Health Department of East Java Province and also the policy for the implementation of the Pesantren assistance program. Data processing in this study used the test of two non-parametric paired samples with the Wilcoxon test. Secondary data used ordinal scale by looking at the PHBS classification data before and after getting the Pesantren assistance program.

### Result

**Overview of the Achievement of the Poskestren Assistance Program (SAJADAH) in East Java Province:** According to Health Department Data of East Java Province (2019), East Java Province has 3,965 Pesantren with 1,284 Poskestren. This shows that there are 32.38% of pesantren that have Poskestren. The following is a comparison chart of the number of pesantren and the number of Poskestren in the District/City of East Java Province:



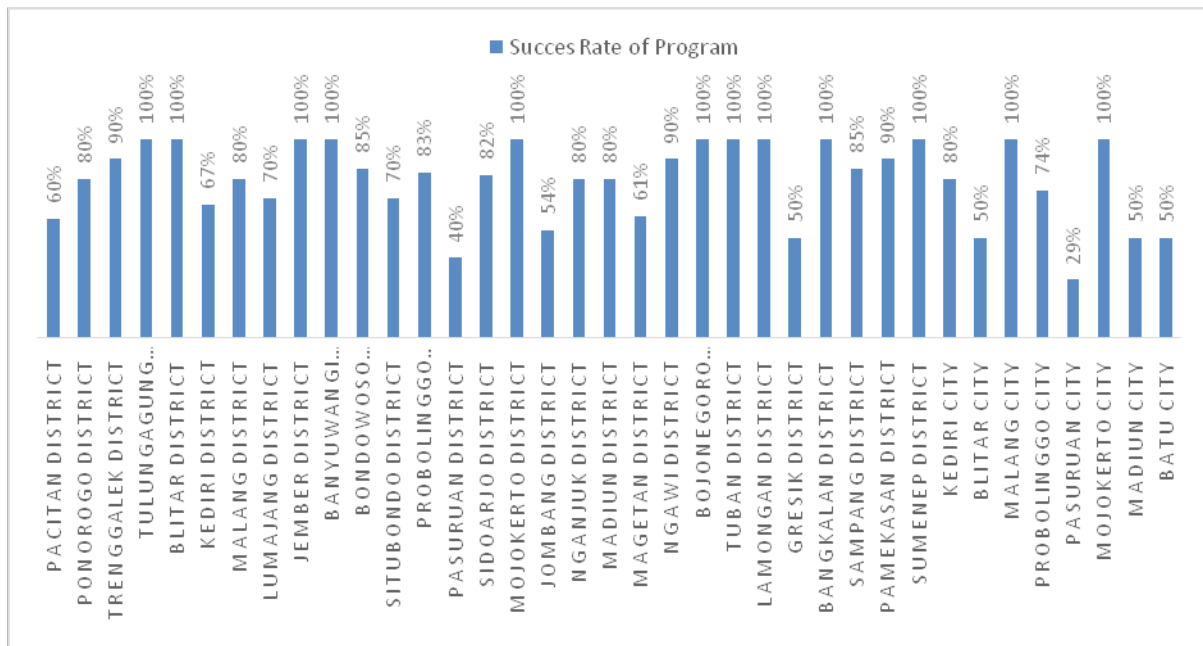
**Figure 1. Number of Pesantren and Poskestren in District/City in East Java Province in 2019**

Figure 1 shows that not all pesantren have Poskestren. This shows that health efforts in Pesantren in each region have not been running optimally. For example in Sampang District which has 475 Pesantren but only has 75 Poskestren (15.79% of the total number of Pesantren).

PHBS scores were collected to find out the Poskestren classification. There are four classifications. The first

classification is the Poskestren which has a value of one to five. The second classification is the Poskestren which has a value of six to ten. The third classification is the Poskestren which has values of eleven to fifteen. And the fourth classification has a value of sixteen to eighteen. Following are the success rates in (%) of the Poskestren assistance program for improving the classification of PHBS in East Java Province in 2019:





**Figure 2. The Success Rate of the Poskestren Assistance Program Against PHBS in East Java Province in 2019**

Figure 2 shows that there are 12 districts or cities that have increased PHBS by 100% with the Poskestren Assistance Program. There are only two districts or cities that have not reached a success rate of 50%. The processed data shows that the data are not normally distributed ( $\text{sig } 0.0000 < \alpha 0.05$ ) so that the difference test for two Non Parametric Paired samples (Wilcoxon Test) is used. The Wilcoxon test results are  $\text{sig } 0,000 < \alpha 0.05$ . It can be concluded that there are differences in Clean and Healthy Behavior (PHBS) between before the Poskestren Assistance Program and after the Poskestren Assistance Program. This shows that the assistance program for Poskestren was effective and succeeded in increasing PHBS in Pesantren.

**Discussion**

**Poskestren as a Health Promotion Strategy in Pesantren:** There is a relationship between the role of the poskestren and the Personal Hygiene behavior of adolescent santri in Al-Ghazaalie Islamic Boarding School Kranjingan, Summersari District, Jember District.<sup>(3)</sup> But there are also many other factors that influence this behavior.

Another study said that the health status of santri in a Pesantren that has a Poskestren is in a fairly good category consisting of three health sub-variables namely physical health in the good category (100%), mental

health in the pretty good category (63%), and health the social category is quite good with a percentage of 43.8%.<sup>(10)</sup> Therefore, every Pesantren needs to establish a Poskestren because if the Poskestren is run well, the health of the santri will improve, especially at the level of implementation of the Clean and Healthy Behavior (PHBS) of the santri.

Poskestren is present as one of the health promotion strategies in Pesantren. However, the existence of the Poskestren cannot guarantee that PHBS in the pesantren is good. A strategy is needed to run the Poskestren. The strategy in question is a health promotion strategy.

Health promotion strategies are based on the complexity of the nature of people’s behavior. Based on the Decree of the Minister of Health No. 1114/MENKES/SK/VII/2005 concerning Guidelines for Implementing Health Promotion in the Regions, health promotion is an effort to increase the community’s capacity through learning from, by, for and with the community, so that they can help themselves, and develop community-based activities, in accordance with local socio-culture and supported by health-oriented public policies.

To achieve the above objectives, the health promotion strategy implemented at the Poskestren contains four aspects.

**1. Advocacy:** Advocacy is an approach and motivation towards certain parties which is calculated to be able to support the successful development of PHBS both in material and non material aspects. The parties involved are both formal and informal community leaders who generally act as resource persons (opinion leaders), or policy makers (norms) or funders. Other certain parties can also be in the form of society or mass media that can create a conducive atmosphere, public opinion and encouragement of the creation of community PHBS.

The factors influencing the success of the poskestren were knowledge, participation, motivation & support, leadership, community potential, cooperation, and policy.<sup>(7)</sup> While the failure factors in the Poskestren program were weak community participation and the emergence of a dependency towards the Ministry of Health assistance and District Health Office. This shows that Poskestren's internal commitment and external support for Poskestren affect the success of the Poskestren itself.

Policy is an example of the commitment of policy makers in an issue. Some regulations have been established by the government in the procurement of Poskestren as an effort to improve the degree of public health, especially in the pesantren environment.

**Supporting regulations and policies include:**

1. Regulation of the Minister of Health of the Republic of Indonesia Number 1 of 2013 concerning Guidelines for Organizing and Developing Poskestren which are guidelines for implementing Poskestren.
2. Joint Decree of the Minister of Health, Minister of Religion, and Minister of Home Affairs Number 1067/Menkes/SKB/VIII/2002, Number 385 of 2002, and Number 37 of 2002 concerning Improvement of the Health of Pesantren and Other Religious Institutions
3. Joint Decree of the Minister of National Education, Minister of Health, Minister of Religion, and Minister of Home Affairs Number 1/U/SKB/2003, Number 1067/Menkes/SKB/VII/2003, Number MA/230A/2003, and Number 26 of 2003 about the Development and Development of School Health Enterprises.
4. Minister of Health Regulation No. 2269/

Menkes/Per/XI/2011 concerning Guidelines for the Development of Clean and Healthy Behavior (State Gazette of the Republic of Indonesia Number 755, 2011) which states that Pesantren are one of the targets of PHBS in educational institutions.

5. The program issued by the Governor of East Java in the form of SAJADAH which is an effort to assist Poskestren in East Java Pesantren.

**2. Social Support:** Community development is an effort to create a social environment that encourages individuals in community members to want to do the behavior that is introduced. Individual community members will be more motivated to engage in introduced behavior if community leaders or influential people in the environment approve or support the introduced behavior.

To achieve the objectives of fostering and enhancing the functions and performance of the Poskestren, the Puskesmas carries out several activities as the person responsible for the Poskestren in its area. The Puskesmas started the formation of the Poskestren by coordinating with the leaders or managers of the Pesantren to approach it. This approach aims to prepare members of the pesantren so that they are willing to support the implementation of the Poskestren. Furthermore, the Self-Inspection Survey (SMD) was conducted involving members of the Pesantren. Puskesmas staff, and related stakeholders. The purpose of SMD is to recognize and identify health problems in the pesantren environment so that they can be considered in what interventions to take. The Puskesmas will also provide guidance and monitoring to help manage the Poskestren on a regular basis.

Improving services at the Poskestren must be based on the health needs of the pesantren community. Therefore there needs to be support for the availability and skills of the Poskestren resources. The Puskesmas assisted with the Pesantren apparatus will also form a Poskestren cadre called SantriHusada. SantriHusada together with the manager of the Poskestren who will later become the spearhead in moving the pesantren community to care about health. This will be the embryo of empowering the Pesantren community by developing and empowering the potential or resources of the Pesantren itself.

Based on the Wilcoxon test it was stated that there were differences in PHBS between before and after the Poskestren assistance program (SAJADAH). This is consistent with a research that there is a significant relationship between self-sanitation and environmental sanitation socialization innovations through poskestren with santri attitudes towards sanitation.<sup>(11)</sup> Socialization of self and environmental sanitation through poskestren is in the high category where socialization provides knowledge about self sanitation and the environment for students. In addition, socialization makes students more active in implementing cooperation in maintaining personal hygiene and the environment of the pesantren where they live and study.

3. **Community Empowerment:** In health promotion, community empowerment is a very important part. Empowerment is the process of providing information to health promotion targets continuously and continuously following the development of targets, and the process of helping targets to change from not knowing to knowing (knowledge aspects), from knowing to being willing (attitude aspects), and from wanting to be able (practice aspects) carry out the introduced behavior. Therefore success in empowerment is to make the target understand and realize that something (a health problem) is a problem for him and for the community so that it leads to the application of the introduced behavior.

Poskestren can be a facility for pesantren communities to obtain health information. Through the managers of the Poskestren and SantriHusada, information can be given continuously and continuously. This is because they live together directly so they understand the development of health problems in Pesantren. Health information from the Puskesmas and other health media is expected to be received by the Poskestren Manager and SantriHusada which can then be passed on to the Pesantren community. The puskesmas will also conduct regular training with the aim of implementing the Poskestren to provide information and intervention to the pesantren community appropriately.

4. **Partnership:** Partnerships must be promoted well in order to support the other three aspects of health promotion strategies. The partnership is based on the principles of equality, openness and mutual benefit. Partnerships with other individuals or groups will

enable the implementation of the Poskestren to be even better.

Partners from Poskestren can support the implementation of Poskestren by providing resource assistance. The resources provided can be in the form of financial resources, materials, information, coaching and training. Stakeholders who can be an opportunity to become a Poskestren partner include Government Agencies or Institutions such as ministries of religion and health, Community Leaders, Community Organizations/NGOs, Business or private sector and Universities.

The government as the policy maker can play a role in formulating health-oriented policies to support health activities and programs in Pesantren. The government can also provide facilities in the form of cross-sector meeting and discussion. This can enable and assist Poskestren to establish broader partners.

Community leaders and organizations involved such as in the religious field can be a companion to the Poskestren. Human resource assistance can help in health improvement programs run by the Poskestren. This is because the Poskestren, Pesantren and Community Leaders/Community Organizations have emotional closeness to the Pesantren community. So that health programs or interventions carried out in solving health problems can be received with an appropriate approach.

The business or private sector has obligations related to social responsibility (CSR). Increasing the role of CSR can be an opportunity to improve the degree of public health. Businesses or the private sector can be involved in health promotion efforts such as involvement and assistance with the implementation of the Poskestren.

Higher education in Indonesia has Tri Darma Higher Education as its basic principle. One of the Tri Darma of Higher Education is "Community Service". The role of tertiary institutions is very clear to be able to make people equal in solving problems in their environment. The academic community can help the community through education and research to develop solutions or appropriate interventions for a problem. This can be an alternative for Poskestren to obtain information and human resources sources in intervening in health problems in Pesantren.

## Conclusion

The results of the Poskestren analysis as a health promotion strategy in the East Java Pesantren can be summarized as follows:

1. Poskestren Assistance Program (SAJADAH) is effective and has succeeded in increasing PHBS in Pesantren in East Java Province.
2. Advocacy becomes very important in health interventions by involving policy makers to make regulations and health-oriented references. The establishment of the Poskestren is based on health problems that often occur in Pesantren boarding schools.
3. Community Development becomes important to provide facilities to the Poskestren in its implementation. Starting from the preparation, planning, organizing and control stages.
4. Poskestren becomes a place for Pesantren community to manage their potential to improve the health status of Pesantren community. Therefore, Community Empowerment through Poskestren must be fostered and developed continuously to promote health and reduce morbidity.
5. Partnerships are needed to optimize the implementation of the Poskestren itself.

## Recommendation:

1. Promoting the Poskestren program based on the Health Promotion Strategy and the needs of the pesantren community in the Pesantren of East Java Province.
2. The government and the person responsible for the Poskestren should bridge the Poskestren with the Business World or Private partnership.

**Conflict of Interest:** The authors have no conflict of interest with the material presented in this paper

**Sources of Funding:** Nill

**Ethical Clearance:** Nill. My paper is an idea and policy analysis to solve population problems, without any treatment to the respondent/informant

## Reference

1. Adriansyah AA. Keterkaitan Antara Sanitasi Pondok Pesantren Dengan Kejadian Penyakit Yang Dialami Santri Di Pondok Pesantren Sunan Drajat. Mtpbj [Internet]. 2018 Aug. 24 [cited 2020 Aug. 1];1(1):4-13. Available from: <https://journal2.unusa.ac.id/index.php/MTPHJ/article/view/752>.
2. Bahruddin E, Hamdi AS. Metode Penelitian Kuantitatif Aplikasi Dalam Pendidikan. Deepublish; 2015.
3. Fauzi Ahmad. Hubungan Peran Pos Kesehatan Pesantren (Poskestren) Dengan Perilaku Personal Hygiene Remaja Santri Pondok Pesantren DarulHikmah Al-Ghazaalie Kranjingan Kecamatan Sumber Sari Kabupaten Jember [Skripsi]. Jember: Fakultas Kesehatan Universitas Muhammadiyah Jember; 2016
4. Health Department of East Java Province. Number of Islamic Boarding Schools, Number of Santri Hisada, and the Level of Development of the East Java Province 2019. Surabaya: Health Department of East Java Province; 2019.
5. Health Department of East Java Province. Petunjuk Teknis Pendampingan Poskestren. Surabaya: Health Department of East Java Province; 2019.
6. Kompri. Manajemen & Kepemimpinan Pondok Pesantren. Prenada Media; 2018.
7. Kusnaati E, Prabandari YS. Pemberdayaan Masyarakat Pondok Pesantren Melalui Pos Kesehatan Pesantren Di Kabupaten Tulungagung [Theses]. Yogyakarta: Universitas Gajah Mada; 2013.
8. Ministry of Health of the Republic of Indonesia. Promosi Kesehatan di Daerah Bermasalah Kesehatan: Panduan bagi Petugas Kesehatan di Puskesmas. Jakarta: Ministry of Health of the Republic of Indonesia; 2011.
9. Ministry of Health of the Republic of Indonesia. Pedoman penyelenggaraan Dan Pembinaan Pos Kesehatan Pesantren. Jakarta: Ministry of Health of the Republic of Indonesia; 2013.
10. Shalihah Nur. Gambaran Status Kesehatan Santri Pada Pondok Yang Memiliki Pos Kesehatan Pesantren Di Pesantren Ruhul Islam Anak Bangsa Aceh Besar [Theses]. Banda Aceh; Universitas Syiah Kuala; 2014.
11. Wahyudin U, Arifin HS. Sosialisasi Sanitasi Diri dan Lingkungan di Pesantren Salafi Melalui Pos Kesehatan Pesantren (Poskestren) Dalam Membentuk Sikap Santri Terhadap Sanitasi. Jurnal Kajian Komunikasi. 2015;3(2):148-153
12. Waryana. Promosi Kesehatan, Penyuluhan, dan Pemberdayaan Masyarakat. Nuha Medika; 2016

# Perception of Successful Aging in Nursing Students

Mihyeon Seong

*Department of Nursing, Changshin University. Assistant Professor; RN, MSN, PhD*

## Abstract

The purpose of this study is to apply Q methodologies to identify and understand the type of successful aging perception in nursing students. The study organized the Q population through in-depth interviews to select 21 Q samples that could represent the Q population by coordination with two professors and researchers familiar with the Q methodology, and 49 nursing students were selected as P-samples. The data collection was about three months from September 10, 2020 to September 17, 2020 and was analyzed using the PQ Method Program. According to this study, nursing students perception of successful aging was divided into four types: Type 1 “capitalism type,” Type 2 “Self-esteem type,” Type 3 “Adaptive type,” Type 4 “Stable type”. As a result of this study, the four types of nursing students recognized health, leisure, economic power, and self-esteem. This study, understanding of each type of subjective aspect should be enhanced, and a wide range of insights should be provided so that nursing students can establish a value system of humanity and nursing professions in the undergraduate program in the future. In addition, it is expected that it will be used as a basic material for nursing education that can grow into a nurse who can meet the national expectations as a health care manager for the elderly through education that can develop the ability to cope with various problems faced in the nursing field.

**Keywords:** *Nursing students, Successful Aging, Q method, Subjectivity.*

## Introduction

The rapid growth of the elderly population is a trend of the elderly, and Korea is already an aging society, and it is expected by 2026, and it is on the faster side compared to other developed countries<sup>1</sup>. Due to this, achieving aging without the elderly is the main aging in all countries, which is contrary to the existing increase in aging that is positive, which involves emphasizing the positive meaning of everything and actively acting on avoidable fears. Another new paradigm is being demanded for healthcare and welfare systems<sup>2</sup>.

A better understanding of an aging society can help to better understand the problems facing the

elderly and their families<sup>3</sup>. The deaths of relatives and friends, separation from children due to marriage, employment, and anatomical changes make older people more vulnerable to various risks, so focus on ideal and purposeful life, close contact with others, and self-esteem We need to find ways to improve it<sup>4,5</sup>. However, the successful concept of aging in Western society does not adequately reflect the socio-cultural values of Korea<sup>6</sup>. Since successful aging is a value-oriented aging, it can be said that it is a socio-psychological concept that reflects the overall life of humans and reflects various social conditions that are culturally common to the elderly in that society. It is important<sup>7-9</sup>. Therefore, most studies on successful aging in Korea consist of the elderly, and studies related to the successful aging of nurses or nursing students who need to take care of such elderly are hard to find.

Looking at the latest research, nursing students' perception of successful aging is the only study of the effects of the self-elasticity and family elasticity of nursing students in Yang and Song<sup>10</sup> on the perception of successful aging. A comparative study of successful aging perception among Korean and Japanese university

---

### Corresponding Author:

**Mihyeon Seong**

262, Paryong-ro, Masanhoewon-gu, Changwon-si

Gyeongsangnam-do, Republic of Korea

Tel: +82-55-250-3165

Fax: +82-55-250-3185

e-mail: mihyeon0624@cs.ac.kr

students<sup>11</sup>, There are studies by Park and Lee<sup>12</sup> that examine the difference between the perceptions of successful aging among the elderly and college students, and studies related to aging among college students are studies on aging anxiety, which is a relatively negative emotion, and studies on successful aging, a positive concept, are insufficient. In particular, nursing students can easily feel the overall atmosphere of society by being exposed to various values of home and society and easily accepting changes in their surroundings as a grace of their self-identity during college<sup>10,13</sup>. In addition, the department of nursing must be able to respond appropriately to the rapidly changing aging society and adapt to the field of nursing, where the main goal of nursing is changing to the elderly<sup>10</sup>.

However, despite these changes in the times, current nursing students are lacking in awareness of the paradigm that reflects social and medical changes and preparation for the future society. It is necessary to grow into a nurse who can meet national expectations as an elderly health manager through education that can cultivate coping skills in various problem<sup>14</sup>. In addition, a positive attitude toward the elderly affects the quality of nursing and is an important issue for nursing practitioners<sup>15</sup>. The positive concept of successful aging, recognized by prospective nurses who will work in the field of nursing in the future, can be a driving force in approaching elderly patients as decent care targets. It can be said that it is urgent to first explore the perception of successful aging among nursing students.

Therefore, this study investigates successful aging, which is a positive concept of aging, for nursing students who are prospective medical personnel and are responsible for supporting and nursing the elderly population using the subjective Q methodology. This study was conducted to explore the perception of aging. The Q methodology focuses on the first person point of view to understand the phenomenon of successful aging from the perspective of individual nursing students, and through this, it is expected that various perspectives on successful aging can be identified. In addition, the purpose of this study is to derive various subjective perceptions of the successful aging of nursing students and to enhance the understanding of the successful aging of nursing students. It identifies subjective types and serves as the basic data needed to research and develop effective nursing strategies in an ultra-aging society.

**Research Purpose:** The purpose of this study is to

explore the types of recognition of successful aging of nursing students and their characteristics by applying the Q methodology to grasp the subject's subjective perspective. The specific research objectives are as follows.

1. Type the perception of nursing students' successful aging.
2. Analyze and describe the characteristics of nursing students' perception of successful aging by type.

## **Research Method**

**Research Design:** This study is an exploratory study applying the Q methodology, a subjectivity study method, to systematically and scientifically explore the perception of aging in nursing students.

**Research Subject:** The subject of this study is to understand the trend of successful aging subjectively perceived by nursing students. It is a P-sample that can best reveal successful aging, and was targeted at nursing students enrolled in the Department of Nursing in City C. In order to form the Q population, a total of 50 subjects including 3 subjects who participated in the interview were conveniently sampled, and 50 subjects who were recruited through the recruitment announcement explained the purpose and procedure of the study and received voluntary consent for the study. The study explained that the subjects can withdraw from the study at any time they do not want to participate in the study, and that there is no penalty. A total of 49 P-samples were used for the study, excluding one who responded insult to the questionnaire.

### **Research Process:**

**Composition of Q population and Q sample:** In this study, the Q population was formed based on the collected data by reviewing the literature on successful aging and conducting in-depth interviews with nursing students.

The subjects of the in-depth interview to obtain the Q recruitment group on the successful aging of nursing students are three nursing students aged 20 to 29 who are enrolled in the nursing department located in C city. It was selected as a target.

The in-depth interview on the perception of successful aging of nursing students was conducted for about 3 days from September 10, 2020 to September 13, 2020, and a total of 75 Q recruitment groups

were extracted. In the Q population extracted on the successful aging of nursing students, a researcher and two nursing professors participated together to readjust the sentences, exchange opinions several times, and then select 21 Q samples (Table 1).

**Q sorting:** It took about 30 minutes for the Q classification, general characteristics investigation, and interview, and the Q sample classification period was implemented from September 14, 2020 to September 18, 2020. For classification of Q samples, a final Q sample is written on a paper card (Q-card), and each Q statement card is read by a research participant. It was divided into three parts. After completing the classification into three groups, the statements of the Q statement card group classified as agreeing were read again, and the Q statement cards were sorted in order from the most agreeing (+3) to neutral (0). Similarly, the Q statement card group classified as disagreeable was classified from the most disagreeable (-3) to neutral (0), and arranged according to the card arrangement distribution table shown in <Figure 1>. After the classification was completed, we tried to obtain useful information when interpreting the Q factor through questions related to reasons, feelings, and successful aging for each statement. While the subject was performing Q classification, the researcher sat near the subject, instructed the classification method, and collected data on general characteristics such as age, gender, and religion. It took about 30 minutes for the Q classification, writing questionnaire, and interview.

**Data Analysis:** This study was analyzed using the principal component analysis of the PQ method program, and the specific analysis method is as follows.

1. 21 Q statements were entered with -3 to 3 points assigned to each P sample depending on the level of consent or disagreement.
2. In order to determine the most ideal number of factors, the most appropriate one was selected based on an Eigen value of 1.0 or higher.
3. The standard score for each type (Z-score) and the average of the standard scores for each type were analyzed.
4. Strong consent items (Z-score 1.00 or higher) and strong disagreement items (Z-score -1.00 or higher) by type were extracted and analyzed.
5. In order to analyze the reasons for selecting consent items and non-consent items of each type,

general characteristics, questionnaire data, and statements of the subject were considered together to comprehensively analyze the characteristics of the types.

## Results

**Analysis of results:** Six of the 49 subjects in this study (P-11, 15, 23, 29, 45, 48) were not classified as one factor because the difference in factor weights was not significant. The age ranged from 20 to 23 years old (Table 2).

According to the characteristics of each type, the four types of recognition of successful aging of nursing students in this study were 'capitalism type' with 23 students for type 1, 7 for type 2, 'self-esteem type', and type 3 for 'adaptive type', 4 types were classified as 'stable' into 5 persons. The Eigen Value by type of this study is as shown in (Table 3), and the explanatory power was 58%. In addition, the correlation coefficient between types 1 and 3 was the highest at  $r = .49$ , and the correlation coefficient between types 3 and 4 was slightly lower at  $r = .07$  (Table 4).

### Q type analysis:

**Type 1: Capitalist type:** Type 1 subjects said that health and economic requirements were more important than their appearance and wisdom for successful aging (Table 5). In particular, they recognized that health and happiness will follow if capital is satisfied.

Looking at this in detail, the statements of respondents with the first type of representativeness (factor weight 1.0 or more) are as follows.

The epitome of this type, P-21 (factor weight = .90) says, "In a capitalist society, there is nothing that should be money. The basis for successfully aging must also have capital. You must have your hobbies, your health and your money." Said. Through this, in this study, type 1 with these characteristics was named 'capitalism type'.

**Type 2: Self-esteem type:** Type 2 subjects said that the aspect related to self-esteem is important for successful aging (Table 5). They value the maintenance of sexual function, the success of their children, and interpersonal relationships, and that their self-esteem is more important than the economic requirements.

Looking at this in detail, the statements of respondents with the second type of representativeness

(factor weight 1.0 or more) are as follows. Typical of this type, P-30 (factor weight = .73) said, “It is important to be confident without money. What can be envious of others in old age? It is important to have children’s success, a strong sex life, and a friend or spouse who can be with them when they need help or are bored.”

Through this, in this study, type 2 with these characteristics was named ‘self-esteem type’.

**Type 3: Adaptive type:** Type 3 subjects said that adaptation according to the life cycle is important for successful aging (Table 5).

In particular, they said that they should not be afraid of changes due to aging, act at times, adapt and manage even if there are changes in the body, and devise a plan to live happily.

Specifically, the statements of respondents with the 3rd type of representativeness (factor weight 1.0 or more) are as follows. The epitome of this type, P-24 (factor weight = .77), says, “I think it is necessary to adapt flexibly over time. Everyone is aging and cannot reverse it. It is important to go in order.” Said. Through this, in this study, type 3 with these characteristics was named ‘adaptive type’.

**Type 4: Stable type:** Type 4 subjects recognized that it is important to feel a sense of stability for successful aging (Table 5).

They said that they need a family next to them in their old age, hobbies and housing that can lead to a successful and stable life for the family. In particular, they did not have any dynamic changes in their life after retirement, and they showed a tendency to want a quiet and comfortable life.

Specifically, the statements of respondents with the 4th type of representativeness (factor weight 1.0 or more) are as follows. The epitome of this type, P-24 (factor weight = .74), said, “I only have my own home and retire, but I wish there was no change in life. I hope to maintain my current life and continue my happiness.” Said. Through this, in this study, type 4 with these characteristics was named ‘stable type’.

**Table 1. Q Statement**

Statement
1. Live happily without worries.
2. There is no economic burden.
3. Have a job.
4. There is no problem with sexual function.
5. There are no special health problems.
6. Children succeed.
7. You have a good relationship with your spouse.
8. I have a lot of friends around me.
9. Honor those around you.
10. There are self-owned houses.
11. I have a hobby.
12. You look young.
13. A experienced people
14. You can get a pension in the country.
15. I get along well with the younger generation.
16. I am not afraid of challenges and failures.
17. I am not afraid of change.
18. Raising grandchildren.
19. You can go on a trip.
20. You are managing chronic diseases well.
21. There is no memory loss.

**Table 2. General characteristics and factor weights of P samples by type**

Type	ID	Factor weights	Age (yrs)	Religion
Type1 (n=23)	P-1	0.46	20	Protestant
	P-5	0.83	20	None
	P-7	0.63	20	None
	P-9	0.69	20	Buddhism
	P-12	0.76	21	Buddhism
	P-14	0.66	21	Protestant
	P-17	0.79	23	None
	P-18	0.73	23	None
	P-19	0.73	23	None
	P-20	0.76	23	Catholic
	P-21*	0.90	23	Catholic
	P-22	0.59	23	None
	P-32	0.57	23	Protestant
	P-35	0.43	21	None



Type	ID	Factor weights	Age (yrs)	Religion
	P-36	0.82	21	Protestant
	P-37	0.73	21	Catholic
	P-38	0.64	21	None
	P-40	0.64	21	Buddhism
	P-41	0.71	21	None
	P-42	0.78	21	None
	P-44	0.76	21	None
	P-47	0.86	21	None
	P-49	0.72	21	Catholic
Type2	P-4	0.71	20	Catholic
(n=7)	P-16	0.62	20	Protestant
	P-25	0.62	22	None
	P-26	0.72	22	None
	P-28	0.63	22	Catholic
	P-30*	0.73	22	Buddhism
	P-34	0.50	22	None
Type3	P-3	0.69	20	Protestant
(n=8)	P-8	0.56	20	None
	P-10	0.56	20	Protestant
	P-24*	0.77	22	Catholic
	P-31	0.51	22	Catholic

Type	ID	Factor weights	Age (yrs)	Religion
	P-39	0.62	21	Buddhism
	P-43	0.70	21	None
	P-46	0.71	21	None
Type4	P-2	0.65	20	None
(n=5)	P-6	0.65	20	None
	P-13	0.46	20	Buddhism
	P-27	0.59	22	None
	P-33*	0.74	22	Protestant

**Table 3. Eigen value and Variance by Type**

	Type1	Type2	Type3	Type4
Eigen values	15.63	6.34	3.75	3.20
Variance (%)	27	10	13	8
Cumulative (%)	27	37	50	58

**Table 4. Correlations among the Types**

	Type1	Type2	Type3	Type4
Type1	1.00			
Type2	0.12	1.00		
Type3	0.49	0.10	1.00	
Type4	0.09	0.41	0.07	1.00

**Table 5. Z-score for each type**

Statement	Z-score			
	Type 1	Type 2	Type 3	Type 4
1. Live happily without worries.	1.51		1.13	
2. There is no economic burden.	1.65			
3. Have a job.				-1.65
4. There is no problem with sexual function.	-1.08	1.87		
5. There are no special health problems.	1.83		1.67	
6. Children succeed.		1.33	-1.02	1.05
7. You have a good relationship with your spouse.		1.32		1.58
8. I have a lot of friends around me.		1.30		
9. Honor those around you.				
10. There are self-owned houses.				1.11
11. I have a hobby.			1.23	
12. You look young.	-1.52			
13. A experienced people	-1.18		-1.39	
14. You can get a pension in the country.		-1.99		

Statement	Z-score			
	Type 1	Type 2	Type 3	Type 4
15. I get along well with the younger generation.	-1.33			
16. I am not afraid of challenges and failures.				
17. I am not afraid of change.			1.31	
18. Raising grandchildren.	-1.53		-1.02	-1.40
19. You can go on a trip.				-1.15
20. You are managing chronic diseases well.			1.17	
21. There is no memory loss.			-1.34	-1.73

※ Blank is a statement with no significant standard score.

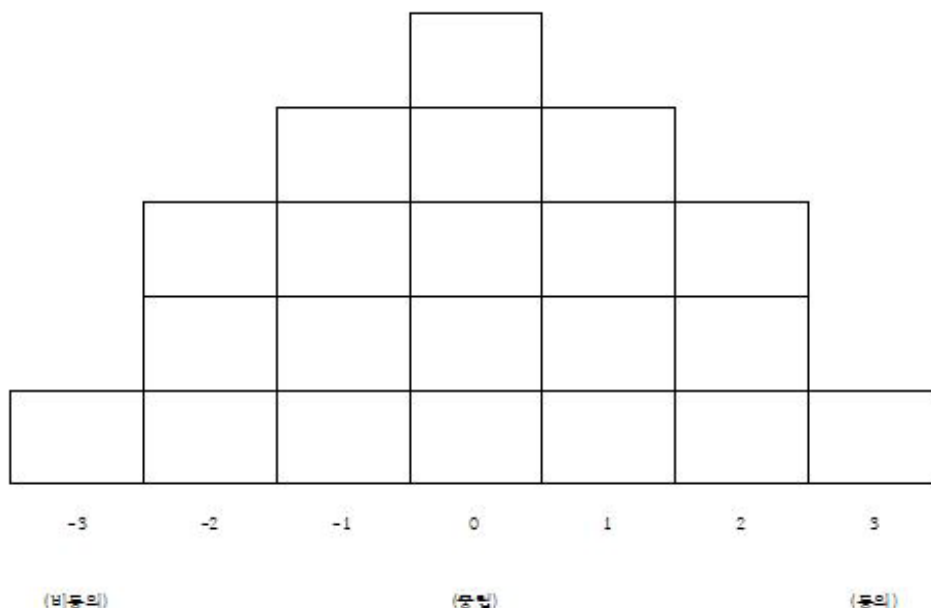


Figure 1. Card arrangement distribution table

### Discussion and Conclusion

In the undergraduate course of the nursing college, it is necessary to establish a value system of nursing professions with a sense of humanity and nursing ethics, and based on this, education that can cultivate the ability to cope with various problem situations faced in the field is necessary. This study was conducted as part of an effort to manage and solve problems in our society where the current traditional virtue of the path ideology has collapsed and the elderly are directly or indirectly experiencing various <sup>15</sup>.

It is believed that the first study of the concept of successful aging recognized by nursing students through this study will serve as basic data for fostering a positive perception of old age.

In this study, four types of nursing students' perception of successful aging were identified as "Type 1: Capitalism", "Type 2: Self-Esteem", "Type 3: Adaptive", and "Type 4: Stable".

Existing studies on successful aging have been mainly searched around old age at home and abroad<sup>2,16</sup> and research on the perception of old age by nurses and nursing students who are mainly caring for the elderly in an aging society. There are not many situations. Therefore, the four types of successful aging of nursing students identified in this study are thought to be able to present the characteristics of successful aging recognized by the younger generation and nursing students, as each type shows the attributes and various characteristics of successful aging. As a result of this study, the four types were analyzed to have properties such as health, leisure,

interpersonal relationships, and economic conditions. Looking at this in detail, types 1 and 4 recognized that economic factors were important. The economic requirements of retirement increase the quality of life by satisfying the elderly's income needs, satisfying the leisure needs through hobbies and leisure activities, and satisfying diverse and complex needs such as health and social psychological needs<sup>17</sup>.

According to a study by Han<sup>18</sup>, economic capital in old age influences the successful aging of capital formed before old age. Economic stability and security in old age can be the basis for the elderly's autonomous life and self-fulfillment orientation, active participation in life, family, interpersonal satisfaction, and acceptance of others<sup>19</sup>, the national pension system or the retirement pension system. It can be said that it is necessary to enlarge the back. This is a part that cannot be overlooked as the elderly who suffer from economic hardships can psychologically contract and interfere with social activities<sup>20</sup>.

On the contrary, Type 2 regarded interpersonal relationships as important, but Hong and Lim<sup>21</sup> said that people tend to maintain social relationships built up at work and in society even after retirement, and people with high self-esteem tend to value interpersonal relationships. There was said to be. In old age, it is highly likely that the scope of the social support system will be reduced due to the death of neighbors such as spouses, brothers, and sisters and becoming a nuclear family<sup>22</sup>. Therefore, it is necessary to prepare a nursing intervention plan that can improve interpersonal relationships and self-esteem in nursing practice in old age.

In addition, it was said that type 3 and type 4 should have a hobby to enjoy leisure. Leisure means free time without restraint, and through leisure, it can be an opportunity for self-realization by getting a break from the tension of relationships that occur in retirement life, and restoring the balance of one's life<sup>23</sup>. Leisure goes beyond simply spending time or promoting fellowship, providing an opportunity for the elderly to participate in a positive society, not isolation from society, and an opportunity to experience social support<sup>24</sup>. In addition, leisure satisfaction that can be obtained through leisure activities is an important variable of successful aging<sup>25</sup>. Leisure in the life of old age represents a mental state, becoming free from the forced life, becoming the core of human existence, and wanting oneself. It refers to a pleasant state of being connected while doing the

selected work<sup>26</sup>. Therefore, leisure has its essence in resolving various and complex mental anxieties caused by the prolongation of life expectancy and the loss of official social roles, and allowing people to feel joy and reward in life<sup>27</sup>.

Types 1 and 4 pointed to health as an important factor in successful aging. Health problems in old age negatively affect life in terms of economic, social relations, and psycho-emotional aspects, and in middle age, individuals from the first half of adults to old age due to the effects of accumulated experiences. Because it is the time to make the difference in the health level of women even larger<sup>28,29</sup>, intervention measures that appropriately apply recognition should be sought.

Erikson presents self-integration as a major development task to be carried out in old age, sees and accepts one's past, present, and future, resolves conflicts and guilt of the past, organizes life, and achieves self-integration<sup>30</sup>. However, no part of self-actualization was found in the traits of successful aging of nursing students identified in this study. Therefore, the importance of self-integration should be emphasized in the curriculum, including the mediation of successful aging recognized by nursing students. This is considered to be an effective way for nursing students to establish personal standards for successful aging in old age, to achieve self-integration by preparing for old age, and to grow into a nurse who can help achieve successful aging. In addition, it is expected that this study can be used as an institutional device and basic data for education to achieve successful aging in the old age.

**Acknowledgments:** The authors would like to thank the students who participated in this study and shared their experiences with us.

**Declaration of Conflicting Interests:** The Author declare that there is no conflict of interest.

**Source of Funding:** This work was supported by Changshin University Research Fund of 2020-044.

**Ethical Clearance:** It was approved Changshin University Institutional Review Board (CSIRB-20200004).

## References

1. Statistical Office. Elderly person statistics, 2015. <http://kosis.kr/statHtml/statHtml.do>
2. Seong MH. Successful aging perception in

- middle-aged adults : the Q methodology approach [dissertation]. [Seoul]: Kyunghee University; 2020.
3. Aliaga-Díaz E, Cuba-Fuentes S, Mar-Meza M. Health promotion and disease prevention for active aging that preserves quality of life. *Revista peruana de medicina experimental y salud publica*. 2016;33(2), 311-320.
  4. Molavi R, Mousa A, Mahrokh K. Relationship between general health of older health service users and their self-esteem in Isfahan in 2014. *Iranian journal of nursing and midwifery research*. 2015;20(6), 717.
  5. Mendoza-Ruvalcaba, NM, Arias-Merino ED. I am active: effects of a program to promote active aging. *Clinical interventions in aging*. 2015;10, 829.
  6. Hong HB, Choi HK. In Search of a Definition of Successful Aging: A Review of Literature. *Journal of Korean Home Management Association*. 2003;21(2), 145-154.
  7. Kwon HS. The Trend of Successful Aging in Academic Journals of Korea. *Journal of Brain Education Special issue*. 2011;1, 23-50.
  8. Rowe JW, Kahn RL. *Successful aging: The MacArthur foundation study*. New York: Pantheon. 1998.
  9. Featherman DL, Smith J, Peterson JG. *Successful aging in a post-retired society*. Cambridge University Press, 1990.
  10. Yang NY, Song MS. Influence of Ego Resilience and Family Resilience on the Perception of Successful Aging in Nursing Students. *Journal of Korean Academic Society of Home Health Care Nursing*. 2019;26(3), 278-287.
  11. Kim YJ. A Comparison of the Perception on Successful Aging of Korean and Japanese University Students. *Journal of the Korean Gerontological Society*. 2008;28(3), 567-583.
  12. Park KR, Lee YS. A Study on Perceptions of Successful Aging in Later Life. *Journal of the Korean Gerontological Society*. 2002;22(3), 53-66.
  13. Yang YK. A study on Aging Knowledge, Attitudes and Awareness about Supporting the Aged in Undergraduate Students. *The Journal of Korean Academic Society of Nursing Education*. 2013;19(4), 498-507.
  14. Kim HJ, Lee YM. Influence of Ageing Knowledge and Family Strengths on Ageism among the Nursing Students. *Korean Journal Rehabil Nursing*. 2018;21(2), 83-90.
  15. Kim YS, Jang IS. The Factors associated with Care Willingness towards Older Adults among Nursing Students. *Journal of the Korean Data Analysis Society*. 2017;19(3), 1669-1683.
  16. Cosco TD, Prina AM, Perales J, Stephan BC, Brayne C. Operational definitions of successful aging: a systematic review. *International Psychogeriatrics*. 2014;26(3), 373.
  17. Lee KH. Social Participation and Voluntarism of the Elderly. *Korean Journal of Gerontological Social Welfare*. 2001;12(6), 7-24.
  18. Han HK. Effects of the Elderly's Human, Economic and Cultural Capitals on Successful Aging: Focused on Mediating Effects of Engagement in Social Activities. *Journal of the Korean Gerontological Society*. 2018;38(4), 981-997.
  19. Lee MS. A Study on the Mediating Effect of Self-efficacy on the Relationship between Economic Status and Successful aging among the Elderly. *Korean Journal of Gerontological Social Welfare*. 2012;9, 289-313.
  20. Jang JE. Successful Aging and Work Activities during Elderly Period: Focused on the Case of Ogawanosho Oyakimura in Japan. *Korean Journal of Comparative Education*. 2017;27(3), 185-212.
  21. Hong RK, Lim WK. Effects of the Work Satisfaction and Quality of Life of the Middle-aged Workers on Retirement Preparation. *Journal of Digital Convergence*. 2014;12(11), 38-48.
  22. Ahn BH. *Human Relationship*. Seoul: TaeyeongBook. 2010.
  23. Kim MS, Ko JW. The Effect of the Elderly's Leisure Activity on Their Health and the Mediating Role of Family Support. *Korean Journal of Gerontological Social Welfare*. 2013;6, 34-54.
  24. Lee EJ. Relationship of Leisure Sports Activities, Social Support, Depression and Death Anxiety among the Elderly. *Korean Journal of Leisure, Recreation & Park*. 2014;38(4), 51-63.
  25. Won HJ. A Policy Study on Optimal Aging of the Korean Female Elderly. *Journal of Korean Association of Physical Education and Sport for Girls and Women*. 2005;19(3), 79-96.
  26. Cho YC, Park YW. A Study of the Relationship between Leisure Satisfaction and Their Mental

- Health of the Aged participating in Sport for All. *Journal of Sport and Leisure Studies*. 2001:15, 289-298.
27. Kim CO. The effect of leisure commitment to the quality of life on the elderly : with focus on mediation effect of depression. *Journal of the Korean Welfare Practice Society*. 2015:6(2), 78-99.
  28. Kang SO, Ha KS. Relations between the Middle Aged's Perception of Successful Aging and their Preparations for the Old Age. *The Journal of Digital Policy & Management*. 2013:11(12), 121-144.
  29. Cha SE, Han KH. The Effect of Work/Family Role Characteristics on Physical Health. *Family and culture*. 2003:15(2), 2.
  30. Erikson EH. *Identity and the life cycle* [reissued]. Noton paperback: NY. 1994.

# Inhibition Activity of Water Hyacinth Leaf Extract (Eichornia Crassipes) to the Growth of Subgingival Plaque Bacteria Colony

Ayu Arismawati<sup>1</sup>, Noer Ulfah<sup>2</sup>, Lambang Bargowo<sup>2</sup>

<sup>1</sup>Undergraduate Student of Dental Medicine Faculty, Airlangga University, Surabaya-Indonesia,

<sup>2</sup>Lecturer in Department of Periodonsia Dentistry, Faculty of Dentistry, Airlangga University, Surabaya, Indonesia

## Abstract

**Background:** Periodontitis is an infectious disease in periodontal tissue and is able to cause a plaque that contains bacteria on the teeth. These bacteria colonize the oral cavity, invade the periodontal tissue, and attack the body's host system. Indonesia has many floras and one of them is called Water hyacinth. This flora is commonly known as waste because its ability to pollute the environment. However, water hyacinth has a useful material including alkaloids, flavonoids, and tannins that can be used as the antibacterial agents. The study aims to determine the effect water hyacinth leaf extract (*Eichorniacrassipes*) to the growth of subgingival plaque bacteria colony. **Method:** The study was conducted by using serial dilution techniques in the BHIB media with 100%; 50%; 25%; 12,5%; 6,25%; 3,125%; 1,56%; 0,78% concentrations and planting on MHA medium. The analysis method in this study uses the Shapiro-Wilk Test, Levene's Test, and statistical tests with One-Way Anova.

**Results:** There are significant differences at the growth of sub gingival plaque bacteria. There is no growth of subgingival plaque bacteria in groups of 100%; 50%; 25%; 12.5% and 6.25%. The growth of subgingival plaque bacteria colonies was only seen at 3.125% concentration and increased the number of bacteria colonies at a 1.56%.

**Conclusion:** Water hyacinth leaf extract was effective to inhibit the growth of sub gingival plaque bacteria colonies.

**Keywords:** *Antibacterial, bacteria colonies, Eichorniacrassipes, sub gingival plaque bacteria.*

## Introduction

Periodontal disease and dental caries are two diseases that mostly affect the severity of dental and oral diseases. Tooth loss in adults is a result of the severe periodontal abnormalities and is found in 5-15% of the world's population<sup>1,2</sup>.

Periodontitis is an infectious disease in periodontal tissue with various manifestations, starting from inflammation of the gingiva, formation of periodontal pockets, loss of supporting bone until the occurrence of a date tooth<sup>3</sup>. In addition, this disease is also characterized by the inflammation that causes damage to collagen fibers, the gingival matrix, periodontal ligaments, and alveolar bone<sup>4</sup>. Periodontitis is often associated with infections from various bacteria, such as *Porphyromonasgingivalis*, *Tannerella forsythia* and *Aggregatibacteractinomycetemcomitans*. The occurred tissue damage that is the result of complex interactions of these bacteria with the response of the host as well as the inflammatory process<sup>5</sup>.

---

### Corresponding Author:

Noer Ulfah

Lecturer in Department of Periodonsia Dentistry,  
Faculty of Dentistry, Airlangga University, Surabaya,  
Indonesia

e-mail: noer\_ulfah@yahoo.com

During the inflammation process, bacterial products are released and penetrate into the periodontal tissues. Afterward, those bacterial products activate the host immunoinflammatory response by producing cytokines and matrix metalloproteinase which can cause damage to the extracellular matrix of the periodontal tissue. The matrix metalloproteinase is a proteolytic enzyme that causes damage to the extracellular matrix, periodontal ligament, and the bone protein matrix. Thereby, MMP plays an important role in the regulation of periodontal tissue damage<sup>6</sup>.

Dental plaque is the main factor which causes the early periodontal abnormalities and known as gingivitis – a process of inflammation in the gingiva<sup>7</sup>. Plaque formation begins with the formation of dental pellicles on the clean surface of the tooth in minutes. These bacteria can bind to receptors on the dental pellicle. Initial colonization is started by gram-positive facultative bacteria, such as *A. viscosus*, *S. sanguis*. This plaque develops rapidly in the early development of the biofilm and progressively slows down during the biofilm maturation<sup>8</sup>. The next stage is secondary colonization by bacteria such as *Prevotellaintermedia*, *Prevotelleloescheii*, *Capnocytophagaspp*, *Fusobacteriumnucleatum*, and *Porphyromonasgingivalis*. These bacteria have the ability to attach at the different species of plaque microorganisms. If the plaque is not cleaned, it will develop into the subgingival area which causes subgingival plaque formation<sup>9</sup>.

Nowadays, the modern medical world of the molecular field is very advanced, but this does not stop the traditional medicine to exist. This is proved by the many traditional medicines that are widely used by the medical world to treat diseases. Some plants are known for their antibacterial activity<sup>10</sup>.

Water hyacinth is a plant that floats on the surface of the water as well as has thick leaves and air-filled stems which make this plant float. This plant is considered disturbing because it can spread in large areas of the water and cover the surface of the water. Thereby, it can reduce the light that penetrate trough the water and result in reduced oxygen in the water. Other affect include silting the lake or other waters due to water hyacinth that dies and settles on the bottom. But the content of the water hyacinth plants is secondary metabolites of alkaloids, flavonoids, tannins, which known as antibacterial, antiviral, and anticancer<sup>11</sup>. Based on the background, the aims of the study is to analyse the inhibition activity of

water hyacinth leaf extract (*Echiorniacrassipes*) to the growth of subgingival plaque bacteria colony.

## Material and Method

This type of research is a laboratory experiment with the design of the Post-Test Only control group design<sup>12</sup>. This research was conducted in the Research Center Dental Medicine Faculty, Airlangga University and Pharmacy Laboratory, Airlangga University, East Java.

The tools and materials used are test tubes and shelves, buchner funnel, petri dish, glass gourd, incubator, micropipette, osse, spreader, rotary evaporator, scales, auctoclave, water hyacinth leaf extract (*Eichornia Crassipes*), subgingival plaque bacteria stock, *Brain Heart Infusion Broth* (BHIB) media, and *Mueller Hinton Agar* (MHA)media

**Making Hyacinth Leaf Extract:** Water hyacinth leaves are dried with oven in 50°C until dry. After the drying process, then the grinding one is conducted using a blender to get water hyacinth powder granule, as much as 600 grams of water hyacinth leaves macerated with 2500 ml ethanol 96% solvent. Moreover, stirred with a stirrer for 24 hours and filtered using whatmann paper which is placed on a Buchner funnel and obtained by filtrate. Centrifuged 50 rpm for 24 hours. The sediment obtained is then evaporated using a rotary evaporator for 4 hours. Finally, the conduct and evaporation above the water bath until finished, and then evaporated again until there is no residual ethanol content.

Stage of Inhibition Activity Test for Water Hyacinth Leaf Extract to The Growth of Subgingival Plaque Bacteria

The inhibitory test in this study uses a liquid dilution method with serial dilution as well as some steps. Firstly, we have to prepare 9 test tubes with 1 test tube containing subgingival plaque bacteria stock which has been prepared and labeled. The test tube no. 1 containing 10 ml of water hyacinth leaf extract, eight other test tubes filled with BHIB media as much as 5 ml. After the other eight tubes were filled with BHIB, 5 ml of extract was put in the tube no. 1 then stirred it. Afterward, 5 ml of liquid from the tube no. 1 were taken and put in tube no. 2 and stirred again. The next one, 5 ml of liquid from the tube no. 2 are taken and put in the tube no. 5. Stirred it again, and repeated until the liquid is put in the tube No. 8. In addition, the 5 ml of liquid from tube no. 8

is removed so that the liquid in each tube has the same liquid volume.

After all of the media are prepared, 1 ml of subgingival plaque bacteria stock is inserted into each tube containing a mixture of BHIB and the extract. The remaining tubes containing only 5 ml of BHIB media were negative controls, and the tubes containing subgingival plaque bacteriastock were positive controls. All the treatment above was repeated three times to obtain adequate sample size. The tubes were incubated at 37°C for 24 hours

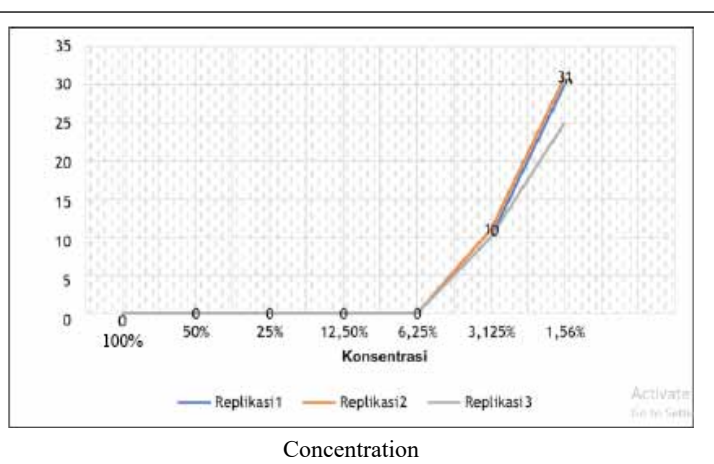
After 24 hours incubated, each tube is taken 1 osse and planted on Mueller Hinton Agar (MHA) media by strike move to check there is bacteria growth or not. Incubation is conducted for 24 hours at 37°C. After the second incubation, we have to take 0.1 ml from the boundary tube between the bacteria growth and the non-positive. The negative control then planted on the MHA media. Enter it into the incubator at 37°C for 24 hours. Calculates the number of bacteria colonies that grow on MHA media after the last incubation and do the data analysis.

### Results

The results of this study can be seen from the number of subgingival plaque bacteriacolonies growth.

**Table 1. The number of subgingival plaque bacteriacolonies given water hyacinth leaf extract (*Eichhorniacrassipes*) at a concentration of 1,56%-100%**

Concentrations	1	2	3
100%	0	0	0
50%	0	0	0
25%	0	0	0
12,5%	0	0	0
6,25%	0	0	0
3,125%	10	12	11
1,56%	31	30	33
Positive controls	149	151	152
Negative controls	0	0	0



Based on the results of the study it can be seen that there is no growth of subgingival plaque bacteria in groups of 100%; 50%; 25%; 12.5% and 6.25%. The growth of subgingival plaque bacteria colonies was only seen at 3.125% concentration and increased the number of bacteria colonies at 1.56%.

The measurement results are tabulated according to each group sample and followed by testing the normal distribution using the Shapiro-Wilk Test with Sig > 0.05. It can be concluded that the data are normally distributed. Afterward, the homogeneity testing using Levene's Test with Sig. < 0.05 can be concluded that the data is homogeneous. Afterward, the statistical tests were conducted using One-Way Anova at the significance level of Sig. < 0.05 and significant differences were obtained. Finally, it then continued by performing

multiple comparisons using Post-hoc Tukey Anova which concluded that all groups had significant differences.

### Discussion

The results of the analysis showed that the number of colonies at a concentration of 3.125% had a significant difference with the number of colonies at a concentration of 1.56% and positive control. Likewise, the number of colonies in the extract of water hyacinth leaves concentration of 1.56% has a significant difference to the number of colonies in the positive control group. This shows that the extract of water hyacinth leaves at a concentration of 3.125% and 1.56% has a fairly good antibacterial effect. The results of this study also showed a bactericidal effect of 6.25% where subgingival plaque bacterial colonies were completely invisible and the



inhibitory power was best at a concentration of 3.125%, where the subgingival plaque bacteria could grow at minimal number. This is due to the presence of bioactive substances in water hyacinth leaves which have been studied as antibacterial, and the quantity of concentration that contains bioactive substances that play a role in inhibiting bacteria.

Based on scientific research stated that water hyacinth leaf extract contains alkaloids, flavonoids, and tannins which are known to have antibacterial power that can inhibit bacterial growth<sup>10</sup>. The alkaloids contained in the hyacinth leaf extract has antibacterial biological activity that can interfere with the constituent components of the bacterial cell that make the cell wall not formed and easily get lysed<sup>11</sup>. Antibacterial flavonoids has a working mechanism that can interfere bacterial membrane synthesis, and inhibits bacterial metabolism – which can damage bacterial breeding pathways and damage bacterial membrane walls that will be followed by the bacterial death<sup>13</sup>. This compound will also interfere with the energy metabolism in a similar manner to the respiratory system because the energy demand for active absorption of various metabolites and the biosynthesis of macromolecules insufficient so that lead to bacterial death<sup>14</sup>. Tannin known to has antibacterial activity related to their ability to form hydrogen bonds which results in protein denaturation in the membrane so that cells experience damage. Membrane damage causes the fulfillment of nutrients needed by bacteria cannot be achieved. This can be disrupted the bacterial metabolism and reduce the bacterial energy<sup>15</sup>.

### Conclusion

Water hyacinth leaf extract was effective to inhibit the growth of sub gingival plaque bacteria colonies. So, it is expected to preserve the water hyacinth plant and cultivate it.

**Ethical Clearance:** The research process involves participants in the survey using a questionnaire that was accordant with the ethical research principle based on the regulation of research ethic committee. The present study was conducted in accordance with the research principles. This study implemented the basic principle ethics of respect, beneficence, nonmaleficence, and justice.

**Conflict of Interest:** There is no conflict of interest for all authors

**Source of Funding:** This study is done with individual funding

### References

1. Engström M, Eriksson K, Lee L, Hermansson M, Johansson A, Nicholas AP, et al. Increased citrullination and expression of peptidylarginine deiminases independently of *P. gingivalis* and *A. actinomycetemcomitans* in gingival tissue of patients with periodontitis. *Journal of translational medicine*. 2018;16(1):214.
2. Petersen PE. The World Oral Health Report 2003: continuous improvement of oral health in the 21st century—the approach of the WHO Global Oral Health Programme. *Community Dentistry and oral epidemiology*. 2003;31:3–24.
3. Kinane DF, Stathopoulou PG, Papapanou PN. Periodontal diseases. *Nature Reviews Disease Primers*. 2017;3(1):1–14.
4. Ilgenli T, Vardar-Sengul S, Gürkan A, Sorsa T, Stackelberg S, Köse T, et al. Gingival crevicular fluid matrix metalloproteinase-13 levels and molecular forms in various types of periodontal diseases. *Oral diseases*. 2006;12(6):573–9.
5. Silva N, Dutzan N, Hernandez M, Dezerega A, Rivera O, Aguillon JC, et al. Characterization of progressive periodontal lesions in chronic periodontitis patients: Levels of chemokines, cytokines, matrix metalloproteinase-13, periodontal pathogens and inflammatory cells. *Journal of clinical periodontology*. 2008;35(3):206–14.
6. Gursoy UK, Liukkonen J, Jula A, Huuonen S, Suominen AL, Puukka P, et al. Associations between salivary bone metabolism markers and periodontal breakdown. *Journal of periodontology*. 2016;87(4):367–75.
7. Al-Bayaty FH, Al-Koubaisi AH, Ali NAW, Abdulla MA. Effect of mouth wash extracted from *Salvadora persica* (Miswak) on dental plaque formation: a clinical trial. *J Med Plant Res*. 2010;4(14):1446–54.
8. Marsh PD, Moter A, Devine DA. Dental plaque biofilms: communities, conflict and control. *Periodontology 2000*. 2011;55(1):16–35.
9. Alzoreky NS, Nakahara K. Antibacterial activity of extracts from some edible plants commonly consumed in Asia. *International journal of food microbiology*. 2003;80(3):223–30.

10. Muladi S. Kajian Eceng Gondok sebagai Bahan Baku Industri dan Penyelamat Lingkungan Hidup di Perairan. In: *Prosiding Seminar Nasional IV Masyarakat Peneliti Kayu Indonesia (MAPEKI) Samarinda*. 2001.
11. Retnowati Y, Bialangi N, Posangi NW. Pertumbuhan bakteri *Staphylococcus aureus* pada media yang diekspos dengan infus daun sambiloto (*Andrographis paniculata*). *Sainstek*. 2011;6(2).
12. Berniyanti T, Fardhani A, Palupi R, Bramantoro T, Ramadhan D, Ramadhani A, et al. Effect of blood iron level on prevalence of recurrent aphthous stomatitis (RAS) in traffic police officers. *Indian Journal of Public Health Research and Development* [Internet]. 2019;10(8):1103–8. Available from: <https://www.scopus.com/inward/record.uri?eid=2-s2.0-85073549846 & doi=10.5958%2F0976-5506.2019.02044.8 & partnerID=40 & md5=5669a15aeaf32c85a7252aea2fdcf59e>
13. Roy R, Tiwari M, Donelli G, Tiwari V. Strategies for combating bacterial biofilms: A focus on anti-biofilm agents and their mechanisms of action. *Virulence*. 2018;9(1):522–54.
14. Cushnie TPT, Lamb AJ. Recent advances in understanding the antibacterial properties of flavonoids. *International journal of antimicrobial agents*. 2011;38(2):99–107.
15. Sofiane G, Wafa N, Ouarda D. Antioxidant, antimicrobial and anti-inflammatory activities of flavonoids and tannins extracted from *Polypodium vulgare* L. *Asian J Biochem Pharm Res*. 2015; 5:114–22.

# Study to Compare Progrid Mesh vs Conventional Mesh in Lichtenstein's Open Inguinal Hernia Repair

Mohammad Farooque Dudhwala<sup>1</sup>, Chiraag Hiran S.<sup>2</sup>,  
Vipul Gurjar<sup>3</sup>, Honeyalsinh H. Maharaul<sup>4</sup>, Vipul Shory<sup>5</sup>

<sup>1</sup>Assistant Professor, <sup>2</sup>Resident, <sup>3</sup>Professor, <sup>4</sup>Associate Professor, <sup>5</sup>Resident, Department of General Surgery, Dhiraj General Hospital, Smt. B.K. Shah. Medical . Institute and Research Centre, Sumadeep Vidyapeeth Deemed to be University (An Institution), Waghodia, Pipariya, Vadodara, Gujarat, India

## Abstract

**Background:** A hernia is protrusion of a tissue or an organ such as omentum or bowel loops through a defect in the weakened abdominal wall muscles . Amongst the various types of hernia, inguinal hernia is the most commonest. The best modality of treating an inguinal hernia is surgery and hence most common surgery done is inguinal hernia repair . Amongst the various techniques of hernia repair, Lichtenstein's tension free meshplasty is the latest, best and has become the gold standard . In 2008, COVIDIEN launched progrid mesh which is a self fixating mesh used in both inguinal and incisional hernia repair . Progrid mesh is made up isoelastic lightweight macroporous knitted monofilament polypropylene fabric that incorporates resorbable poly lactic acid fabric on one side of the mesh to provide self fixation during first few months of implantation.

**Aim:** The aim of this study is to compare the outcome on basis of incidence of postoperative pain and operative time of self fixating pro-grip mesh with conventional mesh in Lichtensteins open inguinal herniomeshplasty .

### Objective:

- Comparing outcome in terms
- Post-operative pain
- Operative time

**Conclusion:** Lichtenstein's open inguinal herniomeshplasty using self-fixating Progrid mesh has an advantage over conventional mesh repair as it requires less operative time and the incidence of postoperative pain is less frequent and occurs at an even more later period compared to conventional mesh repair which at times is found to be present even at post-operative day 2.

**Keywords:** Lichtensteins Inguinal herniomeshplasty, self fixating Progrid mesh.

## Introduction

An inguinal hernia occurs when any tissue, protrudes through a weak spot in the anterior abdominal wall muscles . Amongst the types of hernia, the most common type is inguinal hernia . And the best modality of treating an inguinal hernia is surgery .

Inguinal hernia can be repaired either in its old traditional modality of open hernioplasty or its new modality of laparoscopic hernioplasty . But each

---

### Corresponding Author:

**Dr. Honeyalsinh H. Maharaul**

Associate Professor, Smt. B.K. Shah Medical Institute and Research Centre, Sumadeep Vidyapeeth Deemed to be University (An Institution), Pipariya Vadodara  
e-mail: honeyal.219@gmail.com  
Phone: 9426345105

technique has got its advantage and disadvantage, despite that the main goal of any hernia repair is to provide the best and strongest repair, least recurrence rate, least possible discomfort and quickest recovery.

#### **In open method hernia can be managed by:**

- Herniotomy
- Herniorraphy
- Hernioplasty

Laparoscopic repair is the recent advancement. It can be done by 2 ways with mesh fixation and without mesh fixation and can be by two approaches :

- Total Extra Peritoneal (TEP)
- Trans Abdominal Preperitoneal (TAPP)

Inguinal hernia repair still remains a problem because of chronic groin pain following mesh repair.

One of the most commonly performed surgical procedures is inguinal hernia repair but despite being most common it is associated with long term risks of pain and discomfort. In 1996, according to a study done by Cunningham et Al, he was the first to report 63% pain incidence after one year [1] . In a large cross sectional cohort study the rate of chronic pain was 29% at around 5 years following the surgery.

The mesh is supposed to be a foreign body implanted into our body which resulted in loss of myelinated axons, axonal, peri and endoneuronal edema and subsequently pain [2] . The method of fixation may be an important causative factor for pain . For fixation most commonly used is the sutures which may cause ischaemia or nerve damage which eventually leads to pain . Mesh implantation can be done by several techniques, but the most commonly involved technique is by sutures to anchor the mesh in position and prevent its migration, curling and wrinkling. But these sutures that anchor the mesh can cause extensive tissue tension and nerve entrapment which are considered to be leading causes to prolonged post-operative pain, which is the main primary objective to be looked in our study . This problem does not solve even on application of absorbable sutures instead of non-absorbable ones.

The new progrid mesh is Isoelastic large-pore lightweighted, knitted, monofilament polypropylene fabric that incorporates microgrips which are resorbable and these only provide self-gripping fixation. It promotes

the regeneration of healthy tissue inside its microgrips and shows low rate of complications with 100% self fixation [3][4] . Hence our present study is to enlighten the advantage of this self gripping progrid mesh in reducing the incidence of chronic groin pain after inguinal hernia repair and reduce the operative time as it leads to less exposure to anaesthetic drugs.

## **Materials and Method**

The prospective study was conducted between July 2019 to June 2020 and around 20 patients were divided into two groups with inguinal hernia and were admitted to Dhiraj General Hospital, S.B.K.S.M.I.R.C, Pipariya, Vadodara, Gujarat, India.

### **Inclusion Criteria:**

Patients diagnosed with inguinal hernia and planned for lichtensteinsinguila hernia repair

Willing for study

Anaesthetically fit patients .Exclusion criteria :

- Patient not willing for study.
- Paediatric age group patients
- Patient not fit anaesthetically.

**Method of collection of data:** This study involves 20 patients coming with chief complaints of swelling in the inguinal region. Detailed history and clinical examination was done. Written and Informed Consent was obtained for taking part in study and for operative procedure. Patients were randomly divided into two groups A and B, each group containing 10 patients each.

Group A patients were planned for Lichtenstein's repair with conventional mesh.

Group B patients planned for Lichtenstein's repair with self fixating pro-grid mesh.

Time period starting from skin incision to placing and fixation of mesh in each group will be noted.

Post-operative pain were noted according to pain score during post operative hospital stay and after discharge on 15th day and 3 months of follow up

### **Procedure:**

Patient in supine position following spinal anaesthesia

**Parts painted and draped:** Skin incision placed approximately 1.25 cm above an imaginary line joining pubic tubercle and anterior superior iliac spine.

Skin and subcutaneous tissue incised and external oblique aponeurosis identified .

Small incision placed over the EOA along the fibres

External oblique aponeurosis opened upto the superior inguinal ring medially and deep inguinal ring laterally .

Inguinal canal opened and space created upto conjoint tendon medially and upturn part of inguinal ligament laterally .

Spermatic cord identified, stretched and lateralisation of cord structure done .

Defect identified of size approximately 2x2 cm through which hernial sac was protruding .

Inferior epigastric artery identified and found to be lateral to the hernial sac (direct inguinal hernia) .

Hernial sac identified and reduced and posterior wall repair done with prolene no. 1 R.B .

Progrid mesh was taken after creating good space underneath and around the spermatic cord



**Figure 1: Showing usage of progrid mesh for hernioplasty**

Master suture taken on pubic tubercle with blue mark on pro-grip mesh with prolene 1-0 R.B and the mesh spread properly.

All layers re sutured back as opened

EOA sutured in continuous fashion with prolene 2-0 R.B and artificial superficial ring created

Subcutaneous layer sutured with vicryl 2-0 R.B

Skin sutured with ethilon 2-0 R.C with subcuticular technique

Sterile dressing done after attaining hemostasis

Patient shifted to post op room as was vitally stable

## Discussion

The Lichtensteins tension-free technique has gained remarkable popularity as it is easy-to-perform with less tissue dissection<sup>[5]</sup>. But questions concerning the safety of implantation of mesh for longer duration and the risk of chronic pain have always been around . Various studies have reported the rate of prolonged pain after inguinal hernia surgery to increase from 9.7% to 51.6%<sup>[6]</sup>; and the incidence of persistent postoperative pain is reported to be as high as 6% which hinders with daily activities of the patient.

**The reason for such pain is unclear . But it can be due to:**

- Mesh material that is its structure and interaction with tissue

- Scarring
- At times nerve damage
- Entrapment by sutures

Because of these facts, fixation of the mesh with sutures during surgery continues to be an important factor to be thought and discussed about.

Hence a new self-gripping mesh (Progrid) has been developed in 2008 by COVIDIEN .

**This self-gripping mesh is made of:** Isoelastic large-pore lightweighted, knitted, monofilament polypropylene fabric that incorporates microgrips which are resorbable and these only provide self-gripping fixation in the initial few months of implantation<sup>[7]</sup>.

**The microgrips are:** 1-mm projections that are club in shape and are made up of polylactic acid which is biodegradable.

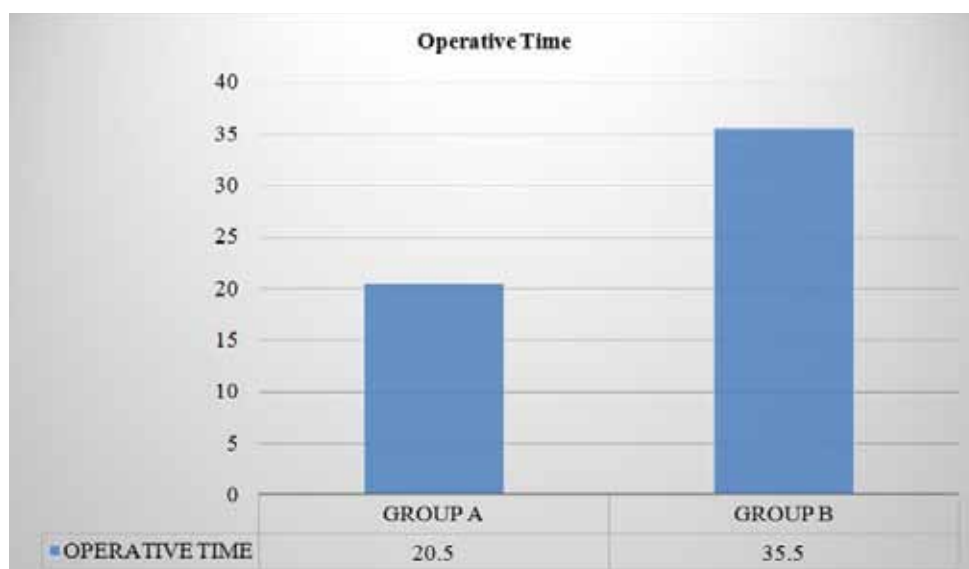
The microgrips integrate for upto 0.5 mm into the tissue and provides stronger tissue incorporation at almost around 5 days.

Hence because of these features available in the self fixatingprogrid mesh can be placed in position safely and proper without the requirement for sutures which can penetrate underlying tissues and might damage cutaneous nerves<sup>[8]</sup>.

### Result

**Operative time :** Conventional mesh repair on an average takes around 35.5 minutes starting from skin incision to closure, whereas progrid mesh repair takes only around 20 mins .

**Postoperative pain :** as noted in these patients, after conventional mesh repair the GROUP B complaints of chronic pain even after 3 months . Whereas in GROUP A progrid mesh repaired patients they were pain free after post operative day 2 and on follow up after 3 months.



**Figure 2: Showing time variation between the operative time between conventional hernioplasty and usage of progrid mesh.**

### Conclusion

Lichtenstein’s open inguinal herniomeshplasty using self-fixating Progrid mesh has an advantage over conventional mesh repair as it requires less operative time and the incidence of post-operative pain is less frequent, mostly painless and occurs at an even more later period compared to conventional mesh repair which at times is found to be present even at post-operatvd day 2.

**Ethical Clearance:** Taken from sumandeept vidyapeeth institutional ethics committee

**Source of Funding:** Self

**Conflict of Interest:** Nil.

### References

1. J Cunningham, W J Temple, P Mitchell, J A Nixon,

- R M Preshaw, N A Hagen et al . Cooperative Hernia Study. Pain in the Postrepair Patient . Ann surgery, 1996 Nov; 224(5):598602.
2. Lichtenstein ME. The custom-tailored inguinal hernia repair. J Okla State Med Assoc 1954; 47:222-4.
  3. Dynamic implant for inguinal hernia repair in porcine experimental model. A feasibility study. Hernia 2009; 13:S1-332.
  4. Dynamic autostatic implant for inguinal hernia repair. Early results in an explorative cohort of patients. Hernia 2010; 14:S55-100.
  5. Nienhuijs S, Staal E, Strobbe L, Rosman C, Groenewoud H, Bleichrodt R. Chronic pain after mesh repair of inguinal hernia: a systemic review. Am J Surg 2007; 194:394-400.
  6. Merskey H, Bogduk N. Classification of chronic pain: descriptions of chronic pain syndromes and definitions of pain terms. In, Task force on Taxonomy. IASP, 2nd edition. Seattle, WA: IASP press, 1994; 209-14.
  7. Awad SS, Fagan SP. Current approaches to inguinal hernia repair. Am J Surg 2004; 188 (6A Suppl):9S16S.
  8. Singh S. Innovative and regenerative hernia repair with dynamic implants. IHS Newsletter 2012; 6(2): 5- 8.

# TMEM121 Protein Is a Regulation Factor in the Proliferation Activity of the Adrenocortical stem/Progenitor Cells

Mohammed Abdalmalek Ali Al-Bedhawi

*Scholar researcher, Institute of Genetic Engineering and Biotechnology, University of Baghdad, Iraq*

## Abstract

Several studies have identified adrenocortical sub-population cells located in the capsule/sub-capsular area, carrying the aspects of stem/progenitor cells. We previously recognized a novel protein (Tmem121) highly expressed in in this sub capsular area and also highly co-localised with Ki67 in this area. The suggestion of these previous studies was considered to clone and transfect Tmem121 into adrenocortical stem/progenitor cells studying the proliferation changes in the transfected cells. Adrenocortical stem/progenitor cells were isolated and cultivated *in vitro*. The cells were previously isolated and prepared for testing the effect of Tmem121 after three months of *in vitro* cultivation. Specific primers were used to detect and amplified the coding sequence of the TMEM121 using RT-PCR followed by cloning into pIRES2-ERFP vector. Immunocytofluorescent tests were carried out to detect the forced expression of TMEM121 into these cells. Real time PCR assays were followed with specific primers to detect the synchronization of Tmem121 expression with two proliferation markers Ki67 and proliferating cell nuclear antigen (PCNA). Immunocytofluorescent tests results showed a significant expression of TMEM121 into these cells. Real time PCR results showed a significant increase in the expression of both proliferation markers Ki67 and (PCNA). These results suggested a propagating effect of TMEM121 to the adrenocortical stem/progenitor cells.

**Keywords:** *Tmem121, proliferation, adrenocortical stem/progenitor cells, PCNA and Ki67.*

## Introduction

Adrenal cortex have been suggested to have a clusters of undifferentiated cells in the capsule and sub-capsular area with limited steroidogenic capacity in mice<sup>(1)</sup> and humans<sup>(2)</sup>. These cells have shown a relatively high proliferating activity and suggested to represent the stem/progenitors cells that responsible of replenish the adrenal cortex<sup>(3)</sup>. More recent studies also suggested these cells occupied the capsule and the sub-capsular areas as a stem/progenitor neich<sup>(4-6)</sup>.

Although Tmem121 was a poorly studied protein, recent findings regarding its role have been developed. Tmem121 is a member of a family are highly expressed in most embryonic tissues<sup>(7)</sup>. A wound healing study showed that Tmem121 is one of the genes that contribute to cell proliferation and migration in human endothelial cells<sup>(8)</sup>. However a recent study forced its expression into MDA cell line but showed no significant effect on the proliferation activity of these cancer cells (un-published data). A histological study showed high expression

of Tmem121 in capsule and sub-capsular areas of the adrenal cortex with relatively high co-expression of Tmem121 with Ki67 on the adrenal sections<sup>(9)</sup>. These finding suggested study the effect of cloning and transfection of Tmem121 in more specific cells as adrenocortical stem/progenitor cells to investigate its role in the proliferation activity.

## Materials and Method

Experiments that conducted in this study were in agreement with all the guidelines and regulations of the committee on experiments of the school of biomedical sciences, University of Reading, UK.

**Animals:** Adrenal glands used in this study were freshly isolated from adult Wistar-rats (weight 250-350g) from Harlan Envigo UK were housed in rooms where the ambient temperature and light were under automatic control. The rats were treated under the United Kingdom Home Office Animals Act 1986. Rats were euthanised by CO<sub>2</sub> asphyxiation.



**RNA isolation, cDNA synthesis and RT-PCR:** TRIzol reagent (Ambion) was used for the isolation of RNA from rat adrenals following the protocol previously described<sup>(10)</sup>. For synthesis of total cDNA, a RevertAid First Strand cDNA synthesis kit was used. PCR was used to detect the expression of the Tmem121, as well as amplifying its full coding sequence. PCR was used to target transcript variant X1, mRNA (accession number is XM\_006225896.3) using specific pair of primers. These primers were designed with NCBI primer design tool. The reaction mixture of PCR included 25µl of 2x master mix of Extensor Hi-Fidelity PCR which mixed with, 1µl of (10µM) Forward primer 5'-3' GCAGGACCTCGTCCCGCTTT That positioned in the sequence (194-217) and 1µl of (10µM) Reverse primer 5'-3' TAGTCCAGCGTCTGTGCGGC that positioned in the sequence (1252-1233)). PCR conditions for this reaction were as follows: 94°C for 1 minute for the initial denaturation and, followed by 36 cycles of 94°C for 20 seconds for denaturation, 59°C for 20 seconds for primer annealing, finally the extension at 72°C for 3 minutes. After cycling, PCR products were separated by electrophoresis on a 1% (w/v) agaros gel with 1kb plus ladder (generuler). The targeted bands were excised and the DNA purified from the gel using QIAquick Gel Extraction Kit (Qiagen).

**Tmem121 gene cloning:** The amplified segment of the Tmem121 was applied to the next PCR to add the restriction sites that required for cloning. Primers for this PCR were new and designed to have the same sequences in addition to restriction site sequence and CGC or GCG platform up-stream the primers. The two restriction sites of the two primers were chosen carefully to set the gene of interest correctly in the vector (pIRES2-ERFP is a modified version of the pIRES2-ERFP) and not cut through the gene sequence. The EcoRI restriction sequence (5'-GAATTC-3') was added upstream the Tmem121 forward primer and the HindIII restriction sequence 5'-AAGCTT-3' was added upstream the reverse primer. Primer sequences for cloning Tmem121 gene into pIRES2 ERFP vector were: EcoRI-forward primer (5' GCGGAATTCGAGGACCTCGTCCCGCTTT 3') and HindIII -reverse primer (5' CGCAAGCTTTAGTCCAGCGTCTGTGCGGC 3').

The components of the cloning PCR reaction were mixed as described previously using the PCR product of the first PCR as DNA template. The targeted band of the Tmem121 was excised and the DNA purified.

**Digestion, ligation and transformation of competent cells:** Both the plasmid and insert were digested with the two restriction enzymes (Promega), The components were assembled in a total volume of 20µl using 2µl of 10x 10X MULTI-CORE™ Buffer (Promega), The reactions were mixed and then incubated for 2-4 hours at 37°C in a water bath. The digested DNA was profiled by agarose gel electrophoresis. The targeted bands of the digested vector and the digested gene of interest were excised and purified. Ligation reactions were carried out using T4 ligase (Promega) to ligate the gene of interest to the pIRES2-ERFP vector. This addition of the DNA insert and vector was conducted using a 3:1 (insert: vector DNA) molar ratio. The reactions were mixed and incubated overnight at 4°C. Ultra Competent™ cell (Mach1™ *Escherichia coli* (*E. coli*)) were prepared.

**Purification and sequencing of insert-vector complex:** The blue-white screening was conducted for identifying recombinant bacteria that contained the plasmid of interest. Plasmid DNA was isolated using Midiprep purification kit according to the provider's recommendations. The purified complexes were sequenced. Ten microliters of the purified plasmid (100ng/µl) were submitted to Source BioScience for sequencing in both directions using the appropriate primer sites located in pIRES2-ERFP vector.

**Adrenocortical stem/progenitor cell preparation:** Adrenal cortex cells were isolated following the method previously described by Al-Bedhawi, (2018)<sup>(10)</sup>. The cells were dispersed in minimum essential media (MEM) containing 0.6 mg/ml collagenase type I (Worthington) and pancreatin (Sigma) 0.5 mg/ml. After each digestion the enzymatic activity was inhibited by the addition of 10% foetal calf serum (FCS) to the medium. Cell viability was assessed using trypan blue The isolated cells were maintained in culture medium at 37°C in humidified atmosphere of 5% CO<sub>2</sub> in air. Magnetic Activated Cell Sorting (MACS) was used to isolate target cells that were expressing Thy-1 using Thy-1 antibody attached to Pierce NHS-Activated magnetic beads following the protocol from the manufacturer.

**Transfection of cells with Tmem121:** The transfection was carried out using ransfection reagent (TurboFect) after cloning of Tmem121 into pIRES2 ERFP vector. As well as transfection with the plasmid only without insert (native-plasmid) as controls. Cells were 70-80% confluent at the day of transfection. The

efficiency of the transfection was examined using an inverted fluorescent microscope (Inverted Epifluorescent Microscope AXIO) to evaluate the rate of the transfection

#### Immunocytofluorescence:

Dual Immunocytofluorescence assays were conducted to confirm the transfection efficiency and the expression of Tmem121 pattern in the Thy-1 cells (stem/progenitor adrenocortical cells). Cells were incubated with the primary antibodies: Thy-1 antibody, diluted to 1.5µg/ml and Tmem121 1:200 dilution (ab151077) overnight at 4°C. The cells were washed with PBS (3x), incubated with 546 or 647 Alexa-fluor conjugated secondary antibody at a 1:200 dilution for 30 min before washing with PBS (3x). The coverslips were mounted with DAPI (VECTASHIELD). In the immunocytofluorescence both primary and secondary antibodies (mouse and rabbit) were mixed together in the primary and secondary incubation steps, respectively.

**Real time PCR assays:** Two-step quantitative RT-PCR (RT-qPCR) was employed to detect changes in the gene expression of Tmem121, and the proliferation

markers Ki67 and PCNA after the transfection of Tmem121 to the target cells. Cells were collected after 2 and 4 days of transfection. The RNA was isolated from the transfected cells using RNeasy mini kit (Qiagen). The isolated RNAs from the biological replicates were mixed together before conducting the cDNA synthesis. Equal RNA concentration (400ng) was used to make the first-strand cDNA. qPCR reactions were set up to analyse the gene expression as fold changes using the  $\Delta\Delta C_t$  method in comparative quantification.  $\beta$ -Actin was the housekeeping gene in this experiment. qPCR primers were designed. The details of qPCR primers are in (Table 1). The reaction of each well was set up as follows: 0.3µL primers mix (5µM) each, 7µl of 2x quantiTect SYBER Green PCR master mix (Qiagen) and 6.7 µl of the diluted cDNA. The qPCR program was as follow: initial denaturation at 95°C for 15 minutes was used and then 40 cycles of 95°C for 15 seconds followed by 60°C for 1 minute. The final step was to show the melting curve of the products. qPCR was performed using a computerized AB Applied Biosystem.

**Table 1: List of primers (Invitrogen) used in the RT-qPCR, their accession number, position in the mRNA sequence and their product size.**

Gene	Forward primer 5'-3'	Reverse primer 5'-3'	Fragment Size (bp)	Accession number
$\beta$ -Actin	CACCCGCGAGTACAACCTTC	CCCATACCCACCATCACACC	207	NM_031144.3
Tmem121	GCCTTAGATCTGCTGGATCTGC	CCCTTGCATACTGACCTCACTG	159	XM_006225896.3
Kia67	TTCCAGACACCAGACCATGC	ACTGGTCTTCTGGTTGTGG	89	XM_006230453.2
PCNA	AGGACGGGGTGAAGTTTTCTG	AGCAAAAGTTAGCTGAACTGGC	134	NM_022381.3

**Statistical Analysis:** Results of RT-qPCR data were analysed using Dunnett's Multiple Comparison Test of one-way analysis of variance (ANOVA).

### Results and Discussion

RT-PCR experiments were successfully carried out to amplify the whole coding sequence of Tmem121. RNA isolation from rat adrenals was achieved with concentrations ranged from (0.8-1.2µg) with high purity. Aliquots of RNA were used for cDNA synthesis followed by PCR to amplify the full coding sequence of Tmem121 using specific primers. The amplified amplicon was successfully detected, excised and purified

from agarose gel after electrophoresis. The purified DNA band of Tmem121 was used as template in a second PCR using specific primers of same sequences in addition to restriction site sequence and platform up-stream the primers. The resulted PCR product was profiled on agarose gel electrophoresis, which showed a single band represents the full coding sequence of Tmem121 flanked by the EcoR1 restriction sequence and HindIII restriction sequence to be ready for digestion with those two enzymes.

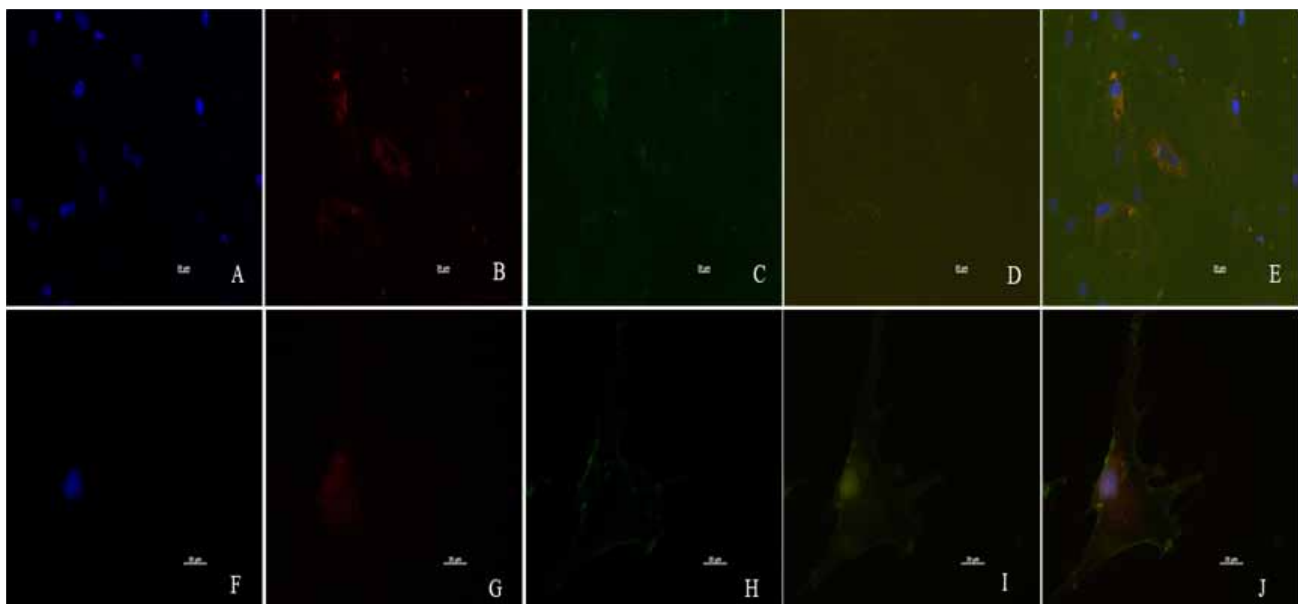
The Tmem121 insert were successfully cloned into the vector and all negative and positive controls were prepared as well and successfully applied to competent

cells for transformation. Plasmid-insert complex was successfully detected in the transform colonies, which was purified with midiprep kit. The purified vectors were used to transfect the adrenocortical stem/progenitor cells with transfection reagent (Turbofect). The transfection efficiency ranged from 35-60%. Although, Turbofect is a strong cationic polymer efficiently used for transfection, this low-medium transfection efficiency rate (35-60%) resulted from the refractory nature of the primary cell<sup>(11)</sup>.

**Immunocytofluorescent:** The results of the dual Immunocytofluorescence assays were showed the co-expression of the Tmem121 in the transfected cells

(as confirmed by the vector reporter (red fluorescent) confirming the successful transfection in the stem/progenitor cells identified with anti-Thy-1 antibody in comparison with control cells (Figure 1).

Although Thy-1 cells in this study were used after spending three months in cultivation, they were potentially young stem/progenitor cells because they hold similar proliferation rate to these cells in their niche, which were proliferate more constantly and can survive longer *in vitro*<sup>(10)</sup> in comparison to the whole adrenal primary culture which tends to lose their survival ability after 100 days *in vitro*<sup>(12)</sup>.



**Figure 1: Dual-immunocytofluorescence on three months old cultures of stem/progenitor adrenocortical cell (Thy-1 cells). Cells were transfected with native pIRES2-ERFP vector (A-E). Cells were transfected with Tmem121 gene cloned into pIRES2-ERFP vector (F-J).**

Cells were fixed and incubated with primary rabbit anti-Tmem121 antibody (ab151077) before detection with secondary anti-rabbit Alexa 546 in D and I. cells also were incubated with mouse anti-Thy-1 antibody before detection with secondary anti-mouse Alexa 488 in C and H. All samples were mounted and cell nuclei were stained with DAPI in (A and F). Red fluorescent protein resulted from pIRES2-ERFP vector in B and G. Merged images of (A), (B), (C) and (D) are shown in (E) and of (F), (G), (H) and (I) in (J). Scale bars: 20μm.

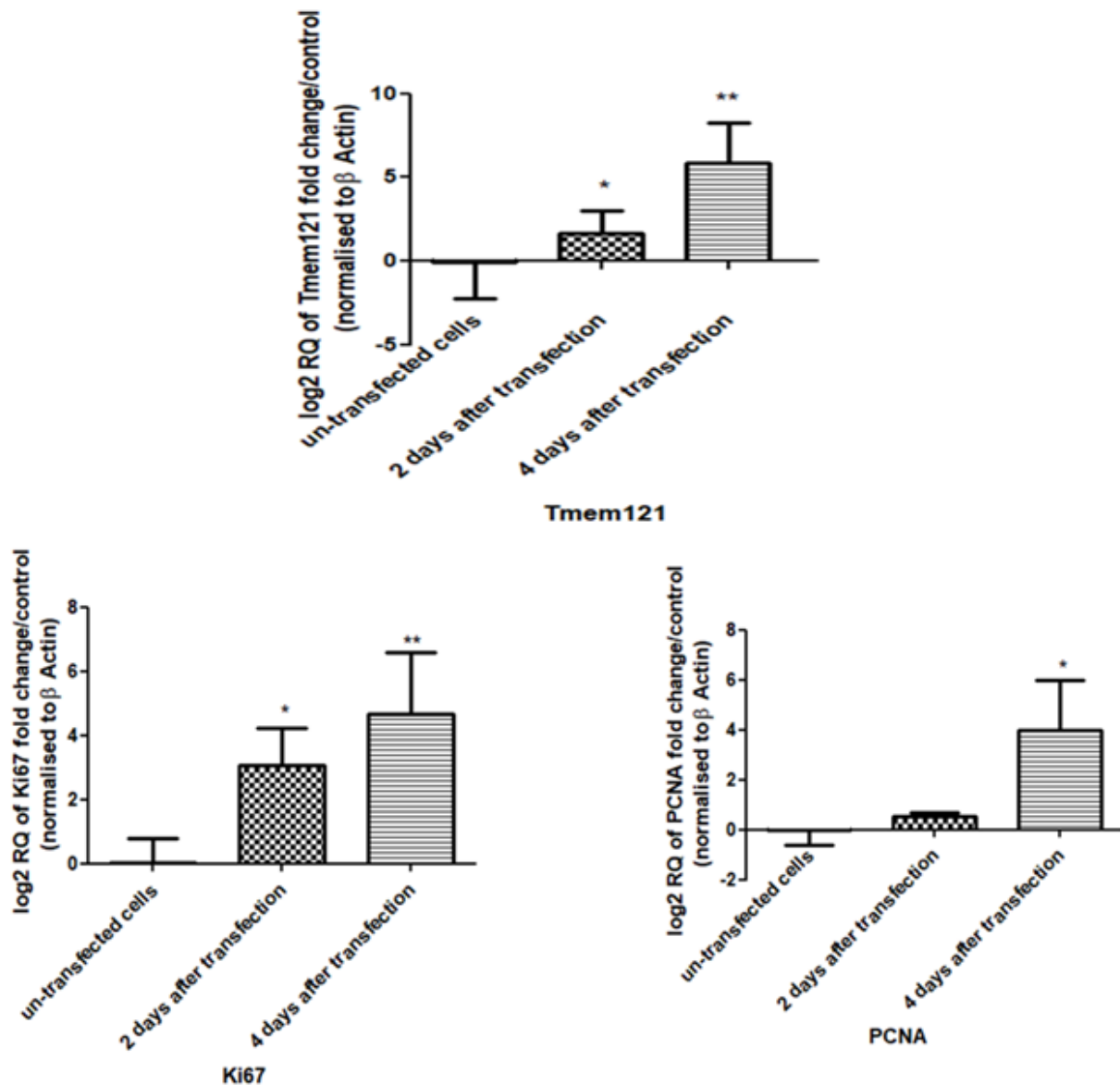
**RT-qPCR:** The transfection of Thy-1 cells with the coding sequence of Tmem121 gene showed significant responses in both proliferation markers Ki67 and PCNA as measured using two steps-Real time PCR. The control group of this assay were the cells that transfected with native-plasmid which also compared with un-transfected cells in addition to the cells received the Tmem121 gene. The results showed a significant ( $P < 0.05$ ) and ( $P < 0.01$ )

increase in the expression of Tmem121 two days and four days after transfection respectively (figure1). This result revealed the gradual elevation in the gene expression of Tmem121 due to the time required to SV40 promoter in vector to elevate the expression level in the host cell.

The response of both proliferation markers were also increased in synchronising with the elevation of

the expression of Tmem121. Ki67 expression increased in harmony with the expression of Tmem121 which revealed similar significant ( $P < 0.05$ ) and ( $P < 0.01$ ) increase after two and four days of transfection respectively (figure 2). Although PCNA also showed positive response to Tmem121 elevated expression, it was less than the response of Ki67. PCNA showed non-significant increase in the expression after two days of transfection. However, after four days of transfection PCNA showed a significant ( $P < 0.05$ ) increase in its expression (figure 2).

These results revealed a positive relationship between the expression of Tmem121 and the proliferation activity of the adrenocortical stem/progenitor cells represented by two proliferation markers. These results were confirming the suggested relationship between Tmem121 expression in capsule and sub-capsular areas of the adrenal cortex with Ki67<sup>(9)</sup>.



**Figure 2.** RT-qPCR relative quantification represented fold changes of mRNA expression of Tmem121, Ki67 and PCNA in the Thy-1 cells after Tmem121 transfection. The cells were transfected in their 3rd month of *in vitro* cultivation and the gene expression was then tested at two interval periods 2 and 4 days after transfection. Three biological replicates were used in this experiment. Summarized one-way ANOVA results showed significant \* ( $P < 0.05$ ) and/or significant \*\* ( $P < 0.01$ ) difference.

## Conclusion

Elevating the expression of Tmem121 in the adrenocortical stem/progenitor cells by cloning and transfection induce a significant increase in the proliferation markers Ki67 and PCNA. This positive incorporation of Tmem121 with these two markers suggested a propagating effect of TMEM121 to the adrenocortical stem/progenitor cells.

**Acknowledgments:** We would like to thank all staff and colleague at Hopkins laboratories at University of Reading for their support, training and to have the opportunity to use their labs conducting our experiments. Special thanks to Dr. Andrew Bicknell, Elizabeth Lander and Phil Dash for their support during commencing our research.

**Conflict of Interest:** None

**Funding:** Self

**Ethical Clearance:** Not required

## List of Abbreviation

DMEM	Dulbeccos Modified Eagle's Medium
dNTP	Deoxyribose nucleoside triphosphate
E.coli	Escherichia coli
ERFP	Enhanced Red Fluorescent Protein
FISH	Fluorescent <i>In situ</i> hybridisation
PCNA	Proliferating cell nuclear antigen
RT-PCR	Reverse transcription-polymerase chain reaction
RT-qPCR	Reverse transcription-quantitative polymerase chain reaction
Tmem121	Transmembrane protein121
$\beta$ -Actin	Beta-Actin

## References

- HEIKKILA, M., PELTOKETO, H., LEPPALUOTO, J., ILVES, M., VUOLTEENAHO, O. & VAINIO, S. Wnt-4 deficiency alters mouse adrenal cortex function, reducing aldosterone production. *Endocrinology*. 2002, 143, 4358-65.
- NISHIMOTO, K., NAKAGAWA, K., LI, D., KOSAKA, T., OYA, M., MIKAMI, S., SHIBATA, H., ITOH, H., MITANI, F., YAMAZAKI, T., OGISHIMA, T., SUEMATSU, M. & MUKAI, K. Adrenocortical zonation in humans under normal and pathological conditions. 2010, *J Clin Endocrinol Metab*, 95, 2296-305.
- CHANG, S. P., MORRISON, H. D., NILSSON, F., KENYON, C. J., WEST, J. D. & MORLEY, S. D. Cell proliferation, movement and differentiation during maintenance of the adult mouse adrenal cortex. 2013, *PLoS One*, 8, e81865.
- WALCZAK, E. M. & HAMMER, G. D. Regulation of the adrenocortical stem cell niche: implications for disease. 2015, *Nat Rev Endocrinol*, 11, 14-28.
- LERARIO, A. M., FINCO, I., LAPENSEE, C. & HAMMER, G. D. Molecular Mechanisms of Stem/Progenitor Cell Maintenance in the Adrenal Cortex. 2017, *Front Endocrinol (Lausanne)*, 8, 52.
- PENNY, M. K., FINCO, I. & HAMMER, G. D. Cell signaling pathways in the adrenal cortex: Links to stem/progenitor biology and neoplasia. 2017, *Mol Cell Endocrinol*, 445, 42-54.
- ZHOU, J., LI, Y., LIANG, P., YUAN, W., YE, X., ZHU, C., CHENG, Y., WANG, Y., LI, G., WU, X. & LIU, M. A novel six-transmembrane protein hhole functions as a suppressor in MAPK signaling pathways. 2005, *Biochem Biophys Res Commun*, 333, 344-52.
- BRONNEKE, S., BRUCKNER, B., SOHLE, J., SIEGNER, R., SMUDA, C., STAB, F., WENCK, H., KOLBE, L., GRONNIGER, E. & WINNEFELD, M. Genome-wide expression analysis of wounded skin reveals novel genes involved in angiogenesis. 2015, *Angiogenesis*, 18, 361-71.
- AL-BEDHAWI, M. A. A. & BICKNEL, A. Tmem121 A Novel Gene Associated With The Proliferation Activity of Adrenocortical Stem/Progenitor Cells. 2019, *Research Journal of Pharmaceutical, Biological and Chemical Sciences*, 10, 14.
- AL-BEDHAWI, M. A. A. Identification and characterisation of a potential adrenocortical stem cell population. university of Reading. 2018,
- STAEDEL, C., HUA, Z., BROKER, T. R., CHOW, L. T., REMY, J.-S. & BEHR, J.-P. High-Efficiency Transfection of Primary Human Keratinocytes with Positively Charged Lipopolyamine: DNA Complexes. 1994, *Journal of Investigative Dermatology*, 102, 768-772.
- AROLA, J., HEIKKILA, P. & KAHRI, A. I. Biphasic effect of ACTH on growth of rat adrenocortical cells in primary culture. 1993, *Cell Tissue Res*, 271, 169-76.

# Impact of Broken Family upon Adolescents' Behavior at Secondary Schools in AL- Najaf AL-Ashraf City

Mohammed Baqer Hassan<sup>1</sup>, Khetam Mutashar Hatab<sup>2</sup>

<sup>1</sup>Assistant Professor, Pediatric Department, Faculty of Nursing, University of Kufa, IRAQ,

<sup>2</sup>Professor, Pediatric Department, Faculty of Nursing, University of Baghdad, IRAQ

## Abstract

**Background:** Broken families It is the family under divorce, separation, death of father, death of mother and death of both parents. It is the legal termination of marriage. It is also the dissolution of marriage that is contracted between husband and wife by the judgment of a court of competent jurisdiction or by an act of the legislature. Separation and divorce have exclusion and negative effects on the behavior of children as well as the burden of education for those in charge of it, which involves risks to the psyche and the degree of coping with children.

**Objectives:** To determine broken families among secondary school adolescents, assess secondary school's adolescents' behaviors, determine the impact of broken families on adolescents' behaviors, and to find-out the relationship between adolescent's behaviors underbroken family and their socio-demographic characteristics of age, gender, parent's education levels, family type and socio-economic status.

**Methodology:** Anon-probability (purposive) sample of (555) students, whose age are between 12 to 18 years have been selected; the sampling of study is divided into two stages which include: First stage: the school's selection by cluster, the AL-Najaf City divided to six districts, the schools selected randomly (36) school's boys and girls, from (130) total schools .Second stage: students under broken family selection by using the purposive sampling, while control group from each school students were randomly selected.

**Results:** Indicate that there is significant relationship between the adolescent's gender under broken family and their behavior domain excessive suffering, poor anger control and poor social conformity. While there is a non-significant relationship between the adolescent's gender under broken family and their other behavior domains. The results show that there is a highly significant relationship between adolescent's Educational level under broken family and their behavior domain poor impulse control and poor anger control. While there is a non-significant relationship between the adolescent's Educational level under broken family and their other behavior domains.

**Conclusion:** That most of the secondary school's adolescents under broken family have Behavior problems.

**Recommendation:** To the Governments and Schools should create awareness on the ills of broken homes on the academic, emotional and social adjustments of students through training, workshops and seminars. Parents should be enlightened on the need to stay together as husband and wife to raise a good family.

**Keywords:** *Impact, Broken Family, Adolescents' Behavior, Secondary Schools.*

## Introduction

God created mankind and made the production of the offspring and its perpetuity of life through marriage between a man and a woman. Therefore, the family is considered the smallest social institution within the community, and the relationship that binds the father and

---

### Corresponding Author:

**Mohammed Baqer Hassan**

Assistant Professor, Pediatric Department, Faculty of Nursing, University of Kufa, IRAQ,

e-mail: mohammedb.daghil@uokufa.edu.iq

the mother within the family, so the more coherent that relationship is, the stronger the society will be, because through the family, the first signs for raising a child and promoting values and good morals are launched<sup>(1)</sup>.

Family is the basic unit of society. A home is that where a family lives which provides children with feelings of security and stability. The members of family constitute the child’s first environment for personal and social adjustment. Anything that interferes with these feelings can be regarded as hazardous for adolescents <sup>(2)</sup>.

The effects of a broken family on children depend on numerous factors, including child’s age and personality when parents got separated, family relationships and the surrounding circumstances in which changes in the behavior of the child can occur from the simplest detail of the most complex, in addition to the child’s ability to overcome these difficulties and favorable conditions <sup>(3)</sup>.

The impact of the broken family on children by shaping children’s attitudes, feelings, thoughts, and

behaviors, which are manifested by the increase in painful feelings of sadness, anxiety, confusion, fear, guilt, and the reinforcement of misconceptions and behaviors with the domination of some negative ideas that increase the suffering of children when there is an incoherent and disassembled family that has an impact On the quality of life of the adolescents in all areas <sup>(4)</sup>.

### Methodology

**Design of the Study:** A descriptive study is conducted through the period of November 11<sup>th</sup>, 2018 to May 9<sup>th</sup>, 2019 in-order to Impact of Broken Family upon Adolescent’s Behavior at Secondary Schools in AL- Najaf AL-Ashraf City.

**Setting of the Study:** The setting of the study includes (36) schools;(12) intermediate schools, (12) high schools (preparatory), and (12) secondary schools, which are distributed in six districts of Al-Najaf Al-Ashraf City, six schools from each quarter’s.

### Results of the Study

**Table (1): Distribution of the Study Sample by their Adolescents Demographic Data**

Variables		Broken Family		Control group		P. value
		No.	%	No.	%	
Gender	Male	139	42.0	39	17.4	0.0001*
	Female	192	58.0	185	82.6	
	<b>Total</b>	<b>331</b>	<b>100%</b>	<b>224</b>	<b>100%</b>	
Adolescents Age (years)	12-13	25	7.5	18	8	0.0001*
	14-15	105	31.7	55	24.6	
	16-17	169	51.1	150	67	
	18	32	9.7	1	0.4	
	<b>Total</b>	<b>331</b>	<b>100%</b>	<b>224</b>	<b>100%</b>	
Educational Level for Adolescent	Intermediate	120	36.3	39	17.4	0.0001*
	Secondary	181	54.7	123	54.9	
	Preparatory	30	9.1	62	27.7	
	<b>Total</b>	<b>331</b>	<b>100%</b>	<b>224</b>	<b>100%</b>	
Class	First	23	6.9	18	8.0	0.0001*
	Second	79	23.9	25	11.2	
	Third	54	16.3	29	12.9	
	Fourth	97	29.3	51	22.8	
	Fifth	78	23.6	101	45.1	
	<b>Total</b>	<b>331</b>	<b>100%</b>	<b>224</b>	<b>100%</b>	
Educational Level for the Students	Good	92	27.8	201	89.7	0.0001*
	Average	131	39.6	22	9.8	
	Poor	108	32.6	1	0.4	
	<b>Total</b>	<b>331</b>	<b>100%</b>	<b>224</b>	<b>100%</b>	

Variables		Broken Family		Control group		P. value
		No.	%	No.	%	
Number of Children in the Family	1-3	144	43.5	94	42	0.832
	4-6	144	43.5	104	46.4	
	7-9	35	10.6	24	10.7	
	10-12	8	2.4	2	0.9	
	<b>Total</b>	<b>331</b>	<b>100%</b>	<b>224</b>	<b>100%</b>	
Age at Broken Family (Years)	1-3	29	8.8	-	-	
	4-6	54	16.3	-	-	
	7-9	86	26	-	-	
	10-12	105	31.7	-	-	
	13-15	47	14.2	-	-	
	More than 16	10	3	-	-	
	<b>Total</b>	<b>331</b>	<b>100%</b>	<b>-</b>	<b>-</b>	

Table (1) indicates that more than half (51.1%); (67%) of ages are 16-17 years of broken and control samples respectively; while the results revealed that the highest percentage (58%); (82.6%) is female of broken and control samples respectively; the educational level more than half (54.7%); (54.9%) at secondary school of broken and control samples respectively; more than quarter (29.3%); (45.1%) of broken and control samples respectively in fourth and fifth class, with average level

(39.6%) of broken sample, while good level (89.7%) of education with control sample; the highest percentage of number children in the family is (43.5%); (46.4%) of four to six of both samples respectively; while age at broken family is more than third percentage (31.7%) at ten to twelve years; the children rank in family is more than third percentage (37.1%) at second in broken sample, while (44.2%) at first in control sample.

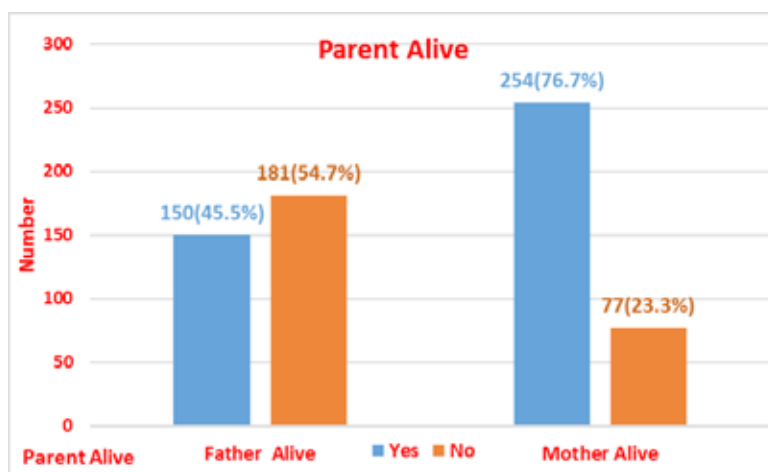
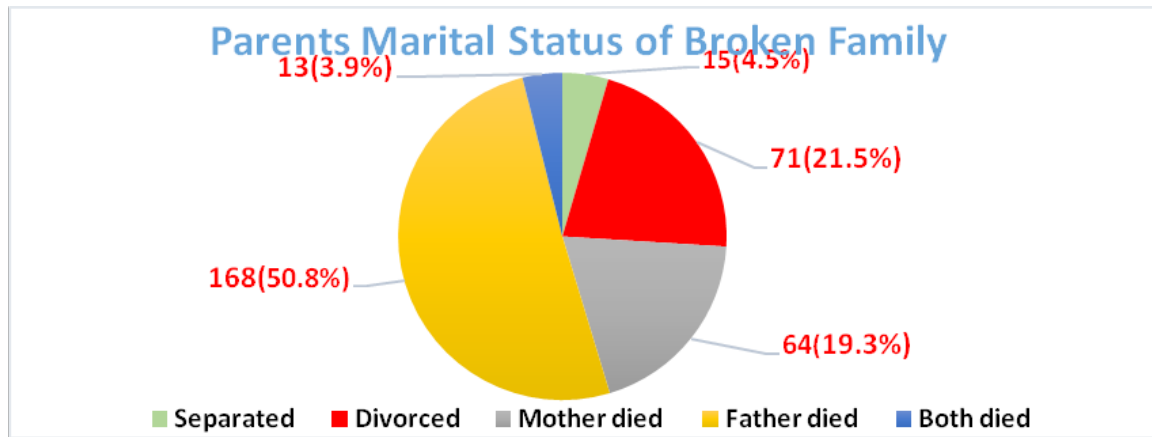


Figure (1): Distribution of the Study Sample by their Parent Alive

The findings in figure (1) indicate that the more than half percentage (54.7%) of no father alive; while mother alive is two-third percentage (76.7%) of broken family sample.





**Figure (2): Distribution of the Study Sample by their Parents Marital Status**

The findings in figure (2) indicates that the majority percentage (50.8%) of father died and the divorced is (21.5%); while lowest percentage (3.9%) is both parent died of broken family.

**Table (2): Association Between Educational Level for the Students and Adolescent’s Behavior Levels of the Study Group**

Variables		Broken Family						Control					
		Educational level for the students						Educational level for the students					
		Good		Average		Poor		Good		Average		Poor	
		No	%	No	%	No	%	No.	%	No.	%	No	%
Burks Behavior Rating Scale (BBRS)	Not (110-220)	4	4.3	-	-	1	0.9	95	47.3	12	54.5	-	-
	Yes (221-384)	74	80.4	104	79.4	91	84.3	106	52.7	10	45.5	1	100
	Sign.(385- 550)	14	15.2	27	20.6	16	14.8	-	-	-	-	-	-
	P. value	0.007						0.655					

\*Significant difference between proportions using P. Chi-square test at 0.05 level.

Table (2) represent the association between the adolescent’s behavior and their educational level for the students, the study results indicate that there is a significant association at p-value more than 0.05; at p-value (0.007) .

**Table (3): Association Between Type of Family and Adolescent’s Behavior Levels of the Study Group**

Variables		Broken Family				Control			
		Type of Family				Type of Family			
		Nucleus		Extended		Nucleus		Extended	
		No.	%	No.	%	No.	%	No.	%
Burks Behavior Rating Scale (BBRS)	Not (110-220)	3	1.7	2	1.3	94	46.8	13	56.5
	Yes (221-384)	135	76.3	134	87.0	107	53.2	10	43.5
	Sign. (385-550)	39	22.0	18	11.7	-	-	-	-
	P. value	0.041*				0.375			

\*Significant difference between proportions using P. Chi-square test at 0.05 level.

Table (3) represent the association between the adolescent’s behavior and their type of family, the study results indicate that there is a non-significant association at p-value more than 0.05; Burks behavior rating scale) at p-value (0.041) .

**Table (4): Association Between Socio Economic Status and Adolescent's Behavior Levels of the Study Group**

Variables		Broken Family						Control					
		SE Status (income)						SE Status (income)					
		Enough		Little bit enough		Not enough		Enough		Little bit enough		Not enough	
		No.	%	No.	%	No.	%	No.	%	No.	%	No.	%
Burks Behavior Rating Scale (BBRS)	Not (110.220)	3	2.2	2	1.7	-	-	85	50.0	22	40.7	-	-
	Yes (221.384)	112	82.4	102	84.3	55	74.3	85	50.0	32	59.3	-	-
	Sign. (385.550)	21	15.4	17	14.0	19	25.7	-	-	-	-	-	-
	P. value	0.185						0.235					

\*Significant difference between proportions using P. Chi-square test at 0.05 level.

Table (4) represent the association between the adolescent's behavior and their socio economic status, the study results indicate that there is a non –significant association at p-value more than 0.05; Burks Behavior Rating Scale (BBRS)at p-value (0.185) .

### Discussion of the Results

Table (1) show distribution of the study sample by their adolescents demographic data, this table indicates that the highest percentage (more than half) (58%); (82.6%) are females of broken and control samples respectively. This result indicates that there were females students of broken homes more than males students in the secondary schools; these findings agree with results obtained from study done by) Pauwels and Svensson, (2017. This result is due to the presence of disputes between parents or family disintegration. This generates conflicts and problems for the children, as it leads the children, especially the girls, to research and clings to any outlet that leads them to alleviate or break out of these conflicts and to prove their existence, and this can only be found through school. Especially in the Najaf community, where the available resources for girls are much less than for boys with more supervision for girls, especially in adolescence, which is characterized by aspirations for freedom and independence <sup>(5)</sup>.

While the results revealed that more than half (51.1%); (67%) of age is 16-17 years of broken and control samples respectively; these findings agree with results obtained from study done by (Tremblay et al., 2018). This result is due to the period in which they were born. The society has suffered in many political and economic problems, in addition to the openness that the country witnessed and other factors have rocked society, especially the family. The disintegration has increased during that period <sup>(6)</sup>.

Concerning the level of adolescent's education, the study indicates that more than half (54.7%); (54.9%) at secondary school of broken and control samples respectively; these findings agree with results obtained from study done by)Atsushiet al., 2018) <sup>(7)</sup>. While there are more than quarter (29.3%); (45.1%) of broken and control samples respectively in fourth and fifth class, with average level (39.6%) of broken sample, and good level (89.7%) of education with control sample; these findings agree with results obtained from study done (Amato and Sobolewsk, 2001) <sup>(8)</sup>. This result is due to the fact that most of the samples members are between 16-17 years old and who are usually in this stage of study. Addition the lower educational level to middle due to loss or lack of supervision by the parents, with the mental, emotional and behavioral problems faced by the teenager, as well as difficulties in the family. All of this reflects negatively on all levels of the adolescent's life, especially the academic level, with the loss or lack of interest of the educational staff in the student, making the student's level be less than good.

The highest percentage of number children in the family are (43.5%); (46.4%) of fourth to sixth of both samples respectively; these findings agree with results obtained from study done by (Cohen, 2014). This result is due to the occurrence of most cases of family disintegration when the number of its members increases, which creates burdens on the family breadwinner and consequently the family's neglect and disintegration. Therefore, the order of adolescents plays a major role in determining the method of family upbringing, especially in dealing with children <sup>(9)</sup>.

While adolescent's age at broken family indicates that more than third (31.7%) occurred at ten to twelve years; these findings agree with results obtained from study done by) Banket al., 2001). This result is due to

the burdens of living and the increasing requirements of adolescents as they get older, with the inability of parents to manage family affairs with the problems of life facing the family in light of the unstable political, economic and security conditions of the country, with the increase in the number of family members. These factors can lead to family disintegration and incoherence<sup>(10)</sup>.

Children rank in family are more than third percentage (37.1%) at second in broken sample, while (44.2%) at first in control sample; while the results revealed that the highest percentage (48.3%); (100%) is number of failure at less than one year of broken and control samples respectively; these findings agree with results obtained from study done by (Anderson et al., 2017). This result is due to the varied socio-demographic of the family who live in a poor or semi-poor family<sup>(11)</sup>.

Respondents were asked whether both parents were alive (Figure 1), the findings indicate that the more than half percentage (54.7%) of no father alive; while mother alive is two-third percentage (76.7%) of broken family sample; these findings agree with results obtained from study done by (Lauren and Laura, 2008). This result is due to the Iraqi society, especially Najafi, the main breadwinner for the family is the father, and the dependency is high, as well as the large role in meeting most of the basic needs necessary for family members, especially individuals without adolescence. In the case of losing the father, the entity and cohesion of the family can permeate or weaken and also generate economic and social burdens on the rest of the family members, especially the mother or big brother<sup>(12)</sup>.

Figure (2) show distribution of the study sample by their parents marital status, it indicates that the majority percentage (50.8%) of father died and the divorced is (21.5%); while lowest percentage (3.9%) is both parent died of broken family; these findings agree with results obtained from study done by (Riala et al., 2013). This result is due to living in single parent families or stepfamilies caused by death had higher negative consequences for adolescent than living in single parent families caused by divorce, due to fathers take on the principal caring role. In general, the results of this study give support to the weak social position of the mother as the most likely explanation for the negative effects of living in a single parent family<sup>(13)</sup>.

Table (2) show association between educational level for the students related to the adolescent's behavior levels broken family in secondary schools, represent

the association between the adolescent's behavior and their educational level for the students, the study results indicate that there is a significant association at p-value more than 0.05; these findings disagree with results obtained from study done by (Umar, 2019); the study results indicate that there is significant influence of broken homes on the academic adjustment of secondary school students<sup>(14)</sup>.

Table (3) show association between type of family related to the adolescent's behavior levels broken family in secondary schools, represent the association between the adolescent's behavior and their type of family, the study results indicate that there is a non – significant association at p-value more than 0.05; these findings agree with results obtained from study done by (Maggie, 2017); individual's adolescent family the study results indicate that the degree of support and sense of belonging individuals felt towards their family during adolescence, as well as their parent's relationship history were associated with low. Table (4) show association between socio economic status related to the adolescent's behavior levels broken family in secondary schools, represent the association between the adolescent's behavior and their socio economic status, the study results indicate that there is a non – significant association at p-value more than 0.05; these findings agree with results obtained from study done by (Hughes et al., 2017); the study results indicate that lower levels of family cohesion are an indicator of poor family relationships and may a healthy development. This result is due to the families characterized by unsupportive and neglectful relationships and conflict constitute risky environments that may lead to worse mental and physical health across the life, operating through pathways such as stress, emotion processing, social competence, and risky health behaviors<sup>(15)</sup>.

## Conclusions

1. The study confirms that more than half of the study are female adolescent under broken family.
2. The study indicates that the broken family has a non-significant relationship to SESS.
3. The study indicates that most of adolescents have a behavior problems with their broken family.
4. The findings from this study lead to the conclusion that broken family have immense Impact of Adolescent's Behavior at Secondary Schools in AL-Najaf AL-Ashraf City.

**Recommendations:**

1. Government should review upward minimum salary from the current amount to reasonable and substantial level to better the lives of the average citizen in the country.
2. Employment opportunities should be created for the unemployed parents.
3. Should, through enacting laws and the media, to enhance and improve the quality of family life.
3. Parents should be enlightened on the need to stay together as husband and wife to raise a good family. They should persevere and tolerate each other in marriage.

**Financial Disclosure:** There is no financial disclosure.

**Conflict of Interest:** None to declare.

**Ethical Clearance:** All experimental protocols were approved under the College of Nursing, University of Kufa, Iraq and all experiments were carried out in accordance with approved guidelines.

**References**

1. Wade T. J., Veldhuizen S., and Cairney J., Prevalence of Psychiatric Disorder in Lone Fathers and Mothers: Examining the Intersection of Gender and Family Structure on Mental Health, *Canadian Journal of Psychiatry*, 2016; 56(9), 567-573.
2. Langton C. E., and Berger L. M., Family Structure and Adolescent Physical Health Behavior and Emotional Well-Being, *Social Service Review*, 2015; 85(3): 323-357.
3. Wolchik S. A., Sandler I., Millsap R. E., Plummer B. A., Greene S. M., and Anderson E. R., Six Year Follow-up of a Randomized Controlled Trial of Preventive Interventions for Children of Divorce, *Journal of the American Medical Association*, 2012; 288: 1-8.
4. Pedro-Carroll J. L., Sutton S. E., and Wyman P. A., A Two Year Follow-up Evaluation of a Preventive Intervention for Young Children of Divorce, *School Psychology Review*, 2015; 28: 467-476.
5. Pauwels L, Svensson R. Analyzing Gender Differences in the Relationship between Family Influences and Adolescent Offending among Boys and Girls. *European Journal of Criminology*. 2017; 10(4): 1079-1094.
6. Tremblay RE, Pagani-Kurtz L, Mâsse LC, Vitaro F, Pihl RO. Individual family and school level interventions targeting multiple risk behaviours in young people. *Journal of Consulting and Clinical Psychology*. 2018;63(4):560-8.
7. Amato PR, Sobolewski JM. The effects of divorce and marital discord on adult children's psychological well-being. *American Sociological Review*. 2001;66:900-921.
8. Cohen GJ, The impact of family structure on the health of children: Effects of divorce. London: University of London, Institute of Education, Thomas Coram Research Unit. 2014 Nov; 110(5):1019-23.
9. Bank L, Marlowe JH, Reid JB, Patterson GR, Weinrott MR. Family and parenting interventions in children and adolescents with conduct disorder and delinquency aged 10-11 *Journal of Abnormal Child Psychology* Published online 2001 : 23.
10. Anderson NJ, Neuwirth SJ, Lenardson JD, Hartley D.; 2017. Differences in Health Care, Family, and Community Factors Associated with Mental, Behavioral, and Developmental Disorders Among Children Aged 2-8 Years in Rural and Urban Areas. 2017; (17). 10: 155 .
11. Lauren E. Glaze and Laura M. Maruschak, Parents in Prison and Their Minor Children, Department of Justice Office (2008) .*American Journal* 8(3): 41-46.
12. Riala, K., Isohanni, I., Jokelainen, J, Jones, P. and Isohanni, M. 'The relationship between childhood family background and educational performance, with special reference to single-parent families: a longitudinal study', *Social Psychology of Education*, (2013); 6(4), pp. 349–365.
13. Umar Usman Sani, Influence of Broken Homes on Senior Secondary School Students' Academic, Emotional and Social Adjustments in Katsina State, Nigeria. *International Journal of Innovative Psychology & Social Development*. 2019; 7(1):26-32.
14. Maggie L. Thorse . The Adolescent Family Environment and Cohabitation across the Transition to Adulthood . Department of Sociology & Anthropology, Montana State University. 2017;75(5):249-262.
15. Hughes K., Bellis M.A., Hardcastle K.A., Sethi D., Butchart A., Mikton C., Jones L., Dunne M.P. Poor Family Relationships in Adolescence and the Risk of Premature Death: Findings from the Stockholm Birth Cohort Study. *Lancet Public Health*. 2017;2:e356-e366. doi: 10.1016/S2468-2667(17)30118-4.

# The Safety and Efficacy of Sacral Neuromodulation on Refractory Urgency Urinary and Fecal Incontinence in Iraqi Patients

Mohammed Bassil Ismail<sup>1</sup>, Wameedh Qays Abdullhussein<sup>2</sup>

<sup>1</sup>CABMS (Urology), Urology Department, College of Medicine, University of Baghdad,

<sup>2</sup>CABMS (Neurosurgery), Medical City Complex, Baghdad

## Abstract

**Background:** Urinary urgency incontinence is characterized by symptoms of involuntary loss of urine that preceded or accompanied by sudden desire to void. Fecal incontinence is defined as involuntary passage of stool through the anus. It may vary from soiling to complete evacuation. This involuntary loss of feces, flatus or urge incontinence adversely affects quality of life.

**Objectives:** To evaluate the efficacy and safety of sacral neuromodulation on these pathologies.

**Method:** Following a detailed investigation, 21 patients with either urinary incontinence, or both urinary and fecal, who did not respond to medical and behavioral treatment were offered the sacral neuromodulation therapy and followed for at least 12 months post implant regarding response and development of complication if any found.

**Results:** In the period from November 2015 to May 2017. The unit of neurogenic bladder and neuromodulation in surgical subspecialty hospital, medical city complex had implanted 21 Patients with urinary incontinence were using from (4-17) pads/day (mean of 10.5/day) presacral neuromodulation which were declined significantly to (0-3) pads/day (mean of 2.2/day).

From the eighteen patients who presented with fecal incontinence after the implantation of sacral neuromodulation interstim 11 permanent devices only four remained incontinent .and from the nine patients who presented with erectile dysfunction only two remained impotent.

**Conclusion:** The use of Sacral Neuromodulation in Iraqi patients with Urinary and Fecal Incontinence is safe and effective

**Keywords:** *Sacral Neuromodulation, Urgency urinary incontinence, fecal incontinence.*

## Introduction

Sacral neuromodulation (SNM) is considered now a well-accepted tertiary treatment modality for patients complaining from refractory nonneurogenic bladder symptoms and nonobstructive urinary retention.<sup>(1)</sup>

Sacral neuromodulation was FDA approved for the treatment of urgency urinary incontinence since 1997.<sup>(2)</sup>

Its exact action mechanism is not fully defined, but it most likely involves the electrical modulation and reset of neuronal reflexes and voiding center through

peripheral afferents and not stimulating the detrusor bladder muscle or urethral internal or external sphincter directly.<sup>(3-4)</sup>

SNM is very effective in the management of many urological diseases refractory to medical therapy, like frequency–urgency syndrome, nonobstructive urinary retention, neurogenic bladder, and others. Sacral neuromodulation has been FDA-approved as proven effective treatment modality for the management of fecal incontinence in 2011.<sup>(5)</sup>

It modulates the spinal cord reflexes that affect the bladder, urethra, anal sphincter and pelvic floor muscle.<sup>(6)</sup>

Urgency urinary incontinence (UUI) is defined as involuntary loss of urine that precede or accompanied by sudden desire to void. Urgency incontinence is considered refractory when shows no response to behavioral therapies and at least two medications.<sup>(7)</sup> The prevalence of urgency urinary incontinence increases with age.<sup>(8)</sup>

Fecal incontinence is a humiliating life-altering condition that affects nearly 2% of population.<sup>(10)</sup>

### Patient and Method

A prospective cohort study was conducted in a tertiary referral specialized neuromodulation unit to assess the efficacy of SNM in patients with refractory urinary and fecal incontinence. All patients between 16 and 61 years of age, who were referred to surgical subspecialty hospital, medical city complex complaining from Urinary and Fecal Incontinence refractory to conservative treatment, were eligible to be included in this study. Informed consent was obtained from all patients and first-degree relatives.

Full detailed history and prior treatments were collected from them, full physical examination was done 3 days voiding diary.

Further diagnostic tests included urinalysis, abdomino-pelvic ultrasound, renal function test, full urodynamics, lumbosacral MRI, flexible cystoscopy was done to all patients.

All those patients should have urinary incontinence alone or associated with fecal incontinence According to guidelines both American and European offered conservative treatment for at least 8-12 weeks if failed so, Refractory incontinence was considered with persistence of symptoms despite at least one supervised behavioral or medical therapy or both for at least 8-12 weeks.

#### Exclusion Criteria:

1. Patients with urinary incontinence due to intrinsic sphincteric deficiency.
2. urinary incontinence due to anatomical abnormality like ectopic ureter or vesicovaginal fistulae

3. Patient age less than 16 years.
4. Patients who had less than 50% improvement in their symptoms during temporary stimulation phase.
5. Patients with pure fecal incontinence (we do not have the facility to exclude abnormality in the anal sphincter)

Those patients were offered sacral neuromodulation in two stage surgery in the first-stage tined lead placement in S3 foramen under fluoroscopic examination. Both motor and sensory responses were assessed for all electrodes independently if there is good response the lead will place and connected to external temporary device. During the two weeks of testing phase, patients will be followed by 3 days voiding diary and full bladder pelvic ultrasound programs will be changed by the surgeon to optimize good results. Patients with more than 50% response were considered as responders and permanent device was implanted for them.

Scheduled visits postimplant from the patients to the outpatient after two weeks and the programmed, every 3 months for at least 4 or 5 times for at least one year and inquire about any undesirable side effects.

### Results

In the period from November 2015 to May 2017 the unit of neurogenic bladder and neuromodulation in surgical subspecialty hospital, medical city complex had implanted 21 permanent interstim II devices in 21 patients with age ranging from 16 to 61 (table 1) year old complaining from urgency urinary incontinence 18 patients had also associated fecal incontinence, and nine of them had erectile dysfunction also. all the patients were followed for at least one-year post implantation.

**Table 1: Descriptive characteristics of studied sample**

		No.	%
Age groups	< 40 year	16	76.2%
	=>40 year	5	23.8%
Gender	Male	12	57.1%
	Female	9	42.9%
Diagnosis	Urgency incontinence	21	100%

Patients with urinary incontinence were using from (4-17) pads/day (mean of 10.5/day) presacral neuromodulation which were declined significantly to (0-3) pads/day (mean of 2.2/day). (Table 2, table 3).

**Table 2: Mean number of pads pre and post SNS**

Paired Samples Statistics				p-value
No. of pads/day	Mean	Std. Deviation	Mean difference	
Pre	10.5	3.5	8.3	0.001
Post	2.2	1.6		

**Table 3: Number of pre and post pads according to number of patients**

No. of patients	No. of pads/day pre-sns	No. of pads/day post-sns											
		0		1		2		3		4		5	
		No.	%	No.	%	No.	%	No.	%	No.	%	No.	%
1	4	1	100.0%	0	0.0%	0	0.0%	0	0.0%	0	0.0%	0	0.0%
1	5	1	100.0%	0	0.0%	0	0.0%	0	0.0%	0	0.0%	0	0.0%
2	6	1	50.0%	1	50.0%	0	0.0%	0	0.0%	0	0.0%	0	0.0%
1	7	1	100.0%	0	0.0%	0	0.0%	0	0.0%	0	0.0%	0	0.0%
1	8	0	0.0%	0	0.0%	1	100.0%	0	0.0%	0	0.0%	0	0.0%
4	10	0	0.0%	0	0.0%	3	75.0%	1	25.0%	0	0.0%	0	0.0%
3	11	0	0.0%	0	0.0%	2	66.7%	0	0.0%	1	33.3%	0	0.0%
2	12	0	0.0%	0	0.0%	0	0.0%	1	50.0%	0	0.0%	1	50.0%
2	13	1	50.0%	0	0.0%	1	50.0%	0	0.0%	0	0.0%	0	0.0%
1	14	0	0.0%	0	0.0%	0	0.0%	0	0.0%	1	100.0%	0	0.0%
2	15	0	0.0%	0	0.0%	0	0.0%	1	50.0%	1	50.0%	0	0.0%
1	17	0	0.0%	0	0.0%	0	0.0%	0	0.0%	0	0.0%	1	100.0%

From the eighteen patients who presented with fecal incontinence after the implantation of sacral neuromodulation interstim 11 permanent devices only four remained incontinent .and from the nine patients who presented with erectile dysfunction only two remained impotent (nearly all those patients didn't even mention this complaint primarily may be due to that their incomitance where their major complaint or maybe they were embarrassed). (Table 5).

From the twenty-one patients treated by sacral neuromodulatin two patients had simple pain at the site of implantation some time radiating to their legs treated by reprograming of the device and simple analgesia. One patient had device infection and another had device malfunction due to direct trauma to the device treated by removal of the device and reimplantation of another device in the contralateral site. (table 4)

**Table 4: Frequency of complications post SNS**

	No.	%
Null	17	81.0
Simple pain	2	9.5
Device infection	1	4.8
Device malfunction	1	4.8
<b>Total</b>	<b>21</b>	<b>100.0</b>

**Table 5: Status of incontinent and ED pre and post SNS N=21**

	No.	%
<b>Bowel status</b>		
Incontinent	Pre-sns	18 85.7%
	post-sns	4 19.0%
<b>Potency status</b>		
Ed	pre-sns	9 64.3%
	Post-sns	2 14.3%

## Discussion

Sacral neuromodulation (SNM) is proved to a valuable addition to urology as an option for the treatment of patients with refractory urgency frequency syndrome whether dry or wet, and urinary retention or non-obstructive unresponsive to behavioral and medical treatment.<sup>(11)</sup>

Sacral neuromodulation is an attractive treatment modality because of its minimally-invasive approach.<sup>(12)</sup>

Although sacral neuromodulation is very effective in patients with sphincteric defect, its action is thought to be extrasphincteric. It has been suggested to act centrally through spinal afferents.<sup>(13)</sup>

The impact of SNM on anorectal physiology was variable. However, there appeared to be a trend towards improved anal pressures (as evidenced by increased resting and maximum squeeze pressures) and rectal sensitivity (as evidenced by a decrease in sensory threshold volumes).<sup>(14)</sup>

In addition, it has been suggested that SNM creates a change in the colonic activity a ‘physiological brake’ so prevents the delivery of stool to the anorectal unit that is functionally suboptimal and thus reduces fecal incontinence.<sup>(15)</sup>

SNM may modulate the higher voiding center reflex pathways by resting the balance between the excitatory and the inhibitory fibers of the bladder.<sup>(16)</sup>

In our study we offered sacral neuromodulation via implantation of interstim II devices to twenty one patients with refractory urgency urinary incontinence, eighteen one of them complaining from fecal incontinence, nine of them complaining from erectile dysfunction.

After at least one year follow up post sacral neuromodulation for the patients there was a significant decrease in the number of pads used by the patients (mean preSNM 10.5, mean postSNM 2.2). Only four patients from the eighteen complaining from fecal incontinence remained incontinent .seven from the nine patients with erectile dysfunction became potent again.

No serious complication faced by the patients during or following SNM for at least one year . 17 patient had nil complication.

Several studies have demonstrated the efficacy of SNM on both urinary and fecal incontinence for the

short and long term which has results approximates to our own.

Van Kerrebroeck et al showed that there was a decrease in the episodes of urgency urinary incontinence from 9.6 preSNM to 4.7 at 1-year postSNM. The number of pads/day postSNM decreased to 1.8 from 5 pads/day preSNM at 5-year follow-up.<sup>(17)</sup>

Maeda et al showed 42.6% favorable outcome of sacral neuromodulation in patients with fecal incontinence after 60 months of follow up.<sup>(18)</sup>

In conclusion according to above results we believe that Sacral Neuromodulation is safe and effective method of treatment in refractory urgency urinary and fecal incontinence.

## References

1. Peripheral and Sacral Neuromodulation in the Treatment of Neurogenic Lower Urinary Tract Dysfunction Paholo G et al *Urol Clin N Am* 44 (2017) 453–461.
2. Bolton JF, Harrison SC. Neuromodulation 10 years on: how widely should we use this technique in bladder dysfunction? *Current opinion in urology*. 2009; 19(4):375–9.
3. Jonas U, Fowler CJ, Chancellor MB et al. Efficacy of sacral nerve stimulation for urinary retention: results 18 months after implantation. *J. Urol*. 2001; 165: 15–19.
4. Sutherland SE, Lavers A, Carlson A, Holtz C, Kesha J, Siegel SW. Sacral nerve stimulation for voiding dysfunction: one institution’s 11-year experience. *NeuroUrodyn*. 2007; 26: 19–28.
5. Mirbagheri N, Sivakumaran Y, Nassar N, Gladman MA. Systematic review of the impact of sacral neuromodulation on clinical symptoms and gastrointestinal physiology. *ANZ J Surg*. 2015
6. Tjandra JJ, Chan MK, Yeh CH, Murray-Green C. Sacral nerve stimulation is more effective than optimal medical therapy for severe fecal incontinence: a randomized, controlled study. *Dis Colon Rectum* 2008; 51: 494-502.
7. Willis-Gray MG, Dieter AA, Geller EJ. Evaluation and management of overactive bladder: strategies for optimizing care. *Res Rep Urol*. 2016; 8:113–12. [PubMed: 27556018]
8. Stewart WF, Van Rooyen JB, Cundiff GW, et al.



- Prevalence and burden of overactive bladder in the United States. *World J Urol.* 2003; 20:327–336. [PubMed: 12811491]
9. Kraus SR, Bavendam T, Brake T, et al. Vulnerable Elderly Patients and Overactive Bladder Syndrome. *Drugs Aging.* 2010; 27(9):697–713. [PubMed: 20809661]
  10. Nelson RN, Norton EC, Furner. S Community-based prevalence of anal incontinence. *JAMA* 1995; 274: 559-61.
  11. Bartley J, Gilleran J, Peters K. Neuromodulation for overactive bladder. *Nat.Rev. Urol.* 2013; 10: 513–21.
  12. Gotoh M, Yamamoto T, Kato M et al. Regenerative treatment of male stress urinary incontinence by periurethral injection of autologous adipose-derived regenerative cells: 1-year outcomes in 11 patients. *Int. J. Urol.* 2014; 21: 294–300.
  13. Carrington EV, Evers J, Grossi U et al. A systematic review of sacral nerve stimulation mechanisms in the treatment of fecal incontinence and constipation. *Neurogastroenterol. Motil.* 2014; 26: 1222– 1237.
  14. Naseem Mirbagheri et al Systematic review of the impact of sacral neuromodulation on clinical symptoms and gastrointestinal physiology. *ANZ j surg* 86(2016)232-236.
  15. Patton V, Wiklendt L, Arkwright JW, Lubowski DZ, Dinning PG. The effect of sacral nerve stimulation on distal colonic motility in patients with faecal incontinence. *Br. J. Surg.* 2013; 100: 959– 968.
  16. Burks FN, Bui DT, Peters KM. Neuromodulation and the neurogenic bladder. *Urol Clin North Am* 2010;37:559-65.
  17. Van Kerrebroeck PE, van Voskuilen AC, Heesakkers JP, et al. Results of sacral neuromodulation therapy for urinary voiding dysfunction: outcomes of a prospective, worldwide clinical study. *J Urol.* 2007;178(5):2029–2034.
  18. Maeda Y, Lundby L, Buntzen S, Laurberg S. Outcome of sacral nerve stimulation for fecal incontinence at 5 years. *Ann Surg* 2013; 259 (6): 1126-31.

# Glycodeline-A, sFlt-1, PlGF Combined as Predictor Markers of First Trimester Pregnancy Loss in Iraqi Women

Mohammed H. Dawood<sup>1</sup>, Halla G. Mahmood<sup>2</sup>, Afraa M. Nedawi<sup>3</sup>

<sup>1</sup>Clinical Biochemistry, Ministry of Health, Baghdad, Iraq, <sup>2</sup>Clinical Biochemistry, Biochemistry school, Scientific School, University of Baghdad, Baghdad, Iraq, <sup>3</sup>Clinical Pathology, Department of Pathology, College of Medicine, University of Baghdad, Baghdad, Iraq

## Abstract

**Objective:** evaluate the serum level of Glycodeline-A, sFlt-1, PlGF combined with  $\beta$ hCG as predictor markers of first trimester pregnancy loss in Iraqi women.

**Method:** A case-control study, carried out from April 2019 to March 2020 and included 85 women, 40 of them as patients which have abortion at the first trimester and 45 of them as healthy control which haven't any complication at the same time of gestation, investigations included serum measurements of  $\beta$ hCG, Glycodeline-A, sFlt-1, PlGF By Method ELISA.

**Results:** Serum Niveaus  $\beta$ hCG, sFlt-1 Was major higher in healthy controls than in patients, while serum level of Glycodeline-A, PlGF was significantly lower in healthy control than in patients, and there is no significant correlation among each of age with other parameters, and there is no significant correlation among each of gest.age with Glycodeline-A and sFlt-1, while there is significant correlation among each of ges.age with  $\beta$ hCG and PlGF  $P < 0.05$ .

**Conclusion:** The present study suggested the significant role of Glycodeline-A, sFlt-1, PlGF in pathogenesis of first trimester pregnancy loss and some of them was related to  $\beta$ hCG in this period and the age of patients wasn't effect on all of these parameters.

**Keywords:**  $\beta$ hCG, Glycodeline-A, sFlt-1, PlGF.

## Introduction

Pregnancy defined as the condition of carrying fetus at the pregnant woman, and can be confirmed by positive urine or blood test with ultrasound that is detection of fetal heartbeat, an X-ray may be using, this condition stay about 9 months beginning from the first day of the (LMP) of the woman, this state is divided ordinarily In three parts, each part Drei Monate period<sup>1</sup>, More important basic cell differentiation Occurrence of fetal during the first three months of pregnancy, so any complication During this stage the embryo is leading to result represent Grave or pregnancy complications, the consistence of blood flow of fetal placental and uteroplacental is the important side of processes of pregnancy and fetal consistence<sup>2</sup>, successful morphogenesis of uterine placental vascular with successful Morphogenicity of fetus blood circulation are the main factor In these

Two Phases systems existing represent these processes of morphogenesis vascular: vasculogenesis: firstly development formation of the blood flow from the activated cells of mesodermal Angiogenesis and : novel vessels Through Blood is formed from present vascular form, which is represent the consistence and development of the system of vascular fetus and placenta through pregnancy. There is no prevent work to protect the pregnant from the miscarriage especially when this situation is occurring whith unknown reason which is undetect, in other site there are many causes that increase the danger of miscarriage, if the pregnant is having difficult maintaining of her carry<sup>3</sup>, the specialist may evaluate some known reasons of miscarriage and remove it through carry, supplement of hormones and nutrients can help to developing embryo, this growing of embryo happened mostly in the first three months of carry, in

most cases miscarriages due to the defect of normally fetus growing<sup>4</sup>, the various symptoms of miscarriage depend on the time of carry age, it happens rapidly even before she know pregnant, these signs include bleeding vagina<sup>5</sup>, tissue drainage, cramping or severe lower pain, back pain mild to heavy, Growth factors play a vital role in the development of vessels; they function as cell mitogens; as attractants in the creation of vascular architectonics; and most notably, as morphogens; the major regulators of angiogenesis are part of the VEGF<sup>6</sup> complex. In addition to direct angiogenesis activators, there is a wide number of causes, including matrix metalloproteinases (MMPs) and their tissue inhibitors (TIMPs), whose effect on angiogenesis is non-specific. production of antiangiogenic Factors are an important part of natural angiogenesis, leading to molecular communication. vascularization<sup>7</sup>, The manufacture of inhibitors acts as a deterrent to unnecessary invasion of trophoblasts, as well as a deterrent to the further growth of the vascular bed and vascularization of pathologically affected tissue locations, angiogenic factors expressed primarily in endothelium and placenta during pregnancy, including receptors VEGFR1 (sFlt1), VEGFR2 (Flk1, KDR) and VEGFR3 (Flt4)<sup>8</sup>, soluble variants of these receptors are able to bind growth factors in circulation, halting or blocking angiogenesis, Humoral factors implicated in vascular development processes are more available for study in maternal circulation, and alteration in their content in mother's blood indicates shifts in the quality of these factors in the fetal blood circulation and tissues<sup>9</sup>. In this regard, a detailed analysis of variables and their ratios correlated with angiogenesis is critical for understanding and predicting vascular morphogenesis disorders during pregnancy<sup>10</sup>. Apparently Soluble tyrosine kinase-1-like fms (sFlt-1) interferes with the events that Inhibiting central angiogenesis and/or blocking invasion of trophoblast. Improved development of Fms-like receptor of tyrosine kinase -1 (sFlt-1) soluble antiangiogenic agent The placenta contributes to the obstetric Physiotherapy . sFlt-1 Is expressed at very high trophoblast rates, and its development in hypoxic conditions is greatly increased role sFlt-1 in pregnancy failures is the focus of ongoing investigation<sup>11</sup>. SFlt-1 in maternal circulation therefore decreased was recently Proposed as a probable distinguishing feature the peril of defeat of pregnancy, PIGF is the angiogenic component most commonly controlled in an uncomplicated first trimester deciduas, Discovering the involvement of angiogenic factors (sFlt-1/PIGF) in the underlying placental disorder pathophysiology,

taking into consideration the biomarkers correlated with angiogenesis are related to a High placental insufficiency disorder, these markers are Relevant to early detection and forecasting assessment<sup>12</sup>, Glycodelin-A (GdA) is an abundant first- trimester glycoprotein deciduas<sup>13</sup> . It participates in fetomaternal defense and early placental growth of different immune cells via its regulatory activities, glycodelin-A is a glycoprotein Consistent with its average expression between 6 and 12 weeks of development in the decidua, Abnormal endometrial rates of glycodelin-A, uterine flushes, and/or maternal serum associate with unexplained miscarriage, early termination of child, and recurrence miscarriage<sup>14</sup>.

**Aim of the study:** To study its position Glycodeline-A, sFlt-1, PIGF combined as predictor markers of first trimester pregnancy loss in Iraqi women.

## Method

**Study Design:** The present project was conducted at the branch of Biochemistry, Medicine College, Baghdad University, at Hospital of Baghdad Teaching through the time from April 19 to March 2020, it included 85 pregnant woman identified the first day of LMP who are confirmed positive pregnancy test in blood, and established to have had pregnancy by Consultant Gynaecologist and matching age 21–35 year and same time 8–12 week of pregnancy and encountered during their attendance the Gynaecology consultation clinic at Baghdad Teaching hospital, encountered these women until the end of week 12 of pregnancy, 40 of them who have pregnancy loss at the prognosis period are patients and the other 45 healthy control who completed the same period without problems, a written consent was applied by each patient and an ethical approval had been suitable the research based of the Medicine College, Baghdad University and the link with Ministry of Health and environment.

**Data Setting:** Eight to ten milliliters (mls) of blood from subjects are draw out and transferred into plain tube, allows for half hour to sure that is clotting, after this, the specimen must be centrifuged to separated the needed serum at 2500 rpm for limited time roughly ten minutes and stored at freezing degree about – 20 Co up to beginning of the assay the project biochemical markers : Beta HCG, Glycodeline-A, sFlt-1, PIGF By ELISA method .

**Inference by Statistics:** Inference by statistics is a method that analysis of details by using SPSS, this

information were putting as simple measures of variants (mean, standard deviation and others), qualitative details which are significant statistically were using student-t-test for compare between two independent means or ANOVA test for compare between different qualitative details on, the statistical significance is equal

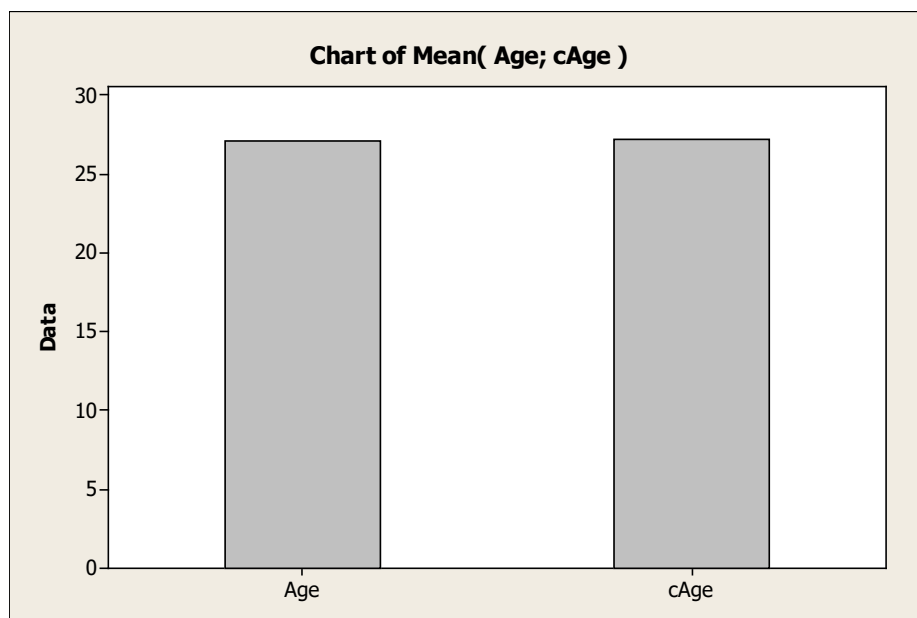
or less than 0.05, the coefficient of correlation value  $r$  : is a kind of coefficient correlation clarify the connection between two different factors that are calculated on the same period,  $r$  may be positive as direct correlation or negative as inverse correlation.

### Results

Explain by table scales of various markers and their correlations according to the study assessment .

**Table 1: Results and their obtained correlations for all markers in this study**

Group Statistics					
	VAR00013	N	Mean	Std. Deviation	Std. Error Mean
Age	1.00	40	27.1250	4.18292	.66138
cAge	2.00	45	27.2444	4.11293	.61312
Gest Age	1.00	40	9.6000	1.29694	.20506
cGestAge	2.00	45	9.5333	1.09959	.16392
Beta HCG	1.00	40	1024.7740	459.39406	72.63658
cBeta HCG	2.00	45	2309.9409	3007.11697	448.27453
Glycodein A	1.00	40	70.9447	56.87327	8.99245
cGlycodlin A	2.00	45	193.7416	200.56648	29.89868
sFlt1	1.00	40	118.2153	76.42478	12.08382
csFlt1	2.00	45	22.2696	19.16359	2.85674
PIGF	1.00	40	141.4350	284.10843	44.92149
CPIGF	2.00	45	340.2947	387.01779	57.69321



**Figure 1: Chart of mean (Age, cAge)**

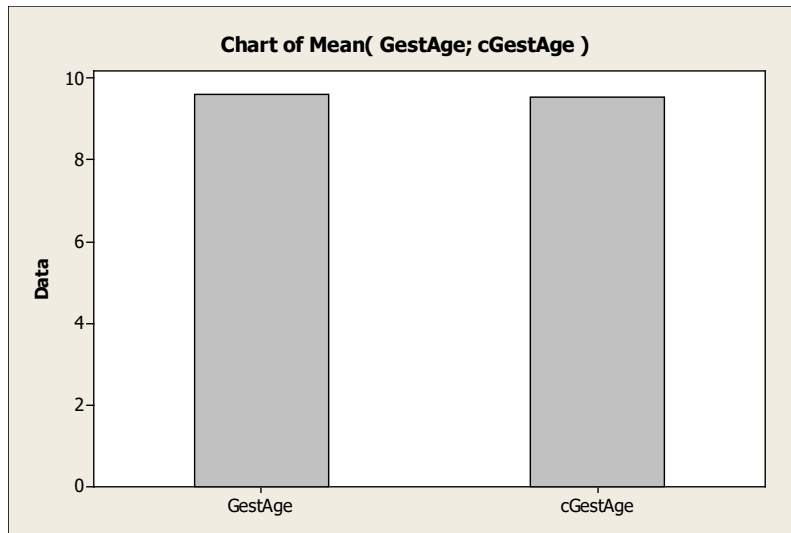


Figure 2: Chart of mean (Gest. age,cGestational age)

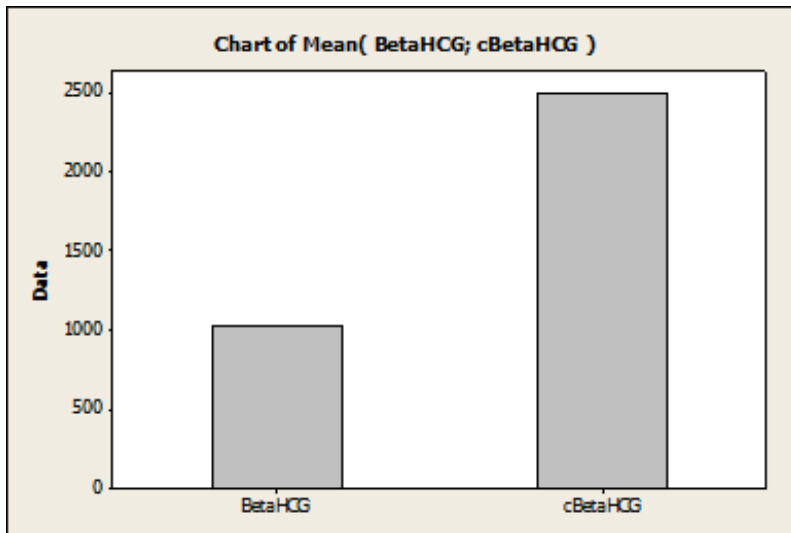


Figure 3: Chart of ( $\beta$ hCG, c $\beta$ hCG)

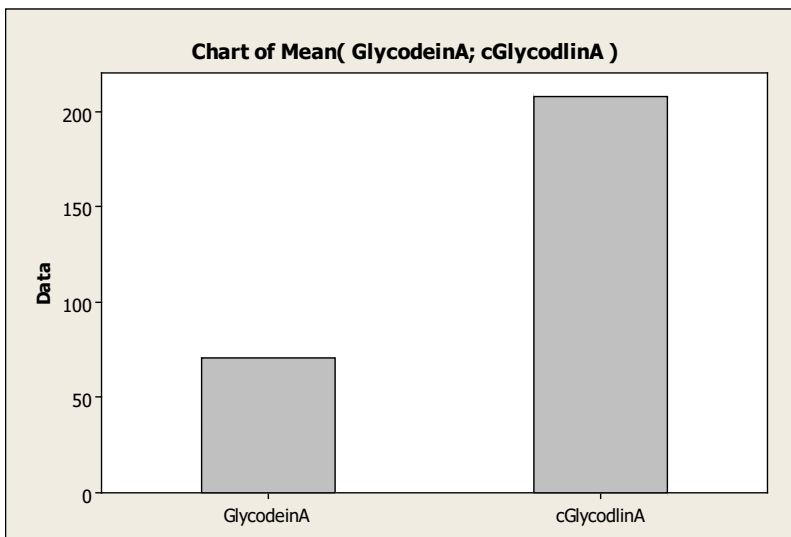


Figure 4: Chart of (Glycodelin-A, cGlycodeline-A)

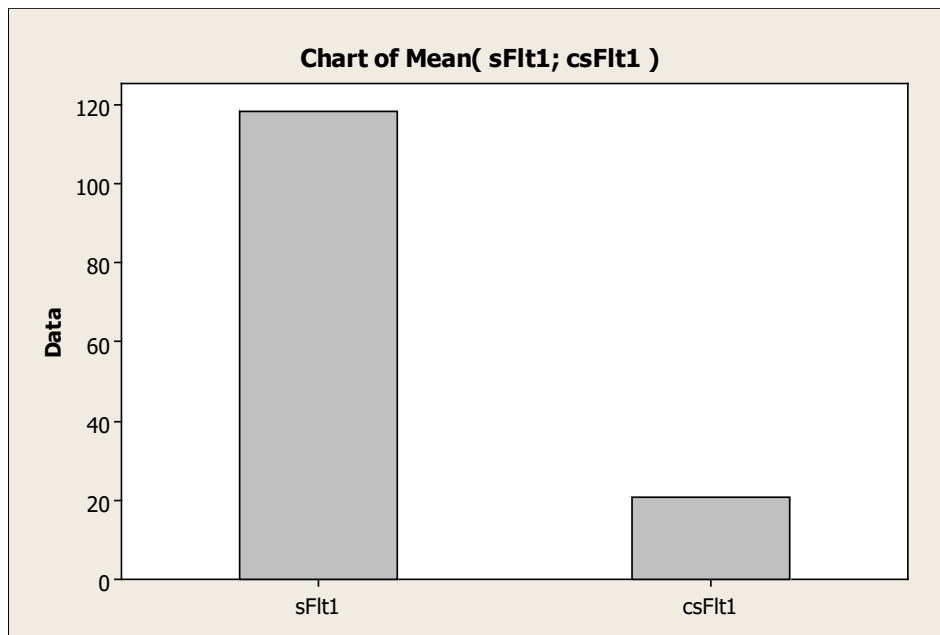


Figure 5: Chart of (sFlt-1, csFlt-1)

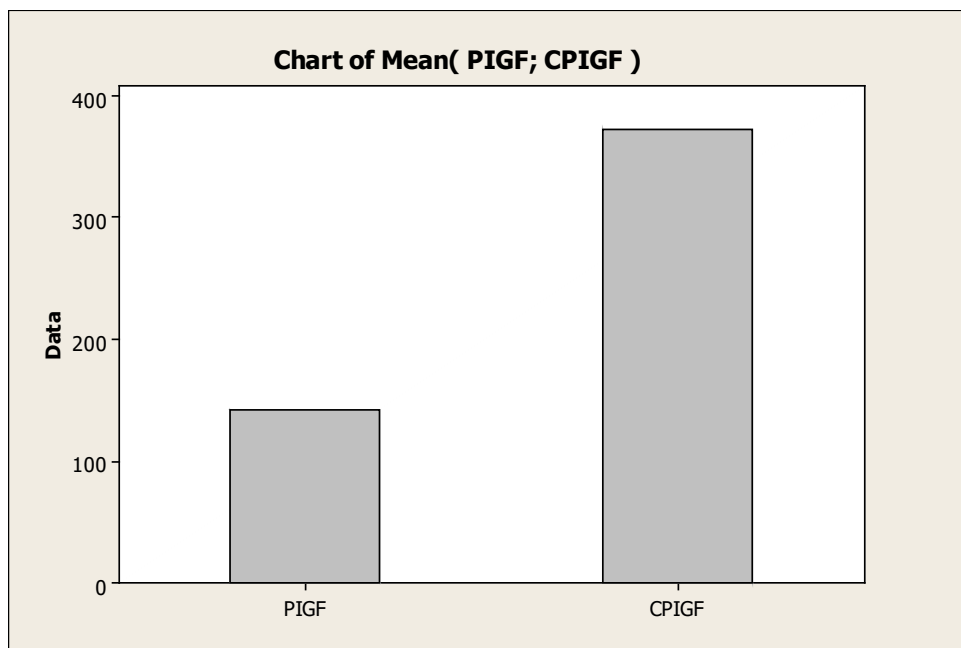


Figure 6: Chart of (PIGF, cPIGF)

### Discussion

Serum level of  $\beta h$  in healthy control group (mean  $\pm$  SD 2309.940  $\pm$ 3007.116) in patients which have abortion (1024.774  $\pm$ 4 59.394) which show significant correlation : P value 0.05, that mean the level of this marker in patients was lower than in healthy control, The present study shows that the serum level of glycodelin-A in healthy control group (mean  $\pm$  SD

193.741  $\pm$  200.566), in patients which have abortion (70.944  $\pm$  56.873) which show significant correlation : P value 0.01, that mean the level of this marker in patients was lower than in healthy control, The present study shows that the serum level of sFlt-1 in healthy control group (mean  $\pm$  SD 22.269  $\pm$  19.163), in patients which have abortion (118.215  $\pm$  76.424) which show significant correlation : P value 0.05, that mean the level of this marker in patients was higher than in healthy

control, The present study shows that the serum level of PIGF in healthy control group (mean  $\pm$  SD 340.294  $\pm$  387.017), in patients which have abortion (141.453  $\pm$  284.108) which show significant correlation : P value 0.05, that mean the level of this marker in patients was lower than in healthy control, most of previous projects have found that the chromosomal agents are effective factor in carry loss<sup>15</sup>, old studies have demonstrated that the normal carry depends on normal immune system which is consist of immune defence, immune response, cytokines<sup>16</sup>, the immune effect is important factor in first carry failed, the immune units that establish at the mediator of placenta and the uterus were stay overlap layer of arrangement by immunity system of mother, this process may help of placental growth but some times reduce the placental aggress the embryo, in the time of implantation natural killer units go to the uterus and help the stimulation secrete of cytokines that inhibit the trophoblast aggress<sup>17</sup>.

### Conclusion

Scales of all markers according to the result which obtained from the assessment of them are clarify the relation between patients which have abortion in the first trimester and healthy control, these results suggest for  $\beta$ hCG: level of this marker in Patients were beyond safe regulation, and for Glycodelin-A: level of this marker in Patients fall beyond safe monitoring, and for sFlt-1: level of this marker in has been careful higher as in healthy check, and for PIGF: level of this marker in patients were beyond safe regulation .

**Ethical Approval:** Describe written consent was applied by each patient and an ethical approval had been suitable the research based of the Biochemistry Department, Medicine College, Baghdad University and the link with Iraqi Ministry of Health .

**Funding Source:** Making of this work depend on authors only.

**Conflict of Interest:** No

**Source of Funding:** Self funded

**Ethical Clearance:** Not Required

### References

- Moran, L. J., McNaughton, S. A., Sui, Z., Cramp, C., Deussen, A. R., Grivell, R. M., & Dodd, J. M. The characterisation of overweight and obese women who are under reporting energy intake during pregnancy. *BMC pregnancy and childbirth*.2018, 18(1), 204.
- Meriwether, K. V., Antosh, D. D., Olivera, C. K., Kim-Fine, S., Balk, E. M., Murphy, M., ... & Crisp, C. C. Uterine preservation vs hysterectomy in pelvic organ prolapse surgery: a systematic review with meta-analysis and clinical practice guidelines. *American journal of obstetrics and gynecology*, 2018. 219(2), 129-146.
- MacGregor, A. Efficacy and side-effects of oral contraceptives. *Prescriber*,2017. 28(8), 19-26.
- MacGregor, A. Efficacy and side-effects of oral contraceptives. *Prescriber*, 2017 28(8), 19-26.
- Oats R, Abraham V, Llewellyn-Jones, Fundamentals of Obstetrics and Gynaecology. 05 Jan 2016.
- Hacker, Gambone & Hobel, Moore, Essentials of Obstetrics and Gynecology. 10 Nov 2018.
- Beischer, MacKay Permezel, Walker, Kyprianou, Obstetrics and Gynaecology and the Newborn .11 Sept 2015.
- Magowan, Owen & Thomson, Clinical Obstetrics and Gynaecology .21 Mar 2016.
- Symonds M, Mike Kagawa, Khadija Malima, Essential Obstetrics and Gynaecology .09 July 2017.
- Bain, Burton C, McGavigan, Gynaecology Illustrated. 05 Oct 2011.
- National Institute for Health and Clinical Excellence, NICE Clinical Guideline 154, (Level III), Ectopic pregnancy and miscarriage: diagnosis and initial management in early pregnancy of ectopic pregnancy and miscarriage .January 20, 2015.
- Barnhart KT, Fertil Steril, Early pregnancy failure. 98:1061–5. (Level III), 2018.
- Doubilet PM, Benson CB, Bourne T, Blaivas M, Barnhart KT, Benacerraf BR, et al., N Engl J Med. (Level III), Diagnostic criteria for nonviable pregnancy early in the first trimester. Society of Radiologists in Ultrasound Multispecialty Panel on Early First Trimester Diagnosis of Miscarriage and Exclusion of a Viable Intrauterine Pregnancy.2018; 369 :1443–51.
- Choobun T, Khanuengkitkong S, Pinjaroen S. (Level II-3), A comparative study of cost of care and duration of management for first-trimester

- abortion with manual vacuum aspiration (MVA) and sharp curettage. 2018; 286 : 1161–4 .
15. Petrou S, McIntosh E, Value Health (Level III), Women's preferences for attributes of first-trimester miscarriage management : a stated preference discrete - choice experiment .2015;12:551–9.
  16. Rausch M, Lorch S, Chung K, Frederick M, Zhang J, Barnhart K, FertilSteril (Level III), A cost-effectiveness analysis of surgical versus medical management of early pregnancy loss .2017; 97: 355–60 .
  17. Colleselli V, Schreiber CA, D'Costa E, Mangesius S, Wildt L, Seeber BE, Arch Gynecol Obstet. (Level II-3), Medical management of early pregnancy failure (EPF) : a retrospective analysis of a combined protocol of mifepristone and misoprostol used in clinical practice .2018; 289 :1341–5.



# The Effect of Using Panicum Mombasa Hay and Millet Hay in the diet on the Production Performance of Awassi Lambs

Mohammed H. Fannos<sup>1</sup>, Husam H. Nafea<sup>1</sup>, Ahmed A. Al-Ani<sup>2</sup>

<sup>1</sup>Student, <sup>2</sup>Prof., College of Agriculture, University of Anbar, Iraq, <sup>2</sup>Research Scholar, Office of Agricultural Researches, Ministry of Agriculture, Iraq

## Abstract

The current study was conducted at Al- Dawar Research Station (30 km to the northeast of Ramadi district center in Anbar Governorate)/Ministry of Agriculture/Agricultural Research Organization/Department of Animal Resource Researches, and for the period from November 1, 2019, to February 1, 2020. This research aims to study the feeding role on the *Panicum maximum* Mombasa hay and Millet hay compared to the alfalfa hay and the mixing between them on the production traits of Awassi lambs. In this experiment, 20 heads of Awassi sheep were used, their ages ranged from 5 to 6 months, and their average weight was  $37 \pm 0.75$  kg. The animals were distributed randomly into five treatments, each treatment containing 3 females and one male; all animals were fed (group feeding/treatment) during the experiment time on the same diet of concentrated forage provided at a percentage of 2% of live body weight/treatment/day. As for the rough forage, it was also provided daily/treatment, but freely, and the next morning the remainder of the concentrated and rough forage was weighed/group. The average total weight gain, the average daily weight gain, the average daily consumption, and the feed conversion efficiency were calculated, and it was observed that there were no significant differences between the treatments in the average live body weight, the total and daily weight gain, the amount of total feed intake (concentrated and rough) and the feed conversion efficiency. It can be concluded from this that the use of *Panicum maximum* Mombasa hay and Millet hay did not negatively affect the product performance of the Awassi lambs.

**Keywords:** *Panicum Mombasa Hay, Millet Hay, Production Performance, Awassi Lambs.*

## Introduction

Iraqi sheep are characterized by low production due to malnutrition, weak soil programs, improvement and poor management, and among the most important reasons that lead to low livestock productivity that is considered, as one of the main problems that farmers face to increase their livestock production is the lack of available forage. One of the important ways to increase the availability of forage in Iraq is to introduce improved forage crop varieties and plant them in the appropriate areas, as there are many types of forage that have been

newly introduced, including Panicum (*Guinea grass*). It is a plant of the Poaceae family, where its scientific name is *panicum maximum* and the English name is Guinea grass<sup>(1)</sup>, which is considered a perennial herb<sup>(2,3)</sup>. However, its cultivation succeeds in tropical and subtropical regions of the world, and it has a tremendous system of roots, which makes its resistance to drought high. In addition to that, it tolerates high temperatures (37-40°C); while the height of Panicum may reach three meters and is characterized by good palatability and a high yield of good quality leaves<sup>(4,5,6)</sup>. Furthermore, its production period is up to ten years, which its productivity is higher than that of alfalfa, Panicum tolerates high salinity of water and soil<sup>(7)</sup>. Other ways to increase the availability of feed include the use of improved varieties, which are characterized by high production of forage and rapid growth, and their high ability to regrow them, as they have become the focus of researchers' attention to

---

### Corresponding Author:

**Dr. Husam H. Nafea**

Prof., College of Agriculture, University of Anbar, Iraq

e-mail: hussam\_979@yahoo.com

cultivate and improve them<sup>(8)</sup>. Among these crops is also the millet plant (*Pennisetum glaucum* L.), where millet is one of the seven most important crops in the world and the second most important crop grown primarily for a dual-purpose after maize. Besides, it is a major crop in semi-arid regions of India and Africa<sup>(9)</sup> and is from the summer crop, which is characterized by abundant growth and many branches, with its smooth, erect stem that carries a large number of leaves that have the ability to regrowth. As it is possible to obtain 3-4 cuts during the growing season, in addition to that the productivity of green forage for millet is superior to many varieties of sorghum<sup>(10),(11)</sup> mentioned that the millet plant could play an important role as a source of forage for ruminants due to its high tolerance to droughts, its short growth cycle that ranges from 60 to 90 days, and its effective ability to regrowth. Finally, the current study aimed to identify the role of feeding on the Panicum Mombasa hay and millet hay, compared to the alfalfa hay and mixing them on the productive performance of the Awassi lambs.

### Materials and Method

**Animal Feeding:** All the experimental animals underwent a preparatory stage for a week before the experiment starts, as all of them were fed (group feeding/group) on concentrated forage, as shown in Tables 1 and 2 at a percentage of 2% of the total live body weight/group, as it is provided at eight in the morning. The rough forage was provided freely as shown in Table 2,

where the animals of the first treatment (T<sub>1</sub>) were fed on alfalfa hay, the second treatment (T<sub>2</sub>) on Panicum hay, and the third treatment (T<sub>3</sub>) on millet hay. Also, the fourth treatment (T<sub>4</sub>) on 50% millet hay and 50% alfalfa hay, and the fifth treatment (T<sub>5</sub>) on 50% Panicum hay and 50% alfalfa hay. The quantity of both concentrated and rough forage consumed daily for each treatment was calculated by weighing the amount provided and subtracting the remaining during the experiment time. While drinking water and mineral salt block were always available for all animals during the experiment. The animals were weighed weekly with an electronic balance for small ruminants to calculate the weight gain/animal/week, in addition to adjusting the concentrated forage quantities provided to each group in light of the total live body weight/group.

**Table [1] The percentages of nutrients included in the concentrated diet**

Nutrients	%
Barley	40
Bran	30
Corn	15
Soybean	12
Limestone	2
Salt	1
<b>Total</b>	<b>100</b>

**Table [2] The chemical composition of the substances included in the composition of concentrate diet, alfalfa hay, Panicum hay, and millet hay**

Materials %	Concentrate forage	Alfalfa hay	Panicum hay	Millet hay
Moisture	7.54	9.14	12.71	12.65
Dry matter	95.91	90.14	96.52	93.13
Ash	12.16	10.97	14.44	8.56
Ether extract	4.97	1.62	1.92	0.97
Crude fiber	7.38	19.96	20.80	10.59
Total protein	14.97	15.25	16.68	13.14

### Results and Discussion

**Average Weekly Weight Gain:** Table [3] showed the effect of using Panicum and millet hay on average body weights during the experiment time, as there was no significant difference between the treatments in all periods of the experiment.

**Table [3]: The effect of using Panicum hay and millet hay in the diet on average live body weight (Mean  $\pm$  standard error)**

Weeks	Treatments					Sig.
	T <sub>1</sub>	T <sub>2</sub>	T <sub>3</sub>	T <sub>4</sub>	T <sub>5</sub>	
1 week	36.60 $\pm$ 2.10	39.10 $\pm$ 2.00	39.26 $\pm$ 3.18	38.13 $\pm$ 1.77	38.66 $\pm$ 1.04	NS
3 weeks	38.66 $\pm$ 2.77	41.20 $\pm$ 1.85	41.66 $\pm$ 3.18	40.53 $\pm$ 2.06	41.00 $\pm$ 1.70	NS
5 weeks	40.93 $\pm$ 3.34	43.06 $\pm$ 1.79	42.73 $\pm$ 3.12	41.60 $\pm$ 2.41	42.60 $\pm$ 2.10	NS
7 weeks	41.26 $\pm$ 1.61	43.53 $\pm$ 1.47	44.0 $\pm$ 3.63	43.56 $\pm$ 2.18	43.93 $\pm$ 2.00	NS
9 weeks	42.33 $\pm$ 2.40	45.86 $\pm$ 0.86	47.06 $\pm$ 3.69	45.66 $\pm$ 2.64	45.40 $\pm$ 2.38	NS
11 weeks	44.73 $\pm$ 3.33	46.46 $\pm$ 1.15	47.56 $\pm$ 3.86	46.80 $\pm$ 3.40	47.06 $\pm$ 2.45	NS
13 weeks	48.40 $\pm$ 3.71	50.26 $\pm$ 0.98	51.53 $\pm$ 4.09	50.93 $\pm$ 2.97	51.46 $\pm$ 3.13	NS

**Note:** NS means that there are no significant differences between the treatments.

Except, it was observed from the results that the treatment (T<sub>2</sub>) and (T<sub>3</sub>) are arithmetically superior over the rest of treatments in the first week, and in the fifth week, the results showed an arithmetic increase in body weight in the treatment (T<sub>2</sub>) over the other treatments. In the other weeks, it is evident from the same Table that there was an arithmetic increase in the average body weight in the treatment (T<sub>3</sub>) over the other treatments. The results of this study are agreed with the (12) findings that they did not notice a significant difference between the treatments in the study, which included feeding goats on Panicum hay, green Panicum, Panicum hay and Panicum silage in average body weight. Besides, (13) did not notice a significant difference between the treatment which are fed Panicum and other treatments that are fed different types of forages. Whereas, the results of the study did not agree with (14) when feeding Panicum to African rams with the addition of leguminous grains, as the treatments of adding legume supplements are significantly superior ( $P \leq 0.05$ ) in body weight over the treatment of Panicum only. Finally, (15) noted significant differences ( $P \leq 0.05$ ) in the average body weight of goats fed on Panicum while providing cobalt in different proportions orally.

**Total Weight Gain:** The results of Table 4 showed the effect of using Panicum and millet hay in the diet on the average total weight gain during the experiment time. It was observed from the results that there were no significant differences between the treatments, but there is an arithmetic superiority in the treatment (T<sub>4</sub>) and the treatment (T<sub>5</sub>) over the other treatments. The results of the study agreed with the (16) findings in their experiment on goats, that there was no significant difference between

the treatment fed on Panicum and the treatment fed on Panicum with an addition of 15% of the Moringa leaves. The results did not agree with (13) finding, in which they were observed significant differences ( $P \leq 0.05$ ) between the treatments in the average total weight gain. As well as, (14) showed the presence of a significant difference ( $P \leq 0.05$ ) between the treatment that fed only Panicum and the treatment that fed on Panicum with the addition of legume supplements, the treatments that were added to the legume supplements were superior.

**Daily Weight Gain:** It is evident from the results of Table [4] that there were no significant differences between animals in the average daily weight gain between treatments and for all periods, and the Table observed the arithmetic superiority in the treatments T<sub>4</sub> and T<sub>5</sub> over the other treatments. These results are consistent with the<sup>(17)</sup> findings that showed there were no significant differences between calves fed on Panicum and calves fed on different grass, and<sup>(12)</sup> did not observe a significant difference between the treatments of four forms of Panicum (hay, green, silage, and hay) that were fed to sheep. Moreover, the results of this study did not agree with what<sup>(11)</sup> findings when feeding rams on the millet silage with the addition of different percentages of urea, and significant differences ( $P \leq 0.05$ ) were observed between the treatments, as the addition treatments were superior in the daily weight gain. Furthermore, <sup>(18)</sup> showed in a study on African goats, there was a significant difference ( $P \leq 0.05$ ) between the treatments, where the treatments fed on Panicum by adding 10 and 15% of the Moringa leaves were significantly superior ( $P \leq 0.05$ ) to the treatment fed on Panicum only.

**Total feed intake:** It is evident from the results of Table [4] that there were no significant differences between the treatments in the amount of total feed intake. However, it was observed from the Table results that there was an arithmetic increase in the amount of feed intake in the treatments T<sub>1</sub>, T<sub>2</sub>, T<sub>5</sub>, the results are consistent with<sup>(17,18)</sup>. These results differed with<sup>(14)</sup> findings when they fed rams on Panicum and Panicum with the addition of legume supplements, as they found a significant difference between the treatments in the amount of feed intake.<sup>(19)</sup> observed the presence of a significant increase in the amount of feed intake between the treatment of rams that fed on Panicum only and treatments that were fed Panicum with the addition of different proportions of cotton seeds and Moringa leaves.

**Feed conversion efficiency:** It is evident from the results of Table [4] that there was no significant difference

between the treatments in the feed conversion efficiency, where the treatment T<sub>2</sub> achieved a mathematical improvement compared to other treatments. The study results agreed with (13), and with (12) that observed no significant differences in the feed conversion efficiency when feeding goats on Panicum compared to other treatments. The study results differed with the (14) findings, that showed a significant difference ( $P \leq 0.05$ ) in the feed conversion efficiency of male African sheep, where the treatment that fed Panicum with the addition a variety of legume supplements exceeded over the treatment fed on Panicum only.<sup>(11)</sup> study showed that there was a significant improvement ( $P \leq 0.05$ ) in the treatment of sheep fed on the millet silage with an addition of 20% of urea in the feed conversion efficiency over the treatment fed on the millet silage without any addition.

**Table [4] The effect of using Panicum hay and millet hay in the diet on the total and daily weight gain, feed consumption and feed conversion efficiency (mean  $\pm$  standard error)**

Treatments	Studied traits			
	Total weight gain (kg)	Daily weight gain (g)	Amount of feed intake (hay + concentrate) (kg)	Food conversion efficiency
T <sub>1</sub>	11.80 $\pm$ 1.61	131.11 $\pm$ 17.96	476.64 $\pm$ 12.36	8.25 $\pm$ 0.52
T <sub>2</sub>	11.16 $\pm$ 1.64	124.07 $\pm$ 18.32	471.40 $\pm$ 10.55	7.90 $\pm$ 0.39
T <sub>3</sub>	12.26 $\pm$ 0.96	136.29 $\pm$ 10.75	462.80 $\pm$ 10.26	8.83 $\pm$ 0.64
T <sub>4</sub>	12.80 $\pm$ 1.24	142.22 $\pm$ 13.87	456.76 $\pm$ 9.46	9.34 $\pm$ 0.64
T <sub>5</sub>	12.80 $\pm$ 2.10	142.22 $\pm$ 23.23	475.75 $\pm$ 12.52	8.96 $\pm$ 0.51
Significance level	NS	NS	NS	NS

**Note:** N.S means no significant differences between the treatments

### Conclusion

The study results observed the absence of significant differences between the five treatments in each of the average weekly body weight, total and daily weight gain, the total amount of forage (concentrated and roughly) intake, and the feed conversion efficiency.

**Conflict of Interest:** None

**Funding:** Self

**Ethical Clearance:** Not required

### References

- Muir, James P, & Jank, L.. Guinea grass. Warm-season (C4) grasses, 2004. 45, 589–621.
- Aganga, A. A., & Tshwenyane, S.. Potentials of Guinea grass (*Panicum maximum*) as a forage crop in livestock production. *Pakistan journal of nutrition*, 2004. 3(1), 1–4.
- Pedreira, B. C., Pedreira, C. G. S., & Lara, M. A. S. Leafage, leaf blade portion, and light intensity as determinants of leaf photosynthesis in *Panicum maximum* Jacq. *Grassland Science*, 2015. 61(1), 45–49.
- Corsi, M., & Santos, P. M. Potencial de produção do *Panicum maximum*. *SIMPÓSIO SOBRE MANEJO DA PASTAGEM*, 1995. 12, 275-303.
- Chen, C. P., & Hutton, E. M. *Panicum maximum* Jacq. *Plant Resources of South-East Asia*, 1992. 4, 172–174.

6. Muir, J P, Alage, A., Maposse, I. C., & Gomide, J. A. Herbage characteristics as affected by the canopies of dominant trees in the savanna of southern Mozambique. *Proc 19th IGC*, 2001. 655–656.
7. Hare, M. D., Phengphet, S., Songsiri, T., & Sutin, N. Botanical and agronomic growth of two *Panicum maximum* cultivars, Mombasa and Tanzania, at varying sowing rates. *Tropical Grasslands-Forrajes Tropicales*, 2014. 2(3), 246–253.
8. Akash, M. W., & Saoub, H. M. Grain yield of three sorghum varieties as influenced by seeding rate and cutting frequency. *Journal of Agronomy*. 2002.
9. Sridevi, N. Marker-assisted introgression of stover quality QTL in pearl millet. Acharya NG Ranga Agricultural Univerisity. 2005.
10. Shah, P., & Perveen, S. Growth characters and productivity of forage oats varieties at Peshawar [Pakistan]. *Sarhad Journal of Agriculture (Pakistan)*. 2004.
11. Carvalho, G. G. P., Freitas, P. M. D., Santos, E. M., Araújo, G. G. L., Oliveira, J. S., Pires, A. J. V., Maranhão, C. M. A., Rodrigues, T. C. G. C., Freitas Júnior, J. E., Rufino, L. M. A., Rodrigues, C. S., Leite, L. C., & Araujo, M. L. G. M. L. Effect of pearl millet silage ammoniated with urea on lamb production and metabolic performance. *Grass and Forage Science*, 2018. 73(3), 685–693.
12. Eyoh, G. D., Udo, M. D., & Edet, C. P. Growth Performance and Carcass Characteristics of West African Dwarf Bucks Fed Different Forms of Processed Guinea grass (*Panicum Maximum*). *Current Agriculture Research Journal*, 2019. 7(2), 254–260.
13. Eyoh, G. D., & Ayuk, A. A. Growth performance and carcass characteristics of West African dwarf (WAD) goats fed selected forages in Akwa Ibom State. *Journal of Animal Science and Veterinary Medicine*, 2019. 4(2), 78–83.
14. Ojo, Victoria Olubunmi A., Oyaniran, D. K., Ogunsakin, A. O., Aderinboye, R. Y., Adelusi, O. O., & Odusoga, F. S. Effects of supplementing herbaceous forage legume pellets on growth indices and blood profile of West African dwarf sheep fed Guinea grass. *Tropical Animal Health and Production*, 2019. 51(4), 867–877.
15. Yousuf, M. B., Belewu, M. A., & Badmus, A. H. A. Effects of cobalt supplements on performance of panicum maximum hay fed goats. *Centrepoint Journal*, 2009. 16, 1-6.
16. Tona, G. O., Ogunbosoye, & Bakare, B. A. Original Research Article Growth performance and nutrient digestibility of West African Dwarf goats fed graded levels of Moringa oleifera leaf meal. *International Journal of Current Microbiology and Applied Sciences*, 2014. 3(8), 99–106.
17. Loresco, M. M., Andal, M. J. C., Ty, K. J. S., & Angeles, A. A. Growth Performance of Growing Dairy heifers fed fresf MULATO II (*Brachiaria ruziziensis* x *B. decumbens* x *B. brizantha*) and MOMBASA (*Panicum maximum* Jacq. cv. Mombasa) Compared to NAPIER (*Pennisetum purpureum* Schum.). *Philippine Journal of Veterinary and Animal Sciences*, 2019. 45(1–3), 87–90.
18. Jiwuba, P. C., Ahamefule, F. O., Ogbuewu, I. P., & Ikwunze, K. Blood chemistry and hematology of West African Dwarf goats fed Moringa oleifera leaf meal (MOLM) in their diet. *Comparative Clinical Pathology*, 2017. 26(3), 621–624.
19. Adegun, M.K., and Aye, P. A. Growth performance and economic analysis of West African Dwarf Rams fed Moringa oleifera and cottonseed cake as protein supplements to *Panicum maximum* Department of Animal Production and Health Sciences. *American Journal of food and nutrition*, 2013. 3(2), 58–63.

# Effect of Combined Antibiotics and Biofilm Formation in Some Bacterial Pathogens from Otitis Media among Children in Baghdad, Iraq

Mohammed Khudhair Alwan<sup>1</sup>, Kais Kassim Ghaima<sup>2</sup>, Zainab Shaban Khalaf<sup>1</sup>

<sup>1</sup>Ministry of Health, Baghdad, Iraq, <sup>2</sup>Institute of Genetic Engineering and Biotechnology for Postgraduate Studies, University of Baghdad, Baghdad, Iraq

## Abstract

Otitis media bacterial infections during childhood may contribute to the development of repeated nasopharyngeal infections and it is complicated of recurrent or chronic middle ear diseases, especially with multidrug resistant strains.

The results of antibiotic synergism for the most prevalent three bacterial species, isolated from otitis media infections in children, and had the highest antibiotic resistance was revealed that combinations ceftazidime-amikacin and ceftazidime- ciprofloxacin displayed synergistic activity fractional inhibitory concentration (FIC  $\leq$  0.5) against the most of tested isolates; *Pseudomonas aeruginosa*, *Porteus mirabilis*, and *Klebsiella pneumoniae*. In the biofilm test all tested isolates were showed biofilm production by tissue culture plate method (TCP), in the present study, the strong biofilm production was most prevalent in *Pseudomonas aeruginosa* (100%) followed by *S. aureus* (71.4%). Biofilm formation increases the activity of antibiotics in children otitis media infections and using antibiotics combinations may be essential for optimum management of OM patients.

**Keywords:** Otitis media, Biofilm, Antibiotics, synergistic activity.

## Introduction

Otitis media (OM) is an inflammatory disease of the middle ear, with different medical conditions and symptoms. It is caused as a result of a blockage to the Eustachian tube. In contrast with adults, the Eustachian tube is shorter and more horizontal in children and also it consists of more flaccid cartilage, which can impair its opening, therefore otitis media is more common in children<sup>(1)</sup>. Recurrent Acute otitis media (RAOM) causes pain and discomfort in children, also it was noted that 20–

30% of infants suffer from RAOM and approximately 70% of infants experience at least one otitis episode by the age of 2 years<sup>(2)</sup>. Multiple otopathogens can colonize the middle ear and nasopharyngeal. The bacterial attachment and colonization, biofilm formation, and invasion of the middle ear are enhanced by the viral infections of the nasopharynx<sup>(3)</sup>. The main pathogenic bacteria which contribute with the middle ear infections are *Haemophilus influenzae*, *Streptococcus pneumoniae*, *Streptococcus pyogenes*, and *Moraxella catarrhalis* and considered as the main risk for OM and RAOM<sup>(4,5)</sup>. Several studies indicated to other species which isolated from the middle ear fluid of children as causative agents of chronic suppurative otitis media (CSOM) such as *Pseudomonas aeruginosa*, *Staphylococcus aureus*, *Staphylococcus epidermidis*, *Klebsiella spp* and *Escherichia coli*<sup>(6,7)</sup>. Most of the bacterial pathogens can form biofilm as the main step for colonization and this biofilm provide some bacteria more effective resistance and tolerance to antibiotics according to the

---

### Corresponding Author:

#### Kais Kassim Ghaima

Assistant Professor, Institute of Genetic Engineering and Biotechnology for Postgraduate Studies, University of Baghdad, Baghdad, Iraq  
e-mail: kaiskassim@gmail.com

complicated structure of bacterial biofilm<sup>(8)</sup>. In Iraq, there is little attention about the study of the role of bacteria species in Otitis media occurrence and their capacity to the formation of biofilm and its relation to increasing antibiotic resistance. Therefore the aims of the study are: Isolation and identification of some species of bacteria, which infect the Iraqi children with otitis media infection by using conventional and molecular method. Investigate the antibiotic resistance of these isolates and study their ability to form the biofilm as a virulence factor. Also, conducting the antibiotics synergism to detection the lowest concentrations of the combination of antibiotics to avoid resistance of bacteria.

## Materials and Method

**The samples of the study:** The collection of study samples has taken place at the period between November 2018 and completed at end of April 2019, it has included 138 clinical specimens as ear discharge samples, collected from inpatients and outpatients with otitis media infections that admitted in four hospitals in Baghdad, from both gender with age ranging from 6 months to 15 years.

**Isolation and identification of bacteria:** The bacterial which selected for this study were identified by biochemical tests and Vitek2 system, these isolates include 28 of pathogenic bacterial isolates distributed as 7 from 4 species (*Pseudomonas aeruginosa*, *Proteus mirabilis*, *Klebsiella pneumoniae* and *Staphylococcus aureus*) for Quantification of biofilm formation. From the same group of bacteria, 18 multidrug resistant isolates of three bacteria species (*Pseudomonas aeruginosa*, *Proteus mirabilis*, and *Klebsiella pneumoniae*) were selected for evaluation the antibiotics combination

**Antibiotics Synergy Test by Using Checkerboard Method:** Checkerboard is method to evaluate interactions between antibiotics with serial concentrations as synergism, additive, indifferent, or antagonism<sup>(9)</sup>.

Amikacin, Ciprofloxacin and Ceftazidime, each antibiotic is prepared and MICs are calculated for each antibiotic by microdilution method by using resazurin dye as described by Elshikh *et al.* (2016)<sup>(10)</sup>.

The checkerboard method uses for study Synergism between Ceftazidime – Ciprofloxacin and Ceftazidime – Amikacin. The test done for most prevalent three bacterial species with the highest antibiotic resistance, which detected in otitis media cases. The concentrations

were from (1 µL -64 µL) for Ceftriaxime, (0.5 µL-256 µL) for Amikacin and Ciprofloxacin. Dilution checkerboard technique was conducted to evaluate the effect of antibiotic combinations. Fractional inhibitory concentration (FIC) indices for each agent is calculated by dividing the MIC of the antibiotics when used in combination by that of the drug alone. The FIC index is the sum of the FICs of each of two antibiotics when examined in combination<sup>(11)</sup>.

A minimum FIC index of  $\leq 0.5$  indicates synergy, while, if the minimum FIC index is  $>0.5$  and  $\leq 1$ , the effect of the combination was classified as additive. If the minimum FIC index is  $>1$  and  $\leq 2$ , the effect of the combination was classified as indifferent, and antagonistic if  $>2$ <sup>(9)</sup>.

**Microtitre plate assay for biofilm quantification:** Biofilm was formed on 96 well flat bottom polystyrene microtitre plates as described by Kırmusaoglu (2019)<sup>(12)</sup>. Briefly, A 10 µl of cell suspension having 0.5 O.D600 nm was inoculated in 190 µl Tryptic soy broth medium in each well. Two hundred µl of sterile distilled water was added in peripheral wells to reduce the water loss. Then microtitre plate was incubated at 37 °C for 18 h. After aspiration of planktonic cells, biofilms were fixed with 99% methanol. Plates are washed twice with phosphate buffer saline or sterile saline water and air dried. Then, 200 µl of crystal violet solution (0.2%) was added to all wells and the excess crystal violet was removed after 5 min, and plates were washed twice and air dried. The cell bound crystal violet was dissolved in 33% acetic acid. Biofilm formation was measured in terms of O.D 570 nm using micro plate reader. Cut off value (OD<sub>c</sub>) was calculated, which can provide categorization of isolates as biofilm producer or not.

**Statistical Analysis:** The Statistical Analysis System, SAS (2012)<sup>(13)</sup> program used in this study. According to Chi-square test uses for significant comparing between percentages. Least significant difference (LSD) test was used to significant compare between means (0.05 and 0.01 probability) in this study

## Results and Discussion

The checkerboard method uses for studying Synergism between Ceftazidime- Ciprofloxacin and Ceftazidime – Amikacin. The test is done for most prevalent three bacterial species with the highest antibiotic resistance, which detected in otitis media infections. The concentrations are from (1 - 64 µg/ml) for Ceftriaxime,

(0.5 - 256 µg/ml) for Amikacin and Ciprofloxacin. The results of MICs of three antimicrobial agents and FICs of 2 combinations against 18 isolates of three bacteria

species (*Pseudomonas aeruginosa*, *Proteus mirabilis*, and *Klebsiella pneumoniae*) are showed in Table (1).

**Table (1). MIC of antibiotic combinations and synergy test results.**

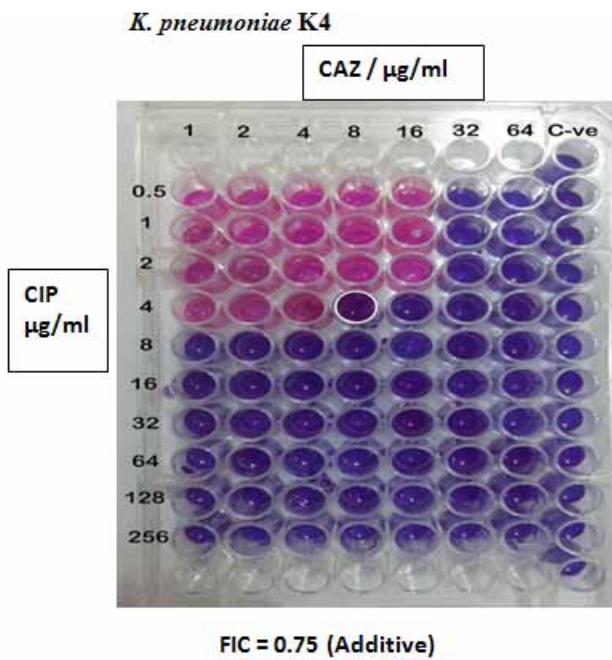
Isolates	Antibiotics combination	MIC of first antibiotic alone (µg/ml)	MIC of first antibiotic in combination (µg/ml)	MIC of second antibiotic alone (µg/ml)	MIC of second antibiotic in combination (µg/ml)	FIC	Result
A1	AK-CAZ	64	16	64	8	0.375	Synergy
A1	CIP-CAZ	4	4	64	16	1.25	Indifferent
A5	AK-CAZ	8	2	128	32	0.5	Synergy
A5	CIP-CAZ	32	8	128	32	0.5	Synergy
A27	AK-CAZ	64	16	64	8	0.375	Synergy
A27	CIP-CAZ	4	2	64	16	0.75	Additive
P1	AK-CAZ	32	4	32	8	0.375	Synergy
P1	CIP-CAZ	2	1	32	16	1.0	Additive
P20	AK-CAZ	64	16	64	16	0.5	Synergy
P20	CIP-CAZ	32	32	64	32	1.5	Indifferent
P23	AK-CAZ	32	4	32	16	0.625	Additive
P23	CIP-CAZ	64	16	32	8	0.5	Synergy
K4	AK-CAZ	64	16	16	4	0.5	Synergy
K4	CIP-CAZ	16	4	16	8	0.75	Additive
K14	AK-CAZ	128	64	64	32	1	Additive
K14	CIP-CAZ	32	8	64	8	0.375	Synergy
K15	AK-CAZ	128	32	64	16	0.5	Synergy
K15	CIP-CAZ	16	4	64	16	0.5	Synergy

FIC: Fractional Inhibitory Concentration; AK: Amikacin; CAZ: Ceftazidime; CIP: Ciprofloxacin; A= *Pseudomonas aeruginosa*, P = *Proteus mirabilis*, K= *Klebsiella pneumoniae*.

Results revealed combinations ceftazidime-amikacin and ceftazidime-ciprofloxacin displayed synergistic activity (FIC ≤ 0.5) against the most of tested isolates except tow isolates *P. aeruginosa* A 1 and *P. mirabilis* P20, which showed indifferent with the ceftazidime-ciprofloxacin combination.

In the current study, none of the antimicrobial combinations tested demonstrated antagonism against any of the isolates tested. Out of 18 isolates, 11 exhibited synergistic activities, while the additive activity showed in 5 isolates, as the result of *K. pneumoniae* K4 (Figure 1).





**Figure (1).** FIC of antibiotics combination ceftazidime-amikacin against *K. pneumoniae* K4.

The four isolates *P. aeruginosa* A1, A27, *P. mirabilis* P1, and *K. pneumoniae* K14 displayed the highest affected by the 2 combinations especially with ceftazidime-amikacin (FIC = 0.375) (Table 1).

Antibiotic combinations to the treatment the resistant infections, have been reported to be effective. One drug may overwhelm or neutralize the mechanisms of bacterial resistance, repurposing the antibiotic drug by increasing its efficacy. May be the best-known example of antibiotic synergy is the combination of clavulanic acid with  $\beta$ -lactam antibiotics<sup>(14)</sup>. Antibiotic combination therapy is used to prevent the emergence of resistant microbial strains, treat emergency cases during the process of etiological diagnosis, and to take advantage of antibiotic synergism. This is noted to be effective when two bactericidal agents are combined, but antagonism occurs *in vitro* on combination of a bacteriostatic and a bactericidal antibiotic<sup>(15)</sup> checkerboard technique is an *in vitro* synergy test using to determine the antimicrobial combinations activity. It is a simple to perform and remains to be a widely used technique to assess antimicrobial combinations<sup>(16)</sup>. Aminoglycoside and beta-lactam combinations are

the most frequent used for the treatment of many infections especially due to *P. aeruginosa*. Many studies reported these synergistic combinations<sup>(17,18)</sup>. In this study, it is detected that the synergy was obvious between Ceftazidime and Amikacin against *P. aeruginosa* isolates. Also, many reports indicated to the combinations of quinolone and beta-lactam antibiotics and the synergism with several rates was observed<sup>(19, 20)</sup>. In this study, synergy was less effective in resistant strains with Ceftazidime-ciprofloxacin combination. Mayer and Nagy (1999)<sup>(19)</sup> revealed that the combination of third-generation cephalosporin with fluoroquinolones rarely shows synergy. In agreement with the results of current study, Hannan *et al.* (2014)<sup>(21)</sup> showed that among the four combinations evaluated ceftazidime-ceftazidime-meropenem, piperacillin/tazobactam, ceftazidime-amikacin and ceftazidime-ciprofloxacin, ceftazidime-amikacin was in high rates of synergy in multidrug resistant strains of *P. aeruginosa*. Combinations of aminoglycosides and  $\beta$ -lactams have synergic effects against gram negative isolates of this study. The mechanism of this combination may be due to the action of  $\beta$ -lactams on bacterial cell wall by destruction of peptidoglycan polymers and then easily of the entry of the aminoglycosides into the bacterial cell<sup>(22)</sup>.

Out of the total isolates of OM infections, 28 isolates with high antibiotic resistance are selected for detection the Quantitative biofilm formation by Tissue Culture Plate (TCP) method, these isolates were distributed as 7 from 4 species which include (*Pseudomonas aeruginosa*, *Proteus mirabilis*, *Klebsiella pneumoniae* and *Staphylococcus aureus*). Quantification of biofilm formation has been shown in Table (2) and Figure (2).

All isolates (100%) showed biofilm production by TCP method. Strong biofilm producers were 14 (50 %), 10 (35.7%) were moderate and 4 (14.2%) isolates were considered as weak biofilm producers. In this study, the strong biofilm production is the most prevalent in *P. aeruginosa* (7, 100%) followed by *S. aureus* (5, 71.4%), while the most of *P. mirabilis* and *K. pneumoniae* are moderate biofilm producers.

Table (2). Screening of OM pathogenic isolates for biofilm formation by Tissue Culture Plate method.

BACTERIAL SPECIES	Number of investigated isolates (%)	BIOFILM PRODUCTION				Chi-Square ( $\chi^2$ )
		STRONG	MODERATE	WEAK	NON PRODUCTION	
<i>Pseudomonas aeruginosa</i>	7	7	0	0	0	6.34 **
<i>Proteus mirabilis</i>	7	1	4	2	0	2.08 NS
<i>Klebsiella pneumoniae</i>	7	1	5	1	0	4.52 *
<i>Staphylococcus aureus</i>	7	5	1	1	0	4.71 *
<b>Total</b>	<b>28 (100 %)</b>	<b>14 (50 %)</b>	<b>10 (35.7 %)</b>	<b>4 (35.7 %)</b>	<b>0</b>	<b>6.41 **</b>

\* (P<0.05), \*\* (P<0.01).

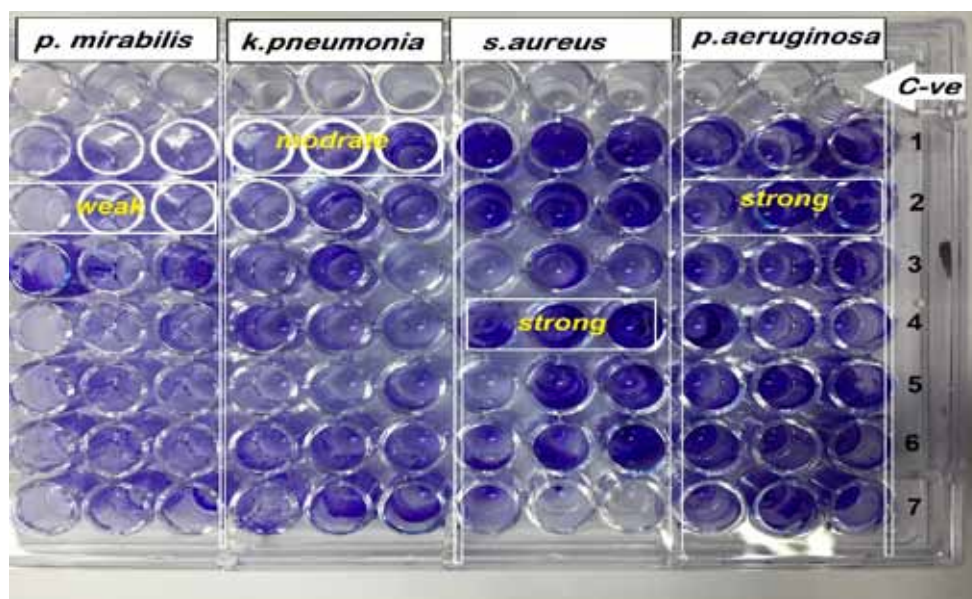


Figure (2). Detection of biofilm producers of otitis media bacterial pathogens by Tissue Culture Plate method with crystal violet staining.

In this study, the unique ability of *P. aeruginosa* to form biofilm makes it as the main cause of OM infections in Iraqi children, where, Chronic suppurative otitis media is largely due to biofilm-forming bacteria, of which a common pathogen is *Pseudomonas aeruginosa*, and this species develop into biofilms and form chronic infections in the middle ear of a mouse model of Eustachian tube obstruction and acute tympanic membrane wounds<sup>(23)</sup>.

The weak biofilm formation of *P. mirabilis* and *K. pneumoniae* in OM infection may be due to that these

bacteria related to bacterial colonization of catheter devices infections such as urinary tract infections<sup>(24)</sup>. It finds that the mucosal biofilm has been implicated in several pediatric respiratory infections, including otitis media with effusion, tonsillitis, adenoiditis, persistent endobronchial infections, chronic rhinosinusitis, and bronchiectasis<sup>(25)</sup>. The nasopharyngeal biofilms have the main role in the effectiveness of antibiotic in children with otitis media, because the biofilm play a role in the development of chronic nasopharyngeal inflammation, which is may be associated with chronic

or recurrent middle ear disease<sup>(26)</sup>. The bacterial biofilms of clinically *H. influenzae* in patients with acute otitis media infections are responsible for the development of acute middle ear infections on the basis of the detection of biofilms produced by this species<sup>(27)</sup>. The production of biofilm may explain the failure of traditional antibiotic treatment acute otitis media, which act as favourable environment<sup>(28)</sup>. Biofilm formation is considered as a survival strategy by bacteria to antibiotics which are effective against bacteria. Biofilms are almost impossible to grow in the laboratory media and are incredibly resistant to antimicrobials, which mean that the diagnosis of chronic OM is one of the most challenging in the management of middle-ear infection<sup>(29)</sup>. The previous results gave a role of biofilm formation in the entire cavity of the middle ear of children with recurrent AOM, contributing to the viscosity of effusion<sup>(30)</sup>.

### Conclusion

The current study revealed that the strong biofilm was the most prevalent in *P. aeruginosa* followed by *S. aureus* and the biofilm formation leads to difficulty in treatment of OM, mainly due to its frequent association with multidrug resistant bacteria, also, it was obvious that the Combinations ceftazidime-amikacin and ceftazidime-ciprofloxacin displayed synergistic activity against the most of tested isolates.

**Source of Funding:** Authors

**Ethical Clearance:** Yes

**Conflict of Interest:** Nil

### References

1. Biradar SK. Study of Microbiological Profile and their Antibigram in Patients with Chronic Suppurative Otitis Media. IJCMAS. 2015; 4(9): 981-85.
2. Klein JO. The burden of otitis media. Vaccine. 2000; 19: S2-S8.
3. Murphy TF, Chonmaitree T, Barenkam S, Kyd J, Nokso-Koivisto J, Patel JA. Microbiology and immunology panel. Otolaryngol Head Neck Surg. 2013; 148(4): 64-89.
4. Pelton SI, Leibovitz E. Recent advances in otitis media. The Pediatric Infectious Disease Journal. 2009; 28(10): S133-S137.
5. Pichichero ME. Ten-year study of acute otitis media in Rochester, NY. The Pediatric Infectious Disease Journal. 2016; 35(9): 1027-1032.
6. Ngo C, Maasa H, Thorntion R, Cripps A. Predominant bacteria detection from the middle ear fluid of Children experiencing Otitis media: A systematic review . Pals One . 2016; 11: e0150949.
7. Toman J, Moll A, Barnes M, Shenoi S, Porterfield JZ. The Role of Routine Culture in the Treatment of Chronic Suppurative Otitis Media: Implications for the Standard of Care in Rural Areas of South Africa. Tropical medicine and infectious disease. 2019; 4(1): 10.
8. Kumar A, Alam A, Rani M, Ehtesham NZ, Hasnain SE. Biofilms: Survival and defense strategy for pathogens. International Journal of Medical Microbiology. 2017; 307(8): 481-489.
9. Rizvi M, Ahmad J, Khan F, Shukla I, Malik A, Sami H. Synergy of drug combinations in treating multidrug-resistant *Pseudomonas aeruginosa*. The Australasian Medical Journal. 2015; 8(1): 1.
10. Elshikh M, Ahmed S, Funston S, Dunlop P, McGaw M, Marchant R. et al. Resazurin-based 96-well plate microdilution method for the determination of minimum inhibitory concentration of biosurfactants. Biotechnol Lett. 2016; 38:1015-1019.
11. Nakamura A, Hosoda M, Kato T, Yamada Y, Itoh M, Kanazawa K, Nouda H. Combined effects of meropenem and aminoglycosides on *Pseudomonas aeruginosa* in vitro. Journal of Antimicrobial Chemotherapy. 2000; 46(6): 901-904.
12. Kırmusaoglu S. The Method for Detection of Biofilm and Screening Antibiofilm Activity of Agents. In: Exopolysaccharides-Method of Preparation and Application. IntechOpen, 2019.
13. SAS. Statistical Analysis System, Useres Guide. Statistical. Version 9.1 th ed. SAS. Inst. Inc. Cary. N.C. USA, 2012.
14. Holt KE, Wertheim H, Zadoks RN, Baker S, Whitehouse CA, Dance D. et al. Genomic analysis of diversity, population structure, virulence, and antimicrobial resistance in *Klebsiella pneumoniae*, an urgent threat to public health. Proceedings of the National Academy of Sciences. 2015; 112(27): E3574-E3581.
15. Daschner FD. Combination of bacteriostatic and bactericidal drugs: lack of significant in vitro antagonism between penicillin, cephalothin,

- and rolitetracycline. *Antimicrobial Agents and Chemotherapy*. 1976; 10(5): 802-808.
16. Vardakas K Z, Athanassaki F, Pitiriga V, Falagas ME. Clinical relevance of in vitro synergistic activity of antibiotics for multidrug-resistant Gram-negative infections: A systematic review. *Journal of Global Antimicrobial Resistance*. 2019; 17: 250-259.
  17. Sader HS, Huynh HK, Jones RN. Contemporary in vitro synergy rates for aztreonam combined with newer fluoroquinolones and  $\beta$ -lactams tested against gram-negative bacilli. *Diagnostic Microbiology and Infectious Disease*. 2003; 47(3): 547-550.
  18. Song W, Woo HJ, Kim JS, Lee KM. In vitro activity of  $\beta$ -lactams in combination with other antimicrobial agents against resistant strains of *Pseudomonas aeruginosa*. *International Journal of Antimicrobial Agents*. 2003; 21(1): 8-12.
  19. Mayer I, Nagy E. Investigation of the synergic effects of aminoglycoside-fluoroquinolone and third-generation cephalosporin combinations against clinical isolates of *Pseudomonas* spp. *Journal of Antimicrobial Chemotherapy*. 1999; 43(5): 651-657.
  20. Fish DN, Choi MK, Jung R. Synergic activity of cephalosporins plus fluoroquinolones against *Pseudomonas aeruginosa* with resistance to one or both drugs. *Journal of Antimicrobial Chemotherapy*. 2002; 50(6): 1045-1049.
  21. Hannan A, Gondal AJ, Saleem S, Arshad MU, Lateef W. In-vitro efficacy of ceftazidime in combinations with meropenem, piperacillin/tazobactam, amikacin and ciprofloxacin against extensively drug resistant *Pseudomonas aeruginosa*. *Pakistan J Zool*. 2014; 46: 1111-1116.
  22. Watanabe T, Obayashi K, Matsui K, Kubota T. Comparative studies of the bactericidal morphological and post-antibiotic affects of arbekacin and vancomycin against methicillin-resistant *Staphylococcus aureus*. *Journal of Antimicrobial Chemotherapy*. 1997; 39: 471-6.
  23. Khomtchouk KM, Kouhi A, Santa Maria P. The Role of Neutrophils in *Pseudomonas aeruginosa* Chronic Suppurative Otitis Media. *J Immunol*. 2019; 202 (1 Supplement): 190.
  24. Verma A, Bhani D, Tomar V, Bachhiwal R, Yadav S. Differences in bacterial colonization and biofilm formation property of uropathogens between the two most commonly used indwelling urinary catheters. *Journal of Clinical and Diagnostic Research: JCDR*. 2016; 10(6): PC01 –PC3.
  25. Hamilos DL. Biofilm Formations in Pediatric Respiratory Tract Infection. *Current Infectious Disease Reports*. 2019; 21(2): 6.
  26. Torretta S, Drago L, Marchisio P, Ibba T, Pignataro L. Role of Biofilms in Children with Chronic Adenoiditis and Middle Ear Disease. *Journal of Clinical Medicine*. 2019; 8(5): 671.
  27. Moriyama S, Hotomi M, Shimada J, Billal DS, Fujihara K, Yamanaka N. Formation of biofilm by *Haemophilus influenzae* isolated from pediatric intractable otitis media. *Auris Nasus Larynx*. 2009; 36(5): 525-531.
  28. Rayner MG, Zhang Y, Gorry MC, Chen Y, Post JC, Ehrlich GD. Evidence of bacterial metabolic activity in culture-negative otitis media with effusion. *JAMA*. 1998; 279(4): 296-299.
  29. Abu Bakar MB, McKimm J, Haque M. Otitis media and biofilm: An overview. *Int J Nutr Pharmacol Neural Dis*. 2018; 8: 70-78.
  30. Thornton RB, Wiertsema SP, Kirkham LAS, Rigby PJ, Vijayasekaran S, Coates HL. Neutrophil Extracellular Traps and Bacterial Biofilms in Middle Ear Effusion of Children with Recurrent Acute Otitis Media, A Potential Treatment Target. *PLoS ONE*. 2013; 8(2): e53837.

# The Role of Religion and Spirituality in Alcohol Use Treatment and Recovery: An Integrative Review

Mohannad A. Aldiqs<sup>1</sup>, Ayman M. Hamdan-Mansour<sup>2</sup>

<sup>1</sup>Lecturer, Mental Health Nursing, Faculty of Nursing, Al-Ahliyya Amman University, Amman- Jordan 19328,

<sup>2</sup>Professor, Mental Health Nursing, School of Nursing, The University of Jordan Queen Rania Street, Amman 11942 Jordan

## Abstract

Despite the belief that religion and spirituality considered the most important cultural factors that give meaning to human behaviors and values, religion and spirituality have been equally ignored in the empirical alcohol studies. The purpose of this integrative review paper is to identify the role of religion and spirituality in alcohol use treatment and recovery. An integrative review has been utilized to address the issue. There is a presentation of findings from research examining religion and spirituality and their relationship to alcoholism. Treatment requires awareness of underlying causes to establish effective treatment approaches. Determining these underlying causes requires adequate knowledge of underlying personal beliefs and values that adheres to religions and spirituality. Health professionals across disciplines have an important role in implementing multidisciplinary interventions. Results, controversies, and concerns raised by the reported results are addressed. Implications for future research are delineated.

**Keywords:** Alcoholism; Belief System; Religion; Spirituality.

## Introduction

The past few decades witnessed a growing public interest in alcoholism and related method of treatment. Alcohol is a widely used substance throughout all ages, cultural, and ethnic groups<sup>[1]</sup>. It affects individuals, families, and societies' financial, psychological, and social functions<sup>[2]</sup>. This evokes attention towards understanding the socio-cultural factors that contribute to alcohol use and its related treatment approaches. Amongst, is religion and spirituality that forms a significant component of any given culture.

Despite the belief that religion and spirituality considered the most important cultural factors that give meaning to human behaviors and values<sup>[3]</sup>, religion and spirituality have been equally ignored in the empirical alcohol studies<sup>[4]</sup>. The researchers mostly include all questions related to religion and spirituality combined as one factor<sup>[5]</sup>. The use of alcohol and other drugs is clearly proscribed in some cultural and religious groups and commended in others. Larson and Larson<sup>[5]</sup> maintained in their review that researchers tend to assess religious affiliation as a measure to religion. This kind of neglect

of religion and spirituality was also observed in medical studies. Mueller and his colleagues<sup>[6]</sup> related that to the researchers' tendencies to use the biomedical model in which physical evidence is paramount. Addressing religion and spirituality as one factor is a questionable issue giving that in many cultures, religion and spirituality are not indicating the same meaning although some common components may exist. The connection between religion, spirituality, and alcohol use required further investigation as alcohol treatment programs depend largely on psychosocial modalities that use the individuals cultural, religious, and spiritual background as major components. Furthermore, mental and medical practitioners are aware of the legal aspects of substance use and treatment; however, recognizing religion and spirituality as core components allows adopting effective approaches to treatment. The *purpose* of this integrative review is to identify the role of religion and spirituality in alcohol use treatment and recovery. The discussion will include a review of studies and treatment approaches that support the efficiency of using the spiritual and religious dimensions in alcohol recovery. Besides, the interrelationship among alcoholism, religion, and

spirituality is also discussed. The paper will emphasize the role of religion and spirituality as an essential and commended approach to deal with the alcohol problem at the individual and society level.

### Method

**Data Source:** The article search was conducted by the first author. EB identified articles by scanning and reviewing all existing literature reviews of Religion, Spirituality, and Alcoholism. Reference lists of these articles were further reviewed for relevant studies. Then literature searches were conducted between January 2010 to Jun 2020 using the online databases: Medline/Pubmed, PsycINFO, Google Scholar, British Nursing Index, Pro-Quest, Elsevier, EBSCOhost, and Cumulative Index to Nursing and Allied Health Literature (CINAHL) Plus using the following search keywords: Alcoholism; Belief System; Religion and Spirituality. Only peer-reviewed papers published in Arabic and English were considered; no geographical limits were used.

Medical subject headings (MeSH) descriptors or appropriate permutations were used to index the content of the databases. The Boolean operators “AND” and “OR” were used as connectors to combine the various search terms and help narrow down the search. Using “AND” ensures that articles with both search terms are retrieved whereas using “OR” ensures the retrieval of articles with either of the search terms. With the aid of these Boolean operators, the search terms were combined as follows: Alcoholism AND Religion OR Spirituality OR Belief System; Alcoholism AND Belief System OR Religion OR Spirituality; and Alcoholism AND Belief System OR Religion OR Spirituality (Table 1).

**Table 1. Boolean table showing keywords used for research.**

<b>List of search terms:</b>
Alcoholism AND Spirituality OR Religion
Alcoholism AND Spirituality OR Belief System

**Inclusion and Exclusion Criteria:** The inclusion criteria included articles published in the English language, research studies specifically related to Religion, Spirituality, Alcoholism, and relevant publications regardless of the study design. The inclusion criteria also included articles published from the year 2010 to 2020 to ensure that only current evidence is explored. The exclusion criteria included studies that were not relevant

to Religion, Spirituality, Alcoholism, studies published in languages other than English and Arabic, and studies with publications older than 2010.

**Religion and Spirituality:** The word religion is taken from the Latin word *religare* which means “to bind together” [7]. Religion reflects a set of beliefs and practices that are agreed upon by specific groups of people. The degree to which an individual devote or the quality of being religious refers to religiosity or religious involvement[7]. Spirituality is taken from the word *spiritualitas* which means “breath”[7]. Spirituality can be defined as “*a broad concept that encompasses values, meaning and purposes; one turn inward to the human traits of honesty, love wisdom, caring, imagination, compassion, existence of quality of a higher authority, guiding spirit or transcendence that is mystical; a lowing, dynamic balance that allows and creates healing of body-mind spirit; and may or may not involve organized religion*” [8] p24. Three characteristics of spirituality as posited by Margaret Burkhardt [9] are unfolding mystery, harmonious inter connectedness, and inner strength. Some researchers use the term spiritual wellbeing to refer to spirituality. But these two terms are different. Spiritual wellbeing refers to “*the affirmation of life in relationship with God, self, community, and environment that nurtures and celebrates wholeness*”[10]. Spiritual well-being is first emerged by David O. Moberg in 1971 where he defined it as “*wellness or health of the totality of the inner resources of people, the ultimate concerns around which all other values are focused, the central philosophy of life that guide the conduct, the meaning-giving center of human life which influences all individual and social behavior*”[11, p2). Carson[12] maintained that spiritual wellbeing is not a state but rather an indication of the presence of spiritual health in the person. The features of spirituality include connectedness with others and divine, transcendence (the human is more than simple materials), and values as love and justice[13]. Despite of the growing interest in different professional disciplines to study the impact of spirituality on various aspects of individuals’ health, researchers were not able to present a measurable definition of spirituality; Therefore, researchers used to measure religiosity to address spirituality[14]. However, religion and spirituality do not refer to the same things. Canda [15], who has developed a concept of spirituality for social work, maintained that religion involves modeling of the individual’s spiritual practices and beliefs into a social institution. Religion is at the level of individual

and has boundaries of specific beliefs, practices, and forms of governance and rituals<sup>[16]</sup>.

**The Interrelationship between religion and alcoholism:** Most clinical studies and population surveys noted that religiosity and alcohol use are inversely related (e.g.,<sup>[17]; [18]</sup>). Chang-Lin and his colleagues<sup>[19]</sup> found that religiously exhibited lower use and initiation of alcohol. In a recent study, the investigators found that religiously-involved students are less likely to abuse alcohol than their nonreligious colleagues<sup>[20]</sup>. Even in maintaining abstinence, religious individuals show more significant results in terms of longer abstinence periods<sup>[21]</sup>.

A systematic review showed that there is an inverse relationship between attitudes toward alcohol drinking and religiosity<sup>[22]</sup>. Religion was negatively associated with using alcohol among adolescents sample<sup>[23]</sup>. These studies show some significant and supportive results toward the effective use of religious beliefs and practices in alcohol sober and abstinence. We need to have these studies replicated in various cultural and religious groups. Despite of the valid results of an existing inverse relationship between alcohol use and religiosity, it very difficult to develop a causal relationship<sup>[6]</sup>.

**Spirituality and Alcoholism:** The issues of measuring spirituality become one of the main concerns for the workers in the sociocultural and psychosocial disciplines. Therefore, drug and alcohol abuse is considered a symptom of wounded spirituality<sup>[24]</sup>. This view is not what Royce<sup>[25]</sup> went for when he called addiction, to alcohol and any other drug, as a spiritual disease. Royce<sup>[25]</sup> maintained that addiction is simply not functioning with ease regarding the drug. He relied mainly on his understanding of the word disease. He pointed out that “disease” is a “lack of ease”; therefore, alcohol works as a disease by impairing the ability of the body to think and feel right about God. The alcoholics and addict resort to drugs and alcohol in an attempt to void and overcome that spiritual emptiness, spirituality is protective factors and function as mechanisms against relapse<sup>[26]</sup>. Hence, the AA’s has a strong belief that addiction, including alcoholism, is a spiritual disease. Researchers<sup>[27]</sup> presented an interesting idea that relates alcoholism and addiction to spirituality by maintaining that spirituality is the functions of the right hemisphere in which it is the part of the brain that most of the addiction drugs make their effects. Therefore, when the defect in spirituality happiness, such as a feeling of spiritual

emptiness, the addicts use alcohol and other drugs for the pharmacological benefits of the drugs in the right hemisphere, where the spiritual process takes place.

**Religion, Spirituality and Health:** The last few decades witnessed an increased interest in the role of an individual’s belief system and spirituality in maintaining and promoting individuals’ health. Health practices, in general, and medicine specifically has been historically linked to religion, and religious people were always the resort for individuals’ health problems. By time medicine, followed by other health care professions split themselves from religion. In the present time, health professionals are encouraged to consider the spiritual assessment and spiritual care in their process of care of individuals and families<sup>[1]</sup>. This reflects the importance to deal with the individual as a whole not only from a disease model perspective. Mueller and his colleagues<sup>[6]</sup> in their review found that patient care was well enhanced by employing and enforcing the patient’s spirituality. They indicated that spirituality enhanced patient coping, and quality of life and patients valued their spiritual wellness equal to their physical well-being.

The association between high spirituality and religiosity with physical and psychosocial well-being has been strongly recommended in the literature. Higher levels of spirituality and religion have been found to be negatively associated with rates of alcohol and drug use, suicide, and depression<sup>[28]</sup>. Spirituality found to associate with an individual’s health through reduced loneliness<sup>[29]</sup>. Further, religious practices are inversely related to the severity of symptoms and hospital use and enhance life satisfaction among psychiatric inpatients<sup>[30]</sup>. This indicated why many people turned to alternative medicine is because it corresponds with their beliefs, values, and philosophical orientation, and because of dissatisfaction with conventional medicine<sup>[31]</sup>. However, religion has been reported with some negative consequences on the individual’s health behaviors and practices such as obesity<sup>[32]</sup>, obsessive behaviors<sup>[33]</sup>, and adherence to medical regimens<sup>[34]</sup>. While some of these beliefs may not be accepted by the health care providers and other allied professionals, ethicists suggest that these beliefs must be respected<sup>[35]</sup>.

Therefore, spiritual assessment and exploring religious beliefs have to be part of the patient’s holistic management and a core part of the first visit<sup>[36]</sup>. That includes fears, wishes, values, hopes, and the way they perceived disease and illness<sup>([37]; [38])</sup>. The person should

not be seen as an object, rather as a biological, spiritual, physical, and social human being. These considerations should not be limited to patients who attend hospitals and clinics suffering from psychotic-related illness, as found by Hilton and his colleagues [39], but also for all patients. One way to accomplish that is by learning the significance of spiritual assessment outcomes in the process of caring and decisions related to the selection of treatment approaches.

**Role of Religion and Spirituality in Alcohol Recovery:** The worker and professionals who deal with addiction problems are no more ignoring the role of the spiritual dimension in recovery from alcoholism and addiction. Literature has provided a significant association between alcohol recovery and spiritual awakening (e.g., [40]). Among the dominant treatment initiatives of alcoholism is Alcoholics Anonymous (AA) [41]. In the AA, the individual develops “humanity, inner strength, a sense of meaning and purpose, acceptance, tolerance, and harmony in one’s life” ([42], p 209). These entire elements considered to be important components in the individual’s spirituality. Therefore, the basic of AA is spiritual growth by practicing certain spiritual principles and traditions [43]. The AA does not provide the definite cure of alcoholism; rather, relieving the alcoholic through practicing the twelve steps and twelve traditions that guide the spiritual growth. Alcoholics Anonymous is not the only alcohol recovery program that is spiritually-related. There are Al-Anon and Alateen, Rational Recovery, SMART Recovery, secular organization for sobriety, men for sobriety, and women for sobriety. All these groups have common agreement on rejecting the disease model of alcoholism, recognize the diversity in treatment, and spirituality is a key element in the recovery [42].

Drinking outcome after treatment is not related to the extent to which the individual attends the AA [44-46]; however, the involvement in AA has been significantly related correlated with drinking outcomes. While studies supported the effect of the spiritual dimension and using meditation on the health outcomes among alcohol and drug addicts (e.g., [47]) the controlled studies revealed a non-significant effect of using meditation on alcohol consumption [48]. One of the major supportive results that related the use of spirituality in alcohol recovery is reported by the project MATCH, where individuals who have AA involvement and spiritual/religious involvement groups have better outcomes on the abstinence measures compared with others in the cognitive/behavioral skills

group and motivational enhancement group. Although spiritual/religious involvement may be an important protective factor against alcohol/drug abuse, and Individuals currently suffering from these problems are found to have a low level of religious involvement and spirituality [49-50], the spiritual-focused intervention is still a debated issue and not well-proven due to the limited empirical evidence [16].

**Implication and research issues:** The reviewed studies on alcoholism and its relationship to religion and spirituality acknowledge the role of religious/spiritual affiliation as a protective factor against alcohol use and abuse. Although some studies revealed a positive relationship between the religious/spiritual involvement and recovery from alcohol; however, the limited empirical evidence limits the ability to establish a predictive relationship. Nevertheless, the roles of religion and spiritual beliefs have been strongly addressed as one major components for alcohol recovery and sobriety. This is dependent upon personal rather than selected model of treatment. Therefore, mental and addiction health practitioners need to assess and investigate sources of internal power and strengths of individuals with alcohol use problems. legal aspects of alcohol use although considered significant factors, the medical and mental health practitioners need to develop their intervention using the power of personal belief and accommodate their plans to cultural factors. This reflects the importance of including the spiritual dimension as an essential part of the process of caring.

The evidence of religious and spiritual practices in protecting against addiction logically implies that these practices can be used effectively in the process of recovery. This require psychiatric and addiction practitioners to gain more understanding of the spirituality and religious affiliation of individuals with alcohol use problems and disorders. Further, the health care providers are urged to include the outcomes of spiritual assessment planning and interventional processes. The researchers need to investigate more the relationship between alcohol recovery and spiritual/religious involvement and include the spiritual variables in the treatment studies. Recognizing that the main barrier to research is lack of interest of researchers in studying religious and spiritual concepts, there is a need to integrate these concepts while addressing alcohol use recovery and treatment research and interventions. The mental health professionals probably lack the appropriate knowledge to use tools and method of measuring religiously and spiritual



beliefs inferring the need to have the researchers and mental health and addictions specialists to communicate and cooperate to improve the excellence of the produced studies in the field of alcoholism.

There is a need to deal with the individual as a whole system and applying the holistic approach of care including the biological, social, psychological, physical, and spiritual processes. Religion has been linked to medicine and health, why not to regain this relationship, and present it in a scientific way. It's time to build the holistic model of health care that recognizes individuals' spirituality and religious affiliation.

### Conclusion

There has been growing interest in studying the relationship between alcoholism and spiritual/religious involvement. Studies have acknowledged the role of an individual's spirituality and religious beliefs in physical and psychosocial well-being and alcohol recovery. This paper presented a discussion of the relationship between spirituality and religiosity and alcoholism. The paper presented a discussion that shows the significant role of spiritual/religious involvement as a protective factor against alcohol use problems and disorder as a supportive element in the process of recovery. Controversial findings related to the nature of this relationship also presented. Further, the paper delineated how individuals' spirituality and religiosity may differ and how can they be linked. Implications and research concerns with suggestions presented and discussed for implementation in the research, education, and clinical settings.

**Conflict of Interest:** the authors declare no conflict of interest related to publication of this article.

**Financial Disclosure:** There is no financial disclosure.

**Ethical Clearance:** the study has been approved by the ethics and research committee at the university of Jordan.

### References

1. American Psychiatric Association. Diagnostic and statistical manual of mental disorders (DSM-5). American Psychiatric Pub; 2013 May 22.
2. Sacks JJ, Gonzales KR, Bouchery EE, Tomedi LE, Brewer RD. 2010 National and State Costs of Excessive Alcohol Consumptionexternal icon. *Am J Prev Med* 2015; 49(5): e73–e79.
3. Hamdan-Mansour AM, Al-Sagarat AY, Shehadeh JH, Al Thawabieh SS. Determinants of substance use among high school students in Jordan. *Current Drug Research Reviews*. 2020 May 25.
4. Al Abaiat D, Hamdan-Mansour A, Hanouneh S, Ghannam B. Psychosocial predictors of relapse among alcohol dependents in Jordan. *Current Drug Abuse Reviews*. 2016; 9, 1, 19-25.
5. Gove PB. *New International Dictionary*. Springfield, MA: Merriam-Webster Inc. 1986.
6. Hamdan-Mansour AH, Shehadeh JH, Mansour LA. Using cognitive behavioral intervention to prevent substance use among university students: comparative study. *Mental Health and Social Inclusion*. 2020 Jul 1. doi.org/10.1108/MHSI-04-2020-0021
7. Hamdan-Mansour AM, Malkawi AO, Sato T, Hamaideh SH, Hanouneh SI. Men's perceptions of and participation in family planning in Aqaba and Ma'an governorates, Jordan. *EMHJ-Eastern Mediterranean Health Journal*. 2016;22(2):124-32.
8. Hamdan-Mansour A, Nawafeh D, Hanouneh S, Al Omari H. Psychosocial aspects of patients diagnosed with Diabetes mellitus type-II in Jordan. *International Journal of Diabetes in the Developing Countries*. 2015; 36:65-9.
9. Xiao H, Yoon JY, Bowers B. Quality of life of nursing home residents in China: a mediation analysis. *Nursing & health sciences*. 2017 Jun;19(2):149-56.
10. Moberg DO. The development of social indicators for quality of life research. *Sociological Analysis*. 1979 Mar 1;40(1):11-26.
11. Hamdan-Mansour AM, Mahmoud KF, Al Shibi AN, Arabiat DH. Impulsivity and sensation-seeking personality traits as predictors of substance use among university students. *Journal of Psychosocial Nursing and Mental Health Services*. 2017 Sep 12;56(1):57-63.
12. Hamdan-Mansour AM, Dardas LA, Nawafleh H, Abu-Asba MH. Psychosocial predictors of anger among university students. *Children and Youth Services Review*. 2012 Feb 1;34(2):474-9.
13. Ghaderi A, Tabatabaei SM, Nedjat S, Javadi M, Larijani B. Explanatory definition of the concept of spiritual health: a qualitative study in Iran. *Journal*

- of medical ethics and history of medicine. 2018;11.
14. Mmaryan N, Rassouli M, Mehrabi M. Spirituality concept by health professionals in Iran: A qualitative study. *Evidence-Based Complementary and Alternative Medicine*. 2016 Jan 1;2016.
  15. Kendler KS, Gardner CO, Prescott CA. Religion, psychopathology, and substance use and abuse: A multimeasure, genetic-epidemiologic study. *The American journal of psychiatry*. 1997 Mar.
  16. Alsyouf WS, Hamdan-Mansour AM, Hamaideh SH, Alnadi KM. Nurses' and patients' perceptions of the quality of psychiatric nursing care in Jordan. *Research and theory for nursing practice*. 2018 Jun 1;32(2):226-38.
  17. Hamdan-Mansour AM, Al-Sagarat AY, AL-Sarayreh F, Nawafleh H, Arabiat DH. Prevalence and correlates of substance use among psychiatric inpatients. *Perspectives in Psychiatric Care*. 2018 Apr;54(2):149-55.
  18. Ghannam B, Hamdan-Mansour A, Al Abaiat D. Psychosocial predictors of burden among caregivers of patients with serious mental illness in Jordan. *Perspectives in Psychiatric Care*. 2017;53(4):299-306.
  19. Lin HC, Hu YH, Barry AE, Russell A. Assessing the associations between religiosity and alcohol use stages in a representative US sample. *Substance Use & Misuse*. 2020 May 2;1-7.
  20. Tomkins MM, Neighbors C, Park CL. Expressing discrepancies between religious affiliations and drinking reduces drinking intentions. *Psychology of Religion and Spirituality*. 2020 Feb;12(1):124.
  21. Almadi T, Cathers I, Hamdan Mansour AM, Chow CM. The association between work stress and inflammatory biomarkers in Jordanian male workers. *Psychophysiology*. 2012 Feb;49(2):172-7.
  22. Luecha T, Peremans L, Dilles T, Poontawee P, Van Rompaey B. The prevalence of and factors related to alcohol consumption among young people in Thailand: a systematic review of observational studies. *Drugs: Education, Prevention and Policy*. 2020 Feb 22:1-22.
  23. Stauner N, Exline JJ, Kusina JR, Pargament KI. Religious and spiritual struggles, religiousness, and alcohol problems among undergraduates. *Journal of Prevention & Intervention in the Community*. 2019 Jul 3;47(3):243-58.
  24. Nikfarjam M, Solati K, Heidari-Soureshjani S, Nourmohammadi M, Kazemi SY, Jafari A, Omidi M. The effect of group religious intervention on spiritual health and symptom reduction in patients with depression. *Journal of Shahrekord University of Medical Sciences*. 2019 Feb 9.
  25. Shehadeh J, Hamdan-Mansour AM, Halasa SN, Hani MH, Nabolsi MM, Thultheen I, Nassar OS. Academic stress and self-efficacy as predictors of academic satisfaction among nursing students. *The Open Nursing Journal*. 2020 Jun 18;14(1).
  26. Shafie AA, Jailani MR, Elias NF, Miskam NA, Mahyuddin MK. The effectiveness of a guided repentance module: a qualitative analysis of psycho spiritual and drug-related locus of control. *International Journal of Academic Research in Business and Social Sciences*. 2019 Jun;9(6).
  27. Hamdan-Mansour AM, Mahmoud KF, Al Shibi AN, Arabiat DH. Impulsivity and sensation-seeking personality traits as predictors of substance use among university students. *Journal of Psychosocial Nursing and Mental Health Services*. 2017 Sep 12;56(1):57-63.
  28. de Rezende-Pinto A, Schumann CS, Moreira-Almeida A. Spirituality, religiousness and mental health: Scientific evidence. In *Spirituality, Religiousness and Health 2019* (pp. 69-86). Springer, Cham.
  29. Gallegos ML, Segrin C. Exploring the mediating role of loneliness in the relationship between spirituality and health: Implications for the Latino health paradox. *Psychology of Religion and Spirituality*. 2019 Aug;11(3):308.
  30. Hamdan-Mansour AM, Constantino RE, Farrell M, Doswell W, Gallagher ME, Safadi R, Shishani KR, Banimustafa R. Evaluating the mental health of Jordanian women in relationships with intimate partner abuse. *Issues in Mental Health Nursing*. 2011 Sep 23;32(10):614-23.
  31. Hamdan-Mansour AM, Al-Gamal E, Puskar K, Yacoub M, Marini A. Mental health nursing in Jordan: An investigation into experience, work stress and organizational support. *International Journal of Mental Health Nursing*. 2011 Apr;20(2):86-94.
  32. Banimustafa RA, Mansour AM, Arabiat DH. Empowerment and psychological wellbeing of women in the southern region of Jordan: in the context utilization of reproductive health care

- services. *The Arab Journal of Psychiatry*. 2011 Nov;44(2313):1-8.
33. Hamdan-Mansour AM, Arabiat DH, Sato T, Obaid B, Imoto A. Marital abuse and psychological well-being among women in the southern region of Jordan. *Journal of Transcultural Nursing*. 2011 Jul;22(3):265-73.
  34. Movahedizadeh M, Sheikhi MR, Shahsavari S, Chen H. The association between religious belief and drug adherence mediated by religious coping in patients with mental disorders. *Social Health and Behavior*. 2019 Jul 1;2(3):77.
  35. Griffin SJ. The ethical accommodation of patients' religious beliefs in healthcare: a care respect framework prompted by examples from modern Paganism (Doctoral dissertation, Keele University).
  36. Abdulla A, Hossain M, Barla C. Toward comprehensive medicine: listening to spiritual and religious needs of patients. *Gerontology and Geriatric Medicine*. 2019 Apr; 5:2333721419843703.
  37. Al Ja'afreh S, Hamdan- Mansour A, Alabeiat D. Predictors of attitudes toward substance use among university students in Jordan. *Psychology and Education*. 2020; July 57(5): 331-335.
  38. McSherry W, Ross L, Balhith K, Ross N, Young S. Spiritual assessment in healthcare: an overview of comprehensive, sensitive approaches to spiritual assessment for use within the interdisciplinary healthcare team. In *Spirituality in Healthcare: Perspectives for Innovative Practice 2019* (pp. 39-54). Springer, Cham.
  39. Ghaznavi F, Zuberi T. Religious beliefs and practices in acute mental health patients. *Nursing Standard* (through 2013). 2002 Jun 5;16(38):33.
  40. Hamdan-Mansour AM, Abdel Razeq NM, AbdulHaq B, Arabiat D, Khalil AA. Displaced Syrian children's reported physical and mental wellbeing. *Child and Adolescent Mental Health*. 2017 Nov;22(4):186-93.
  41. Vandivier AM. The Growth of Spiritual Awareness through AA Participation: A phenomenological study. *Alcoholism Treatment Quarterly*. 2020 Jan 2;38(1):32-49.
  42. Carroll S. Spirituality and purpose in life in alcoholism recovery. *Journal of studies on alcohol*. 1993 May;54(3):297-301.
  43. Marmash LR, Hamdan-Mansour AM, Elian RN RM, Hiarat SY. Differences in perception between nurses and patients in Jordanian nurses' effectiveness in practicing communication skills. *Jordan Medical Journal*. 2012 Apr;171(785):1-21.
  44. Mahadeen A, Othman A, Hamdan-Mansour A, Sato T, Imoto A. Knowledge and practices towards reproductive health among rural women in the southern region of Jordan. *East Mediterr Health J*. 2012;18(6):567-72.
  45. Aldiqs MA, Mansour A. Relationship of neurocognitive function with psychological well-being and activities of daily living among patients diagnosed with schizophrenia in Jordan. *Journal of Nursing and Health Sciences*. 2018 Jun;4(2):34.
  46. Almadi T, Cathers I, Mansour AM, Chow CM. An Arabic version of the Perceived Stress Scale: Translation and validation study. *International journal of nursing studies*. 2012 Jan 1;49(1):84-9.
  47. M Hamdan Mansour A, H Shehadeh J, Puskar K, El-Hneiti M, M Haourani E. Investigating physical, psychological and social well-being of older persons in Jordan. *Current Aging Science*. 2017 Aug 1;10(3):217-23.
  48. Murphy TJ, Pagano RR, Marlatt GA. Lifestyle modification with heavy alcohol drinkers: Effects of aerobic exercise and meditation. *Addictive behaviors*. 1986 Jan 1;11(2):175-86.
  49. Atallah MA, Hamdan-Mansour AM, Al-Sayed MM, Aboshaiqah AE. Patients' satisfaction with the quality of nursing care provided: The Saudi experience. *International Journal of Nursing Practice*. 2013 Dec;19(6):584-90.
  50. Breslow RA, Dong C, White A. Prevalence of alcohol-interactive prescription medication use among current drinkers: United States, 1999 to 2010. *Alcoholism: Clinical and Experimental Research*. 2015 Feb;39(2):371-9.

# Quality of Life After Bariatric Surgery

**Moly K.T.**

*Professor cum Principal, Amrita College of Nursing, Amrita Institute of Medical Sciences, AMRITA Vishwa Vidyapeetham, Kochi, Kerala, India. PIN: 682041*

## Abstract

Bariatric surgery improves patients' well-being beyond significant weight loss and resolution of comorbidities, Quality of Life (QoL) is a relevant but challenging variable to assess in the process of weight loss and lifestyle changes. The primary objective of the study was to determine the QoL of patients after bariatric surgery in comparison with obese patients who have not undergone bariatric surgery. A descriptive analytical approach was used to collect data from 100 subjects who had undergone Laparoscopic Sleeve Gastrectomy (LSG) through SF 36 in comparison with 100 obese subjects without surgery. 50% data collection was done directly from OPD and 50% from telephonic contact in both the groups. The mean scores in all the eight dimensions of SF 36 were found to be good in Bariatric Surgery (BS) group. Both Physical Component Score (PCS) and Mental Component Score (MCS) were found to be high, the MCS being higher (85.74 + 22.72) than the PCS (83.68 + 21.8) in BS group whereas the MCS was poor in obese group (49.98 + 11.84). The overall QoL of BS group was found to be good (mean 80.93 + 18.18) compared to obese group (49.69 + 11.77). The health related QoL was found to be quite good in patients after LSG than those without surgery. The study concludes that the health related quality of life is better in obese patients after LSG than those without surgery. The study also strongly recommends the conduct of long term longitudinal qualitative studies with multiple points of measurements and follow-ups to be extended to the community.

**Keywords:** *Quality of Life, Laparoscopic Sleeve Gastrectomy, Physical Component Score, Mental Component Score, Obesity.*

## Introduction

LSG has gained grounds worldwide as the popular bariatric surgical procedure including Asia. Sleeve gastrectomy has been found to improve Quality of Life (QoL) and allows reduction of comorbidities.<sup>1,2,3</sup> Beyond significant weight loss, the objective of bariatric surgery is to improve patients' postoperative well-being. QoL is recognized as a relevant variable to consider in the weight loss process and psychologic monitoring of patients.

It has to be remembered that almost all the patients who had undergone obesity surgery, were not successful in following or maintaining a prescribed diet in the past. Adherence to the dietary restrictions and altered lifestyle necessary after LSG requires continuous monitoring and support from relatives and caregivers.<sup>4</sup>

The importance of optimizing patients' monitoring, notably around 15 to 18 months after bariatric surgery (the first "critical" period of weight regain) especially for men and diminished self-perceived QoL especially for women has been highlighted in literature.<sup>5</sup>

QoL is a multidimensional construct. When applied to obesity, it includes not only health-related and weight-related QoL, but also the psychosocial burden. These relationships stress the necessity of its assessment.<sup>6</sup> But less is known about its psychosocial impact. Depressive disorders are the most common psychological diagnoses (ranging from 4.4% to 53%), followed by anxiety disorder.<sup>7,8</sup> In a study on Quality of Life and Depression

---

### Corresponding Author:

**Moly K.T.**

Professor cum Principal, Amrita College of Nursing,  
Amrita Institute of Medical Sciences, AMRITA Vishwa  
Vidyapeetham, Kochi, Kerala, India. PIN: 682041

Ph: No. +91 94475 13383

e-mail: ktmoly59@gmail.com

in obese conducted among 220 patients attending various OPDs of a tertiary care hospital, the QoL in mental components (49.43+/-13.68) was found to be poor than the physical component (54.4+/-20.09).<sup>9</sup>

The long term complications after bariatric surgery cannot be neglected. The chronic complications include stricture (3.5%), nutritional deficiencies, Vit. B<sub>12</sub>, Vit. D, folate, iron & zinc deficiency (3%, 23%, 3%, 3% & 14% respectively) and gastroesophageal reflux disease [GERD] (47%).<sup>10</sup>

Although there seems to be adequate post surgical physical care following BS there appears to be a lack of postsurgical psychosocial follow up and support for these patients.<sup>11</sup> The psychological distress and the vulnerability in social situations while adjusting to the new rapidly changing body image after LSG needs attention.

Massive weight loss often leaves the patient with large quantities of flabby skin that can result in problems related to altered body image. Additional surgeries may be required to handle the excess skin which may cause confusion about the impact of bariatric surgery.

Most of the studies conducted in India were to compare the effect of different types of bariatric surgical procedures in terms of weight loss and resolution of comorbidities. Studies in India on QoL after LSG were found to be less. Also it is interesting to note that women account for 80% of those having BS, although the reasons are poorly understood.<sup>12</sup>

Successful QoL after bariatric surgery depends on proper selection of patients and a thorough pre operative preparation by a multidisciplinary health care team. The nurses' role in making the patient and family members clear about the real expectations as well as their own responsibilities in the diet and life style on a long term basis is to be understood.

The purpose of the study was to explore the health related QoL in patients after bariatric surgery (Laparoscopic Sleeve Gastrectomy) in comparison with obese patients without surgery so as to provide the right perception of the surgical outcome to the candidates for bariatric surgery as well as the health care team along with an awareness of each one's responsibilities towards attaining the best possible QoL.

The primary objective of the study was to determine

the QoL of patients after bariatric surgery in comparison with obese patients who have not undergone bariatric surgery. Accordingly, the null hypothesis tested was "There will be no significant difference between the mean Quality of Life score of obese patients after bariatric surgery (BS group) and obese patients who did not undergo bariatric surgery (Obese group/Control group)"

## Materials and Method

In view of the nature of problems selected for the study and objectives, a descriptive analytical approach was used. The study sample included 100 subjects who had undergone bariatric surgery six months before and 100 obese subjects without surgery at the same time meeting the selection criteria for bariatric surgery as per ASMBS 2012. As subjects after bariatric surgery rarely need to come to OPD after six months, 50% data collection was done from GI Surgery OPD and 50% from telephonic contact. Data collection from obese patients was also done in the same way ie, 50% from OPDs (Medicine, Endocrinology OPDs and Obesity Clinic) and 50% through telephonic contact. Data collection took around one year. QoL was assessed through RAND SF 36 Item Health Survey 1.0.<sup>13</sup> The item-and scale-level statistical analyses supported the validity and reliability of SF-36 for use in India.<sup>14</sup>

## Results

**Sample Characteristics:** The group of patients after bariatric surgery was referred as 'BS group' and obese patients who have not undergone surgery were referred as 'Obese group' for easy understanding. The study subjects in BS group were comparatively of younger age than the obese group. (76% in BS group belonged to the age group 31-55 years whereas in obese group it was only 65%) Majority of the subjects in both the groups were females (BS group – 61% and obese group - 73%). The BS group was more educated than the obese group (58% of subjects in BS groups were graduates or post graduates whereas it was only 28% in obese).

Nearly half of study subjects in BS group (46%) changed to the category of overweight after surgery. However, 4% in BS group were still in class 3 obesity, 14% in class 2 obesity and 36% in class 1 obesity category. The mean weight before surgery 115.99 + 22.97 was reduced to a mean of 84.02 + 17.75 after surgery. The mean percentage of EWL was 63.31 + 26.20. The mean weight of BS group was 84.02 + 17.75 at the time of

study while the mean weight of obese group was 91.71 + 13.68 with a BMI 42.47 + 6.03 obesity Vs 38.72 + 3.48 (F value significant at 0.001).

Quality of Life in patients after bariatric surgery and in obese patients who have not undergone bariatric surgery.

**Table 1: Distribution of subjects based on mean QoL in eight dimensions N=200**

Dimensions	BS (n=100)				OBESE (n=100)			
	Min.	Max.	Mean	SD	Min.	Max.	Mean	SD
Physical functioning (PF)	15	100	86.95	23.41	0	95	52.5	22.78
Role limitations due to physical health (RPF)	0	100	86.25	33.59	0	100	47.75	24.89
Role limitation due to emotional problems (REF)	0	100	88.67	30.05	0	100	41.33	31.11
Energy fatigue (E)	0	100	83.55	23.6	15	85	52.45	13.64
Emotional well being(EW)	0	100	85	23.41	28	88	53.2	11.96
Social functioning (SF)	0	100	83.88	30.01	13	100	55.5	17.13
Pain(P)	0	100	77.85	28.27	10	100	60.75	24.2
General Health (GH)	20	80	53.9	8.95	0	65	38.2	12.46

Of the eight dimensions of QoL assessed, the mean scores in all the dimensions were found to be good in BS group with the highest score in Role Limitations due to Emotional Problems ie, REF (88.67 + 30.05), followed by Physical Functioning ie, PF and Role Limitations due to Physical Health ie, RPF (86.95 + 23.41, 86.25 + 33.59

respectively) and the lowest in General Health ie, GH (53.90 + 8.95). On the other hand, the dimension GH was found to be very poor in obese group (38.2 + 12.46) followed by REF with a score of 41.33 + 31.11 and RPF 47.75 + 24.89. The other dimensions showed only a slightly above average score.

**Table 2: Distribution of subjects based on the physical and mental component mean scores of QoL N=200**

Component	BS (n=100)				OBESE(n=100)			
	Min.	Max.	Mean	SD	Min.	Max.	Mean	SD
Physical component score (PCS)	5	100	83.68	21.8	3	84	52.34	18.95
Mental component score (MCS)	0	100	85.74	22.72	25	83	49.98	11.84

Both PCS and MCS were found to be high in BS group. The mental component score was higher (85.74 + 22.72) than the physical component score (83.68 + 21.8) in BS group whereas the mental component score was poor in obese group (49.98 + 11.84) than the physical component score (52.34 + 18.95).

**Table 3 Mean and Standard deviation of the overall QoL in BS group and obese group N=200**

QoL	Minimum	Maximum	Mean	SD
QoL BS group	22	94	80.93	18.18
QoL Obese group	15	77	49.69	11.77

The overall quality of life of BS group was found to be good (mean 80.93 + 18.18) whereas it was poor in obese group (49.69 + 11.77).

**Table 4: Distribution of the subjects based on their present general health compared to Oneyear ago.**  
N = 200

	BS group (n=100)		Obese group (n=100)	
	f	%	f	%
Much better	62	62	6	6
Somewhat better	15	15	25	25
Same	8	8	25	25
Somewhat worse	8	8	42	42
Much worse	7	7	2	2

Majority (62%) in the BS group perceived their present general health much better compared to one year ago while only 6% of the obese group perceived it so. The rest 42% in the obese group perceived their general health as somewhat worse than one year ago and for 25%, it was status quo.

Since the p-value obtained by the K-S test was less than 0.05 significance level in all the dimensions or components, the two groups were considered as heterogeneous. Hence Mann - Whitney U test was used to compare the mean scores of both the groups. It showed a highly significant statistical difference between the BS group and obese group in their Mean QoL (over all, dimension wise and component wise). Hence the null hypothesis was rejected.

Of the six socio-demographic variables (age, gender, marital status, education, occupation and type of work), statistically significant association was found between age, education, occupation and QoL (p value < 0.05). A highly significant statistical association was found between duration after surgery and QoL in the BS group. 86% of the subjects studied were between 6 months to 5 years after LSG. Of, these 94.18% had good QoL. However, QoL was good only in nine out of fourteen subjects who had undergone bariatric surgery five years before.

## Discussion

LSG is the recent bariatric surgery performed to reduce excess weight and improve QoL in morbidly obese. Though studies have shown that QoL can improve as soon as three months after bariatric surgery, the present study included only subjects who underwent LSG from six months to six years under the assumption that patients may have surgery related discomforts that may interfere in their QoL within six months.<sup>15</sup>

The mean scores of QoL (dimension wise, physical and mental components and overall) were found to be good in BS group than the obese group. Similar findings were observed in studies conducted mostly abroad. Substantial and significant improvement in physical and mental health favouring the surgical group was observed in a systematic review and meta-analysis on long term HRQL in bariatric surgery patients compared with controls spanning 5 to 25 years after surgery.<sup>16</sup> Sleeve gastrectomy has been found to improve QoL and allows reduction of comorbidities.<sup>17,18</sup>

Studies by Akan et al., Fezzi et al., Porta et al. and Rebibo et al. demonstrated significant improvement in all domains of the SF-36 in 6 and 12 months after surgery compared to preoperative scores.<sup>19,20,21,22</sup> Two studies in Indian settings also showed similar improvements in QoL one being in Kerala.<sup>23,24</sup>

Long term studies like the famous Swedish Obese Subjects (SOS) intervention study, Norway (2014) systematic database search for a period of 10 years found significantly better outcome in the surgical group. But the peak improvements in HRQL after bariatric surgery was during the first year, whereas the weight regain phase (mainly between 1 and 6 year follow-up) was accompanied by a gradual decline in HRQL.<sup>25,26</sup>

Some studies could prove significant improvement only in selected dimensions of QoL. An Italian study (2014) to evaluate the changes of HRQL after bariatric surgery in 110 patients using SF-36 showed a significant improvement in all dimensions of SF-36 except General health and Mental health.<sup>27</sup> In Poland the SF-36 scores were statistically different in all parameters (P < 0.05) except for "role limitations attributed to emotional problems" and "mental health" in a group of 120 patients in comparison with patients scheduled for surgery.<sup>28</sup> A

systematic review with 72 studies on 9433 patients found that bariatric surgery has a significant positive influence on QoL in general with a greater positive influence on physical QoL compared to mental QoL.<sup>29,30,31,32,33</sup>

These findings are different from the present study findings in that the QoL had significantly improved in mental dimensions than the physical dimensions. The difference may be due to the improvement in self esteem, societal and family acceptance felt by the subjects probably influenced by the age, education and culture.

Contradictory to the findings of the present study, the physical and mental component scores were significantly found to be lower than the norm population mean in a Midwestern academic medical center study on 350 patients after bariatric surgery (2015). The study concluded that improvements in HRQL following bariatric surgery do not appear to be sustained over long term.<sup>34</sup>

Recent literature has raised concerns regarding the risk of adverse psychiatric events among bariatric surgery patients. The improvement in MCS score found in the present study is contrary to a recent study by Szmulewicz A, et al. 2019 who did a systematic review and meta-analysis of RCTs that compared surgical and non-surgical treatments and assessed mental health QoL of bariatric surgery patients. Eleven randomized trials with 731 participants were included in the final analysis. The final mental health QoL scores were similar for surgically and non-surgically treated patients (SMD: 0.37, 95% CI -0.07 to 0.81). These results suggest that intensive mental health follow-up following surgery should be routinely considered.<sup>35</sup>

In general it can be stated that most of the studies showed improvement in HRQL after LSG in 6-80 months follow-up in adult population. The impact varied considerably across studies showing a significantly greater positive influence on physical QoL compared to mental QoL.

**Clinical Application:** The compliance of the bariatric surgery subjects to the new lifestyle and changes during weight loss/weight regain periods could be enhanced only by consistent follow up by the community health workers resulting in better QoL. The fluctuations in weight loss after crossing certain threshold needs further longitudinal studies with multiple check points.<sup>36</sup> Listening to the psychosocial issues of these patients would help in detecting early the manifestations

of psychological disorders like depression so that appropriate referral services could be offered. Finally aggressive, comprehensive measures should be taken by the regional, state and national level governments to prevent obesity from childhood as patients after bariatric surgery have to live with restrictions hour as India ranks third in obesity in the world.

## Conclusion

The study concludes that the health related quality of life is better in obese patients after LSG than those without surgery in the study subjects. Hence the null hypothesis is rejected. The study also strongly recommends the conduct of long term longitudinal qualitative studies with multiple points of measurements and follow-ups to be extended to the community.

**Acknowledgement:** The investigator deeply thanks the subjects for their active co-operation during the study.

**Conflict of Interest:** Nil

**Source of Funding:** Self

**Ethical Clearance:** The research proposal and tools were presented before the Institutional Scientific Committee and Institutional Ethical Committee and got approval. Permission for data collection was also obtained from the heads of the departments. Informed consent was obtained from each study subject

## References

1. Alkassis M, Haddad FG, Gharios J, Noun R, Chakhtoura G. Quality of Life before and after Sleeve Gastrectomy in Lebanese Population. *Journal of obesity*. 2019;2019.
2. Hosseini SV, Al Hurry AM, Khazraei H, Hadavi H. The effect of laparoscopic sleeve gastrectomy on patients' quality of life in Shiraz. *Journal of Minimally Invasive Surgical Sciences*. 2018 Feb;7(1).
3. Nickel F, Schmidt L, Bruckner T, Buchler WB, Stich BP, Fischer L. Influence of bariatric surgery on quality of life, body image and general self-efficacy within 6 and 24 months- a prospective cohort study. *Surgery for obesity and related diseases*. [Internet]. 2016 month[date of citation];volume:[about 13 pages].
4. Brown D, Edwards H. *Lewis's Medical Surgical*



- Nursing- Assessment and management of clinical problems. 7<sup>th</sup> ed. Place of publication: Elsevier; year. 2011 Page No. 976 - 992.
5. Le Foll D, Lechaux D, Rascle O, Cabagno G. Weight loss and quality of life after bariatric surgery: a 2-year longitudinal study. *Surgery for Obesity and Related Diseases*. 2020 Jan 1;16(1):56-64.
  6. Still C, Sarwer DB, Blankenship J. *The ASMBS Textbook of Bariatric Surgery*. New York, NY: Springer Science, Media; 2014
  7. Grothe KB, Dubbert PM, O'Jile JR. Psychological assessment and management of the weight loss surgery patient . *American Journal of Medical Sciences*, 2006, 331(4), 201- 206. doi: 0000441-200604000-00006 [pii].
  8. Song A, Fernstrom MH. (2008). Nutritional and psychological considerations after bariatric surgery. *Aesthetic Surgery Journal*, 28(2), 195-199. doi: S1090-820X(08)00027- 7 [pii]10.1016/j.asj.2008.01.005
  9. Moly KT, Shajan S, Johny S. Quality of Life and Depression in Obese. *Indian Journal of Public Health Research & Development*. 2019;10(9):266-70
  10. Sarkhosh K, Birch DW, Sharma A, Karmali S. Complications associated with laparoscopic sleeve gastrectomy for morbid obesity: a surgeon's guide. *Canadian journal of surgery*. 2013 Oct;56(5):347.
  11. Gilmartin J. Body image concerns amongst massive weight loss patients. *Journal of clinical nursing*. 2013 May;22(9-10):1299-309.
  12. Sarwer DB, Wadden TA, Fabricatore AN. Psychosocial and behavioral aspects of bariatric surgery. *Obesity research*. 2005 Apr;13(4):639-48.
  13. [https://www.rand.org/health-care/surveys\\_tools/mos/36-item-short-form.html](https://www.rand.org/health-care/surveys_tools/mos/36-item-short-form.html)
  14. Sinha R, van den Heuvel WJ, Arokiasamy P. Validity and reliability of MOS short form health survey (SF-36) for use in India. *Indian journal of community medicine: official publication of Indian Association of Preventive & Social Medicine*. 2013 Jan;38(1):22
  15. Faria GF, Santos JM, Simonson DC. Quality of life after gastric sleeve and gastric bypass for morbid obesity. *Porto Biomedical Journal*. 2017 Mar 1;2(2):40-6. Quality-of-life measures improve as early as 3 months after bariatric surgery
  16. Kristina F. Endocrinology Gastric Sleeve Works Long Term Obese patients., *MedPage* July 16, 2013, <https://www.medpagetoday.org/endocrinology/obesity/40490?vpass=1>
  17. Vasileios C, Georgios B, Vasileios L, Eelco de B. Quality-of-Life Before and After Laparoscopic Sleeve Gastrectomy. A Prospective Cohort Study. *Article in Surgery for Obesity and Related Diseases* 11(1) · May 2014 DOI: 10.1016/j.soard.2014.04.024
  18. Flolo TN, Tell GS, Kolotkin RL, Aasprang A, Norekvål TM, Våge V, Hufthammer KO, Andersen JR. Changes in quality of life 5 years after sleeve gastrectomy: a prospective cohort study. *BMJ open*. 2019 Sep 1;9(9):e031170
  19. Akan S, Uruc F, Aydin MT, Verit A. The effect of sleeve gastrectomy technique on women's sexual function: A prospective study. *Rev Int Andrologia [Internet]*. 2018;16(4):167-73.
  20. Fezzi M, Kolotkin RL, Nedelcu M, Jausent A, Schaub R, Chauvet MA, et al. Improvement in Quality of Life After Laparoscopic Sleeve Gastrectomy. *Obes Surg [Internet]*. 2011;21(8):1161-7.
  21. Porta A, Aiolfi A, Musolino C, Antonini I, Zappa MA. Prospective Comparison and Quality of Life for Single-Incision and Conventional Laparoscopic Sleeve Gastrectomy in a Series of Morbidly Obese Patients. *Obes Surg [Internet]*. 2017;27(3):681-7.
  22. Rebibo L, Verhaeghe P, Tasseel-Ponche S, Cosse C, Maréchal V, Dhahri A, et al. Does sleeve gastrectomy improve the gait parameters of obese patients? *Surg Obes Relat Dis [Internet]*. 2016;12(8):1474-81.
  23. Bal RS, Ahuja A, Virk SS. Difference in Quality of Life in Morbidly Obese Patients after Bariatric Surgery. *Poster [Internet]*. 2012 .
  24. Dasgupta A, Wasir J, Beloyartseva M, Malhotra S, Mithal A. An observational longitudinal study of the impact of sleeve gastrectomy on glycemic control in type 2 diabetes mellitus. *Diabetes Technology and Therapeutics*. 2013; 15(12): 990-995
  25. Karlsson J, Taft C, Ryde A, Sjo S, Sullivan M. Ten-year trends in health related quality of life after surgical and conventional treatment for severe obesity; SOS intervention study. *International Journal of Obesity.[Internet]*.2007 month[date of citation];31: [about 13 pages]. Available from www.

- nature.com site---- DOI:10.1038/SJ.IJO.0803573.
26. Andersen JR, Aasprang A, Karlsten TI, Natvig GK, Våge V, Kolotkin RL. Health-related quality of life after bariatric surgery: a systematic review of prospective long-term studies. *Surgery for Obesity and Related Diseases*. 2015 Mar 1;11(2):466-73.
  27. Nadalini L, Zenti MG, Masotto L, Indelicato L, Fainelli G, Bonora F, Battistoni M, Romani B, Genna M, Zoppini G, Bonora E. Improved quality of life after bariatric surgery in morbidly obese patients. *Interdisciplinary group of bariatric surgery of Verona (GICOV). Il Giornale di chirurgia*. 2014 Jul;35(7-8):161.
  28. Haldis, Lier, Eva Bringer, Oddbjorn Hove, BjarteStubhaug and Tong Tangen Health and Quality of life outcomes. Quality of life among patients undergoing bariatric surgery: associations with mental health. A 1 year follow-up study of bariatric surgery patients. <http://www.hqlo.com/content/9/1/79>
  29. Lindekilde N, Gladstone BP, Lübeck M, Nielsen J, Clausen L, Vach W, Jones A. The impact of bariatric surgery on quality of life: a systematic review and meta-analysis. *Obesity reviews*. 2015 Aug;16(8):639-51.
  30. Hachem A, Brennan L. Quality of life outcomes of bariatric surgery: a systematic review. *Obesity surgery*. 2016 Feb 1;26(2):395-409.
  31. Hosseini SV, Al Hurry AM, Khazraei H, Hadavi H. The effect of laparoscopic sleeve gastrectomy on patients' quality of life in Shiraz. *Journal of Minimally Invasive Surgical Sciences*. 2018 Feb;7(1).
  32. Van Nunen AM, Wouters EJ, Vingerhoets AJ, Hox JJ, Geenen R. The health-related quality of life of obese persons seeking or not seeking surgical or non-surgical treatment: a meta-analysis. *Obesity surgery*. 2007 Oct 1;17(10):1357
  33. Bolen SD, Chang HY, Weiner JP, Richards TM, Shore AD, et.al, Clinical outcomes after bariatric surgery: a five-year matched cohort analysis in seven US states. *Obes Surg*. 2012 May;22(5):749-63. doi: 10.1007/s11695-012-0595-2
  34. Khandalavala BN, Geske J, Nirmalraj M, Koran-Scholl JB, Neumann-Potash L, McBride CL. Predictors of health-related quality of life after bariatric surgery. *Obesity surgery*. 2015 Dec 1;25(12):2302-5.
  35. Szmulewicz A, Wanis KN, Gripper A, Angriman F, Hawel J, Elnahas A, Alkhamesi NA, Schlachta CM. Mental health quality of life after bariatric surgery: A systematic review and meta-analysis of randomized clinical trials. *Clinical obesity*. 2019 Feb;9(1):e12290.
  36. Prof. Moly K. T., "Excessive Weight Loss and Quality of Life after Laparoscopic Sleeve Gastrectomy—A Correlational Study", *Indian Journal of Public Health Research & Development*, vol. 10, no. 6, pp. 296-301, 2019

# Socio-Legal Updates of Children's Rights on the Protection and Shared Assets in Divorce Cases in Indonesian Family Law

**Muhyidin**

*Lecturer at Diponegoro University, Semarang, Indonesia*

## Abstract

The focus of this research study is the law on the distribution of joint assets and child custody as a result of divorce against husbands and wives who work based on justice value. Article 97 Compilation of Islamic Law which determines that widows of divorced widows get a half share of the joint property. This is inseparable from the provisions of Article 31 and Article 34 of Law Number 1 of 1974 concerning Marriage. This study uses normative juridical method, sociological juridical method, and comparative juridical research method; and using decision data and interviews with judges of the religious courts, using critical paradigms and using inductive qualitative analysis. The results of the study were that the judge had begun to make legal discoveries. Factors that influence the ruling of the religious courts that do not bring about justice are substantial, structural, and cultural factors. The current division of shared assets and the rights of child ownership as a result of divorce is not yet fair, meaning that the construction of the distribution of shared assets and child rights as a result of divorce is currently granted by The reconstruction of the legal value of the distribution of shared assets due to divorce is carried out casually based on its contribution by taking into account the benefit and well-being of the company.

**Keywords:** *Child rights, custody, child care, marital assets, family law.*

## Introduction

Marriage law is part of the teachings of Islam that must be obeyed and implemented according to the religious provisions. With the enactment of Law Number 1 of 1974 concerning Marriage, the reception theory by Snouck Hurgronje as taught in the Dutch East Indies era was erased formally<sup>1</sup>. The reception theory is a theory which states that Islamic law only applies in Indonesia to adherents of Islam, if something Islamic law has clearly been permeated by and in customary law<sup>2</sup>. By looking at certain articles in this Marriage Law there is no doubt to accept the argument that Islamic law

has become a direct source of law without the need for assistance/intermediaries for customary law<sup>3</sup>. Marriage law that applies to all Indonesian people, namely Law Number 1 of 1974 concerning Marriage, was ratified and signed by the President Soeharto in Jakarta on January 2, 1974, and that day was also promulgated and signed by the Minister/Secretary of the Republic of Indonesia Maj. Gen. Sudarmono, as well as being included in the 1974 State Gazette no. 1 and the explanation contained in the additional sheet of the Republic of Indonesia No. 3019. This law contains 14 chapters and 67 articles. In it regulates the basis of marriage, conditions for marriage, marriage prevention, marriage cancellation, marriage agreements, rights and obligations of husband and wife, property in marriage, marriage termination and its consequences, child status, rights and obligations between parents and children, guardianship and other provisions<sup>4,5,6</sup>.

For the smooth implementation of Law Number 1 of 1974 the government issued Government Regulation Number 9 of 1975 concerning Implementation of Law Number 1 of 1974. Government Regulation Number

---

### Corresponding Author:

**Muhyidin**

Lecturer at Faculty of Law, Diponegoro University, Jl. Prof. Soedarto, Tembalang, Semarang, Central Java 50275, Indonesia

e-mail: muhyidin.fhundip@gmail.com

9 of 1975 is contained in State Gazette No. 12 and its explanation in the Supplement to the State Gazette No. 3050. Government Regulation Number 9 of 1975 contains 10 Chapters and 47 articles. The study aims to examine further the case of the distribution of shared assets and the right of child care due to divorce of husband and wife. Different from the perspective offered in previous studies, this paper also aims to examine the right for child custody after divorce<sup>7,8,9</sup>. This is based on the assumption that there is an absence regarding clear arrangements regarding the distribution of shared assets, as well as child custody due to divorce in Islamic Marriage Law.

#### **Marriage in Religious and Legal Perspectives:**

Marriage is very important in the lives of people, individuals and groups. By way of a legal marriage, the association of men and women takes place in an honorable manner according to the position of humans as respectable beings. Relationships of married life are fostered in an atmosphere of peace, tranquility, and affection between husband and wife. The offspring of the result of a legal marriage adorns family life and at the same time is a continuation of human life in a clean and respectful manner. Human relations between men and women are determined to be based on a sense of devotion to God and devotion to humanity in order to carry on the life of its kind. Marriage is carried out on the basis of the willingness of the parties concerned, which is reflected in the provisions of the marriage before marriage and consent granted in the marriage ceremony which is also witnessed before the public in an event. The rights and obligations of a husband and wife are regulated very neatly and in an orderly manner, as well as the rights and obligations between parents and children. If there is a dispute between husband and wife, it is also arranged how to deal with it. It also guided the customs of social courtesy in the family as well as possible so that harmony of life remains maintained and guaranteed.

From the foregoing, it can be seen that marriage has a very important position in Islamic law because the marriage law regulates family life procedures which are the core of people's lives in line with the position of humans as respectable beings over other creatures<sup>10</sup>. Opinion which states that the reception theory both as a theory and as a provision in article 134 paragraph 2 Indische Staatsregeling has been erased by the enactment of the 1945 Constitution. This can be seen in the 1945 Constitution article 29 paragraph (2), which contains

provisions: The state guarantees the independence of each population to embrace their respective religions and to worship according to their religion and beliefs. From the provisions of article 29 paragraph (2), the government has the right to regulate certain issues based on Islamic law, to what extent these regulations are intended for citizens who are Muslim<sup>11</sup>.

**Child Rights on Shared Assets as Results of Divorce:** Regarding the consequences of divorce against children Law Number 1 of 1974 concerning Marriage under Article 41 determines that the mother or father remains obliged to look after and educate their children, solely based on the interests of the child, if there is a dispute regarding childcare, the court gives its decision. The father is responsible for all the maintenance and education costs required by the child, if in fact the father cannot provide this obligation, the court can determine that the mother will share the costs. Article 149(d) Compilation of Islamic Law, stated that if the marriage is broken because of divorce, then the ex-husband is required to provide child custody fees for his children who have not reached the age of 21 years old<sup>12,13,14</sup>. According to Law Number 1 of 1974 and the Compilation of Islamic Law, parental divorce does not eliminate the obligation of parents to care for and educate their children. It is the father who is responsible for bearing the costs of maintaining and educating his children with the provisions that if in reality the father cannot fulfill his obligations, then the mother can also be burdened to bear the costs. As a result of divorce against a child is about the issue of parental power, with the divorce resulting in the termination of marriage, the court determined that each of the children who had not grown up who of the parents who do guardianship. Regarding the trusteeship it is up to the judge who determines and who will be appointed guardian only in the appointment must be considered the interests of the child.

Most people, especially parents or husband and wife, do understand and realize that caring for their child is an obligation. However, there are also those who mistakenly carry out child care, so that there are only those who are concerned only with the physical growth of their children and meet the material needs of children excessively, without regard to the child's mental growth and the spiritual needs of children in the form of attention to mental development and giving love affection for him. This mistake may be caused by the lack of understanding of the parents of the meaning and understanding of the child care, as well as the obligations that exist in it.

Child care is an authority to care for and educate people who have not been adults who have not sufficiently acquired their intelligence. The emergence of the child care problem is sometimes caused by divorce or because of death where children are not yet mature and are no longer able to take care of themselves, hence the need for people who are responsible for caring for and educating the child<sup>15,16,17</sup>. Child care is to equip children materially and spiritually, mentally and physically so that children are able to stand alone in facing life and later life when he is an adult. Child care covers all the needs of the child, physically and spiritually. So including child care is to develop the intellectual soul of children through education.

Islamic jurists agree that the mother is the person most entitled to do child care. However, they differ in matters, especially regarding the length of a mother's upbringing, which is most entitled after the mother and also about the conditions for being a caregiver mother. As long as there is no obstacle to taking care of the children, the mother must perform the child care unless there is an obstacle preventing her from carrying out the child care.

In the condition of the more dominant wife/greater contribution in meeting the needs of the family, the right of the child care due to divorce, the child in the care of the mother. This right will be erased if the mother behaves badly or because of desires the child himself (the child who has been in teenage has the right to choose to get child care from his father or mother, article 156 letter b of the Compilation). Thus, the husband (also applies to the wife) can also ask for custody of the child based on the best interests of the child, by proving the arguments that one of the parties apparently cannot be used as a role model for children. In other words one of the parties cannot carry out a good obligation as a parent to their children, in the same conditions. First, one party commits adultery or becomes a drunkard, compactor, gambler, etc. that is difficult to cure; second, one party has left the other party without the permission of the other party and without a valid reason or because of anything else beyond its ability; third, one party gets a prison sentence; fourth, one party commits atrocities or severe persecution that endangers the other party; fifth, in carrying out the activities of caring for children so far, it turns out that it is no better than the party that submitted it; and/or other reasons<sup>19</sup>.

Article 156 of the Compilation point b stated that as a

result of the marriage breaking up due to divorce are that children who are in teen have the right to choose custody of the child from their father or mother. One thing that needs to be warned is that whoever is ultimately chosen to be followed, the success of education in order to become a godly child becomes the joint responsibility of his father and mother. Everything is discussed together, divorce father and mother do not result in the child being a victim. The child should never instill hatred to parents, mothers should not make the father's name in the face of the child, and vice versa. The child who follows the father should not be separated at all from his mother and the child who follows the mother should never be separated from his father's relationship.

## Conclusion

The current division of shared assets and the rights of child ownership as a result of divorce is not yet fair, meaning that the construction of the distribution of shared assets and child rights as a result of divorce is currently granted by Marriage Law No. 1 of 1974, Compilation of Islamic Law has not fulfilled a sense of justice. The factors which influence the distribution of shared assets and the rights of the children of a child due to divorce are not based on justice. The reconstruction of the legal value of the distribution of shared assets due to divorce is carried out casually based on its contribution by taking into account the benefit and well-being of the company. The provisions of article 97 the Compilation will not be considered fair and cannot explain or resolve if there is a case of a wife other than as a housewife as well as a household regulator, the wife also contributes to family needs. The judge needs to make a legal discovery. The right to child care often becomes a problem after divorce. This study uses normative juridical method, sociological juridical method, and comparative juridical research method; and using decision data and interviews with judges of the religious courts, using critical paradigms and using inductive qualitative analysis. The results of the study were that the judge had begun to make legal discoveries such as in the decision of the Padang High Religious Court with No. 38/Pdt.G/2013/PTA.Pdg. by adjudicating themselves, namely establishing joint assets of 1/3 part for the plaintiff (husband) and 2/3 part for the defendant (wife) on the basis of consideration in obtaining joint property of the plaintiff and defendant during the marriage, the defendant is more dominant and plays an active role as a civil servant. Factors that influence the ruling of the religious courts that do not bring about justice are substantial, structural, and cultural

factors. The development of the value of the division of shared assets due to divorce is carried out casually based on its contribution by taking into account the benefit and well-being of it. The development of the value of child custody due to divorce is based on orientation in child care is solely for the benefit, benefit and benefit of the child concerned. The theory of case law with justice and prosperity can be used as a contribution in the formation of national law in the field of marriage, especially to re-construct article 37 of Law Number 1 of 1974 and Article 97 of Compilation of Islamic Law.

**Ethical Clearance:** This research was ethically approved by Faculty of Law, Universitas Diponegoro, Semarang, Indonesia

**Funding:** This research receives Research Grant Funds at the Faculty of Law of Diponegoro University in the 2020 budget year.

**Conflict of Interests:** There are no conflict of interests

### References

1. Barlinti YS. Harmonization of Islamic Law In National Legal System: A Comparative Study Between Indonesian Law And Malaysian Law. *Indon. L. Rev.*2011;1:35.
2. Mas'ud M. The application of islamic law at the colonial age and it's implication for the indonesian religious justice system. *Journal of Islamicate Studies.* 2018;1(2)..
3. Lukito R. *Islamic Law and Adat Encounter: The Experience of Indonesia.* Logos; 2001.
4. Katz JS, Katz RS. The new Indonesian marriage law: a mirror of Indonesia's political, cultural, and legal systems. *Am. J. Comp. L.* 1975;23:653.
5. Suadi A. Peranan Peradilan Agama Dalam Melindungi Hak Perempuan Dan Anak Melalui Putusan Yang Memihak Dan Dapat Dilaksanakan/ The Role of Religious Court In Women And Children Rights Protection Through Partial And Executable Decision. *Jurnal Hukum dan Peradilan.* 2018 Dec 18;7(3):353-74.
6. Nurhadi N. The dualism of the supreme court's decisions on the position of non-marital child. *Jurnal Hukum dan Peradilan.* 2019 Jul 31;8(2):228-54..
7. Waridin W, Dwiyanto BM, Saraswati R, Mafruhah I. Formulation of problem-solving design for indonesian informal sector migrant workers towards post-placement independence: Case study in Malaysia. *Research in World Economy.* 2020;11(1):115-122
8. Utami NS, Prasetyoningsih N, Hidayat A, (...), Saraswati R, Budiono A. Equality of the political rights of people with mental disorders (PWMD) in general elections. *Indian Journal of Forensic Medicine and Toxicology.* 2019;13(4):1571-1575
- 9]Azhar M, Solechan S, Saraswati R, Suharso P, Suhartoyo S, Ispriyarso B. The New Renewable Energy Consumption Policy of Rare Earth Metals to Build Indonesia's National Energy Security. *InE3S Web of Conferences 2018 (Vol. 68, p. 03008).* EDP Sciences.
10. Soemiyati N. *Hukum Perkawinan Islam Dan Undang-undang Perkawinan (undang-undang No. 1 Tahun 1974, Tentang Perkawinan).* Liberty Yogyakarta; 1986.
11. Hazairin, T. S. T. H. Hazairin, *Hukum Kekeluargaan Nasional.* Jakarta: Tintamas; 1982.
12. Julia J. The Maqāsid Analysis on the Nafkah Iddah of Divorce Lawsuit in the Compilation of Islamic Law (KHI) Article 149 (b) and the Supreme Court Verdict Number 137/K/AG/2007. *Ulumuddin.* 2020 Jan 31;13(1):23-43.
13. Ristyawati A, Saraswati R. An Effort of Political Party Simplification for the Effective Government Realization. *IOP Conference Series: Earth and Environmental Science* 2018;175(1),012170
14. Tyesta LA, Saraswati R, Faisal A. Implications of Legal Positivism of the Promotion of Children's Rights on National Law. *Journal of Advanced Research in Law and Economics.* 2020 Mar 31;11(2):661-6.
15. Alam S, Fauzan M. *Hukum Pengangkatan Anak Perspektif Islam.* Kencana Prenada Media Group; 2008.
16. Saraswati R, Ristyawati A, Basworo RS. Recent developments and changes in the governance of regional legal products in Indonesia: Supervision, evaluation and clarification mechanisms. *International Journal of Innovation, Creativity and Change.* 2020;12(7):1-9
17. Ariyanto A, Saraswati R, Sukirno S. Asymmetric election of protecting the voting of the noken

- system in selecting the regional head in Papua. *Test Engineering and Management*. 2020;83(2):3229-3237
18. Jauhari I. Comparison of Child Protection Law between Indonesia and Malaysia. *Indonesian J. Int'l L.* 2014;12:84.
  19. Roisah K, Utama YJ, Saraswati R, Whidari Y. Status and contemporary development of employee inventions ownership in G-20 countries. *European Research Studies Journal*. 2018;21(2):214-224

# New Treatment for Regular Astigmatism Using Physical Exercises

**Mundher Sameen Shuker**

*Assist Prof., Department of Optics Technology, College of Health and Medical Technology, Middle Technical University, 10047 Bab Al Muadham, Baghdad, Iraq*

## Abstract

**Introduction:** Regular Astigmatism is one of the most common problems for the eye; it makes a patient unable to see things clearly. Therefore, the aim of the study estimates the incidence of regular astigmatism among age group (10-32) years by using physical exerciser in the college of health and medical technology. We perform therapeutic exercises in an applied scientific way to activate the towed eye muscles by the pulled during treatment sessions to get rid of regular astigmatism and improve vision without the use of glasses or surgery to patients.

**Materials and Method:** The method used in this study was a cross-sectional analysis of 100 cases (51 males) (49 females) with different types of astigmatism through physical exercise. The data analysed using the SPSS package program.

**Results:** We found the compound astigmatism (58%) is higher than simple astigmatism (33%), as well as the compound astigmatism is higher than mixed astigmatism (13%). Also, we found to improve in (90%) patients treatment for continuous exercise as requested by the therapist.

**Conclusion:** This study that most patients of Astigmatism were compound and improvement in 90% of cases treatment by physical exercise and did not need to use any glasses to read during the examination and get 'Visual Acuity' VA=6/6.

**Keywords:** *Regular Astigmatism, Physical Exercises, New Treatment, Visual Acuity, Astigmatism Treatment.*

## Introduction

Astigmatism, considered to be one of a group of eye defects with certain sights, including myopia and hyperopia, known as Refractive Errors (R.E)<sup>(1)</sup>. This is also the concept of the inability of the cornea to focus the image on the retina; the effect is a blurred picture of the patient<sup>(2)</sup>. As they influence light refraction in the eyes, this creates a change in the way light beam focused in the eye, it simply means that the shape of your cornea is different<sup>(3)</sup>. Many symptoms may include eyestrain, headache, and night driving problems<sup>(4)</sup>. The stigmatism has many classifications, but there are two types of astigmatism, which are determined by the shape of the cornea: Irregular Astigmatism, and Regular Astigmatism<sup>(5,6)</sup>. The two terms are defined:

**Irregular Astigmatism** is a kind of astigmatism

that arises from the disruption of light rays caused by a cornea lens disorder<sup>(7)</sup>. Interruption is usually caused by illness or injury in one of these areas of the eye, resulting in surface irregularity and, consequently, distortion of the light rays that reaching the eye<sup>(7)</sup>. This type of astigmatism is only treated with surgical procedures or special type of contact lenses and will not be emphasized in this research.

**Regular Astigmatism** also, there is a type of astigmatism in different areas of the eye<sup>(7)</sup>, while light is not focused on the centre of the retina in normal conditions if the stabilizing beam is called near-sightedness or hyperopia in the retina in front of the eye<sup>(8)</sup>. There is one trend in all cases of regular astigmatism where the lines are very far and one in the right corners of this where conventional lenses (lenses, contact lenses, and surgery) tend to be more confusing and accurate. But today we



correct the curative exercises of weak eye muscles in a different way from the previous one, and it is called muscle stimulation<sup>(9)</sup>. This type of astigmatism has three classes (simple astigmatism, complex astigmatism, and mixed astigmatism), and these types are known as:

**A -Simple Astigmatism;** is the one area of the eye is regular while the other is either myopia or hyperopia; therefore, when two or perpendicular lines have been seen, the line representing myopia or hyperopia is out of focus and blurred while the other line is clearly focused (10). The simple type of astigmatism is corrected by means of cylindrical lenses that guide the out of focus beam of the eye according to the power required<sup>(7,10)</sup>.

**A- Compound Astigmatism** Two primary meridians are described (Myopia, or Hyperopia). 1- Composite Astigmatism of Myopia, a beam in all meridians in front of the eye comes to a concentration. 2- Hybrid astigmatism with hyperopia, a pulse in both meridians is focussed in the retina<sup>(11)</sup>.

**B- Mixed Astigmatism;** one of the definitions of the meridian is myopia, while the other is hyperopia. In combination and mixed types, the ring is attached to the spherical lenses to create a clear image<sup>(11,12)</sup>.

The incidence of astigmatism usually refers to the overall population of people who treat it at any given time<sup>(13)</sup>. The incidence of high levels of astigmatism among Americans is greater (1D)\*. That key fundamental causes have postulated is inherited.

In 1995, 11% of schoolchildren in Taiwan had astigmatism (1D-2D) and 1.3% (3D). While in 2000 it was 13% had astigmatism (1D-2D), and 1.8% (3D). The incidence of myopic astigmatism increased with age, but the comparison is a reduction in the rate of hyperopic and mixed astigmatism with age 17 years<sup>(14)</sup>. Most of the children had astigmatism were from East Asia 17.2%, the Middle East 4.9%, and South America 0.9%<sup>(15)</sup>.

\*(D = Dioptre)

**Astigmatism treatment** at first, if the degree of astigmatism is small, and there are no other refractive problems, such as Myopia or Hyperopia, corrective lenses may not be required<sup>(11)</sup>. While, if the degree of astigmatism causes visual loss or pain, it will prescribe prescription lenses<sup>(16)</sup>. However, there are very effective alternatives, such as eye robins, which allow a clear vision of contact lenses or glasses to be restored naturally<sup>(17)</sup>. There are three common types of Astigmatism treatment:

1. Eye-glasses: a method of correction for people with astigmatism. In order to account for astigmatism, it must contain a special cylindrical lens prescription in only specific lens meridians; this provides additional lens power<sup>(18)</sup>. A single vision lens is a clear vision at all distances, but when the patient is 40 years of age, it is considered presbyopia<sup>(17,19)</sup>.
2. Contact lens (C.L): is a better vision than eyeglasses; it can provide a clearer vision and a wider FOV because C.L is worn directly on the eyes, but regular cleaning and care are needed to protect and safety of the eyes<sup>(20)</sup>.
3. Surgery: it has two method of astigmatism treatment by surgery. First, Implantation of contact lens: Recent attempts to surgically implant contact lenses for correction of regular astigmatism have also been found effective<sup>(21)</sup>. Second, refractive surgery (LASIK): improves vision and removes the need for eyeglasses and contact lenses<sup>(22,23)</sup>. Your eye surgeon uses a laser beam to reshape corneal curves to correct astigmatism before surgery<sup>(23,24)</sup>; doctors will assess you and determine whether or not you are a candidate for LASIK astigmatism<sup>(25,26)</sup>.

## Materials and Method

**Materials:** The research group consists of 100 patients with Regular Astigmatism (51 Male, 49 female). All patients were exposed to regular physical activity, astigmatism therapy, and attending the clinical advisory in the Medical and Health Technology Collage. It was the criteria for selecting patients with astigmatism and determines the level of natural astigmatism at the age of 10-30 years. Then all information was done by means of a direct questioner, including (age, gender, family history, and glass wearing).

**Method:** The method will use four-step procedures for regular astigmatism. Initially, the use of the (automatic refractometer) for an automatic tool automatically measures the power of eye focus. Second (visual acuity); This test was used to measure the VA, requesting the patient to read messages using the Snellen chart or cubes. Third (retina range), the patient adjusts and looks directly at the Snellen chart for about 6 meters, the doctor holds the instrument for about 0.5 to 1 or 1.5 meters, and light from the device directs the patient's eye to see the type and measure the degree of regular astigmatism for each individual eye. Finally, conducting therapeutic exercises in an integrated scientific way to stimulate the muscles

of the eye without closing the healthy eye after placing the cornea in the centre of the eye and using a principle pinhole and then the eyes are drilled without movement for a period of 15 minutes depending on the experience of the therapist until a straight movement in addition to conducting training at home before Parents need to maintain the amount of improvement that they got in each session of treatment sessions to get rid of regular astigmatism. Initially, using glasses for three sessions occurs to determine the extent of improvement exercises and then the continuous exercise without glasses.

## Results

In the beginning, it is noted that most types of treatment use glasses and in the case of leaving or not wearing the glasses are returned to their old position. But in this method, what has been done to the patient by means of therapeutic exercises to stimulate the eye muscles and to conduct an optician test without affecting the eye and the possibility of getting VA=6/6 and removing the glasses, the results show all that.

Table (1) shows the samples were 100 patients, split into 51% male and 49% female. Higher percentages at age groups 10-15 years were ratio formed 51%, while the proportion was 11% for people 22-27 years of age. This means that the highest percentage is children, so the patient's family needs to help the patient conduct therapy exercises.

**Table (1): Distribution of cases of regular astigmatism according to age groups (years) and gender.**

Age Groups (Years)	Male		Female		Total	
	N	%	N	%	N	%
15-10	29	29%	22	22%	51	51%
21-16	06	6%	19	19%	25	25%
27-22	06	6%	05	5%	11	11%
Up to 32	10	10%	03	3%	13	13%

It is evident that the aetiology of the types of daily astigmatism in 100 patients is the majority of smart devices such as (x-box, play station, and mobile) where the proportion 67% of the total causes is considered to be the most common among other causal types. While, it was found 25% because of continuous reading with neglect of wearing glasses and lack of therapeutic exercises. We also found that compound astigmatism has been aggravated in 58% of cases. Table (2) show the distribution of all 100 patients according to causes by types of regular astigmatism. Also, It is evident from Table (3) that the case with compound Astigmatism were 58% regular the distribution of astigmatism according to age groups (years), which found that 20 cases were having compound astigmatism & were at age group 16-21 years.

**Table (2): Distribution of samples according to causes by types of regular astigmatism.**

Types of Regular Astigmatism	Causes			Total
	Smart Devices	Continuous Reading	Others	
Simple Astigmatism	22	8	3	33
Compound Astigmatism	40	14	4	58
Mix Astigmatism	05	03	1	09
<b>Total</b>	<b>67</b>	<b>25</b>	<b>8</b>	<b>100</b>

**Table (3): Distribution of cases of regular astigmatism by age (year) and type of regular astigmatism.**

Age Groups (Year)	Type of regular astigmatism			Total
	Simple	Compound	Mixed	
10-15	10	15	3	28%
16-21	15	20	4	39%
22-27	5	13	2	20%
Up to 32	3	10	-	13%
<b>Total</b>	<b>33</b>	<b>58</b>	<b>9</b>	<b>100%</b>

According to Visual acuity (VA) of patients with glasses, the highest rates of patient physical exercise therapy 94.8% found 55 cases out of 58 whose visual accuracy exceeds the compound form of regular astigmatism. In contrast, the lower rates of patient physical exercise therapy 44.4% in 4 cases out of 9

of their VA with glass reaches in mixed astigmatism. Table (4) show the distribution Visual Acuity (VA) of cases without glasses and form of Regular Astigmatism (simple, compound, and mixed) before and after treatment without glass.

**Table (4): Distribution Visual Acuity (VA) of cases of Regular Astigmatism (R.A) before and after treatment without glass.**

Type of (R.A) VA	Type of Regular Astigmatism (R.A) before and after treatment						Total	
	Simple		Compound		Mixed		Before Treatment	After Treatment
	Before	After	Before	After	Before	After		
C.F- 6/60	12	12	20	19	3	2	35	33
6/36 - 6/24	10	9	18	16	3	1	31	26
6/18 - 6/12	5	4	12	12	1	1	18	17
6/9 - 6/6	6	6	8	8	2	--	16	14
<b>Total</b>	<b>33</b>	<b>31</b>	<b>58</b>	<b>55</b>	<b>9</b>	<b>4</b>	<b>100</b>	<b>90</b>

R.A= Regular Astigmatism, VA= Visual Acuity, C.F = Count Figure

**Table (5): Distribution of cases of regular astigmatism by groupage and family history.**

Family history Age	Family history				Total	
	Positive		Negative		N	%
	N	%	N	%		
10 – 15	15	37.5%	25	41.5%	40	40%
16 – 21	12	30%	20	33.5%	32	32%
22 – 27	7	17.5%	10	16.5%	17	17%
Up to 32	6	15%	5	8.4%	11	11%
<b>Total</b>	<b>40</b>	<b>40%</b>	<b>60</b>	<b>60</b>	<b>100</b>	<b>100%</b>

Table (5) shows that cases with a negative family history of astigmatism accounted for more than 60% of those without a negative family history, particularly those with a 41.5% negative family history age group of 10-15 years.

**Discussion**

The number of males is marginally higher than that of females for a retrospective study of medical data on 100 patients, the proportion of males is 51 %, while the ratio of females is 49%. In this study, we found that 52% of patients have a complex type of normal astigmatism and that most patients have modified the way visual acuity(VA) is viewed from prescription glasses to physics therapy exercises. This is the ease of therapeutic

exercises with the use of medicinal drugs and 90% of patients have been treated, most of them were the degree of vision produced 6/6 without glasses.

It also found that the prevalence of astigmatism in patients between the ages of 10 and 15 due to the excessive use of electronic devices (smart devices) and their inability to wear glasses when continuous reading is caused by a higher prevalence of 16 % between the ages of 16 and 21. For this report, the number of patients who use smart devices are 67% .According to a study carried out in the United States, we found similar results in which compound astigmatism is more prevalent among students than simple and mixed astigmatism. In addition, Family history is a significant risk factor in children with regular astigmatism.

Clinical initiatives and identification of method of treatment have shown how patient outcomes can be improved, that is, by recognizing and moving weak eye muscles and finding the test. During exercises 1-6 sessions, the patient turns the eye in all directions and forces it forward to minimize the eye muscle pressure by about 15 minutes to strengthen the weak eye. Therefore, both patients were treated and strengthened in the degree of concern of each session with therapeutic exercises and did not need to use any glasses to read during the test and to achieve ' visual acuity ' VA=6/6.

### Conclusion

It was recommended that all patients should be tested for their visual acuity and that all cases of astigmatism (regular astigmatism) should be treated with glasses at first and checked every six months to see the difference in the degree of astigmatism that, if any, or any complications in the eye due to misuse of smart devices (It is necessary to use MC-lenses to prevent harmful radiation from smart devices). It must to treat by Physical exercises and at least advised the patient wearing glasses and conduct exercises according to instructions the therapist. After the end of this study are advised to adhere to therapeutic exercises to get rid form correct regular astigmatism. Upon completion of this research are advised to adhere to therapeutic exercises to get rid form regular astigmatism.

**Acknowledgments:** The author would like to thank the patients who have kindly offered their time to take the information and confidence in the treatment method. The author would also like to thank the College of Health and Medical Technology, Middle Technical University, Baghdad, Iraq, for their moral support.

**Conflict of Interest:** Non

**Source of Findings:** Self-findings.

**Ethical Clearance:** Non

### References

1. Andrew A. Dahl, MD, FACS. Astigmatism; 2012. [https://www.emedicinehealth.com/astigmatism/article\\_em.htm#what\\_is\\_an\\_astigmatism](https://www.emedicinehealth.com/astigmatism/article_em.htm#what_is_an_astigmatism)
2. Gary Heiting, OD. What is astigmatism? 2018. <https://www.allaboutvision.com/conditions/astigmatism.htm>
3. Read, Scott A; Collins, Michael J;Carney, Leo G.A review of astigmatism and its possible genesis. *Clinical and Experimental Optometry*; 2007.
4. Gilbert Smolin; Charies Stephen Foster; Dimitri T-Azar; Claes H.Dohlman.Smolin and Thofts the Cornea; Scientific Foundations and Clinical Practice; 2005.PP173.
5. Afsaneh Khetrapal, BSc Astigmatism Types-Regular and Irregular. *News Medical Life Sciences*; 2018.
6. Waddell K. Spherical refraction for general eye workers. *J comma eye health* 2000, 6-7.
7. Mohamed EL-Rifai. *Text Book of Clinical Ophthalmic Optics*. Egypt, 2007.
8. Carlo Cavallotti; Luciano Cerulli.Age – Related changes of the human eye. *Springer Science & Business Media*; 2008.pp49.
9. Harvery, EM. Development and treatment of astigmatism. *Optometry and vision science*; official publication of the American Academy of optometry; 2009.
10. Boyd, Benjamin F. *Modern Ophthalmology, The high lights*. Panama; Jaypee Brothers Medical Pub; 2011. P.388.
11. Mozayan,E, Lee, astigmatism management. *Current opinion in ophthalmology*. 2014.
12. Kleinstein, R. N. Jones, LA; Hullett, S. *Refractive Error and Ethnicity in Children*; 2003.
13. Bourne, R; Dineen, BP;Ali, SM; Noorul Huq, DM; Johnson, GJ. Prevalence of refractive error in Bangladeshi adults; 2004.
14. Yung-Feng Shih. The Prevalence of Astigmatism in Taiwan Schoolchildren, *Optometry and Vision Science*; 02/2004.
15. Ostadimoghaddam H, Fotouhi A, Hashemi H, Yekta A. Heravian J, Re zvan F,et al. Prevalence of the astigmatism by age and gender in Mashhad, Iran: The Mashhad eye study . *Clin Experiment Ophthalmic*; 2011.
16. Andrew A. Dahl, MD, FACS. Astigmatism. *Medicine Net*;2013. [https://www.medicinenet.com/astigmatism\\_overview/article.htm#astigmatism\\_facts](https://www.medicinenet.com/astigmatism_overview/article.htm#astigmatism_facts)
17. Gary L. Mancil, O.D., (Principal Author). *Optometric Clinical Practice Guideline Care of the Patient with Presbyopia*. American Optometric Associattion; 2011.
18. George Biddel Airy. On a peculiar Defect in the

- eye, and a mode of correcting it. Transactions of the Cambridge Philosophical Society; 28 October 2016.
19. Jack J. Kanski, MD, MS, FRCS, FRCOphth. Clinical ophthalmology: A Systematic Approach, Book, Clinical Ophthalmology; 2006.
  20. Grame Young, Anna Sulley, Chris Hunt. Prevalence of astigmatism in relation to soft contact lens fitting. Eye & contact lens, 2011.
  21. Rose Kivi, and Elizabeth Boskey, PhD Medically, MD on November, 2015.
  22. Azar Dimitri T. Refractive surgery (2nd). Mosby Elsevier; 2007.
  23. Munther. S SH., Zina T.A, The biophysical efficacy of smart phones on the eyes of children from 3=12 years, Indian Journal of Forensic Medicine & Toxicology. 2020.
  24. Sophie J. Bakri, M.D. Book: Mayo Clinic Guide to Better Vision. 2019. <https://www.mayoclinic.org/tests-procedures/lasik-eye-surgery/about/pac-20384774>
  25. PK Mukherjee MS Ophth. Manual of optics & Refraction, Refractive Surgeries; 2015 pp212-232.
  26. Ming Wang, MD, PhD. Irregular Astigmatism Diagnosis and Treatment, Book; 2008.

# Patterns of Paediatric Maxillofacial Fractures: A Twelve-Year Retrospective Study

Musaev Shamshodbek Shuxratovich<sup>1</sup>, Shomurodov Kahramon Erkinovich<sup>2</sup>,  
Abdusalikov Sirojiddin Faxriddin O'g'li<sup>3</sup>, Narzieva Mahliyo Isrofil Qizi<sup>3</sup>

<sup>1</sup>Phd Student, Department of Paediatric Maxillofacial Surgery, Tashkent State Dental Institute, Uzbekistan,

<sup>2</sup>Dsc, Docent & Head, of Department of Maxillofacial Surgery, Tashkent State Dental Institute, Uzbekistan,

<sup>3</sup>Postgraduate, Department of Paediatric Maxillofacial Surgery, Tashkent State Dental Institute, Uzbekistan

## Abstract

In this study was to analyse the patterns of maxillofacial fractures in children under 18 years of age admitted at paediatric maxillofacial surgery department in Tashkent state dental institute, Uzbekistan in a period of 12 years between January 2007 and December 2018. Out of 757 children with maxillofacial bone fractures, the majority were aged between 6-18 years (78,6%, n=595). The mean ( $\pm$ SD) age was 9.3 $\pm$ 0.5 years and male to female ratio was 6.2:1. Falls was the most frequent mode of injury (46,9%, n=355). The mandible was most commonly involved (67.2%, n=509) of the cases. The incidence of paediatrics maxillofacial fractures in Uzbekistan region was high. The 6-18-year olds and boys were most commonly involved in maxillofacial paediatrics trauma. Mandibular fractures were the most common type of fracture. Safety programs should be instituted in Uzbekistan region to increase public awareness and to decrease morbidity resulting from paediatrics maxillofacial trauma.

**Keywords:** Paediatric, Maxillofacial area, Trauma, Mandibular fractures.

## Introduction

Head injuries of children are common, comprising more than half of all injuries sustained. The mortality and morbidity rates associated with traumatic head injury in children are high and the majority of deaths due to trauma in children are caused by brain injury<sup>1,2</sup>. Trauma is a leading cause of injury and death among the paediatric population. There is a pattern of facial fractures by age that is influenced by trends in the mechanism of injury and facial development. Cranial and central facial injuries are more common in toddlers and infants and mandibular fractures are more common

in adolescents and beyond. A large proportion of facial fractures were caused by fall<sup>4,5</sup>. The exponential rise in the incidence of facial fractures associated with skull fractures in children reflect the growth and development of the face to downward and forward direction that make it more susceptible to trauma. Paediatric facial fractures account for 25% of all maxillofacial injuries<sup>1,3,6,7,8,11</sup>.

The most prevalent cause of facial fractures in paediatric patients are accidental falls (58.2%) including falling on the floor when playing, falling from bed and stairs, and falling from height, followed by violence (12.7%), bicycle (10%), and motor vehicle accidents (8.2%). Sports injuries represented only 7.3% and others 3.6% [2,5] Nasal fractures were the most common (69.1%) and condyle was the most common site of mandibular fractures (63.2%). The mandible was the most common bone to fracture (65%) and the body of the mandible was the commonest site to be involved by fracture (27%). Only 10% of cases involved both jaws<sup>12</sup>. The zygomatic bone appeared to be the most common bone involved in mid-face fractures (45%)<sup>6</sup>.

---

### Corresponding Author:

**Musaev Shamshodbek Shuxratovich**

PhD Student (Department of Paediatric Maxillofacial Surgery), Tashkent State Dental Institute, 100077, Tashkent, Uzbekistan

Contact: +998934700753;

e-mail: shamshodbek@inbox.ru

The minimally displaced mandibular fracture is usually managed by a short course of maxilla-mandibular fixation (MMF) usually 21 days using elastics<sup>6,9,10</sup>. The use of open reduction and rigid internal fixation without maxillomandibular fixation also has obvious advantages for the management of children with multiple injuries. The aim of this study was to analyze the patterns of facial fractures in children up to eighteen years of age admitted at paediatric maxillofacial surgery department in Tashkent state dental institute, Tashkent city, Uzbekistan retrospectively in the last twelve years (2007-2018).

### Material and Method

All paediatric patients under 18 years admitted at the department of paediatric maxillofacial surgery of Tashkent state dental institute diagnosed with maxillofacial fracture were included in this study. The study was a twelve years retrospective study from January 2007 – December 2018. The data collected from the patients records included, age, gender, etiology, type of injuries.

**Inclusion Criteria:** All paediatric patients under 18 years admitted to paediatric maxillofacial surgery department with maxillofacial bone fractures.

### Exclusion Criteria:

1. Fractures involving the skull vault or frontal bone were not included in the study because children with cranial bone fracture are usually referred and managed by neurosurgery according to the hospital policy.
2. Soft tissue injuries were not included in the study as they are mainly treated at emergency departments without recording.
3. Patients with dental trauma also were not included in the study as they were either managed at emergency departments without recording or referred to pedodontist at dental center.

The study was conducted at the department of paediatric maxillofacial surgery at Tashkent state dental institute following the approval from research centre of Tashkent state dental institute and hospital ethical committee. Statistical analysis was performed using Statistical Package for Social Sciences (IBM SPSS), Version 25.0 for Windows 10.

## Results

The incidence of paediatric maxillofacial fractures in relation to age group: out of 757 children with maxillofacial bone fractures, 78.6% (n=595) were 6-18 years (school age) old and 21.4% (n=162) were under 5 years (pre-school) of age. It can be seen that children in the 6-18 years age group were more commonly involved with a peak incidence at <12 years. The mean age was 9.3±0.5 (SD) years, ranging from 2-18 years. Gender distribution showed that 86.1% (n=652) were males and 13.9% (n=105) were females with a male to female ratio of 6.2:1.

Falls were the most frequent mode of injury (46.9%, n=355), followed by sport (26.8%, n=203), bicycle accident (21.1%, n=160), and RTAs (5.2%, n=39). The mandible was most commonly involved (67.2%, n=509), followed by nasal 14.9% (n=113), dentoalveolar fractures (8.1%, n=61), zygoma (5.9%, n=45), maxilla (3.8%, n=29) fractures, respectively.

Cross-tabulation showed 6-18 years age group was more likely to have facial fractures in all sites. Association between gender and site of facial fracture by cross-tabulation showed male were more likely to have facial fractures in all sites than female shows the association between site of paediatric facial fractures and mode of injury. All sites of fracture except dentoalveolar were more likely to be due to falls. Dentoalveolar fracture was more likely to be due to sport.

## Discussion and Conclusions

The current study showed that males were more susceptible to facial trauma than females. More frequently young children sustain injuries from low-velocity forces than older children who are more likely to be exposed to high velocity forces<sup>12</sup>. In the present study, falls were the most prevalent etiological factor of facial fractures. This is in agreement with the reports by Lee (2009)<sup>5</sup> who stated that falls are a major health hazard.

The mandible was the most common site (67.2%) which is in agreement with the majority of studies which have reported the mandible as being the most common bone involved in paediatrics facial fractures<sup>13,14</sup>.

The twelve years incidence of paediatrics facial fractures in Uzbekistan region was higher in 6-18

year olds and boys were more commonly involved in maxillofacial paediatrics trauma. The most common etiological factor was falls. Mandibular fractures were the leading type of fracture. This data serves as a warning to maxillofacial surgeons to provide the proper and early management to prevent farther facial asymmetry or occlusion disturbances. It is also recommended that researchers should conduct future studies analysing the post-operative deformity for the managed children in the same hospital.

**Conflict of Interest:** None

**Ethical Clearance:** Taken from the Ethical Committee from the Institute.

**Source of Funding:** Nil

### References:

1. Arraj GP, Rossi-Fedele G, Dogramaci EJ. The association of overjet size and traumatic dental injuries- a systematic review and meta-analysis. *Dent Traumatol* 2019;35(4-5):217–32
2. da Costa Nardis A, Costa SAP, da Silva RA, Kaba SCP: Patterns of paediatric facial fractures in a hospital of São Paulo, Brazil: A retrospective study of 3 years. *Journal of Cranio-Maxillofacial Surgery* 2013, 41(3):226-229.
3. Flores MT, Onetto JE. How does orofacial trauma in children affect the developing dentition? Long-term treatment and associated complications. *Dent Traumatol* 2019;35(6):312–23.
4. Kim SH, Lee SH, Cho PD. Analysis of 809 facial bone fractures in a pediatric and adolescent population. *Arch Plast Surg* 2012;39:606–11.
5. Lee KH: Epidemiology of facial fractures secondary to accidental falls. *Asian Journal of Oral and Maxillofacial Surgery* 2009, 21(1-2):33-37.
6. Mong TK, Mustafa WMW, Sockafngam G: Paediatric Facial Fractures: One-year Survey of 23 Government Hospitals in Malaysia. *Asian Journal of Oral and Maxillofacial Surgery* 2007,19(1):30-33.
7. Shomurodov KE, Kuryazova ZK, Isomov MM, Mukimov II, Fayziyev BR. Improvement of surgical treatment of fractures of the inferior orbit wall. *J Stomatologiya* 2017;2:78-80. Available from URL: <https://www.elibrary.ru/item.asp?id=37073416>
8. Shomurodov KE, Musaev SS, Olimjonov KJ. Influence of immobilization method on periodontal tissues during treatment fractures of the lower jaw in children. *Journal of oral medicine and craniofacial research* 2020;1(1):8-11. <http://dx.doi.org/10.26739/2181-0966-2020-1-1>
9. Yakubov RK, Mukhamedov IM, Khodzhimetov AA and etc. Comprehensive diagnosis and treatment of fractures of the lower jaws in children: Method. recommendations for practitioners dentists general. *Pract., Maxillofacial surgeons, masters.* Tashkent, 2009. 15 p.
10. Yakubov RK, Sharipova AU, Fayziyev BR, Yakubova NA, Yakubov RR Substantiation of pharmacological correction in the complex treatment of mandibular fractures and their early complications in children. *Stomatologiya* 2008,3-4:49-51.
11. Zhou, Wei, et al. Analysis of pediatric maxillofacial trauma in North China: Epidemiology, pattern, and management. *Injury* 2020;51(7):1561-1567. <https://doi.org/10.1016/j.injury.2020.04.053>
12. Zimmermann C, Troulis M, Kaban L: Pediatric facial fractures: recent advances in prevention, diagnosis and management. *International journal of oral and maxillofacial surgery* 2005,34(8):823-833.
13. Ferreira PC, Amarante JM, Silva PN, Rodrigues JM, Choupina MP, Silva AC, Barbosa RF, Cardoso MA, Reis JC: Retrospective study of 1251 maxillofacial fractures in children and adolescents. *Plastic and reconstructive surgery* 2005,115(6):1500-1508.
14. Scariot R, Oliveira IAd, Passeri LA, Rebellato NLB, Müller PR: Maxillofacial injuries in a group of Brazilian subjects under 18 years of age. *Journal of applied oral science* 2009,17(3):195-198.



# Effect of Blood Groups and Complications on Orofacial Measurements of B Thalassemia Adult Patients

Nada Hashim Mohammed<sup>1</sup>, Nawal Mustafa Abdullah<sup>2</sup>, Riad Altaee<sup>3</sup>

<sup>1</sup>Lec./MB,ChB, MSc Anatomy, Department of Anatomy/Al Zahraa College of Medicine, University of Basrah,  
<sup>2</sup>Assist- Prof/MB,ChB, MSc, PhD Anatomy, Department of Anatomy/Al Zahraa College of Medicine, University of Basrah,  
<sup>3</sup>Assistant Prof/B.D.S, College of Dentistry/University of Basrah

## Abstract

**Background:**  $\beta$ -thalassaemia is a common hereditary disorders in Iraq and worldwide .with different treatment schemes,, including blood transfusion, iron chelation and splenectomy, patients with B thalassemia may develop different skeletal changes. Limited studies link these complications with orofacial changes, This study aimed to evaluate the orofacial dimensions in  $\beta$ -thalassemia patients with age, gender, blood groups, splenectomy and cholecystectomy and to assist surgeons for planning their future intervention.

**Method:** This study was conducted on 130  $\beta$ -thalassemia patients of both gender,,and two age categories (20-30 yrs), & (21-40 yrs), five orofacial measurements (face,eyes,nose,mouth and ears) and sixteen parameters were measured and calculated for differences,P value is estimated,data analysis were done by using Chi square test and SPSS version 20

**Results:** Significant findings were found for mandibular width and mouth width at older age group (31-40 years), the nasal width and ear height are more in male, patients with splenectomy have significance for lower 1/3 face and ear width. Cholecystectomy increase eye length measurments and ear height but for blood groups the  $P > 0.05$

**Conclusions:** Orofacial bone changes are pronounced in  $\beta$ -thalassaemia with distinct findings regarding sex dimorphism, older are more prone to have variations, earlier splenectomy is advisable,cholecystectomy is better choice for symptomatic patients, blood groups have no significance.

**Keywords:**  *$\beta$ Thalassemia,,Blood groups, Orofacial measurments, Complications.*

## Introduction

Thalassemia are group of single gene inherited hematological disorders caused by deficiencies in the synthesis of hemoglobin chains that cause haemolytic anemia<sup>[1]</sup>.  $\beta$ -thalassemia major is the most severe form leading to severe anemia in infancy or childhood and

used to be life threatening in absence of regular red cell transfusions<sup>[2]</sup>. Various studies found that patients with blood group O are more risky to develop  $\beta$  thalassemia<sup>[3,4]</sup>. The common symptoms of the disease include severe anemia, poor growth, delayed sexual maturation,splenomegaly and gall bladder bilirubin stones, if patients are symptomatic, they may require laproscopic cholecystectomy,could be at the same time as the splenectomy.<sup>[5-8]</sup>

---

### Corresponding Author:

**Nawal Mustafa Abdullah**

Assist- Prof/MB,ChB, MSc, PhD Anatomy, Department of Anatomy/Al Zahraa College of Medicine, University of Basrah  
e-mail: nawal.abdullah@uobasrah.edu.iq

Patients with  $\beta$  thalassemia commonly have skeletal abnormalities including limbs,vertebral column,skull and bones of the face, commonly called squirrel –like face<sup>[9]</sup>. Theorofacial bone changes are the results of ineffective erythropoiesis, the bones become thinner with pathological fractures may occur due to overexpansion

of the bone marrow and extra medullary region and this is frequently noticed in patients who receive insufficient or irregular blood transfusions<sup>[10,11]</sup>. Patient survival depends on regular blood transfusions and iron chelating therapy, In spite of being an effective cure but there are many serious associated long-term problems. Iron toxicity (hemosiderosis) will lead to hepato splenomegaly which end with organ damage, surgical intervention and impaired growth<sup>[12,13]</sup>.

Different orofacial dimensions include face, eyes, nose, mouth and ears of thalassemia patients have significant differences from normal individuals which is documented in many studies<sup>[14,15]</sup> Although B thalassemia is a leading health problem in Basrah, southern of Iraq but limited published data were available on orofacial measurements therefore the aim of the study is to evaluate the effect of age, gender, blood groups, splenectomy and cholecystectomy on orofacial bone changes and determine their clinical outcome in thalassemia patients.

### Material and Method

The present study was conducted during the period from August 2019 to March 2020, data obtained from a total number of 130 adult B Thalassemia Major Iraqi patients from Basrah city (72 female and 58 male) who attended to the thalassemia center for Hereditary Blood diseases at Basrah Maternity and Child Hospital irrespective to their social or educational backgrounds. All patients were diagnosed previously based on hemoglobin electrophoresis or high-performance liquid chromatography and submitted to frequent blood transfusions. The age ranged between 20-40 years. Patients were divided according to age into two groups, 21-30 age group, and 31-40 age group. Patient's data

including age, sex, weight (in kg), and height (in cm), were obtained and evaluated. All patients receive different treatments and blood transfusion.

Verbal consent obtained from each participant in this study and the approval of the Ethical Committee of Al Zahraa Medical College/University of Basrah and Centre for Human Development of Basrah Health Authority (Ref. No. 261 at 13/5/2019) was obtained. The standard instruments used in this study were calipers and measuring tape, Fig. 1 & 2

Surface landmarks were marked on the face before taking the standard anthropometric measurement according to Farkas method<sup>[16]</sup>. The head orientation was achieved by positioning the head in Frankfurt horizontal plane aligned parallel to the floor. Three anatomical landmarks determined the facial midline: the nasion, the subnasal, and the gnathion. "Fourteen linear and two angular measurement taken, these are:

1. Face: Face width (zy- zy), Face height (n- gn), Upper face height (n- sto), Maxillary depth (t- sn), Mandibular depth (t- gn).
2. Nose: Nose width (al- al), Nose height (n- sn), Nasal tip protrusion (sn- prn)
3. Eyes: Biorbital width (ex-ex), Intercanthal distance (en- en), Palpebral fissure length (en- ex).
4. Mouth: Mouth width (ch- ch), Lower lip height (sto- ls), Upper lip height (sn- sto).
5. Ears: Ear width (par- pa), Ear length (sa- sba).

Facial measurements are taken in millimeters.

A comprehensive analysis of data was achieved by using SPSS version 20 and Chi square test



**Fig. 1: The vernia and measuring tape**



**Fig. 2: Orofacial measurments**

**Results**

A total number of 130 B - thalassemia adult patients of both gender (72 male/58 female; 1.2/1),age range from 20 to 40 years were enrolled in this study for estimating orofacial measurments (OFM).

Significant differences were found between different age groups regarding face, ear, eye, and nose, the mandibular depth (t-gn) show high results at age group 31-40 years (p = 0.022) and the mouth width (ch-ch) show significance at older age group also (p = 0.041). Table 1.

**Table 1: Relation of age to OFM of B thalassemia patients**

OFM		Age Group		
		20-30	31-40	
Face	Face width (zy-zy)	96.1	99.3087	0.129
	Facial height (n-gn)	107.1111	107.8261	0.801
	Upper facial Morphological height (n-sto)	68.7944	72.3957	0.099
	Maxillary depth (t-sn)	117.1278	118.9174	0.505
	Mandibular depth (t-gn)	128.0472	135.7652	0.022
Nose	Nasal width (al-al)	34.9139	35.4783	0.527
	Nasal height (n-sn)	48.0222	51.3783	0.083
	Nasal length (sn-pr n)	14.7778	17.2391	0.136
Mouth	Mouth width (ch-ch)	42.8556	45.6696	0.041
	Lower third face height (sn-gn)	59.0222	58.0826	0.616
Eye	Outer eye space (ex-ex)	90.8333	91.1261	0.94
	Inner corner eye space (en-en)	33.3306	34.0174	0.344
	Eye length (en-ex)	30.6806	31.5	0.373
Ear	Ear width (pra-pa)	36.6861	37.1261	0.785
	Ear Height (sa-sba)	54.9417	56.4917	0.367

P<0.05 is significant

No significant differences were detected between male and female in orofacial measurement, except for nasal width (al-al), and ear height (sa-sba) which show

higher results in male patients ( $p = 0.019$ ), ( $p = 0.011$ ) respectively Table 2.

**Table 2: Relation of Sex and Orofacial measurements of B thalassemia patients**

OFM		Sex		P-value
		Female	Male	
Face	Face width (zy-zy)	96.5364	98.3846	0.377
	Facial height (n-gn)	105.9182	109.2577	0.228
	Upper facial Morphological height (n-sto)	69.0091	71.7077	0.211
	Maxillary depth (t-sn)	115.2303	121.1192	0.022
	Mandibular depth (t-gn)	129.1515	133.4731	0.199
Nose	Nasal width (al-al)	34.2485	36.2577	0.019
	Nasal height (n-sn)	48.5212	50.3577	0.338
	Nasal length (sn-pr n)	16.3364	14.9769	0.405
Mouth	Mouth width (ch-ch)	43.5515	44.4615	0.509
	Lower third face height (sn-gn)	57.3091	60.3654	0.093
Eye	Outer eye space (ex-ex)	89.7	92.5308	0.455
	Inner corner eye space (en-en)	33.0182	34.3346	0.062
	Eye length (en-ex)	30.7303	31.3423	0.498
Ear	Ear width (pra-pa)	37.2667	36.3385	0.557
	Ear Height (sa-sba)	53.6942	57.8962	0.011

$P < 0.05$  is significant

Relation of different blood groups and orofacial parameters were insignificant for all parameters (face, nose, ear, eyes and ears) as shown in Table 3.

**Table 3: Comparison between blood groups of B thalassemia patients and orofacial measurements**

OFM		Blood group			P-value
		A	B	O	
Face	Face width (zy-zy)	97.4048	97.7941	96.9381	0.947
	Facial height (n-gn)	107.9714	108.3	106.0714	0.775
	Upper facial Morphological height (n-sto)	71	71.4059	68.419	0.464
	Maxillary depth (t-sn)	116.3905	118.4529	118.7524	0.716
	Mandibular depth (t-gn)	130.7143	130.6	131.7667	0.952
Nose	Nasal width (al-al)	34.1095	36.4353	35.1048	0.096
	Nasal height (n-sn)	49.2857	50.5059	48.4238	0.685
	Nasal length (sn-pr n)	16.9143	14.4353	15.6143	0.472
Mouth	Mouth width (ch-ch)	43.6952	43.9118	44.2429	0.945
	Lower third face height (sn-gn)	58.6524	57.7588	59.3857	0.778
Eye	Outer eye space (ex-ex)	89.5429	92.6412	90.981	0.808
	Inner corner eye space (en-en)	33.6762	33.2059	33.8381	0.768
	Eye length (en-ex)	31.3571	31.7588	30.0286	0.253
Ear	Ear width (pra-pa)	36.9762	36.3059	37.1857	0.9
	Ear Height (sa-sba)	55.9286	55.7118	55.029	0.897

$p > 0.05$  NS

In evaluating the effect of splenectomy on OFM, significant difference was detected for the lower third face height (sn-gn)  $p=0.04$  and ear width (pra-pa)  $p=0.053$ . Table 4.

**Table 4: Relation of OFM of B thalassemia patient and splenectomy**

OFM		Splenectomy		P-value
		-ve	+ve	
Face	Face width (zy-zy)	97.6	97.0	0.779
	Facial height (n-gn)	107.3	107.5	0.926
	Upper facial Morphological height (n-sto)	69.9	70.5	0.78
	Maxillary depth (t-sn)	118.8	116.8	0.442
	Mandibular depth (t-gn)	132.6	129.4	0.337
Nose	Nasal width (al-al)	35.6	34.6	0.226
	Nasal height (n-sn)	50.3	48.3	0.283
	Nasal length (sn-prn)	14.3	17.3	0.066
Mouth	Mouth width (ch-ch)	44.4	43.4	0.454
	Lower third face height (sn-gn)	56.9	60.6	0.04
Eye	Outer eye space (ex-ex)	93.0	88.6	0.244
	Inner corner eye space (en-en)	33.7	33.5	0.706
	Eye length (en-ex)	31.1	30.8	0.74
Ear	Ear width (pra-pa)	38.3	35.3	0.053
	Ear Height (sa-sba)	56.7	54.3	0.159

$p < 0.05$  = Significant

Table 5 show significant difference for cholecystectomy and orofacial measurements regarding eye length (en-ex) ( $p=0.000$ ) and ear height ( $p= 0.019$ ).

**Table 5: Relation of cholecystectomy to OFM of B thalassemia patients**

OFM		Cholecystectomy		P-value
		-ve	+ve	
Face	Face width (zy-zy)	97.8	92.1	0.118
	Facial height (n-gn)	107.8	102.8	0.31
	Upper facial Morphological height (n-sto)	70.6	65.8	0.215
	Maxillary depth (t-sn)	118.0	116.0	0.665
	Mandibular depth (t-gn)	131.3	129.0	0.704
Nose	Nasal width (al-al)	35.1	36.0	0.545
	Nasal height (n-sn)	49.6	46.3	0.333
	Nasal length (sn-pr n)	15.9	13.6	0.422
Mouth	Mouth width (ch-ch)	44.1	42.5	0.53
	Lower third face height (sn-gn)	58.9	56.4	0.452
Eye	Outer eye space (ex-ex)	91.8	81.9	0.142
	Inner corner eye space (en-en)	33.7	32.6	0.372
	Eye length (en-ex)	31.5	26.1	0.000
Ear	Ear width (pra-pa)	37.4	31.1	0.021
	Ear Height (sa-sba)	56.1	49.2	0.019

$p > 0.05$  NS

## Discussion

The ultimate cure of transfusion dependent thalassemia is bone marrow transplantation, but this is very costly procedure for the majority of patients, their survival, therefore, depends on regular blood transfusions and iron chelating drugs. It was found that severe anemia, frequent blood transfusion, iron overload and chelation drug toxicities and bone changes are common complications of this hereditary disease [17,18]. The pathogenesis of skeletal changes is still unclear in spite of the enhanced treatment, patients used to have derange in bone mineral turnover with raised resorption rates and inhibition of osteoblast action which result in diminished bone mineral density (BMD) clearly evident as osteoporosis in the vertebrae, skull and face [13,19].

The results of the current study showed that the number of male affected by thalassemia are higher than females (M :1.3\ F :1). However the differences were not significant. Our study is consistent with a study of Baghianimoghadam *et al.* 2011, and Hannan *et al.* 2018 [20,21], bone changes are more common in older age group, (31-40 years old) for mandibular depth (135.76mm) and mouth width (45.66mm) as in Table 1. Furthermore the study found that the relation of sex and orofacial measurements were significant in patients with B thalassemia, the facial variations of nasal width (36.25) and ear height (57.89) are higher in male than female Table 2.

Bone changes in adult thalassemia patients can be explained on the bases that chronic anemia increases erythropoietin secretion, lead to bone marrow expansion and thinning of bony cortices beside overloaded iron interferes with growth of osteoid and deposited in hydroxyapatite crystals thus effecting the normal bone mineralization furthermore desferoxamine (iron chelator) prevents DNA synthesis, proliferation, and maturing of fibroblasts and osteoblasts which enhance the skeletal deformities in thalassemia [22,23]. Different blood groups have no significant effect in changing craniofacial parameters as shown in table 3.

Splenectomy result in minor changes on orofacial parameters in thalassemia patients, differences were seen for lower third face (60mm) and ear width (35.3mmL) when compared with those without splenectomy as in Table 4. Spleen is most commonly affected organ in B thalassemia due to excessive destruction of abnormal red blood cells, extra medullary hematopoiesis, and transfusion overload. The splenectomy definitely reduce

blood need therefore improve hemoglobin level but seems to have prolonged orofacial changes [24,25]. In severe cases bone changes could be minimized when splenectomy is done as early as possible.

**Cholelithiasis (gallstones) is well known complication in patients with thalassemia major: (TM)**. Several possible explanations for this observation, including older age, high degree of ineffective erythropoiesis, whenever symptoms found, cholecystectomy must be done with follow up to prevent complications like obstructive jaundice and cholangitis [26]. Table 5 showed significant effect of cholecystectomy on orofacial measurements regarding eye length (p=0.00) and ear height. (p=0.019).

Further studies may assist in better understanding of the pathogenetic mechanism underlying bone anomalies in B thalassemia patients and it is needed to develop useful treatment therapy like use of bisphosphonate in early osteoporosis which is an effective regime to minimize the severity of skeletal complications, new-generation of iron chelators may reduce the negative effects of deferoxamine on bone metabolism. and to improve the nutritional, hormonal deficits with the help of physical training programs.

## Conclusion

The screening for carriers, premarital regulatory rules and counseling programs, can help in decreasing the incidence rate and complications although a high prevalence of thalassemia in Basrah southern Iraq was observed, Results had shown sex dimorphism, older age groups are prone to have obvious bony changes, earlier splenectomy is advisable in severe cases, cholecystectomy is done whenever symptoms are found, ABO blood groups have no remarkable changes on OFM.

**Acknowledgment:** The authors would like to thank all doctors and medical staff of Thalassemia center for Hereditary Blood diseases at Basrah Maternity and Child Hospital for their great help and support during data collection.

**Source of Funding:** Self funding

**Conflict of Interest:** No conflict of interest.

## References

1. Sacide Karakas1, Ayfer Metin Tellioglu1, Mehmet Bilgin2, Imran Kurt Omurlu3, Sercin Caliskan2,

- Salih Coskun4.” Craniofacial Characteristics of Thalassemia Major Patients” *Eurasian j of medicine*, 2016;48:204-8.
2. Ghanshyam Gupta1, Manali Arora2” Association of orofacial features of  $\beta$  thalassemia major patients ” *J. Evolution Med. Dent. Sci./Vol. 7/Issue 30/2018*;eISSN- 2278-4802, pISSN- 2278-4748/
  3. Pranoti A. Sinha<sup>1\*</sup>, Sachin H. Mulkutkar<sup>1</sup>, J. B. Bhavani” Study of distribution of ABO blood groups in  $\beta$ -thalassemia patients<sup>2</sup>” *International Journal of Research in Medical Sciences* 2017;5(8):3479-3483
  4. Sarah M. Mahmoud Marbut\*, Maha A. Hamdi\*\*, AbdulhadiM.Jumaa\*\*, Basma Abbas Salman”Distribution of ABO blood groups in beta thalassemia patients dependent on blood transfusion In Bagdad city” *J of madentAlelem college* “2018; Vol 10 No 22
  5. Alireza Jafari Naimi, Samaneh Bolourian, 2 Mahsa Mohammadzadeh, 3 Mona Farahmand, 4 Fatemeh Ghanbari5 and Sadegh Samiee6; Investigating the relationship between major thalassemia diseases with anthropometric sizes head and facial soft tissue” *Bioscience Biotechnology Research communications* 10(2): 233-240 (2017)
  6. Abu Alhajja ESJ, Hattab FN, Al Omari MAO. Cephalometric measurements and facial deform in subjects with  $\beta$ -thalesaemia major. *Eur J Orthod* 2002; 24: 9-19.
  7. Raffaella Origa<sup>1</sup>, Renzo Galanello<sup>1</sup>, Lucia Perseu<sup>2</sup>, Dario Tavazzi<sup>3</sup>, M. Domenica Cappellini<sup>3</sup>, Laura Terenzani<sup>4</sup>, Gian Luca Forni<sup>4</sup>, Giovanni Quarta<sup>5</sup>, Tatiana Boetti<sup>6</sup>, Antonio Piga<sup>6</sup> Cholelithiasis in thalassemia major *European Journal of Haematology* ISSN 0902-4441
  8. Weledji EP. Benefits and risks of splenectomy. *Int J Surg* 2014; 12:113–119.
  9. Toman HA, Nasir A, Hassan R, Hassan R. Skeletal, dentoalveolar, and soft tissue cephalometric measurements of Malay transfusion-dependent thalassemia patients. *Eur J Orthod* 2011; 33: 700-4.
  10. Bushra Moiz a, Aysha Habiba, Sobiya Sawanib, Ahmed Raheema, Bilal Hasanc and Manesh Gangwanic Anthropometric measurements in children having Transfusion dependent beta thalassemia “*Hematology*, 2018 Vol. 23, No. 4, 248–252, <https://doi.org/10.1080/10245332.2017.1396044>.
  11. Mahachoklertwattana, V. Sirikulchayanonta, A. Chuansumrit et al., “Bone histomorphometry in children and adolescents with  $\beta$ -thalassemia disease: iron-associated focal osteomalacia, ” *Journal of Clinical Endocrinology and Metabolism*, vol. 88, no. 8, pp. 3966–3972, 2003.View at: [Publisher Site](#)|
  12. Valizadeh N, Farrokhi F, Alinejad V, et al. Bone density in transfusion dependent thalassemia patients in Urmia Iran. *Iran J Ped Hematol Oncol*. 2014;4(2):68–71
  13. Hashemi A, Ghilian R, Golestan M, et al. The study of growth in thalassemic patients and its correlation with Serum ferritin level. *SSUJ*. 2011;1(4):147–151.
  14. F Amini, A Jafari L Eslamian S, Sharifzadeh; A cephalometric study on craniofacial morphology of Iranian children with beta-thalassemia major; 2007 (*Dentistry, Oral Surgery & Medicine*)<https://doi.org/10.1111/j.1601-6343.2007.00380.x>.
  15. Bassimitci S, Yücel Eroglu E, Akalar M. Effects of thalassemia major on components of the craniofacial complex *Br J Orthod* 1996; 23: 157-162.
  16. Farkas LG, Kolar JC, Munro IR. Craniofacial disproportions in Apert’s syndrome: an anthropometric study. *Cleft Palate J*. 1985; 22:253–65.
  17. Tahir H, Shahid SA, Mahmood KT. Complications in thalassemia patients receiving blood transfusion. *J Biomed Sci Res*. 2011;3(1):339-46.
  18. Haidar R, Musallam KM, Taher AT. Bone disease and skeletal complications In patients with beta thalassemia major. *Bone*. 2011; 48(3):425–432.17. [15]
  19. Porter J, editors. Guidelines for the management of transfusion dependent thalassaemia (TDT). Nicosia (CY): Thalassemia International Federation; 2014.
  20. Baghianimoghadam B, Heshmati H. Health related quality of life in children with thalassemia assessed on the basis of SF -20 questionnaire in yazd, Iran: Ascae -control study center. *Eur J Public Health* 2011;19:165-9.
  21. Hanan Jassim Hammodi Tahanaa Abdul Mahdi Mokif, Hassan Jassim Al Harbi Mohanad Salam Majeed. Evaluation of some Biochemical and Endocrine profile In transfusion dependent Iraqi major  $\beta$ -thalassemia patients; *Iraqi Journal of Science*, 2017, Vol. 58, No. 2A, pp: 639-645

22. Cappellini MD, Cohen A, Porter J, et al. .Guidelines in the managements of transfusion dependent thalassemia; Thalassaemia International Federation; ch2 2014.
23. Hassan K, Younus M, Ikram N, Naseem L, Zaheer HA. Red cell Alloimmunization in repeatedly transfused thalassemia major patients. *Int J Pathol.* 2004;2(1):16-9.
24. Saleh Hatem A, Alkhateep Yahia M, Mohammed Ashraf N; Role of splenectomy in thalassemic patients: 2018| Volume: 31 |Issue Number: 1| Page: 118-125
25. Ikramullah Khan Akhtar, Muhammad Ashraf, and Khalid Mukhtar Surgical outcome of splenectomy in Thalassemia major in children, *Pak J Med Sci*;2016 Mar-Apr; 32(2): 305–308
26. Abdulkareem A. Jasim<sup>1</sup>, Israa Mustafa Salih ALMusawi<sup>2</sup>, \*, Zahraa Alaa Abdul Zhara<sup>3</sup> Frequency of Cholelithiasis in Sickle Cell Disease and Thalassemic Patients at Hereditary Blood Diseases Center in Karbala Teaching Hospital for Children *IJPPR* 2018 Vol.:11, Issue:3.



# Prevalence of Oral Maxillary and Mandibular Tori among Outpatients Attending Dental Collage in Basra Governorate Southern of Iraq

Nadia Azzam Al-Shareeda<sup>1</sup>, Majed Mohamed Refaat<sup>2</sup>, Abdullah M. Hussain<sup>3</sup>

<sup>1</sup>Assistant Lecturer, Pedodontics, Orthodontics and Preventive Dentistry, College of Dentistry, University of Basrah, Basrah, Iraq, <sup>2</sup>Assistant Lecturer, Prosthetic Dentistry, <sup>3</sup>Assistant Lecturer, Restorative and Aesthetic Dentistry, College of Dentistry, University of Basrah, Basrah, Iraq

## Abstract

The objectives of the study is the assessment of torus palatinus (TP) prevalence as well as torus mandibular is (TM) among different gender and age groups. Seven hundred and fifty (750) out door patients (380 male and 370 female) were tested for the tori presence or absence at dentistry collage in Basrah city between January 2019 and June 2019. Sex, gender and location factors were evaluated. The prevalence rate of TP was 4.73% for male and 5.13% for female, and the prevalence rate of TM was 2.36% for male and 3.24% for female. In females, TP prevalence was more compared to males. The TP incidence more commonly in middle aged persons, While the TM more commonly in older persons.

**Keywords:** Exostosis, Prevalence, Tori.

## Introduction

Tori arenon-pathologic bony exostosis that are consist of dense cortical bone covered by thin mucosa with poor vascularization<sup>1</sup>. Thin mucosal membrane covering the tori easily traumatized by removable dental prosthesis unless adequate relief is provided. Surgical removal is mandatory if large exostosis cause trauma or interference with artificial removable replacement insertion or with its function<sup>2</sup>. TP mostly found along the mid suture of the hard palate, and TM located in areas of premolar and canine at the mandible lingual aspect, usually bilateral<sup>3</sup>. TP has four shapes flat, nodular, lobular and spindle<sup>4,5</sup>. The etiology of both tori has been subjected multifactorial due to genetic, mastication, environmental and continued growth<sup>6,7</sup>. TP has been found more common in females, while TM more frequently in males. Tori usually are noticed in young and middle age adults<sup>8</sup>.

**Objectives:** The study aimed to investigate the location and prevalence of TP and TM. Also determine the correlation between current findings and population gender and age.

## Materials and Method

Patients of seven hundred and fifty (380 male and 370 female) randomly selected outdoor admitted at Dentistry College/Basrah University between January to June 2019. Detailed questioner sheet prepared for the study, subjects were stratified depend on their age into 5age categories: (20-29, 30-39, 40-49, 50-59, ≥60 years).To prevent inter examiner bias, one author clinically examine all the subjects for tori absence or presence through clinical palpation and inspection, the subject who has questionable tori was excluded. Raised bony exostosis located in the hard palatal midline defined as torus palatinus, raised bony exostosis situated in mandibular lingual aspect defined as being torus mandibularis.

The collected data were inserted in a computerized spreadsheet (Microsoft Excel 2013) and analyzed by SPSS version 20.

## Results

Among the 750 male and female studied subjects, 58 person found having tori with a prevalence rate of 7.73% as shown in table 1. TP was presented in 37

subjects with a prevalence rate of 4.93% the males were 18 (4.73%) and the females were 19 (5.13%), whereas TM was detected in 21 subjects expressing 2.8 % prevalence rate, males were 9 (2.36%) and the females were 12 (3.24%). Table 2 summarize this distribution according to sex.

**Table 1: Tori Prevalence in different groups**

Age Groups	M+F (Total)	M+F with tori	% Prevalence
20-29	175	9	5.14
30-39	170	15	8.82
40-49	175	19	10.85
50-59	150	10	6.66
≥ 60	80	5	6.25
<b>Total</b>	<b>750</b>	<b>58</b>	<b>7.73</b>

**Table 2: Tori distribution in male and female**

Tori	Male (%)	Female (%)	Total (%)
Torus palatinus	18 (4.73)	19 (5.13)	37 (4.93)
Torus mandibularis	9 (2.36)	12 (3.24)	21 (2.8)
<b>Total</b>	<b>27 (7.1)</b>	<b>31 (8.37)</b>	<b>58 (7.73)</b>

Most patients located at 40-59 years age group and tori incidence decreased over the 60 years old. The prevalence in each age groups seen in table 3.

**Table 3: Prevalence of TP and TM based on gender and age**

Age groups (years)	Torus palatinus	Torus palatinus	Torus palatinus	Torus mandibularis	Torus mandibularis	Torus mandibularis
	Male (%)	Female (%)	Total (%)	Male (%)	Female (%)	Total (%)
20-29	3 (16.66)	3 (15.78)	6 (16.21)	1 (11.11)	2 (16.66)	3 (13.28)
30-39	4 (22.22)	7 (36.84)	11 (29.72)	2 (22.22)	2 (16.66)	4 (19.4)
40-49	8 (44.44)	6 (31.57)	14 (37.83)	2 (22.22)	3 (25)	5 (23.80)
50-59	2 (11.11)	3 (15.78)	5 (13.51)	1 (11.11)	4 (33.33)	5 (23.80)
≥ 60	1 (5.55)	0 (0)	1 (2.70)	3 (33.33)	1 (8.33)	4 (19.4)
<b>Total</b>	<b>18 (100)</b>	<b>19 (100)</b>	<b>37 (100)</b>	<b>9 (100)</b>	<b>12 (100)</b>	<b>21 (100)</b>

**Discussion**

Tori of maxilla and mandible were detected as bony outgrowths slowly is growing at palatal midline and mandibular lingual aspect<sup>9,10</sup>. A Jordanian study had been reported that no significant difference in the prevalence between male and female among Jordanian population 29.8%<sup>11</sup>. The racial divergence or ethnic groups may cause the tori prevalence varies among studies<sup>12,13</sup>. An Indian study showed torus prevalence being 9.5% in the palate and commonly occurred more in women in comparison to men<sup>14</sup>. Actually, no clear interpretation for such variance between sexes was identified, where genetics might propose being a fundamental contributing factor.

A significant finding of our study among this population was that TP (4.93 %) was more frequently seen than TM(2.8%).

Tori occurrence peak at third decade of life as mentioned by other observations<sup>15,16</sup>, our investigation illustrate the occurrence peak for both tori at fifth decade of life. With age, tori prevalence starts to increase until reaching the peak at 40-49 years old. After that the occurrence of both tori trend to decrease over the 50 year old, this is agreed with the findings of many authors<sup>16,17,18</sup>. Functional factors affect this variation, after teeth extraction the torus palatinus regression noticed. Eggen and Natvig<sup>19</sup> showed same findings in Norwegians and summarized that prevalence decreased over the fifty years was attributed to remaining teeth numbers decrease, and also they associated the high TM prevalence with increasing the stress of mastication. Both tori was more common in female (8.37 %) as compared to male (7.1 %).

## Conclusion

- a. More occurrence of tori in female compared to male.
- b. Both tori prevalence is low at such region, and prevalence of TP is higher than the prevalence of TM.
- c. The incidence to tori increased with age up to 50 years old.

**Source of Funding:** This study is self-funded

**Disclosure/Conflict of Interest:** The authors declare no conflict of interest.

**Ethical Clearance:** Ethical clearance from the institutional ethical committee obtained for the study.

## References

1. Castro Reino O, Perez Galera J, Perez Cosio Martin J, Urbon Caballero J. Surgical techniques for the exeresis of torus, both palatal and mandibular. We observe indications, contra indications and complications as well as enumerate all the right events to realize correctly the said techniques. [Surgery of palatal and mandibular torus]. *Rev Actual Odontoestomatol Esp.* 1990; 50:47-50, 53-6.
2. Woo JK. Torus palatinus. *Am J Phys Anthropol* 1950;8:81- 111.
3. Neville BW, Damm DD, Allen CM, Bouquot JE. In: *Oral and Maxillofacial Pathology*, 2nd edn. Philadelphia: WB Saunders 2002:20–1.
4. Eggen S, Natvig B, Gasemyr J. Variation in torus palatinus prevalence in Norway. *Scand J Dent Res* 1994;102:54-59.
5. Reichart PA, Neuhaus F, Sookasem M. Prevalence of torus palatinus and torus mandibularis in Germans and Thai. *Community Dent Oral Epidemiol* 1988;16:61-64.
6. Suzuki M, Sakai T. A familial study of torus palatinus and torus mandibularis. *Am J Phys Anthropol* 1960;18:263-72.
7. Topazian DS, Mullen FR. Continued growth of a torus palatinus. *J Oral Surg* 1977;35:845-6.
8. Reichart PA, Neuhaus F, Sookasem M. Prevalence of torus palatinus and torus mandibularis in Germans and Thais *Commun Dent Ora Epidemiol* 1988;16:61-4.
9. Stephen T.S.; Robert C.F.; Leslie F Principle and Practice of Oral Medicine; W.B. Saunders Company: Philadelphia, 1984; pp 476-477.
10. Carl O.B. *Current Clinical Dental Terminology*; The C.V. Mosby Company: Saint Louis, 1974; pp 411-412.
11. Al Quran FA, Al-Dwairi ZN. Torus palatinus and torus mandibularis in edentulous patients. *J Contemp Dent Pract.* 2006 May 1; 7(2):112-9.
12. Gorsky M, Bukai A, Shohat M. Genetic influence on the prevalence of torus palatinus. *Am J Med Genet* 1998;75: 138-40.
13. Bouquot IE, Gundlach KKH. Oral exophytic lesions in 23,616 white Americans over 35 years of age. *Oral Surg Oral Med Oral Pathol* 1986;62:284-91.
14. Shah DS, Sanghavi SJ, Chawada JD, Shah RM. Prevalence of torus palatinus and torus mandibularis in 1000 patients. *Indian J Dent Res* 1992;3:107-10
15. Kolas, S.; Halperin, V.; Jefferis, K.; Huddleston, S.; Robinson, H. B. The Occurrence of Torus Palatinus and Torus Mandibularis in 2,478 Dental Patients. *Oral Surg. Oral Med. Oral Pathol.* 1953; 6: 1134-1141.
16. Wandee A; Aree J; Somporn S Torus Palatinus and Torus Mandibularis in a Thai Population. *Science Asia* 2002; 28: 105-111.
17. Bruce, I.; Ndanu, T. A.; Addo, M. E. Epidemiological Aspects of Oral Tori in a Ghanaian Community. *Int. Dent. J.* 2004; 54: 78-82.
18. Dosumu O.O.; Arotiba J.T.; Ogunyinka A.O. The Prevalence of Palatine and Mandibular Tori in a Nigerian Population. *Odonto- Stomatologie Tropicale* 1998; 6-8.
19. Eggen, S.; Natvig, B. Variation in Torus Mandibularis Prevalence in Norway. A Statistical Analysis Using Logistic Regression. *Community Dent. Oral Epidemiol.* 1991; 19: 32-35.

# Appraisal of Genotoxicity and Cytotoxicity of Depakine<sup>®</sup> and/or Epanutin<sup>®</sup> in Bone Marrow Erythrocytes and Hepatocytes of Male Albino Mice by Comet and Micronucleus Assays

Nagla Zaky Ibrahim El -Alfy<sup>1</sup>, Amany Ibrahim Alqosaibi<sup>2</sup>,  
Mahmoud Fathy Mahmoud<sup>3</sup>, Ayman Mohammad Abdullah<sup>4</sup>

<sup>1</sup> Professor of Cytogenetics, <sup>2</sup> Assistant Professor of Molecular genetics, Department of Biology, College of Science, University of Imam Abdulrahman bin Faisal, P. O. Box 1982, Dammam, 31441, Saudi Arabia, <sup>3</sup> Professor of Cytology and Histology, <sup>4</sup> PhD Researcher, Department of Biological and Geological Sciences, Faculty of Education, Ain Shams University, Cairo, Egypt

## Abstract

**Background:** Depakine and epanutin are widely used in the treatment of a variety of diseases. A special attention should be given for their deleterious impacts on genetic material of patients.

**Method:** Sixty-five male albino mice were separated into four main sections. First is control injected with normal saline 1ml/kg, second section injected with depakine 25 & 50 mg/kg/day, third section injected with epanutin 3 & 6 mg/kg/day and fourth section injected with (depakine 25 + epanutin 3) & (depakine 50 + epanutin 6) mg/kg/day. Injections were via intraperitoneal, samples of both bone marrow erythrocytes for micronucleus test and hepatocytes for comet assay were collected after one and two weeks for each dose.

**Conclusions:** Human therapeutic doses range of depakine and/or epanutin generate (s) variable degrees of damages in genetic material in both bone marrow erythrocytes and hepatocytes of male albino mice depended on dose and time.

**Keywords:** *Epilepsy, liver, mutagenicity, phenytoin, sodium valproate.*

## Introduction

Epilepsy is a prevalent long-lasting neurological illness symptomized by gratuitous muscular convulsions<sup>(1)</sup>. It cannot be cured but it can be controlled by antiepileptic drugs<sup>(2)</sup>. Antiepileptic drugs have a wide range of clinical applications for the treatment of epilepsy and other disease<sup>(3)</sup>. It was stated that there is a positive correlation between DNA damage and teratogenicity<sup>(4)</sup>. Depakine (valproate sodium) has a broad capability to

treat several types of epilepsy<sup>(5)</sup>, psychiatric disorders<sup>(6)</sup> and neuropathic spasm<sup>(7)</sup>. Administration of valproate was associated with many delirious impacts. It was reported that in utero exposure to valproate induced high significant value of major congenital malformations in human embryo<sup>(8)</sup>. According to several clinical reviews treatment with depakine during pregnancy resulted in fetal valproate syndrome symptomized with craniofacial deformities, growth delay, spina bifida, skeletal deformities and cognitive disorders<sup>(9)</sup>. Epanutin (phenytoin sodium) applied to solve several clinical issues such as various degree of epilepsy, cardiac arrhythmia and sensory-motor disorders<sup>(10)</sup>. Phenytoin has adverse effects in pregnancy known as fetal hydantoin syndrome resembles to the fetal alcohol syndrome<sup>(11)</sup>, characterized with craniofacial anomalies (broad nasal bridge, cleft lip and palate, smaller than normal head) and mental retardation<sup>(12)</sup>.

---

### Corresponding Author:

**Ayman Mohammad Abdullah**

Biological and Geological Sciences Department,  
Faculty of Education, Ain Shams University, Egypt  
e-mail: ayman1924@gmail.com

## Materials and Method

Present study was performed on December 2019 at university of Ain shams, collage of education, biological and geological science department, Cairo, Egypt.

**Drugs:** Depakine is produced by Sanofi Aventis in pharmaceutical form of sodium valproate 200mg/1ml oral solution.

Epanutin is produced by El Nile Pharmaceutical Company in the form of phenytoin 250mg/5ml vial for injection. All tested doses were prepared in constant volume of 1ml/kg body weigh by dissolving drugs in normal saline. Tested doses were equivalent to human therapeutic doses<sup>(13)</sup>.

**Animals and experimental design:** Current experiment was carried out on pure and closed mating strain of male albino mice *Mus musculus* (CD -1). Animals were adult (6 to 8 weeks) with body weight (28 ± 2 g.) reared in animal house of Ain shams university, Egypt. Mice were resident in special acrylic boxes with base covered with clean wood shavings dust (3 mice per box) under constant temperature 20°C and 12 hours of light/dark natural sequence for two weeks before the beginning of the experiment and during all procedures. Mice were supplied with typical murine pellets diet and deionized water. Sawdust was changed daily to avoid septic pollutants. Animals care, usage and experimental procedures were circumscribed with recommendations of Ain shams University ethics authorities. Sixty-five mice were randomly sectioned into seven groups (8 mice/group).

**Control:** Mice were injected daily with normal saline 1ml/kg.

**Group 2:** Mice were injected daily with depakine drug 25 mg/kg body wieght.

**Group 3:** Mice were injected daily with depakine drug 50 mg/kg body wieght.

**Group 4:** Mice were injected daily with epanutin drug 3 mg/kg body wieght.

**Group 5:** Mice were injected daily with epanutin drug 6 mg/kg body wieght.

**Group 6:** Injected daily with (depakine drug 25 + epanutin drug 3) mg/kg b.wt.

**Group 7:** Injected daily with (depakine drug 50 +

epanutin drug 6) mg/kgb.wt.

All mice were injected intraperitoneally. Mice from all treated groups were randomly selected, sacrificed and specimens were taken after one and two week(s) for each dose.

**Micronucleus (MN) test:** Mice were injected with 0.05mg colchicine solution (2ml/1kg b.wt.) for 90-120 mins. Bone marrow was collected in fetal calf serum (media), smeared on clean microscope slide then stained by May-Grunwald 5-10 minutes<sup>(14)</sup>. Micronucleus test results represented by (mean ± SD) of polychromatic erythrocytes with micronucleus (MnPCEs) out of total scored 6000/group polychromatic erythrocytes (PCEs) and cytotoxicity results based on (mean ± SD) polychromatic erythrocytes (PCEs)/normochromatic erythrocytes (NCEs).

**Comet Assay:** It was applied on mice hepatocytes to spot and estimate DNA single-stranded breakages under cold, sterile, aseptic and UV free conditions to prevent DNA contaminations or damage. Hepatocytes isolated from homogenized liver by hepatocytes lysis media (1:1 by volume) and centrifuge (1500r.p.m.) for 30min. One drop of the mixture consisted of [20 µl of hepatocyte + 60 µl of low melting point agarose (0.5% phosphate buffer solution)] was smeared on clean microscopic slide pre-coated with dried normal melting point agarose (0.75% phosphate buffer solution) left to harden at 4°C, final layer of normal melting point agarose was applied, slides were immersed gently in a cold lysis liquid thenelectrophorized by 0.74 Volt/centimeter and 300 milli ampere for 30 minutes where DNA fragments migrate toward anode<sup>(15)</sup>. Slides were immediately stained in dim light by ethidium bromide and comets were evaluated by adjusted filter 515-560 nm of fluorescent microscope.

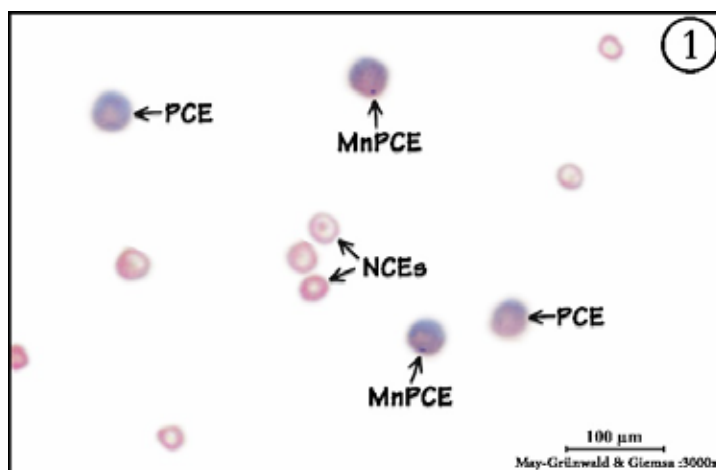
**Statistical Analysis:** Data were processed by version 16.0 of (SPSS). Results are determined by means ± SD of three independent repetitions. T- test was applied to evaluate statistical significance of variance at P <0.05 level as statistically significant.

## Results

**Micronucleus Test:** Under microscope two distinguishable colored stages of erythrocytes were identified. Figure 1 displayed that polychromatic erythrocytes (PCEs) were immature erythrocytes contain variable amounts of chromatin material so, it

was stained in blue-grayish, some of (PCEs) contain a condensed chromatin appeared in the form of dark blue spot known as micronucleus and it considered as pathogen (MnPCEs) and normochromatic erythrocytes (NCEs) were mature erythrocytes had no chromatin stained in pinky-yellowish. As shown in table 1 the mean

of (MnPCEs) and the mean of (PCEs/NCEs) displayed variable degrees in the significant values. The means of (MnPCEs) were increased while the means of (PCEs/MnPCEs) were decreased (cytotoxicity increased) by dose and time in all treated groups in comparison to control group.



**Figure1: Photomicrograph of bone marrow smear of male albino mouse *Mus musculus* treated with single dose of epanutin (6 mg/kg b.wt.) for two weeks showing polychromatic erythrocytes (PCEs), normochromatic erythrocytes (NCEs) and Polychromatic erythrocytes with micronucleus (MnPCEs).**

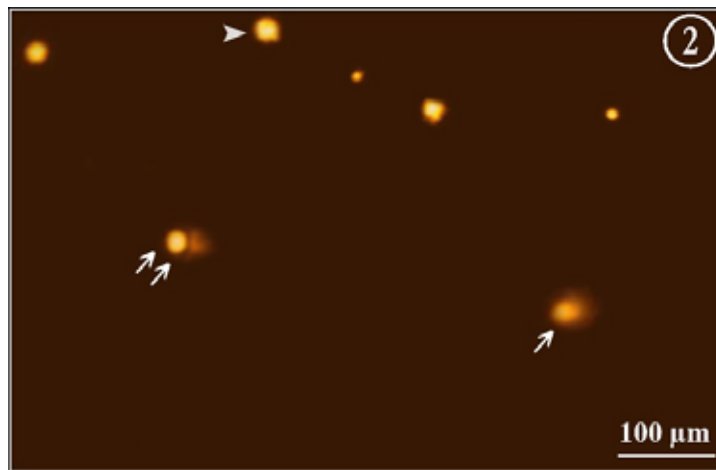
**Table 1: The (Mean ± SD) of both polychromatic erythrocytes with micronucleus (MnPCEs) and polychromatic erythrocytes (PCEs)/normochromatic erythrocytes (NCEs) in bone marrow of male albino mice of control and all treated groups.**

Drug	Dose mg/kg	PCEs/mouse	Micronucleus		Cytotoxicity	
			MnPCEs		PCEs/NCEs	
			1 <sup>st</sup> week	2 <sup>nd</sup> week	1 <sup>st</sup> week	2 <sup>nd</sup> week
Control		6000/3	12.7±1.3	12.7±1.3	2.1	2.1
Depakine	25	6000/3	14.0±0.8	19.7±1.7*	1.9*	1.8**
	50	6000/3	24.0±0.8**	33.0±2.5**	1.8*	1.7**
Epanutin	3	6000/3	20.7±3.3	26.3±1.3**	1.7*	1.7*
	6	6000/3	35.7±2.1**	39.7±3.3**	1.6*	1.5**
Depakine+Epanutin	25+3	6000/3	17.7±0.5	23.3±4.2	1.6	1.5*
	50+6	6000/3	32.3±2.9*	35.3±2.1**	1.5	1.5

\* represented high significant value (P<0.01), \*\* represented significant value (P<0.05)

**Comet Assay:** According to tail length 3 classes of nuclei were figured out. Class 0 had no tail; class 1 tail is shorter than the diameter of nucleus and class 2 tail length 1 to 2x the diameter of the nuclei as shown in figure 2. Hepatocytes with no heads were omitted from the calculation because they represented dead cells. Total comet score results were expressed by

(mean ± SD) of (number of comets multiplied by class number) out of total scored 300 randomly selected and non-overlapping hepatocytes nuclei/group. Statistical analysis was summarized in table 2, it exhibited high significant increase (P<0.01) in the mean of total comet score in most of treated groups in comparison to control group depend on dose and time.



**Figure 2:** photomicrograph of comet-FISH product of hepatocytes nuclei of male albino mouse *Mus musculus* treated with single dose of epanutin (6 mg/kg b.wt.) for two weeks showing comet class 0 (arrow head), comet class 1 (single arrow) and comet class 2 (duple arrows).

**Table 2:** The (Mean  $\pm$  SD) of comet classes and total comet score in hepatocytes of male albino mice of control and all treated groups.

Drug	Dose (mg/kg)	1 <sup>st</sup> week				2 <sup>nd</sup> week			
		Comet classes			Total comet score	Comet classes			Total comet score
		0	1	2		0	1	2	
Control		91 $\pm$ 0.5	9 $\pm$ 0.5	0	9 $\pm$ 0.5	91 $\pm$ 0.5	9 $\pm$ 0.5	0	9 $\pm$ 0.5
Depakine	25	90 $\pm$ 0.5	10 $\pm$ 0.5	-	10 $\pm$ 0.5	76 $\pm$ 0.0**	19 $\pm$ 0.3*	5 $\pm$ 0.3*	29 $\pm$ 0.3**
	50	70 $\pm$ 0.5*	30 $\pm$ 0.5*	-	30 $\pm$ 0.5*	69 $\pm$ 0.3**	31 $\pm$ 0.3**	-	31 $\pm$ 0.3**
Epanutin	3	32 $\pm$ 1.1**	30 $\pm$ 0.6**	8 $\pm$ 0.3**	46 $\pm$ 1.4**	61 $\pm$ 0.3**	25 $\pm$ 0.3*	14 $\pm$ 0.5**	53 $\pm$ 0.8**
	6	57 $\pm$ 1.1*	25 $\pm$ 0.6*	18 $\pm$ 0.3**	61 $\pm$ 1.4**	59 $\pm$ 0.3**	21 $\pm$ 0.5*	20 $\pm$ 0.8**	61 $\pm$ 1.1**
Depakine+Epanutin	25+3	71 $\pm$ 1.1*	25 $\pm$ 0.8*	3 $\pm$ 0.3*	31 $\pm$ 1.3*	71 $\pm$ 0.0**	26 $\pm$ 0.3**	3 $\pm$ 0.3*	32 $\pm$ 0.3**
	50+6	71 $\pm$ 0.0**	25 $\pm$ 0.3*	4 $\pm$ 0.3**	33 $\pm$ 0.3**	71 $\pm$ 0.3**	32 $\pm$ 0.0**	6 $\pm$ 0.3**	44 $\pm$ 0.5**

\* represented high significant value (P<0.01), \*\* represented significant value (P<0.05)

## Discussion

Current investigation declared that treatment of depakine and/or epanutin resulted in significant increase in the mean of micronuclei formation in bone marrow erythrocytes of male albino mice depend on dose and time. Our results was supported by previous publications found that micronuclei formation was enhanced in erythrocytes of mice and rat after the treatment with depakine<sup>(16)</sup>, or was enhanced in reticulocytes of male mice after the treatment with phenytoin<sup>(17)</sup> or was enhanced in human umbilical blood cells *in vivo* after the treatment with depakine together with epanutin<sup>(18)</sup>. These findings explanations were in the light of micronuclei are chromosomal residual after improper cellular division<sup>(19)</sup>

produced as a result of chromosomal aberrations caused by the treatment of either depakine<sup>(20)</sup> or epanutin<sup>(21)</sup>. Also, treatment of depakine and/or epanutin resulted in significant increase in the mean of cytotoxic impacts in bone marrow erythrocytes of male albino mice depend on dose and time. It was proved that cytotoxicity in rat hepatocytes was generated either by depakine treatment represented by enzymatic leakage in rat hepatocytes *in vitro* depended on dose<sup>(22)</sup> or by epanutin treatment represented by collapsing of mitochondrial membrane and kreb's cycle dysfunction<sup>(23)</sup>. Cytotoxicity results were due to the arrest of erythroblasts maturation (early stage of PCE) by depakine treatment *in vitro*<sup>(24)</sup> or even by epanutin treatment in human<sup>(25)</sup> and this maturation arresting resulted in decreased the number of PCE

(numerator) of the PCEs/NCEs ratio. Results found that treatment with depakine and/or epanutin resulted in raising the mean of total comet score by dose and by the time in compression to control group. According to earlier studies DNA fragmentation could be induced in human after depakine treatment<sup>(26)</sup> and in mice fetus cell culture pretreated with epanutin<sup>(27)</sup>. In the present work variable degrees of significance among all treated groups were due to the difference in the depakine and/or epanutin mechanisms of action. Genotoxicity and cytotoxicity were induced as a result of oxidative stress<sup>(28)</sup> induced either by depakine administration<sup>(29)</sup> or by epanutin administration<sup>(30)</sup> in addition to folate deficiency<sup>(31)</sup> caused by epanutin treatment<sup>(32)</sup>. Results of groups that were co-treated with depakine together with epanutin could be described due to depakine repel epanutin from plasma<sup>(33)</sup>.

### Conclusion

Treatment with human therapeutic doses range of depakine drug and/or epanutin drug generated genotoxic impacts in bone marrow erythrocytes and hepatocytes in addition to induction of cytotoxic effects in bone marrow erythrocytes in male albino mice. These drugs should be administrated under restricted medical consideration to avoid the incidence of mutagenicity in human patient.

**Conflict of Interest:** Nil.

**Source of Funding:** Self-funded.

**Ethical Clearance:** Ain shams University ethical committee.

### References

1. Neligan A, Hauser WA, Sander JW. The epidemiology of the epilepsies. *Handbook of Clinical Neurology*. 2012;107:113-133.
2. Krueger DA, Wilfong AA, Mays M, et al. Long-term treatment of epilepsy with everolimus in tuberous sclerosis. *Neurology*. 2016; 87(23):2408-2415.
3. Perucca P, Gilliam FG. Adverse effects of antiepileptic drugs. *The Lancet. Neurology*. 2012;11(9):792-802.
4. Parman T, Wiley MJ, Wells PG. Free radical-mediated oxidative DNA damage in the mechanism of thalidomide teratogenicity. *Nature medicine*. 1999;5(5):582-585.
5. Jeavons PM, Clark JE. Sodium valproate in treatment of epilepsy. *British medical journal*. 1974;2(5919):584-586.
6. McIntyre RS, Mancini DA, McCann S, Srinivasan J, Kennedy SH. Valproate, bipolar disorder and polycystic ovarian syndrome. *Bipolar disorders*. 2003;5(1):28-35.
7. Gill D, Derry S, Wiffen PJ, Moore RA. Valproic acid and sodium valproate for neuropathic pain and fibromyalgia in adults. *The Cochrane database of systematic reviews*. 2011;2011(10):CD009183.
8. Campbell E, Kennedy F, Russell A, et al. Malformation risks of antiepileptic drug monotherapies in pregnancy: updated results from the UK and Ireland Epilepsy and Pregnancy Registers. *Journal of neurology, neurosurgery, and psychiatry*. 2014;85(9):1029-1034.
9. Ardinger HH, Atkin JF, Blackston RD, et al. Verification of the fetal valproate syndrome phenotype. *American journal of medical genetics*. 1988;29(1):171-185.
10. Karthikeyan M, SAQUIB AK, Karthikeyan D. Therapeutic applications of phenytoin. *Asian journal of pharmaceutical and clinical research : AJPCR*. 2009;2(3):1-14.
11. Brewer JM, Waltman PA. Epilepsy and pregnancy: maternal and fetal effects of phenytoin. *Critical care nurse*. 2003;23(2):93-98.
12. Gollop TR, Salzo I. A case of prenatal diagnosis of fetal hydantoin syndrome by ultrasound. *Genetics and molecular biology*. 1999;22(2):147-150.
13. Nair A, Jacob S. A simple practice guide for dose conversion between animals and human. *Journal of basic and clinical pharmacy*. 2016;7(2):27-31.
14. Schmid W. The micronucleous test. *Mutation research*. 1975;31(1):9-15.
15. Singh NP, McCoy MT, Tice RR, Schneider EL. A simple technique for quantitation of low levels of DNA damage in individual cells. *Experimental cell research*. 1988;175(1):184-191.
16. Ahmad T, Shekh K, Khan S, et al. Pretreatment with valproic acid, a histone deacetylase inhibitor, enhances the sensitivity of the peripheral blood micronucleus assay in rodents. *Mutation research*. 2013;751(1):19-26.
17. Alarcón-Herrera N, Flores-Maya S. Phenytoin sodium induced micronuclei in the polychromatic



- erythrocytes of CD-1 mouse peripheral blood. *BIOCYT Biología Ciencia y Tecnología*. 2018;11(42): 780-788.
18. Witczak M, Kociszewska I, Wilczyński J, Łopaczyńska D, Ferenc T. Evaluation of chromosome aberrations, sister chromatid exchange and micronuclei in cultured cord-blood lymphocytes of newborns of women treated for epilepsy during pregnancy. *Mutation research*. 2010;701(2):111-117.
  19. Luzhna L, Kathiria P, Kovalechuk O. Micronuclei in genotoxicity assessment: from genetics to epigenetics and beyond. *Frontiers in genetics*. 2013;4:131.
  20. Galaly SR, Abdella EM, Mohammed HM. Effects of royal jelly on genotoxicity and nephrotoxicity induced by valproic acid in albino mice. *Beni-Suef University journal of basic and applied sciences*. 2014;3(1):1-15.
  21. Meng H, Zhang F, Gao X, et al. Effects of phenytoin on structural aberration of human sperm chromosomes in vitro. *Zhonghua yi xue yi chuan xue za zhi= Zhonghua yixue yichuanxue zazhi= Chinese J Med Genet*. 2001;18(4):303-305.
  22. Takeuchi T, Sugimoto T, Nishida N, Kobayashi Y. Evaluation of the cytotoxicity of sodium valproate on primary cultured rat hepatocytes. *Neuropediatrics*. 1988;19(03):158-161.
  23. Eghbal MA, Taziki S, Sattari MR. Mechanisms of phenytoin-induced toxicity in freshly isolated rat hepatocytes and the protective effects of taurine and/or melatonin. *ournal of biochemical and molecular toxicology*. 2014;28(3):111-118.
  24. Migliaccio AR. Erythroblast enucleation. *Haematologica*. 2010;95(12):1985-1988.
  25. Paul G, Sood P, Berry A, Paul BS. Pure red cell aplasia with phenytoin following traumatic brain injury. *Neurology India*. 2011;59(1):69-70.
  26. Mahmoud A, Tawfik M, Abd-El-Naby S, El-Aziz HD. A study of DNA damage in epileptic children treated with valproic acid or carbamazepine. *Menoufia Medical Journal*. 2019;32(3):1078-1082.
  27. Winn LM, Wells PG. Phenytoin-initiated DNA oxidation in murine embryo culture, and embryo protection by the antioxidative enzymes superoxide dismutase and catalase: evidence for reactive oxygen species-mediated DNA oxidation in the molecular mechanism of phenytoin teratogen. *Molecular pharmacology*. 1995;48(1):112-120.
  28. Tian S, Li K, Møller P, et al. Assessment of reactive oxygen species production and genotoxicity of rare earth mining dust: Implications for public health and mining management. *The Science of the total environment*. 2020;740:139759.
  29. Tung EWY, Winn L. Valproic acid increases formation of reactive oxygen species and induces apoptosis in postimplantation embryos: A role for oxidative stress in valproic acid-induced neural tube defects. *Molecular pharmacology*. 2011;80(6):979-987.
  30. Erenberk U, Dundaroz R, Gok O, et al. Melatonin attenuates phenytoin sodium-induced DNA damage. *Drug and chemical toxicology*. 2014;37(2):233-239.
  31. MacFarlane AJ, Behan NA, Field MS, Williams A, Stover PJ, Yauk CL. Dietary folic acid protects against genotoxicity in the red blood cells of mice. *Mutation research*. 2015;779:105-111.
  32. Xu Y, Zhang N, Xu S, Xu H, Chen S, Xia Z. Effects of phenytoin on serum levels of homocysteine, vitamin B12, folate in patients with epilepsy: A systematic review and meta-analysis (PRISMA-compliant article). *Medicine*. 98(12):e14844.
  33. Roberts WL, Annesley TM, De BK, Moulton L, Juenke JM, Moyer TP. Performance characteristics of four free phenytoin immunoassays. *Therapeutic drug monitoring*. 2001;23(2):148-154.

# Assessment of Neutrophil-to-Lymphocyte Ratio, Platelet-to-Lymphocyte Ratio, Oxidative Stress and Anti Oxidants levels in Polycystic Ovary Syndrome Patients with Low-Grade Chronic Inflammation

Najlaa Abdulameer Ali AL-Dahhan<sup>1</sup>, Aseel Jassim Albdairi<sup>2</sup>, Ammar Jabbar Hamad<sup>3</sup>

<sup>1</sup>Assist. Prof., Department of Basic Science, College of Dentistry, University of Kufa, Al-Najaf, Iraq, <sup>2</sup>Assist. Prof., Department of Physiology, College of Medicine, University of Kufa, Al-Najaf, Iraq, <sup>3</sup>Assist. Prof., Department of Medicine, College of Medicine, University of Kufa, Al-Najaf, Iraq

## Abstract

**Background:** The ratio of neutrophils to lymphocytes (NLR) and the ratio of platelets to lymphocytes (PLR) are prognostic factors in many diseases such as inflammatory diseases, cardiovascular diseases and cancer. However, raising NLR and PLR are important, it is important to establish reference values for NLR and PLR in polycystic ovary syndrome (PCOS) patients with mild chronic inflammation.

**Objective:** To determine the neutrophil-lymphocyte ratio (NLR) and platelet-lymphocyte ratio (PLR), and the relationship between oxidative stress markers and anti oxidants markers in PCOS patients with low-grade chronic inflammation. Methodology. The study included 92 patients with PCOS and 46 control. Serum PON1, XO, SOD activities, 8-OHdG and NO levels were measured using enzyme linked immunosorbent assay (ELISA) kits.

**Results:** Concentration of TNF- $\alpha$ , IL-6, IL-8, IL-10 and CRP were significantly higher in PCOS patients compared with control ( $P < 0.001$ ). Significant increases were recorded in WBC, ANC, PLT, NLR, PLR, and ESR values. A significant decrease in ALC and MPV values in PCOS patients compared with control ( $P < 0.01$ ). Serum XO, SOD activities and NO levels were higher in PCOS patients than in the control ( $p < 0.001$ ). Serum 8-OHdG levels and PON1 activities were lower in PCOS patients than in the control ( $p < 0.001$ ). Serum CRP values is positively correlated with XO, NO, 8-OHdG and PON1 activity ( $r = 0.377$ ,  $p < 0.008$ ;  $r = 0.560$ ,  $p < 0.007$ ;  $r = 0.387$ ,  $p < 0.006$ ;  $r = 0.481$ ,  $p < 0.009$ ), respectively. Serum CRP values is negatively correlated with SOD activity in PCOS patients ( $r = -0.444$ ,  $p < 0.004$ ). Serum XO activities were negatively correlated with serum PON1 and SOD. Serum XO activities were positively correlated with serum NO and 8-OHdG levels.

**Conclusion:** Inflammation stimulates the oxidation process and reduces the ability of cellular antioxidants in PCOS patients. NLR and PLR are good markers of inflammation, their highest values indicate the severity of the disease and an imbalance between neutrophils and lymphocytes can be linked to cancer and its development.

**Keywords:** Polycystic ovary syndrome, Inflammation, Oxidative Stress, Anti Oxidants.

---

## Corresponding Author:

Najlaa Abdulameer Ali AL-Dahhan

Assist. Prof., Department of Basic Science, College of Dentistry, University of Kufa, Al-Najaf, Iraq  
e-mail: najlaa.aldahhan@uokufa.edu.iq

## Introduction

Polycystic ovary syndrome (PCOS) is a common disorder in women of childbearing years characterized by increased androgen and ovulation and is associated with many metabolic disorders, especially insulin

resistance and obesity<sup>(1)</sup>. Oxidative stress (OS) indicates an imbalance between oxidizing substances and antioxidants that lead to abnormal cell state<sup>(2)</sup>. OS occurs when destructive reactive oxygen species (ROS) overcome antioxidants, and stress leads to the accumulation of peroxides and free radicals causing damage to DNA and/or programmed cell death and causing damage to proteins, lipids, carbohydrates and other molecules<sup>(3)</sup>. Chronic inflammation and ROS contribute to the DNA damage of many organs, and ROS causes oxidation of biomolecules such as lipids, proteins, and other molecules which leads to the formation of toxic and mutagenic intermediates<sup>(4)</sup>. Cells produce ROS and reactive nitrogen species (RNS) as normal products of the biological reduction of molecular oxygen. ROS include superoxide anion ( $O_2^{\bullet-}$ ), hydroxyl radical ( $OH^{\bullet}$ ), hydrogen peroxide ( $H_2O_2$ ) and organic peroxides<sup>(5,6)</sup>. Superoxide ( $O_2^{\bullet-}$ ) is mainly generated at the mitochondrial electron transport chain level and can be converted to hydrogen peroxide ( $H_2O_2$ ) by SOD or undergo spontaneous disassociation<sup>(6)</sup>. RNS includes nitric oxide (NO) and its metabolites, which are also highly reactive and toxic<sup>(1,5)</sup>. Inflammation is one of the main pathophysiological factors in PCOS diseases. Nowadays diagnostic and monitoring markers are used, such as C-reactive protein (CRP), erythrocyte sedimentation rate, ferritin, serum albumin, apolipoprotein A-1, tumor necrosis factor, interleukin-1, interleukin-6 and others<sup>(7,8)</sup>. Chronic inflammation and infection are an important and major cause of cancer, include NF- $\kappa$ B, reactive oxygen species and nitrogen, inflammatory cytokines, prostaglandins, and RNAs, through proliferation changes, cell death, cellular aging, mutation and methylation in DNA<sup>(7)</sup>.

Several biomarkers such as CRP, neutrophil-to-lymphocyte ratio (NLR) and platelet-to lymphocyte ratio (PLR) were used as markers of inflammation and endothelial damage<sup>(8,9)</sup>. Complete blood count (CBC) test is widely used, and mainly includes white blood cell (WBC) count, red blood cell (RBC) count and platelet count. WBCs most abundant in healthy individuals are neutrophils, which play important roles during acute and chronic inflammation and may be potential therapeutic targets in several diseases<sup>(10,11)</sup>.

8-Hydroxydeoxyguanosine (8-OHdG) can be a defense mechanism against oxidative stress and preventing inflammatory disease<sup>(12)</sup>. ROS easily attacks guanine bases in DNA and forms 8-OHdG, which can bind to thymidine instead of cytosine, so the 8-OHdG

level is a biological biomarker of mutations resulting from oxidative stress. The oxidative form of DNA damage can be seen by assessing the concentration of 8-OHdG<sup>(13)</sup>. 8-OHdG can reduce ROS production, reduce the pathway of nuclear factor- $\kappa$ B, and reduce expression of inflammatory mediators such as interleukin IL-1, IL-6, cyclo-oxygenase-2, and inducible nitric oxide synthase in addition to the expression of nicotinamide adenine dinucleotide phosphate oxidase (NOX)-1, NOX organizer-1 and NOX activator-1 in different cases of PCOS inflammation<sup>(2)</sup>. To determine the role of OS in PCOS, a set of vital biomarkers were examined including Xanthine oxidase (XO), NO, 8-OHdG, Paraoxonase 1 (PON1) and Superoxide dismutase (SOD). The aim of present study was to verify individual and group diagnostic accuracy of NLR, PLR, and MPV in PCOS patients diagnosed with CRC. And assess whether there was any relationship between oxidative stress markers and antioxidant markers with inflammation in the development of PCOS. We have investigated oxidative stress by measuring serum XO activity (as a generator of reactive oxygen species) and NO levels.

## Material and Method

**Study Population:** One hundred and thirty-eight women within the (21-38) age group were involved in this study from 12 October 2018 to 16 November 2019. They were divided into two groups: 92 patients with PCOS (mean age:  $34.4 \pm 5.8$  years) and 46 healthy individuals were recruited as a controls (mean age:  $35.7 \pm 5.8$  years). Patients selected clinically diagnosed with polycystic ovary syndrome from Al-Sadder Teaching Hospital in Najaf city, Iraq. The diagnosis was based on the presence of oligomenorrhea or chronic menopause (less than six menstrual periods in the preceding year), hirsutism (Ferriman-Gallwey score of 7), LH/FSH ratio (3.0), hyperandrogenemia, plasma total testosterone concentrations of more than (0.6) ng/ml, and free androgen index (FAI) of less than 5. Patients were excluded if they had evidence of the presence history of malignancy, hyperprolactinemia, diabetes mellitus, hypertension, pregnancy, thyroid and adrenal dysfunction, any history of cardiac symptoms, myocardial infarction, angina, coronary artery disease, vascular disease. Women who are taking contraceptives because they contain hormones, acetyl salicylic acid, non-steroidal anti-inflammatory drugs or other pharmacological factors that could affect On the results of our study.

**Sample Collection:** Blood samples were collected

after an overnight fasting of  $\geq 12$  hours on the second or third day of the menstrual cycle. Venous blood samples (5ml) were collected into EDTA tubes and centrifuged at 3000 rpm for 5 minutes, and, were separated and stored at  $-20^{\circ}\text{C}$  for estimate some criteria.

**Method:** On the second or third day of the menstrual cycle, the BMI was calculated according to WHO criteria based on weight divided by height squared ( $\text{kg}/\text{m}^2$ ). Using commercially available diagnostic kits (Bayer Corporation, Tarrytown, NY) in an Advia Centaur Immunoassay System, Follicle stimulating hormone (FSH), luteinizing hormone (LH), and prolactin (PRL) levels were measured. Serum CRP was turbidimetrically determined by a clinical chemistry system (SPACE, Schiapparelli Biosystems, Woerden, The Netherlands), which gives a quantitative result. Serum C-reactive protein (CRP), tumor necrosis factor- $\alpha$  (TNF- $\alpha$ ), interleukin-6 (IL-6), interleukin-8 (IL-8), and interleukin-10 (IL-10) were determined using ELISA kits (SunLong Biotech Co, China). Serum PON1, XO, SOD activities, 8-OHdG and NO levels were measured using enzyme linked immunosorbent assay (ELISA) kits (SunLong Biotech Co, China). Complete blood counts (CBC) tests were performed in anticoagulant samples with EDTA within 4 hours after collection, using a Coulter® LH750 Hematology Analyzer (Beckman Coulter, USA). Neutrophil-to-lymphocyte ratio (NLR) was calculated by dividing the absolute neutrophil count (ANC) by the absolute lymphocyte count (ALC); likewise, platelet to lymphocyte ratio (PLR) was calculated by dividing the absolute platelet count by Absolute lymphocyte count (ALC). Three levels of commercial surveillance material (Beckman Coulter, USA) were run twice daily. Samples were excluded with white blood count (WBC) less than  $3.5 \times 10^9/\text{L}$  or more than  $9.5 \times 10^9/\text{L}$  and platelet less than  $125 \times 10^9/\text{L}$  or more than  $350 \times 10^9/\text{L}$ .

**Statistical Analysis:** SPSS software 22 was used for statistical analysis. The data are expressed as mean  $\pm$  SD. Significance of the difference between the mean value of the measured parameters between groups were evaluated by Student's t-test and chi-square. Correlation was indicated by Pearson correlation tests and  $P < 0.05$  is considered significant.

## Results

The demographic characteristics and hormones levels in PCOS patients and control are shown in Table 1. Concentration of pro-inflammatory cytokines (TNF- $\alpha$ , IL-6 and IL-8), anti-inflammatory cytokines (IL-10), and CRP were significantly higher in PCOS patients compared with control ( $P < 0.001$ ) Table 2. A significant increase in WBC, ANC, PLT, NLR, PLR and ESR values in PCOS patients compared to controls. A significant decrease in ALC and MPV values in PCOS patients compared with control ( $P < 0.01$ ) Table 3 and Fig. 1. Serum XO, SOD activities and NO levels were higher in the PCOS patients compared with control ( $p < 0.001$ ). Serum 8-OHdG levels and PON1 activities were lower in women with PCOS than in the control ( $p < 0.001$ ) Table 4. Serum CRP values is positively correlated with XO, NO, 8-OHdG and PON1 activity ( $r = 0.377$ ,  $p < 0.008$ ;  $r = 0.560$ ,  $p < 0.007$ ;  $r = 0.387$ ,  $p < 0.006$ ;  $r = 0.481$ ,  $p < 0.009$ ), respectively. Serum CRP values is negatively correlated with SOD activity in PCOS patients ( $r = -0.444$ ,  $p < 0.004$ ) Table 5. Serum XO activities were negatively correlated with serum PON1 and SOD activities ( $r = -0.465$ ,  $p < 0.008$ ;  $r = -0.375$ ,  $p < 0.007$ ), respectively. Serum XO activities were positively correlated with serum NO and 8-OHdG levels ( $r = 0.483$ ,  $p < 0.009$ ;  $r = 0.472$ ,  $p < 0.006$ ), respectively Table 6.

**Table 1. Characteristics in PCOS patients and control.**

Parameter	PCOS (n=92) Mean $\pm$ SD	Controls (n=46) Mean $\pm$ SD	p-Value
Age (Years)	23.40 $\pm$ 2.80	24.72 $\pm$ 1.68	NR
BMI ( $\text{kg}/\text{m}^2$ )	29.33 $\pm$ 3.56	22.48 $\pm$ 2.87	<0.01*
FSH (mIU/ml)	5.22 $\pm$ 2.20	6.10 $\pm$ 2.11	<0.001
LH (mIU/ml)	10.33 $\pm$ 2.11	5.01 $\pm$ 2.77	<0.001
PRL (mIU/ml)	40.42 $\pm$ 1.28	18.88 $\pm$ 1.18	<0.001

\* $p < 0.05$  was considered significant; NR, Not significant.

**Table 2. Concentration of pro-inflammatory cytokines, anti-inflammatory cytokines and CRP in PCOS patients and control.**

<i>p</i> -Value	Control (n=46) Mean ± SD	PCOS (n=92) Mean ± SD	Parameter
< 0.001	8.11±2.21	43.30±3.42	CRP (mg/l)
< 0.001	5.42 ± 1.66	97.33 ± 1.74	TNF-α(pg/ml)
< 0.001	38.32±6.32	142.31±5.24	IL-6 (pg/ml)
< 0.001	31.34±5.95	127.44±7.10	IL-8 (pg/ml)
< 0.001	40.14±2.27	77.62±2.22	IL-10 (pg/ml)

CRP, C-reactive protein; TNF-α, tumor necrosis factor-α; IL-6, interleukin-6; IL-8, interleukin-8.  $p < 0.05$  was considered significant

**Table 3. Laboratory values in PCOS patients and control.**

<i>p</i> -Value	Controls (n=46) Mean ± SD	PCOS (n=92) Mean ± SD	Parameter
<0.01	4.55±7.33	12.02±4.31	WBC( $10^9/L$ )
<0.01	4.33 ± 1.62	7.55 ± 2.66	ANC (%)
<0.01	5.13 ± 0.85	1.60 ± 0.75	ALC (%)
<0.01	220.38 ± 51.88	263.04 ± 80.12	PLT ( $10^9/L$ )
<0.01	1.81±0.22	6.82±0.97	NLR
<0.01	93.78±18.33	182.04±41.11	PLR
<0.01	9.77 ± 1.65	5.53 ± 1.24	MPV (fL)
<0.01	15.86±4.76	31.11±8.21	ESR(mm/hour)

$p < 0.05$  was considered significant; WBC, white blood count. Tumor necrosis factor-α, Complete blood counts; ANC, Absolute neutrophil count; ALC, Absolute lymphocyte count.

**Table 4. Serum oxidative stress markers (XO, NO and 8-OHdG) and antioxidative stress markers (SOD and PON1) in PCOS patients and control.**

<i>p</i> -Value	Controls (n=46) Mean ± SD	PCOS (n=92) Mean ± SD	Parameter
< 0.001	0.73±0.30	4.07±0.22	XO (U/mL)
< 0.001	6.82±3.11	10.06±2.52	NO ( $\mu\text{mol/L}$ )
< 0.001	220.32 ± 64.81	136.72 ± 45.34	8-OHdG (pg/mL)
< 0.001	748.66±20.77	855.44±41.44	SOD (U/gm of Hb)
< 0.001	196.10±81.83	127.50±77.26	PON1 (U/L)

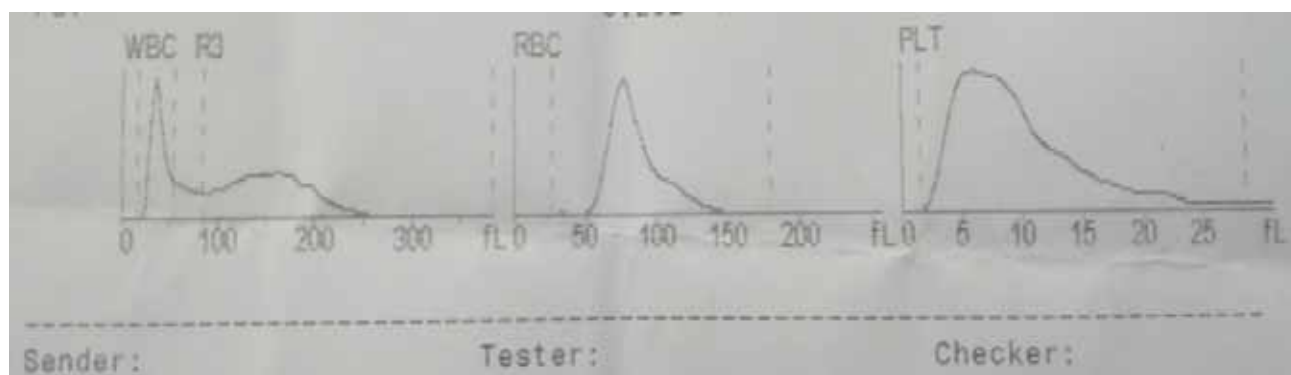
$p < 0.05$  was considered significant

**Table 5. Correlation between Oxidative stress markers, Antioxidative stress markers and CRP in PCOS patients.**

Parameter	PCOS (n=92)		Control (n=46)	
	r	p-value	r	p-value
XO (U/mL)	0.377	<0.008	0.228	<0.005
NO ( $\mu\text{mol/L}$ )	0.560	<0.007	0.217	<0.008
8-OHdG (pg/mL)	0.387	<0.006	0.636	<0.005
SOD (U/gm of Hb)	-0.444	<0.006	0.338	<0.002
PON-1 (U/L)	0.481	<0.009	0.568	<0.007

**Table 6. Correlation between XO activity and PON1, SOD activity, and NO, 8-OHdG levels in PCOS patients.**

Parameter				p-value
8-OHdG (pg/mL)	NO ( $\mu\text{mol/L}$ )	SOD (U/gm of Hb)	PON1 (U/L)	
0.472	0.483	-0.375	-0.465	r
<0.006	<0.009	<0.007	<0.008	

**Fig. 1. Values of WBC, RBC and PLT in PCOS patients**

## Discussion

Enlarged adipose tissue leads to infiltration of macrophages and imbalance are pro-inflammatory and anti-inflammatory factors secreted by adipose tissue, which leads to enhanced inflammation, impairment of insulin sensitivity and dysregulation of lipid metabolism. Obesity-related inflammation is caused by extra nutrients that initially activate many pathways of metabolic signals, such as JNK, NF- $\kappa$ B, and protein kinase R pathways<sup>(2, 14)</sup>. In obese PCOS patients, BMI, free fatty acids, IL-6, and CRP levels increased, while androgen levels decreases with gonadotropin-releasing hormone (Gn RH) agonist for a long term<sup>(15)</sup>. These results are consistent with Our current study. Activation of these pathways leads to the production of many inflammatory cytokines and then leads to chronic low grade inflammation<sup>(6)</sup>. Increased production of ROS leads to disruption of the organism, therefore, the enhancement of OS in tissues and organisms causes related damage; harms mitochondrial components (mtDNA, proteins, lipids, etc.), and induces apoptosis<sup>(1)</sup>. Our results indicate the concentration of pro-inflammatory cytokines (TNF- $\alpha$ , IL-6 and IL-8), anti-inflammatory cytokines (IL-10), and CRP were significantly higher in PCOS patients compared with control ( $P < 0.001$ , for each) Table 2. Several recent studies have indicated that chronic inflammation have a role in causing PCOS because many markers of inflammation are elevated

in those women with this disease. On the other hand, a relationship was found between the proinflammatory condition and PCOS, associated with polymorphism of TNF- $\alpha$ , IL-6, and its receptor<sup>(16,17)</sup>. Inflammation are involved in the pathogenesis of numerous chronic diseases. Where there is a relationship between chronic low-grade Inflammation and the development of PCOS<sup>(4)</sup>.

Our results indicate a significant increases in WBC, ANC, PLT, NLR, PLR and ESR values, and a significant decrease in ALC and MPV values in PCOS patients compared with control ( $P < 0.01$ , for each) Table 3 and Fig. 1. These results are consistent with other studies<sup>(9, 18)</sup>. NLR (neutrophil-to-lymphocyte ratio) and PLR (platelet to lymphocyte ratio) were good inflammatory markers and can be used to assess disease activity and in some diseases they are used to differentiate infections<sup>(16)</sup>. On the other hand, these parameters are related to the early diagnosis of diseases<sup>(11)</sup>. MPV is used as a marker for platelet size and activity<sup>(10)</sup>. MPV has been identified as an inflammatory marker for cerebrovascular, cardiovascular, digestive and rheumatic diseases<sup>(18)</sup>. Also, as a marker of early diagnosis in detecting types of cancer<sup>(9, 10)</sup>. A high BMI can be explained by considering that obesity can also affect MPV<sup>(19)</sup>.

Oxidants and antioxidants are involved in regulating gene expression in physiological and pathological

conditions, and therefore ROS modulate proliferation (1). The results indicated a significantly increased Serum XO activity in women with PCOS compared with control ( $p < 0.001$ ). Table 4. XO plays an important role in the catabolism of purines and generating ROS in PCOS patients<sup>(20)</sup>, Thus it can be said that the increase is due to the increase in oxidative stress in patients. These results are consistent with previous studies<sup>(20, 21)</sup>. PCOS can be considered a purely oxidative state in which the body's antioxidants cannot exceed the overproduction of free radicals<sup>(3)</sup>. This indicates that the increase in XO activity is closely related to the changes and increase in markers of inflammation during the development of PCOS. XO is a key enzyme and source of ROS and can generate superoxide anion radicals, capable of lipid peroxide and protein degradation<sup>(21)</sup>. This enzyme catalyzes oxidation of hypoxanthine to xanthine and oxidation of xanthine to uric acid<sup>(20)</sup>. Free radicals seek stability by taking electrons from other stable molecules, which creates a chain reaction of free radical formation that can cause damage to body cells, proteins, and DNA. In addition, aging and/or environmental stress may enhance this oxidation and may cause chronic inflammation, which may exacerbate damage and increase the risk of cancer. NO plays a major role in the pathophysiology of PCOS. The results showed that NO levels were statistically higher in patients with PCOS compared to control ( $p < 0.001$ ) Table 4. RNS, such as NO with the unpaired electron are also highly reactive and toxic. OS occurs when destructive ROS overcome antioxidants, causing DNA damage and/or programmed cell death. Our current results are consistent with similar studies<sup>(6, 22)</sup>. Increased NO levels may be toxic to host cells, as they are also produced in immune responses by monocytes, macrophages, and neutrophils<sup>(6, 23)</sup>, indicated that nitrite/nitrate concentration is an indicator of NO lining. On the other hand, an analytical study showed that the mean NO level had no statistically significant difference in patients with PCOS compared to controls<sup>(24)</sup>. Moreover, several data indicated a significant negative correlation between NO and fasting insulin levels and HOMA in PCOS patients<sup>(2)</sup>.

Serum 8-OHdG levels were decreased in PCOS patients compared with control ( $p < 0.001$ ) Table 4. The reason for the decrease in 8-OHdG level may be due to changes in antioxidant levels as response to increased oxidative stress that causes DNA damage these results are consistent with previous studies<sup>(25, 26)</sup>, which have indicated that metformin therapy leads to reduced serum

8-OHdG level in obese patients. On the other hand, 8-OHdG levels are associated with body weight and the marker of inflammation CRP<sup>(13)</sup>. Conversely, several studies indicated an increase in the 8-OHdG level in PCOS patients compared to control<sup>(27, 28)</sup>. On the other hand, Several studies have shown increased levels of 8-OHdG in diseases associated with oxidation. ROS easily attacks guanine bases in DNA and forms 8-OHdG, which can bind to thymidine instead of cytosine, so the 8-OHdG level is a biological biomarker of mutations resulting from oxidative stress<sup>(12)</sup>. The oxidative form of DNA damage can be seen by assessing the concentration of 8-OHdG<sup>(13)</sup>.

SODs are a family of enzymes that catalyze the breakdown of  $O_2^-$  to  $H_2O_2$ , which is a toxic substance converted to water by GPx<sup>(29, 30)</sup>. Serum SOD activity increased in patients with PCOS compared to control ( $p < 0.001$ ) Table 4. These results are consistent with other studies<sup>(22, 31, 2)</sup>. Excessive expression of SOD may be an adaptive response against increased ROS levels, and leads to increased dissociation of superoxide from hydrogen peroxide<sup>(33)</sup>. Several studies have suggested that an increase in antioxidant enzymes may represent compensatory swelling in response to an increase in oxidative stress<sup>(34, 35)</sup>. Serum SOD activity can be a clinical marker for determining oxidative stress in PCOS patients. SOD enzymes act as pro-oxidant producing  $H_2O_2$ ; for this reason, other antioxidant enzymes such as GPx and CAT are urgently needed. On the other hand, the results of our study are not compatible with what previous studies have found<sup>(21, 36)</sup>.

PON1 is an antioxidant responsible for removing oxidized toxins from lipids<sup>(37)</sup>. Serum PON1 activity decreased in PCOS patients compared to control ( $p < 0.001$ ) Table 4. Similar results have been reported in other studies<sup>(20, 38)</sup>. The mechanism of decrease serum PON1 activity is unclear. Consumption of PON1 to prevent oxidation can lead to decreased activity in PCOS patients, or the reason for the decrease is due to the increased disruption of PON1 as a result of increased ROS generation in patients<sup>(38)</sup>. Therefore, it can be speculated that the superoxide anions produced by XO are responsible for the decreased PON1 activity due to the change in structure of protein. PON1 associated with lipid peroxidation, therefore an anti-inflammatory indication due to its activity in paroxonase which does not represent its total physiological activity. PON1/HDL activity was a better abnormal parameter in several diseases including PCOS<sup>(20)</sup>.

Serum CRP values is positively correlated with XO, NO, 8-OHdG and PON1 activity ( $r=0.377$ ,  $p<0.008$ ;  $r=0.560$ ,  $p<0.007$ ;  $r=0.387$ ,  $p<0.006$ ;  $r=0.481$ ,  $p<0.009$ ; respectively). Serum CRP values is negatively correlated with SOD activity in PCOS patients ( $r=-0.444$ ,  $p<0.006$ ) Table 5. These results are consistent with other studies<sup>(20, 21)</sup>. OS and chronic inflammation are closely related mechanisms, the release of many active substances by inflammatory cells into inflammatory sites results in the overgeneration of the OS<sup>(39)</sup>. This relationship is confirmed by the increase in the levels of associated circulatory markers with inflammation, such as CRP, IL-6, TNF- $\alpha$ , IL-8, monocyte chemoattractant protein-1 (MCP-1), soluble intercellular adhesion molecule-1, and WBC in PCOS patients<sup>(16, 39)</sup>. XO was used as an indicator of oxidative stress (as a generator of ROS); Serum XO activities were negatively correlated with serum PON1 and SOD activities ( $r=-0.465$ ,  $p<0.008$ ;  $r=-0.375$ ,  $p<0.007$ ; respectively). Serum XO activities were positively correlated with serum NO and 8-OHdG levels ( $r=0.483$ ,  $p<0.009$ ;  $r=0.472$ ,  $p<0.007$ ; respectively) Table 6. These results are consistent with other studies<sup>(2, 20)</sup>. To our knowledge, this is the first study that combines NLR, PLR and MPV and has a high diagnostic accuracy. In addition, this is the first study among the Iraqi population, which is important given the regional prevalence of PCOS. **In conclusion.** An imbalance in oxidative stress and antioxidants system toward increased of ROS generation and cause PCOS and its development. Inflammation stimulates the oxidation process and reduces the ability of cellular antioxidants in PCOS patients. Diagnostic effectiveness of NLR, PLR, and MPV can be used as biomarkers and test markers to detect PCOS even in the early stages of the disease, taking into account that it is part of a routine blood work analysis, and its higher values disease severity and imbalance between neutrophils and lymphocytes then to cancer and its development.

**Ethical Clearance:** Ethical clearance taken from Al-Saddr Teaching Hospital committee in Najaf city, Iraq.

**Source of Funding:** The source of funding is self and there is no agreement with an institution or company.

**Competing Interests:** There are no conflicts of interest.

## References

- Zuo T, Zhu M, Xu W. Roles of Oxidative Stress in Polycystic Ovary Syndrome and Cancers. *J Oxidative Medicine and Cellular Longevity* 2016; 1:1-14.
- Zhang J, Bao Y, Zhou X et al. Polycysticovarysyndrome & mitochondrial dysfunction. *Reproductive Biology and Endocrinology* 2019;17(67):2-15.
- Agarwal A, Gupta S, Sharma RK. Role of oxidative stress in female reproduction. *Reprod Biol Endocrinol* 2012;3:28.
- Pandey V, Singh A, Krishna A et al. Role of oxidative stress and low-grade inflammation in letrozole-induced polycysticovary syndrome in the rat. *Reprod Biol* 2016;16:70-7.
- Novo E, Parola M. Redox mechanisms in hepatic chronic wound healing and fibrogenesis. *Fibrogenesis Tissue Repair* 2008;1(1):5.
- Valko M, Leibfritz D, Moncol J et al. Free radicals and antioxidants in normal physiological functions and human disease. *Int J. Biochem & Cell Biol* 2007;39(1):44-84.
- Chavez-Valencia V, Orizaga-dela C, Mejia O et al. Inflammation in hemodialysis and their correlation with neutrophil-lymphocyteratio & platelet-lymphocyteratio. *Nefrologia* 2017;37:554-6.
- Valga F, Monzón T, Henriquez F et al. Neutrophil to lymphocyte & platelet to lymphocyte ratios as biological markers of interest in kidney disease. *Nefrologia* 2019;39(3):243-249.
- Stojkovic M, Pavlovic AM, Stankovic S et al. Combined Diagnostic Efficacy of Neutrophil to Lymphocyte Ratio, Platelet to Lymphocyte Ratio, and Mean Platelet Volume as Biomarkers of Systemic Inflammation in the Diagnosis of Colorectal Cancer. *Disease Markers* 2019;1-7.
- Zeb A, Khurshid S, Bano S. The Role of the Neutrophil-to-Lymphocyte Ratio and Platelet-to-Lymphocyte Ratio as Markers of Disease Activity in Ankylosing Spondylitis. *Cureus* 2019;11(10):6025.
- Wu L, Zou S, Wang C et al. Neutrophil-to-lymphocyte and platelet-to-lymphocyte ratio in Chinese Han population from Chaoshan region in South China. *BMCCardio-vascular Disorders* 2019, 19:125.
- Ock CY, Kim E, Choi-Joo D et al. 8-Hydroxy deoxyguanosine: Not mere biomarker for oxidative stress, but remedy for oxidative stress-implicated gastrointestinal diseases. *World J Gastroenterol*



- 2012;18(4):302-308.
13. Setyaningsiha Y, Husodob A, Astuti I. Detection of Urinary 8-hydroxydeoxyguanosine (8-OHdG) levels as a Biomarker of Oxidative DNA Damage among Home Industry Workers Exposed to Chromium. *Procedia Environmental Sciences* 2015; 23:290- 296.
  14. Khanna H, Karki K, Negi R et al. Inflammation, Free Radical Damage, Oxidative Stress and Cancer. *Interdiscip J Micro inflammation* 2014;1(1):1-5.
  15. Gonzalez F, Sia C, Blair H et al. Hyperandrogenism exerts an anti-inflammatory effect in obese women with polycystic ovary syndrome, *Endocrine* 2012; 42(3):726–735.
  16. Artimani T, Karimi J, Mehdizadeh M, Yavangi M, Ghorbani M. Evaluation of pro-oxidant-antioxidant balance (PAB) and its association with inflammatory cytokines in polycystic ovary syndrome (PCOS). *Gynecol Endocrinol* 2018; 34:148–52.
  17. Rashad NM, El-Shal A, Abdelaziz AM. Association between inflammatory biomarker serum procalcitonin and obesity in women with polycystic ovary syndrome. *J. Reprod Immunol* 2013;97:232–9.
  18. Peng H, Yang L, He B. Combination of preoperative NLR, PLR and CEA could increase the diagnostic efficacy for I-III stage CRC, *J. Clinical Laboratory Analysis* 2017; 31(5):1-8.
  19. Au AE, Sashindranath M, Borg RJ. Activated platelets rescue apoptotic cells via paracrine activation of EGFR and DNA-dependent protein kinase, *Cell Death and Disease* 2014;5(9):1410.
  20. Baskol G, Aygen E, Erdem F et al. Assessment of paraoxonase 1, xanthine oxidase and glutathione peroxidase activities, nitric oxide and thiol levels in women with polycystic ovary syndrome. *Acta Obstet Gynecol Scand* 2012; 91:326–330.
  21. Isik H, Aynioglu O, Timur H et al. Is xanthine oxidase activity in polycystic ovary syndrome associated with inflammatory and cardiovascular risk factors? *J Reprod Immunol* 2016;116:98–103.
  22. Mohammadi M. Oxidative stress and polycystic ovary syndrome: A brief review. *Int J Prev Med* 2019;10:86.
  24. Murri M, Luque-ramirez M, Insenser M et al. Circulating markers of oxidative stress and polycystic ovary syndrome (PCOS): a systematic review and meta-analysis, *Human Reproduction Update* 2013;19(3): 268–288.
  25. Sova H, Morin-Papunen L, Puistola U et al. Distinctively low levels of serum 8-hydroxydeoxyguanosine in women with polycystic ovary syndrome, *Fertility and Sterility* 2010;94(7):2670–2673.
  26. Sova H. Oxidative stress in breast and gynaecological carcinogenesis. University of Oulu Graduate School; Faculty of Medicine, Institute of Clinical Medicine, Department of Obstetrics and Gynecology 2014 .
  27. Shreeve N, Cagampang F, Sadek K et al. Poor sleep in PCOS; is melatonin the culprit? *Hum Reprod* 2014; 28:1348–1353.
  28. Gao H, Meng J, Xu M et al. Serum Heat Shock Protein 70 Concentration in Relation to Polycystic Ovary Syndrome in a Non-Obese Chinese Population. *PLoS One* 2013;8: 67727.
  29. Zelko IN, Mariani TJ, Folz RJ. Superoxide dismutase multigene family: a comparison of the CuZn-SOD (SOD1), Mn-SOD (SOD2), and EC-SOD (SOD3) gene structures, evolution, and expression, *Free Radical Biology and Medicine* 2002;33(3):337–349.
  30. Norman RJ, Dewailly D, Legro RS et al. Polycystic ovary syndrome. *Lancet* 2007; 370(9588):685-97.
  31. Sumithra NU, Lakshmi RL, Menon N et al. Evaluation of oxidative stress and hsCRP in polycystic ovarian syndrome in a tertiary care hospital. *J Clinical Biochemistry* 2015;30(2):161–166.
  32. Peskin AV, Winterbourn CC. Assay of superoxide dismutase activity in a plate assay using WST-1, *Free Radical Biology and Medicine* 2017, 103(1): 188–191.
  33. Kuscu NK, Var A. Oxidative stress but not endothelial dysfunction exists in non-obese, young group of patients with polycystic ovary syndrome. *Acta Obstet Gynecol Scand* 2009;88(5):612-7.
  34. Turk HM, Sevinc A, Camci C. Plasma lipid peroxidation products and antioxidant enzyme activities in patients with type 2 diabetes mellitus, *Acta Diabetologica* 2002; 39(3):117–122.
  35. Likidilid A, Patchanans N, Sriratanasathavorn C. Lipid peroxidation and antioxidant enzyme activities in erythrocytes of type 2 diabetic patients.

- J Medical Association of Thailand 2010;3(6): 682–693.
36. Zhang D, Luo WY, Liao H et al. The effects of oxidative stress to PCOS. *Sichuan Da Xue Xue Bao Yi Xue Ban* 2008;39(3): 421-3.
37. Baskol G, Baskol M, Kocer D. Oxidative stress and antioxidant defenses in serum of patients with non-alcoholic steatohepatitis. *Clin Biochem* 2007; 40:776–80.
38. Aviram M, Rosenblat M, Billecke S et al. Human serum paraoxonase (PON1) is inactivated by oxidized low density lipoprotein and preserved by antioxidants. *Free Radic Biol Med* 1999; 26:892–904.
39. Gonzalez F. Inflammation in polycystic ovary syndrome underpinning of insulin resistance and ovarian dysfunction. *Steroids* 2012; 77(4): 300–305.

# Impact of Breakfast Habits on Physical Parameters and Academic Performance of Nursing Students

Nalini M.<sup>1</sup>, Sukesh<sup>2</sup>, Joyce Fernandes<sup>3</sup>

<sup>1</sup>Head of the Department, Mental Health Nursing, Nitte Usha Institute of Nursing Sciences, <sup>2</sup>Assistant Professor, Department of Mental Health Nursing, Nitte Usha Institute of Nursing Sciences, <sup>3</sup>Lecturer, Department of Mental Health Nursing, Nitte Usha Institute of Nursing Sciences

## Abstract

**Background:** Breakfast is an important meal of the day. Skipping Breakfast has become very prevalent among health science university students. Therefore, the present study was conducted to find the impact breakfast habits on the Body Mass Index (BMI), Haemoglobin and Academic performance.

**Methodology:** Eighty-one, first year undergraduate nursing students from the Nitte (deemed to be University), were taken for the study, after taking informed consent from them. Purposive sampling Technique was used to select the students. Students Breakfast habits were assessed by questionnaires, and haemoglobin (Hb) level was by lab investigation. Standard instruments were used to check the height and weight of the students.

**Results:** Revealed that the majority of the students (55.6%) skipped Breakfast. Also, the majority of them mentioned the reason for skipping Breakfast is lack of time, getting up late, not hungry, not interested in having Breakfast, and tasteless food. Beside, there was no significant difference found between BMI, Hb, and Academic Score in breakfast-skippers and non-skippers. Though the present study hasn't shown any impact of breakfast habits on physical parameters and academic performance, it may affect on total nutritional status of the students. So it's need of the hour to aware the students on the importance of regular Breakfast.

**Keywords:** Breakfast habits, BMI, Haemoglobin, Nursing Students, Academic Performance.

## Introduction

Adolescence is a crucial period, where rapid growth and development takes place. Having a regular and balanced diet in this period will ensure healthy development<sup>1</sup>. Breakfast is important meal of the day. Regular consumption of Breakfast is a part of a healthy

lifestyle. It should contribute around 20 to 30 percent of daily total energy needs<sup>2,3</sup>. Studies revealed that eating healthy breakfast results in a total positive nutritional outcome of children<sup>4</sup>. Also, Breakfast with an adequate level of tryptophan will help to gain beneficial effects on mental health. The mechanism of action is the conversion of tryptophan into serotonin in the day time, which is a natural antidepressant and serotonin to melatonin at night induces good sleep<sup>5</sup>. Thus, it may positively affect the mental health, cognitive functions, and academics of young people<sup>3</sup>. On the Contrary, skipping Breakfast is associated with mood disorders, cognitive impairment, overweight and obesity, and health risk behaviours such as smoking, bullying.<sup>6-8</sup>

---

### Corresponding Author:

#### Mr. Sukesh

Assistant Professor, Department of Mental Health Nursing, Nitte Usha Institute of Nursing Sciences, Paneer Campus Deralakatte, PIN: 575018  
e-mail: sukeshm@nitte.edu.in  
Mobile No.: 8861036103

Despite the known effect of Breakfast on physical and mental health, skipping Breakfast become prevalent

among adolescence<sup>6,9</sup>. A systematic review conducted showed that Breakfast is frequently skipped meal compared to other meals, with the prevalence ranging from 5% to 83%<sup>10</sup>. Besides newspaper article in the new Indian express revealed that three out of four does not eat healthy Breakfast, and one out of four skip breakfast in India<sup>11</sup>. Also, to support this, studies conducted in India revealed, breakfast skipping habits among school-going adolescents ranged from 30-50%<sup>12</sup>.

The prevalence rate is even high among Health science University students. The study conducted in Malaysian Health Science University revealed that the majority of students consume Breakfast between one to three times per week<sup>13</sup>. The data from the Saudi Arabian College of Health Sciences showed, 38.7% of the students eat Breakfast three to four times a week and daily by 49.9%<sup>14</sup>. Also, a study from Ghana revealed that 72% of Medical students skip the meal<sup>15</sup>. The research conducted in Iran told that 71% of nursing students skip Breakfast<sup>16</sup>. Beside a study conducted in Haryana, India showed 78.2% of B.Sc Nursing students skip a meal<sup>17</sup>. The reason given towards skipping Breakfast was to lose weight, no time, waking up late, not having Breakfast to eat, and not hungry<sup>13</sup>.

As from the above review, it is clear that breakfast skipping habits are prevalent among health science university students. Also, these reviews have shown that it has a deleterious effect on cognitive functions; thus, it may lead to poor academic performance. As there are very few studies in the field of Nursing concerning breakfast habits, the present study is done to know the prevalence of Breakfast skipping among first-year nursing students and its effect on academic performance, BMI, and Hb level.

## Method

A descriptive cross-sectional study was conducted to assess the breakfast habits and its impact on academic performance, BMI, and Hb level. After taking the informed consent total of 81 students of First Year B.Sc. Nursing was taken for the study. Purposive sampling technique was used to select the above students.

**Data Collection Instruments:** Initially, demographic characteristics of the participants such as age, gender, type of family, Residence, attendance, academic grade, diet preference, Height and weight,

frequency of having Breakfast per week were collected. Followed by reasons for skipping the Breakfast were assessed by checklist, which had 11 items. Five ml of blood was collected to determine the Haemoglobin level of students. Lab investigation was done at Justice K.S Hegde Hospital, Mangaluru. BMI was calculated by dividing weight in kg by the height in meters square. Classification of the BMI was made as per the WHO guidelines.

**Statistical Analysis:** Collected data were analyzed using SPSS software 22 version. Descriptive statistics such as frequency and the percentage was used to explain the demographic characteristics and to assess the reason for skipping Breakfast. An independent sample t-test was used to find the difference in the BMI, Hb, and academic marks of breakfast-skippers and non-skippers. P-value is < 0.05 level is considered significant.

## Result

**Socio-Demographic Characteristics:** In the present study, among 81 students, the majority of them were females (77%) belongs to the age group 17 to 19 (77%). Most of them from the nuclear family (77%) and stays in the Hostel (74%). The majority of them were having a normal BMI range (63%) and Hb level (81%).

**Table 1: Reason for skipping Breakfast (n=81)**

Reason for skipping Breakfast	Frequency	Percentage
Lack of time	67	82.71
Anxiety	10	12.34
Nauseated	7	8.64
Getting up late	47	58.02
Not hungry	46	56.79
Food allergy	2	2.46
No interest	27	33.33
Over weight	7	8.64
Tasteless Food	47	58.02
Fasting	9	11.11

Among 81 students, the majority of them said the reason for skipping Breakfast is lack of time (82.71%), getting up late(58.02%), not hungry (56.79%), not interested in having Breakfast (33.33%), and tasteless food (58.02%). (Table 1).

**Table 2: Difference in Hb level, BMI and Academic Marks of Breakfast skippers and Non-Skippers (n=81)**

		N	Mean	Std. Deviation	Mean Difference	df	T value	Sig. (p-Value)	Std. Error Difference
Hb	Non Skippers	36	13.044	1.6263	-.0022	79	-.006	.995	.3763
	Skippers	45	13.047	1.7267					
BMI	Non Skippers	36	20.786	2.9076	.7196	79	1.063	.291	.6771
	Skippers	45	20.066	3.1203					
Academic Marks	Non Skippers	36	61.11	12.723	3.133	79	1.181	.241	2.653
	Skippers	45	57.98	11.139					

Independent sample t-test Df-degree of freedom,  $p < 0.05$  is considered significant

An independent t-test showed that there is no significant difference in Hb level ( $t = -0.006$ ,  $p = 0.995$ ), BMI ( $t = 1.063$ ,  $p = 0.291$ ) and Academic marks ( $t = 1.181$ ,  $p = 0.241$ ) among Breakfast skippers and non-skippers. (Table 2)

## Discussion

The present study shows that prevalence of Breakfast skipping in nursing students is 55.6% which is lower compared to the study conducted at in nursing college of Haryana (78.2%)<sup>17</sup> and Iraq (71%)<sup>16</sup>. The reason could be a difference in the geographical area and batch of the students included in the study. Also, in the present study, only first-year students were taken.

In the present study, there is no significant difference found in the academic score, BMI and Hb between Breakfast skippers and non skippers. In contrast, Study in the USA, US and Jpan showed that skipping Breakfast associated with obesity<sup>18-20</sup>. However, study conducted on Canadian adults revealed that skipping Breakfast is not associated with obesity<sup>21</sup>. Also, a study conducted in Denpasar, and review of literature conducted on breakfast habits and academic performance has shown the significant relation<sup>22,23</sup>. In Contrary, A study conducted by Andiarna F(2018) and one more study by Amrin(2014) revealed that skipping Breakfast increases the risk of anaemia<sup>24</sup>. The discrepancy in the result may be due to the geographical area, and cultural background. Also, the majority of the students were from the first year and stayed in the Hostel. Adjustment to the new type of food could be the reason for skipping Breakfast

Also, present study majority of the subject revealed the reason for skipping Breakfast as lack of time (82.71%), getting up late(58.02%), not hungry (56.79%), not interested in having Breakfast (33.33%) and tasteless food (58.02%). Which is similar to the study conducted by ALBashtawy M (2017), where children revealed

the reason for skipping Breakfast was no enough time, nothing to eat, not hungry, poor appetite<sup>25</sup>.

In the present study, there are many limitations such as small sample size, including only first-year nursing students and self-reported questionnaires, which might have caused the response bias. The study could be conducted with a larger sample size to get an accurate result.

## Conclusion

Despite knowing the ill effects of Breakfast skipping its prevalent even in health science students. Though present findings show there is no significant effect of skipping Breakfast on BMI, Hb, and academic performance, it may affect the total nutritional status of students in the later period. Therefore creating awareness among students on the importance of breakfast habits is necessary.

**Ethical Clearance:** Was taken from Institutional Ethics committee Nitte Usha Institute of Nursing Sciences (Ref. No. NUINS/CON/NU/IEC/2018-19).

**Source of Funding:** This project was funded by Nitte (Deemed to be University).

**Conflict of Interest:** Nil

**Acknowledgement:** We acknowledge the Nitte (Deemed to be University) for providing the fund for the project. Also, we would like acknowledge the support given by Arathi A.S, Anet M Sebastian, Ann, Maria, Neethu Thomas, Sandra Prakash and Jeslita D'Souza, in the process of data collection.

## Reference

- Hu J, Li Z, Li S, Li H, Wang S, Wang S, et al. Skipping breakfast and physical fitness among school-aged adolescents. *Clinics (Sao Paulo)* [Internet]. 2020 [cited 2020 Sep 5];75:e1599. Available from: [http://www.scielo.br/scielo.php?script=sci\\_arttext&pid=S1807-59322020000100250&lng=en&nrm=iso&tlng=en](http://www.scielo.br/scielo.php?script=sci_arttext&pid=S1807-59322020000100250&lng=en&nrm=iso&tlng=en)
- Taha Z, Rashed AS. The Effect of Breakfast on Academic Performance among High School Students in Abu Dhabi. *Arab J Nutr Exerc* [Internet]. 2017;2(1):40. Available from: <https://knepublishing.com/index.php/AJNE/article/view/1243>
- Ünal G, Uzdil Z, Kökdener M, Özenoğlu A. Breakfast habits and diet quality among university students and its effect on anthropometric measurements and academic success. *Prog Nutr*. 2017;19(2):154–62.
- Bhattacharya J, Currie J, Haider S. Breakfast of Champions? The School Breakfast Program and the Nutrition of Children and Families. 2005.
- Sun J, Yi H, Liu Z, Wu Y, Bian J, Wu Y, et al. Factors associated with skipping breakfast among Inner Mongolia Medical students in China. *BMC Public Health* [Internet]. 2013 Dec 17 [cited 2020 Sep 6];13(1):42. Available from: <https://bmcpublikealth.biomedcentral.com/articles/10.1186/1471-2458-13-42>
- Ahadi Z, Kelishadi R, Qorbani M, Zahedi H, Aram M, Motlagh ME, et al. Association of Breakfast Intake with Psychiatric Distress and Violent Behaviors in Iranian Children and Adolescents: The CASPIAN- IV Study. *Indian J Pediatr* [Internet]. 2016/03/05. 2016;83(9):922–9. Available from: <https://www.ncbi.nlm.nih.gov/pubmed/26935200>
- Yao CDEF J, Liu BCD Y, Zhou S, Yao J. Effect of Eating Breakfast on Cognitive Development of Elementary and Middle School Students: An Empirical Study Using Large-Scale Provincial Survey Data. 2019; Available from: <https://www.medscimonit.com/abstract/index/idArt/920459>
- Goyal R, Julka S. Impact of breakfast skipping on the health status of the population. *Indian J Endocrinol Metab* [Internet]. 2014 [cited 2020 Sep 5];18(5):683–7. Available from: <http://pmc/articles/PMC4171892/?report=abstract>
- Vereecken C, Dupuy M, Rasmussen M, Kelly C, Nansel TR, Al Sabbah H, et al. Breakfast consumption and its socio-demographic and lifestyle correlates in schoolchildren in 41 countries participating in the HBSC study. *Int J Public Health* [Internet]. 2009 [cited 2020 Sep 5];54(SUPPL. 2). Available from: <https://pubmed.ncbi.nlm.nih.gov/19639257/>
- Pendergast FJ, Livingstone KM, Worsley A, McNaughton SA. Correlates of meal skipping in young adults: A systematic review [Internet]. Vol. 13, *International Journal of Behavioral Nutrition and Physical Activity*. BioMed Central Ltd.; 2016 [cited 2020 Sep 6]. p. 125. Available from: <http://ijbnpa.biomedcentral.com/articles/10.1186/s12966-016-0451-1>
- One out of four skip breakfast: survey- The New Indian Express. *The New Indian Express* [Internet]. [cited 2020 Sep 5]; Available from: <https://www.newindianexpress.com/cities/hyderabad/2018/sep/19/one-out-of-four-skip-breakfast-survey-1874432.html>
- Sundaram TNMJOI, Paul KR, Sudhakar M, Kumar A. Dynamics of growth and weight transitions in a pediatric cohort from India [Internet]. Vol. 31, *FASEB J*. 2018 [cited 2020 Sep 6]. Available from: <http://www.nmji.in>
- Seedat R, Pillay K. Breakfast consumption and its relationship to sociodemographic and lifestyle factors of undergraduate students in the School of Health Sciences at the University of KwaZulu-Natal. *South African J Clin Nutr* [Internet]. 2020 [cited 2020 Sep 6];33(3):79–85. Available from: <https://www.tandfonline.com/action/journalInformation?journalCode=ojcn20>
- Anuar K, Masuri MG. The association of breakfast consumption habit, snacking behavior and body mass index among university students. *Am J Food Nutr* [Internet]. 2011 [cited 2020 Sep 6]; Available from: <http://www.scihub.org/AJFN>
- Ackuaku-Dogbe EM, Abaidoo B. Breakfast eating habits among medical students. *Ghana Med J* [Internet]. 2014 Jun 1 [cited 2020 Sep 2];48(2):66–70. Available from: <http://dx.doi.org/10.4314/gmj.v48i2.2>
- KJ S, AA W, A Z. A study of eating habits among female nursing students in the university of Babylon/Iraq. *J Contemp Med Sci* [Internet]. 2016 [cited 2020 Sep 6];2(4):141–7. Available from: [https://www.researchgate.net/publication/320618327\\_A\\_](https://www.researchgate.net/publication/320618327_A_)

- study\_of\_eating\_habits\_among\_female\_nursing\_students\_in\_the\_university\_of\_BabylonIraq
17. Devi R, Devi SS, Singh SB. An exploratory study to assess the effect of breakfast skipping on college performance among Bsc nursing students in MM College of nursing, Mullana, Ambala. *Int J Appl Res* 2017 [Internet]. 2017;3(3):904–6. Available from: [www.allresearchjournal.com](http://www.allresearchjournal.com)
  18. Deshmukh-Taskar P, Nicklas TA, Radcliffe JD, O’Neil CE, Liu Y. The relationship of breakfast skipping and type of breakfast consumed with overweight/obesity, abdominal obesity, other cardiometabolic risk factors and the metabolic syndrome in young adults. the National Health and Nutrition Examination Survey (NHANES): 1999-2006. *Public Health Nutr* [Internet]. 2013 Nov [cited 2020 Sep 7];16(11):2073–82. Available from: [:/core/journals/public-health-nutrition/article/relationship-of-breakfast-skipping-and-type-of-breakfast-consumed-with-overweightobesity-abdominal-obesity-other-cardiometabolic-risk-factors-and-the-metabolic-syndrome-in-young-adults-the-national-health-and-nutrition-examination-survey-nhanes-19992006/C03EBBABDCB60753261A1495C341DA65](http://core/journals/public-health-nutrition/article/relationship-of-breakfast-skipping-and-type-of-breakfast-consumed-with-overweightobesity-abdominal-obesity-other-cardiometabolic-risk-factors-and-the-metabolic-syndrome-in-young-adults-the-national-health-and-nutrition-examination-survey-nhanes-19992006/C03EBBABDCB60753261A1495C341DA65)
  19. Sakurai M, Yoshita K, Nakamura K, Miura K, Takamura T, Nagasawa SY, et al. Skipping breakfast and 5-year changes in body mass index and waist circumference in Japanese men and women. 2017;
  20. Van Der Heijden AAWA, Hu FB, Rimm EB, Van Dam RM. A prospective study of breakfast consumption and weight gain among U.S. men. *Obesity*. 2007 Oct;15(10):2463–9.
  21. Barr SI, DiFrancesco L, Fulgoni VL. Association of breakfast consumption with body mass index and prevalence of overweight/obesity in a nationally-representative survey of Canadian adults. Vol. 15, *Nutrition Journal*. 2016.
  22. Widyanti PA, Sidhiarta IGL. Breakfast Habit and Academic Performance Among Suburban Elementary School Children. *J Ilm Kedokt* [Internet]. 2013 [cited 2020 Sep 7];56:3–7. Available from: <http://ojs.unud.ac.id/index.php/medicina/article/view/6823/5157>
  23. Adolphus K, Lawton CL, Dye L. The effects of breakfast on behaviour and academic performance in children and adolescents. *Front Hum Neurosci*. 2013;7(JUL):1–28.
  24. Hamidiyah A. “Analysis of Breakfast Habits on The Incidence of Anemia.” *Int Conf Sustain Heal Promot*. 2018;114–8.
  25. ALBashtawy M. Breakfast Eating Habits Among Schoolchildren. *J Pediatr Nurs* [Internet]. 2017;36:118–23. Available from: <http://dx.doi.org/10.1016/j.pedn.2017.05.013>

# Self Medication Practices among Youngsters: A Global Health Concern

Navdeep Kaur<sup>1</sup>, Bandana Bisht<sup>2</sup>, Manmeet Kaur<sup>3</sup>

<sup>1</sup>Vice Principal, Chitkara University College of Nursing, Chitkara University, Himachal Pradesh, India,  
<sup>2</sup>Principal, Chitkara University College of Nursing, Chitkara University, Himachal Pradesh, India, <sup>3</sup>Assistant  
Professor, Chitkara School of Health Sciences, Chitkara University, Punjab, India

## Abstract

Self medication is considered as key aspect of primary health care to treat minor symptoms. However, inappropriate practice of self medication and related potential dangers has become public health concern worldwide.

**Objectives:** This study aimed at assessing the prevalence and frequency of practicing self medication. Common self diagnosed Disorders and prime reasons for engaging in self medication were explored by the researchers. Also, association between self medication and various sociodemographic variables was also discovered.

**Method:** The study employed exploratory design. A self structured questionnaire was administered to 500 students of selected University. The data were summarized and analyzed using descriptive and inferential statistics.

**Results:** Overall 442 (88.4%) students practiced self medication and approximately 77% of study subjects consume self medications occasionally. Headache (84.4%), common cold (83.8%), cough (82.6%) and gastric acidity (81.8%) were the most common minor ailments for which self medication is being taken. Major driving factors behind self medication are considering minor ailments non- seriously (83%), easy availability of medicines (82%) and lack of trust in institute dispensaries (79%). Further, no significant association was found between self medication practices and age, gender, year of study, academic disciplines, parents' education level, place of residence. *Conclusion:* Prevalence of self medication is remarkably high among scholars which constitutes health concern that requires conduction of awareness programs on risk and benefit of self medication at university level and stringent laws on sale of medicines without current prescription needs to be enforced to control malpractice.

**Keywords:** *Self medication, Prevalence, malpractice.*

## Introduction

Self medication is a process of medicating oneself for self-diagnosed diseases. It involves consuming medicines without physician's advice, taking medicines on advice of pharmacist, relative or friend, using old prescriptions, sharing medicines with others and taking leftover medicines at home.<sup>1-4</sup> Key drives of self medication are inadequacies in healthcare system especially in developing world such as inaccessibility, inequitable distribution of health, high costs, patient's attitude and lack of healthcare resources.<sup>5</sup> Though, it

provides the patients' greater independence in managing minor ailments, hence enhance empowerment. Also, self medication is advantageous to health care system and people when practiced correctly as it reduces time spent in visiting doctors, decreases load on medical services and saves cost.<sup>6</sup> Despite these facts, major problem is an inappropriate use of self medication thus resulting in detrimental consequences such as masking of potential health problems, severe adverse effects, and antibiotic resistance. Hence, Self medication has become a widespread practice and is an emerging health issue across the globe especially in developing countries.<sup>7,8</sup>



The prevalence of self-medication practice has risen sharply worldwide especially in economically deprived countries owing to limiting health resources. Certain projected evidences shown that prevalence of self medication in developing nations is in the range of 12.7% to 95%.<sup>9-11</sup> Moreover, there are huge variations in practice of self medication among population due to factors such as at age, gender, self care orientation, education level, drug access and exposure to advertisements by pharmaceutical companies.<sup>9,10</sup> Further, the most common ailments for which self-medication is being practiced are fever, headache, diarrhea, constipation, common cold as reported by many researchers.<sup>11</sup> Moreover, people do not refrain from consuming antimicrobials for self-care that may lead to serious drug related problems such as antimicrobial resistance and toxicity.<sup>12,6</sup>

Although, many studies are conducted at community level to assess magnitude of self medication, but only few studies are done to estimate prevalence in practicing self medication in youngsters who belong to the most vulnerable population. Through this study, researcher tried to explore the data from students of selected university with aims of find out the prevalence of self medication, common condition for which self medication is being used, and also to identify the association between factors such as age, gender, parent's education level and self medication practices.

### Materials and Method

An exploratory study was conducted in selected university, Punjab, India in March, 2019. The sample size of 500 participants was determined using Power Analysis with formula as  $n = z^2 P (1-p)/w^2$  at 5%. Respondents from the available population were chosen with multi-staged cluster sampling. In stage one, five departments were chosen, and 100 students were selected from each of the five departments in second stage using simple random method. Ethical approval was taken from ethical review committee of university. Also, an informed written content of respondents was taken

with assurance of anonymity and confidentiality of data. Content validity of self structured tool was assured by five experts from departments specialized in pharmacy, nursing, health sciences and further data was collected using a pretested self administered questionnaire with closed and open ended questions. The respondents who were practicing self medication had to select/write the ailments for which they self medicate and the reason for such behavior. Finally, collected data was checked for completeness and analysis was done using SPSS latest version 25.

### Results

The sociodemographic characteristics of the respondents depicts that most of them were females (55.9%) and hostellers ((52.8%). Majority of study subjects were from age group 19-20 years (65.6%) and having parental education level up to graduation and above (mother - 71.6%, father- 78.8%) as shown in table 1. Approximately 88% of the respondents admitted to self medication practice and majority of subjects 77.3% used self medication for treating minor illnesses occasionally as depicted in figure 1 and 2 respectively. Most common ailment for self medication is pain (84.40%), followed by respiratory problems (83.8%), gastrointestinal problems (81.8%) and other health problems (83.2%) as seen in table 2. Further, in pain, majority of respondents consume self medication for headache (84.8%), cold (83.8%) is the common respiratory condition for which self medication is being practiced whereas acidity (81.80%) and fever (83.2%) is the most common ailment in gastrointestinal and other problem for self medication respectively. Most common determinants that lead to self medication among youngsters were non- seriousness of illness (83.4%), easy availability of drugs (82%), lack of trust in institute dispensary (79.2%), Previous Prescriptions (74%), convenience (39%) and costly medicines prescribed by doctors (33%, table 3). Self medication practice was found not to be significantly associated with any of the sociodemographic variables.

**Table No. 1: Frequency and percentage distribution of socio-demographic variables. N = 500**

Variables	Opts	Percentage Distribution (%)	Frequency (f)
Age (in years)	19 to 20	65.6%	328
	21 to 22	33.4%	167
	23 to 24	1.0%	5
	24 to 25	0.0%	0

Variables	Opts	Percentage Distribution (%)	Frequency (f)
Gender	Male	44.2%	221
	Female	55.8%	279
Educational Status of Mother	Primary	1.4%	7
	Metric	13.6%	68
	Senior Secondary	13.4%	67
	Graduation and above	71.6%	358
Educational Status of Father	Primary	0.6%	3
	Metric	4.4%	22
	Senior Secondary	8.6%	43
	Graduation and above	78.8%	394
Place of Present Stay	Hostel	52.8%	264
	Home	45.4%	227
	Paying guest (PG)	1.6%	8

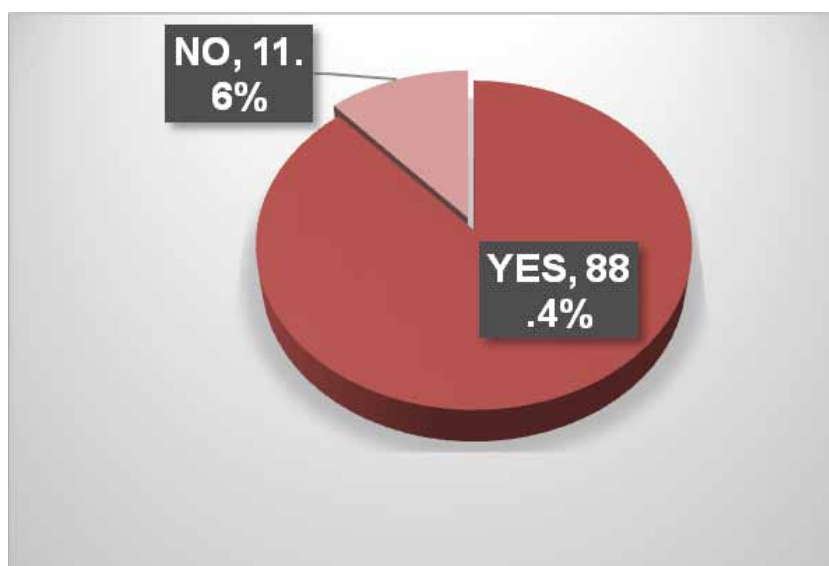


Fig no. 1: Prevalence of self-medication

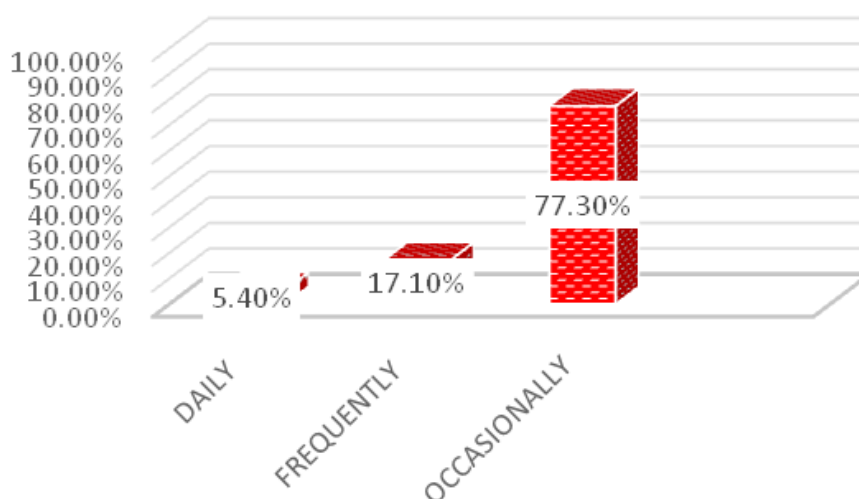
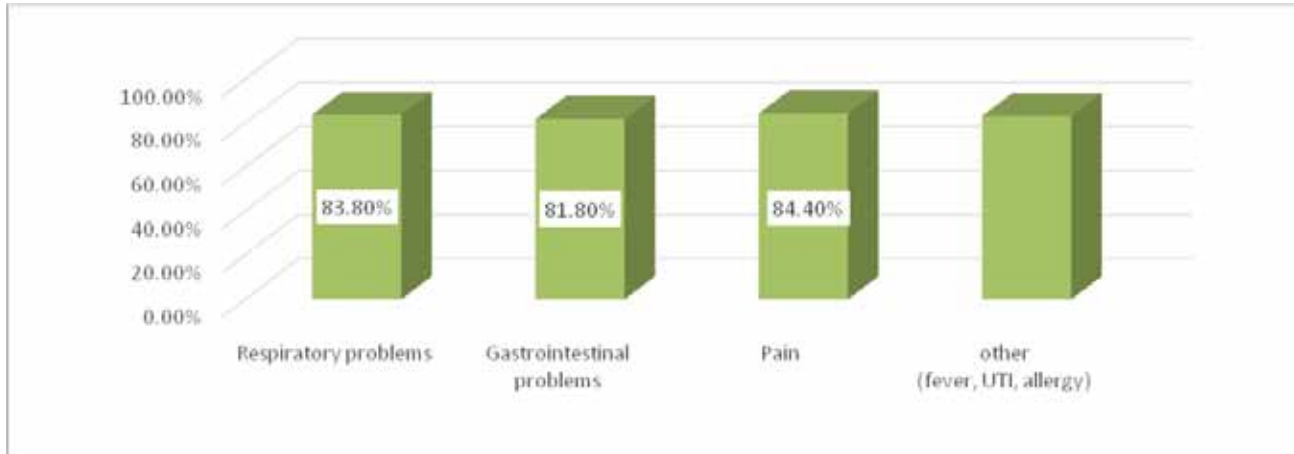


Figure No. 2: Frequency of practicing self-medication among students.

**Table 2: Common minor ailments for which self-medication is being used (N=442)**



**Table 3: Factors leading to self-medication among students N=442**

Variables	Percentage (%)	Frequency (f)
Convenience	39%	195
Non- seriousness of illness	83.4%	417
Lack of trust in institute dispensary	79.2%	396
Easily available drugs	82.0%	410
Costly medications prescribed by doctors	33%	146
Previous Prescriptions	74.2%	371

**Discussion**

Prevalence of self medication is increasing worldwide particularly among youngsters and university students.<sup>13,14</sup> Many factors like readily available medicines, lack of accessible health services, extensive advertisement are leading causes of such practice.<sup>15,16</sup>

The findings of this revealed that the prevalence of self-medication is 88% among the university students and 77.3% respondents practice self medication now and then. The prevalence is considerable high and similar results were found in students of Bangladesh (100%), Brazil (86.4%), South India (92%) and South-west Nigeria (91.4%).<sup>17,20</sup> However, lower prevalence of self medication was reported by few studies as many university students declared not to self medicate.<sup>21,22</sup> In few, this difference could be attributed to the drug laws of country, accessibility to quality health services and discipline of the students

The results of this study reported that most common health problem that encouraged self-medication practice was pain (headache), followed by respiratory problems

like cold, cough, then gastrointestinal problems such as acidity and, lastly for fever, UTI and allergies. Similarly, some studies reported comparable observations in which headache, common cold and fever were leading ailments for such practice<sup>23, 11</sup> where studies conducted in Egypt and western Nigeria found sore throat, intestinal colic, cramps and urinary tract infection, diarrhea as main complaints that lead to self medication respectively.<sup>24, 25</sup> These variations in findings could be because of different study population in all studies.

In the current study, causative factors for self medication practice among university students were non- seriousness of illness (83.4%), easy availability of drugs (82%), lack of trust in institute dispensary (79.2%) using previous prescriptions (74%). Various studies revealed many different reasons for indulging into self medication.<sup>20, 26, 27</sup> These reasons can be attributed to the fact the practice of self medication is influenced by several factors such as family, advertising, having previous experience, financial constraints. Not only this, seeking advice from pharmacists and friends to overcome the obstacles related to medical care cost and

dissatisfaction with medical care, lead to irrational self medication.

In present study, no association was found between self medication practice and sociodemographic variables. On the contrary, previous studies found that females tend to self medicate more as compare to males and this gender difference could be related to special health conditions in women like menstruation.<sup>28</sup> In addition to this, self medication is more common in residents of urban as per former studies. Reason for such variation can be described by difference in accessibility of health services.<sup>24</sup>

### Conclusion

This study concluded that majority of university students engaged into self medication practice, and headache, cold, gastric acidity are the minor diseases for which self medication is being practiced. Further, non-seriousness about mild-illness, availability of drugs, lack of trust in institute dispensary and previous knowledge about disease were the main driving forces for indulging into self medication. Self medication, when used appropriately may not be harmful, but, it's inappropriate use poses a threat. So, awareness programs must be inculcated at university level to enlighten the youth about benefits and risks of self medication.

**Limitations:** One of the limitations is that analysis of this study was based on self report with chances of over and under reporting. Also, results of current study cannot be generalized to students of other universities of state and nation.

**Conflicts of Interest:** The researchers, hereby, declare there are no conflicts of interest related with present study or with materials and procedures used in this study.

**Ethical Clearance:** Ethical approval was taken from institutional ethical committee.

**Funding:** No

### References

- Selvaraj K, Kumar GS, Ramalingam A. Prevalence of self-medication practices and its associated factors in Urban Puducherry. *Perspect Clin Res*. 2014 Jan-Mar; 5(1): 32–36.
- Esan D T, Fasoro AA, Odesanya OE, Esan TO, Ojo EF, Faeji CO. Assessment of Self-Medication Practices and Its Associated Factors among Undergraduates of a Private University in Nigeria. *Journal of Environmental and Public Health* Volume; 2018, Article ID 5439079, 7 pages <https://doi.org/10.1155/2018/5439079>
- C. M. Hughes, J. C. McElnay, and G. F. Fleming, “Benefits and risks of self medication,” *Drug Safety* 2001; 24(14):1027–1037.
- Z. Klemenc-Ketis, Z. Hladnik, and J. Kersnik. Self-medication among healthcare and non-healthcare students at university of Ljubljana, Slovenia. *Medical Principles and Practice* 2010;19(5):395–401.
- Bakri A, Bustanji, & Wazaify. Factors contributing to problems with medication use. *Social and administration aspects of pharmacy in low-middle income countries*; 2008: 249.
- Ruiz ME. Risks of Self-Medication Practices. *Curr Drug Saf* 2010 Oct; 5(4):315-23.
- H. Bauchner and P. H. Wise. Antibiotics without prescription: bacterial or medical resistance. *The Lancet* 2000;355: 1480–1484.
- P. Calabresi and L. M. Cupini. Medication-overuse headache: similarities with drug addiction. *Trends in Pharmacological Sciences* 2005; 26(2):62–68.
- Klemenc-Ketis Z., Hladnik Z., Kersnik J. Self-medication among healthcare and non-healthcare students at University of Ljubljana, Slovenia. *Medical Principles and Practice*. 2010;19 (5):395–401.
- Bennadi D. Self-medication: a current challenge. *Journal of Basic and Clinical Pharmacy*. 2014; 5 (1):19–23.
- Abay SM, Amelo W. Assessment of self-medication practices among medical, pharmacy, and health science students in Gondar University, Ethiopia. *J Young Pharm*. 2010; 2:306–10.
- Loyola Filho AI, Lima-Costa MF, Uchôa E. Bambuí project: A qualitative approach to self-medication. *Cad Saude Publica*. 2004; 20:1661–9.
- G. B. Gutema, D. A. Gadisa, Z. A. Kidanemariam et al. Self-medication practices among health sciences students: the case of Mekelle University. *Journal of Applied Pharmaceutical Science* 2011; 1 (10): 183–189.
- H. James, S. S. Handu, K. A. J. Al Khaja, S. Otoom,

- and R. P. Sequeira. Evaluation of the knowledge, attitude and practice of self-medication among first-year medical students. *Medical Principles and Practice* 2006; 15(4): 270–275.
15. D. Galato, L. D. M. Galafassi, G. M. Alano, and S. C. Trauthman. Responsible self-medication: review of the process of pharmaceutical attendance. *Brazilian Journal of Pharmaceutical Sciences* 2009; 45(4): 625–633.
  16. Hussain A and Khanum A. Self-medication among university students of Islamabad, Pakistan—a preliminary study. *Southern Med Review* 2008. 1(1): 14–16.
  17. N. Alam, N. Saffoon, and Uddin R. Self-medication among medical and pharmacy students in Bangladesh. *BMC Research Notes* 2015; 8 (1): 763.
  18. M. G. Corrêa da Silva, M. C. F. Soares, and A. L. Muccillo-Baisch. Self-medication in university students from the city of Rio Grande, Brazil. *BMC Public Health* 2012; 12 (1): 339.
  19. K. P. Osemene and A. Lamikanra. A study of the prevalence of self-medication practice among university students in southwestern Nigeria. *Tropical Journal of Pharmaceutical Research* 2012; 11(4): 683–689.
  20. S. Badiger, R. Kundapur, A. Jain et al. Self-medication patterns among medical students in South India. *Australasian Medical Journal* 2012; 5 (4) :217–220.
  21. De Aquino D S, De Barros J A C, and Da Silva M D P. Self-medication and health academic staff. *Ciencia e Saude Coletiva* 2010; 15 (5): 2533–2538.
  22. C. Buke, M. Hosgor-Limoncu, S. Ermertcan et al. Irrational use of antibiotics among university students. *Journal of Infection* 2005; 51 (2):135–139.
  23. Kumar N, Kanchan T, Unnikrishnan B, Rekha T, Mithra P, Kulkarni V, et al. Perception and practices of self-medication among medical students in costal South India. *PLoS One*. 2013; 8(8):e72247.
  24. R.M. Helal and H.S. Abou-Elwafa. Self-medication in University students from the city of Mansoura, Egypt. *Journal of Environmental and Public health* 2017; 10:1-7.
  25. R. K. Verma, L. Mohan, and M. Pandey. Evaluation of self-medication among professional students in North India: proper statutory drug control must be implemented. *Asian Journal of Pharmaceutical and Clinical Research* 2010; 3(1): 60–64,
  26. D. D. Goel. Self-medication patterns among nursing students in North India. *IOSR Journal of Dental and Medical Sciences* 2013. 11(4). 14–17.
  27. A. Auta, D. Shalkur, S. Omale, and A. H. Abiodun. Medicine knowledge and self-medication practice among students. *African Journal of Pharmaceutical Research and Development* 2012; 4 (1): 6–11.
  28. Lukovic JA, Miletic V, Pekmezovic T, Trajkovic G, Ratkovic N, Aleksic D, Grgurevic A. Self-medication practices and risk factors for self-medication among medical students in Belgrade, Serbia. *PLoS One*. 2014; 9(12):e114644.

# Service Quality Assessment of Higher Education by Gray Approach (The Case of Kerbala University)

Nawal Mousa Almeyali<sup>1</sup>, Ali Al Mousawi<sup>2</sup>

<sup>1</sup>BSc, MSc, Quality Assurance Unit-College of Medicine-University of Kerbala, <sup>2</sup>MChB, MSc. In Community Medicine Assistant Professor at the Department of Family and Community Medicine-College of Medicine-University of Kerbala

## Abstract

The quality of higher education has become one of the main challenges facing educational systems in the last two decades. The promotion of services in the field of education and scientific research require active management that continuously improves academic services.

In this study, after identifying the indicators of the quality of higher education services, a questionnaire was distributed to 15 experts in order to elite the quality of higher education services in the university to assess these indicators and select the best effective ones. Then, a second questionnaire was provided to eight experts to evaluate the performance and the weight of these criteria in the university by using Gray weights.

The result of research revealed that the staff has the highest score and the university has a solid foundation. In order to reduce the existing gap, relevant academic subjects related to the disciplines need to be provided. Access to administrative services was improved, as well as electronic office services tailored to students' needs. In order to reduce the gap created for the environmental index, wider green space need to be developed within the university and increasing the opportunity for free web access and free access to valid and up-to-date scientific resources are needed.

**Keywords:** Service Quality, Higher Education, Gray Weighting, University of Kerbala. Introduction.

## Introduction

We live in the Information Age characterized by the emergence of modern information and communication technologies<sup>(1)</sup>. The educational system in every country is one of the most complicated social, economic and cultural sub-systems, and is considered as an influential factor in the realization of national macro policies. Considering the wide expansion of educational system activities, qualitative management of the educational system can play an important role in providing better institute's quality of education (Bazargan, 2015)<sup>(2)</sup>. On the other hand, higher education is a source for inspiration and form the foundation for the development and advancement of any society<sup>(3)</sup>.

To reach the goal of effective education in any educational institution; it is essential to establish an efficient teaching-learning process which could be comprehensively assessed in a framework of an

effective behavioral system<sup>(4)</sup>. For this reason the higher education systems in most countries in the world have established a quality management system in order to pay more attention to the quality of education, in addition to improving research and supplying of specialized services. The identification and evaluation an appropriate framework for managing the quality of higher education is one of the requirements for the success of higher education institutions for sustainability, advancement and growth.

The higher education system as a part of every country's educational system plays a critical and essential role in the development of various dimensions of economic and social and cultural development<sup>(3)</sup>. Indeed; the growth and development of all systems in the society are dependent on the development of quantitative and qualitative dimensions of its higher education. In other words, the growth and development

of countries are tied to their educational system. Graduates of universities are responsible for government and society leading, cultural empowerment, originality, innovation, modern technology management, industry, trading and national security of a country. In the present era, the attention of the people and especially, the youth towards the educational system has been significantly increased. This is accompanied by an increase in the output expectations of the people from these institutions. Therefore, universities, on one side, should improve the quality of their services and on the other side, should have a continuous evaluating and observing system. Such body or system can monitor their current status and make plan for future improvements in these organizations. In the event of any problem; lack of a performance assessing system means losing links with the internal and external factors of the organization that are very important predictors of optimal performance. Indeed, the results of this performance assessment will be an improvement in the organization's activities since the organization cannot function without identifying the challenges and weaknesses that need rapid improvement<sup>(5-7)</sup>.

In recent decades, the higher education system faces significant issues due to the growth of the technical procedure, wide-ranging social, economic and cultural changes and the urgent need for meeting the expanding needs of the community. A meta-synthesis approach was tried to designing a conceptual framework had concluded that out of 52 papers only 42 of them have mentioned codes and factors relevant to the infrastructure<sup>(8)</sup>.

The assessment of quality techniques for identification of the differences and similarities surrounding quality improvement efforts covers each of three service areas typically found in higher education: academic, administrative, and auxiliary functions<sup>(9)</sup>. To assess the quality of services, Shick and Partners (2007) have designed a Deep Learning Skoval model (D.L. Skoval model) based on the combination of models of SERVQUAL and E.S.Q. The designed model has 12 indices: reliability, accountability, trust, empathy, merit, politeness, availability, efficiency, security, flexibility and communication. The Institute of Higher Education for Politics in Washington, DC, has conducted comprehensive studies in guaranteeing quality. Their research results in 2009 showed that organizational support, course development, teaching/Learning, course structure, students support, faculty support, evaluation and valuation are the essential factors in ensuring learning organization<sup>(7)</sup>. Many external studies in the

field of multi-criteria decision making have been done to deal with the ambiguity of judgment. Several effective phase models and linear programming models have been presented. However, in recent years, after the presentation of the theory of Gray system by Deng and despite this theory being young and new, it has been used to find the solution for the problems in various fields of science, especially in regards of modeling, prediction, Gray relation analysis, and Gray decision making.

In most cases where the goal is choosing the preferred option and ranking options in uncertain conditions, Gray decision making has been used as a powerful method. Other foreign backgrounds are listed in the table below. In this table, in addition to the author and year of research, the studied university and results of the research are also presented. In Gray relational analysis method analysis method depends on Gray system theory<sup>(10)</sup>. According to the similarity or difference of the developmental trend among the factors, it could measure the relevancy among factors "Gray relevancy". The Gray relational analysis method could be used to describe the relative changes among factors in the system development process. If the relative changes of the two were basically the same in the development process, we could consider the relevancy between them is large, while, conversely, the relevancy is small. In the real world, the relevancy among many factors is Gray, namely the overall information and mutual relevancy is "indefinite". Therefore, when analyzing the relationship between two factors, we could apply the concept of relevancy to measure the relation between each factor and describe their relative changes quantitatively.

Ghasemi and Ahmadi (2013)<sup>(11)</sup>, Evaluated Higher Education Institutes Performance in Zanjan province by BSC and GAHP. They used a new model is implemented for ranking the institutes. The research population includes 21 faculty members selected by random sampling. 3 separate questioners collected data, analysed by SPSS software, and weighted by Team Expert Choice software. The results of this research showed that in non-profit institutes of higher education, the most important criteria include higher income, reliability and number of students accepted for higher education.

Recently Ghasemi and Alizadeh (2017) use GMCDM technique to assess antifragility's performance of Iran Banknote papers. Table 1 summarised mentioned research<sup>(12)</sup>.

**Table 1: Summary of research background**

Author	Year	University	Goal and model used
Owlia and Aspinall <sup>(13)</sup>	1996	Birmingham university	They presented a new framework for the dimensions of the quality of higher education services.
Waugh <sup>(14)</sup>	2002	Administrative quality in Australia.	He suggested a model for the University's administrative quality.
Lalovic <sup>(15)</sup>	2002	The Belgrade university	He presented an evaluation model using the Six Sigma methodology.
Lagrosen, Hashemi, and Leitner <sup>(16)</sup>	2004	University of Australia and Sweden	They evaluated dimensions of service quality in higher education institutions and compared these dimensions.
Yang, Yan-ping, and Jie <sup>(17)</sup>	2006	China Higher education	They studied two. They suggested a suitable model for evaluating the quality of service in China using the SERVQUAL model.
Tsinidou <sup>(18)</sup>	2010	Turkey	They studied two universities in Turkey and concluded that students care most about the two dimensions of empathy and quality of service.
Noaman <sup>(19)</sup>	2010	Higher education institutes in Greece	Decision-makers in higher education service quality were identified.
Ghasemi and Ahmadi <sup>(11)</sup>	2013	Nonprofit Higher education institutes in Zanjan province (Iran)	Evaluation of Higher Education Institutes Performance by BSC and GAHP
Ghasemi and Alizadeh <sup>(12)</sup>	2017	Antifragility Assessment	Application of Gray MCDM to antifragility assessment of Iranian Banknote papers.

**Source:** Noaman, Amin Yet al. (2014)<sup>(19)</sup>

The literature review showed only few studies in Iraq evaluated the service quality in higher education. A study assessing the private open university in a study in a tourism college in Mosul in 2007 reported that technical and administrative level was low<sup>(20)</sup>. While a more recent study in the College of Tourism Sciences concluded that there is a kind of good performance related for the organization, planning and evaluation, and support for users, but there is a Kind of average performance related to resources and facilities<sup>(21)</sup>. Another study in the Administration and Economics College at the university of Anbar concluded that the quality team lacks accountant of quality costs which made a weak in detailed documentation of quality costs<sup>(22)</sup>. While a study in Baghdad University tried to determine the links between strategic planning and entrepreneurial quality through a survey among 65 academic staff in three faculties concluded that a significant association was found<sup>(23)</sup>. Additionally, a study in Dewaniyah Technical Institute concluded that building a knowledge Society is fundamental point for students satisfaction<sup>(24)</sup>.

### Methodology

Tsinidou, Noaman, Ragab, Madbouly, Khedra and Fayoumi<sup>(18)</sup>, in their research titled "Higher Educational Quality Assesment Model to achieve educational quality

standards " at King Abdulaziz University (Saudi Arabia) presented HEQAM model for improving academic services. This model has eight main dimensions (curriculum, academic staff, business perspective, infrastructure, e-services, library services, office services and environments).

### Research Methodology:

#### Method of data collection

The most important method of data collection in this study were as follows:

1. Library study: In this field to collect information in theoretical Foundations and topic research literature; library resources, articles, books and the internet have been used.
2. Field researches: In this section, a questionnaire was used to collect data and information for analysis. The questionnaire is a highly structured technique for collecting data, in which for each answer the same set of questions are asked. The mentioned questionnaire includes:

**(a) General questions:** In general questions, the attempted concentrates on collecting project-



doers' profile, general and demographic information of respondents.

**(b) Particular questions:** This section contains 57 questions related to various factors adapted to the literature of the subject. When designing this section, questions have been tried to be as

short as possible, hence easily understood, and to avoid asking negative questions. To design this section, the 5-option Likert spectrum has been used, which is one of the most common measurement scales.

**Table 2: The questionnaire preparation guide**

Factor name	Number of questions	Reference
Educational program	6 Questions	SERVQUAL (Parasuraman et al. ), 1985) <sup>(25)</sup>
Staff	11 Questions	SERVQUAL (Parasuraman et al. ), 1985) <sup>(25)</sup> Noaman,Amin et al (2014)(19)
Infrastructures	7 Questions	SERVPERF (Cronin and Taylor, 1992) and SERVQUAL (Parasuraman et al., 1985) <sup>(25)</sup>
Environment	6 Questions	HEdPERF (Abdullah, Firdaus 2006) <sup>(26)</sup>
Office services	10 Questions	Noaman, Amin Yet al. (2014)(19)
Library services	6 Questions	HEdPERF (Abdullah, Firdaus, 2006) <sup>(26)</sup> , (Noaman, Amin Y et al. (2014) <sup>(19)</sup>
Electronic services	5 Questions	HEdPERF (Abdullah, Firdaus, 2006) <sup>(27)</sup>
Job perspectives	6 Questions	Noaman, Amin Y et al. (2014) <sup>(19)</sup>

In each research, various stages are gone through. In many books, a precise number of research steps have been mentioned, such as the formulation and clarification of an issue or a topic, literature review, research design, data collection, data analysis, and writing. However, Sanders and colleagues (2009)<sup>(28)</sup>, believe in rare cases, all of these steps happen in a row, without going back to the previous stages. In reality, we may want to go back to the previous stages and review our operations. Every time previous stages are rectified, the idea of research slightly changes, and this change is reflected in all stages of the research. However, in this research, it has been attempted to do the research process in a reasonable order.

After preparing a long list of criteria, it is the time for their refinement and screening. The reason for this is the high number of extracted criteria, preventing the possible reduction of the accuracy in completing questionnaires related to the weight of selected criteria, and the likelihood of an increase in inconsistency rates in experts responses. Screening of the extracted criteria was done by using a survey on experts about determining the most important criteria affecting the quality of education services according to a Likert spectrum. In order to have the necessary validity for this questionnaire, it was attempted to avoid using complex phrases as far as possible. To assess the reliability of this questionnaire,

the Cronbach Alpha has been used. The estimated value of this index for the whole questionnaire was 0.927.

Then, after collecting completed questionnaires and in order to distinguish criteria with a higher degree of significance, the binomial test (sometimes called the ratio test) was used.

The assumptions of the mentioned test are as follows, in which the null hypothesis ( $H_0$ ) which expresses the lack of effect for the variable and an alternative hypothesis ( $H_1$ ) which expresses the presence of effect for the variable.

**Equation 1:**

$$\begin{cases} H_0: P = P_0 \\ H_1: P \neq P_0 \end{cases}$$

After distributing the questionnaire and collecting information through the binomial test (ratio), the most critical indices were extracted and became the base of the research. **Giving Weight to the criteria using the Gray method**

During the initial step, the analysis process was formulated by a group of eight specialists in a targeted manner with already-mentioned explanations. These specialists answered the questionnaire related to

identifying eight qualitative components that resulted in the presentation of 28 characteristics in the university.

Choosing approximate language terms for evaluating performance rate and weight of the importance of qualitative characteristics

To help professionals while allocating the performance rate of qualitative characteristics; linguistic

terms in Likert scale were chosen as Excellent, very good, good, fair, poor, very poor, worst. In order to assess the importance of weighting the qualitative characteristics, linguistic terms have been chosen as very high, high, fairly high, medium, relatively low, low, very low. The Gray triangular used numbers along with the linguistic variables during the research to facilitate analysis (Table 3).

**Table 3: The linguist terms and its peer Gray numbers**

Language terms	Gray numbers	Language terms	Gray numbers
The worst (w)	(0-1.5)	Very Low (VL)	(0-0.15)
Very weak (vp)	(1-3)	Low (l)	(0.1-0.3)
Fair (f)	(3-7)	Medium (m)	(0.3-0.7)
Very good (vg)	(7-9)	High (h)	(0.7-0.9)
Excellent (e)	(8.5-10)	Very High (vh)	(0.85-1)

Linguistic terms and synonyms Gray numbers (peer-to-peer) have been adapted by previously-performed studies about performance assessment related to qualitative assessment and was confirmed by the experts.

**Assessing the importance of gray weight of quality characteristic:** According to the following table, the weight of the lower and upper limit of the qualitative characteristics for each variable has been for Educational program, Staff, Infrastructure, Environment, Office services, Library services, Electronic services and Job perspectives: 0.894, 1, 0.832, 0.949, 0.982, 0.989, 0.892, 0.915, respectively. The highest weight is for the staff criterion (6.85-8.95), and the rest of the

criteria have been normalized. It seems that the staff in the university, in terms of experts and quality specialists, had acceptable performance. The lowest weight was assigned to the university infrastructure criterion (2.58-5.41). The other criteria were: educational program (3.72-6.81), environment (4.81-7.00), office services (4.75-7.58), library services (5.56-8.43), electronic services (4.88-7.12) and job perspectives (4.15-7.06).

**Performance rate of qualitative characteristics:** A detailed assessment of the expert assessment of the qualitative characteristics showed that very good (VG) assessment formed the majority of answers (%), 23 Out of 40, table 4).

**Table 4: Details of the expert assessment of the qualitative characteristics Integration of Gray rates and weights**

Qualitative Characteristics	Experts evaluation							
	E1	E2	E3	E4	E5	E6	E7	E8
Curriculum provides appropriate scientific subjects.	VG	VG	VP	VP	F	VG	E	F
The curriculum includes specialized courses (software education).	F	F	VP	E	F	F	F	F
University staff never turn down students' requests to cooperate	F	F	VG	VG	E	VG	E	VG
Staff have a good relationship with students.	VG	VG	E	VG	VG	VG	VG	VG
University staff spend adequate time to consults with students	VG	F	VG	VG	VG	VG	VG	VG

The arithmetic means, mode and median are method that are adapted to integrate multiple decision-makers assessments. The arithmetic mean due to its widespread use, have been used for research to integrate and unify comments, during the research. During the research, the arithmetic mean of Gray performance rate and arithmetic mean of performance rate for each characteristic has been determined by  $R_j$  and  $W_j$  symbols. Calculation of  $R_j$  and  $W_j$  through equation 1 and 2:

**Equation 1:**

$$R_j = (a_j \cdot c_j) = \frac{R_{j1} + R_{j2} + \dots + R_{jm}}{m}$$

**Equation 2:**

$$W_j = (x_j \cdot z_j) = \frac{w_{j1} + w_{j2} + \dots + w_{jm}}{m}$$

In order to unify and consolidate the Gray rates and the Gray weights used to determine the overall qualitative Gray index equation three have been used:

**Equation 3:**

$$GQI = \frac{\sum_{j=1}^n w_j \times R_j}{\sum_{j=1}^n w_j}$$

For example, the two qualitative characteristics of the curriculum and staff are calculated as follows:

**Curriculum Characteristic:**

$$\begin{cases} R_j = (6.81 \cdot 3.71) \\ W_j = (0.93 \cdot 0.74) \end{cases}$$

**Staff Characteristic:**

$$\begin{cases} R_j = (8.95 \cdot 6.85) \\ W_j = (0.94 \cdot 0.75) \end{cases}$$

**As a result, the integrated Gray index for two characteristics is calculated as follows:**

$$\frac{\sum_{j=1}^n w_j \times R_j}{\sum_{j=1}^n w_j} = \frac{[(6.81 \cdot 3.71) \times (0.93 \cdot 0.74)] + [(8.95 \cdot 6.85) \times (0.94 \cdot 0.75)]}{(0.93 \cdot 0.74) + (0.94 \cdot 0.75)}$$

Similarly, the integrated Gray index for all indices is calculated as a general index. After calculating the whole performance rate average and the arithmetic mean of Gray weights for all characteristics, according to

equation three the general integrated Gray quality index (GQI) of qualitative characteristic is  $GQI=(4.80,7.33)$ .

## Conclusion

**Determining the Euclidean Distance to Adapt to Approximate Level of Quality:** When the Gray quality index is obtained, it should be adapted to the language and verbal terms in order to determine the amount of quality level. During this study, the Euclidean distance method will be used for this purpose, since this is the best and most intuitive and understandable way for humans. In this study, linguistic expressions such as, Extremely Quality, Very Quality, Quality, Fairly Quality, Slowly Becoming Quality have been used in order to adapt and determine the quality level. Linguistic expressions and corresponding Gray numbers are given below:

Extremely Quality (EQ) = (8.5-10)

Very Quality (VQ) = (5.5-8.5)

Quality (Q) = (3.5-5.5)

Fairly Quality (FQ) = (1.5-3.5)

Slowly Becoming Quality (SQ) = (0-1.5)

**Then Euclidean distance is calculated as follows:**

$$D = \sqrt{\left[ \sum (f_{FAI}(x) - f_{ALI}(x))^2 \right]}$$

D(FA,EQ)=4.556601  
D(FA,FQ)=5.061145  
D(FA,Q)=2.2499

D(FA,VQ)=1.3585.1  
D(FA,Q)=7.557464

By comparing the values of the calculated Euclidean distances, it is observed that the lowest Euclidean distance is related to the Very Quality level; resultantly the qualitative performance level of the university is Very Quality level (VQ).

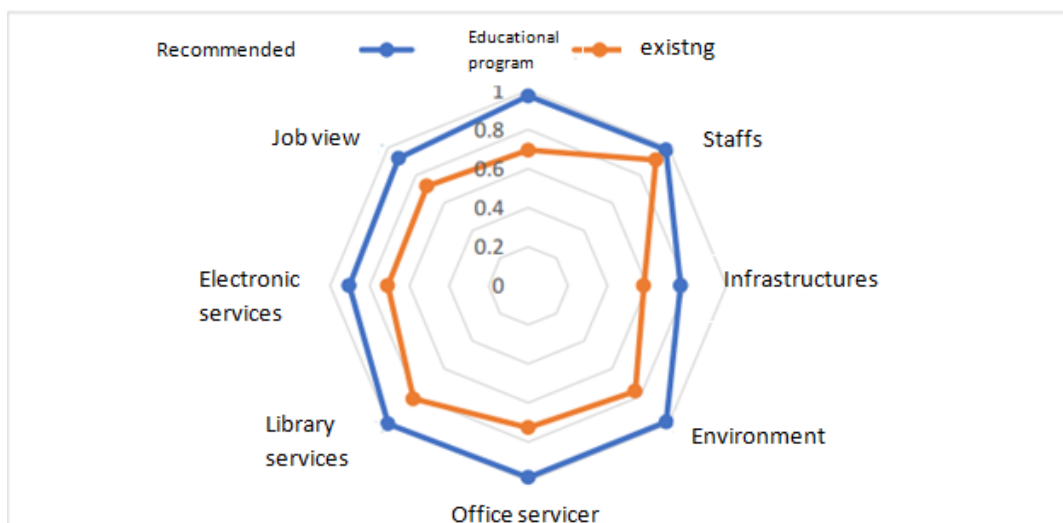
After Euclidean calculations of each criterion, the final result categorized based on indices is presented in table 7. According to the table below, most of the indices have a desirable quality in the studied university.

Infrastructure, environment and career prospects indices have lower quality in comparison with other indices. Therefore, quality improvement programs in these indices should be prioritized by university officials. The results showed that the Educational program, Staff, Infrastructure, Office services, Library services, Electronic services were in ‘‘very quality’’,

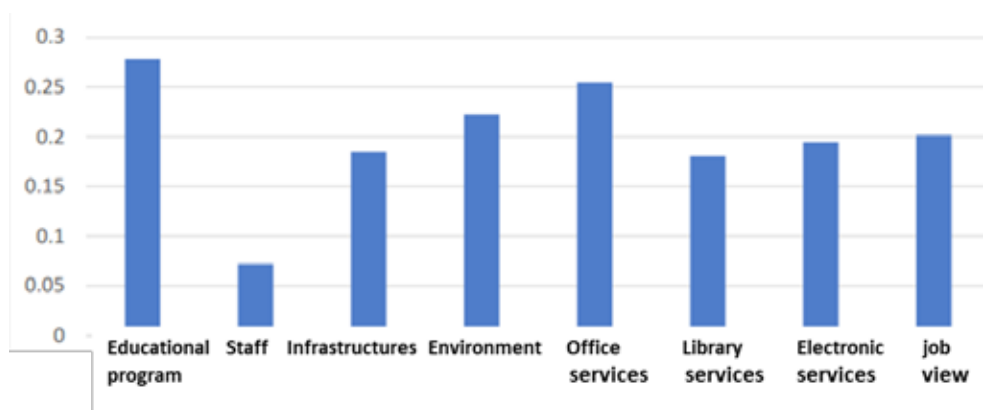
while was in ‘‘Satisfying quality’’ for Environment and job Perspectives.

As expected from the comparison of the status quo and desirable situation of quality of higher education services criteria, there is a significant gap between some criteria. This Figure has been presented below.

As mentioned beforehand, for assessing the quality of higher education services, eight indices at the current level and desirable level were evaluated among eight academic experts through a questionnaire approach. For calculating the importance of the main indices, the given points of sub-indices were averaged. Moreover, to reach a better analysis, all collected data were normalized and then analyzed.



**Figure 1: Comparison between existing status and recommended status of higher education services quality dimensions**



**Figure 2: The rate of guff in existing weights of quality dimensions in Kerbala university higher education services**

With a slight reflection in comparison of the current and desired weights, it can be understood that the lowest gap in staff index and the highest gap is in the university’s curriculum index. For a better analysis of the gap in weights of each criterion, the bar chart (Figure 2) is presented:

According to Figure 1 and by comparing the current and desired weights, it can be concluded that the lowest gap is staff index. In other words, it can be said that from the viewpoint of specialists and experts of the quality of Kerbala University, staff have performed their duties correctly and have the necessary commitment to perform their duties. Therefore, there is not a noticeable gap in this criterion.

## Results

1. It seems that considering achieved quality dimensions in this study can be used in assessing the quality of academic services. The results of the present study indicates that management process quality of departments at the university is rather desirable and requires planning its improvement
2. Looking at the obtained weights in the table showed that the staff have the highest weight. This means that the performance of the staff in the studied university is within acceptable limits. For this purpose, to maintain the status quo, an appropriate reward system can be established for the staff in the university.
3. Library services are ranked second. However, it could be understood that the provided library services at the university, as well as staff services, have a satisfactory level.
4. University environment: Due to the gap between the status quo and the desired situation, it is recommended to improve the available commuting services (such as provision of transportation services, precise timing and scheduling for commuting according to the peak hours of students attendance and improvement of covered routes in different spots of town), or partially, in routes where coverage of services is not possible. The cost of students' commute is partially paid by the student. Moreover, the development of parks and green spaces are also proposed due to the lack of enough space for the students.
5. Administrative and electronic services: According to Figure 2, the university situation in this criterion is far from being desired, and it is suggested that, in order to reduce the gap between the current and desirable status of this criterion, the administrative processes of the university should be clearly explained to freshmen. In addition, reviewing the administrative processes will provide students with fast, efficient and accurate services. Also, to facilitate the use of these services and access to them for students; it is necessary to synchronize the hours of administrative services with hours of student attendance at the university. Due to the nature of the administrative service; these services should be provided electronically with appropriate technical support to avoid loss of time and money. Also, appropriate communication tools (such as telephone operators) should be used to address student problems in different service units.
6. Library Services: To overcome the gap between the status quo and the desirable condition in this criterion, the university is recommended to update bookshelves and add books published in recent years to the shelves. Necessary facilities for students to access to new profiles and valid journals should be provided. Development of electronic library services (such as the extension of fines payment for late delivery of books and others). Considering copyright law, an e-book sharing network for students should be followed. Also, selecting the right place (that has enough lighting, internet access, providing reading equipment, and others) of the library for students to study.
7. Career perspective: To bridge the gap between the current situation and the desired situation in this criterion, it is suggested that a unit called "Relationships with Business" should be established that allows students to get acquainted with different occupational fields and get familiar with new job titles and opportunities. Also, negotiating with foreign universities provide students with the opportunity to continue studying abroad. A road map for different fields should be providing to make clear to students their career perspectives.
8. Curriculum: According to Figure 2, the biggest gap between the current and desired status is in this criterion. Therefore, it is suggested that firstly a good academic program should be provided; secondly, by offering special courses (including up-to-date software training programs), they improve this important dimension. (To any one to five) . Also, given the assigned weight to each criterion (Table1), this one has a good weight.
9. Staff: This qualitative dimension has the lowest between the current and the desired status. Also, the assigned weight for this criterion is the highest. Therefore, university authorities are suggested to set up a rewarding system proportionate to staff's performance and by providing better facilities, they try to maintain the status quo or even improve it.
10. Infrastructure: This criterion has attained the lowest weight. It seems that the university did not perform well in providing infrastructure and electronic services, including well-equipped buildings, green Service quality assessment in higher education,

and the case of Technological Educational Institute (TEI), Greece. In 9th International Conference on Marketing and Development: Marketing Contributions to Prosperity and Peace (pp. 8-11). spaces, sports facilities, well-equipped classrooms and laboratories, and medical facilities. Also, the gap between the existing and desirable situation of these dimensions are almost equal and worth pondering. Therefore, it is recommended that the university officials improve the existing situation by improving the university's infrastructure facilities (including building well-equipped buildings and laboratories, providing appropriate treatment facilities, expansion internet services, and others).

**Ethical Clearance:** Taken from Kerbala Medical College ethical committee

**Source of Funding:** Self funds

**Conflict of Interest:** None

### References

- Alcácer J, Cantwell J, Piscitello L. Internationalization in the information age: A new era for places, firms, and international business networks? : Springer; 2016.
- Bazargan A. Educational evaluation concepts, models and operational processes. Tehran: SAMT Publishers. 2001.
- Irby DM, Cooke M, O'Brien BC. Calls for reform of medical education by the Carnegie Foundation for the Advancement of Teaching: 1910 and 2010. *Academic Medicine*. 2010;85(2):220-7.
- Zeithaml V, Bitner M, Gremler D. *Services Marketing* McGraw Hill. New York. 1996.
- Rezaeian N, Shirvanizadeh N, Mohammadi S, Nikkhah M, Arab SS. The inhibitory effects of biomimetically designed peptides on  $\alpha$ -synuclein aggregation. *Archives of biochemistry and biophysics*. 2017;634:96-106.
- Brown Jr J. *Assessment matters in higher education*: McGraw-Hill Education (UK); 1999.
- Sharaf M, Mirzaei Karzan A, Mazbui S. Internal Evaluation in the Higher Education System: A Case Study in Iran. *Journal of Research in Educational System*.5(14):147-67.
- Dokouhaki H, Zarifsanaiey M, Zarifsanaiey N. A Meta-Synthesis Approach to Designing a Conceptual Framework for Mobile Learning in Higher Education. 2019:1-13.
- Quinn A, Lemay G, Larsen P, Johnson DM. Service quality in higher education. *Total Quality Management*. 2009;20(2):139-52.
- Julong D. Introduction to grey system theory. *The Journal of grey system*. 1989;1(1):1-24.
- Ghasemi AR, Ahmadi SH. The Evaluation of Higher Education Institutes Performance by BSC and GAHP. 2013.
- Ghasemi A, Alizadeh M. Evaluating organizational antifragility via fuzzy logic. The case of an Iranian company producing banknotes and security paper. *Operations Research and Decisions*. 2017;27(2):21-43.
- Owlia MS, Aspinwall EM. A framework for measuring quality in engineering education. *Total Quality Management*. 1998;9(6):501-18.
- Waugh RF. Academic staff perceptions of administrative quality at universities. *Journal of Educational Administration*. 2002.
- Lalovic M. An ABET assessment model using Six Sigma methodology: University of Cincinnati; 2002.
- Lagrosen S, Seyyed-Hashemi R, Leitner M. Examination of the dimensions of quality in higher education. *Quality assurance in education*. 2004.
- Yang Z, Yan-ping L, Jie T, editors. Study on quality indicators in higher education: An application of the SERVQUAL Instrument. 2006 International Conference on Service Systems and Service Management; 2006: IEEE.
- Tsinidou M, Gerogiannis V, Fitsilis P. Evaluation of the factors that determine quality in higher education: an empirical study. *Quality assurance in Education*. 2010.
- Noaman AY, Ragab AHM, Madbouly AI, Khedra AM, Fayoumi AG. Higher education quality assessment model: towards achieving educational quality standard. *Studies in Higher Education*. 2017;42(1):23-46.
- Al-Jobuisihalil KI, Al-JobuisHasn HS. Evaluating the Experience of Open College of Education in Mosul City. *College of Basic Education Researches Journal*. 2007;6(3):87-112.
- Muhammed MA. Evaluation of the performance and Quality of Learning Resources at the College

- of Tourism Sciences of Al- Mustansiriyah University –an Empirical Study. *Gulf Economist*. 2017;33(32):119-46.
22. Jasim SR. Measurement of Quality Costs to Administration and Economics College at University of Anbar and the Impact of Displacement on These Costs/Analytical Study For 2013-2017. *Tikrit Journal of Administration and Economics Sciences*. 2019;15(47 Part 1):1-20.
23. Dawood FS. leading quality of university education in accordance with the strategic planning. *AL-Anbar University journal of Economic and Administration Sciences*. 2016;8(15):253-83.
24. Taher Hameed Abbas B. Evaluation of the Educational Service Quality from the Perspective of Students' Using the (HEdPERF) Model Field Study in the Al-Dewaniyah Technical Institute. *Al Kut Journal of Economics Administrative Sciences* 2019;1(31):134-61.
25. Parasuraman A, Zeithaml VA, Berry LL. A conceptual model of service quality and its implications for future research. *Journal of marketing*. 1985;49(4):41-50.
26. Abdullah F. Measuring service quality in higher education: HEdPERF versus SERVPERF. *Marketing Intelligence & Planning*. 2006.
27. Abdullah F. The development of HEdPERF: a new measuring instrument of service quality for the higher education sector. *International journal of consumer studies*. 2006;30(6):569-81.
28. Sanders DR, Irwin SH. The impact of index funds in commodity futures markets: A systems approach. *The Journal of Alternative Investments*. 2011;14(1):40-9.

# Effectiveness of Breathing as a Non-Pharmacological Method to Reduce Pain Severity among Woman During Labor

Nawras Monim Alzurfi<sup>1</sup>, Shukriyia Shadhan Al-Ogaili<sup>2</sup>

<sup>1</sup>Research Scholar, Maternity Department/Faculty of Nursing/University of Kufa, Iraq,

<sup>2</sup>Professor, Health and Medical College Techniques, Al-Furat Al-Awsat Technical University, Iraq

## Abstract

The aim of the study is identify the effect of non-pharmacological method technique (breathing) on severity of pain through comparing woman's pain score during labor. A quasi-experimental Design is used through the present study in order to achieve the study objectives. The period of the study is from 15th January to 4th June 2020. A Non-Probability (Purposive Sample) of (60) women (30) of them are control group and (30) women are the study group, selected from those who are admitted to Al-Zahraa Maternity Teaching Hospital/ Al-Forat Teaching Hospital, are included in the study sample. Labor pain was assessed using the scale known as: Face, Leg, Activity, Cry, And Consolability (FLACC). Breathing Technique was used as a non-pharmacological method to reduce pain . The current study revealed that applying the non-pharmacological pain managing interventions (breathing) showed a remarkably significant reduction in pain according to in FLACC behavioral scale regarding the other stages (active phase (after intervention); transition phase; second Phase; third Phase) which. . It is concluded that breathing has reduced pain during active phase, transition phase, and second phase .

**Keywords:** *Breathing, Non –Pharmacological, Pain Severity, Woman Labor.*

## Introduction

Women often mention, that because of their anxiety they would prefer a caesarean section rather than a natural delivery<sup>(1)</sup>. Occasionally, women feel little if any pain in labor and give birth unexpectedly<sup>(2)</sup>. Labor pain has its two elements: visceral and somatic. The visceral one occurs during the first stage of labor and it is connected with the tension exerted on the cervix, which causes its dilatation. That is felt by a parturient as a pain. The somatic kind of pain appears at the end of the first stage and it lasts also in the second stage. It is a result of the force exerted on the vaginal part of the cervix, the vagina and the perineum<sup>(3)</sup>. Labor pain management is not only a crucial concern for future mothers but also a great challenge in modern medicine. A wide range of both pharmacological and non-pharmacological labor pain relief techniques are currently available for pregnant women in Poland. The

first group includes: epidural analgesia, gas for pain control and intravenous opioids. Non pharmacological techniques contain water birth and water immersion, transcutaneous electrical nerve stimulation (TENS), aromatherapy, acupuncture and acupressure, massage techniques<sup>(4)</sup>. In general, labor pain management means use complementary and alternative medicine (CAM) that includes herbs, vitamins and minerals, massage, aromatherapy, acupuncture, homeopathic remedies as well as psychological, physical and spiritual techniques. Its prevalence is increasing in developed countries likewise in the united states of America (USA) used by more than one third of pregnant women, while in the united kingdom (UK) used by (57.1%) of women during pregnancy . In Arab countries, it is used by (40.0%) in Palestine, (75%) in Jordan, and (22.3%) in Iran. However, women in Iraq are little is known about the use of pain management during labor<sup>(5)</sup>. TO identify the effect of non-pharmacological method technique (breathing, back massage) on severity of pain through comparing woman's pain score after the application of these method. The aim of the study is identify the effect of non-pharmacological method technique (breathing) on severity of pain through comparing woman's pain score after the application of these method .

---

### Corresponding Author:

**Nawras Monim Alzurfi**

Research Scholar, Maternity Department/Faculty of Nursing/University of Kufa, Iraq

e-mail: nawrasm.alzurfi@student.uokufa.edu.iq



**Method**

A quasi-experimental Design is used through the present study in order to achieve the study objectives. The period of the study is from 15th January to 4th June 2020.

A Non-Probability (Purposive Sample) of (60) women (30) of them are control group and (30) women are the study group, selected from those who are admitted to Al-Zahraa Maternity Teaching Hospital/Al-Forat Teaching Hospital, are included in the study sample.

**Part 1: Demographic Data:** A demographic data sheet, which consists of (6) items, include: Age, level of education, monthly income, occupational status of wife, occupational status of the husband, and resistance environment.

**Part 2: Reproductive Health Data:** The second part of the questionnaire is comprised which including expected date of delivery, history of current labor, gestational age, uterine contraction, duration and frequencies), membrane status for each stage.

**Part 3: Pain Assessment (FLACC behavioral Scale):** This scale has been constructed to assess the labor

pain in a behavioral pain scale (Face, Leg, Activity, Cry, And Consolability (FLACC). It includes five categories ranged from 0 to 2 scale, which results in a total score of 0-10, (0 = relax and comfortable, 1-3= mild pain, 4-6 moderate pain, 7-10= sever pain).

**Part 4:** Breathing Technique was used as a non-pharmacological method to reduce pain.

**Statistical Analysis:** Descriptive statistics presented as mean, standard deviation, frequencies and percentages. Chi-square test was used to compare frequencies. Pearson’s correlation test was used to assess the correlations. Level of significance of  $\leq 0.05$  was considered as significant difference or correlation.

**Results**

Table (1) shows the highest percentage of the women subgroup are : women ages between (16-20) years old (50% for study group and 40% for control group), those who live urban residents (86.7% for study group and 73.3% for control group), those who are secondary school graduated (30% for study groups) and primary school graduates (26.7% for control group), house wives (90% for study group and 83.3% for control group) .

**Table (1) Statistical distribution of study sample (women) by their demographic data**

Items	Sub-groups	Study Group Total = 30		Control Group Total = 30		Chi Sq. P value
		Freq.	Percent.	Freq.	Percent.	
Age/Years	16-20	15	50.0	12	40.0	0.93 (0.62)
	21-25	9	30.0	9	30.0	
	26-30	6	20.0	9	30.0	
Family Income	Sufficient	5	16.7	8	26.7	4.93 (0.08)
	Barely Sufficient	15	50.0	19	63.3	
	Insufficient	10	33.3	3	10.0	
Residential Environment	Urban	26	86.7	22	73.3	1.67 (0.19)
	Rural	4	13.3	8	26.7	
Educational Status	illiterate	2	6.7	5	16.7	14.84 (0.02)
	Read and write	6	20.0	4	13.3	
	Primary	2	6.7	8	26.7	
	Intermediate	8	26.7	2	6.7	
	Secondary	9	30.0	5	16.7	
	Institute and above	3	10.0	6	20.0	

Table (2) reveals differences in the assessment in FLACC behavioral scale at different labor stages between study and control groups, it shows that there is no significant difference ( $p > 0.05$ ) between study and control groups in the assessment in FLACC behavioral scale at the first active phase before applying the non-

pharmacological pain managing interventions; regarding the other stages (active phase (after intervention); transition phase; second Phase; third Phase) which show a remarkably significant reduction pain according to in FLACC behavioral scale .

**Table (2) Differences in the assessment in FLACC behavioral scale at different labor stages between study and control groups**

Items	Sub-groups	Study Group Total = 30		Control Group Total = 30		Chi Square
		Freq.	%	Freq.	%	
Active phase (Before intervention)	Relaxed and Comfort	0	0.0	0	0.0	1.96 (0.16) NS
	Mild	0	0.0	0	0.0	
	Moderate	4	13.3	1	3.3	
	Severe	26	86.7	29	96.7	
Active phase (After intervention)	Relaxed and Comfort	0	0.0	0	0.0	33.61 (0.000) HS
	Mild	0	0.0	0	0.0	
	Moderate	23	76.7	1	3.3	
	Severe	7	23.3	29	96.7	
Transition phase	Relaxed and Comfort	0	0.0	0	0.0	38.57 (0.000) HS
	Mild	0	0.0	0	0.0	
	Moderate	26	86.7	2	6.7	
	Severe	4	13.3	28	93.3	
Second Phase	Relaxed and Comfort	0	0.0	0	0.0	29.7 (0.000) HS
	Mild	0	0.0	0	0.0	
	Moderate	24	80.0	3	10.0	
	Severe	6	20.0	27	90.0	

## Discussion

The present study reveals that the highest percentage of the women subgroup are : women with ages between (16-20) years old (50% for study group and 40% for control group) (table 1). This result is supported by Shrestha who indicated that labor pain was found to be more severe in younger age (adolescence parturient) as compared to those above 20<sup>(6)</sup>. In addition, these results study reported by Vyas, et.al who evaluated intra partum non-pharmacological pain relief techniques during labor, and found that out of the (60) sample of primigravida woman, the highest age groups were aged between (18-22) years old and that was (41.7%) and the lowest were found in the age group of (30-34) and they are accounted (11.7%)<sup>(7)</sup>.

Concerning the level of education, the study reveals that the highest percentage of the study sample are secondary school graduated (30% for study groups) and primary school graduates (26.7% for control group), (table 1).

These result was in agreement with study conducted by Daniel, et al. who stated that the pain of a woman experiences during labor and birth is subjective, indivisualized and caused by a number of interrelating factors such as physical, affective, psychological and environmental components all shape the pain experience. One of these factors is the educational level of women

which majority of them (26.7%) are primary school graduates<sup>(8)</sup>.

The study results reveal that the highest percentage of the study sample are live urban residents (86.7% for study group and 73.3% for control group). This is agreement with across-sectional survey on Iraqi woman that use of complementary and alternative medicine in pregnancy reported by Hwang et al. found that (53.7%) of Iraqi woman Women Were living in urban areas<sup>(9)</sup>.

The study result reveals that the highest percentage of the study sample are barely sufficient family income (50% for study group and 63.3% for control group) They are accounted through applying of the Ministry of planning and Development Cooperative/Central Statistical Organization Technique and Information Scale. These results are in constant with studies reported by Johnston-Robledo <sup>(10)</sup>who stated that Insufficient of women were less likely than Sufficient Women to attend childbirth centers and classes and they are more likely to acquire information about childbirth from their mothers rather than acquired information from medical personnel during prenatal care visits. So that, these women experience higher levels of pain during childbirth. In addition, Al Ahmmar and Tarraf indicated, that the women with Sufficient of socioeconomic was more convinced with the labor process than those with Insufficient<sup>(11)</sup>.

Table (2) show that reveals statistical distribution and difference in overall assessment of FLACC behavioral scale between study and control groups, it shows that there is no significant difference between study and control groups according to the evaluation of pain signs in term of FLACC behavioral scale; expect for face signs which indicated increased pain in the control group.

These finding are supported with a randomized controlled trial study in Turkey reported by Yuksel et al.<sup>(12)</sup> which measured the effects of breathing exercises on maternal pain during the second stage of labor which revealed that the mean visual analog scale score of intervention the study group and control group were (88.+ 6.3) and (90.5)+ 7.0), respectively ( $p > 0.001$ ). based on this study, breathing exercises for women are effective in reducing the perception of labor pain; therefore breathing exercises consider an effective method pain management and lessening the duration of labor. The finding of the current study are supported with studied which used non-pharmacological pain relief method. A study reported in India by Jhala and its results show that practice of breathing exercise conditioned the mother to breathe and relax during contractions to control the experience of pain in gravid mothers, and shortens the duration of labor and prevents the complications during labor<sup>(13)</sup>.

### Conclusions

It is concluded that breathing has reduced pain during active phase, transition phase, and second phase.

**Ethical Clearance:** Taken from University of Kufa ethical committee.

**Source of Funding:** Self

**Conflict of Interest:** Nil

### References

1. Sercekus, p; Okumus, H. Fears associated with childbirth among nulliparous women in Turkey. *Midwifery*. 2009 : 155-162.
2. Gaskin, I.M. Ina May's Guide to childbirth: Update with New Material; Vermilion: London, UK, 2008.
3. Labor, S.; Maguire, S. The Pain of Labour. *Rev Pain*. 2008 : 15-19.
4. Sulima, M. Alternatywnemetodylagodzeniaboluporodowego. *Eur. J. Med. Technol*. 2013;1:32-38.
5. Hall, H. G., Griffiths, D. L., & McKenna, L. G. The use of complementary and alternative medicine by pregnant women: a literature review. *Midwifery*. 2011; 27(6): 817-824.
6. Shrestha, I., Pradhan, N., & Sharma, J. Factors influencing perception of labor pain among parturient woman at Tribhuvan University teaching hospital . *Nepal Journal of Obstetrics and Gynaecology*. 2013; 8(1): 26-30.
7. Vakilinan, K., Davoud Abadi, M., & Seyed Zadeh Aghdam, N. The Effects of Breathing Techniques on the Length of Labor Active Phase and its Second Stage in Women's First Labor. *Complementary Medicine Journal of Faculty of Nursing & Midwifery*. 2014; 3(4) : 666-673.
8. Daniel, G., Oyetunde, M., & Eleri, G. (). Mother's validation of midwives care in the management of labor pain in Plateau State, Nigeria. *International Journal of Nursing and Midwifery*, 2015; 7(1) : 123-133.
9. Hwang, J. H., Kim, Y. R., Ahmed, M., Choi, S., AL-Hammadi, N. Q., Widad, N. M., & Han, D. Use of complementary and alternative medicine in pregnancy: a cross-sectional on Iraqi women. *BMC Complementary and Alternative Medicine*. 2016; 16(1) : 191.
10. Johnston-Robledo, I. Beyond Lamaze: Socioeconomic status and women's experiences with childbirth preparation. *Journal of Gender, Culture and Health*. 1998; 3(3): 159-169.
11. Kamalifard, M., Shahnazi, M., Melli, M.S., Allahverdizadeh, S., Toraby, S., & Ghahvechi, A. The efficacy of massage therapy and breathing techniques on pain intensity and physiological responses to labor pain. *Journal of Caring Sciences*. 2012; 1(2) : 73.
12. Yuksel, H., Cayir, Y., Kosan, Z., & Tastan, K. Effectiveness of breathing exercises during the second stage of labor on pain and duration: a randomized controlled trail. *Journal of integrative medicine*. 2017; 15 (6) : 456-461.
13. Jhala A. A study to assess the effectiveness of Lamaze breathing on labor pain and anxiety towards labor outcome among primigravida mothers during labor in community health center, Kolar Road, Bhopal (M.P.); *Indian Journal of Obstetrics and Gynecology*. 2017; 5(1) : 19-22.

# Vitik Detection of Aerobic Spore-Forming Bacteria Isolated from Raw Milk, Skim Milk Powder and UHT Milk

Nawres N. Jaber<sup>1</sup>, Nada Salih Hadi<sup>1</sup>, Abeer Laily Mohammed<sup>1</sup>, Marwa Idan<sup>1</sup>, Adyan Niama<sup>1</sup>

<sup>1</sup>Scholar Researchers, Department of Microbiology, College of Veterinary Medicine University of Basrah, Basra, Iraq

## Abstract

**Background** Aerobic spore-forming bacteria can be found in a wide range of environmental niches such as food production. Among them, the aerobic spore-forming bacteria like *Bacillus ceruse*, pose a risk of causing dairy product poisoning by the production of toxins.

**Materials and Method:** Out of 40 samples, 10 from each of Raw Milk, Skim Milk Powder, UHT Milk and Wight chees were collected to isolate aerobic spore-forming bacteria by morphological, physiological and biochemical tests.

**Conclusion:** A total of 25 isolates of heat resistant bacteria, 10(40%), 8(32%), 3(12%), 4(16%) from “RM, white chees, SMP and UHT milk respectively,” were purified and characterized. Various spore forming bacteria belonging to Bacilli spp. which include pathogenic were biochemically identified using vitek 2 systems, the result showed the highest rate of *Bacillus subtilis* (28%) followed by *Bacillus ceruse* and *Bacillus thuringiensis* (24%).

**Keywords:** Vitik Detection, Aerobic Spore-Forming Bacteria, Raw milk, Skim milk Powder, UHT milk.

## Introduction

Spore-forming bacteria is gram-positive microorganisms aerobic or anaerobic, ubiquitous in nature. Bacterial spores are common contaminants of food products, and their outgrowth may cause food spoilage or food borne diseases. Bacilli and Clostridia remain the most important classes relevant to the dairy industry<sup>(1)</sup>. The *Bacillus* genus, part of the Bacillaceae family, have been recognized as major contributors to dairy product quality issues over the past 2 decades. They have a remarkable range of physiological characteristics that renders appropriate categorization and generalizations

impossible<sup>(2,3)</sup>. They are a primary cause of concern for the international dairy industry because of the pervasive and resistant nature of their spores in comparison to vegetative cells, surviving environmental challenges, such as heat, desiccation, freezing, thawing, presence of organic solvents and oxidizing agents, and UV irradiation, as well as predation by protozoa<sup>(4)</sup>.

Spore-forming bacteria pose the greatest spoilage threat to dairy products, causing severe economic losses, equipment impairment and/or reputational damage of food companies. Bacilli and related genera are responsible for spoilage problems in milk and dairy products such as bitty cream, sweet curdling, off flavor, flat sour, non-sterility, bitterness, ropiness, interference with cheese production, and cheese blowing<sup>(5,6,7,8,9)</sup>.

---

## Corresponding Author:

Nawres N. Jaber

Scholar Researchers, Department of Microbiology,  
College of Veterinary Medicine University of Basrah,  
Basra, Iraq

e-mail: naw\_m@yahoo.com

## Material and Method

**Sample Collections:** A total of forty samples, including: 10 samples from each of Raw Milk, Skim Milk Powder, UHT Milk and Wight cheese samples were collected during the period from September to December

2019 from Basrah city markets according to standard Method for the Examination of Dairy Products<sup>(10)</sup>.

**Enumeration of total viable and aerobic spore-forming bacteria:** Total viable counts of all samples and aerobic spore-forming bacteria were enumerated using the nutrient agar mediums. The bacterial and spore bacterial count was expressed as cfu/ml or g milk and cheese<sup>(10)</sup>. However, the samples of RM and SMP and cheese after preparation were heated in water bath at 80°C for 10 minimums then they cooled suddenly to the room temperature before transferring one ml aliquots in petri dishes<sup>(11)</sup>.

**Isolation of aerobic spore-forming bacteria:** Some of the colonies, which suspected to be *Bacillus* spp. according to the colony morphology on Nutrient Agar and blood agar were identified by using Gram's staining, motility, spore staining, catalase test hemolytic activity on blood agar<sup>(12)</sup>, Casein hydrolysis test<sup>(11)</sup> and Lactose fermentation test<sup>(12)</sup>.

**Biochemical identification of Bacteria using Vitek-2 System:** VITEK-2 system imparts an automated, computer-based technique of species identifications, relies on advanced colorimetry technology, the measurement of light attenuation associated with each biochemical reaction in VITEK cards.

**Antibiotic susceptibility test:** The antimicrobial susceptibility testing was determined by the disk agar diffusion method<sup>(13)</sup>. It tested for susceptibility to 7 antimicrobial disks. Erythromycin E (15mg), Cadazolid (10mg), chloramphenicol C (30mg), Cephalexin CN (10mg), Ciprofloxacin CIP (30mg) and Tetracycline TE (30 mg).

## Results and Discussion

Enumeration of total viable and aerobic spore forming bacteria in raw milk, cheese, skim milk powder and UHT-milk

The results in Table (1) shown that all RM and white cheese samples contain highly bacterial levels or counts according to the ESS (No, 0154-01/2005) the average of the total number of micro-organisms should not exceed 100.000 per ml (log 5 cfu/ml) of raw cow's milk from primary production. Hence, the raw milk samples and locally synthesize white cheese may be considered of bad quality. While the skim milk powder and UHT milk contain fewer amounts of microbial count, the current results also were compatible with the study of (14) who reported the presence of bacteria isolated from raw milk, skim milk powder and UHT milk in Egypt and found that the mean counts of total viable count ranged between logs 5.06 and 8.03 cfu/ml in raw milk samples, RM samples were containing highly bacterial levels, also as shown in Table (2) aerobic spore-forming bacteria count ranged between  $1.1 \times 10^3$  cfu/ml in in skim milk powder to  $6.7 \times 10^3$  and  $3.7 \times 10^3$  cfu/ml in white cheese and raw milk samples respectively. *Bacillus* contamination has been demonstrated to be a problem in the dairy manufacturing process, affecting the quality and safety of the final product. Second, the issue of secondary contamination of heat-treated milk products by spoiling bacteria is now widely known<sup>(15, 16, 17)</sup>. Also the present study is in line with study of (14) who recorded the aerobic spore-forming bacteria count ranged between <10 and log 3.53 cfu/ml in raw milk samples

**Table 1. Total bacterial counts for raw milk (RM), White cheese (Wch), skim milk powder (SMP) and UHT milk**

Sample	TBC	Sample	TBC	Sample	TBC	Sample	TBC
RM1	$10.1 \times 10^5$	Wch1	$7.12 \times 10^5$	SMP1	$2.3 \times 10^5$	UHT1	$1.1 \times 10^4$
RM2	$9.8 \times 10^5$	Wch2	$8.1 \times 10^5$	SMP2	$1.1 \times 10^5$	UHT2	$2 \times 10^4$
RM3	$2.44 \times 10^6$	Wch3	$2.02 \times 10^6$	SMP3	$2.5 \times 10^5$	UHT3	$1.3 \times 10^4$
RM4	$7.33 \times 10^6$	Wch4	$7.3 \times 10^5$	SMP4	$2.2 \times 10^5$	UHT4	$1 \times 10^4$
RM5	$8.5 \times 10^5$	Wch5	$10.1 \times 10^5$	SMP5	$3 \times 10^4$	UHT5	$1.1 \times 10^4$
RM6	$1.11 \times 10^6$	Wch6	$5 \times 10^6$	SMP6	$1.1 \times 10^5$	UHT6	$2 \times 10^4$
RM7	$2.97 \times 10^6$	Wch7	$3.33 \times 10^6$	SMP7	$2.7 \times 10^5$	UHT7	$2.01 \times 10^4$

Sample	TBC	Sample	TBC	Sample	TBC	Sample	TBC
RM8	1.4*10 <sup>6</sup>	Wch8	8.1*10 <sup>5</sup>	SMP8	1.6*10 <sup>5</sup>	UHT8	1.6* 10 <sup>4</sup>
RM9	3.43*10 <sup>5</sup>	Wch9	9.2*10 <sup>5</sup>	SMP9	4* 10 <sup>4</sup>	UHT9	2.5* 10 <sup>4</sup>
RM10	3.11*10 <sup>5</sup>	Wch10	6.3*10 <sup>5</sup>	SMP10	6.1* 10 <sup>4</sup>	UHT10	1.1* 10 <sup>4</sup>

TBC: Total Bacterial Count

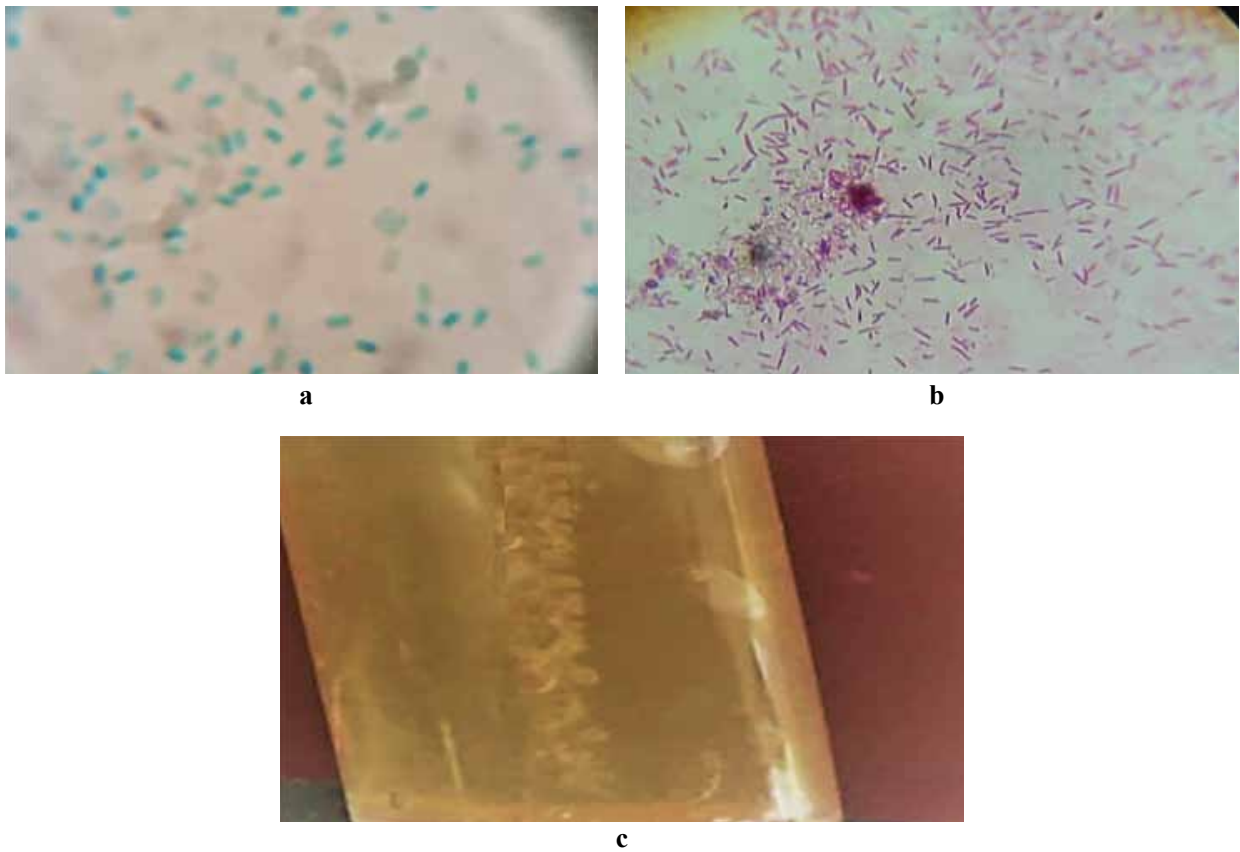
**Table 2. Total aerobic spore forming cell for raw milk (RM), White chees (Wch), skim milk powder (SMP) and UHT milk.**

Sample	ASFC	Sample	ASFC	Sample	ASFC	Sample	ASFC
RM1	2.1*10 <sup>3</sup>	Wch1	2.6*10 <sup>3</sup>	SMP1	1.2*10 <sup>3</sup>	UHT1	-
RM2	2.2* 10 <sup>4</sup>	Wch2	3.7*10 <sup>3</sup>	SMP2	1.1*10 <sup>3</sup>	UHT2	5*10 <sup>3</sup>
RM3	1.7* 10 <sup>4</sup>	Wch3	3*10 <sup>3</sup>	SMP3	-	UHT3	2.1*10 <sup>3</sup>
RM4	3.1* 10 <sup>4</sup>	Wch4	5*10 <sup>3</sup>	SMP4	2*10 <sup>3</sup>	UHT4	-
RM5	2.7* 10 <sup>4</sup>	Wch5	1* 10 <sup>4</sup>	SMP5	1.5*10 <sup>3</sup>	UHT5	3.1*10 <sup>3</sup>
RM6	3* 10 <sup>4</sup>	Wch6	4.3* 10 <sup>4</sup>	SMP6	2*10 <sup>3</sup>	UHT6	3.6*10 <sup>3</sup>
RM7	3.7*10 <sup>3</sup>	Wch7	3.6*10 <sup>3</sup>	SMP7	-	UHT7	-
RM8	2.8*10 <sup>3</sup>	Wch8	6.7*10 <sup>3</sup>	SMP8	2.1*10 <sup>3</sup>	UHT8	-
RM9	2,8*10 <sup>3</sup>	Wch9	1.2*10 <sup>3</sup>	SMP9	-	UHT9	-
RM10	3.1*10 <sup>3</sup>	Wch10	2*10 <sup>3</sup>	SMP10	-	UHT10	-

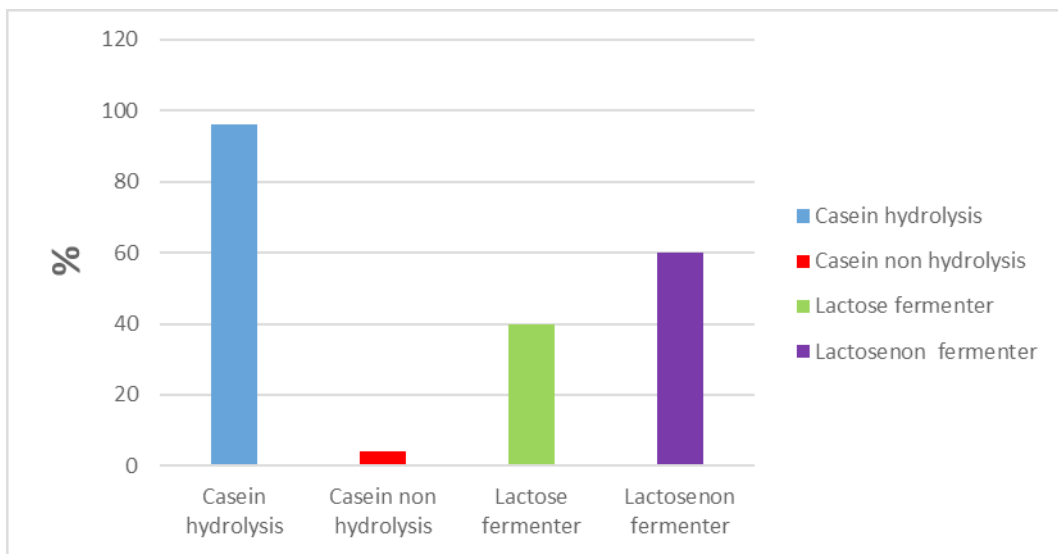
ASB: Aerobic Spore Forming Cell

**Characterization and Enzymatic properties of aerobic spore-forming isolates:** A total of 25 isolates 10, 8, 3, 4 from “RM, white chees, SMP and UHT milk respectively”, were purified and characterized by gram positive, spore forming and motile bacteria, Fig 1 (a, b, c). Biochemical tests were used for detection the enzymatic properties of the of aerobic spore-forming isolates isolated bacteria; the isolates were shown different enzymatic properties. According to the results illustrated in fig (2), it was revealed that the proportion of 96% for total *Bacillus* Spp. isolates were able to hydrolyze the casein, the results were determined as clearing of the agar around the bacterial growth while there are 4% of the isolates was not able to hydrolyze the casein. Furthermore, 60 % of the isolates were ferment lactose, and 40% were determined as lactose non fermenter. The study of enzymatic properties of aerobic spore-forming isolates showed that the isolates have the applet to hydrolyze the casein and fermented

lactose, these can cause spoilage in sterilized milk due to their production of proteolytic and lipolytic enzymes or recontamination during the filling of sterilized milk<sup>(18)</sup>. A finding in accordance with the study of (19) who reported that contamination with spore formers can lead to spoilage of milk and dairy products, mainly caused by enzyme deterioration (proteolytic and lipolytic activity by *Bacillus* species), acid production, (i.e. lactic, butyric and acetic acid. Moreover, (20), mentioned that the presence of *B. cereus* in UHT milk and 91.67% of mesophilic *Bacillus ssp.* isolates were able to hydrolyze the casein and 36.36% of isolates able to hydrolyze the casein were able to ferment the lactose. The UHT processing of milk destroys all microorganisms that can grow under normal storage conditions<sup>(21,22)</sup>. Almost all enzymes are also inactivated by UHT processing because the most enzymes in milk are inactivated at temperatures below 100 °C, but some bacterial proteinases and lipases needs temperatures above 150°C for inactivation<sup>(23)</sup>.



**Fig. 1: a: Gram staining, b: spore staining, c: motility test**



**Fig (2): The Percentages of Casein hydrolyses and lactose fermenter isolates**

The results showed that all the isolates were positive for Catalase test and have variable activity for blood hemolysis activity 44% blood hemolysis, 48% non-blood hemolysis and 8 % variable in hemolysis activity.

**Biochemical identification of Bacteria using Vitek-2 System:** Aerobic spore forming isolates were

biochemically identified using vitek-2 system version: 07.01 according to the following test, AMY, APPA, LeuA, AlaA, Drib, NOVO, Draf, OPTO, PIPLC, CDEX, ProA, TyrA, ILATk, NC6.5, O129R, Dxyl, AspA, BGURr, Dsor, LAC, d MAN, SAL, ADH, BGAR, AGAL, URE, NAG, dMNAE, SAC, BGAL,

AMAN, PyrA, POLYB, dMAL, MBdG, dTRE, AGLU, AMAN, PyrA, POLYB, dMAL, MBdG, dTRE, AGLU, PHOS, BGUR, dGAL, BACI, PUL, ADH2s. The result for 25 isolates were presented in figure (3), there are 28% isolates were identified *Bacillus subtilis*, 24% isolates were identified as *Bacillus ceruse* and *Bacillus thuringiensis*, 8% isolates were identified as *Bacillus licheniformis* while 16% isolates were unidentified.

The preliminary identification of aerobic spore forming isolates was performed and the results indicated that morphological characteristics of isolates were bacilli. The Gram staining techniques showed that all isolates were gram positive and from the Catalase test all isolates

were found to be positive. The selected organisms were identified using VITEK 2 system imparts an automated, computer based technique of species identifications, relies on advanced colorimetry technology, the measurement of light attenuation associated with each biochemical reaction in VITEK cards. The reagent cards have 63 wells and each well contain an individual test substrate. Substrates assess various metabolic activities such as alkalinisation, acidification, enzyme hydrolysis, and growth in the presence of inhibitory compounds. The VITEK-2 compact system combines several advantages like rapid identification, a simple methodology, high level of automation and taxonomically updated databases.

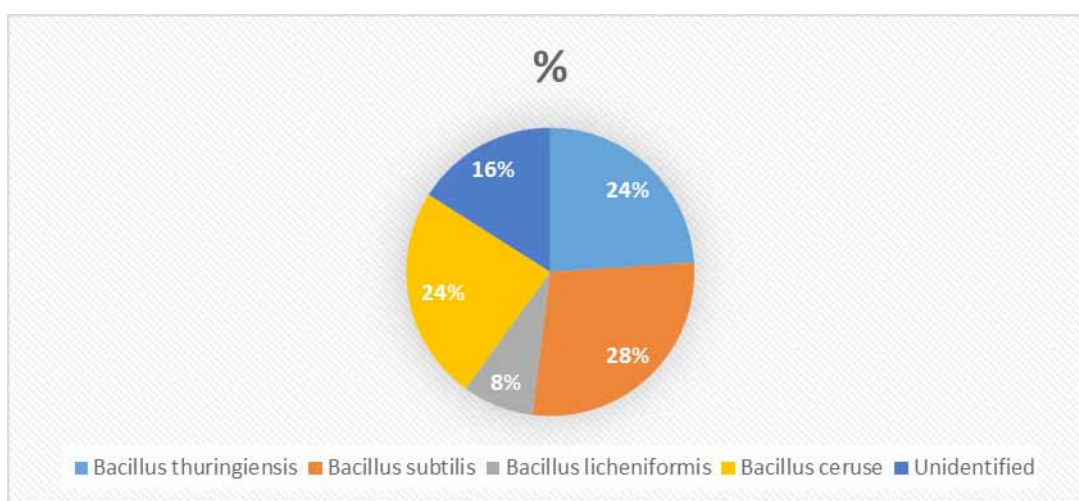


Figure (3) Results of microbial identification using VITEK 2 system

**Antibiotic susceptibility test:** Among the variety of antibiotics tested, the aerobic spore-forming isolated bacteria show resistance to Cadazolid (CDZ) and Chloramphenicol (C) and Show medium sensitivity for

Tetracycline (TE), Erythromycin (E) and Vancomycin (VA), its show highest sensitivity to Ciprofloxacin (CIP) and Cephalexin (CN) (Table 3).

Table (3) Antibiotic susceptibility test of the isolated bacteria

Identified species	Mean of Diameter of inhibition						
	CDZ	C	VA	CN	TE	E	CIP
Bacillus thuringiensis	0	0	±13.2	±25.66	±15	±18.9	±27.66
Bacillus subtilis	0	0	±16.1	±27	±15	±20.2	± 25
Bacillus licheniformis	0	0	±19	±28.33	±20	±22.3	±31.66
Bacillus ceruse	0	0	±13	±26.32	±10.9	±13	±25.3

In conclusion, raw milk, skimmed milk powder and some of UHT milk samples were contaminated with aerobic spore forming bacteria. *Bacillus subtilis* was

the highest isolates from Bacillus species. There were differences among isolates in ability to hydrolyze the casein and ferment lactose.



**Conflict of Interest:** None

**Funding:** Self

**Ethical Clearance:** Not required

### References

1. Gopal N, Hill C, Ross PR, Beresford TP, Fenelon MA, Cotter PD., The prevalence and control of Bacillus and related spore-forming bacteria in the dairy industry. *Front Microbiol* 2015.6:1418.
2. Slepecky R. A., Hemphill H. E. The genus Bacillus—nonmedical. *Prokaryotes*. 2006. 4 530–562. 10.1007/0-387-30744-3\_16
3. Ranieri M.L. and Boor K.J. Short communication: Bacterial ecology of high-temperature, short-time pasteurized milk processed in the United States. *J. Dairy Sci.* 2009; 92: 4833-4840
4. Setlow, P., Germination of spores of Bacillus species: what we know and do not know. *J. Bacteriol.* 2014. 196, 1297–1305. doi: 10.1128/JB.01455-13.
5. Ternstrom A, Lindberg AM, Molin G., Classification of the spoilage flora of raw and pasteurized bovine milk, with special reference to Pseudomonas and Bacillus. *J Appl Bacteriol.* 1993. 75:25-34.
6. Heyndrickx M, Scheldeman P., Bacilli associated with spoilage in dairy products and other food. In: Berkeley R, Heyndrickx MN, de Vos P. editors. *Applications and systematics of Bacillus and relatives*. 1st ed. Oxford: Blackwell Science, 2002. pp 64–82.
7. Quiberoni A, Guglielmotti D, Reinheimer J., New and classical spoilage bacteria causing widespread blowing in Argentinean soft and semihard cheeses. *Int J Dairy Technol* 2008.61:358–63.
8. Burgess SA, Lindsay D, Flint SH., Thermophilic bacilli and their importance in dairy processing. *Int J Food Microbiol* 2010.144:215–25.
9. Garde S, Ávila M, Gómez N, Nuñez M., Clostridium in late blowing defect of cheese: detection, prevalence, effects and control strategies. In: Castelli H, du Vale L. editors. *Cheese: production, chemistry and sensory properties*. New York: Nova Science Publishers, 2013. pp 503–18.
10. Standard Method for Examination of Dairy Products. American Public Health Association. 17<sup>th</sup> edit. 2014.
11. Difco S, manual of dehydrated culture media and reagents for microbiology., 10th ed. Pub. Difco,s laboratories, Detroit MchiGan. U.S.A. 1984.
12. Macfaddin, J. F., Biochemical tests for identification of medical bacteria. 3<sup>rd</sup> Ed. Lippincott Williams and Wilkins USA. 2000.
13. Bauer, A. W; Kirby, W. M. and Sherris, J. C., Antibiotic susceptibility testing by a standard single disk method. *American Journal of Clinical Pathology*. 1966.45: 493-496.
14. Sameh S. Yacoub, Sherif M. Shamsia, Sameh A. Awad, Hamid M. Ziena and Nabil M. Safwat Characterization of Aerobic Spore-Forming Bacteria Isolated from Raw Milk, Skim Milk Powder and UHT Mil 1 Food, Dairy Science & Technology Dept., Faculty of Agric., Damanhour Univ., Egypt. 2-Dairy Science & Technology Dept., Faculty of Agric. El-Shatby, Alexandria Univ., Egypt. 2017.
15. Kim, E.R., Jung, B.M., Yu, B.H., Jung, H.K., Kang, K.H. and Chun, H.N., Comparative characterization of the bacteria isolated from market milk treated with ESL and conventional system. *Korean J. Food Sci. Anim Resources* 2003.23, 327–332.
16. Aaku, E.N., Collison, E.K., Gashe, B.A. and Mpuchane, S., Microbiological quality of milk from two processing plants in Gaborone Botswana. *Food Control* 2004.15, 181–186.
17. Pacheco-Sanchez, C.P. and de Massaguer, P.R., Bacillus cereus in Brazilian ultra-high temperature milk. *Sci Agric (Piracicaba, Braz)* 2007. 64, 152–161.
18. Chen L., T., Coolbear and R.M. Daniel, Characteristics of proteinases and lipases produced by seven Bacillus Spp. Isolated from milk powder production lines. *International Dairy Journal*, 2004. 14: 495-504.
19. Garde, S., Gómez-Torres, N. and Ávila, M. Spore forming bacteria in dairy product. Wiley Blackwell Editors: Palmiro Poltronieri. 2017. pp.11-36
20. Bahout A.A., Prevalence of Bacillus species in UHT milk. *Assoc. Vet. Med. J.*, 2000. 42: 47-53.
21. Lewis M. J. and H. C. Deeth . Heat treatment of milk. In A. Y. Tamime (Ed.), *Milk processing and quality management* (pp. 168e204). West Sussex: Blackwell Publishing Ltd. 2009.
22. Deeth H.C. Improving UHT techniques. In Mansel W. Griffiths (Ed.), *Improving the safety and quality of milk* (pp. 302-329) Cambridge, U.K.: Woodhead. 2010.

# Counseling with Tooth Brushing Demonstration Method as an Effort to Improve Tooth Brushing Skills and the Status of Dental and Oral Hygiene in Early Childhood at School

Ngatemi<sup>1</sup>, Tedi Purnama<sup>1</sup>

<sup>1</sup>Assistant Professor, Department of Dental Health, Health Polytechnic of Jakarta I, Indonesia

## Abstract

Dental health problems suffered by many people in Indonesia is dental caries. Poor dental and oral hygiene is one of the factors causing dental caries or oral and dental health problems. Teaching oral health with demonstration method can improve tooth brushing skills and reduce oral and dental hygiene in early childhood. This study aims to the effectiveness of counseling with brushing demonstration method as an effort to improve tooth brushing skills and the status of dental hygiene in early childhood in school. Method: this study used a quasy experiment with a pretest and posttest with one group design. This research was conducted at Kindergarten Dharma Putra Nusantara 86 Cilandak District, South Jakarta City. Independent variable: counseling by demonstration method and the dependent variable: brushing skills and the status of early childhood dental and oral hygiene. Data were tested using Wilcoxon. Results: counseling with a tooth brushing demonstration method was effective in improving brushing skills ( $p < 0.001$ ) and effective in improving the status of early childhood dental and oral hygiene ( $p < 0.001$ ). Conclusion: Counseling with the demonstration method of tooth brushing is effective as an effort to improve tooth brushing skills and the status of dental and oral hygiene in early childhood at school.

**Keywords:** *Tooth brushing demonstration method, brushing skills, the status of dental and oral hygiene.*

## Introduction

The goal of health development is the creation of Indonesian people who live and behave in a healthy environment and are able to reach quality health services. On the other hand, health services provided throughout Indonesia must be carried out fairly, evenly and optimally. Health development is directed at increasing the awareness, willingness and ability to live a healthy life for everyone so that the highest degree of public health can be realized.<sup>1,2</sup> Healthteeth are an integral part of general health. Besides teeth is one of the digestive organs that plays an important role in the process of

masticating food. Dental and oral hygiene maintenance is one of the efforts to improve health so as to prevent various oral diseases.<sup>3</sup>

Dental and oral health problems can occur in adults and children. However, children are more vulnerable to these problems, especially post-school children. This is evidenced by the results of the 2018 Basic Health Research reports that 93% of early childhood aged 5-6 years experience dental health problems; with a national deft value of 8.43, it means that the average number of tooth decay is 8 to 9 teeth per child. The high rate of dental and mouth disease is currently very much influenced by several factors, one of which is the behavioral factor of the people who are not yet aware of the importance of maintaining oral health. It is seen that the brushing behavior of the population aged  $\geq 3$  years by 2.8% behaves to brush teeth properly.<sup>4,5</sup>

Dental plaque is a soft, colorless sediment and contains a variety of bacteria that are firmly attached to the tooth surface. Plaque cannot be cleaned by gargling,

---

### Corresponding Author:

**Tedi Purnama**

Department of Dental Health, Health Polytechnic of Jakarta I, Wijaya Kusuma Raya Street, No. 47, Jakarta, Indonesia

e-mail: tedypurnama23@yahoo.com

water spray or air, but plaque can only be cleaned mechanically. Until now the most effective mechanical way to clean plaque is by brushing teeth.<sup>6</sup>

The ability to brush your teeth properly and correctly is a fairly important factor for dental and oral health care. Rubbing teeth namely the simple action of removing plaque and food scraps with a brush and toothpaste, because plaque and food scraps are the main cause of dental caries.<sup>7, 8</sup>

Poor dental and oral hygiene is one of the factors causing dental caries or oral and dental health problems. Poor oral hygiene causes plaque accumulation which contains various kinds of bacteria including the bacterium *Streptococcus mutans* as the main cause of caries. Zulfikri research (2017) shows the status of dental and oral hygiene of children with moderate criteria totaling 31 people (51.7%), with poor criteria 29 people (48.3%), and very good criteria totaling (0%) and good criteria (0%) because there are no students who have very good criteria and good criteria.<sup>9, 10</sup>

Efforts to maintain oral health and the development of dental health, especially in school children, need special attention because at this age children are undergoing a process of growth and development that will affect the development of dental health in later adulthood. Through the counseling program it is expected that the target can increase the knowledge criteria and make aware of the importance of maintaining oral health and be able to actively participate in improving self-care efforts.<sup>11</sup>

The choice of demonstration method in oral and dental health education supports the improvement of children's understanding, by directly practicing the right way to brush their teeth. Demonstration method is one of the challenging method for children because it can satisfy a child's great curiosity about something that is learned and wants to be known. This demonstration method is also right for children because it matches the concrete style and way of thinking and enhances more critical thinking. Ilyas research (2012) shows that there is an effect of dental and oral health counseling with demonstration method on decreasing plaque scores in children.<sup>6, 12</sup>

Based on background above author interested in conducting research with the title "Counseling with brushing demonstration method as an effort to improve tooth brushing skills and dental hygiene status in early childhood at school"

## Research Methodology

The method used in this research is quasy experiment with pre and post-test design with one group design. The study was conducted at Kindergarten Dharma Putra Nusantara 86 Cilandak District, South Jakarta City during February 2020. The research sample was taken with a total sampling technique, as many as 40 students. The independent variable in this study was demonstration of tooth brushing demonstration and the dependent variable was the ability to brush teeth and the exclusion status of preschool children.

Data collection on tooth brushing skills was measured by brushing teeth, validity and reliability tests had been carried out by the same researchers who examined tooth brushing skills. Dental hygiene status was measured by a standard dental hygiene examination that is the PHP-M index.<sup>13</sup> Stages of activities are as follows: pre-test by observing brushing and checking the status of children's dental hygiene, then intervening for 5 days in the form of counseling with a demonstration method of brushing teeth and practice brushing teeth at school every day and finally post-test by observing brushing teeth and check the child's dental hygiene status to see the changes. The research data uses ratio scales and statistical tests, because the data are not normal using Wilcoxon.

## Result

**Table 1. The mean value of tooth brushing skills and dental and oral hygiene status**

No.	Variable	Mean	SD	Min-Max
1	<b>Tooth brushing skills</b>			
	Pre-test	5.67	1.298	4-9
	Post-test	8.87	0.596	8-10
2	<b>Dental and oral hygiene status (PHP-M)</b>			
	Pre-test	31.95	9,686	16-59
	Post-test	19.45	7,980	10-45

Table 1. Shows the average value of children's tooth brushing skills increased from 5.67 to 8.87 and the value of dental and oral hygiene status decreased from 31.95 to 19.45

**Table 2. Test data normality**

No.	Variable	Pre-test	Post-test
1	Tooth brushing skills	0,002	0,000
2	Dental and oral hygiene status	0,000	0,000

\*Kolmogorov-Smirnov

Based on table 2 shows the normality of tooth brushing skills and dental and oral hygiene status p-value <0.05, meaning that the data is not normally distributed so non-parametric tests.

**Table 3. Test the effectiveness of tooth brushing skills and dental and oral hygiene status before and after counseling interventions with the brushing demonstration method**

Variable		Mean+SD	P-value
Tooth brushing skills	Pre-test	5.67+1,298	0.001
	Post-test	8.87+0.596	
Dental and oral hygiene status	Pre-test	31.95+9,686	0.001
	Post-test	19.45+7,980	

\*Wilcoxon

The results of the effectiveness of tooth brushing skills before and after treatment showed that the p-value was 0.001 (p <0.05) meaning that counseling with a tooth brushing demonstration method effectively improved the brushing skills of early childhood teeth in school and the status of dental and oral hygiene status p-value is 0.001 (p <0.05) meaning that counseling with a brushing demonstration method is effective in reducing the status of dental and oral hygiene in early childhood.

### Discussion

The results of the study of dental and oral hygiene status before counseling with the demonstration method of brushing teeth obtained an average value of dental and oral hygiene status of 31.95 including the medium category. In line with Pantow research (2014), the mean plaque index value before counseling using the brushing demonstration method was 1.53 in the medium category.

This is because early childhood children do not yet have the ability to brush their teeth properly proven the average value of children’s tooth brushing skills of 5.67, including the category of less skilled, so that it affects the cleanliness of teeth and mouth. Strengthened Arianto et al (2014), states that brushing their teeth properly and correctly can affect the status of dental and oral hygiene.<sup>7,14</sup>

Then the respondent is given an intervention, the first step is to introduce the tooth brushing equipment along with the storage area stored in the school environment. The response of the sample in initiating more enthusiasm and enthusiasm, means that the stimulus given to the

child was successfully seen by the child’s ability to retrieve and store it easily. Purnama (2019) states that the provision of school toothbrush storage model facilities in the form of toothbrushes and toothpaste and gargle glasses in person so that children find it easier to take and store toothbrushes without the help of others.<sup>8</sup>

Researchers conducted counseling and demonstrations to brush their teeth using phantom media. For children, how to brush teeth need to be given an example of a good model and with the simplest technique possible. Delivery of dental and oral health education to children must be made as attractive as possible, including through attractive counseling without reducing the content of education, demonstrations directly. The choice of demonstration method in oral and dental health education supports the improvement of children’s understanding, by directly practicing the right way to brush their teeth.<sup>6</sup> Furthermore, respondents do tooth brushing exercises every day for 5 consecutive days, this is in line with Research Pujiyasari (2015) the method of brushing teeth for 4 times can increase the independence of brushing your teeth. Makuch (2011) statement is also reinforced that the method of brushing teeth can be applied to teach preschoolers’ brushing skills.<sup>15, 16</sup>

The results of the effectiveness test of tooth brushing skills and after being treated showed that the p-value was 0.001 (p <0.05) meaning that counseling with a tooth brushing demonstration method was effective in improving brushing skills in early childhood at school. This also justifies the opinion expressed by Ilyas (2012) demonstration method on oral health counseling to support increased understanding of children, by practicing directly how to brush teeth correctly.<sup>6</sup>

This success was also seen in the improvement of the child’s dental and oral hygiene status. The results of the effectiveness test of oral and dental hygiene status and after being treated showed that the p-value was 0.001 (p <0.05) meaning that counseling with a tooth brushing demonstration method effectively improved the status of dental and oral hygiene in early childhood at school. The dental and mouth hygiene status scores decreased because they were given treatment in the form of counseling using a demonstration method about oral health, especially how to brush teeth correctly so that with this counseling, students will increase their knowledge so they are able to practice the right teeth brushing. The practice of brushing your teeth

properly will be able to remove plaque. Purnama et al (2019), proving that brushing your teeth with the right techniques will improve your brushing skills and clean teeth and mouth. Ilyas (2012) also proved the promotion of dental and oral health with a demonstration method for decreasing dental and oral hygiene scores.<sup>6,8</sup>

### Conclusion

**Based on the results of the study, it can be concluded that:**

1. Counseling with demonstration method proved significantly ( $p < 0.001$ ) effectively improve early childhood toothbrushing skills in school.
2. Counseling with demonstration method proved significantly ( $p < 0.001$ ) effectively improve the status of dental hygiene in early childhood

**Source Funding:** This study was done by self-funding from the authors.

**Conflict of Interest:** The authors declare that they have no conflict interests.

**Ethical Clearance:** All participants were signed the informed consent prior to the data collection.

### Reference

- 1 Ministry of Health. School Dental Health Business Guidelines (UKGS). Jakarta, Directorate General of Health Efforts; 2012.
- 2 Ministry of Health. National Action Plan for Dental and Oral Health Services 2015-2019. Jakarta, Directorate General of Health Efforts; 2015.
- 3 Alhamda S. Status of dental and oral hygiene with dental caries status (study of 12-year-old students in the Bukittinggi city state elementary school). *Journal of Community Medicine News*. 2011; 27 (2): 108.
- 4 Purnama T, Rasipin R, Ngatemi. Tedi's Behavior Change Model to Improving Brushing Teeth Behavior Parents. *Journal of Applied Health Management Technology*. 2020; 2 (1): 1-12.
- 5 Ministry of Health. Main results Riskesdas 2018. Research and Development Agency; 2018. p.179-217
- 6 Ilyas M, Putri I. The effect of counseling on the demonstration method of brushing teeth on decreasing the dental plaque index in elementary school students. *Dentofacial Journal of Dentistry*. 2012; 11 (2): 91-95.
- 7 Arianto A, Shaluhayah Z, Nugraha P. Teeth Brushing Behavior in Elementary School Students Class V and VI in Sumberejo District. *Indonesian Health Promotion Journal*. 2014; 9 (2): 127-135.
- 8 Purnama T, Rasipin R, Santoso B. Effects of Tedi's Behavior Change Model Training on Teachers and Parents on the Teeth Brush Skills of Preschoolers. *Journal Health Quality*. 2019; 13 (2): 75-81.
- 9 Yuliana NM, Setiawan H, Hendari R. Effect of Education Through Dental Care to Clean Dental and Mouth Patients in Post-Dental Patients Due to Caries. *Journal of Dental Health*. 2014; 2 (2): 249-259.
- 10 Zulfikri Z, Huda Z. The Relationship of the Dental and Mouth Clean Index With The Dental Career Index In The Disciples of SDN 03 Features of Kurai Subdistrict, Long Guguk District, Bukittinggi City. *Journal of Dental Health*. 2017; 4 (1): 55-62.
- 11 Prasko P, Santoso B, Sutomo B. Counseling of audio visual method and demonstration of the knowledge of brushing teeth in elementary school children. *Journal of Dental Health*. 2016; 3 (2): 53-57.
- 12 Agustin D. The Use of Demonstration Method Against Ability to Brush Teeth in Children with ADHD (Attention Deficit Hyperactivity Disorder). *Special Education Journal*. 2014; 6 (6).
- 13 Ngatemi, Purnama T. Dental Health Handbook as Parents Monitoring in the Formation of Independence for Brushing Teeth in Early Childhood. *Indian Journal of Public Health Research Development*. 2020; 11(1):785-790
- 14 Pantow CB, Warouw SM, Gunawan PN. The Effect of Counseling on Brushing Teeth Against Dental Plaque Index on Elementary Inpres Field Students. *Journal e-Gigi* 2014; 2 (2).
- 15 Pujiyasari S, Asih SHM, Nurullita U. The effect of brushing teeth training method on the independence of brushing children's teeth in school-age mental retardation. *Journal of Nursing and Midwifery*. 2014; 3:1-11
- 16 Makuch A, Reschke K, Rupf S. Effective teaching of tooth-brushing to preschool children. *J Dent Child (Chic)*. 2011; 78 (1): 9-12.

# Smoking Behavior among Female Worker in Indonesia Does Education Matter?

Nikmatur Rohmah<sup>1</sup>, Anita Dewi Prahastuti Sujoso<sup>2</sup>, Masrurroh<sup>3</sup>, Ilyas Ibrahim<sup>4</sup>,  
Qurnia Andayani<sup>5</sup>, Irfansyah Baharuddin Pakki<sup>6</sup>, Agung Dwi Laksono<sup>7</sup>

<sup>1</sup>Lecturer, Faculty of Health Science, Muhammadiyah University of Jember East Java Indonesia, <sup>2</sup>Lecturer, Public Health Faculty Jember University East Java, Indonesia, <sup>3</sup>Lecturer, Faculty of Health Science Universitas Pesantren Tinggi Darul Ulum Jombang, East Java, Indonesia, <sup>4</sup>Lecturer, Faculty of Health Science, Bumi Hijrah Tidore University, North Maluku, Indonesia, <sup>5</sup>Doctoral Program, Faculty of Public Health, University of Airlangga Surabaya Indonesia, <sup>6</sup>Lecturer, Faculty of Public Health University of Mulawarman, Samarinda, Kalimantan Timur, Indonesia, <sup>7</sup>Researcher, National Institute of Health Research and Development, The Indonesian Ministry of Health

## Abstract

Smoking behavior in women has a risk of fertility problems, the reproductive system, and many other health problems. This study was aimed at analyzing the effect of education level on smoking behavior among female workers in Indonesia. The samples used were a female worker. The sample size was 51,815 respondents. Apart from education, other independent variables analyzed were the place of residence, age, marital, wealth, and pregnant status. Determination of determinant by binary logistic regression. The results of the study informed that female workers with primary education were 0.456 times more likely than no education to become smokers. Female workers with secondary education are 0.428 times more likely than no education to become smokers. Female workers with higher education are 0.219 times more likely than no education to become smokers. The results of this analysis indicate that the higher the education level, the lower the possibility of female workers becoming smokers. Apart from the education level, 4 other variables were also found as predictors of smoking behavior among female workers, namely the place of residence, age, wealth, and pregnant status. It was concluded that the education level was a predictor of smoking behavior among female workers in Indonesia. The higher the education level, the lower the possibility of female workers becoming smokers.

**Keywords:** *Smoking behavior, female worker, tobacco use.*

## Introduction

It is reported that female smokers worldwide reach 250 million people, 22% in developed countries, and 9% in developing countries<sup>1</sup>. Several countries reported a complete reversal in relative prevalence between men and women, accompanied by a shrinking gap between male and female smokers in adulthood<sup>2</sup>. This

condition shows that smoking behavior in women globally can change significantly in the future<sup>2</sup>. In line with the increase in female smokers, it was found that female smokers were at greater risk of experiencing pain due to tobacco use than men. Female smokers are at risk of developing breast, fibroid, and lung cancer<sup>3,4</sup>. Some female smokers reported not stopping smoking while pregnant<sup>5</sup>. Screening results in female smokers showed positive depression at early pregnancy, late pregnancy, and 12 months after delivery<sup>5</sup>. Quitting smoking especially early in pregnancy is associated with a reduction in preterm birth<sup>6</sup>. Besides, smoking also has adverse effects on the reproductive system, increased risk of infertility, stillbirth, sudden death syndrome, and intrauterine fetal growth disorders<sup>7</sup>.

---

### Corresponding Author:

**Nikmatur Rohmah**

Lecturer, Faculty of Health Science, Muhammadiyah University of Jember East Java Indonesia

e-mail: nikmaturrohmah@unmuhjember.ac.id

Most of the smokers are female workers. Female smokers working in Indonesia are reported to be 66.2%<sup>8</sup>, in Iran 27.7%<sup>9</sup>, and Brazil 40.3%<sup>10</sup>. 7.3% of female smokers in Brazil still smoke during pregnancy<sup>10</sup>. Women who smoke in China are reported to have poor education and socioeconomic<sup>8</sup>. A Canadian study of female smokers reported that female smokers were more likely to continue smoking during pregnancy which was associated with education and employment status<sup>11</sup>. Meanwhile, in Bangladesh, it was also reported that 51.0% of smokers were women, and 33.6% worked in various sectors<sup>12</sup>.

Female workers are one of the seven vulnerable groups. Some of the vulnerabilities of female workers that occur in the European Union include discrimination in workgroups, sexual harassment, lack of concern for reproductive health, including menstruation leave and pregnancy<sup>13</sup>. Vulnerabilities in female reproduction include not being allowed to get pregnant while working, not having a baby during the contract period, greater wage discrimination for men, including work benefits, such as children and family, less than maximum menstrual and pregnancy leave, harassment, and sexual violence<sup>14</sup>. The psychological vulnerability of female workers is 30.8% higher than that of men. Psychological vulnerabilities can take the form of bullying, anxiety, stress, mental badness, and depression<sup>15</sup>.

Working women show an important aspect in the macro economy<sup>16</sup>, but it is also a challenge that women must face. Working women have a double burden, namely as workers outside the home and workers in the home<sup>17</sup>. World Bank data shows that the percentage of female workers in 2018 was 50.7%, and those aged 15 years and over. This data forms the basis that women have a role in the family economy<sup>18</sup>. The dual roles of female workers include caring for their children, being mothers, partners as well as being members of society. This condition affects emotional health, physical health, social and economic activities<sup>15</sup>. Based on the background description, the study was aimed at analyzing the effect of education level on smoking behavior among female workers in Indonesia.

## Materials and Method

Data from the 2017 Indonesian Demographic Data Survey (IDHS) was used as material for analysis in this study. The unit of analysis in this study was female workers (15-49 years) in Indonesia. The 2017 IDHS

used stratification and multistage random sampling, so it got 51,815 respondents.

Smoking behavior is the respondent's recognition of his smoking behavior. Divided into 2 categories, namely no smoking and smoking. Apart from the education level, other independent variables analyzed were the type of place of residence, age groups, marital status, wealth status, and pregnant status.

All variables involved in the analysis of this study were dichotomous variables, therefore the chi-square test was used to examine the relationship between education level and other variables. In the final stage, binary logistic regression is used because of the nature of the dependent variable. All statistical analyzes were carried out using SPSS 22 software.

## Results and Discussion

Table 1 displays descriptive statistics of female workers in Indonesia. It can be seen that all categories of education level are dominated by female workers who don't smoke. Based on the education level, primary and no education female workers are predominantly living in rural areas, while female workers with secondary and higher education levels are predominantly living in urban areas.

Based on the age group, primary and no education female workers are dominated by the 45-49 age group, while female workers with secondary and higher education levels are dominated by the 35-39 age group. All-female workers are dominated by those who are married or living with partners.

Based on wealth status, primary and no education female workers were dominated by the poorest, while female workers who had education at the secondary category level were dominated by the richer, and female workers who had education at the higher category level were dominated by the richest. Based on variable status, all-female workers were dominated by those who were not pregnant.

Table 2 shows the results of the binary logistic regression of smoking behavior among female workers in Indonesia. It can be seen that female workers with primary education have a 0.456 times chance compared to no education female workers to become smokers (OR 0.456; 95% CI 0.393-0.529). Female workers with secondary education are 0.428 times more likely than

no education female workers to become smokers (OR 0.428; 95% CI 0.366-0.501). Female workers with higher education are 0.219 times more likely than no education female workers to become smokers (OR 0.219; 95% CI 0.171-0.279).

The results of this analysis indicate that the higher the education level, the lower the possibility of female workers becoming smokers. The better the level of education, the more female workers understand the risk of behavior that will be adopted in their daily lives. This condition makes education level often found as a positive predictor of output in the health sector<sup>8,19,20</sup>. On

the other hand, low levels of education are often found to be a barrier to output in the health sector<sup>21,22</sup>.

Apart from the education level, 4 other variables were also found as predictors of smoking behavior among female workers. First, based on the type of place of residence, it was found that female workers living in rural were 0.643 times more likely than female workers living in urban to become smokers (OR 0.643; 95% CI 0.588-0.704). This information shows that female workers who live in urban have a higher likelihood of becoming smokers. The same findings were also confirmed in several previous studies<sup>23,24</sup>.

**Table 1. The descriptive statistics of the education level of female workers in Indonesia (n=51,815)**

Variables	Education Level								P
	No Education		Primary		Secondary		Higher		
	n	%	n	%	n	%	n	%	
<b>Smoking Behavior</b>									<b>***0.000</b>
No	2672	91.9%	31546	96.6%	40080	97.2%	9302	98.7%	
Yes	237	8.1%	1125	3.4%	1154	2.8%	123	1.3%	
<b>Type of place of residence</b>									
Urban	575	19.7%	11233	34.4%	23219	56.3%	6300	66.8%	
Rural	2337	80.3%	21450	65.6%	18025	43.7%	3126	33.2%	
<b>Age Group</b>									<b>***0.000</b>
15-19	7	0.2%	114	0.3%	318	0.8%	6	0.1%	
20-24	45	1.5%	718	2.2%	2354	5.7%	241	2.6%	
25-29	113	3.9%	2085	6.4%	4918	11.9%	1278	13.6%	
30-34	247	8.5%	4336	13.3%	7646	18.5%	2209	23.4%	
35-39	443	15.2%	7125	21.8%	9597	23.3%	2231	23.7%	
40-44	724	24.9%	8856	27.1%	9111	22.1%	1812	19.2%	
45-49	1333	45.8%	9449	28.9%	7300	17.7%	1649	17.5%	
<b>Marital Status</b>									<b>0.527</b>
Never in union/Divorced/Widowed	2	0.1%	17	0.1%	27	0.1%	9	0.1%	
Married/Living with partner	2910	99.9%	32666	99.9%	41217	99.9%	9417	99.9%	
<b>Wealth status</b>									<b>***0.000</b>
Poorest	2065	70.9%	13508	41.3%	7895	19.1%	547	5.8%	
Poorer	476	16.3%	7737	23.7%	7817	19.0%	803	8.5%	
Middle	220	7.6%	5801	17.7%	8458	20.5%	1088	11.5%	
Richer	102	3.5%	3916	12.0%	9134	22.1%	2019	21.4%	
Richest	49	1.7%	1721	5.3%	7940	19.3%	4969	52.7%	
<b>Pregnant</b>									<b>***0.000</b>
No	2872	98.6%	31955	97.8%	39802	96.5%	9083	96.4%	
Yes	40	1.4%	728	2.2%	1442	3.5%	343	3.6%	

Note: \*p <0.05; \*\*p <0.01; \*\*\*p <0.001.



**Table 2: Results of binary logistic regression of smoking behavior among female worker in Indonesia (n=51,815)**

Predictor	Low Birth Weight			
	P	OR	Lower Bound	Upper Bound
Education Level: No education	-	-	-	-
Education Level: Primary	***0.000	0.456	0.393	0.529
Education Level: Secondary	***0.000	0.428	0.366	0.501
Education Level: Higher	***0.000	0.219	0.172	0.279
Type of place of residence: Urban	-	-	-	-
Type of place of residence: Rural	***0.000	0.643	0.588	0.704
Age group of respondents: 15-19	-	-	-	-
Age group of respondents: 20-24	0.804	0.909	0.428	1.932
Age group of respondents: 25-29	0.531	1.258	.614	2.578
Age group of respondents: 30-34	0.137	1.712	.844	3.474
Age group of respondents: 35-39	*0.034	2.140	1.057	4.330
Age group of respondents: 40-44	0.059	1.975	0.976	3.997
Age group of respondents: 45-49	*0.032	2.168	1.071	4.387
Wealth status: Poorest	-	-	-	-
Wealth status: Poorer	***0.000	0.771	0.692	0.859
Wealth status: Middle	***0.000	0.523	0.460	0.595
Wealth status: Richer	***0.000	0.483	0.421	0.554
Wealth status: Richest	***0.000	0.481	0.414	0.560
Pregnant: No	-	-	-	-
Pregnant: Yes	*0.028	0.723	0.542	0.965

Note: \* p <0.05; \*\* p <0.01; \*\*\* p <0.001.

Second, the results of the analysis found that the age group had a partial effect on smoking behavior among female workers. Female workers in the 35-39 age group were 2.140 times more likely than female workers in the 15-19 age group to become smokers (OR 2.140; 95% CI 1.057-4.330). Female workers in the 45-49 age group were 2.168 times more likely than female workers in the 15-19 age group to become smokers (OR 2.168; 95% CI 1.071-4.387). Previous studies in Costa Rica, Iran, and Cuba also informed the same finding, that age is a predictor of smoking behavior<sup>23,25,26</sup>.

Third, wealth status. Female workers with poorer wealth status have a probability of 0.771 times compared to the poorest female workers to become a smoker (OR 0.771; 95% CI 0.692-0.859). Female workers with middle wealth status have a 0.523 times chance compared to the poorest female workers to become smokers (OR

0.523; 95% CI 0.460-0.595). Female workers with richer wealth status have a 0.483 times chance compared to the poorest female workers to become smokers (OR 0.483; 95% CI 0.421-0.554). The richest female worker was 0.481 times more likely than the poorest female worker to become a smoker (OR 0.481; 95% CI 0.414-0.560). This information is in line with the findings of the previous studies<sup>27</sup>.

Fourth, pregnant status. Pregnant female workers had 0.723 times the probability of non-pregnant female workers becoming smokers (OR 0.723; 95% CI 0.542-0.965). This means that pregnancy is a protective factor to prevent female workers from smoking.

## Conclusions

Based on the analysis, it can be concluded that education was a predictor of smoking behavior among

female workers in Indonesia. The higher the education, the lower the possibility of female workers to become smokers. Apart from education, 4 other variables were also found as predictors of smoking behavior among female workers, namely type of place of residence, age group, wealth status, and pregnant status.

**Acknowledgments:** The author would like to thank the ICF International, who has agreed to allow the 2017 IDHS data to be analyzed in this article.

**Source of Funding:** Self-funding

**Conflict of Interest:** The authors declare no conflict of interest, financial or otherwise.

**Ethical Clearance:** The 2017 IDHS has received ethical clearance from the National Ethics Commission. Utilization of the 2017 IDHS data in this study has been permitted by ICF International through its website: <https://dhsprogram.com/data/new-user-registration.cfm>.

## References

- Phetphum C, Pongpreecha B, Hangsantea J, Muankaew W. Predicting Factors for Smoking Behavior among Women Who Frequent Nightlife Entertainment Venues around a University in the Northern Region of Thailand. *Subst Abuse Res Treat*. 2018;12.
- Solomon A. Gender, women, and the future of tobacco control. *Drugs and Alcohol Today*. 2020;May:1–15.
- Jones ME, Schoemaker MJ, Wright LB, Ashworth A, Swerdlow AJ. Smoking and risk of breast cancer in the Generations Study cohort. *Breast Cancer Res*. 2017;19(1):1–14.
- Wong JYY, Chang PY, Gold EB, Johnson WO, Lee JS. Environmental tobacco smoke and risk of late-diagnosis incident fibroids in the Study of Women's Health across the Nation (SWAN). *Fertil Steril*. 2016;106(5):1157–64.
- Jones AM, Carter-Harris L, Stiffler D, Macy JT, Staten LK, Shieh C. Smoking Status and Symptoms of Depression During and After Pregnancy Among Low-Income Women. *JOGNN - J Obstet Gynecol Neonatal Nurs*. 2020;49(4):361–72.
- Soneji S, Beltrán-Sánchez H. Association of Maternal Cigarette Smoking and Smoking Cessation With Preterm Birth. *JAMA Netw open*. 2019;2(4):1-14.
- Lukowski A. Women & Smoking Health risk. 2015.
- Laksono AD, Wulandari RD, Rukmini R, Matahari R. Determinant of Smoking Behavior among Childbearing Age Women in Indonesia. *Int J Psychosoc Rehabil*. 2020;24(8):6292–303.
- Baheiraei A, Ghafoori F, Nedjat S, Foroushani AR. Sociodemographic characteristics and secondhand smoke exposure among women. *Tanaffos*. 2013;12(2):41–7.
- Madeira Domingues RMS, Figueiredo VC, Carmo Leal M do. Prevalence of pre-gestational and gestational smoking and factors associated with smoking cessation during pregnancy, Brazil, 2011-2012. *PLoS One*. 2019;14(5):2011–2.
- Gilbert NL, Nelson CRM, Greaves L. Smoking Cessation During Pregnancy and Relapse After Childbirth in Canada. *J Obstet Gynaecol Canada*. 2015;37(1):32–9.
- Islam FMA, Walton A. Tobacco Smoking and Use of Smokeless Tobacco and Their Association with Psychological Distress and Other Factors in a Rural District in Bangladesh: A Cross-Sectional Study. *J Environ Public Health*. 2019;2019:11.
- European Agency for Safety and Health at Work (EU-OSHA). New risks and trends in the safety and health of women at work. Luxembourg: Publications Office of the European Union. Luxembourg; 2014. 51 p.
- Kabir H, Maple M, Fatema SR. Vulnerabilities of Women Workers in the Readymade Garment Sector of Bangladesh : A Case Study of Rana Plaza. *J Int Womens Stud*. 2018;19(6):224–35.
- Ansoleaga E, Ahumada M, Cruz AGS. Association of workplace bullying and workplace vulnerability in the psychological distress of Chilean workers. *Int J Environ Res Public Health*. 2019;16(20):1–14.
- Mehrotra S, Sinha S. Explaining falling female employment during a high growth period. *Econ Polit Wkly*. 2017;52(39):54–62.
- Wunrn. Current Trends Suggested Global Strategies to Support the Feminization of the Workforce the Double Burden of Working Women. 2018;
- Ginting PA. Implementasi Teori Maslow dan Peran Ganda Pekerja Wanita K3L Universitas Padajajaran. *Focus J Pekerj Sos*. 2019;1(3):220.
- Wulandari RD, Laksono AD. Education as

- predictor of the knowledge of pregnancy danger signs in Rural Indonesia. *Int J Innov Creat Chang*. 2020;13(1):1037–51.
20. Ipa M, Widawati M, Laksono AD, Kusri I, Dhewantara PW. Variation of preventive practices and its association with malaria infection in eastern Indonesia: Findings from community-based survey. *PLoS One*. 2020;15(5):e0232909.
  21. Rohmah N, Yusuf A, Hargono R, Laksono AD, Masruroh, Ibrahim I, et al. Determinants of teenage pregnancy in Indonesia. *Indian J Forensic Med Toxicol*. 2020;14(3):2080–5.
  22. Laksono AD, Wulandari RD. The Barrier to Maternity Care in Rural Indonesia. *J Public Heal From Theory to Pract*. 2020;Online First.
  23. Aguirre AE, Fantin R, Solis CB, Miranda AS. Sociodemographic characteristics associated with the prevalence of tobacco use in Costa Rica. *Rev Panam Salud Publica/Pan Am J Public Heal*. 2020;44:Article number e17.
  24. Barik A, Rai RK, Gorain A, Majumdar S, Chowdhury A. Socio-economic disparities in tobacco consumption in rural India: Evidence from a health and demographic surveillance system. *Perspect Public Health*. 2016;136(5):278–87.
  25. Masjedi MR, Roshanfekar P, Naghdi S, Higgs P, Armoon B, Ghaffari S, et al. Socio-economic contributors to current cigarette smoking among Iranian household heads: findings from a national household survey. *J Subst Use*. 2020;25(2):217–23.
  26. Thomson B, Rojas NA, Lacey B, Burrett JA, Varona-Pérez P, Martínez MC, et al. Association of childhood smoking and adult mortality: prospective study of 120 000 Cuban adults. *Lancet Glob Heal*. 2020;8(6):e850-7.
  27. Buffarini R, Abdalla S, Weber AM, Costa JC, Menezes AMB, HelenGonçalves, et al. The Intersectionality of Gender and Wealth in Adolescent Health and Behavioral Outcomes in Brazil: The 1993 Pelotas Birth Cohort. *J Adolesc Heal*. 2020;66(1):S51-7.

# Biostatistics Evaluation of Women Breast Lesions in Baghdad/Iraq

Noor F.M. Ali<sup>1</sup>, Hiba A. Abdul Sattar<sup>2</sup>, Mervet Abd-alhassan<sup>3</sup>,  
Fathaa Abdullah Mahmoud<sup>4</sup>, Munya H. Sabri<sup>5</sup>

<sup>1</sup>College of Pathological Analysis Technique/Al- Bayan University, Baghdad, Iraq, <sup>2</sup>College of Medical Lab Techniques/Osol Aldeen University College, Baghdad, Iraq, <sup>3</sup>College of Pathological Analysis Technique/Al-Bayan University, Baghdad, Iraq, <sup>4</sup>College of Pathological Analysis Technique/Al-Bayan University, Diyala, Iraq, <sup>5</sup>Al-Elwiyah Educational Hospital, Baghdad, Iraq

## Abstract

**Background:** Breast lesions are a basic term for a benign or malignant tumor or bump in the breast. This study is aimed to evaluate the biostatistics range of the malignant lesions in women breast in Baghdad/Iraq and compared it with other types of breast lesions by using ultrasound in diagnoses.

**Method:** The study is done on 1494 of women patients from different ages and screened through six months in Al-Elwiya Educational Hospital in Baghdad/Iraq, by using ultrasound machine to diagnosis of the breast lesion type's and divided it into groups (normal, benign, suspected and malignant).

**Conclusion:** Our result showed **horizontally** significant differences ( $P \leq 0.01$ ), ( $P \leq 0.05$ ) in groups of (normal, Benign, suspected) in percentages about (35.94%), (30.79%), (32.20%) respectively. Except of malignant group has no significant differences and percentage about (1.07%) through all months. And **vertically** our result showed high significant differences ( $P \leq 0.01$ ) between all the studied groups (normal, benign, suspected, and malignant) and percentages was (35.94%, 30.79%, 32.20%, and 1.07%) respectively. That means there is little case of malignant lesion significantly improved by ultrasound, because all the suspicious breast lesions detected by ultra-sound should be biopsied in histologic results to confirm or exclude the presence of malignancy.

**Keywords:** Breast, lesion, tumor, benign, malignant, suspected, ultrasound.

## Introduction

The tumor (also known as a neoplasm) is an abnormal mass of tissue that may be solid or fluid-filled. In general, tumors are divided into three groups:<sup>1,2</sup>

- **Benign:** These are not cancerous, not harmful and cannot spread. A benign tumor will remain in its current form. They do not generally return after being removed.

- **Premalignant:** A premalignant tumor is not yet cancerous but appears to be developing the properties of cancer. It's required close monitoring.
- **Malignant:** Malignant tumors are cancerous. They can grow quickly, spread, and can potentially result in death.

Breast tissue is heterogeneous, associating connective and glandular structures, which grow and change cyclically under hormonal regulation. Hormones are also thought to be the main determinant of the major benign and malignant pathologies encountered in the breast. Benign lesions are more frequent and fibrocystic changes are by far the most common among them. They usually associate different entities, (adenosis, fibrosis, cysts and hyperplasia) but vary in intensity and extension.

---

### Corresponding Author:

Noor F.M. Ali

College of Pathological Analysis Technique/Al- Bayan University, Baghdad, Iraq

e-mail: noor\_veterinarian@yahoo.com

Thus, their clinical and radiographic presentation is extremely different from one patient to another.<sup>3</sup>

Breast cancer is regarded as one of the most frequent mortality causes among women. As early detection of breast cancer increases the survival chance. Breast cancer symptoms vary widely — from lumps to swelling to skin changes—and many breast cancers have no obvious symptoms at all.<sup>4,5</sup>

Ultrasound is safe, painless and widely used. It produces pictures of the inside of the body using sound waves. Ultrasound imaging is also called ultrasound scanning or sonography. Ultrasound exams are Noninvasive and does not use radiation (like X-rays) that helps physicians diagnose and treat many of medical conditions. The images are captured in real-time; so they can show the structure and movement of the body's internal organs. They can also show blood flowing through blood vessels. When an ultrasound examination reveals a suspicious breast abnormality, a physician may choose to perform an ultrasound-guided biopsy.<sup>6</sup>

### Materials and Method

1494 of women patients from different ages were screened through six months (beginning from January/2019 till the end of June/2019) in Al-Elwiya Educational Hospital in Baghdad/Iraq, all were viewed by using ultrasound machine (MEDISON SONOACE 8000 Live prime) to diagnosis of the breast lesion type's and divided it into (normal, benign, suspected and malignant).

The ultrasound machine produces pictures of the internal structures of the breast by using sound waves. It uses a small probe called a transducer and gel placed directly on the skin of breast. High-frequency sound waves travel from the probe through the gel into the breast. The probe collects the sounds that bounce back. A computer uses those sound waves to create an image.

Ultrasound imaging can help to determine whether a new breast lump is a solid (which may be a non-cancerous tumor or a cancerous tumor), fluid-filled (such as a benign cyst) or both solid and cystic.<sup>7</sup>

High-quality images of the normal and abnormal breast can be obtained with modern ultrasound equipment. At the minimum, a 7.5 MHz linear array

probe should be used, through digital broadband-width transducers using higher frequency (mid-range exceeding 7.5 MHz) are widely available and allow higher resolution imaging. The patient is examined in the supine oblique position. The side being examined is raised and the arm placed above the head to ensure that the breast tissue is evenly distributed over the chest wall. In addition to conventional orthogonal scanning direction, scanning in the radial and antiradial planes are of value in demonstrating ductal abnormalities.<sup>8,9</sup>

**Statistical Analysis:** The Statistical Analysis System program was used to detect the effect of difference factors in study parameters. Chi-square test was used to significant compare between percentage (0.05 and 0.01 probability) in this study.<sup>10</sup>

### Results and Discussion

Our results in 1494 patient screened will explained in two ways:

**First: Horizontally:** According to the table (1) the column of normal group has high significant differences ( $P \leq 0.01$ ) in percentage about (35.94%) through all months, the highest percentage was in January (44.90%), the lowest percentage in June (26.91%).

The column of benign group has significant differences ( $P \leq 0.05$ ) in percentage about (30.79%) through all months, the highest percentage was in January (37.24%), the lowest percentage in April (26.16%).

The column of suspected group has high significant differences ( $P \leq 0.01$ ) in percentage about (32.20%) through all months, the highest percentage was in June (40.36%), the lowest percentage in January (17.86%).

The column of malignant group has no significant differences in percentage about (**1.07%**) through all months.

**Second: Vertically:** The table below showed high significant differences ( $P \leq 0.01$ ) between all the studied groups (normal, benign, suspected, and malignant) was (35.94%, 30.79%, 32.20%, and 1.07%) respectively. The highest percentage was in normal cases (35.94%), but the lowest percentage was in malignant cases (1.07%). That means there is little case of malignant lesion diagnosed by ultrasound.

**Table (1): Total Number of patients that are diagnosed in all the Six month (from January 2019 to June 2019) and classified to (normal, benign, malignant, and suspected)**

Months	Total patients	Total No. of Normal	Total No. of Benign	Total No. of Suspected	Total No. of Malignant	Chi-Square ( $\chi^2$ )
January	196(13.12%)	88(44.90%)	73(37.24%)	35(17.86%)	0(0.00%)	11.641**
February	281(18.81%)	112(39.86%)	95(33.81%)	70(24.91%)	4(1.42%)	9.836**
March	261(17.47%)	88(33.72%)	75(28.73%)	88(33.72%)	10(3.83%)	9.107**
April	279(18.67%)	93(33.33%)	73(26.16%)	112(40.14%)	1(0.36%)	12.632**
May	254(17.00%)	96(37.80%)	72(28.35%)	86(33.86%)	0(0.00%)	9.871**
June	223(14.94%)	60(26.91%)	72(32.29%)	90(40.36%)	1(0.45%)	10.523**
Chi-Square ( $\chi^2$ )	2.194NS	6.702**	4.524*	9.331**	0.536NS	---
<b>Total summary</b>						
All Six months	1494	537(35.94%)	460(30.79%)	481(32.20%)	16(1.07%)	9.761**

\*( $P \leq 0.05$ ), \*\* ( $P \leq 0.01$ )

## Discussion

**Horizontally**, our results in all six months showed significant differences ( $P \leq 0.01$  &  $P \leq 0.05$ ) of normal, benign and suspected cases group except the malignant that showed no significant differences because of the Variable consequences depending on the applied techniques used, as well as their diagnostic measures. Additionally, thickness, lesion size, shape of breast that affected on ultrasound for differentiation of normal, benign, suspected and malignant breast lesions. And this finding is agreed with.<sup>11</sup>

Malignant lesions that are soft, like: mucinous carcinomas, necrotic tumors, and ductal carcinoma in situ, may be false diagnosed as benign, and benign conditions that are stiff, such as: scarring, fibrosis, and complex fibroadenomas, may be misjudged as malignant. And this result is fixed with<sup>12,13 and 14</sup>.

**Vertically**, the results showed high significant differences ( $P \leq 0.01$ ) between all the studied groups (normal, benign, suspected, and malignant). The highest percentage was in normal cases (35.94%), but the lowest percentage was in malignant cases (1.07%). That means there is little case of malignant lesion significantly improved by ultrasound, because all the suspicious breast lesions detected by U/S should be biopsied in histologic results to confirm or exclude the presence of malignancy. And all that is agreed with.<sup>15</sup>

## Conclusion

At the end, our study of Biostatistics evaluation of women breast lesions in Baghdad/Iraq showed that breast thickness (lesion size, lesion depth, lesion location and pathologic finding) are factors influencing the image quality at ultrasound, with sensitivity for the classification of benign and malignant masses improving with higher quality scores. And all the suspicious breast lesions detected by ultrasound should be biopsied in histologic results to confirm or exclude the presence of malignancy.

**Conflict of Interest:** Nil

**Source of Funding:** Self-funding

**Ethical Clearance:** All the data collected was approved by doctors in Al-Elwiya Educational Hospital in Baghdad/Iraq. The patient name and personal data have not been collected.

## References

1. Liberman L, Bonaccio E, Hamele-Bena D, Abramson AF, Cohen MA, Dershaw DD. Benign and malignant phyllodes tumors: mammographic and sonographic findings. *Radiology*. 1996 Jan; 198 (1):121-4.
2. Enzinger FM, Weiss SW. *Soft tissue tumors* 2nd ed. St Louis, Mo: Mosby-Year Book. 1988:719-860.

3. Guinebretiere JM, Menet E, Tardivon A, Chere P, Vanel D. Normal and pathological breast, the histological basis. *European journal of radiology*. 2005 Apr 1;54 (1):6-14.
4. Rouhi R, Jafari M, Kasaei S, Keshavarzian P. Benign and malignant breast tumors classification based on region growing and CNN segmentation. *Expert Systems with Applications*. 2015 Feb 15;42(3):990-1002.
5. Rahbar G, Sie AC, Hansen GC, Prince JS, Melany ML, Reynolds HE, Jackson VP, Sayre JW, Bassett LW. Benign versus malignant solid breast masses: US differentiation. *Radiology*. 1999 Dec;213 (3):889-94.
6. Parker SH, Dennis MA, Stavros AT, Johnson KK. Ultrasound-guided mamotomeotomy: a new breast biopsy technique. *Journal of Diagnostic Medical Sonography*. 1996 May; 12(3):113-8.
7. <https://www.radiologyinfo.org/en/info.cfm?pg=breastus>
8. Hagen-Ansert SL. *Textbook of Diagnostic Sonography: 2-Volume Set*. Elsevier Health Sciences; 2011 Jun 20.
9. Alwan NA. Breast cancer among Iraqi women: Preliminary findings from a regional comparative Breast Cancer Research Project. *Journal of global oncology*. 2016 Oct;2(5):255.
10. SAS. *J. Statistical Analysis System, User's Guide*. Statistical. Version 9.1<sup>th</sup> ed. SAS. Inst. Inc. Cary. N.C. USA. 2012.
11. Chang JM, Moon WK, Cho N, Kim SJ. Breast mass evaluation: factors influencing the quality of US elastography. *Radiology*. 2011 Apr;259(1):59-64.
12. Itoh A, Ueno E, Tohno E, Kamma H, Takahashi H, Shiina T, Yamakawa M, Matsumura T. Breast disease: clinical application of US elastography for diagnosis. *Radiology*. 2006 May;239(2):341-50.
13. Berg WA, Cosgrove DO, Doré CJ, Schäfer FK, Svensson WE, Hooley RJ, Ohlinger R, Mendelson EB, Balu-Maestro C, Locatelli M, Tourasse C. Shear-wave elastography improves the specificity of breast US: the BE1 multinational study of 939 masses. *Radiology*. 2012 Feb; 262(2):435-49.
14. Chang JM, Moon WK, Cho N, Yi A, Koo HR, Han W, Noh DY, Moon HG, Kim SJ. Clinical application of shear wave elastography (SWE) in the diagnosis of benign and malignant breast diseases. *Breast cancer research and treatment*. 2011 Aug 1;129(1):89-97.
15. Cha JH, Moon WK, Cho N, Kim SM, Park SH, Han BK, Choe YH, Park JM, Im JG. Characterization of benign and malignant solid breast masses: comparison of conventional US and tissue harmonic imaging. *Radiology*. 2007 Jan;242(1):63-9.

# Strategies of Carious Tissue Removal in Deep Carious Lesions among Dentists in Iraq: Online Based Survey Study

Noor H. Fadhil<sup>1</sup>, Anas F. Mahdee<sup>2</sup>, Ahmed H. Ali<sup>3</sup>

<sup>1</sup>Assistant Lecturer, <sup>2</sup>Assistant Professor, <sup>3</sup>Lecturer, Department of Aesthetic and Restorative Dentistry, College of Dentistry, University of Baghdad, Baghdad, Iraq

## Abstract

The aim was to find out the preferences of dentists in Iraq regarding strategies of carious tissue removal in management of deep carious lesions (CR) in asymptomatic teeth and how demographics (sex, years of experience, qualification, specialty, place of work) influences these preferences. An online questionnaire of two months duration was constructed and distributed randomly via social media (Facebook). The questionnaire' questions investigated the demographics, CR (included non-selective removal to hard dentine (NS), stepwise (SW) and selective (SE) removal). 238 dentists participated in the study, 164 (69%), 56 (23.5%) and 18 (7.5%) of respondents prefer NS, SW and SE removal, respectively. Significantly both GDP and males prefer NS more than Endodontists and females ( $P < 0.05$ ), Percent of respondents work in private clinics who perform non-selective removal (53.6%) significantly lower than those who work in hospitals (73.6%) ( $p < 0.01$ ). less invasive CR significantly associated with being an endodontist or female or work in a private clinic (OR=2.02, CI 95% 1.02-4.0), (OR=2.04, CI 95% 1.12-3.7) and (OR=2.1, CI 95% 1.0-4.0), respectively. In conclusion Iraqi GDPs prefer invasive strategy of carious tissue removal in management of deep carious lesions. Specialty, place of work and sex of respondents affected these choices significantly.

**Keywords:** *Selective, stepwise, deep carious lesion, dentists, attitude.*

## Introduction

The treatment of deep dentin caries is a daily practice for most dentists worldwide. However, there is no consensus in the dental profession regarding the best practice protocol, excavation technique, treatment option in the event of pulp exposure or suitable materials after pulp exposure. Traditionally removal of all heavily contaminated and demineralized dentin in deep carious lesions (non-selective carious tissue removal to hard dentine) was the aim of dentists in the case of treatment of deep carious lesion<sup>1</sup>, this procedure may result in a pulpal exposure often. Therefore, attention has brought

to a more minimal invasive method such as stepwise removal and selective removal (to leathery dentin), which shows higher success rates and lower risk of pulp exposure compared to non-selective removal to hard dentine<sup>2,3</sup>. In these removal techniques, all peripheral carious dentine is removed leaving some carious tissue over the pulp wall before permanent restoration in case of selective removal at the same visit<sup>4</sup>, but re-entry is needed in stepwise removal to remove the remaining soft dentine before permanent restoration after temporarily sealing period. Higher success rate of the selective removal compared to stepwise removal reported, suggesting no need for re-entry<sup>3,5</sup>.

There is no existing data regarding how dental professionals manage deep carious lesions in Iraq, the aim of this study was to investigate the preference of strategies of carious tissue removal in management of deep carious lesions by the dental practitioners in Iraq and how the respondents' demographic variables (sex, years of experience, qualification, specialty, place of work) influences these decisions.

---

### Corresponding Author:

**Dr. Ahmed H. Ali**

Lecturer, Department of Aesthetic and Restorative Dentistry, College of Dentistry, University of Baghdad. Dental Educational Hospital, Baghdad, Iraq  
e-mail: ahmedhamidalisalman@gmail.com  
Mob.: 99647713115902



## Materials and Method

An online questionnaire was designed and piloted through staff members at College of Dentistry/University of Baghdad. A sample size calculation was carried out through population for descriptive sampling technique with an expected response rate between 60 and 80 and 80% power calculation. Hence, 350 dentists were needed to respond. Online questionnaire was constructed using Google form, A section of the questionnaire constructed as a cover letter explaining the purpose of the questionnaire and emphasis on anonymity. The questionnaire questions investigated:

1. Demographics of respondent which included: sex, years of experience, qualification (BDS, Diploma, MSc and PhD), specialty (Endodontists, general dental practitioner (GDP) and other specialty (referred to as "other")), place of work (private clinic or hospital).
2. Carious tissue removal technique (non-selective vs stepwise vs selective removal) in deep carious lesions in asymptomatic teeth.

The questionnaire was sent electronically via social media (Facebook) with respondents completing the form anonymously. The distribution was performed through mailing to members of certain Iraqi Dental Facebook groups which were assigned using a simple randomization-lottery method to minimize bias in selection. The issue with respondents making more than one entry was excluded by using an IP-protection protocol. The respondents were asked to choose one suitable answer for each question. Ethical approval was considered unnecessary as there was no patient information included, only dentists were asked about their preference. Responses in the Google form gathered as Excel sheet. The collected data was analyzed using the statistical package SPSS 26 (SPSS Inc., Chicago, IL, USA). Descriptive statistics given as frequencies (n) and percent (%). Chi Square test was used to investigate the influence of gender, qualification, specialty, place of work and years of experience on the choice of carious tissue removal strategy and treatment option after pulp exposure. The background characteristic variable was chosen as an independent variable for the binary multivariable logistic regression analysis. Through this, odds ratios (OR) and their confidence intervals (CI) were calculated

## Results

**Demographic Data:** 238 dentists responded in the study. Table 1 shows the demographic characteristics of the respondents in the study.

**Table 1: Demographic characteristics of the respondents in the study.**

Categories	n (%)
<b>Sex:</b>	
a. Females	100 (42%)
b. Males	138 (58%)
<b>Experience:</b>	
a. Less than 5 years	80 (33.6%)
b. 5-10 years	52 (21.8%)
c. 10-20 years	62 (26%)
d. More than 20 years	44 (18.4%)
<b>Qualifications:</b>	
a. BDS	136 (57%)
b. DIPLOMA	17 (7%)
c. MSc	52 (22%)
d. PhD	33 (14%)
<b>Specialty:</b>	
a. General practitioner	116 (48.7%)
b. Endodontists	58 (24.4%)
c. Other specialties	64 (26.9%)
<b>Place of work:</b>	
a. Private clinic	56 (23%)
b. Hospital	183 (27%)

n (%) = number (percentage) of respondents

### Strategy of carious tissue removal in management of deep carious lesion in asymptomatic teeth:

164 (69%), 56 (23.5%) and 18 (7.5%) of respondents choose to use non-selective, stepwise and selective carious tissue excavation in treatment deep carious lesions, respectively, with statistically significant difference between frequencies ( $p < 0.001$ ). Years of experience, age, qualification did not statistically significantly affect the decision of selection of the strategy used to remove carious tissue in deep carious lesions.

Specialty significantly affects the decision of carious tissue removal technique ( $p=0.05$ ). Percent of endodontists who perform non-selective removal (55.2%) significantly lower than those in GDP (72.4%) ( $p < 0.05$ ) and Other (75%) ( $p < 0.05$ ), respectively.

Significantly higher percent of Endodontists perform stepwise removal compared to GDP ( $p<0.05$ ) and Other ( $P<0.01$ ), respectively. No differences in percentages of respondents who perform selective removal in all categories ( $p>0.05$ ).

Sex significantly affect the decision of carious tissue removal technique ( $p=0.026$ ). Significantly more males (75.4%) use non-selective removal compared to females (60%) ( $p<0.05$ ). Significantly more females (32%) use stepwise removal compared to males (17.4%) ( $p<0.01$ ). There was no significant difference in percentages of respondents who perform selective removal in different sex ( $p>0.05$ ).

Place of work significantly affects the decision of carious tissue removal technique ( $p=0.018$ ). Percent of respondents work in private clinics who perform non-selective removal (53.6%) significantly lower than those who work in hospitals (73.6%) ( $p<0.01$ ). Percent of respondents work in private clinics who perform stepwise removal (35.7%) significantly higher than those who work in hospitals (19.7%) ( $p<0.05$ ). There was no significant difference in percentages of respondents who perform selective removal in private clinics (10.7%) and hospitals (6.5%) ( $P>0.05$ ), as shown in Table 2.

**Table 2: Distribution of frequencies and percentages of Strategy of Carious tissue removal among significant demographic categories.**

Respondents Categories	Strategy of Carious Tissue removal n (%)			
	Non-selective removal	Stepwise removal	Selective removal	Total
<b>Specialty n (%)</b>				
Endodontists	32(55.2%) <sup>a</sup>	22(37.9%) <sup>b</sup>	4(6.9%)	58(24.3%)
Others	48(75%) <sup>a</sup>	12(18.8%) <sup>b</sup>	4(6.3%)	64(26.8%)
GDP	84(72.4%) <sup>a</sup>	22(19%) <sup>b</sup>	10(8.6%)	116(48.7%)
<b>Total</b>	<b>164(69%)</b>	<b>56(23.5%)</b>	<b>18(7.5%)</b>	<b>238(100%)</b>
<b>Sex n (%)</b>				
Females	60(60%) <sup>c</sup>	32(32%) <sup>d</sup>	8(8%)	100(42%)
Males	104(75.4%) <sup>c</sup>	24(17.4%) <sup>d</sup>	10(7.2%)	138(58%)
<b>Total</b>	<b>164(69%)</b>	<b>56(23.5%)</b>	<b>18(7.5%)</b>	<b>238(100%)</b>
<b>Place of Work n (%)</b>				
Private clinics	30(53.6%) <sup>e</sup>	20(35.7%) <sup>f</sup>	6(10.7%)	56(23.5%)
Hospitals	134(73.2%) <sup>e</sup>	36(19.7%) <sup>f</sup>	12(6.5%)	182(76.5%)
<b>Total</b>	<b>164(69%)</b>	<b>56(23.5%)</b>	<b>18(7.5%)</b>	<b>238(100%)</b>

n= number of respondents, identical superscript small letters represent statistically significant difference among the relevant groups.

For the purpose of statistical analysis via binary multivariable logistic regression, CR categories classified into invasive (non-selective removal) and less invasive (include stepwise and selective caries removal). Results of regression analysis show that being an endodontist or female or work in a private clinic significantly associated with choosing a less invasive carious tissue removal strategy (stepwise or selective removal) in management of deep carious lesions (OR=2.023, CI 1.02-4.0), (OR=2.044, CI 1.12-3.7) and (OR=2.101, CI 1.0-4.0), respectively.

## Discussion

With development of minimal invasive approaches in the management of deep carious lesions, it is important to investigate existing dentists' attitude and preferences toward these approaches and to assess the effect of different demographic factors influencing these choices. Therefore, this study is the first to compare and analyses management of deep carious lesions in Iraq. In this study, social media platforms were used to distribute the questionnaire into targeted groups representing the dentist population in Iraq. Rapid and effective sharing of information allowed by social media widely used by the population<sup>6</sup>. Daily, there are 1.52 billion active users of Facebook alone and 2.7 billion subscribers use social

media<sup>7</sup>. This media has been suggested as an alternative way for communications in a survey study involving medical professionals to assess social media use with a response rate of 64%<sup>7</sup>. This study showed a response rate of 68% which is satisfactory and representing the targeted population.

Majority of dentists who surveyed in this study (69%) preferred a non-selective carious tissue removal strategy in management of asymptomatic deep carious lesions and refused to leave caries under restoration. This decision is related to the idea that residual caries might progress and harm the pulp. According to the results, less invasive excavation method (stepwise and selective excavation) were chosen by 31% of the respondents, this result is in agreement with studies in United States and Brazil, reporting that only 21%<sup>8</sup> and 26%<sup>9</sup> of dentists considered incomplete excavation of pulp-proximal caries. Other studies carried out in USA, France, Germany and Brazil showed that majority of dentists (60-70%) preferred non-selective carious tissue removal to the hard dentine in management of deep carious lesions even with high risk of pulp exposure during the excavation procedure<sup>8-10</sup>, similar to the results of this study.

Reduced risk of pulp exposure and pulpal complications associated with incomplete excavation (selective removal) versus complete excavation (non-selective removal to hard dentine) has been confirmed recently by reviews and meta-analysis<sup>10,11</sup>. Although the idea of leaving residual caries in proximity to the pulp bears the fear of restoration failure, failure risk did not seem to be increased significantly (OR = 0.97, 95% CI = 0.64–1.46). Therefore, current scientific evidence supports selective removal of caries if the residual carious lesion is sealed successfully with no indication for a considerable risk of progress<sup>12,13</sup>. Also, recent randomized clinical trial supports the advantage of selective removal of carious tissue in deep carious lesion with symptoms of reversible pulpitis using a self-limiting excavation protocol (Carisolv gel and operating microscope) which maintain 90% pulp survival rate after one year of follow-up utilizing CBCT for radiographic evaluation of periapical health<sup>4</sup>. However long-term follow-up of teeth excavated selectively is limited.

One of the factors that affected preference of carious tissue removal strategy was specialty of the respondent, half of Endodontists prefer less invasive CR compared to GDP and other specialties significantly (Table 2),

being an Endodontist increased the probability of choosing less invasive method by 2 times compared to GDPs (OR=2.023, CI (95%)1.02-4.0). This could be explained by the fact that endodontists may become more conscious about the recent clinical guidelines that outline the benefits of less invasive carious tissue removal strategies<sup>11,14-16</sup>.

Also, results of this study show that females prefer a less invasive approach in caries excavation of deep carious lesions (Table 2). The preference of a less invasive carious tissue removal strategy was significantly associated with the gender "female" (OR=2.044, CI (95%) 1.12-3.7). This agrees with another multi-national survey study which found that stepwise removal was performed less often by male dentists<sup>10</sup>. However other studies could not find such association between gender and CR strategy preference<sup>17,18</sup>.

Result of this study found that place of work significantly affects the decision of carious tissue removal technique. work in private clinics strongly associated with choosing less invasive Cr compared to working in hospitals Table 2. This disagrees with results from other studies which found a strong correlation between employment in the public sector and choosing a less invasive strategy<sup>10,18</sup>. This probably can be explained by lack of local clinical guidelines that promote less invasive carious tissue removal strategies in the public sector compared to the private sector in Iraq which have more diversity and flexibility in terms of time and financial consideration. Also, it seems that treatment decision guided by previous experience and familiarities, for example, dental Under and postgraduate education significantly affect the dentist decision regarding the strategy of carious tissue removal adopted, most Iraqi dental schools teaches the contemporary invasive approach of non-selective carious tissue removal to hard dentine.

In conclusion, majority of the surveyed dentists preferred invasive carious tissue removal strategies in excavation of asymptomatic deep carious lesions. Therefore, benefits of selective excavation should be highlighted in under- and postgraduate education to promote minimally invasive techniques. Less invasive strategies in management of deep carious lesions and vital pulp therapies are not common in clinical practice in Iraq and there is urgent need to educate GDPs the current scientific evidence on less invasive strategies.

**Conflict of Interest:** Nil

**Source of Funding:** Self-funded

**Ethical Clearance:** Not Required

### References

- Innes N, Frencken JE, Bjørndal L, Maltz M, Manton DJ, Ricketts D, et al. Managing carious lesions: consensus recommendations on terminology. *Advances in dental research*. 2016;28(2):49-57.
- Bjørndal L, Reit C, Bruun G, Markvart M, Kjældgaard M, Näsman P, et al. Treatment of deep caries lesions in adults: randomized clinical trials comparing stepwise vs. direct complete excavation, and direct pulp capping vs. partial pulpotomy. *European journal of oral sciences*. 2010;118(3):290-7.
- Maltz M, Garcia R, Jardim JJ, de Paula LM, Yamaguti PM, Moura MS, et al. Randomized trial of partial vs. stepwise caries removal: 3-year follow-up. *J Dent Res*. 2012;91(11):1026-31.
- Ali A, Koller G, Foschi F, Andiappan M, Bruce K, Banerjee A, et al. Self-limiting versus conventional caries removal: a randomized clinical trial. *Journal of dental research*. 2018;97(11):1207-13.
- Carvalho JC, Dige I, Machiulskiene V, Qvist V, Bakhshandeh A, Fatturi-Parolo C, et al. Occlusal caries: biological approach for its diagnosis and management. *Caries Research*. 2016;50(6):527-42.
- Boyd DM, Ellison NB. Social network sites: Definition, history, and scholarship. *Journal of computer-mediated communication*. 2007; 13(1):210-30.
- Petosic A, Sunde K, Beeckman D, Flaatten HK, Wøien H. Use of social media for communicating about critical care topics: A Norwegian cross-sectional survey. *Acta Anaesthesiologica Scandinavica*. 2019;63(10):1398-405.
- Oen KT, Thompson VP, Vena D, Caufield PW, Curro F, Dasanayake A, et al. Attitudes and expectations of treating deep caries: a PEARL Network survey. *General dentistry*. 2007;55(3):197-203.
- Weber CM, Alves LS, Maltz M. Treatment decisions for deep carious lesions in the Public Health Service in Southern Brazil. *Journal of public health dentistry*. 2011;71(4):265-70.
- Schwendicke F, Stangvaltaite L, Holmgren C, Maltz M, Finet M, Elhennawy K, et al. Dentists' attitudes and behaviour regarding deep carious lesion management: a multi-national survey. *Clinical oral investigations*. 2017;21(1):191-8.
- Ricketts D, Lamont T, Innes NP, Kidd E, Clarkson JE. Operative caries management in adults and children. *Cochrane database of systematic reviews*. 2013(3).
- Bjørndal L, Larsen T, Thylstrup A. A clinical and microbiological study of deep carious lesions during stepwise excavation using long treatment intervals. *Caries Research*. 1997;31(6):411-7.
- Maltz M, de Oliveira EF, Fontanella V, Bianchi R. A clinical, microbiologic, and radiographic study of deep caries lesions after incomplete caries removal. *Quintessence international*. 2002;33(2).
- Schwendicke F, Dörfer C, Paris S. Incomplete caries removal: a systematic review and meta-analysis. *Journal of dental research*. 2013;92(4):306-14.
- Endodontology: ESo, Duncan H, Galler K, Tomson P, Simon S, El-Karim I, et al. European Society of Endodontology position statement: Management of deep caries and the exposed pulp. *International endodontic journal*. 2019;52(7):923-34.
- Bjørndal L, Simon S, Tomson P, Duncan H. Management of deep caries and the exposed pulp. *International endodontic journal*. 2019;52(7):949-73.
- Stangvaltaite L, Kundzina R, Eriksen HM, Kerosuo E. Treatment preferences of deep carious lesions in mature teeth: questionnaire study among dentists in Northern Norway. *Acta Odontologica Scandinavica*. 2013;71(6):1532-7.
- Croft K, Kervanto-Seppälä S, Stangvaltaite L, Kerosuo E. Management of deep carious lesions and pulps exposed during carious tissue removal in adults: a questionnaire study among dentists in Finland. *Clinical oral investigations*. 2019;23(3):1271-80.

# Antibiofilm Activity of Nystatin, Aspirin and EDTA Against *Candida albicans* Isolated from Iraqi Women with Vulvovaginitis

Noor Naser Raheem<sup>1</sup>, Kais Kassim Ghaima<sup>2\*</sup>

<sup>1</sup>Research Scholar, M Sc Student, Kamal Al-Samarrai Hospital, Ministry of Health, Baghdad, Iraq,

<sup>2</sup>Assistant Professor, Institute of Genetic Engineering and Biotechnology for Postgraduate Studies, University of Baghdad, Baghdad, Iraq

## Abstract

The vulvovaginitis candidiasis is often associated with biofilm formation by *Candida albicans* and using of antifungal agents against *C. albicans* biofilms is urgently needed. Microtiter plate assay using crystal violet was used for detection the ability of *Candida albicans* to form biofilm and the microtiter broth dilution method was used for determination the minimum inhibitory concentrations (MICs). Out of 42 *Candida albicans* isolated from vulvovaginitis, 37 (88%) can produce biofilm at the varying degrees. Twenty-eight (75.7%) isolates could form a strong biofilm. The results of minimum inhibitory concentrations (MICs) of Nystatin, Aspirin and EDTA (Ethylenediaminetetraacetic acid) against 28 *C. albicans* isolates which formed the strong biofilm, revealed that range of concentrations of Nystatin were (6.25-100 µg/ml), while the MICs of aspirin and EDTA were more than 1000 µg/ml. It was obvious that the Nystatin had the inhibitory activity at the concentrations 6.25 and 12.5 µg/ml. The highest antibiofilm activity by Nystatin were demonstrated at the subinhibitory concentration 50 µg/ml with biofilm eradication percent (75.80%), while the lowest antifungal effect (2.86-10.70%) was at very low concentrations (3.125-6.25 µg/ml). Also, there was an obvious biofilm eradication of Aspirin and EDTA at the concentrations 500 and 1000 µg/ml but the effect of aspirin at the concentration 1000 µg/ml (70.51%) is more than EDTA (60.12%) in contrast with the concentration 500 µg/ml, it was found that the effect of EDTA (51.29%) is more than aspirin (34.25%). In conclusion, the present study highlights the role of Aspirin and EDTA as antibiofilm agents when used with Nystatin which have the ability to inhibit the growth of *C. albicans* in patients with vulvovaginitis.

**Keywords:** Nystatin, Aspirin, EDTA, *C. albicans*, Biofilm, Vulvovaginitis.

## Introduction

Vulvovaginal candidiasis (VVC) is considered as the main infection caused by *Candida albicans*. Numerous virulence determinants and escalating resistance to antifungal therapy have contributed to its pathogenicity<sup>(1)</sup>. Some virulence factors such as

dimorphism and the ability to adhere and form biofilm on medical device and/or the host mucosal epithelium, enhance the pathogenicity of *C. albicans*<sup>(2)</sup>. Vulvovaginal candidiasis defined as a disorder characterized by signs and symptoms of vaginal inflammation when the *Candida* species are found and is an ever living problem affecting 70–75% of women of reproductive age at least once during their life<sup>(3)</sup>. The evolution of drug resistance of *Candida* species to conventional antifungal agents has been a major medical challenge worldwide; attempt to use the potential antifungal agents with appropriate therapy efficacy and minimum effects is considerably growing<sup>(4)</sup>. The mechanism underlying development of antifungal resistance of *C. albicans* are complex and involve multiple pathways and genes. Further,

---

### Corresponding Author:

**Kais Kassim Ghaima**

Assistant Professor, Institute of Genetic Engineering and Biotechnology for Postgraduate Studies, University of Baghdad, Baghdad, Iraq  
e-mail: kaiskassim@gmail.com

these mechanisms continue to change and evolve and challenging the medical clinic<sup>(5)</sup>. The widespread use of antibiotics, frequent use of indwelling medical devices, and a trend towards increased patient immunosuppression has resulted in a creation of opportunity for clinically important *Candida* to form biofilms and there is growing evidence of the importance of *Candida* biofilms in clinical problems<sup>(6)</sup>. Therefore the aim of this study is investigate the biofilm formation of *C. albicans* isolates as the causative agent of vulvovaginitis in Iraqi women, also using of some compounds such as Aspirin and EDTA as antifungal agents against the high antifungal resistant isolates.

## Materials and Method

***Candida albicans* isolates:** In this study, a total of 42 *C. albicans* clinical strains were collected from women patients with vulvovaginitis from three hospitals in Baghdad, Iraq, during the period from September to December 2019. All strains were previously identified by API Candida system (bioMérieux, France) and confirmed using VITEK 2 compact system (bioMérieux, France).

**Quantitative biofilm production assay:** The Colonies from all isolates of fresh *C. albicans* cultures (48 hours) were grown at 37°C in Sabouraud dextrose broth medium for 24 hours. Biofilm formation was tested by adding 100 µl of this standardized cell suspension to wells of microtiter plates that contained 100 µl of fresh Sabouraud dextrose broth media and incubating them at 37°C for 48 hours. Thereafter, the medium was removed and planktonic cells were removed by washing the biofilms in phosphate buffered saline. After staining plates with 2% crystal violet for 20 m, excess stain was removed using water. The plates were air dried and then the dye was resolubilized with absolute ethanol. The optical density (OD) of each well was measured at 570 nm using Enzyme-Linked Immunosorbent Assay (ELISA) reader (BioTek, Korea). Optical density cut-off value (OD<sub>c</sub>) was calculated using the equation: average OD of negative control + (3\*SD of negative control)<sup>(7)</sup>.

**Minimum inhibitory concentration of Nystatin, Aspirin and EDTA:** Nearly, 100 µl (0.5 McFarland) of the *C. albicans* culture was inoculated into each well of a 96-well microtiter plate containing 100 µl Nystatin, Aspirin and EDTA at different concentrations (0.39–200

µg/ml). Wells without Nystatin, Aspirin and EDTA were used as a positive control while those without *Candida* were considered as negative controls. After 24 hours incubation at 37°C, the wells were visually inspected for the growth. The MIC was considered as the lowest concentration of Nystatin, Aspirin and EDTA that inhibits the Yeast growth<sup>(8)</sup>.

**Antibiofilm activity of Nystatin, Aspirin and EDTA:** This test was performed on four strains that showed strong biofilm formation ability in the biofilm production assay. The effect of different concentrations of Nystatin (3.125-100 µg/ml), while Aspirin and EDTA (31.25-1000 µg/ml) to inhibit the ability of *C. albicans* cells to form a biofilm was assessed using the TCP method adopted by Khodavandi *et al.* (2011)<sup>(9)</sup>. Nearly, 100 µl of 0.5 McFarland yeast cultures was dispensed into each well of 96-well polystyrene microtiter plates in the presence of 100 µl of the antibiofilm agent at different concentrations, and plates were incubated at 37°C for 48 hours. Antimicrobial agent free wells served as positive controls for the biofilm growth. After incubation, the medium and non-adherent cells were removed and wells were washed three times with sterile PBS. The plates were air dried and then the dye was resolubilized with absolute ethanol. The OD of each well was measured at 570 nm using ELISA reader (BioTek, Korea). Each assay was performed in triplicates.

**Statistical Analysis:** The Statistical Analysis System- SAS (2012)<sup>(10)</sup> program was used to detect the effect of difference factors in study percentage. Chi-square test was used to significant compare between percentage (0.05 and 0.01 probability). Least significant difference LSD test (Analysis of Variation-ANOVA) was used to significant compare between means in this study.

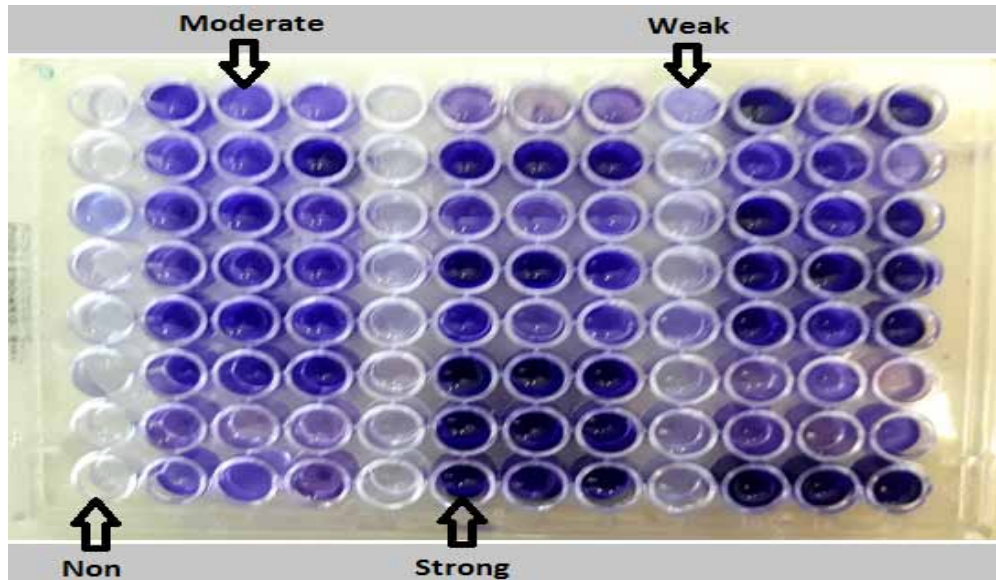
## Results and Discussion

**Biofilm formation:** Out of 42 *Candida albicans* isolates, 37 (88%) can produce biofilm at the varying degrees. Twenty-eight (75.7%) isolates could form a strong biofilm, while 6 isolates were the moderate producer, and only 3 isolates were weak biofilm formers. Also it was found that five isolates don't have the ability to formation the biofilm (table 1). Microtiter plate assay using crystal violet was used for detection the ability of *Candida albicans* to form biofilm (figure 1).

**Table 1. Distribution of biofilm formation ability among *Candida albicans* isolates.**

Candida albicans	Biofilm formation			
	Weak	Moderate	Strong	Negative
Total no of Isolate = 42	3	6	28	5
%	7.14%	14.29%	66.67%	11.90%
Chi-Square ( $\chi^2$ )	12.073 **			

\*\* (P≤0.01).



**Figure 1. Biofilm formation detection of *Candida albicans* isolates by microtiter plate assay.**

This study revealed that the most of *Candida albicans* isolated from Iraqi women patients with vulvovaginitis formed a strong biofilm. Many studies demonstrated the ability of *Candida albicans* clinical isolates to form heterogeneous biofilms. The presence of these communities in vulvovaginitis may explain why *C. albicans* infections remain unresponsive to therapy, and there was a relationship between biofilm formation and antifungal resistance among *Candida* isolates<sup>(11, 12)</sup>. The study of Shreif *et al.* (2019)<sup>(13)</sup> in Egypt which included one hundred *Candida albicans* isolates from patients with nosocomial infections revealed that the biofilm capacity was identified by the microplate method in 58% of *C. albicans* and the optical density was intense in 20 isolates, moderate in 21 isolates and mild in 17 isolates. The local study of Mohammed *et al.* (2017)<sup>(14)</sup> demonstrated that *C. albicans* was the most predominant species among vaginal specimens in percentage (45%) and all *C. albicans* isolates were biofilm producers with variable strength, Among vaginal isolates; 10/22 (45.5%) were weak biofilm formers whereas moderate or strong

biofilm formers were 12/22 (54.5%). In a previous study, it was found the *Candida* biofilms have important clinical implications since the biofilm associated with *Candida* or *Gardnerella* genital infections may act as a chlamydial reservoir contributing to the transmission of *Chlamydia trachomatis* in the population, alongside its dissemination in the female upper genital tract<sup>(15)</sup>. The biofilm formation is very important virulence factor in *C. albicans*, where this species expresses hyphal-specific adhesins and regulators required for adhesion. Also, the morphological dimorphism in *Candida albicans* supports noticeable phagocyte escape mechanism<sup>(16)</sup>.

The present study investigated the role of some compounds as antibiofilm agents against the biofilm formation in *C. albicans* isolates, these compounds are Nystatin, Aspirin and EDTA. At first, the minimum inhibitory concentrations (MICs) of these compounds were measured by microdilution method in 96 well microtiter plates with resazurin dye and then detection the antibiofilm concentration by exposing the yeast

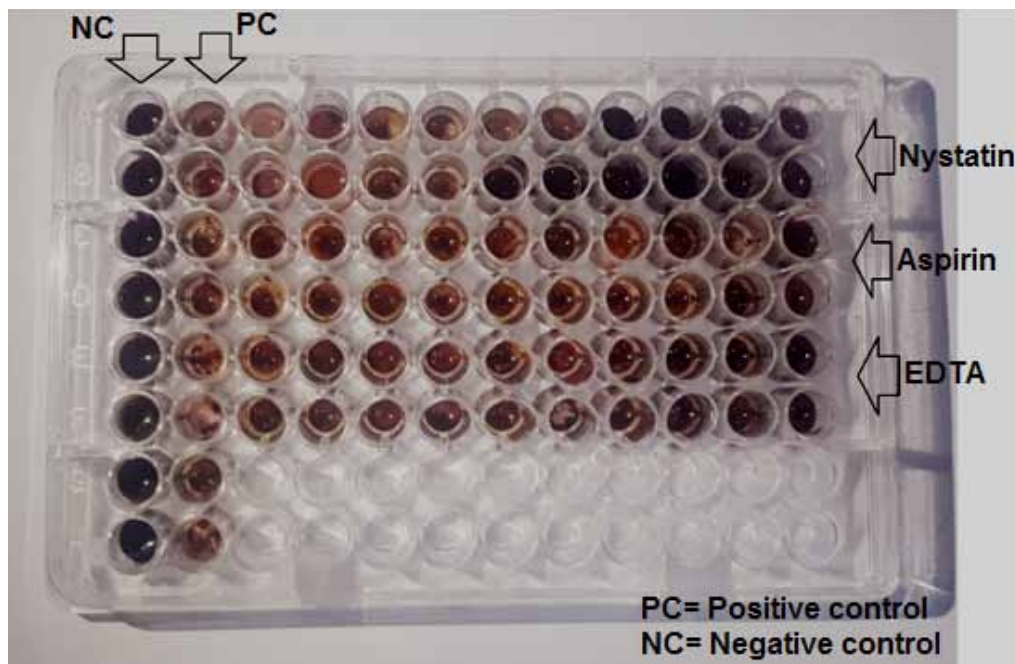
to subinhibitory concentration in the same plate with crystal violet staining.

The results of minimum inhibitory concentrations (MICs) of Nystatin, Aspirin and EDTA against 28 *C. albicans* isolates which formed the strong biofilm, revealed that range of concentrations of Nystatin were (6.25-100 µg/ml), while the MICs of aspirin and EDTA

were more than 1000 µg/ml. The table 2 and figure 2 demonstrated the MICs of 2 isolates by using the double concentrations (from 0.39 to 200 µg/ml) and it was obvious that there is no effect of Aspirin and EDTA on the growth of *C. albicans* at the used range while the Nystatin had the inhibitory activity at the concentrations 6.25 and 12.5 µg/ml against the isolates 1 and 2 respectively.

**Table 2. The minimum Inhibitory Concentrations (MICs) of antibiofilm agents against *Candida albicans* isolates.**

Antibiofilm agent	<i>Candida albicans</i>	Minimum Inhibitory Concentration (MIC) (µg/ml)									
		0.39	0.78	1.56	3.12	6.25	12.5	25	50	100	200
Nystatin	Isolate 1						+				
	Isolate 2					+					
Asprin	Isolate 1	-	-	-	-	-	-	-	-	-	-
	Isolate 2	-	-	-	-	-	-	-	-	-	-
EDTA	Isolate 1	-	-	-	-	-	-	-	-	-	-
	Isolate 2	-	-	-	-	-	-	-	-	-	-



**Figure 2. The minimum Inhibitory Concentrations (MICs) of antibiofilm agents against *Candida albicans* isolates by microtiter plate assay with resazurin dye.**

The previous study included 14 yeast strains 7 control strains were investigated regarding their *in vitro* susceptibility to the polyene antifungal agent nystatin, the Minimum inhibitory concentrations (MICs) for nystatin were measured by both visual examination,

and spectrophotometric measuring after 24 and 48 hours incubation time at 36°C. The visual read-out of growth inhibition revealed MICs for nystatin in a range from 0.625 to 1.25 µg/ml for all *Candida* species tested, where the *Candida albicans* strains, and both

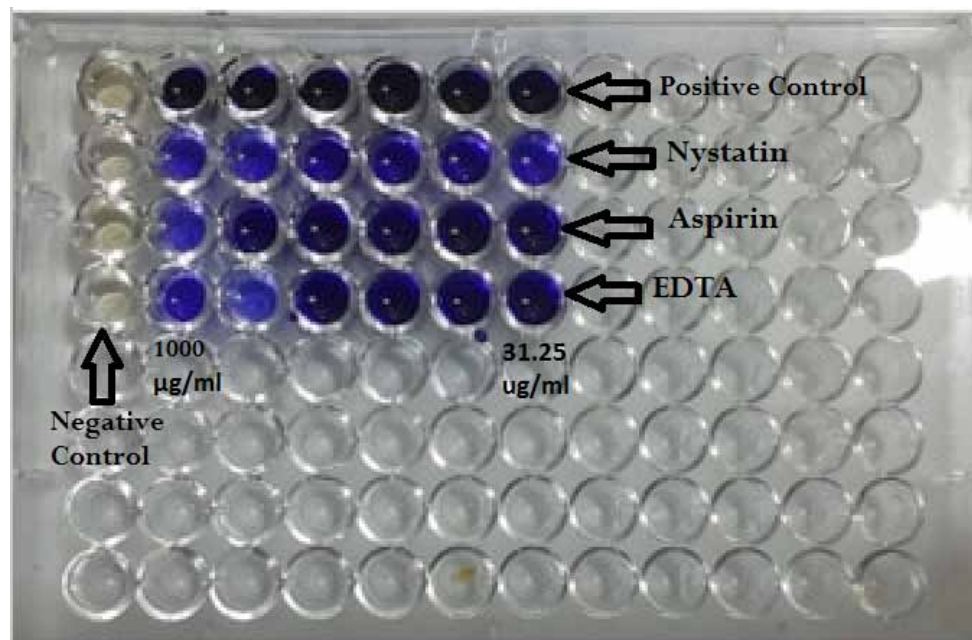


strains of *C. glabrata* and *C. tropicalis*, showed low MIC values 0.625 µg/ml<sup>(17)</sup>. Many previous studies found that nystatin MICs for *C. albicans* isolated from vulvovaginitis ranged from 1 to 16 µg/ml, with a MIC inhibiting 90% of isolates (MIC<sub>90</sub>) of 4 to 16 µg/ml<sup>(18,19)</sup>.

The current study consistent with Al-Bakri *et al.* (2009)<sup>(20)</sup> study which indicated to need of high concentrations of Aspirin and EDTA to achieve MIC against *C. albicans*, where Aspirin MIC values (mg/ml) of 2.03, 1.2 and 2.65 were achieved against *P. aeruginosa*, *E. coli* and *C. albicans*, respectively. An EDTA concentration as high as 60 mg/ml failed to attain the MBC value, while aspirin MBC values (mg/ml) of 4.8, 4.9 and 5.28 were reported against *P. aeruginosa*, *E. coli* and *C. albicans*, respectively. Also, the results of Cederlund and Mardh (1993)<sup>(21)</sup> demonstrated that Aspirin possesses a relatively weak broad-spectrum antimicrobial activity where relatively high concentrations of aspirin are needed to effect biostatic activities and even higher concentrations are needed for biocidal activities. Antipyretics such as Aspirin primarily act by inhibiting prostaglandin synthesis. Fungi produce prostaglandins, and although their exact function is uncertain, it is thought that they influence virulence, in particular controlling the yeast-to-hypha transition and biofilm production. Also, changing the surface hydrophobicity of microbes and modifying the susceptibility of microbes to antimicrobial therapy<sup>(22,23)</sup>.

It is also known that anticoagulant and calcium and magnesium chelator EDTA (Ethylenediaminetetraacetic Acid) may have antimicrobial activity against several Gram-positive bacteria and *Candida* spp. EDTA forms chelation with divalent metals such as Mg(2+) and Ca(2+), which are required by various essential enzymes<sup>(24,25)</sup>. EDTA demonstrated the highest antifungal activity in comparison with routine antifungal drugs by prevent the binding of *C. albicans* to the proteins in a dose-dependent manner and reduces the growth of *C. albicans* by removing calcium from the cell walls and causing collapses in the cell wall, and by inhibiting enzyme reaction<sup>(26)</sup>. EDTA acts on the cell surface, resulting in the rapid release of approximately half of the lipopolysaccharide with a negligible loss of other cell components. The disruption of the lipopolysaccharide structure in the outer membrane of Gram-negative bacteria occurs because EDTA chelates divalent cations. The release of lipopolysaccharides increases the membrane permeability to other agents, hence the potentiating action<sup>(27)</sup>.

The effect of some antifungal and antibiofilm agents (Nystatin, Aspirin and EDTA) on the biofilm formation of *C. albicans* isolates were achieved using microtiter plate assay with crystal violet staining (figure 3).



**Figure 3. Biofilm quantification by microtiter plate assay of *Candida albicans* (isolate 5) at different subinhibitory concentrations of Nystatin, Aspirin and EDTA.**

The results of effect Nystatin, Aspirin, and EDTA at subinhibitory concentrations against the biofilm formation of 28 *C. albicans* isolates which formed the strong biofilm, revealed that the Inhibition activity

of biofilm formation by nystatin was stronger relative to Aspirin and EDTA, and this antifungal agent had antibiofilm effect even though at very low concentrations (table 3).

**Table 3. The percentages of biofilm reduction by Aspirin, EDTA and Nystatin against *Candida albicans* at different subinhibitory concentrations.**

Antibiofilm agent (µg/ml)	Biofilm reduction (%)						Chi-Square (χ <sup>2</sup> )
	1000	500	250	125	62.5	31.25	
Aspirin	61.90–70.51%	29.75–34.25%	8.95–10.71%	1.54–5.18%	12.01–14.33%	2.35–8.58%	12.63**
EDTA	54.43–60.12%	48.27–51.29%	1.83–3.27%	0.74–2.08%	4.00–5.89%	26.19–28.65%	11.08**
	Biofilm reduction (%)						---
Antibiofilm agent (µg/ml)	100	50	25	12.5	6.25	3.125	---
Nystatin	76.66–83.30%	69.51–75.80%	44.86–57.15%	29.49–34.35%	9.12–10.70%	2.86–4.22%	13.46**

\*\* (P≤0.01).

**EDTA (Ethylenediaminetetraacetic Acid):** The effect of three antibiofilm agents (Nystatin, Aspirin and EDTA) on the nystatin resistant *C. albicans* isolate 5 (MIC=100 µg/ml) was summarized at the figure 3 and table 4.

**Table 4. The absorbance of biofilm formation of *Candida albicans* (isolate 5) at different subinhibitory concentrations of Aspirin and EDTA.**

Antibiofilm agent (µg/ml)	O.D. (630nm)						LSD value
	1000	500	250	125	62.5	31.25	
Aspirin	0.581 b	1.138 a	1.211 a	1.589 a	1.384 a	1.050 a	0.456 *
EDTA	0.695 d	0.808 cd	1.505 ab	1.601 a	1.509 ab	1.195 bc	0.398 *
	O.D. (630nm)						---
Antibiofilm agent (µg/ml)	100	50	25	12.5	6.25	3.125	---
Nystatin	0.262 d	0.411 cd	0.724 bc	1.030 b	1.401 a	1.580 a	0.377 *

Means having with the different letters in same row differed significantly.

\* (P≤0.05).

O.D. of positive control = 0.063

O.D. of negative control = 1.569

**EDTA (Ethylenediaminetetraacetic Acid):** The highest antibiofilm activity by Nystatin were demonstrated at the subinhibitory concentration 50 µg/ml with biofilm eradication percent (75.80%), while the lowest antifungal effect (2.86-10.70%) was at very low concentrations (3.125-6.25 µg/ml). Also, there was an obvious biofilm eradication of Aspirin and EDTA at the concentrations 500 and 1000 µg/ml but the effect of aspirin at the concentration 1000 µg/ml (70.51%) is more than EDTA (60.12%) in contrast with the concentration 500 µg/ml, it was found that the effect of EDTA (51.29%) is more than aspirin (34.25%). The effect of other concentrations (31.25-250 µg/ml) on the

biofilm formation was not significant in comparison with the higher concentrations. The results revealed that nystatin at low concentration showed a significant effect as antifungal and antibiofilm agent in comparison with the high concentrations of aspirin and EDTA.

Concerning inhibition of biofilm production in the presence of subinhibitory concentrations of the Nystatin, the present study reflected more promising significant effects for treatment with this antifungal agent (75.80% reduction) which are more than studies reported by other investigators, as in El-Houssaini *et al.* (2019)<sup>(28)</sup> (30.86% reduction), and the study of Redding *et al.* (2009)<sup>(29)</sup> (70%

reduction). Many studies showed that the treatment of clinical *C. albicans* isolates with subinhibitory nystatin concentrations significantly decreased production of extracellular hydrolases. Also, the greatest inhibitory effect on phospholipase and aspartyl protease production and a noticeable significant impact on inhibiting biofilm formation of *C. albicans* clinical isolates<sup>(28)</sup>. De Prijck and coworkers investigated the effect of nystatin released from modified polydimethyl siloxane disk as a model for incorporating antifungals in medical devices against biofilm formation by *Candida* spp. Nystatin exhibited a concentration-dependent inhibitory effect on *Candida* biofilm formation in a microtiter plate<sup>(30)</sup>.

It was demonstrated that EDTA alone (at 25 and 2.5 mM) significantly reduced fungal metabolic activity in preformed biofilms. Also, EDTA combined with fluconazole significantly reduced the growth of biofilm when compared to biofilm treated with fluconazole alone<sup>(31)</sup>. EDTA resulted in partial reduction of catheter colonization by *C. albicans*. As previously reported, the combination of EDTA with low minocycline concentration (0.1 mg/ml) resulted in a significant decrease in catheter colonization but combined with higher concentrations of minocycline resulted in complete eradication of *C. albicans* biofilms<sup>(32)</sup>.

According to the results of effect of aspirin on the biofilm formation in *C. albicans*, it was found that cyclooxygenase-dependent synthesis of fungal prostaglandins is important for both biofilm development and morphogenesis in *C. albicans* and may act as a regulator in these physiological processes and that aspirin possesses potent antibiofilm activity in vitro and could be useful in combined therapy with conventional antifungal agents in the management of some biofilm-associated *Candida* infections<sup>(33)</sup>. Studies have shown that cyclooxygenase (COX) inhibitors, such as aspirin, ibuprofen, and indomethacin, combined with fluconazole can significantly reduce *Candida* adhesion and biofilm development and increase fluconazole susceptibility; the MIC of fluconazole can be decrease from 64 to 2 µg/ml when used in combination with ibuprofen. In addition, *in vivo* studies have also confirmed the antifungal activities of these inhibitors<sup>(34)</sup>. Aspirin alone or in combination with conventional antifungal drugs is also beneficial for the treatment of vulvovaginal candidiasis by inhibition of cyclooxygenases in host cells and by inhibition of 3-hydroxyoxylipins in *C. albicans*<sup>(35)</sup>.

## Conclusion

The present findings indicated to the role of some drugs or compounds such as Aspirin and EDTA when used with effective antifungal agents in control the infections of *Candida albicans* especially in the women with vulvovaginitis by inhibition the biofilm formation which considered as the main virulence factor in *Candida* species.

**Source of Funding:** Authors

**Ethical Clearance:** Yes

**Conflict of Interest:** Nil

## References

1. El-Houssaini HH, Elnabawy OM, Nasser HA, Elkhatib WF. Influence of subinhibitory antifungal concentrations on extracellular hydrolases and biofilm production by *Candida albicans* recovered from Egyptian patients. *BMC Infect Dis.* 2019; 19(1):54.
2. Ganguly S, Mitchell AP. Mucosal biofilms of *Candida albicans*. *Current Opinion In Microbiology.* 2011; 14(4), 380-385.
3. Theodoropoulos DS, Stockdale CK, Duquette DR, Morris MS. Inhalant allergy compounding the chronic vaginitis syndrome: characterization of sensitization patterns, comorbidities and responses to sublingual immunotherapy. *Archives of Gynecology and Obstetrics.* 2016; 294(3), 541-548.
4. Nikoomanesh F, Roudbarmohammadi S, Khoobi M, Haghighi F, Roudbary M. Design and synthesis of mucoadhesive nanogel containing farnesol: investigation of the effect on HWP1, SAP6 and Rim101 genes expression of *Candida albicans* in vitro. *Artificial Cells, Nanomedicine, and Biotechnology.* 2019; 47(1), 64-72.
5. De Oliveira Santos GC, Vasconcelos CC, Lopes AJ, de Sousa Cartágenes MDS, Allan Filho KDB, Do Nascimento FR, De Andrade Monteiro C. *Candida* infections and therapeutic strategies: mechanisms of action for traditional and alternative agents. *Frontiers In Microbiology.* 2018; 9: 1351.
6. Pathirana RU, McCall AD, Norris HL, Edgerton M. Filamentous non-albicans *Candida* species adhere to *Candida albicans* and benefit from dual biofilm growth. *Frontiers in microbiology.* 2019; 10: 1188.
7. Aboualigalehdari E, Sadeghifard N, Taherikalani

- M. Anti-biofilm Properties of *Peganum harmala* against *Candida albicans*. *Osong Public Health Res Perspect.* 2016; 7(2):116-118.
8. CLSI, Clinical and Laboratory Standards Institute. Performance Standards for Antimicrobial Susceptibility Testing; Twentieth Informational Supplement. CLSI document M100–S20. Wayne, PA, 2010.
  9. Khodavandi A, Harmal NS, Alizadeh F. Comparison between allicin and fluconazole in *Candida albicans* biofilm inhibition and in suppression of HWP1 gene expression. *Phytomedicine.* 2011; 19:56-63.
  10. SAS, Statistical Analysis System, User's Guide. Statistical Version 9.1<sup>th</sup> ed. SAS. Inst. Inc. Cary. N.C. USA, 2012.
  11. Gao M, Wang H, Zhu L. Quercetin assists fluconazole to inhibit biofilm formations of fluconazole-resistant *Candida albicans* in in vitro and in vivo antifungal managements of vulvovaginal candidiasis. *Cell Physiol Biochem.* 2016; 40:727–742.
  12. Sherry L, Kean R, McKloud E, O'Donnell LE, Metcalfe R, Jones BL, Ramage G. Biofilms formed by isolates from recurrent vulvovaginal candidiasis patients are heterogeneous and insensitive to fluconazole. *Antimicrob Agents Chemother.* 2017; 61:e01065-17.
  13. Shrief R, Zaki EM, El-Sehsah EM, Ghaleb S, Mofreh M. Study of Antifungal Susceptibility, Virulence Genes and Biofilm Formation in *Candida albicans*. *The Open Microbiology Journal.* 2019; 13, 241-248.
  14. Mohammed NA, Ajah HA, Abdulbaqi NJ. Detection the prevalence of adhesins and extracellular hydrolytic enzymes genes in *Candida albicans* biofilm formation Iraqi Journal of Science. 2017; 58: 988-1000.
  15. Filardo S, Di Pietro M, Tranquilli G, Sessa, R. Biofilm in Genital Ecosystem: A Potential Risk Factor for Chlamydia trachomatis Infection. *Can J Infect Dis Med Microbiol.* 2019; 2019: 1672109.
  16. Galocha M, Pais P, Cavalheiro M, Pereira D, Viana R, Teixeira MC. Divergent Approaches to Virulence in *C. albicans* and *C. glabrata*: Two Sides of the Same Coin. *Int J Mol Sci.* 2019; 20(9):2345.
  17. Nenoff P, Krüger C, Neumeister C, Schwantes U, Koch D. In vitro susceptibility testing of yeasts to nystatin - low minimum inhibitory concentrations suggest no indication of in vitro resistance of *Candida albicans*, *Candida species* or non-*Candida* yeast species to nystatin. *Clin Med Investig.* 2016; 1: 71–76.
  18. El-Din SS, Reynolds, MT, Ashbee, HR, Barton, RC, Evans. EGV. An investigation into the pathogenesis of vulvovaginal candidosis. *Sex. Transm. Infect.* 2001; 77:179-183.
  19. Richter SS, Galask RP, Messer SA, Hollis RJ, Diekema DJ, Pfaller MA. Antifungal susceptibilities of *Candida* species causing vulvovaginitis and epidemiology of recurrent cases. *J Clin Microbiol.* 2005; 43(5):2155-2162.
  20. Al-Bakri AG, Othman G, Bustanji Y. The assessment of the antibacterial and antifungal activities of aspirin, EDTA and aspirin-EDTA combination and their effectiveness as antibiofilm agents. *J Appl Microbiol.* 2009; 107:280-6.
  21. Cederlund H, Mardh PA. Antibacterial activities of non-antibiotic drugs. *J Antimicrob Chemother.* 1993; 32, 355–365.
  22. Erb-Downward JR, Noverr MC. Characterization of prostaglandin E2 production by *Candida albicans*. *Infect Immun.* 2007; 75:3498–3505.
  23. Zhou Y, Wang G, Li Y, Liu Y, Song Y, Zheng W, Zhang N, Hu X, Yan S, Jia J. In vitro interactions between aspirin and amphotericin B against planktonic cells and biofilm cells of *Candida albicans* and *C. parapsilosis*. *Antimicrob Agents Chemother.* 2012; 56:3250–3260.
  24. Gil ML, Casanova M, Martínez JP. Changes in the cell wall glycoprotein composition of *Candida albicans* associated to the inhibition of germ tube formation by EDTA. *Arch Microbiol.* 1994; 161: 489-494.
  25. Arias-Moliz MT, Ferrer-Luque CM, Espigares-Rodríguez E, Liébana-Ureña J, Espigares-García M. Bactericidal activity of phosphoric acid, citric acid, and EDTA solutions against *Enterococcus faecalis*. *Oral Surg Oral Med Oral Pathol Oral Radiol Endod.* 2008; 106(2):e84-e89.
  26. Sen BH, AKdeniz BG, Denizci AA. The effect of ethylenediamine- tetraacetic acid on *C albicans*. *OOOE.* 2000; 90:651-655.
  27. Lambert RJW, Hanlon GW, Denyer SP. The synergistic effect of EDTA/antimicrobial combinations on *Pseudomonas aeruginosa*. *J Appl Microbiol.* 2004; 96: 244–253.

28. El-Houssaini HH, Elnabawy OM, Nasser HA, Elkhatib WF. Correlation between antifungal resistance and virulence factors in *Candida albicans* recovered from vaginal specimens. *Microbial Pathogenesis*. 2019; 128: 13-19.
29. Redding S, Bhatt B, Rawls HR, Siegel G, Scott K, Lopez-Ribot J. Inhibition of *Candida albicans* biofilm formation on denture material. *Oral Surg Oral Med Oral Pathol Oral Radiol Endod*. 2009; 107(5): 669-72.
30. De Prijck K, De Smet N, Honraet K. Inhibition of *Candida albicans* biofilm formation by antimycotics released from modified polydimethyl siloxane. *Mycopathologia* 2010; 169(3): 167-74.
31. Casalnuovo IA, Sorge R, Bonelli G, Di Francesco P. Evaluation of the antifungal effect of EDTA, a metal chelator agent, on *Candida albicans* biofilm. *Eur Rev Med Pharmacol Sci*. 2017; 21(6):1413-1420.
32. Raad I, Hachem R, Tcholakian RK, Sherertz R. Efficacy of minocycline and EDTA lock solution in preventing catheter-related bacteremia, septic phlebitis, and endocarditis in rabbits. *Antimicrob Agents Chemother*. 2002; 46(2): 327-32.
33. Alem, M. A. & Douglas, L. J. (2004). Effects of aspirin and other nonsteroidal anti-inflammatory drugs on biofilms and planktonic cells of *Candida albicans*. *Antimicrob. Agents Chemother*. 48, 41-47.
34. Liu, X., Wang, D., Yu, C., Li, T., Liu, J., and Sun, S. (2016). Potential antifungal targets against a *Candida* biofilm based on an enzyme in the arachidonic acid cascade-a review. *Front. Microbiol*. 7:1925.
35. Deva, R., Ciccoli, R., Kock, L., and Nigam, S. (2001). Involvement of aspirin-sensitive oxylipins in vulvovaginal candidiasis. *FEMS Microbiol. Lett*. 198, 37-43.

# Radiographic Evaluation of Five Variables in Iraqi Young Subjects among Impacted and Erupted Lower Wisdom Teeth Groups

Nuhad A. Hassan<sup>1</sup>, Amal R.S. Mohammed<sup>2</sup>

<sup>1</sup>M.Sc., Assistant Professor at Department of Oral Medicine, College of Dentistry, AL- Mustansiriyah University, Iraq, <sup>2</sup>M.Sc., Professor at Department of Oral Medicine, College of Dentistry, AL- Mustansiriyah University, Iraq

## Abstract

**Objective:** To look at those contrasts in five variables in connection to sex between impacted and erupted lower wisdom teeth groups on digital panoramic radiographs in Iraqi young subjects.

Those variables that compared were: retromolar space might have been measured by drawing a line starting with Ricketts (Xi) by drawing accordance with the focal point of the ramus on the distal surface of the lower 2nd molar. Retromolar space starting from the anterior edge of claiming ramus (AER-7) might have been measured dependent upon those distal surfaces of the more level the 2nd molar along the occlusal plane. The angle of the tooth axis of the 2nd and 3rd molar ( $\beta$  angle). Mesiodistal width of the lower wisdom tooth (MDW) was calculated, while space/width ratio (SWR) might have been gotten through (AER-7/MDW).

**Materials and Method:** This study comprised 80 patients their ages varying between 20 and 25 years all of them having full dentition with bilaterally present mandibular 3rd molars. After they examine clinically, lower 3rd molars were distributed into two; Group A erupted (20 male and 20 female), whereas Group B included the impacted mandibular 3rd molars (20 male and 20 female). Five variables were measured in all radiographs to make a comparison between the two groups. The data analysis was done by using SPSS (ver.10) by applying T-test and descriptive tests.

**Results:** The means of (Xi-7, AER-7, MDW) are larger in males than females in both groups A and B. The means of (Xi-7, AER-7,) are larger in group A than group B. the mean of the  $\beta$  angle is larger in group B. the mean of SWR in group B is less than 1.

**Conclusion:** This study demonstrated that the long axes of the 2nd molar and wisdom teeth ( $\beta$  angle) and a space parameter were important parameters in predicting mandibular 3rd molar eruption.

**Keywords:** Panoramic; 3rd molar; impacted tooth, ramus, center.

## Introduction

The 3rd molar (M3) varies more than the opposite molars in terms of shape, size, the timing of eruption,

and even tendency toward the impaction. In modern societies, M3s get impacted for more than any other teeth, and the impaction of mandibular M3 is more common than its maxillary counterpart<sup>1</sup>. Impaction can be defined as the failure of the whole eruption right into an everyday useful function of one tooth within ordinary time due to the absence of space within the dental arch, as a result of obstruction with some other tooth or development in an abnormal position<sup>2</sup>. Panoramic radiography is a radiological technique that can produce a single tomographic X-ray image of curved facial structures, including the maxillary and mandibular

---

### Corresponding Author:

**Nuhad A. Hassan**

Department of Oral Medicine/College of Dentistry/Al-Mustansiriyah University

Phone Number: 964+07803327473

e-mail: alwanxray@gmail.com

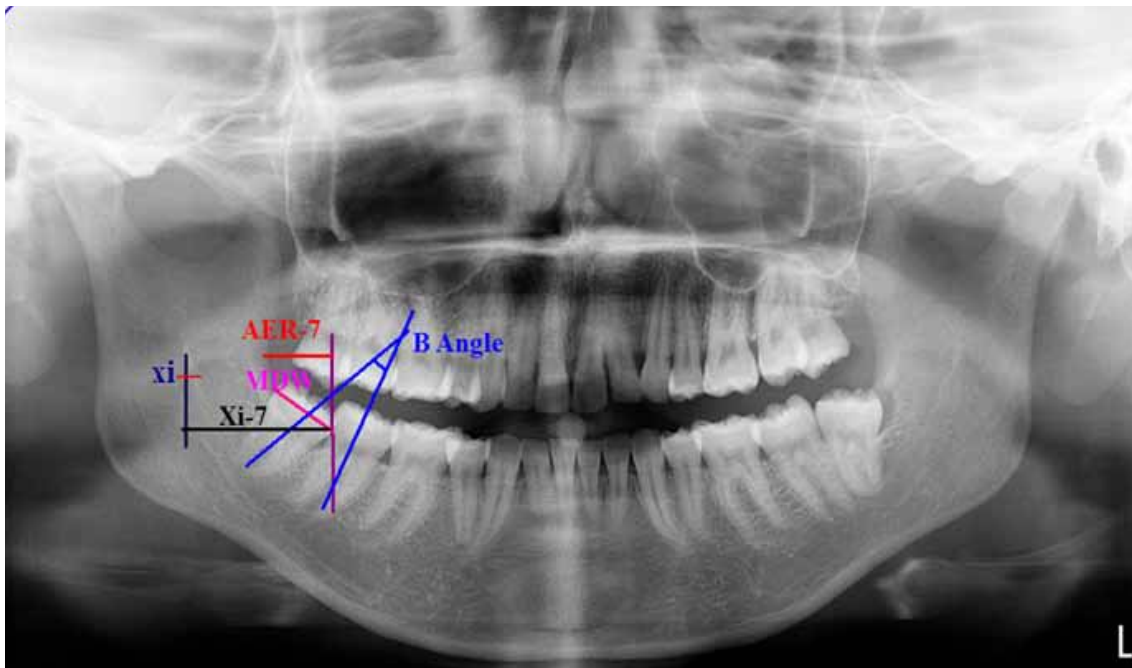
dental arches together with their supporting structures. Based on panoramic radiograms, it is possible to evaluate developing wisdom teeth and their surrounding tissues<sup>3</sup>. As stated by a few studies, there is no sex predilection in the impaction of M3<sup>4,5</sup>. However, Hugoson and Kugelberg<sup>6</sup> indicated a higher frequency in females than males.

The point of this investigation to look at those contrasts in five variables in connection to sex between erupted and impacted lower wisdom teeth groups on digital panoramic radiographs in Iraqi young subjects.

### Materials and Method

In this study, the samples collected retrospectively from the patients attending the college of dentistry-Mustansiriyah University from the time between (September 2017 - April 2018), about 80 patients all of them having full dentition with bilaterally present mandibular wisdom teeth their ages are among 20 and 25 years (40 were females and 40 were males). Patients were divided into two groups of mandibular wisdom teeth, first group was A, the patients in group A were having mandibular wisdom teeth which were fully

erupted into functional position in the other side there was the 2nd group B, the patients in group B comprised the mandibular wisdom teeth which were below the occlusal plane/erupted up to the occlusal plane but they were not fully functional due to their aberrant angulations. Digital panoramic radiographs (My ray CE 0051(V.B1 cocc A 14/C-IMOLA (BO)-Italy, X-ray source (75kVp, 5 mA), exposure time (9.34 sec), (52 mGycm), the analyzing process for all patients was by using different measurements. The measuring of the retromolar area done with the aid of sketching a straight line starts from Ricketts (Xi) point i.e. centers of ramus and it reaches until the distal surface of the lower second molar. The retromolar area from the anterior edge of the ramus (AER-7) was measured up to the distal surface of the lower 2nd molar alongside the occlusal plane. The angle of the tooth axis of 2nd molar and wisdom tooth ( $\beta$  angle). The mesiodistal width of the lower wisdom tooth (MDW) was calculated; Figure (1), whereas the gap/width ratio (SWR) was obtained through (AER-7/MDW). The means of all five variables between left and right have been taken. Data, which was then, analyzed the usage of SPSS for detecting the distinction between the two groups' means.



**Figure (1):** The measuring of the retromolar area was accomplished through sketching a straight line starts from Ricketts Xi point i.e. center of ramus and it attains till the distal surface of the lower 2nd molar. The retromolar area from the anterior fringe of the ramus (AER-7) became measured as much as the distal surface of the lower 2nd molar along the occlusal plane. The angle of the tooth axis of the 2nd and 3rd molar ( $\beta$  angle). Mesiodistal width of the lower 3rd molar (MDW).

### Results

The means of (Xi-7, AER-7, MDW,  $\beta$  angle) would bigger for males than females in group A and the means of (Xi-7, AER-7, MDW) would bigger for males than females of group B, as shown in table (1).

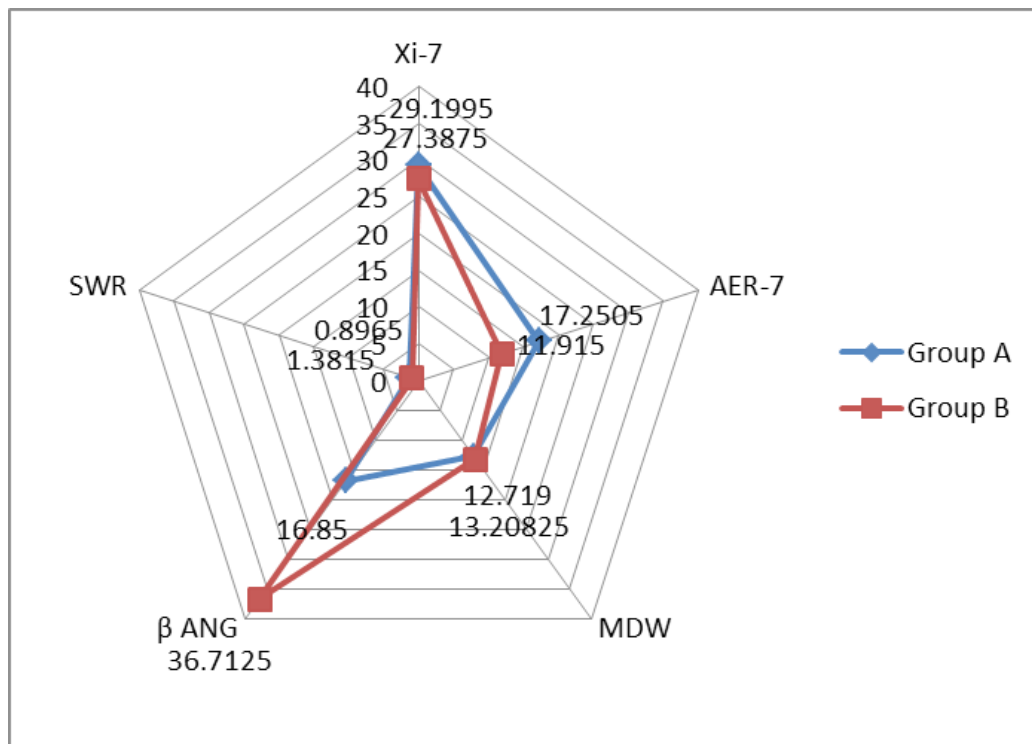
**Table (1): Descriptive of groups by gender.**

	Gender	Statistic	Xi-7	AER-7	MDW	$\beta$ Angle	SWR
Group A	Female	Mean	28.415	16.7965	12.095	16.775	1.41115
		SD	4.163185	1.477314	1.888955	3.097006	0.183264
	Male	Mean	29.984	17.7045	13.343	16.925	1.35045
		SD	3.988505	1.645637	2.288056	3.138366	0.170794
Group B	Female	Mean	26.865	10.975	12.903	36.95	0.8477
		SD	5.723477	3.70048	2.275161	3.594221	0.220419
	Male	Mean	27.91	12.855	13.5135	36.475	0.94525
		SD	6.006304	3.169837	2.278772	3.94193	0.124564

In group A, the means of (Xi-7, AER-7) are larger than group B, the mean of SWR in group B is less than 1 while the mean of  $\beta$  angle is larger in group B, table (2), figure (2) illustrated that.

**Table (2): Descriptive of group A, and Group B.**

Groups	Statistic	Xi-7	AER-7	MDW	$\beta$ Angle	SWR
Group A	Mean	29.1995	17.2505	12.719	16.85	1.3815
	SD	4.101854	1.610587	2.165219	3.078461	0.177685
Group B	Mean	27.3875	11.915	13.20825	36.7125	0.8965
	SD	5.81502	3.531655	2.268746	3.731171	0.183451



**Figure (2): Show means of variables in A & B groups**



The T-test between males and females for (AER-7, MDW) indicated a statistically significant difference in group A while it indicated a statistically significant difference for (AER-7, MDW, SWR) in group B, table (3) explained that.

**Table (3): T-test between Males and Females of each group.**

Groups	Statistic	Xi-7	AER-7	MDW	$\beta$ Angle	SWR
Group A	t-test	1.471	2.355	2.381	0.286	1.100
	P-value	0.158	0.029	0.028	0.778	0.285
Group B	t-test	1.090	3.889	2.517	0.414	2.515
	P-value	0.290***	0.001**	0.021*	0.683***	0.021*

The T-test between group A and group B showed a highly statistically significant difference for (AER-7, SWR,  $\beta$  angle), table (4) clarified that.

**Table (4): T-test between group A and group B.**

Statistic	Xi-7	AER-7	MDW	$\beta$ Angle	SWR
T-test	2.201	12.260	1.472	22.433	10.178
P-value	0.034*	P<0.01**	0.149***	P<0.01**	P<0.01**

\*P<0.05 Significant, \*\*P<0.01 High significant, \*\*\*P>0.05 Non-significant

## Discussion

Due to there is no space in human jaws, this thing has been a subject of great interest for a long period. The mandibular retromolar space is one of the most studied factors for two main reasons: the lower wisdom teeth are the 2nd most-affected teeth<sup>7,8,9</sup> and the absence of space may be viewed as the main reason for this. Thus, the tests of this space must be performed very carefully, particularly on young patients<sup>10</sup>. It'd make expected that facial growth, jaw size, and tooth length differ amongst races and populations seeing that there were only a few studies articles around this problem primarily based on the Serbian population<sup>11</sup>, this observes comparative in terms of gender for the Iraqi full dentition population, it showed that  $\beta$  perspective and an area parameter had been valuable parameters in predicting mandibular 3rd molar eruption which is in a near settlement with the part of findings of a examine performed with the aid of Uthman(2007)<sup>12</sup> using panoramic radiographs for Iraqi subjects.

Within the present day observe, the mean value for xi-7 became larger for Group A than for the organization on Group B which turned into near findings through others<sup>13,14</sup> and it concluded that the average value for xi-7 turned into larger in adult males than ladies with

a full eruption that's in the settlement with some other previous examine<sup>15</sup>. In this study, the suggested distance from AER to the distal surface of the 2nd molar becomes larger for A than Group B. tremendous difference turned into found among the two clusters. Ventä<sup>16</sup> stated that the probability of eruption is 100% if the retromolar area is as a minimum of 16.5 mm and Quiros and Palma<sup>17</sup> additionally located the range between 14-17 mm in the erupted group that is an agreement with the result of this look at. The prevailing examination conforms with the finding of Hattab and Alhaja<sup>18</sup> who mentioned that ladies had smaller than males. The prevailing have a look at and different research<sup>14,18</sup> additionally affirmed that 3rd molars had been larger in the impacted group. It'd had been viewed as that the growth of the lower retromolar area ought not to be anticipated after the age of 16<sup>19,20</sup>. On the other hand, Chen et al.<sup>21</sup> observed that there is a sizeable growth of this area between the age of sixteen and eighteen. this problem may be clinically considerable, considering that possibility to predict impaction of lower 3rd molar in an early stage could favor the decision to get rid of it easily earlier than the roots are completely shaped .within this survey at the SWR become bigger within the erupted group with the average value of 1.3815 wherein as within the impacted group, it changed into 0.8965.

That is following preceding studies<sup>12</sup> which found this ratio to be much less than 1 within the marginal eruption group and greater than 1 in the total eruption group. Olive and Basford<sup>22</sup> concluded that the gap/width ratio gives a dependable appraisal of the available retromolar space for the 3rd molar eruption and that orthopantomogram presents for the best estimation of the desired ratio, whilst the lateral cephalogram is unsure. Kahl et al.<sup>23</sup> located that the general public (97.40%) of impacted teeth did no longer have enough space and after 7 years of the statement, Gansset al.<sup>24</sup> concluded that, if the gap/3rd molar width ratio is greater than 1, most of the wisdom teeth could ultimately enter the arch which confirmed with the locating of this research.

An Iranian study executed via Ezoddini Ardakaniet, et al. in 2014<sup>25</sup> to determine and evaluate the eruption space of unerupted and erupted 3rd molars via the approach of digital panoramic radiography (seventy-three men and seventy-seven ladies with the common age of  $21.18 \pm 1.67$  years), a statistically giant difference was located among the 2 groups in regard with the common perspective among 2nd and 3rd molar, the implied space of retro-molar and its ratio to the width of 3rd molar in addition to the suggest distance among centers of ramus and 2nd molar ( $P=0.0001$ ), they concluded that increasing the angle among 2nd and 3rd molar, as well as an inadequate area of retro-molar, can cause impaction of lower 3rd molar that is in a close settlement with the effects of this Iraqi examine.

In the current study, the  $\beta$  perspective is larger in group b and women than group A and males, so it has been validated that the larger the inclination, the larger the probability of impaction which is in similarity with the result of the previous study<sup>26</sup>. It has been recommended in other to examine that if a 3rd molar has a low preliminary inclination and good enough area, then eruption is viable<sup>3</sup>.

### Conclusion

This study demonstrated that the long axes of the 2nd and 3rd molars ( $\beta$  angle) and a space parameter were important parameters in predicting mandibular 3rd molar eruption.

**Ethical Statement:** This study was conducted in accordance with the World Medical Association. Declaration of Helsinki, the approval of the scientific committee of the Oral Medicine Department was gotten.

**Declaration of Competing Interest:** The authors declare that they have no known competing financial interests or personal relationships that could have appeared to influence the work reported in this paper.

**Funding:** No funding was received for this study.

### References

1. Abu Alhaija ES, AlBhairan HM, AlKhateeb SN. Mandibular third molar space in different antero-posterior skeletal patterns. *Eur J Orthod* 2011; 33: 570-6.
2. Khawaja NA. Third molar impaction: a review. *J Pak Dent Assoc* 2006; 15:97-101.
3. Hattab FN. Positional changes and eruption of impacted mandibular third molars in young adults. Aradiographic 4-year follow-up study. *Oral Surg Oral Med Oral Pathol Radiol Endod*, 1997; 84: 604-608.
4. Hattab FN, Rawashdeh MA, Fahmy MS. Impaction status of third molars in Jordanian students. *Oral Surg Oral Med Oral Pathol Oral Radiol Endod* 1995; 79: 24-9.
5. Breik O and Grubor D. The incidence of mandibular third molar impactions in different skeletal face types. *Aust Dent J* 2008;53: 320-4.
6. Hugoson A and Kugelberg CF. The prevalence of third molars in a Swedish population. An epidemiological study. *Community Dent Health* 1988; 5: 121-38.
7. Bishara SE and Anreassen G. Third Molars: a review. *Am J Orthod* 1983; 83(2): 131-7.
8. Dachi SF and Howell FV. A survey of 3, 874 routine full-month radiographs. II. A study of impacted teeth. *Oral Surg Oral Med Oral Pathol* 1961; 14: 1165-9.
9. Grover PS and Lorton L. The incidence of unerupted permanent teeth and related clinical cases. *Oral Surg Oral Med Oral Pathol* 1985; 59(4): 420-5.
10. Zelić K and Nedeljković N. Size of the lower third molar space in relation to age in Serbian Population. *Vojnosanit Pregl* 2013; 70(10): 923-928.
11. Nedeljkovic N, Stamenkovic Z, Tatic Z, Racic A. Possibility of the lower third molar eruption-radiographic analysis. *Vojnosanit Pregl* 2006; 63(2): 159-62. (Serbian).
12. Uthman A. Retromolar space analysis in relation to selected linear and angular measurements for

- an Iraqi sample. *Oral Surgery, Oral Medicine, Oral Pathology, Oral Radiology, and Endodontics* 2007;104: e76-e82.
13. Schulhof RJ. Third molars and orthodontic diagnosis. *J Clin Orthod* 1976; 10:272-81.
  14. Qamruddin I, Qayyum W, Haider SM, Siddiqui SW, Rehan F. Differences in various measurements on panoramic radiograph among erupted and impacted lower third molar groups. *J Pak Med Assoc* 2012;62 (9): 883-887.
  15. Ventä I, Murtomaa H, Turtola L, Meurman J, Ylipaavalniemi P. Assessing the eruption of lower third molars on the basis of radiographic features. *Br J Oral Maxillofac Surg* 1991; 29: 259-62.
  16. Ventä I, Murtomaa H, Ylipaavalniemi P. A device to predict lower third molar eruption. *Oral Surg Oral Med Oral Pathol Oral Radiol Endod* 1997; 84: 598-603.
  17. Quiros O and Palma A. The mandibular third molar. A method of predicting its eruption. *The Orthodontic Cyber Journal*. (Online) (Cited 1999 July 20). Available from URL: <http://www.oc-j.com/3rdmolar/3rdmlr.html>.
  18. Hattab FN and Alhaija ES. Radiographic evaluation of mandibular third molar eruption space. *Oral Surg Oral Med Oral Pathol Oral Radiol Endod* 1999; 88:285-91.
  19. Niedzielska IA, Drugacz J, Kus N, Kreska J. Panoramic radiographic predictors of mandibular third molar eruption. *Oral Surg Oral Med Oral Pathol Oral Radiol Endod* 2006; 102(2):154-8; discussion 159.
  20. Ledyard BC Jr. A study of the mandibular third molar area. *Am J Orthod* 1953; 39: 366-9.
  21. Chen LL, Xu TM, Jiang JH, Zhang XZ, Lin JX. Longitudinal changes in mandibular arch posterior space in adolescents with normal occlusion. *Am J Orthod Dentofac Orthop* 2010; 137(2): 187-93.
  22. Olive R and Basford K. Reliability and validity of lower third molar space- assessment techniques. *Am J Orthod* 1981; 79(1):45-53.
  23. Kahl B, Gerlach KL, Hilgers RD. A long-term, follow-up, radiographic evaluation of asymptomatic impacted third molars in orthodontically treated patients. *Int J Oral Maxillofac Surg* 1994; 23(5): 279-85.
  24. Ganss C, Hochban W, Keilbassa AM., Umstad HE. Prognosis of third molar eruption. *Oral Surg Oral Med Oral Pathol Oral Radiol Endod* 1993; 76(6): 688-93.
  25. Ezoddini Ardakani F, Mirbeigi S, Jebali H, Besharati S. Comparing eruption space of the lower third molar in unerupted and erupted teeth via digital panoramic radiography in patients referring to yazd dental college during 2011-2013. *J Shahid Sadoughi Univ Med Sci* 2014; 22(3): 1246-55.
  26. Shiller WR. Positional changes in mesio-angular impacted mandibular third molars during a year. *J Am Dent Assoc* 1979; 99: 460-4.

# Information Seeking Problems that May Occur Against Covid-19 Vaccine When it is Ready

Olowo Emmanuel Opeyemi<sup>1</sup>, Hamisah Hasan<sup>2</sup>, Abdul Mua'ti<sup>3</sup>, Julia Wirza Mohd Zawawi<sup>4</sup>

<sup>1</sup>Doctoral Degree Student, <sup>2</sup>Associate. Professor, <sup>3</sup>Professor, <sup>4</sup>Senior Lecturer, Department of Communication, Faculty of Modern Languages and Communication, 43400 Univ. Putra Malaysia, Serdang, Selangor

## Abstract

Information-seeking patterns of vaccine receivers have over time been determined their vaccine decisions. These patterns are mostly represented by their demographic representation. Therefore it is interesting to review how these demographic representations have affected vaccine choices in the past. This paper would serve as a guide to health officials, human communication experts and pharmaceutical companies in the development and distribution of Coronavirus vaccines when it is ready.

**Keywords:** *Information seeking, Corona virus, Religion, Income, Side-effects, and Vaccine Hesitancy.*

## Introduction

The 8<sup>th</sup> of December, 2019 foresaw the first reported case of Corona Virus Disease 2019 (COVID-19) in Wuhan, China<sup>[1]</sup>. By April 25<sup>th</sup> 2020 over 2.8 million cases and 200,000 deaths have been confirmed all over the world with the United states of America, Italy, China and Spain were countries with most reported cases<sup>[2]</sup>. More so as at the time of this study vaccine against or to prevent this pandemic is not available. However, the World Health Organization (WHO) were able to team up with global forces, the mainstream media, and the government to pass out “the kick out coronavirus” campaigns<sup>[3]</sup>. This message published in 18 languages were protrude as (i) hands, washing of hands generally with soap or alcohol-based solutions (ii) elbow, covering of mouth and nose with a bent elbow or tissue whilst sneezing or coughing (iii) Face, avoid touching your face especially the “T-Zone” to prevent virus from entering your body (iv) distance, social distancing is way to break the chain of the virus. Keep a safe space always (v)

Feel, if you feel unwell, please report to the local health authorities around you<sup>[4]</sup>. These measures could only serve as more of a preventive measure against the virus than a permanent cure or anti vaccine solutions that have been put in place to tackle past epidemic and pandemic crisis. COVID-19 does not just alter and stretch medical personals and systems it has broken the world's economy as stocks and oil prices are falling by the data<sup>[4]</sup>.

This chaos has led to an emergency call/need for vaccines against, and to cure COVID-19. Vaccine development is ridiculously expensive. normally it takes between 20-30 months for a vaccine to complete clinical trials and Food and Drug administration FDA approvals. the race is on for the first pharmaceutical com to develop an approved (COVID-19) vaccine, but at what cost? would it be affordable? These are questions this paper will try to collate together. For example, <sup>[5]</sup> reported that over four thousand works have begun a trial for a century-old vaccine for tuberculosis to see if it could serve as an immune build up against the virus but not a cure. The assumption of this vaccine is that if your immune are stronger, it would limit the fatality of the virus if you were infected. Subsequently, the Murdoch Children's Research Institute (MCRI) explained that the vaccine results were expected in about six months' time. Another by <sup>[5]</sup> illustrated that COVID-19 is expected to be on the market in at least 18 months. Although leading pharmaceuticals like 'Inovio' explained that a DNA-based vaccine has begun pre-clinical trials (human

---

### Corresponding Author:

**Hamisah Hasan, PhD**

Associate. Professor, Department of Communication,  
Faculty of Modern Languages and Communication  
43400 Univ. Putra Malaysia, Serdang, Selangor  
Tel: +6012-371 7054  
e-mail: hamisah@upm.edu.my

test ready). More so GlaxoSmithKline are developing a protein vaccine “molecular Clamp” that enables COVID-19 to enter human cells. The United States company “Moderna” has already begun testing an RNA-based treatment [6]. On April the 20<sup>th</sup> Dr. Jennifer Miller, Ph.D stated in an interview to abc NEWS that one of the challenges involved in the clinical trials for a COVID-19 vaccine is procurement of a vaccine that is responsive to population needs/demands as the vaccine would be needed all over the world when it is ready [5]. However, it is important to understand how people approach health related issues based on their information seeking behaviours.

Wilson defines ‘information behaviour’ or ‘information seeking behaviour’ as a need that arises in order to fill a knowledge quest or to satisfy an information need [7]. Case, [8] explained that, an information need may consist or perceive a difference between an actual state of knowledge or an ideal state of knowledge. This information need might be satisfied by searching or seeking information from an informal or formal services or source of information, which might result in failure or success in finding that information. If this search for information is successful, the person might then make use of such information acquired to satisfy the need for it or transfer such a knowledge to another [10]. The race to develop a vaccine is much impressive, and the with the aid of technology one could be ready in 6-8 months. The questions remains that are manufactures putting into consideration everyone in the world and trying to learn from previous mistake?

would the manufacturers of this vaccine put into the consideration religious sentiments and beliefs during production? as we know people reject vaccines simply because it contains (religious) forbidden ingredients. For example, [9] could be referred to as one of the pandemic era in medical history because of the outbreak of measles and pertussis. This event in similar fashion like the COVID-19 caused for social distancing and exclusion from work and school in the affected areas [11]. Although as at the arrival of the vaccine, there were certain religious complications which influenced vaccine decisions [17]. A study by [19] found that some groups in india refused their children vaccinations due to religious predictive factors. For the catholicis the most common issues regarding vaccinaions has been the moral reflection on vaccines derived from using cells of a voluntatry aborted fetus [18]. However, the catholic doctorines didn’t directly cover this vaccination topic directly, it only expalins on

the ability of human intellect and emphasises to always “save lives.” The protestant on the other hand are of the view that vaccination is an act of lack of faith in God. This explains why side effects following vaccinations are seen as a punishment from God [17]. The Jewish have a contradicting view to that of the Orthodox, they believe that people should vaccinate based on the recommendations of the health care professionals [16]. The Islamic tradition forbids use of certain food “haram” add this irritations are transfer to vaccinations as well, as seen In the case of Islam vs vaccines which contained pig DNA [7]. These religions sentiments can/would be a major problem for vaccine developers should there be a break through with the vaccine against COVID-19. They would have to find a balance where all of the population are comfortable with the ideology of vaccination [12].

Yes, the race to bit time and this pandemic means vaccines ought to be ready like yesterday, but would the emergency bypass for this vaccines not lead to another catastrophe in side effects? According to the study by the World Health Organization (WHO) in 2013 they explained that the public has a really tolerance to vaccine adverse reactions. Therefore, vaccines can only be administered when there are very rare or minor reactions reported [13]. Logically a vaccine that has passed all medical/clinical trials have been deem good enough by the appropriate authorities as good enough for the public. These vaccinations could be in oral or injection forms. Subsequently, such adverse effects like dizziness, fever, headache, pain, swelling, and loss of appetite [14]. With the race to create an emergency vaccine to help combat COVID-19 which should be out there in the market as soon as possible, pharmaceuticals need to be vary of the possible side effects that could follow such vaccine, because a severe reaction or complication might lead to an out-right of the vaccine [13].

More so, we have people who believe non-medical exemption for vaccines. they were never vaccinated. if a vaccine is available, would they be forced to accept the vaccine even if it is against their right knowing full well that they could endanger the whole nation?

In the United States of America (USA) for example, there are states that allow nonmedical exemptions (NMEs). These emptions are allow children to be exempted from vaccines due to medically contradictory reasons [15]. More so, parents are allowed to be exempted based on their personal, philosophical and religious beliefs as NMEs are considered as a balance in child

welfare and protection of parental rights and public health<sup>[20]</sup>. In the State of Texas the main reason for NEMs has been philosophical exemptions. Although states like Oregon, Washington and California have made the process of<sup>[2]</sup>.

Lastly, would the vaccine be acceptable to 1/3 of the world's population due to the cost of the vaccine?<sup>[6]</sup> explained that, income can be categorized into two; i) High income countries, ii) low income countries:<sup>[6]</sup> continued that high-income countries (HIC) are often of the opinion that vaccine is a victim of its own success. Parents in this category believe or argue that the decrease of Vaccine preventable diseases (VPD) means they don't need the vaccine anymore, as thus, the fear of receiving "useless vaccine" is more prominent than the fear of VPD. Low income countries on the other hand, still believe in the ideology of vaccination. So, it's really unclear as to why there is a decrease in acceptance amongst them<sup>[6],[8]</sup> in an article reported for the Los Angeles Times, explained that vaccine exemptions in more than 150 schools in Los Angeles rose above 8%. Parents responsible for these exemptions were those who earn an average of \$94,500. Hiltzik concluded that schools and government shouldn't allow these "rich" parents affect the herd immunity with their poor vaccine decisions<sup>[8],[21]</sup> illustrated in their study that, Low income adults are more open to accepting vaccinations when compared to the high-income adults. also pointed out that, due to personal experience, with VPD most women view vaccination positively<sup>[22]</sup>.

### Conclusion

As the world currently seek possible solutions to the COVID-19 pandemic, it is empirical for pharmaceutical to reflect on the possible determinates of vaccine hesitancy. A vaccine is only as useful as the acceptance rate. More so, given that the nature of this kind of vaccine that would be useful to everyone irrespective of their socio demographic representation. This is tricky because of the contagion rate of the pandemic. One cannot afford to leave out a certain heterogenous anti vaccine population. Questions of how the United Nations (UN) would enforce those against non-medical exemptions to take the vaccine when it is eventually ready is fascinating. Would the rights of private individuals be treated and put into consideration before the safety of the herd? How would they be convinced to accept the vaccine? As for religion, as observed above that might be a little flexible if the "forbidden" materials are not used in the procurement of

the vaccine. However, the protestants who believe that vaccinations is against the almighty protection of God might also posit another complication. Lastly, due to the pandemic a lot of companies have been forced to lay off their employees. How affordable would the vaccine be that a family would not be forced to choose between their daily meal and vaccination? Affordability is a key essential in vaccine acceptance.

**Conflict of Interest:** There are no conflict of interest noted.

**Ethical Clearance:** Taken from Universiti Putra Malaysia Ethics Committee (JKEUPM). Ref no- JKEUPM-2019-248.

**Source of Funding:** Self.

### References

1. WHO, "Pass the message: Five steps to kicking out coronavirus," 2020. [Online]. Available: <https://www.who.int/news-room/detail/23-03-2020-pass-the-message-five-steps-to-kicking-out-coronavirus>.
2. F. Wu, S. Zhao, B. Yu, Y. Chen, W. Wang and e. al., "A new coronavirus associated with human respiratory disease in China," *Nature*, 2020.
3. COVID-19, "Coronavirus Pandemic cases," 2020. [Online]. Available: <https://www.worldometers.info/coronavirus/>.
4. C. Joanne, "Global stocks fall as Oil Dips Below \$20," 2020. [Online]. Available: <https://www.wsj.com/articles/global-stock-markets-dow-update-3-30-2020-11584925602-11585531131>.
5. K. Byron, "Australia enters 4,000 healthcare workers in trial for coronavirus vaccine," 2020. [Online]. Available: <https://www.thestar.com.my/news/world/2020/03/26/australia-enters-4000-healthcare-workers-in-trial-for-coronavirus-vaccine>.
6. M. Mark, "Coronavirus vaccine: How soon will we have one?," 2020. [Online]. Available: <https://www.weforum.org/agenda/2020/03/vaccine-covid-19-coronavirus-pandemic-healthcare/>.
7. N. B. Angela, "Injecting healthy adults with live coronavirus provides moral dilemma, faster path to vaccine," 2020. [Online]. Available: <https://abcnews.go.com/Health/injecting-healthy-adults-live-coronavirus-moral-dilemma-faster/story?id=70331610>.

8. U. A. Knol M, "Large ongoing measles outbreak in a religious community in the Netherlands since May 2013," *Euro Surveill*, 2013.
9. H. Ruijs WL, "The role of religious leaders in promoting acceptance of vaccination within a minority group: a qualitative study.," *BMC Public Health*, 2013.
10. G. M. Shrivastwa N, "Predictors of vaccination in India for children aged 12-36 months.," *Vaccine*, 2015.
11. E. Sgreccia, "Moral reflection on vaccines prepared from cells derived from aborted human foetus," *Pontifical Academia Pro Vita.*, 2005.
12. Rabbinical, "Rabbinical Council of America. Statement on Vaccinations from the OU and Rabbinical Council of America," 2016. [Online]. Available: <http://www.rabbis.org/news/article.cfm?id=105814>.
13. J. D. Grabenstein, "What the world's religions teach, applied to vaccines and immune globulins," *Vaccine*, 2013.
14. WHO, "Adverse events following immunization," *The World Health Organisation*, 2013.
15. E. O. Olowo, H. Hamisah and W. M. Z. Julia, "Information Seeking and Trust on Vaccination Practices," *Human Communication PACA*, 2018.
16. S. K. McCauley, "Exploring the choice to refuse or delay vaccines: A national survey of parents of 6-through 23-month olds," *Academic Pediatre*, 2012.
17. S. N. Omer SB, "Vaccine refusal, mandatory immunization, and the risks of vaccine-preventable diseases.," *N Engl J Med.*, 2009.
18. R. Silverman, "No more kidding around: restructuring non-medical childhood immunization exemptions to ensure public health protection.," *Ann Health Law*, 2003.
19. N. Blank, A. Caplan and C. Constable, "Exempting schoolchildren from immunizations: states with few barriers had highest rates of nonmedical exemptions.," *Health Aff (Millwood)*, 2013.
20. M. Hiltzik, "Rich, educated and stupid parents are driving the vaccination crisis," 15 December 2018. [Online]. Available: <https://www.latimes.com/business/hiltzik/la-fi-mh-vaccination-crisis-20140903-column.html>.
21. P. Jeudin, E. Liveright, G. Marcela, C. Del and B. Rebecca, "Race, Ethnicity, and income factors impacting human papillomavirus vaccination rates," *Clinical Therapeutics*, p. 36, 2014.
22. E. Dube, M. Vivion and N. E. MacDonald, "Vaccine hesitancy, vaccine refusal and the anti-vaccine movement: Influence, impact and implications," *Vaccines*, 2015.

# Newly Emerged Online Educational Framework in Nursing Major During the Pandemic of COVID-19

Omar M. Khraisat<sup>1</sup>, Ahmad M. Al-Bashaireh<sup>2</sup>, Mohammad O. Khraisat<sup>3</sup>,  
Fatima H. Khraisat, HD<sup>4</sup>, Eman Nazly, PhD, RN<sup>5</sup>, Mohannad A. Aldiqs, MSN, RN<sup>6</sup>

<sup>1</sup>Assistant Professor, Head of Department, Al-Ahliyya Amman University (AAU)/Faculty of Nursing, Jordan,

<sup>2</sup>Assistant Professor, Vice Dean for Academic Affairs, Al-Ahliyya Amman University (AAU)/Faculty of Nursing, Jordan, <sup>3</sup>Medical Doctor, Cairo University, Kasr Alainy Faculty of Medicine, Egypt, <sup>4</sup>Primary School Chairman, Jordanian Ministry of Education, Jordan, <sup>5</sup>Associate Professor, Vice Dean for Deanship of Scientific Research, Al-Ahliyya Amman University (AAU), Jordan, <sup>6</sup>Mohannad A. Aldiqs MSN, RN, CNS, Lecturer, Mental Health Nursing, Al-Ahliyya Amman University (AAU)/Faculty of Nursing, Jordan

## Abstract

The pandemic of COVID-19 has globally interrupted the education systems. Many countries including Jordan forcefully moved to online education. This study is designed to build an innovative Framework to overcome the concerns and challenges of online clinical teaching.

A cyclical module of the Online Clinical Training Pathway (OCTP) was created to provide an opportunity for students to document their learning, in the form of a reflection guide. Each module aims to attain the intended learning outcomes through a set of four integrated learning activities. OCTP success was assessed by regular evaluation parallel with semi-structured interview targeted faculty members and students across courses and student levels. The results emerged a new framework of the teaching and learning of synchronous distance learning among participants. Technical limitations were also observed with regards to internet-connection speed and reliability. Quality indicators of the synchronous and asynchronous online environment were issues that need to be addressed. Creating opportunities to enhance online engagement through the use of new framework methodology provides a promising direction to bring experiential education into the online context.

**Keywords:** *Clinical, COVID-19, Education, Framework, Nursing, Online.*

## Introduction

The pandemic of COVID-19 has globally interrupted the social, economic, and education systems. Many countries around the world suspended their schools, academic institutions, and gathering places to minimize its contagiousness and lethality.

Our institution, a private university, offers a BScs nursing program, and as a consequence of the government orders directed toward the control of the spread of new COVID-19 infection in Jordan. University moved to a dual system of synchronous (Microsoft Team) and asynchronous distance learning (V class/Moodle) in March 2020. There are particular considerations for clinical courses in nursing. Nursing faculty members were under pressure and they need to be innovative to overcome concerns and challenges while teaching clinical courses since online education replaced the traditional face-to-face on-campus classes. Other concerns were challenging, as the emphasis on student interactions, continuity of quality of education, achieving the learning outcomes, and aiming to attain highly caliber competencies following Benner's model<sup>(1)</sup>.

---

### Corresponding Author:

**Mr. Mohannad A. Aldiqs**

Jordan-P.O. Box 311, Amman 19328, Al-Ahliyya  
Amman University (AAU)/Faculty of Nursing

Tel: + 00962 53500211, Ext (2536),

Fax +00962 65335169

e-mail: m.aldiqs@ammanu.edu.jo,

m-aldiqs@hotmail.com



Nursing faculty adopted Benner's model (2001) that describes five levels of proficiency in nursing to obtain the specialized competencies for each clinical course.

Thus, this study aimed to build an innovative Framework to overcome the concerns and challenges of online clinical teaching.

### **Challenges and Resolution: Learned Lessons:**

**Ensure the Lecturer Sees Participants' Faces along with the Lecture Slides:** It is always helpful for lecturers to see students' faces to recognize students' reactions. Microsoft Teams can display up to 40 participants on a screen and allows users to use dual screens<sup>(2,3)</sup>. Unfortunately, the number of students you can display depends on your (Personal Computer) PC's specification. The instructor PC's CPU should be Intel i7 or equivalent to be able to show 49 participants on display<sup>(4)</sup>. If the computer has Intel Quad-Core i3, so it could only display 15 on a window, and when there are a larger number of participants, the instructor needs to scroll the window to watch all students, which is not convenient<sup>(4,5)</sup>. So, instructors need to use two sets of PC and external monitors to see all participants. Additionally, the quality of the internet used by the Instructor may limit the uses of options within the Microsoft Team.

**The Quality Standards of Case Sceneries:** The online-training methodology is a method that tries to rebuild real-world characteristics and to enhance learners' clinical judgment, by using a problem-solving approach integrated into interactive learning scenarios<sup>(3,4)</sup>. These scenarios provide students with practical experience and immediate feedback through debriefing and guided reflection<sup>(7)</sup>.

Faculty of Nursing adopted a set of quality standards when the case sceneries designed as follows: (a) identify patient and other problems apparent or expected in the case, (b) suggest alternative problems that might be possible if more information were available, (c) identify the information needed, (d) identify relevant and irrelevant information in the case, (e) interpret the information to enable a response, (f) propose different approaches that might be used, weigh approaches against the evidence, select the best approaches for the case situation, and provide a rationale for those approaches, (g) Identify gaps in the literature and evidence as related to the case, and (h) evaluate the effectiveness of interventions, and plan alternative interventions based on analysis of the case.

**Student-Instructor Interactions:** Due to such imminent challenge with online courses, interaction is one of the major factors that were also extensively investigated in several studies<sup>(7,8,9)</sup>. Determinants of student interaction in online learning were a lot. Learners' style, instructor teaching style, course content, course design and length, instructional style, class size, and support system are examples of such determinants<sup>(7,8,9)</sup>.

The online teaching environment creates some obstacles for student-instructor interactions during the sessions. Several actions need to be considered by the Instructor. Instructors normally need to ask students to mute their microphones during the session, as microphones can catch a background noise, which makes the instructor's voices less audible. Even if the Instructor displays all students' faces, it is still challenging for a lecturer to visually notice signs that students want to say something. Instructors need to more systematically (rather than naturally) organize interactions.

To enhance students' readiness and interaction in a weekly manner proceeding of the online session, the standardized videos, competency checklists, and structured case scenarios were uploaded on a synchronize (MOODLE/V class) system.

Further, on daily basis, the Clinical Training Portfolio was used by the instructor. Portfolios are valuable for clinical evaluation because students provide evidence in their portfolios to confirm their clinical competencies and document new learning and skills acquired in a course. The focus will be on inter-professional communication, collaboration professionalism, and teamwork by applying meaningful, and realistic scenarios<sup>(9)</sup> followed by a guided reflection that is a helpful tool in health care, to develop professional practice and improve the quality of care<sup>(3,10)</sup>.

**Evaluation for Students' Interaction:** In follow-up for debriefings of student-instructor interactions, the training provided to learners with feedback about their professional manner, attitude, and interpersonal skills, thus promoting standardized, rather than personal learning; this feedback is immediate and from the critical point of the adopted course portfolio.

The evaluation was conducted in three steps. The first step aimed to assess the current status of each competency for students based on the course portfolio. An evaluation was conducted every week. Various method focusing on the critical and/or core points were

used such as the folded and unfolded case scenario, self-exam module, short quizzes, and students' presentation. The second step aimed to explore the opportunities for improvement; the faculty members were conducted a weekly basis meeting to do a gap analysis to each course. The analysis was done by discussing the achievement report provided in the form of reflection which includes the target and desired level of competencies based on Benner's adopted model.

In the third step, the evaluation aimed to follow up on the implementation of the action plan using an objective structured clinical examination (OSCE) and a final written exam. OSCE and the final written exam cover all educational materials uploaded in the MOODLE and matched with the Nursing Student Clinical Training Portfolio and parallel with learning outcomes for each clinical course.

### Method

The study was guided by Benner's model. Online Clinical Training Pathway (OCTP) was created to provide an opportunity for students to document, in the form of a reflection guide. Using a semi-structured interview, purposive sampling of faculty members (focus group) ( $n = 4$ ) and students ( $n = 6$ ) from different courses and levels were recruited to evaluate barriers and facilitators of OCTP utilization.

The interviewer (moderator) guided the discussion according to a written set of questions or topics to be covered, as in a semi-structured interview. Focus group sessions are carefully planned discussions that take advantage of group dynamics for efficiently accessing rich information in an efficient manner. Typically, the people selected for a group (usually through purposive or snowball sampling) are a fairly homogeneous group, to promote a comfortable group dynamic. The setting for the focus group sessions selected carefully and, ideally, should be a neutral one.

**Analysis:** Use quantitative method as adjuncts to qualitative analysis was used similar to Kidd et al., <sup>(11)</sup>. Filling gaps of OCTP evaluation and return demonstration end by implementing a New framework for clinical course distance training.

**Ethical Considerations:** Written IRB approval was obtained as an expedited review from the Scientific Research Committee of Nursing Faculty at Al-Ahliyya Amman University (AAU).

## Results

**Newly Emerged Online Framework:** The huge challenges in online teaching for clinical courses were to tell students exactly what they should achieve and to continuously monitor their progression. The student is required to learn predetermined sets of intended learning outcomes for each course supervised by Faculty members.

He/she worked intensively and closely with the administrative support system to make this framework evident and ready for implementation. First, there is an agreement to run the clinical training in three phases: Phase- 1 preliminary phase (pre-training phase) refers to the activities and preparatory work made before the actual conduct of training. In this phase, actual preparations are made for launching the program. It involves the following activities: assessment of the needs of training design, and development of the training courses according to intended learning outcomes.

Phase -2 will follow the framework that was created and named as Online Clinical Training Pathway (OCTP) (Figure 1). Figure 1 describes the four consequent steps during the OCTP. Before the launching of OCTP and going live a crash session was conducted to all faculty members to explain the OCTP steps, integrate OCTP effectively within in a dual system of synchronized and a synchronized online training, and to obtain feedback of online training via a structured weekly performance report submitted by the instructors to the coordinator of clinical training.

In phase-2 of OCTP, students will be assigned to direct assignments depending on their level of learning and the nature of the course (e.g. standardized video, case scenarios, short essay, questions, log paper, self-exam module, and critical point care, etc.). All assignments were submitted through a synchronized online learning platform (V-class/Moodle). Following the assignments submission, all graded assignments will be discussed in an interactive online session conducted via synchronized distance learning (Microsoft Team). The online session via Microsoft Team provides students a chance to interact with their instructors and other students and help faculty members to explore the clinical reasoning and judgment of their students.

Additionally, students need to go a long standardized video, and competency-based check-off based on the National Council Licensure Examination (NCLEX)

standards. Students are required to be mastered certain psychomotor skills in a real clinical setting. So, a structured of folded and unfolded case scenarios were built and match with clinical intended learning outcomes for each course and compatible with the Nursing Student Clinical Training Portfolio to achieve this goal. These blended method provided to students in touch with the clinical area will enhance their critical thinking, reasoning, and clinical judgment once since they are way from the clinical area due to the constraints of lockdown and quarantine associated with the pandemic state of COVID-19.

In phase 2 evaluation is evident and continuously monitored, it is a process to determine the relevance, effectiveness, and impact of activities in light of their

objectives. In this phase, four criteria were included: reaction, learning, behavior, and results. OCTP program is continuously assessed and the gap noticed in this training will be followed by remedial actions after the commencement of education on campus. Phase 3 and phase 4 were proposed based on the continuous evaluation method during phase 2. In phase 3 and phase 4, a 2 weeks intensive training in a simulation lab followed by a final written exam and objective structured clinical examination (OSCE) are an example of future proposed remedies. The integration of all online training phases starting from preliminary to OCTP use and evaluation process was ended by the emerging Khraisat and Al-Bashairah Distance Training Model (KADTM) as showed in Figure 1.

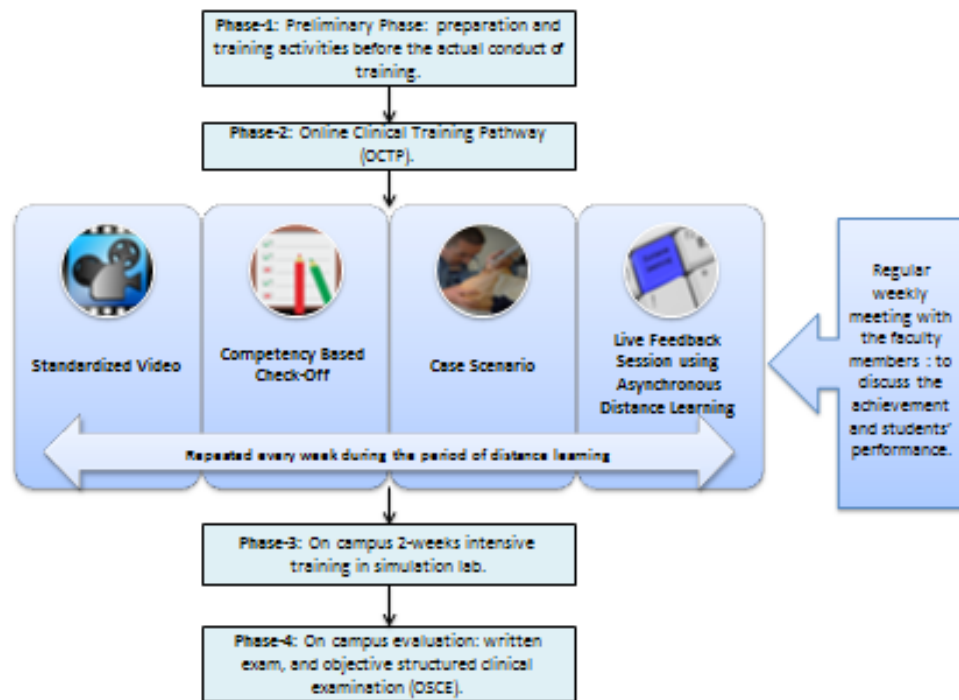


Figure 1: New Framework for Clinical Courses: Distance Learning Followed by Proposed On-Campus Training and Evaluation (Khraisat and Al-Beshairah Distance Training Model (KADTM) ).

## Discussion

**Evaluation of Implementation of New Framework:** As part of the evaluation of the implementation of the new framework, a semi-structured interview was used among a focus group of faculty members to assess barriers and facilitators of effective utilization of Synchronous Distance Learning (Microsoft Team) and Asynchronous Distance Learning (V-class/Moodle).

Data were collected on Tuesday (17/3/2020) between 08:00 and 11:00 pm, after 3 days of using Microsoft Team. Also, another (6) students from different courses and levels were involved by using a semi-structured interview to evaluate their responses to the implementation of online education during the pandemic crisis.

The faculty members reported that online teaching is a new experience; they learned a new strategy of

teaching synchronous distance learning. It may be used in the future as a supportive tool for the classical session. They reported that student culture needs time to be improved regarding the use and application of ethical standards when they are online. Additionally, they reported that evaluation was difficult for clinical courses since a large number of students.

Further, students reported that they were able to catch the required information from instructors in theory courses. However, they think the challenge wherewith the clinical courses. All students think they able to achieve 70-100% of learning outcomes for the course of theory; however, they think they may able to achieve 30-40% of learning outcomes in clinical courses. Similarly, 5 of 6 students said it was a great experience,” I learned a new strategy of the teaching of synchronous distance learning”. The majority of the students (4 out of 6) reported they were gotten a huge material even more than before (classroom) and they spend more time reading and preparation. They were highly committed to attend the online class was reported by 5 out of 6 students.

Technical problems reported in (e.g. accessing, hearing Instructors’ voices, internet disconnection, shared folder appearance, Instructor control for the session) with Microsoft Team and Moodle (50%). The mainstream of the students expresses a fear concerning the evaluation process. 4 out of 6 students ask for more flexibility from their Instructors concerning the deadlines, quizzes, attendance, and feedback.

Hence, the first few days up to the first week most of the issues were related technologies such as access, use, connectivity, voice, noise, and control while using Moodle or Microsoft Team. However, in the second week, these complaints vanished, students become more focused on the material, reading, Instructor feedbacks, and the anxiety toward the midterm exam.

### Conclusions

Both faculty members and students reported they “learned a new strategy of the teaching and learning of synchronous distance learning”. Distance Learning is an educational occasion that helps students to understand the content better and improves their engagement in learning.

Creating opportunities to enhance online engagement through the use of simulation provides a promising direction to bring experiential education

into the online context; in light of the COVID-19 outbreak and preparation for potential future outbreaks, the provision of such opportunities becomes critical in higher education contexts. Although it was not identified through this experience, when shifting to distance training encounters it is useful to consider the challenges and limitations that may be faced by the learners, instructors, and involving aspects related to professional competence, professionalism, and non-verbal communication skills. Future studies to use the KADTM as a methodology can examine: (a) the impact of distance training on the learners’ affective domain-including contextual challenges and psychological, social, and cultural barriers.

**Limitations:** Distance-training programs identified some limitations to be considered, regarding the use of body language and non-verbal skills. Technical limitations were also observed with regards to internet-connection speed and reliability. Quality indicators of synchronous and asynchronous online environment efficiency were issues that need to be addressed. Teaching effectiveness and performance quality indicators were two categories were also emerged. Computer anxiety was reported by some students. Furthermore, the accessibility to a stable internet connection can be a limiting factor.

**Conflict of Interest:** None to declare.

**Financial Disclosure:** There is no financial disclosure.

### References

1. Field DE. Moving from novice to expert—the value of learning in clinical practice: a literature review. *Nurse education today*. 2004 Oct 1;24(7):560-5.
2. Farhadi B. “The Sky’s the Limit”: On the Impossible Promise of E-learning in the Toronto District School Board (Doctoral dissertation).
3. Petrucci C, La Cerra C, Caponnetto V, Franconi I, Gaxhja E, Rubbi I, Lancia L. Literature-based analysis of the potentials and the limitations of using simulation in nursing education. In *International Conference in Methodologies and intelligent Systems for Technology Enhanced Learning 2017* Jun 21 (pp. 57-64). Springer, Cham.
4. Cheng A, Morse KJ, Rudolph J, Arab AA, Runnacles J, Eppich W. Learner-centered debriefing for health care simulation education: lessons for faculty development. *Simulation in Healthcare*. 2016 Feb 1;11(1):32-40.

5. Murphy MP. COVID-19 and emergency eLearning: Consequences of the securitization of higher education for post-pandemic pedagogy. *Contemporary Security Policy*. 2020 May 1:1-4.
6. Zhao J, Xiao H, Li Y, Wen D, Xu P, Fu Y, Piao J, Liu J, Cao D, Zhong Z, Zhao G. Experience of Massive Distance Online Education for Medical Colleges and Universities in China to Counter the COVID-19 Pandemic.
7. Oh PJ, Jeon KD, Koh MS. The effects of simulation-based learning using standardized patients in nursing students: A meta-analysis. *Nurse education today*. 2015 May 1;35(5): e6-15.
8. Cascella M, Rajnik M, Cuomo A, Dulebohn SC, Di Napoli R. Features, evaluation and treatment coronavirus (COVID-19). InStatpearls [internet] 2020 Mar 8. StatPearls Publishing.
9. Luhanga FL. The traditional-faculty supervised teaching model: Nursing faculty and clinical instructors' perspectives. *Journal of Nursing Education and Practice*. 2018;8(6):124-37.
10. Barak M, Hussein-Farradj R, Dori YJ. On-campus or online: examining self-regulation and cognitive transfer skills in different learning settings. *International Journal of Educational Technology in Higher Education*. 2016 Dec;13(1):1-8.
11. Kidd PS, Parshall MB. Getting the focus and the group: enhancing analytical rigor in focus group research. *Qualitative health research*. 2000 May;10(3):293-308.

# Factors Contributing to Emotional Distress among Postpartum Mothers with Newborns at Newborn Unit Kenyatta National Hospital, Kenya

Omulo O. Wycliffe<sup>1</sup>, Cheptum Jebet Joyce<sup>2</sup>, Mageto G. Irene Mageto<sup>3</sup>

<sup>1</sup>BSc Nursing Student at the Stime of the Study, <sup>2</sup>Lecturer, Midwifery and Obsteric Nursing,

<sup>3</sup>Lecturer, Mental health and Psychiatric Nursing, School of Nursing Sciences, University of Nairobi,  
P.O Box 19676-00202, Kenyatta National Hospital Nairobi, Kenya

## Abstract

**Background:** The expectation of a woman during pregnancy is to have a healthy live bay with no complications. Admission of a newborn baby to the newborn unit is distressing to the parents, more so in cases where there is little or no support from the health care team and other players.

**Objective:** To establish factors contributing to emotional distress among postpartum mothers with newborns at newborn unit Kenyatta National Hospital, Kenya.

**Method:** This was a descriptive cross-sectional study employing a quantitative method by use of an interviewer-administered questionnaire. The study was conducted among 59 postpartum mothers with newborns at the Newborn Unit Kenyatta National Hospital. Simple random sampling technique was employed and data collected using a pretested semi-structured questionnaire. Data was analyzed using Statistical Package for The Social SPSS version 25 software. Qualitative data was coded, categorized into themes and thematic analysis done.

**Results:** The factors contributing to maternal emotional distress were low levels of education primary 14(23.7%) and secondary 23(39.0%) and unemployment 27(45.8%). In addition, lengthy NBU stays 34(57.6%), ineffective communication patterns 18(30.5%) and null communication 9(15.3%) between mothers and the healthcare givers contributed to emotional distress.

**Conclusion:** There are sociodemographic, socioeconomic, and hospital factors contributing to maternal emotional distress.

**Keywords:** *Emotional distress, postpartum mothers, newborn unit, factors, baby.*

## Introduction

Postpartum period is the duration immediately after birth of a child and the expulsion of placenta extending

to about 6 weeks<sup>1</sup>. During this period, the maternal body undergoes a lot of physiological changes to return into the non-pregnant state. Mothers face a lot of challenges during the postpartum period<sup>2</sup>. These include need for social support, issues with breast feeding (especially first-time mothers) and need for help with postpartum emotional distress among others. Globally, emotional distress during the postpartum period will impact negatively on both the maternal and the newborn health and well-being<sup>3</sup>. Emotional distress is the second most common cause of maternal deaths in United States of America (USA) with about 20% of the affected population committing suicide each year<sup>4</sup>. Maternal

---

### Corresponding Author:

**Joyce Jebet**

Lecturer, Midwifery and Obsteric Nursing, School of Nursing Sciences, University of Nairobi, P.O Box 19676-00202, Kenyatta National Hospital Nairobi, Kenya

e-mail: jjcheptum@gmail.com

Tel: +254721475165

emotional distress negatively impacted on the mother-child bonding leading to impaired neurodevelopment among the children in China<sup>5</sup>. It was reported that emotionally distressed postpartum mothers have higher chances of early breastfeeding termination. 40% of children in such cases were ending up underweight and stunted in growth. Apart from increasing mortality rate with emotional distress, mothers also showed less affectionate manners towards their newborns in USA<sup>6</sup>. In Kenya, the prevalence of infanticides among emotionally distressed mothers as at 19% and 1 out of 10 emotionally distressed mothers is likely to commit suicide.<sup>7,8</sup>

Newborn unit (NBU) admissions have been associated with elevated emotional distress among the postpartum mothers<sup>6</sup>. It is believed that the NBU environment, the prolonged duration of hospital stays due to newborn admission among other factors contribute to heightened emotional distress among the mothers.

Sociodemographic and socioeconomic factors have been found to contribute to emotional distress among postpartum mothers<sup>9</sup>. These include being household heads, low level of education and financial constraints<sup>10</sup>. Hispanic women living in the rural areas of Southern California were more likely to develop emotional distress during the postpartum period due to low level of education, unemployment, caesarean mode of delivery and being a primipara<sup>11</sup>. Mothers who experienced suicidal thoughts during pregnancy, those who were exposed to domestic violence, those who had unplanned pregnancies and a history of a previous psychiatric illness were at a higher risk of developing emotional distress<sup>12</sup>.

A few studies have been conducted to establish the factors which may lead to the heightened emotional distress among the NBU mothers. These are different from the causes of newborn admissions themselves. World Health Organization reports poverty, low social support, exposure to violence and extreme stress among other factors as the causes of emotional distress among such mothers<sup>13</sup>. Several hospital factors have been found to contribute to emotional distress among postpartum mothers with babies at the NBU with regards to the complexity of such environments<sup>14</sup>. Concerns that the health care team may misunderstand the newborn's needs and mothers feeling of lack of information on the diagnosis or treatment of their newborns contributed to maternal distress<sup>15</sup>. In a systemic review of parental

needs for mothers with NICU newborns in US, there was lack of communication of information, maternal involvement in the newborn's care and lack of positive perception by and interaction with the NICU staff<sup>16</sup>. In a descriptive study in Turkey (state hospital Canakkale city), information communication, empathic emotional support and mothers' involvement in the treatment and diagnosis of their newborns lacked among the health care team<sup>17</sup>.

Lack of communication from health care staff was yet still a stressor in the NBU among the mothers of Midwestern<sup>6</sup>. Mothers felt alienated from care of their newborns. Poor bedside manner of the medical staff was also of major concern. Half of the mothers were being informed of the newborn's disease in inappropriate situations and most of them complained of negative attitude among health care professionals<sup>18</sup>. The unfavorable hospital conditions, not being able to see their newborns whenever they wished and not being able to get enough information regarding their newborns were also of major concerns.

With regard to Kenya's Sustainable Development Goal (SDG) 3 of ensuring healthy lives and promoting well-being for all at all ages, maternal and hence neonatal health and well-being is vital and relying on the country's efforts in the delivery of health care services to her citizens. Kenyatta National Hospital (KNH) therefore being the largest referral health facility receiving both direct admissions and referred cases from all across the country, it was very important to identify those postpartum mothers at potential risk for emotional distress and appropriate interventions implemented. In ensuring the same, the findings from this study may help establish those factors contributing to emotional distress and help put up the strategies to reduce such incidences.

## Materials and Method

This was a descriptive cross-sectional study employing a quantitative method to establish factors contributing to emotional distress among postpartum mothers with babies at the newborn unit at Kenyatta National Hospital. A sample size of 59 mothers who met the inclusion criteria were randomly selected to participate in the study. Data was collected using an interviewer administered questionnaire. Data was cleaned, coded and entered in SPSS version 25 and analyzed. Descriptive statistics was reported and data was presented by use of figures and tables. Ethical approval

was sought from Kenyatta National Hospital–University of Nairobi (KHN-UON) Ethics and Research Committee and permission at the Kenyatta hospital granted by the head of department obstetrics and gynecology.

## Results

On sociodemographic factors, majority of the respondents 17(28.8%) were aged between 18-23 years old. The mothers who were married were 32(54.2%). According to the findings, secondary 23(39.0%) and primary 14(23.7%) respectively were the levels of education attained by most mothers. The mothers residing far and very far from the hospital were 34(57.6%) and 17(28.8%) respectively. Those who had fairly good experience (uneventful) during pregnancy were 34(57.6%) while those with challenging and extremely stressful experiences were 17(28.8%) and 8(13.6%) respectively. The primiparous mothers were 23(39%) while 36(61%) were multiparous. Those who delivered through caesarian section and spontaneous vertex delivery were 25(42.4%) and 34(57.6%) respectively.

On socioeconomic factors, majority 27(45.8%) of the mothers were unemployed. Most mothers 34(57.6%) had income levels below 10,000 shillings. A larger percentage 39(66.1%) of the mothers reported to be the sole breadwinners in their families. On the other hand, mothers reported their past medical history and majority 37(45.1%) of the mothers had not previously suffered from any psychiatric illnesses.

On hospital factors, 34(57.6%) of the mothers had babies admitted to NBU for durations between 4-6 days while those above 6 days were at 25(42.4%). According to the findings, majority of the mothers 33(55.9%) and 20(33.9%) found the explanations regarding the baby diagnoses as helpful and confusing respectively. Most mothers 31(52.5%) and 17(28.8%) were worried and confused respectively upon first incubator sight of the baby. For 15(25.4%) of the mothers, the NBU policies were hindering while 20(33.9%) found them as stressful with only 24(40.7%) reporting the policies as protective. Majority of the mothers 28(47.5%) and 15(25.4%) received updates on baby's progress upon inquiry and weekly respectively. The findings showed 18(30.5%) and 9(15.3%) of the mothers reporting the mothers-caregivers' communications as ineffective and null respectively. Mothers who found the hospitals counseling services as insufficient were 29(49.2%), 22(37.3%) as beneficial while 8(13.6%) did not receive

any form of counselling. All the findings are as shown in the table 1 below.

**Table 1: Sociodemographic factors contributing to emotional distress among the respondents**

Characteristics	Frequency (n=59)	Percentage (%)
<b>Sociodemographic Factors</b>		
<b>Age</b>		
18-23	17	28.8
24-29	15	25.4
30-35	16	27.2
36-41	11	18.6
<b>Education</b>		
Primary	14	23.7
Secondary	23	39.0
College	13	22.0
University	5	8.5
Others	4	6.8
<b>Marital Status</b>		
Married	35	54.2
Separated	6	10.2
Single	21	35.6
<b>Residence</b>		
Far	34	57.6
Very far	17	28.8
Near	8	13.6
<b>Pregnancy Experience (Uneventful)</b>		
Good	34	57.6
Challenging	17	28.8
Extremely stressful	8	13.6
<b>Parity</b>		
Primiparous	23	39.0
Multiparous	36	61.0
<b>Mode of delivery</b>		
Caesarian section	25	42.4
Spontaneous vertex delivery	34	57.6
<b>Socioeconomic</b>		
<b>Employment status</b>		
Employed	11	18.6
Self-employed	21	35.6
Unemployed	27	45.8
<b>Average Monthly Earnings</b>		
<10,000	34	57.6
10,000-50,000	24	40.7
>50,000	1	1.7



**Table 2: Hospital factors contributing to emotional distress among the respondents**

Characteristics	Frequency (n=59)	Percentage (%)
<b>Hospital Factors</b>		
<b>Admission duration</b>		
4-6 days	34	57.6
>6 days	25	42.4
<b>Diagnoses explanations</b>		
Helpful	33	55.9
Confusing	20	33.9
Null	5	8.5
<b>Reaction to first incubator sight</b>		
Worried	31	52.5
Confused	17	28.8
Hopeful	11	18.6
<b>NBU policies</b>		
Hindering	15	25.4
Stressful	20	33.9
Protective	24	40.7
<b>Progress updates</b>		
Daily	9	15.3
Weekly	15	25.4
Upon inquiry	6	10.2
No updates	28	47.5
Others	1	1.7
<b>Mother-caregiver communication patterns</b>		
Effective	28	47.5
Ineffective	18	30.5
Null	9	15.3
Others	4	6.8
<b>Hospital counselling services</b>		
Insufficient	29	49.2
Beneficial	22	37.3
Null	8	13.6

**Discussion**

**Sociodemographic Factors:** The finding of this study showed that majority of the mothers had attained primary and secondary levels of educations. Even though majority of the mothers found explanations on baby diagnosis by the health care givers as helpful, a good percentage perceived them as confusing with resultant

anxiety. This can be attributed to the low level of education among the mothers with the characteristics of the health care givers a side. Lack of basic education can inhibit the understanding of even simplified information because even then, language barrier is a problem. This finding is in agreement with the study done by Kim and Dee where low levels of education contributed to maternal emotional distress<sup>19</sup>.

**Socioeconomic Factors:** The findings of this study showed that majority of the mothers were the sole breadwinners in their families (most of them were of small sizes). Most mothers were unemployed with a monthly income below 10,000 shillings. Due to the resultant financial strain in terms hospital costs and other incurred logistics, the additional stress is a contributory factor to maternal emotional distress. This can be attributed to non-engagement of the families in income generating activities and the unfavorable prevailing economic trends. This is in agreement with the previous study that being the head of the family was an additional stressor and a contributory factor to maternal emotional distress<sup>9</sup>. Other studies also found unemployment as a contributory factor to maternal emotional distress due to financial strains<sup>19</sup>.

**Hospital Factors:** In this study, majority of the mothers had babies staying in the NBU for durations between 4-6 days and a few exceeding 6 days. Such long stays were attributed to negative perceptions among the mothers with increased worries putting them at risk for maternal emotional distress. This is in agreement with the study that lengthy NBU stays increased strain on the mothers and their relationship with their babies increasing their chances of emotional distress<sup>20</sup>. This can be attributed to care givers lack of care optimization perhaps due to inadequate medical and human resources leading to lengthy NBU stays.

The findings of this study showed a good number of the mothers finding the care givers’ explanations regarding baby diagnosis confusing even though majority found them helpful. This can be attributed to the care givers characteristics such as use of technical medical language exacerbating their stress. This is in agreement with the findings of the study that mothers’ lack of information on diagnosis of their babies contributed to maternal emotional distress<sup>15</sup>. In another study, one out of five mothers had no idea on the diagnosis of their babies hence becoming emotionally distressed<sup>18</sup>.

The new born unit (NBU) is unfamiliar setting where mothers feel lost and frustrated with the negative perceptions contributing to emotional distress<sup>20</sup>. The findings of this study showed majority of the mothers feeling worried and confused on the first sight of their babies in the incubators. Most mothers also found the NBU policies stressful and hindering as far as taking part in care of their babies is concerned. This is in agreement with the findings of the study that NBU policies had set up impediments to the mothers for developing interactional skills with their babies hence exacerbating their emotional distress<sup>15</sup>. In some other study, NBU was found to be a complex environment raising anxiety and stress of the mothers. This can be due to lack of the health care givers' commitment in bringing to mothers an envisage of what NBU is in prior. Attributions can also be made to alienating NBU policies and regulations.

Majority of mothers were receiving updates on treatment progress of their babies weekly and only upon inquiry. This could be attributed to the care givers' lack of involvement of the mothers in the care of their babies and with the accompanying negative perceptions contributing to maternal emotional distress. This finding is in agreement with the study that there was lack of information to the mothers on treatment progress of the newborns in NBU leading to increased maternal emotional distress<sup>6,20</sup>.

In this study, majority of the mothers reported day to day communication between them and the healthcare givers as ineffective. This can be attributed to lack of involvement of the mothers by the healthcare givers in decision making and care of their babies and hence exacerbating their emotional distress. A tangible section of the mothers also reported the bed side manner of the healthcare providers as poor leading to stress among the mothers. These findings are in agreement with the study which found that poor bed side manner of the care givers, and lack of proper information communication gave the mothers a sense of alienation making them emotionally distressed<sup>6</sup>. In another study, lack of information communication, lack of maternal involvement and lack of positive interaction between the mother and the care giver was contributory to emotional distress.<sup>4,20</sup>

The findings of this study showed that the counselling services provided by the hospital were insufficient according to majority of the mothers. A few reported the nonexistence of such services. This can be attributed to such counselling services not meeting the

individualized needs of the mothers hence not meeting the threshold to aid towards emotional distress. This in agreement with the findings of the study that lack of emotional support by the healthcare team to help the mothers in expressing their feelings in coping with the babies' critical conditions was contributory to emotional distress<sup>3,17</sup>

## Conclusion

In conclusion, sociodemographic factors such as low levels of education and being the head of the family as a mother were contributing to maternal emotional distress. Socioeconomic factors such as unemployment and low levels of income were also contributing to maternal emotional distress with baby receiving care at the NBU. Hospital factors contributing to maternal emotional distress included: - lengthy NBU stays, inconsistent updates on baby's treatment progress and poor explanations by the health care givers, stressful and hindering NBU policies and regulations, ineffective communication patterns between the mother and the care givers and frail counselling services offered by the hospital.

**Conflict of Interests:** We declare no conflict of interest.

**Acknowledgement:** We acknowledge all the personnel in the Obstetrics and Gynecology department of Kenyatta National Hospital and the mothers who participated in this study.

**Source of Funding:** This research project was self-funded.

**Ethical Clearance:** Ethical approval was obtained from the Kenyatta National Hospital–University of Nairobi Ethics and research Committee.

## References

1. WHO, UNFPA, UNICEF. Pregnancy, Childbirth, Postpartum and New Born Care: A Guide for Essential Practice. IWorld Heal Organ IIUNFPA IIIUNICEF IVWorld Bank ISBN [Internet]. 2015;978(2):92–4. Available from: [www.who.int/about/licensing/copyright\\_form/en/index.html](http://www.who.int/about/licensing/copyright_form/en/index.html)
2. Lilo EA, Shaw RJ, Corcoran J, Storfer-Isser A, Horwitz SM. Does she think she's supported? Maternal perceptions of their experiences in the neonatal intensive care unit. *Patient Exp J*. 2016;3(1):15–24.

3. Alkozei A, McMahon E, Lahav A. Stress levels and depressive symptoms in NICU mothers in the early postpartum period. *J Matern Neonatal Med.* 2014;27(17).
4. Binder W, L. Z, C. S. The father in the hallway: Differing parental roles and their relation to post-traumatic stress reactions in parents of NICU babies. Vol. 35, *Neuropsychopharmacology.* 2010.
5. González G, Moraes M, Sosa C, Umpierrez E, Duarte M, Cal J, et al. Maternal postnatal depression and its impact on child neurodevelopment: A cohort study. *Rev Chil Pediatr.* 2017;88(3).
6. Williams KG, Patel KT, Stausmire JM, Bridges C, Mathis MW, Barkin JL. The neonatal intensive care unit: Environmental stressors and supports. *Int J Environ Res Public Health.* 2018;15(1).
7. Ongeru L, Wanga V, Otieno P, Mbui J, Juma E, Stoep A Vander, et al. Demographic, psychosocial and clinical factors associated with postpartum depression in Kenyan women. *BMC Psychiatry.* 2018;18(1).
8. Mutua JN. Prevalence of Post-partum depression and anxiety among Mothers of preterm infants receiving Intensive Care in Newborn unit at Kenyatta National Hospital. 2017;
9. Alvarado Socarrás JL, Gamboa-Delgado EM, Trujillo Cáceres S, Rodríguez Forero S. Depressive symptoms and associated factors in caregivers of newborn infants hospitalized in a neonatal intensive care unit. *Arch Argent Pediatr.* 2017;115(2).
10. Tahirkheli NN, Cherry AS, Tackett AP, McCaffree MA, Gillaspay SR. Postpartum depression on the neonatal intensive care unit: Current perspectives. Vol. 6, *International Journal of Women's Health.* 2014.
11. Kim AR, Tak YR, Shin YS, Yun EH, Park HK, Lee HJ. Mothers' Perceptions of Quality of Family-Centered Care and Environmental Stressors in Neonatal Intensive Care Units: Predictors of and Relationships with Psycho-emotional Outcomes and Postpartum Attachment. *Matern Child Health J.* 2020;24(5).
12. Narayan R. A study of the pattern of admissions and outcome in a neonatal intensive care unit at high altitude. *Sri Lanka Journal of Child Health.* 2012;41(2).
13. WHO. WHO | Neonatal mortality [Internet]. Who. 2017. Available from: [http://www.who.int/gho/child\\_health/mortality/neonatal\\_text/en/](http://www.who.int/gho/child_health/mortality/neonatal_text/en/)
14. Enke C, Oliva y Hausmann A, Miedaner F, Roth B, Woopen C. Communicating with parents in neonatal intensive care units: The impact on parental stress. *Patient Educ Couns.* 2017;100(4).
15. Baía I, Amorim M, Silva S, Kelly-Irving M, de Freitas C, Alves E. Parenting very preterm infants and stress in Neonatal Intensive Care Units. *Early Hum Dev.* 2016;101.
16. Turner M, Chur-Hansen A, Winefield H, Stanners M. The assessment of parental stress and support in the neonatal intensive care unit using the Parent Stress Scale - Neonatal Intensive Care Unit. *Women and Birth.* 2015;28(3).
17. Yilmaz F, Atay S, Arikan D, Güler ST. Evaluation of the effect of sociodemographic characteristics on the satisfaction of mothers in neonatal intensive care units in Turkey. *Iran J Neonatol.* 2016;7(1).
18. Yaman S, Altay N. Posttraumatic stress and experiences of parents with a newborn in the neonatal intensive care unit. Vol. 33, *Journal of Reproductive and Infant Psychology.* 2015. p. 140–52.
19. Kim Y, Dee V. Sociodemographic and Obstetric Factors Related to Symptoms of Postpartum Depression in Hispanic Women in Rural California. *JOGNN - J Obstet Gynecol Neonatal Nurs.* 2018;47(1).
20. Obeidat HM, Bond EA, Callister LC. The Parental Experience of Having an Infant in the Newborn Intensive Care Unit. *J Perinat Educ.* 2009;18(3).

# Assessment of Satisfaction Level and Quality of Life among Haemodialysis Patient's on Dialysis Therapy

Parimala L.<sup>1</sup>, Mary Sofia<sup>2</sup>

<sup>1</sup>Vice-Principal, <sup>2</sup>B.Sc (Nursing) IV Year, Saveetha College of Nursing, SIMATS, Thandalam, Chennai 602105

## Abstract

**Background:** Chronic diseases have become a major public health problem and the leading cause of morbidity and mortality. The burden of chronic kidney disease in India cannot be assessed accurately. QOL is an overall assessment of a person's well-being, which may include physical, emotional, and social dimensions, as well as stress level, sexual function, and self-perceived health status. Patients' quality of life (QOL) and satisfaction assessment are becoming increasingly important in health care delivery. There is evidence that better QOL and patient satisfaction might be associated with better medical outcome including reduced hospitalization and reduced mortality. The present aims are to assess the satisfaction level and quality of life among haemodialysis patients on dialysis therapy.

**Method:** A descriptive study was chosen to assess the satisfaction level and quality of life among 100 haemodialysis patients. The structured questionnaire was used to assess the satisfaction level and quality of life among haemodialysis patients. The present study results depicts that in regards to the level of satisfaction on dialysis procedure 16% were completely dissatisfied, 37% were dissatisfied, 18% were neither satisfied nor dissatisfied, 12% were satisfied and 17% were completely satisfied. The level of quality of life among haemodialysis patients, 8% had very negative impact, 42% had negative impact, 22% had no impact, 23% had positive impact and 5% had very positive impact.

**Conclusion:** The present study findings concluded that patients on HD were not having adequate QOL in all domains except patient satisfaction due to changes in the physiological, chemical changes occur in the kidney.

**Keywords:** *Satisfaction level, Quality of life, Hemodialysis, CKD and Dialysis Therapy.*

## Introduction

Chronic kidney disease has become a major cause of global morbidity and mortality even in developed countries. Global status report on non-communicable disease (2010) stated that 80% of chronic disease deaths worldwide occur in low and middle income countries. CKD prevalence in all over the world predicated to reach 8-16% of the populations.<sup>1</sup> Chronic kidney disease

is now the 3<sup>rd</sup> most common non-communicable disease in India. CKD incidence rises every year, especially in developing countries cause of increasing life expectation age, so that people have a longer age<sup>2</sup>. CKD therapy needs special treatment such as dialysis (Hemodialysis or peritoneal dialysis) or renal transplantation which needs a lot of costs. Renal transplantation actually is more efficient compared to dialysis because only in one treatment can make patients avoid dialysis procedure which takes place in relatively long duration. Meanwhile, many people use dialysis to treat CKD<sup>3</sup>.

---

### Corresponding Author:

**Parimala L.**

Vice-Principal, Saveetha College of Nursing, SIMATS, Thandalam, Chennai 602105

e-mail: parimala.scon@saveetha.com

Chronic kidney disease is now the 3<sup>rd</sup> most common non-communicable disease in India. Worldwide statistics shows that 9, 20,000 people are undergoing haemodialysis per day, which constitutes about 7-8% of the population. Patients undergoing haemodialysis

in today's society will require several life style modifications like diet, fluid, work and activities of daily living. Dialysis is treatment for patients with temporary or permanent kidney failure. Haemodialysis is the most commonly used method of dialysis<sup>4</sup>.

Kidneys are vital organs of our body and are integral to maintain the body's homeostasis. Dysfunction of kidney is very common now a day and may occur at any age with varying degrees. Kidney problems are acute and chronic kidney failure from stage 1 to stage 5 and end stage renal failure. Haemodialysis is the process, by which the crystalline substances will pass through a semi-permeable membrane, usually employed to remove waste and toxic products from the blood in cases of renal insufficiency. Haemodialysis was first developed by Thomas graham in 1884 and Dr William K off is considered as father of dialysis<sup>5</sup>.

Watson stated dialysis is a therapeutic procedure used in acute and chronic failure to lower the blood level of metabolic waste products (urea, creatinine, uric acid) and toxic substances and to correct abnormal electrolyte and fluid balances. Two method currently in use are continuous ambulatory peritoneal dialysis and haemodialysis. Haemodialysis takes place outside of the body using a dialysis machine to which an artificial kidney is attached<sup>6</sup>.

QOL is an overall assessment of a person's well-being, which may include physical, emotional, and social dimensions, as well as stress level, sexual function, and self-perceived health status<sup>7</sup>. Patients' quality of life (QOL) and satisfaction assessment are becoming increasingly important in health care delivery. There is evidence that better QOL and patient satisfaction might be associated with better medical outcome including reduced hospitalization and reduced mortality. Recently more attention has been paid to patient preferences in various renal replacement therapy modalities<sup>8</sup>.

According to the findings of recent studies, 322 patients on maintenance HD in 3 Saudi dialysis centers participated in a study regarding factors affecting their satisfaction with their dialysis therapy. The results indicated that the level of satisfaction is influenced by gender, duration on dialysis, educational level, and standard of care given. Specifically, a lower level of education was associated with worse dialysis effect on stress, overall health, sexual life, hobbies, and exercise ability.<sup>9,10</sup>

In a study conducted by **Kim et al. (2013)** with regards to health related quality of life (HRQOL) and its association with self-efficacy and the treatment satisfaction in Korean dialysis patients; the study subjects were 237 patients receiving either HD or peritoneal dialysis (PD) from two university hospitals. The main finding showed that patients' self-efficacy and treatment satisfaction could influence their HRQOL.<sup>11</sup>

**Palmer et al. (2014)** conducted a survey to evaluate patients' experiences of specific aspects of HD care across several countries in Europe and South America. 2748 adults treated in HD participated in the study. Aspects of care that respondents the most frequently ranked as excellent were staff attention to dialysis vascular access; caring of nurses; staff responsiveness to pain or discomfort; caring, helpfulness and sensitivity of dialysis staff; and ease of reaching dialysis staff by telephone. The aspects of care least frequently ranked as excellent were information provided when choosing a dialysis modality, ease of seeing a social worker, information provided about dialysis, accuracy of information from nephrologists, and accuracy of nephrologists' instructions<sup>12</sup>.

Although a considerable number of articles on QOL among haemodialysis patients have been published, few studies particularly are done to assess the level of satisfaction. Consequently, the assessment of the current issue needs to be better understood and addressed more among haemodialysis patients. The objectives of the study are to assess the satisfaction level and quality of life among haemodialysis patients on dialysis therapy.

## Method and Materials

The research approach adopted for the present study was quantitative approach by using descriptive research design. The study was conducted in Saveetha Medical College and Hospital with 100 samples who satisfied the inclusion criteria were selected by using non probability purposive sampling technique. The Demographic data consisting of age, gender, education level, duration of dialysis, causes of renal failure. The satisfaction level was assessed using 5-point Likert scale among haemodialysis patients. The quality of life was assessed using 5-point Likert scale among haemodialysis patients. The project has been approved by the ethical committee of the institution. Informed consent was obtained from the participants before initiating the study. The data were collected and analyzed by using descriptive and inferential statistics.

## Results

The current study reveals that out of 100 patients Majority of the participants belong to the age group of 41 to 50 years (48%), 64% were males, 61% had primary education. Regarding duration of dialysis, 19% had 21 to 50 sessions, 41% had 51 to 100 sessions and 40% of them had more than 100 sessions of dialysis. Regarding to cause of renal failure, 19% had arterial hypertension, 42% had diabetes mellitus, 29% had polycystic kidneys and 10% had other related problems.

Regarding to level of satisfaction on dialysis procedure, 16% were completely dissatisfied, 37% were dissatisfied, 18% were neither satisfied nor dissatisfied, 12% were satisfied and 17% were completely satisfied. (Table 1).

**Table 1: Assessment of satisfaction level among haemodialysis patients**

Level of Satisfaction	Frequency	Percentage (%)
Completely dissatisfied	16	16
Dissatisfied	37	37
Neither satisfied nor dissatisfied	18	18
Satisfied	12	12
Completely satisfied	17	17

Regarding to level of quality of life among haemodialysis patients, 8% had very negative impact, 42% had negative impact, 22% had no impact, 23% had positive impact and 5% had very positive impact. (Table 2).

**Table 2: Assessment of quality of life among haemodialysis patients**

Level of Satisfaction	Frequency	Percentage (%)
Very negative impact	8	8
Negative impact	42	42
No impact	22	22
Positive impact	23	23
Very positive impact	5	5

The current study also reveals that there is moderate positive correlation ( $r=0.682$ ) between satisfaction level and quality of life among the haemodialysis patients. The duration of dialysis associated with better effect ( $P=0.030^{**}$ ) on satisfaction level among haemodialysis patients. The education level associated with better effect

( $P=0.021^{**}$ ) on quality of life among haemodialysis patients.

## Discussion

The current study reveals that out of 100 patients Majority of the participants belong to the age group of 41 to 50 years (48%), 64% were males, 61% had primary education. Regarding duration of dialysis, 19% had 21 to 50 sessions, 41% had 51 to 100 sessions and 40% of them had more than 100 sessions of dialysis. Regarding to cause of renal failure, 19% had arterial hypertension, 42% had diabetes mellitus, 29% had polycystic kidneys and 10% had other related problems.

Regarding to level of satisfaction on dialysis procedure, 16% were completely dissatisfied, 37% were dissatisfied, 18% were neither satisfied nor dissatisfied, 12% were satisfied and 17% were completely satisfied.

The present study findings were supported by **M. Al Eissa** who reported that Patients were recruited from 3 Saudi dialysis centers. Using 1 to 10 Likert scale, the patients were asked to rate the overall satisfaction with, and the overall impact of, their dialysis therapy on their lives and to rate the effect of the dialysis therapy on 15 qualities of life domains. Results are 322 patients were recruited (72.6% of the total eligible patients). The mean age was 51.7 years ( $\pm 15.4$ ); 58% have been on dialysis for  $> 3$  years. The mean Charlson Co morbidity Index was 3.2 ( $\pm 2$ ), and Kt/V was 1.3 ( $\pm 0.44$ ). The mean satisfaction score was ( $7.41 \pm 2.75$ ) and the mean score of the impact of the dialysis on the patients' lives was  $5.32 \pm 2.55$ .<sup>13</sup>

Regarding to level of quality of life among haemodialysis patients, 8% had very negative impact, 42% had negative impact, 22% had no impact, 23% had positive impact and 5% had very positive impact.

**Abraham et al. (2012)** who Assessed the quality of life in patients on haemodialysis and the impact of counselling. The study revealed a remarkable difference in the QOL of HD patients in the test group during their first and second visits, while the control group showed only a slight or no change. There was an increase in the overall QOL of the test group patients when compared with the control group, although the baseline values are similar. The QOL of patients in the test group was compared with the control group using the independent t test. It showed that all the domain scores of the test group was significantly higher than the control group

( $P < 0.001$ ). Thus, patient counselling seemed to play an important role in improving the QOL by changing their psychological thinking and initiating them toward spirituality.<sup>14</sup>

The current study also reveals that there is moderate positive correlation ( $r=0.682$ ) between satisfaction level and quality of life among the haemodialysis patients. The duration of dialysis associated with better effect ( $P=0.030^{**}$ ) on satisfaction level among haemodialysis patients. The education level associated with better effect ( $P=0.021^{**}$ ) on quality of life among haemodialysis patients.

### Conclusions

This study of patient satisfaction and quality of life with different aspects of long-term haemodialysis care suggests that patients' needs are not being fully met. The findings suggest that meeting patient expectations about information on dialysis choices and prognosis may be critical for improving patient experiences of long-term dialysis care and can form the basis for future healthcare services research in the dialysis setting.

**Ethical Clearance:** This project has been approved by the ethical committee of the Saveetha Institute of Medical and Technical Sciences.

**Financial Support and Sponsorship:** Nil

**Conflicts of Interest:** The authors declare no conflicts of interest.

### Reference

1. Khan IA, Nasiruddin M, Haque SF, Khan RA. A randomized clinical trial to evaluate the efficacy and safety of keto amino acids in stage 3 and 4 of chronic kidney disease. *Asian J Pharm Clin Res* 2014; 7:21-4.
2. Schieppati A, Remuzzi G. Chronic renal diseases as a public health problem: Epidemiology, social, and economic implications. *Kidney Int Suppl* 2005; 68:S7-10.
3. Raines N, Gonz lez M, Wyatt C, Kurzrok M, Pool C, Lemma T, et al. Risk factors for reduced glomerular filtration rate in a Nicaraguan community affected by Mesoamerican nephropathy. *MEDICC Rev* 2014; 16:16-22.
4. Sathvik BS, Parthasarathi G, Narahari MG, Gurudev KC. An assessment of the quality of life in haemodialysis patients using the WHOQOL-BREF questionnaire. *Indian J Nephrol* 2008;18:141-9.
5. Mollaoglu M. Perceived social support anxiety and self-care among patients receiving haemodialysis. *Dial Transplant* 2006;35:144-55.
6. Theofilou P. Quality of life and mental health in haemodialysis and peritoneal dialysis patients: The role of health beliefs. *Int Urol Nephrol* .2012; 44:245-53.
7. Thenmozhi.PQuality of life of patients undergoing Hemodialysis. *Asian Journal of Pharmaceutical and Clinical Research*.2018;11(4): 219-223.
8. Zyga S, Alikari V, Sachlas A, Fradelos E, Stathoulis J, Panoutsopoulos G, et al. Assessment of fatigue in end stage renal disease patients undergoing haemodialysis: Prevalence and associated factors. *Med Arch* 2015;69:376-80.
9. Gerasimoula K, Lefkothea L, Maria L, Victoria A, Paraskevi T, Maria P. Quality of life in haemodialysis patients. *Mater Sociomed*2015;27:305-9.
10. Kim JY, Kim B, Park KS, Choi JY, Seo JJ, Park SH, et al. Health-related quality of life with KDQOL-36 and its association with self-efficacy and treatment satisfaction in Korean dialysis patients. *Qual Life Res* 2013;22:753-8.
11. Wan EY, Chen JY, Choi EP, Wong CK, Chan AK, Chan KH, et al. Patterns of health-related quality of life and associated factors in Chinese patients undergoing haemodialysis. *Health Qual Life Outcomes* 2015;13:108.
12. Baby B, Antony CL, Wilson S, Xavier T, Tamilselvan T. Evaluation of impact of pharmaceutical care on improving knowledge and medication adherence in CKD Patients. *Int J Pharm Pharm Sci* 2017;9:63-6.
13. Eissa MA, Sulaiman AM, Jondeby M, Karkar A, Barahmein V, Shaheen FA, et al. Factors affecting haemodialysis patients' satisfaction with their dialysis therapy. *Int J Nephrol* 2010:340-46.
14. Abraham S, Venu A, Ramachandran A, Chandran PM, Raman S. Assessment of quality of life in patients on haemodialysis and the impact of counselling. *Saudi J Kidney Dis Transpl*. 2012; 23:953-7.

# Exogenous Cushing's Syndrome with Subsequent Secondary Adrenal Insufficiency in Patients with Long Term Steroid Usage

Cynthia Ayu Permatasari<sup>1</sup>, Ferdy Royland Marpaung<sup>2</sup>

<sup>1</sup>Resident, Clinical Pathology Specialty Medicine Program, Faculty of Medicine, Airlangga University-RSUD Dr. Soetomo, Surabaya, Indonesia, <sup>2</sup>Lecturer, Clinical Pathology Department, Faculty of Medicine, Airlangga University-RSUD Dr. Soetomo, Surabaya, Indonesia

## Abstract

Exogenous Cushing's syndrome is a collection of symptoms and clinical signs due to elevated levels of glucocorticoids (cortisol) in the blood because of prolonged consumption of glucocorticoid drugs. Glucocorticoids were introduced in the 1950s and have been used for anti-inflammatory treatment. Withdrawal of glucocorticoids can lead to complications of secondary adrenal insufficiency caused by suppression of the Hypothalamic-Pituitary-Adrenal (HPA) axis. Male, 28 years old, with weakness in both hands and feet throughout 3 days before admission to hospital. Other complaints include nausea (+), vomiting (+), diarrhea (-). He had been taking dexamethasone daily in the past 3 years until one month ago when he suddenly stopped. Physical examination revealed moon facies (+), striae (+) in the abdomen, and motor strength of 2 in all four extremities. Laboratory: K 2.0 mmol/L, Mg 0.8 mg/dL, GDA 64 mg/dL, Total cholesterol 240 mg/dL, cortisol 18.67 ng/mL, ACTH 2.1 pg/mL. The patient was diagnosed with exogenous Cushing's syndrome based on a history of long-term use of dexamethasone. Physical examination revealed moon face, buffalo hump, purplish striae, and hypertension. The patient stopped dexamethasone consumption suddenly and is consequently experiencing secondary adrenal insufficiency at the present time. As evidenced by laboratory values, there was a decrease in serum cortisol (18.67 ng/mL), as well as a decrease in serum ACTH (2.1 pg/mL). Based on the history of dexamethasone use, physical examination, and laboratory results, this patient had exogenous Cushing's syndrome. Sudden discontinuation of dexamethasone results in withdrawal symptoms in the form of secondary adrenal insufficiency as indicated by low cortisol and ACTH values.

**Keywords:** *Cushing's syndrome, glucocorticoid, withdrawal, adrenal insufficiency.*

## Introduction

Cushing's syndrome is a term used to describe conditions resulting from increased concentrations of glucocorticoids (cortisol) in the blood circulation. The incidence of Cushing's syndrome is 0.7–2.4:1,000,000 population per year. This condition can be caused

by factors outside (exogenous) or inside the body (endogenous)<sup>1</sup>. Corticosteroid use is the most common cause of Cushing's syndrome, the exogenous type of which depends on the dose and potency of the steroid used and the duration of usage<sup>1-3</sup>.

Glucocorticoids were introduced in the 1950s, and have been used for anti-inflammatory, autoimmune and neoplastic treatment. Cushing's syndrome can manifest as a result of Glucocorticoids usage for treatment over a long period of time. Withdrawal of corticosteroids without tapering off can cause withdrawal symptoms, namely secondary adrenal insufficiency due to suppression of the hypothalamic-pituitary-adrenal (HPA) axis<sup>3,4</sup>.

---

### Corresponding Author:

**Ferdy Royland Marpaung**

Lecturer, Clinical Pathology Department, Faculty of Medicine, Airlangga University-RSUD Dr. Soetomo, Surabaya, Indonesia

e-mail: ferdyoke@gmail.com



Adrenal insufficiency is a pathological condition characterized by decreased glucocorticoid production. Adrenal insufficiency is rare, with an incidence rate of <0.01% in the general population. It can be classified as primary and secondary, with the latter occurring when exogenous steroids suppress the hypothalamic-pituitary-adrenal (HPA) axis, resulting in insufficient stimulation of the adrenal glands to secrete adrenocorticotrophic hormone (ACTH)<sup>5,6</sup>.

**Case Report:** A man aged 28 years came with complaints of weakness in both hands and feet for 3 days prior to hospital admission. Other complaints include fever (+), nausea (+), vomiting (+), and decreased appetite. Bowel movement and bladder within normal limits. The patient was diagnosed with gout (3 years ago) and had since been routinely taking

dexamethasone. In a day, the patient could take 9 to 15 tablets of dexamethasone until one month ago when the patient suddenly stopped.

**Physical Examination 26 August 2020 (Upon arrival at the ER):** The patient was generally weak; conscious (Compos mentis) with GCS 4-5-6; had blood pressure of 132/80 mmHg, pulse of 96×/minute, breathing of 22×/minute, and axillary temperature of 36.5 °C. Other physical examinations revealed moon face (+), buffalo hump (+), and purplish (+) striae on the abdomen. The acral extremities felt warm, and there was atrophy of the lower limb muscles, as well as oedema of both legs. Neurological examination revealed paraparesis with motor muscle strength of 2 for all extremities.

### Supporting Examination:

**Table 1. Hematological Examination.**

Parameter	26-08	27-08	28-08	31-08	02-09	Normal range
Hb (g/dL)	9.0	9.6	8.8	9.6	9.7	13.3-16.6
RBC (10 <sup>6</sup> /uL)	3.36	3.66	3.33	3.81	3.65	3.69-5.46
HCT (%)	26.4	38.3	27.4	30.4	29.4	41.3-52.1
MCV (fL)	84.7	81.5	82.3	79.8	80.5	86.7-102.3
MCH (pg)	26.6	26.2	26.4	25.2	26.6	27.1-32.4
MCHC (g/dL)	34.1	33.9	32.1	31.6	33.0	29.7-33.1
WBC (10 <sup>3</sup> /uL)	11.22	9.84	9.68	12.73	13.5	4.1-11.0
Eo (%)	1.9	2.1	2.2	2.5	1.5	0.6-5.4
Baso (%)	0.4	0.8	0.8	0.7	0.4	0.3-1.4
Neut (%)	82	70.3	59.3	69.1	86.6	39.8-70.5
Lymph (%)	14.8	17.6	27.3	19.2	8.4	23.1-49.9
Mono (%)	10.5	9.2	10.4	8.5	4.6	4.3-10
PLT (10 <sup>3</sup> /uL)	599	367	548	585	553	150-450
RDW (%)	12	13.5	14.0	13.2	14.5	12.2-14.8
LED (mm/jam)					52	
PPT (second)	11.6	13.7				9-12
APTT pend.(detik)	27.9	30.0				23-33

**Table 2. Clinical Chemistry Examination and Urinalysis.**

Parameter	26-08	28-08	31-08	1-09	2-09	4-09	Normal range
Na (mmol/L)	137	137	137	138	136	143	136-145
K (mmol/L)	2.3	3.4	3.4	2.9	3.4	3.1	3.5-5.1
Cl (mmol/L)	98	98	104	100	99	103	98-107

Parameter	26-08	28-08	31-08	1-09	2-09	4-09	Normal range
Ca (mg/dL)				6.8			8.5-10.1
Mg (mg/dL)	0.8	1.2	1.4		1.3	1.4	1.8-2.4
BUN (mg/dL)	4	2	9				7-18
SC (mg/dL)	1.2	1.2	0.9				0.6-1.3
Alb (g/dL)	2.61	2.8	2.9		3.0		3.4-5
GDA (mg/dL)	67	90			109		<200
SGOT (U/L)	56	59					L: 0-50, P: 0-35
SGPT (U/L)	39	47					L: 0-50, P: 0-35
Chol (mg/dL)						240	0-200
HDL (mg/dL)						44	40-60
LDL (mg/dL)						164	0-90
TG (mg/dL)						160	30-150
CRP (mg/dL)	13	14.67					0-1
Cortisol (ng/mL)		18.67				19.58 (Dexamethasone Suppression Test)	Morning serum (08.00-10.00): 57.2-194.2 Afternoon serum (16.00-18.00): 20.2 -131.0
ACTH (pg/mL)					2.1		7.4 – 64.3
Urinalysis	26-08	28-08	31-08	1-09	2-08	4-08	Normal range
pH		7.5					
Urine Kalium		27.75					35-80
Urine Natrium		122.5					30-300
Urine Chloride		145					85-170

**Table 3. Blood Gas Analysis.**

Blood Gas Analysis	26-08	28-08	Normal range
pH	7.53	7.58	7.35-7.45
pCO <sub>2</sub>	46	37	35-45
pO <sub>2</sub>	76	81	80-100
HCO <sub>3</sub>	36.4	34.7	22-26
TCO <sub>2</sub>	39.8	24.5	23-30
BE <sub>ecf</sub>	15.7	12.8	-3.5-2
SO <sub>2</sub>	97%	98%	94-98
AaDO <sub>2</sub>	16	3	15-50
%FiO <sub>2</sub>	21	21	
Temp	37	37	

**Conclusion:** The results of blood gas analysis on 26-08-2020 showed a metabolic alkalosis with compensation for respiratory acidosis. Blood gas analysis tests on 28-08-2020 revealed an uncompensated metabolic alkalosis.

**Table 4. Immunological Examination.**

Parameter	28-08	30-08	31-08	Normal range
C3	42.7			50-12
C4	24.0			17.4-52.2
ANA Test	10.82			Neg <40, Pos $\geq$ 40
FT4		1.52	1.63	0.89-1.76
TSH		1.993	1.863	>18 y.o.: 0.55 – 4.78

**Conclusion:** Immunological and thyroid function examination results in the patient were within normal range.



**Figure 1. Moon face (left) and purplish striae on the abdomen (right).**



**Figure 2. Buffalo hump (left) and atrophy of the lower limbs with edema in the instep (right).**

## Discussion

The adrenal glands, made up of the cortex and medulla, are located atop the kidneys. The adrenal gland cortex has 3 successive layers from the outside, namely the zona glomerulosa, the zona fasciculata and the reticular zone. These three layers secrete steroid hormones, namely mineralocorticoids produced by the zona glomerulosa, and glucocorticoids and androgens secreted by the zona fasciculata and the zona reticularis. Cortisol is the main product of glucocorticoids, which plays a role in regulating the metabolism of carbohydrates, proteins, and fats<sup>7,8</sup>.

Cortisol secretion is controlled by corticotropin or adrenocorticotropic hormone (ACTH), which is secreted by the anterior pituitary, further regulated by hypothalamic hormones to secrete corticotropin (CRH). Both ACTH and CRH are controlled by cortisol via a feedback mechanism<sup>2,7</sup>.

Glucocorticoids work as catabolic hormones, causing the breakdown of protein and fat and inhibiting protein synthesis in muscle, connective tissue, fat tissue, and lymphoid cells. This hormone also has an anabolic effect on metabolism in the liver<sup>2,7,8</sup>.

This patient presented with complaints of weakness and fatigue. On examination, purplish striae in the armpits and lower abdomen was found. The breakdown of protein causes muscles to weaken, bone structure to thin, and lessens the skin's resistance. Stretch of the skin over the site of new fat deposition added with loss of elasticity due to protein catabolism results in rupture of blood vessels' surface. Blood seeps through the gaps caused by collagen catabolism so that purple striae can be observed<sup>7</sup>.

The patient has hyperlipidemia characterized by increased levels of total cholesterol 240g/dL, triglycerides 160 g/dL, high-density-lipoprotein (HDL)-

cholesterol: 44 mg/dL, and low-density-lipoprotein (LDL)-cholesterol: 164 mg/dL. Hyperlipidemia occurs due to cortisol's potentiating effect on other hormones such as somatotropins and catecholamines in the lipolysis process in fat tissue<sup>3,6,8</sup>.

Hypercortisolism causes accumulation of fatty tissue in particular places such as the face (moon face), the interscapular area (buffalo hump) and the mesenteric base (body obesity). The cause of this characteristic distribution of fatty tissue is unknown, but it is thought to be related to insulin resistance and/or elevated insulin levels<sup>3,7</sup>. As the case showed, this patient had moon face, buffalo hump and body obesity.

Additionally, he has hypertension, which, in patients with Cushing's syndrome, occurs due to increased production of angiotensin II as a result of increased hepatic production of angiotensinogen, increased activity of blood vessels against vasoconstrictive hormones, decreased reuptake of catecholamine degradation products, or inhibition of vasodilators such as kinins and prostaglandins<sup>9</sup>.

Sudden discontinuation of corticosteroid use without tapering off can cause withdrawal symptoms such as secondary adrenal insufficiency due to suppression of the hypothalamic-pituitary-adrenal (HPA) axis<sup>5,10</sup>. Steroid withdrawal syndrome is a syndrome with symptoms of lethargy, malaise, anorexia, myalgia, headaches, fever, and skin desquamation. Sufferers have symptoms of weakness, fatigue, anorexia, nausea, and vomiting, all of which are present in the patient.

The diagnosis of exogenous Cushing's syndrome begins with clinical suspicion based on a physical examination. Exogenous Cushing's syndrome is indicated by low serum cortisol levels in the morning. ACTH levels are also relatively low since ACTH production by the pituitary is suppressed by exogenous steroids<sup>3</sup>.

Secondary adrenal insufficiency caused by ACTH deficiency is commonly caused by exogenous glucocorticoid therapy<sup>3,5</sup>. This patient had a history of long-term dexamethasone use in high doses. Taking dexamethasone will result in high levels of cortisol in the blood which in turn will reduce the secretion of ACTH.

Diagnosis of adrenal insufficiency is based on the suspicion of the patient's symptoms, clinical chemistry examination, and serum ACTH and serum

cortisol levels<sup>11</sup>. In secondary adrenal insufficiency, ACTH suppression has minimal effect on aldosterone secretion by the zona glomerulosa, therefore, there is no manifestation of mineralocorticoid deficiency. Hyponatremia and hyperkalemia rarely occur due to the reasons above<sup>4,5</sup>. The patient experienced low intake and vomiting which causes low potassium and magnesium levels, resulting in complaints of weakness in the 4 extremities. The weakness ameliorated after therapy and gradually improved as the patient's potassium and magnesium levels improved.

The next step after clinical suspicion of Cushing's syndrome is to prove that there is excess secretion of the hormone cortisol and impaired feedback mechanism of the hypothalamic-pituitary-adrenal axis. For initial laboratory testing, many guidelines recommend one of the following tests: two 24-hour urine-free cortisol checks, late night salivary cortisol, 1 mg overnight dexamethasone suppression test or a longer dose dexamethasone suppression test. These three tests are the most common types of initial tests to evaluate the possibility of Cushing's syndrome. They are often faced with difficulty or entirely not available in developing countries, so, pragmatically, only morning cortisol levels are checked. For morning serum cortisol, the results are quite acceptable if the results are extremely high.

Patient's history and physical examination strongly supported the diagnosis of Cushing's syndrome, but the laboratory examination did not show an increase in serum cortisol levels. The patient had a decreased level of cortisol (serum 08.00 am), namely 18.67 ng/mL. Morning serum cortisol levels indicate adrenal insufficiency caused by corticosteroid therapy when levels are below  $<3\mu\text{g/dL}$  ( $<30\text{ ng/mL}$ ) and indicate normal adrenal function when values are  $>20\mu\text{g/dL}$  ( $>200\text{ ng/mL}$ )<sup>3,4</sup>.

Serum ACTH levels are used to differentiate primary and secondary adrenal insufficiency. Ideally, an ACTH stimulation test using synthetic ACTH (Cortrosina<sup>®</sup>, Synacthen<sup>®</sup>) is carried out by first determining the baseline serum cortisol level, then injecting 250 mcg of ACTH intravenously, followed by assessing the serum cortisol level 30 and 60 minutes after ACTH administration. Normally, after an ACTH stimulation test there will be an increase in serum cortisol levels  $>20\text{ mcg/dL}$  or an increase of  $>10\text{ mcg/dL}$  from the patient's initial cortisol level (baseline). In secondary adrenal insufficiency, there is no increase in serum cortisol

levels after the ACTH stimulation test<sup>4,6</sup>. The limitation in this case was that the ACTH stimulation test was not performed because no synthetic ACTH was available in the Pharmacy Unit of Dr. Soetomo Hospital Surabaya.

In the presence of secondary adrenal insufficiency, serum ACTH levels are low (<5 pg/mL [1.10 pmol/L]). The patient had a decreased serum ACTH level, namely 2.1 pg/mL<sup>12</sup>. This supported the diagnosis of secondary adrenal insufficiency.

### Conclusion

The patient was diagnosed with exogenous Cushing's syndrome based on a history of long-term use of dexamethasone. Physical examination revealed moon face, buffalo hump, purplish striae, and hypertension. Sudden discontinuation of dexamethasone causes withdrawal symptoms, one of which being secondary adrenal insufficiency as evidenced by low morning serum values for cortisol and ACTH parameters.

**Conflict of Interest:** The author declare that they have no conflict of interest.

**Source of Funding:** This study supported by the Universitas Airlangga through the Annual Budget Activity Plan 2018.

**Acknowledgements:** We would like to thank the participants who have voluntarily participated, the Ponorogo Government Regency that support this study and the enumerators who have collected data. We additionally thank Arif Nur Muhammad Ansori for editing the manuscript.

**Ethical Approval:** This study approved by the Ethics Committee from Faculty of Public Health, Universitas Airlangga (121-KEPK/2018).

### References

1. Guaraldi F, Salvatori R. Cushing syndrome : Maybe not so uncommon of an endocrine disease. 2012; 199–208.
2. Siddiqi AI, Usamah M, Noor B. Review article diagnosis of Cushing's syndrome: Biochemical Investigations. 2017; 3(4).
3. Hopkins RL, Leinung MC. Exogenous Cushing's syndrome and glucocorticoid withdrawal. 2005; 34: 371–84.
4. Alves C, Cristina T, Robazzi V, et al. Withdrawal from glucocorticosteroid therapy : clinical practice recommendations. 2008; 84(3): 192–202.
5. Younes AK, Younes NK. Recovery of steroid induced adrenal insufficiency. *Transl Pediatr.* 2017; 6(1): 269–73.
6. Igaz P, RÁCZ K, Tóth M, et al. Treatment of Iatrogenic Cushing's Syndrome. 2007; 1(1): 63–72.
7. Kirk Jr, L.F., Hash, R.B., et al. Cushing's Disease: Clinical Manifestations and Diagnostic Evaluation. . *Am Fam Physiciancan.* 2005; 62.
8. Hernaningsih Y, Soehita S. Sindroma Cushing Pada Kehamilan. *Clin Pathol Med Lab.* 2005; 12(1): 21–30.
9. Harris GD FG. Hypertensive Endocrine Disorders. *Clinics in Family Practice.* 2002; 4(3).
10. Stewart PM N-PJ. The adrenal cortex. In: Melmed S, Polonsky KS, Larsen PR, Kronenberg HM, eds. *Williams Textbook of Endocrinology.* 13th ed Philadelphia, PA: Elsevier; 2016: 490–555.
11. Nimkarn S. Endocrinology Metabolism Adrenal Insufficiency Overview. 2017; 1–11.
12. Grossman AB. Secondary Adrenal Insufficiency. *Endocr Metab Disord - MSD Man Prof Ed.* 2020; 2–3.

# Influence of Exercise Classics on the Ability to Switch the Attention of Schoolchildren Aged 9-10 Years

**Polevoy G.G.**

*Candidate of Pedagogical Sciences, Associate Professor, Department of Physical Education,  
Moscow Aviation Institute (National Research University), Moscow, Russia*

## Abstract

**Background:** The problem of switching the attention of schoolchildren can be solved by exercises in physical education classes at school.

**Aim:** To determine the influence of exercise Classics on the ability of schoolchildren to switch their attention at the age of 9-10 years.

**Method:** The study was conducted over a period of 9 months, in which 40 9-10-year-olds took part. Physical education classes were held 2 times a week for 40 minutes each lesson. The level of development of coordination abilities was assessed on the «Shuttle run» test, and the indicators of attention switching on the «Method of Numbers» test. The programs bio-stat 2009, Microsoft excel 2016 and t-student were used for mathematical and statistical processing of results.

**Results:** Before the beginning of the pedagogical experiment, the indicators of school children between the groups did not have significant differences ( $P>0.05$ ). After the end of the study, the indicators in both groups improved. In CG, in the «Shuttle run» test, the indicators improved from  $10.2\pm 0.6$  to  $9.9\pm 0.5$  ( $P>0.05$ ), and in the test for the level of attention switching, the indicators improved by 5.4% ( $P>0.05$ ). In EG, in the «Shuttle run 3x10 m» test, the indicators improved from  $9.9\pm 0.5$  to  $8.5\pm 0.4$  ( $P<0.05$ ), and in the «Method of Numbers» test, the indicators improved by 26.6%. These results indicate the effectiveness of using exercise Classics in physical education lessons in working with younger schoolchildren.

**Conclusion:** If schoolchildren will perform exercise Classics in physical education classes at school, they will improve not only coordination abilities, but also attention switching indicators.

**Keywords:** *Attention switching, coordination abilities, school children, physical education, Classics.*

## Introduction

At the present stage of development of society, one of the most important tasks is the optimal level of motor activity, motor mode during the day. Unfortunately,

every year more and more children with disabilities enter the first classes in a state of health, while the main problem is a lack of motor activity. It was found that the lack of motor activity significantly worsens the health of the growing human body, weakens its defenses, and does not provide full physical development. Diseases of the heart, blood vessels, lung system, and some others are progressing and becoming younger. It is impossible to fully develop schoolchildren without physical education. Physical education is an integral part of the modern Russian education system. The main form of physical exercises in school is a physical culture lesson. During the lesson, the teacher forms schoolchildren interest in physical exercises, encourages them to be

---

### Corresponding Author:

**Polevoy G.G.**

Candidate of Pedagogical Sciences, Associate Professor, Department of Physical Education, Moscow Aviation Institute (National Research University), Moscow, Russia  
e-mail: g.g.polevoy@gmail.com

active. The main task is to ensure that children, starting from their earliest childhood, grow up healthy, strong, and harmoniously developed. Physical culture plays an important role in improving a person’s health<sup>1-2</sup>.

Schoolchildren receive the necessary minimum of knowledge, skills and abilities provided for in the school curriculum, and increase their level of physical development<sup>3</sup>. One of the problems of implementing modern programs is the lack of a comfortable gym for a lesson in physical culture. Some authors suggest replacing the standard program with modern method<sup>4-5</sup>. In our opinion, the more correct option is only to add the standard program. The effectiveness of implementing exercise Classics in physical education classes at school has been proved<sup>6</sup>.

An individual-differentiated approach to exercise Classics is very important. Thanks to this, schoolchildren can realize the reserve potential of their body, meet the needs for physical and motor activity<sup>7-8</sup>.

Exercise Classics allows you to develop coordination abilities – this is the ability of a person to quickly master new movements and solve motor problems that arise in unexpected and changing situations. A high level of development of coordination abilities allows you to save movement, strength, and time. The efficiency and rationality of human motor actions increases simultaneously with an increase in the indicators of coordination abilities<sup>9-11</sup>. It should be noted that the sensitive period for the development of most conditioning and coordination abilities is primary school age. The effect of developing such abilities will be higher if you purposefully influence them in early school age<sup>12-13</sup>.

Motor activity has a positive effect on the mental processes of schoolchildren, it improves their thinking

processes<sup>14-15</sup>. Some studies confirm the effectiveness of physical education for obtaining positive grades in other subjects<sup>16</sup>.

Thus, the aim of the study is to determine the influence of exercise Classics on the ability of schoolchildren to switch their attention at the age of 9-10 years.

**Material and Method**

**Participants:** 40 children, boys and girls 9-10 years old took part in the pedagogical experiment. At the time of the study, the schoolchildren were in the third grade at normal school No. 60 (Russia). Children who had good health indicators and were able to engage in physical education at school were admitted to the study.

All procedures met the ethical standards of the 1964 Declaration of Helsinki. Informed consent was obtained from all parents of the children included in the study.

**Procedure:** The pedagogical experiment lasted from September to may (9 months). Classes for schoolchildren were held twice a week for 40 minutes. There were 56 physical education classes in total.

**Before starting the study, two groups were formed:**

1. Control group (CG) - children of class 3A (20 people). During the school year, schoolchildren were engaged in a standard physical education program at school<sup>3</sup>.
2. Experimental group (EG) - children of class 3B (20 people). During the school year, schoolchildren were engaged in the usual program and additionally performed exercise Classics at each physical education lesson (table 1).

**Table 1. Exercise “Classic’s”**

1	5	6		2	8	5		9	3	4
4	8	2		7	4	1		8	2	7
9	7	3		9	3	6		1	6	5
Square 1				Square 2				Square 3		

**Exercise Classics:** In the gym, there are three large squares on the floor. The side of one square is 180 cm. Inside each large square there are nine small squares,

the side of the small square is 60 cm. Inside each small square are numbers from 1 to 9.

Task: the schoolchild must use jumps from square to square to get from number 1 to number 2, then to number 3, and so on, to number 9. After that, it should jump on the same squares in reverse order (from number 9 to number 1). You can move around the squares in any way (from one leg to the other, jump on one leg or on two). If the schoolchild makes a mistake, he returns to the previous square. During the lesson, each schoolchild must overcome three large squares. The numbers in the squares must be changed by the teacher before each lesson. You can perform the exercise in any part of the lesson.

**Before and after the pedagogical experiment all schoolchildren took control tests:**

1. “Shuttle run 3x10 m” (indicator of coordination abilities)<sup>17</sup>.
2. “Method of Numbers”<sup>18</sup>.

The A4 sheet shows 2 large squares. Each square has 16 small squares with numbers from 1 to 16 written in them (table 2).

**Table 2. Example of a blank in the “Method of Numbers” test**

4	9	14	11	15	14	2	7
16	1	2	6	3	5	8	10
13	8	15	3	12	9	13	16
5	12	7	10	1	11	6	4

Schoolchildren should switch their attention from square to square so that they can cross out the numbers in turn, first in the left square (number 1), then in the right square (number 1). The exercise ends when the schoolchildren has crossed out number 16 in both squares. Result: the time that children spent on completing the task (0.1 seconds).

**Statistical Analysis:** The results of the pedagogical experiment were processed using Microsoft excel 2016, which allows you to determine the average value of the indicators of both groups. The bio-stat 2009 program allows us to compare groups and determine the reliability of the results ( $P < 0.05$ ) using the t-student parametric criterion<sup>19</sup>.

**Results**

Before the beginning of the pedagogical research, all 40 schoolchildren took control tests. It should be noted that before the study, the differences in indicators between schoolchildren were not significant ( $P > 0.05$ ). After the study, the indicators changed in both classes (table 3).

Table 3 shows that the performance of schoolchildren from CG and EG improved in both tests. However, the improvement in both tests was different. In children in grade 3A who were engaged in the standard physical education program at school, the performance in the «Shuttle run» test improved from  $10.2 \pm 0.6$  to  $9.9 \pm 0.5$  ( $P > 0.05$ ). Schoolchildren who were engaged in the standard program and performed the exercise Classics in each lesson improved their coordination abilities from  $9.9 \pm 0.5$  to  $8.5 \pm 0.4$  ( $P < 0.05$ ). In the same way, the pedagogical experiment affected the indicators of switching the attention of schoolchildren. Children from CG in the «Method of Numbers» test had 5.4% higher scores ( $P > 0.05$ ), and children from EG had 26.6% better scores ( $P < 0.05$ ). Thus, we can talk about the insignificant effectiveness of the standard physical education program in secondary schools for the development of coordination abilities, and the introduction of exercise Classics in the educational process in physical education has a significant and positive effect on both coordination abilities and the ability of schoolchildren to switch attention.

**Table 3. Indicators of coordination abilities and abilities of children 9-10 years old to switch attention**

Test	CG				EG			
	Before	After	%	P	Before	After	%	P
Shuttle run 3x10 m (s)	10.2±0.6	9.9±0.5	2.9	P>0.05	9.9±0.5	8.5±0.4	14.1	P<0.05
Method of Numbers (s)	44.1±3.4	41.7±4.1	5.4	P>0.05	42,9±3.9	31.5±3.3	26.6	P<0.05



## Discussion

Physical culture is very important for a person. The main goal of physical education is comprehensive personal development, preparation for work and life in society. Physical education classes at school are mandatory and make a significant contribution to the development of schoolchildren<sup>1-2</sup>.

Today, the physical education program at school is a set of method, sets of exercises and rules. Some authors believe that the modern physical education program is outdated and should be replaced with modern methodics and sets of exercises. However, in our opinion, this is a very strict measure. It is enough to add only a little to the program, for example, exercise Classics which has proved to be positive in previous studies<sup>6</sup>.

This study is new, as it is the first to study the influence of exercise Classics on the ability of schoolchildren to switch their attention. The relationship was positive. Children who performed the exercise Classics in every physical education lesson at school improved their ability to switch their attention.

Such studies confirm the data that physical culture, exercise and sport have a positive impact on the human body not only in terms of physical fitness, but also intellectual development<sup>14-15,20-21</sup>, such children have an advantage in solving tasks that require increased mental readiness, respectively, receive more positive ratings for their abilities<sup>16,22</sup>.

It should be noted that the authors' opinion about a favorable period for the development of coordination abilities of primary school children is fully confirmed by this study, since children in the control group who did not take additional classes were able to improve their indicators of coordination abilities<sup>12-13</sup>.

An individual approach to working with children is used more often in high school, and in primary school age, the method of differentiated approach is more common, which also proved itself in a new study<sup>7-8</sup>.

## Conclusion

Thus, if you perform exercise Classics at each physical education lesson at school, the indicators of physical and mental development of children will improve. Specifically, indicators of coordination abilities and ability to switch attention. The new research is relevant and promising for further directions

in the study of mental processes and physical abilities of schoolchildren.

**Conflicts of Interest:** There is no conflict of interest

**Source of Funding:** Self-funding

**Ethical Clearance:** All procedures performed in studies involving human participants were in accordance with the ethical standards of the institutional and/or national research committee and with the 1964 Helsinki declaration and its later amendments or comparable ethical standards. Informed consent was obtained from all individual participants included in the study.

## Reference

1. Wallhead T, Garn A, Vidoni C. Sport Education and social goals in physical education: relationships with enjoyment, relatedness, and leisure-time physical activity. *Physical Education and Sport Pedagogy* 2012; 18(4):427-441. <https://doi.org/10.1080/17408989.2012.690377>
2. Chen S, Kim Y, Gao Z. The contributing role of physical education in youth's daily physical activity and sedentary behavior. *BMC Public Health* 2014; 14. <https://doi.org/10.1186/1471-2458-14-110>
3. Lyakh VI. Physical culture. Grades 1-4: Textbook for general education institutions. – Moscow: Education. 2013; 190 p.
4. Chiodera P, Volta E, Gobbi G, Milioli MA, Mirandola P, Bonetti A, Delsignore R, Bernasconi S, Anedda A, Vitale M. Specifically designed physical exercise programs improve children's motor abilities. *Scandinavian Journal of Medicine and Science in Sports* 2008; 18(2):179-187. <https://doi.org/10.1111/j.1600-0838.2007.00682.x>
5. Dobbins M, Husson H, DeCorby K, LaRocca RL. School-based physical activity programs for promoting physical activity & fitness in children and adolescents aged 6 to 18. *Cochrane Database of Systematic Reviews* 2013; 2. <https://doi.org/10.1002/14651858.CD007651.pub2>
6. Polevoy GG. Development of Coordination Abilities with Use of Classic's Exercises. *International Journal of Medical Research & Health Sciences* 2019; 8 (12): 41-45
7. Barker D, Quennerstedt M, Annerstedt C. Learning through group work in physical education: a symbolic interactionist approach. *Sport, Education*

- and Society 2015; 20(5):604-623. <https://doi.org/10.1080/13573322.2014.962493>
8. Kühnhausen J, Dirk J, Schmiedek F. Individual classification of elementary school children's physical activity: A time-efficient, group-based approach to reference measurements. *Behaviour Research Method* 2016; 49(2):685-697. DOI: 10.3758/s13428-016-0724-2
  9. Bokin, A. Influence of coordination abilities of young karatekas on productivity of their sports activity. *Social-economic phenomena and process* 2013; 12(58):198-201. DOI: 10.3200/JMBR.40.5.400-408
  10. Tuchak O. Influence of Coordination Exercises on Elementary Schoolchildren with Mental Retardation. *Novelty. Physical Education, Sports and Health Culture in Modern Society* 2018; 42(2):78-85. <https://doi.org/10.29038/2220-7481-2018-02-78-85>
  11. Erceg M, Zagorac N, Katić R. The impact of football training on motor development in male children. *Collegium antropologicum* 2008; 32(1):241-247.
  12. Matulaitis K, Skarbalius, A. Study of the Phenomenon of Sensitive Periods for Development of Velocity and Agility in Young Basketball Players (Aged 7–17). *Theory and Practice of Physical Culture* 2013; 1.
  13. Charles HZ, Megan RG, Robert BM, Jana MK, Nathan AF. Sensitive Periods. *Monographs of the society for research in child development* 2011; 76(4):147-162. <http://doi.org/10.1111/j.1540-5834.2011.00631.x>
  14. Bidzan-Bluma I, Lipowska M. Physical Activity and Cognitive Functioning of Children. *International journal of environmental research and public health* 2018; 15(4):800 <http://doi.org/10.3390/ijerph15040800>
  15. Pietsch, S, Böttcher, C, Jansen P. Cognitive Motor Coordination Training Improves Mental Rotation Performance in Primary School-Aged Children. *Mind, Brain, and Education* 2017; 11(4):176-180 <https://doi.org/10.1111/mbe.12154>
  16. Esteban-Cornejo I, Tejero-González CM, Martínez-Gomez D, Cabanas-Sánchez V, Fernández-Santos JR, Conde-Caveda J, Sallis JF, Veiga OL. Objectively measured physical activity has a negative but weak association with academic performance in children and adolescents. *Journal Acta Paediatrica* 2014; 103(11):501-506. <https://doi.org/10.1111/apa.12757>
  17. Polevoy GG. Training of motor rhythm in students, practicing football. *Physical education of students* 2017; 21 (4):189-192. <https://doi.org/10.15561/20755279.2017.0407>
  18. Nemov R.S. Psychology. Psychodiagnostics. Introduction to scientific psychological research with elements of mathematical statistics – Moscow: Vlado 2003; 640 p
  19. Khusainova RM, Shilova ZV, Curteva OV. Selection of appropriate statistical method for research results processing. *Mathematics Education* 2016; 11(1):303-315. DOI: 10.12973/iser.2016.21030a
  20. Gerber M, Kalak N, Lemola S, Clough PJ, Pühse U, Elliot S, Holsboer-Trachsler E, Brand S. Adolescents' exercise and physical activity are associated with mental toughness. *Mental Health and Physical Activity* 2012; 5(1): 35-42. <https://doi.org/10.1016/j.mhpa.2012.02.004>
  21. Chang EC-H, Chu C-H, Karageorghis CI, Wang CC, Tsai JH-C, Wang Y-S, Chang Y-K. Relationship between mode of sport training and general cognitive performance. *Journal of Sport and Health Science* 2017; 6(1):89-95. <https://doi.org/10.1016/j.jshs.2015.07.007>
  22. Trudeau F, Shephard RJ. School physical activity, school sports and academic performance. *International Journal of Behavioral Nutrition and Physical Activity* 2008, 5. <https://doi.org/10.1186/1479-5868-5-10>

# Effectiveness of Teaching and Text Message Based Intervention on Dietary Habits among Overweight Adolescents in Selected Schools of Ambala, Haryana

Pooja<sup>1</sup>, Kanika<sup>2</sup>, Srinivasan P.<sup>3</sup>

<sup>1</sup>Former M.Sc. Nursing Student, Department of Child Health Nursing, M.M. College of Nursing, Maharishi Markandeshwer University, Mullana-133207, Haryana, India, <sup>2</sup>Professor, Department of medical surgical nursing, M.M College of nursing, Maharishi Markandeshwer University, Mullana-133207, Haryana, India, <sup>3</sup>Nursing tutor, College of nursing, AIIMS, Patna, India

## Abstract

**Background:** Overweight and obesity is associated with an increased risk of morbidity and mortality as well as reduced life expectancy.

**Objectives:** The objectives of the study was to assess and compare the dietary habits among overweight adolescents before and after teaching and text message based intervention in experimental and comparison group, to determine the association of dietary habits among overweight adolescents with their selected variables in experimental and comparison group.

**Methodology:** A quasi experimental non equivalent control group pretest-posttest design was used for the study. Fifty nine (59) overweight adolescents were selected by using purposive sampling technique. The data was collected by rating scale to assess the dietary habits for overweight.

**Results and Conclusion:** The findings revealed that mean post test score of dietary habits ( $29.5 \pm 2.55$ ) was significantly higher in experimental group than mean post test score of dietary habits. There was a significant association found between post test of dietary habits of experimental group with BMI ( $p=0.02$ ) and with age ( $p=0.05$ ) in comparison group. It was concluded from the study that teaching and text message based intervention was effective in improving the dietary habits among overweight adolescents.

**Keywords:** *Dietary habits, overweight adolescents, teaching and text message based intervention.*

## Introduction

Obesity is an independent risk factor for CVD. Obesity is associated with an increased risk of morbidity and mortality as well as reduced life expectancy. The last two decades of the previous century have witnessed dramatic increase in health care costs due to obesity and related issues among children and adolescents.<sup>1</sup>

The number of overweight or obese infants and young children (aged 0 to 5 years) increased from 32 million globally in 1990 to 42 million in 2013. In the WHO African Region alone, the number of overweight or obese children increased from 4 to 9 million over the same period. The vast majority of overweight or obese children live in developing countries, where the rate of increase has been more than 30% higher than that of developed countries. If current trends continue, the number of overweight or obese infants and young children globally will increase to 70 million by 2025. Without intervention, obese infants and young children will likely continue to be obese during childhood, adolescence and adulthood. Obesity in childhood is associated with a wide range of serious health

---

### Corresponding Author:

#### Pooja

Former M.Sc. Nursing Student, Department of Child Health Nursing, M.M. College of Nursing, Maharishi Markandeshwer University, Mullana-133207, Haryana, India

complications and an increased risk of premature onset of illnesses, including diabetes and heart disease.<sup>2</sup>

With a rapid demographic and socioeconomic transition, India is becoming the epicenter of epidemics of both adult and childhood obesity, especially in urban populations. Although the age-standardized rates are low, but in absolute terms, India is the country with the third-highest level of obesity in the world. Over the years, epidemiological studies have reported a consistent increase in the prevalence of childhood overweight and obesity in the subcontinent.<sup>3</sup>

This rising trend in developing countries is largely due to rapid urbanization and mechanization which led to reduction in energy expenditure along with increase in energy intake in the form of high calorie snack and junk food.<sup>4</sup>

Overweight and obesity result from an energy imbalance. The body needs a certain amount of energy (calories) from food to keep up basic life functions. Body weight tends to remain the same when the number of calories eaten equals the number of calories the body uses or “burns.” Over time, when people eat and drink more calories than they burn, the energy balance tips toward weight gain, overweight, and obesity. Children need to balance their energy too, but they are also growing and that should be considered as well. Energy balance in children take place when the amount of energy taken in the form of food or drink and used by the body in natural growth without promoting excess weight gain. Many factors can lead to energy imbalance and weight gain. They include genes, eating habits, how and where people live, attitudes and emotions, life habits, and income.<sup>5</sup>

More and more children and teenagers nowadays are becoming a prey to bad eating habits and tend to consume fast foods instead of eat a healthy diet. These junk foods which are rich in fast carbohydrates and fat are considered as the major reason for childhood obesity. Nowadays, children spend much of their time in front of the TV or on their gaming consoles instead of taking part in exercise, which causes them to gain extra pounds.<sup>6</sup>

Recent research finds that adolescents are following poor dietary habits and on a routine basis which is a contributing factor for them becoming overweight.

Fast foods affect children and youth often worse than adults. This is because most of the fast foods

are targeted towards children and there is a sustained pattern of eating fast foods and eating out. Children with a sustained excess energy imbalance, intake of approximately 2% result in the development of obesity over time. A 2% imbalance could mean an excess of only about 30 kilocalories per day. This corresponds to two-thirds of a chocolate cookie, fewer than two French fries or one-fourth of a can of soda. Eating out is another major contributor to childhood obesity. Studies show that calorie content of out-of-home meals that children consumed was 55% higher than that of in-home meals.<sup>7</sup>

By 2025, India will have over 17 million obese children and stand second among 184 countries where the number of obese children are concerned, says a study published in *Pediatric Obesity*, an international journal. According to Global Burden of Disease collaborative for 2000 and 2013, estimated that by 2025, some 268 million children, aged between five and 17 years, may be overweight, assuming that no policy interventions have proven effective at changing the current trend. China has the largest number of children who are obese. The estimation of the likely numbers of children in 2025 with obesity-related comorbidities: impaired glucose tolerance (12 million), type 2 diabetes (4 million), hypertension (27 million) and hepatic steatosis (38 million). The global overweight prevalence for children aged 5–17 years rising from 13.9% in 2010 to 15.8% in 2025. On the assumptions of continued population growth given by the World Bank, this translates to a rise from some 219 million children in this age group in 2010 to 268 million children in 2025. Obesity alone rises from 76 million children (4.8%) in 2010 to 91 million (5.4%) by 2025.<sup>8</sup>

A cross - sectional study was conducted on Fast Food Consumption, Quality of Diet, and Obesity among Isfahanian Adolescent Girls. Results showed that individuals in the highest quartile of fast food intake had significantly lower NARs for vitamin B<sub>1</sub> (P = 0.008), phosphorus (P = 0.0250), selenium (P < 0.001) and vitamin B<sub>2</sub> (P = 0.012) compared with those in the lowest quartile. Those in top quartile of fast food intake consumed more energy-dense diets than those in the bottom quartile (P = 0.022). High intakes of fast foods were significantly associated with overweight (top quartile: 40% versus bottom quartile: 0%, P = 0.0001) and obesity (11.4% versus 2.9%, P = 0.0001).<sup>9</sup>

**Material and Method**

The study was conducted in January 2017 in the state Haryana, India. A sample of 60 (analyzed 59 due to attrition of one adolescent) overweight adolescents (13-16 years of age) participated in the study with the prior permission from the Principals of participating schools. The *ethical clearance* was obtained from university research ethics committee of Maharishi Markandeshwar University Mullana, Ambala (MMU/IEC/775) and the study was carried out in accordance with the guidelines laid by Indian Council for Medical Research ICMR (2006). The assent was taken from the overweight adolescents and telephonic consent was taken from the parents prior to the study. A quasi experimental Non Equivalent Control Group Pretest-Posttest Research Design was used in this study. The overweight adolescents who were in the age group of 13-15 years and were studying in selected schools of Mullana/Ambala and were available to be accessed as study subjects. The overweight adolescents who were not regular to school were excluded from the study. Fifty nine (59) overweight adolescents were enrolled in the study. Out of which 30 were enrolled in experimental group and 29 were enrolled in comparison group on convenient basis. Data was collected by using **rating scale** to assess dietary habits for overweight. Reliability of the tool was established by Cronbach’s alpha and was found to be 0.74 (acceptable range is 0.07-1.00).

**Statistical Analysis:** According to the objectives, hypothesis of the study and opinion of the expert, it was planned to organize, analyze and interpret the data by using both descriptive and inferential statistics

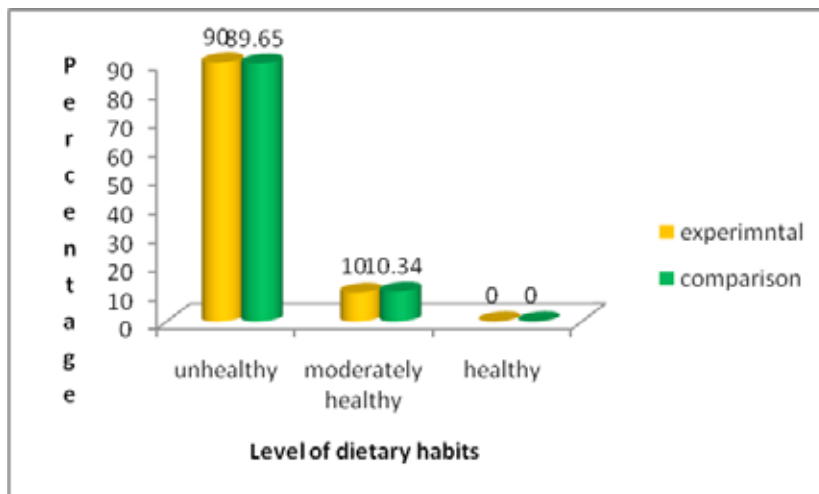
i.e. frequency, mean, median, standard deviation, chi-square, ANOVA and ‘t’ test.

**Results and Discussions**

Homogeneity between the experimental and comparison group was checked by  $x^2$  test in terms of selected variables that is age, gender, religion, total family income per month (in rupees), number of siblings, birth order, type of family, dietary habits, kind of medication taken, other health risk habits, mother’s educational status, father educational status, mother’s occupation, father’s occupation, place of living, height, weight, Body Mass Index. There was no significant difference between experimental and comparison group in terms of selected variables at 0.05 level of significance which infer that both the groups were homogenous in terms of selected variables except number of siblings (p=0.01), mother’s educational status (p=0.004) and place of living (p=0.00).

There was no significant difference between experimental and comparison group in terms of selected variables at 0.05 level of significance which infer that both the groups were homogenous in terms of selected variables except number of siblings (p=0.01), mother’s educational status (p=0.004) and place of living (p=0.00).

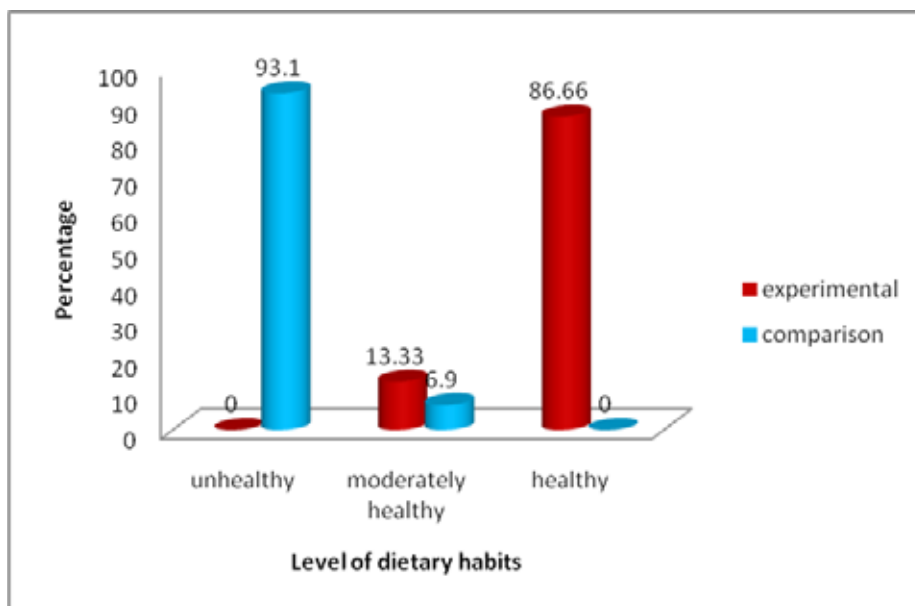
Percentage distribution of experimental and comparison group in terms of level of dietary habits is shown in figure 1. Majority of overweight adolescents in both experimental and comparison group were following unhealthy dietary habits i.e. 90% and 89.65% respectively.



**Figure 1: Pre test score of level of Dietary Habits before Administration of Teaching and Text Message Based Intervention**

Majority of overweight adolescents in experimental group were following healthy dietary habits i.e. 26(86.66%) whereas in comparison group majority of

adolescents were following unhealthy dietary habits i.e. 27(93.1%) after administration of teaching and text message based intervention. [Figure 2].



**Figure 2: Post test score of level of Dietary Habits after Administration of Teaching and Text Message Based Intervention**

In order to find out the significant difference between experimental and comparison group in dietary habits after teaching and text message based intervention

independent ‘t’ test was applied which is shown in table 1.

**Table 1: Mean score of dietary habits after teaching and text message based intervention among overweight adolescents in experimental and comparison group N=59**

Variable	Group	Mean	M <sub>D</sub>	SD <sub>D</sub>	SE <sub>MD</sub>	‘t’ value	p value
Dietary Habits	Experimental (n=30)	29.53				19.44	0.001*
	Comparison (n=29)	13.10	16.43	5.97	2.34		

‘t’(57)= 2.00\* - significant (p ≤0.05)

The table shows that there was a significant difference between experimental and comparison group in dietary habits after teaching and text message based intervention as computed ‘t’ value **19.44** was higher than the tabulated ‘t’ value (**2.00**) at 0.05 level of significance.

Further, paired ‘t’ test was applied to find out the significant difference within the experimental group which is shown in table 2.

**Table 2: Mean pre test and post test scores of dietary habits among overweight adolescents in experimental group n=30**

Variable	Assessment	Mean	M <sub>D</sub>	SD <sub>D</sub>	SE <sub>MD</sub>	‘t’ value	P value
Dietary habits	Pre Test	13.60				19.58	0.001*
	Post Test	29.53	15.93	4.46	0.81		

‘t’(57)= 2.05\* - significant (p ≤0.05)

The table shows that there was a significant difference between pre test and post test in dietary habits in experimental group as calculated 't' values was 19.58,  $p=0.001$  which was higher than the tabulated values (2.05) at 0.05 level of significance.

In order to find out the association of dietary habits among overweight adolescents with their selected variables one way ANOVA and 't' test were applied as shown in table 3.

**Table 3: ANOVA and 't' test value showing association of dietary habits among overweight adolescents with selected variables N=59**

S.No.	Variable	Mean	F/t	p value
<b>Experimental group (n=30)</b>				
1.	<b>Body mass index (BMI)</b>			
1.1	Overweight	30.00	2.40	0.02*
1.2	Obese	27.20		
<b>Comparison group (n=29)</b>				
2.	<b>Age</b>			
2.1	13	13.33	3.27	0.05*
2.2	14	11.93		
2.3	15	17.67		

t (28)= 2.00, t(27)=2.05 \*- significant ( $p\leq 0.05$ )

There was no significant association of dietary habits with selected variables was found except body mass index i.e.  $p=0.02$  which was found to be significant at 0.05 level of significance. Similarly, in comparison group all variables found to be non- significant except age i.e.  $p=0.05$  which was found to be significant at 0.05 level of significance. Hence, dietary habits of overweight adolescents were dependent on BMI and age.

Additionally, Post Hoc test was applied to reveal the mean difference of significant association in comparison group (age group) which is shown in table 4.

**Table 4: Post hoc test showing significant mean difference in association of Dietary Habits for Overweight with selected Variables (age in comparison group) n=29**

S.No.	Selected variable	Category	MD	SE	p value
1.	Age	13 Vs 14	1.40	1.39	0.58 <sup>NS</sup>
		13 Vs 15	-4.33	2.29	0.16 <sup>NS</sup>
		14 Vs 15	-5.73	2.26	0.04*

<sup>NS</sup>- non significant ( $p>0.05$ ), \* - significant ( $p\leq 0.05$ )

It concluded that age group of 15 had healthy dietary habits than the age group of 14.

## Discussion

The present study aims to evaluate the effectiveness of teaching and text message based intervention on dietary habits among overweight adolescents in selected schools of Ambala, Haryana.

In the present study, more than half of the overweight adolescents in experimental and less than half of overweight adolescents in comparison group were in the age group of 14 i.e. 16(53.3%) and 14(48.3%) respectively. More than half of the overweight adolescents in experimental group were males 19(63.3%) whereas in comparison group most of the overweight adolescents were females 17(58.6%). These findings are contradictory to a cross-sectional study conducted by Natalija Smetanina, Edita Albaviciute, Veslava Babinska et al (2010) on Prevalence of overweight/obesity in relation to dietary habits and lifestyle among 7–17 years old children and adolescents in Lithuania. The study results showed that overweight, and obesity among boys and girls was 12.6 and 12.6 % ( $p>0.05$ ), and 4.9 and 3.4 % ( $p<0.05$ ), respectively. Obesity was significantly more prevalent in the 7–9 years old group (6.7 and 4.8 % in boys and girls, respectively,  $p<0.05$ ).<sup>10</sup>

In the present study, in dietary habits, there was a significant association among overweight adolescents with all variables except body mass index i.e. in experimental group and age in comparison group were found to be significant. The study findings were equally supported and contradictory to a cross-sectional study conducted by Natalija Smetanina, Edita Albaviciute, Veslava Babinska et al (2010) on Prevalence of overweight/obesity in relation to dietary habits and lifestyle among 7–17 years old children and adolescents in Lithuania. Lower meals frequency and breakfast skipping were directly associated with overweight/obesity ( $p<0.05$ ).<sup>10</sup>

## Conclusion

There was a significant difference in the mean score of dietary habits before and after teaching and text message based intervention. Hence, teaching and text message based intervention was effective in improving the dietary habits among overweight adolescents.

**Acknowledgement:** The authors express their deepest sense of gratitude to Mr. Dhanesh Garg

(Associate Professor, department of Statistics) M.M. College of Nursing (Mullana, Ambala), Principals of both the schools and genuine thanks to Mr. Asir John Samuel, Assistant Professor, Maharishi Markandeshwar Institute of physiotherapy and Rehabilitation, Maharishi Markandeshwar University for timely support in completion of the study.

**Ethical Consideration:** The ethical clearance was obtained from university research ethics committee of Maharishi Markandeshwar University Mullana, Ambala (MMU/IEC/775) and the study was carried out in accordance with the guidelines laid by Indian Council of Medical Research ICMR (2006). The permission was taken to conduct the study in the MM International School, Mullana and The S.D. Vidya School, Ambala Cantt (from Principals of the Schools). The assent from children and telephonic consent from their parents was collected prior to the study. The purpose for carrying out research project was explained and assurance of confidentiality was given to the participants.

**Source of Funding:** Self

**Conflict of Interest:** Nil

### References

1. G. Wang, W. H Dietz. Economic burden of obesity in youths aged 6 to 17 years: 1979-1999. *national journal of medicine* 2002; 109(5): 81-1.
2. WHO. Facts and figures on childhood obesity. <http://www.who.int/end-childhood-obesity/facts/en/>(accessed 2017).
3. Marie Ng, Tom Fleming, Margaret Robinson, et. al. Global, regional, and national prevalence of overweight and obesity in children and adults during 1980-2013: a systematic analysis for the Global Burden of Disease Study 2013. *Lancet* 2014; 384(9945): 766-81.
4. S Bhardwaj, A Misra, L Khurana, S Gulati, P Shah and NK Vikram. Childhood obesity in Asian Indians: a burgeoning cause of insulin resistance, diabetes and sub-clinical inflammation. *Asia Pac J Clin Nutr* 2008; 17(SI): 172-175.
5. National Institutes of Health. Clinical guidelines on the identification, evaluation, and treatment of overweight and obesity in adults: The evidence report. National Heart, Lung, and Blood Institute; September 1998. NIH Publication No. 98-4083. Available online: <http://www.nhlbi.nih.gov/health-pro/guidelines/archive/clinical-guidelines-obesity-adults-evidence-report>.
6. Common Causes of Childhood Obesity. Available from <http://www.newkidscenter.com/Causes-of-Childhood-Obesity.html>
7. Dr. Kalpna Mandal. Obesity and fast food. Available from: <http://www.news-medical.net/health/Obesity-and-Fast-Food.aspx>
8. Hindustan times. 17 million obese children in India by 2025:International journal', hindustan times. Available from: <http://www.hindustantimes.com/mumbai-news/17-million-obese-children-in-india-by-2025-international-journal/storyvTSZnYhFIWTjgKwSg5J2AL.html>
9. Mohammad H. Rouhani, Maryam Mirseifinezhad, Nasrin Omrani, Ahmad Esmailzadeh and Leila Azadbakht. Fast Food Consumption, Quality of Diet, and Obesity among Isfahanian Adolescent Girls. *Journal of Obesity* 2012; 2012.
10. Natalija Smetanina, Edita Albaviciute, Eslava, et.al. Prevalence of overweight/obesity in relation to dietary habits and lifestyle among 7-17 years old children and adolescents in Lithuania. *BMC Public health* 2015; 15(1001).



# Changing Trends Inpoisoning at a Tertiary Healthcare Centre in North Karnataka, India

Pratibha R. Kulkarni<sup>1</sup>, Ranganath R. Kulkarni<sup>2</sup>, R.B. Kotabagi<sup>3</sup>

<sup>1</sup>Assistant Professor, Department of Forensic Medicine, <sup>2</sup>Associate Professor, Department of Psychiatry, <sup>3</sup>Professor and Head, Department of Forensic Medicine, Shri Dharmasthala Manjunatheshwara University, Dharwad-580009, India

## Abstract

**Background:** Acute poisoning is a medical emergency as well as a major public health problem as it leads to significant burden on healthcare services. It is pertinent to know the nature and outcome of poisoning for effective prevention and management strategies.

**Method:** A comparative retrospective analysis of 622 poisoning cases admitted to a tertiary care hospital during the period from 2011-12 and 2018-19 were compared to assess the age, sex, mode of poisoning and the nature of the poisonous substance.

**Conclusion:** The study reveals a sharp increase in the acute poisoning cases and changing trends of commonly used poisons with passage of time. Although, males outnumbered females, a steep rise in female poisoning cases, with majority (60%) being young adults especially in the age group of 21-30 years is alarming. Suicide was the most common manner of poisoning, while organophosphates and medicinal drugs were the most commonly used substances.

**Keywords:** Drug overdose; Organophosphates; Pesticides; Poisoning; Prescription drug misuse; Suicide.

## Introduction

Poison and poisoning are known to mankind since times immemorial. Mortality and morbidity due to acute poisoning has tremendous medical, legal and social significance. Intentional ingestion of pesticides is estimated to account for one in five of all suicides globally.<sup>1</sup> India, being mainly an agrarian country, with majority of the population belonging to rural areas, has witnessed poisoning due to conventional insecticides like organophosphates. However, in the past few years, with the advent of newer agricultural poisons and easy

availability of pharmacological products to an educated population, remarkable changes have occurred in the trends of acute poisoning. The present day poisoning trends pose a challenge in the diagnosis, treatment and availability of analytical facilities in developing countries.

The changing trends need to be studied on regional basis as knowledge of the general patterns of poisoning in a particular region would help in proper healthcare policy planning, so as to equip the healthcare centres for early diagnosis and effective treatment, which in turn would result in a reduction in morbidity and mortality. The present study was an attempt to analyze the change in the commonly used poisonous substances across two time periods.

## Materials and Method

The present study is a comparative, retrospective chart review across two time periods. All cases of poisoning admitted to SDM College of Medical

---

### Corresponding Author:

**Dr. Pratibha R. Kulkarni**

Assistant Professor, Department of Forensic Medicine,  
SDM College of Medical Sciences and Hospital,  
Shri Dharmasthala Manjunatheshwara University,  
Dharwad-580009, India  
e-mail: pratibha\_ak@rediffmail.com

Sciences and Hospital, a tertiary healthcare centre at Dharwad, Karnataka from January 2011 to December 2012 and January 2018 to December 2019 were included for the study. Cases due to snake bite envenomation and/or other insect bites were excluded from the study. Socio-demographic details such as age, gender, marital status, occupation, manner of poisoning and type of poisonous substance consumed were collected from the hospital records. Data was tabulated and analysed using descriptive statistics with statistical significance of  $p$  value at  $<0.05$ . Chi-square test was applied to compare the groups and sub-groups depending on nature of the variables involved. Ethical clearance for the study was obtained from the Institutional Ethics Committee.

## Results and Discussion

A total of 2963 medico-legal cases were registered during the period 2011-12, of which poisoning cases accounted for 6.88% ( $n=204$ ), in comparison to 4697 medico-legal cases during the years 2018-19 where poisoning cases accounted for 8.9% ( $n=418$ ), suggesting a significant rise of 2.02% in poisoning cases during 2018-19 ( $\chi^2=3.89$ ;  $df=1$ ;  $p<0.05$ ). This sharp uptrend in the recent years could be due to various reasons like rising population, increasing demands, competition amongst people to perform better, work pressure, intra/inter-personal conflicts thereby leading to frustration intolerance, rejection sensitivity, depression and suicidal tendencies.

Young adults formed the majority in both the groups accounting for one-third of the cases, with most common age group being 21-30 years [Table 1], which is in concordance with most Indian studies like that done in south India,<sup>2</sup> and that done in north India,<sup>3</sup> possibly due to stressors like professional failure, failure in love or competitive exams, and family discordance suffered by people in this age group.

Of a total 622 poisoning cases, males ( $n=329$ ; 52.89%) outnumbered females ( $n=293$ ; 47.11%) during both the time periods. The higher incidence in males could be due to the fact that males are more exposed to stress and strain due to financial difficulties, workplace stress and/or discord at home. This is in concordance with other Indian studies.<sup>4,5</sup> During the years 2011-12, males ( $n=114$ ; 55.89%) outnumbered females ( $n=90$ ; 44.11%) with a ratio of 1.26:1, in comparison to males ( $n=215$ ; 51.43%) and females ( $n=203$ ; 48.57%), with a ratio of 1.05:1 during the years 2018-19. This finding showed

statistical significance across age groups in total cases ( $\chi^2=15.04$ ;  $df=6$ ;  $p<0.05$ ) and female gender ( $\chi^2=18.59$ ;  $df=6$ ;  $p<0.05$ ), but not in males ( $\chi^2=3.19$ ;  $df=6$ ;  $p>0.05$ ) [Table 1]. This implies rising trends of poisoning cases across all age groups, especially in female gender in recent years, thereby suggesting females as almost equally affected as males. As majority of females in present study were housewives, possibly they were prone to suffer from loneliness and depression, alcoholism by husband, financial difficulties, abuse by spouse or in-laws in connection with dowry, etc. This finding is in agreement with an Indian study that reported females as being the commonest victims.<sup>6</sup>

Poisoning was more common in the married group in both time periods, although statistically no significant difference was found between two time periods [Table 1]. This finding is consistent with studies done in other parts of India as well.<sup>7,8</sup> This may imply that maladaptive stressful marital life can act as a triggering factor for suicidal behaviour in vulnerable individuals, especially in the Indian context where an early marriage along with its added familial responsibilities can be synergistic factor.

In present study, self-ingestion was the commonest manner of poisoning, especially among adults and elderly; only few were accidental (especially among children) and none were homicidal in both the groups [Table 1]. This is in agreement with other Indian studies.<sup>3,9</sup> Possibly, people resort to suicidal attempts by poisoning due to many reasons like easy availability and accessibility to poisonous substances, lower need for strenuous efforts compared to other suicidal acts, their belief that poison terminates life with minimal suffering. It is also quite possible that few amongst accidental poisoning victims might have under reported their suicidal behaviour due to sensitivity of stress, social stigma of suicide and fear of legal procedures thereto. However, in an Indian study although majority of the poisoning cases were accidental in nature, deaths were more in poisoning of suicidal manner.<sup>5</sup> This may be due to the differences in study design, psychiatric consultation, tactic eliciting of clinical history and stressful factors that have major influences in categorising the manner of poisoning act as suicidal or accidental or homicidal.

During the years 2011-12, majority of the poisoning cases were farmers ( $n=57$ ; 27.94%) compared to housewives ( $N=140$ , 33.49%) during the years 2018-19 [Table 2]. There was a statistically significant difference

between the two study periods in relation to occupation and poisoning. India being an agrarian country, farmers have easy access and occupational exposure to the poisonous substances like pesticides, insecticides, or rodenticides and thus are commonly affected victims. In the recent years, with increasing incidence of poisoning in the female population, housewives comprised the vulnerable group. However, some Indian studies reported manual labourers to be more commonly affected than others,<sup>4,10</sup> while another Indian study reported students and unemployed youths as the most common victims<sup>11</sup>. These differences can be due to different study settings and methodologies.

Organophosphorus compound was the commonest poison in both the time periods, owing to its easy availability [Fig. 1]. This finding is consistent with most of the Indian studies,<sup>5,10</sup> although studies from northern parts of India have reported aluminium phosphide as a common cause of poisoning<sup>8</sup>. Rise in drug overdose cases is gaining popularity in recent years as a means of poisoning in majority of victims in their second and third decades, especially in students and housewives.<sup>12</sup> This could possibly be due to easy availability and accessibility to all types of medicines over the counter

with no strict law enforcement to check prescription delivery, and risk factors like academic stress, unhealthy competition, failure in relationships, and family conflicts. Such individuals are prone for depression and have an access to psychiatric drugs. Common tablets that were consumed included psychotropic medications (benzodiazepines, anti-depressants, anti-psychotics, carbamazepine, valproate), paracetamol and antihypertensives. This study also observed a rising trend in consumption of non-conventional, local-made pesticides that have no mention of the ingredients leading to therapeutic challenges that funnel mostly on clinical presentation.

During the years 2011-12, mortality was noted in 14 cases (6.9%), of which 12 cases (85.71%) were due to organophosphate poisoning, compared to 28 cases (6.7%) during in the years 2018-19, of which 17 cases (60.71%) were due to organophosphorus poison and 6 cases (21.43%) due to other pesticides. Although some studies have reported higher mortality rate of 15%,<sup>4,10</sup> lower mortality in our study could be due to early accessibility to health centre, early therapeutic interventions and sophisticated tertiary care centre facility.

**Table 1: Changing trends in socio-demographic characteristics of poisoning cases by gender distribution.**

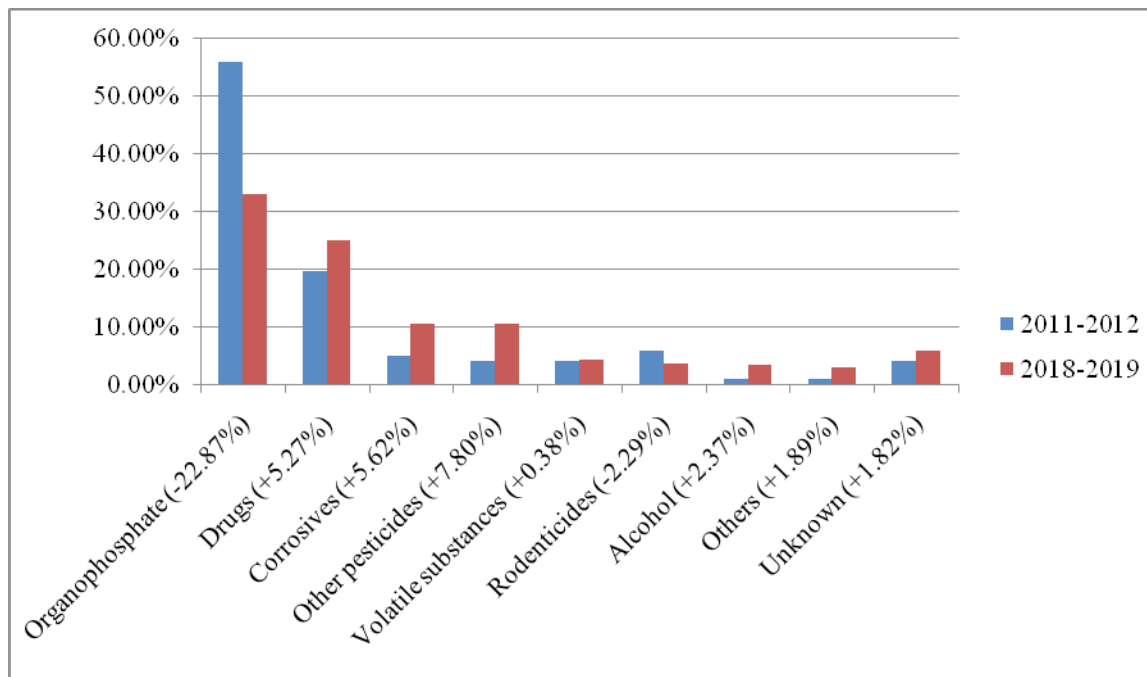
Variables	2011-12			2018-19			Statistics p<0.05 significant	
	Males n=114 (%)	Females n=90 (%)	Total n=204 (%)	Males n=215 (%)	Females n=203 (%)	Total n=418 (%)		
Age in years	< 10	6 (5.26)	0 (0)	6 (2.94)	12 (5.58)	10 (4.93)	22 (5.26)	$\chi^2$ for males=3.19, df=6, p>0.05, NS*; $\chi^2$ for females=18.59, df=6, p<0.05, significant. $\chi^2$ for total cases=15.04, df=6, p<0.05, significant.
	11-20	18 (15.79)	32 (35.56)	50 (24.52)	34 (15.81)	47 (23.15)	81 (19.38)	
	21-30	56 (49.12)	44 (48.89)	100 (49.02)	89 (41.40)	75 (36.95)	164 (39.23)	
	31-40	16 (14.04)	6 (6.67)	22 (10.78)	43 (20.00)	37 (18.23)	83 (19.86)	
	41-50	10 (8.77)	4 (4.44)	14 (6.86)	18 (8.37)	16 (7.88)	34 (8.12)	
	51-60	4 (3.51)	2 (2.22)	6 (2.94)	7 (3.26)	10 (4.93)	17 (4.07)	
	> 61	4 (3.51)	2 (2.22)	6 (2.94)	12 (5.58)	8 (3.94)	20 (4.78)	
Marital status	Married	62 (54.39)	60 (66.67)	122 (59.80)	105 (48.84)	143 (70.44)	248 (59.33)	$\chi^2$ for males=0.92, df=1, p>0.05, NS $\chi^2$ for females=0.42, df=1, p>0.05, NS $\chi^2$ for total cases=0.01, df=1, p>0.05, NS
	Single	52 (45.61)	30 (33.33)	82 (40.20)	110 (51.16)	60 (29.56)	170 (40.67)	
Manner of poisoning <sup>^</sup>	Suicidal	96 (84.21)	84 (93.33)	180 (88.24)	182 (84.65)	176 (86.70)	358 (85.65)	$\chi^2$ for males=0.01, df=1, p>0.05, NS; $\chi^2$ for females=2.75, df=1, p>0.05, NS. $\chi^2$ for total cases=0.79, df=1, p>0.05, NS
	Accidental	18 (15.79)	6 (6.67)	24 (11.76)	33 (15.35)	27 (13.30)	60 (14.35)	

\*NS=not significant; ^none of the cases were reported to be homicidal in nature;

**Table 2: Changing trends in distribution of poisoning cases according to occupation**

Occupation	2011-12	2018-19	Percentage change (%)
	n=204 (%)	n=418 (%)	
Farmers	57 (27.94)	120 (28.71)	0.77
Housewives	50 (24.51)	140 (33.49)	8.98
Students	45 (22.06)	105 (25.12)	3.06
Others	28 (13.73)	42 (10.05)	-3.68
Unemployed	24 (11.76)	11 (2.63)	-9.13

$\chi^2 = 26.152$ ,  $df=4$ ;  $p < 0.05$ ; significant (Others - include businessmen, drivers, labourers, teachers and children less than 5 yrs)



$\chi^2 = 41.201$ ,  $df=8$ ,  $p < 0.05$ ; significant (Others - includes plant poisons, glass pieces)

**Figure 1: Changing trends in distribution of poisoning cases by type of poisonous substance**

### Conclusion

The study on changing trend in poisoning will give an idea about the current patterns which would help in early diagnosis by the common clinical manifestations associated with it and will also help in developing the analytical method used for detecting the poison. Rising trend in the number of poisoning cases over the recent years, especially drug overdose and local-made pesticides is quite alarming.

The study also highlights the importance of proper labelling of the ingredients and restricting the sale of non-conventional agricultural poisons along with proper education about safe handling as well as hazards of agricultural poisons. Strict legislative measures must

be implemented regarding the sale of 'over the counter' drugs to tackle the recent rising trend of drug overdose. Epidemiological surveillance is necessary for every region to identify problems prevalent in that region, so that preventive measures can be taken accordingly.

**Conflicts of interest:** Nil

**Source of Funding:** Nil

### References

1. World Health Organization and Food and Agriculture Organisation. Preventing suicide: a resource for pesticide registrars and regulators. Geneva: World Health Organization; Rome: Food

- and Agriculture Organisation of the United Nations [Online]. [2019] [cited 2020 Sept 22]. Available from: URL:<https://apps.who.int/iris/bitstream/handle/10665/326947/9789241516389-eng.pdf>
2. Maharani B, Vijayakumari N. Profile of poisoning cases in a tertiary care hospital, Tamil Nadu, India. *J Appl Pharm Sci* 2013;3(1):91-4.
  3. Sharma BR, Harish D, Sharma V, Vij K. Poisoning in Northern India: changing trends, causes and prevention thereof. *Med Sci Law* 2002;42(3):250-7.
  4. Unnikrishnan B, Singh B, Rajeev A. Trends of acute poisoning in south Karnataka. *Kathmandu Univ Med J* 2005;3;2(10):149-54.
  5. Parekh U, Gupta S. Epidemio-toxicological profile of poisoning cases – a five year retrospective study. *J Forensic Leg Med* 2019;65:124-32.
  6. Singh K, Oberoi SS, Bhullar DS. Poisoning trends in the Malwa region of Punjab. *J Punjab Acad Forensic Med Toxicol* 2003;3:26-9.
  7. Mishra PK, Kulkarni R, Sane MR, Deshpande A, Kushwah M. Prospects of poisoning – a multi-facet study. *Arch Med Sadowej Kryminol* 2016;66:235-43.
  8. Sharma BR. Trends of fatal poisoning in northern India. A ten year autopsy analysis. *Journal of Pharmacology and Toxicology* 2007;2(4):350-8.
  9. Gupta BD, Hapani JH, Shah VN. Current trend of poisoning in Jamnagar: an experience of tertiary care teaching hospital. *J Indian Acad Forensic Med.* 2006;28(3):90-2.
  10. Ramesha KN, Rao KBH, Kumar GS. Pattern and outcome of acute poisoning cases in a tertiary care hospital in Karnataka, India. *Indian J Crit Care Med* 2009;13(3):152-5.
  11. Singh D, Jit MS, Tyagi S. Changing trends in acute poisoning in Chandigarh zone: a 25 year autopsy experience. *American J Forensic Med Pathol* 1999;20(2):145-54.
  12. Nistor N, Jitareanu C, Frasinariu OE, Ciomaga IM, Rugina AL, Streanga V. Epidemiological profile and triggering factors of voluntary poisoning in teenagers. *Medicine* 2017;96(5):1-5.

# Approach to Patients with Hemorrhoids at Our Tertiary Care Centre

Pratik Shaparia<sup>1</sup>, Brijesh Bharodiya<sup>2</sup>, Vipul Gurjar<sup>3</sup>, Honeyपाल H. Maharaul<sup>4</sup>

<sup>1</sup>Assistant Professor, <sup>2</sup>Resident, <sup>3</sup>Professor, <sup>4</sup>Associate Professor, Smt. B.K. Shah Medical Institute and Research Centre, Sumandeep Vidyapeeth Deemed to be University (an Institution), Pipariya Vadodara

## Abstract

Haemorrhoids is considered to be one of the most common surgical condition nowadays. Its prevalence is 4.4% i.e. 10 million world population. The purpose of this study is to observe outcomes of various procedures and conservative management in patients respective to their grades of haemorrhoids. In our setup we used dietary and lifestyle modification, Medications (Topical/Systemic) stapled haemorrhoidopexy, Milligan Morgan Hemorrhoidectomy.

**Keywords:** *Haemorrhoids, Treatment, Outcomes, Complications.*

## Introduction

Haima (bleed) + Rhoos (Flowering) are the greek words for origin of word Haemorrhoids which means bleeding from flowered like structure. 'Pila' is the word of origin for Piles in latin vocabulary<sup>(1)</sup>. Haemorrhoids are normal Vascular tissue within the submucosa located in anal canal<sup>(2)</sup>. Displacement or enlargement of anal cushions results to development of haemorrhoids. Anal Cushions normally resides in left lateral, right anterolateral, right posterolateral and are aggregation of blood vessels (arterioles, venules), smooth muscles and elastic connective tissue in submucosa<sup>(3)</sup>. Many people have features of piles on proctoscopy but may or may not have symptoms so exact prevalence of haemorrhoids is difficult to evaluate. Sometimes patient with portal hypertension develop per rectal bleeding but that is due to rectal varices and not to be confused with haemorrhoids<sup>(4)</sup>. They can be mucosal or vascular. Vascular type is seen in young whereas mucosal in old age people.

Present concept is weakening of Park's ligament which is lower end of external sphincter. Basically, there are 2 types- 1) Internal- Above dentate line, covered with mucous membrane. 2) External- below dentate line, covered with skin. Other way of classification is 1) Primary- located at 3,7,11'0 clock position related to branches of superior hemorrhoidal vessel which divides into 2 branches on right and 1 on left side. 2) Secondary- one which occurs between primary sites.

Grades of haemorrhoids- Grade 1- Piles bleed but doesn't come out. Grade 2- Piles that prolapse during defecation but returns back on its own. Grade 3- Piles that prolapse on defecation and can be replaced back manually. Grade 4- Piles that are permanently prolapse. Specific considerations like acutely thrombosed or strangulated internal haemorrhoids, acutely thrombosed external piles, Pregnancy induced piles, various underlying liver disorders like portal hypertension and cirrhosis, patients on various anticoagulants and antiplatelets medications.

Modes of treatment used are- 1) Dietary and Lifestyle modifications which includes high fibrediet, increase oral fluid intake, and also avoid constipation and cough, Warm Sits bath with anal region dipped in water for 20 minutes, 2-3 times a day 2) Medical Management includes topical application to reduce pain, oedema, itching. Oral Antibiotics, Laxatives, NSAIDs are also used. 3) Stapled Haemorrhoidopexy (Antonio Longo)-

---

### Corresponding Author:

**Dr. Honeyपाल H. Maharaul**

Associate Professor, Smt. B.K. Shah Medical Institute and Research Centre, Sumandeep Vidyapeeth deemed to be University (an Institution), Pipariya Vadodara  
e-mail: honeyपाल.219@gmail.com  
Phone: 9426345105

circumferential excision of mucosa and submucosa 4 cm above dentate line using circular Haemorrhoidal stapler passed per anally (MIPH- Minimally Invasive procedure for haemorrhoids) which is less painful, less blood loss, faster recovery, short hospital stay and equally efficacious. Ring formed as a result of staplers restores the downward displaced tissue back to its place and thus both anatomical and functional integrity is maintained.<sup>(5)</sup> But it need advanced surgical skill experience, costlier, may cause full thickness excision of rectal wall, may injure anal sphincter and improper purstring can cause incomplete doughnut leading to severe haemorrhage and it is contraindicated in associated anorectal diseases like fissure, fistula in ano.

4) Milligan Morgan Open Hemorrhoidectomy which involves ligation and excision of piles and anal mucosa and skin is left open to heal by second intention. Some RCTs and meta-analyses stated that this method is best for patients with recurrent symptoms of grade 3 and 4 Hemorrhoids<sup>(6)</sup>. It is also recommended in patients with mixed grades of hemorrhoids and for patients in whom other treatments failed.<sup>(7)(8)</sup>

Perianal pain while defecation, muscular or sphincter injury, per rectal bleeding, recurrence, bleeding or painful anal fissure, faecal incontinence can occur as post operative complications.

**Materials and Method**

The study is prospective study conducted at Dhiraj general Hospital of 100 patients of haemorrhoids fitting into this study requirements according to inclusion and exclusion criteria.

**Inclusion Criteria:**

1. Patients above 16 years of age of either sex.
2. Suffering from any Grade of Haemorrhoids.
3. Fit for Anesthesia if planned for Surgical Intervention.
4. Patients available for follow up

**Exclusion Criteria:**

1. Cases with active Per anal wound infection.
2. Mentally ill patients/any cognitive impairment.

**Observation and Results**

	Grade 1	Grade 2	Grade 3	Grade 4	Specific considerations
M1	Yes	Yes	Yes	Yes	Yes
M2	Yes	Yes			
M3		Yes	Yes	Yes	
M4		Yes	Yes	Yes	Yes

M1- Dietary and lifestyle modifications, M2- Medical Management, M3- Stapled Haemorrhoidopexy, M4- Milligan Morgan Hemorrhoidectomy



**Figure 1: Showing prolapsed hemorrhoids**



**Figure 2: Showing hemorrhoidal stapler used for stapler haemorrhoidopexy**

### Conclusion

1. Dietary and lifestyle modification is necessary and helpful for all grades and specific considerations.
2. Medical management is useful for only Grade 1 and 2
3. Stapler and Milligan Morgan both are useful in Grade 2,3,4.
4. Only Milligan Morgan Hemorrhoidectomy is useful in Specific considerations.

**Ethical Clearance:** Taken from Sumandeep Vidyapeeth Institutional Ethics Committee

**Source of Funding:** Self

**Conflict of Interest:** Nil

### References

1. Love, Bailey and. Short Practice of surgery. Boca raton : CRC press Taylor & Francis group, 2018.
2. Sabiston. Textbook of surgery. Philadelphia : Elsevier, 2017. ISBN: 978-0-323-29987-9.
3. Love, Bailey and. Short Practice of surgery. Boca Raton : CRC press Taylor & Francis group, 2018.
4. Love, Bailey and. Short Practice of surgery. Boca raton : CRC Press Taylor & Francis Group, 2018.
5. A, Longo. Treatment of hemorrhoidal disease by reduction of mucosa and hemorrhoidal prolapse with a circular suturing devise. Proceedings of the sixth world congress of endoscopic surgery. Rome: s.n., 1998.
6. Acheson AG, Schlofield JH. Management of hemorrhoids. BMJ. 2008.
7. Shanmugan V, Thaha MA, Rabindranath KS, Campbell KL, Steele RJ, Loudon MA. Systematic review of randomized trials comparing rubber band ligation with excisional hemorrhoidectomy. Br J Surg. 2005.
8. Ooi BS, Ho YH, Tang CL, Eu KW, Seow-Cheon F. Results of stapling and Conventional hemorrhoidectomy. Tech coloproctol. 2002.



# Behaviours (Cognitive, Affective and Psychomotor) among Patients with Gout Arthritis in Elderly

Chilyatiz Zahroh<sup>1</sup>, Asmaul Faujiyah<sup>1</sup>, Ima Nadatien<sup>1</sup>, Yasi Anggasari<sup>1</sup>, Nur Ainiyah<sup>1</sup>, Siti Nurjanah<sup>1</sup>

<sup>1</sup>Lecturer, Faculty of Nursing and Midwifery, Universitas Nahdlatul Ulama Surabaya, Surabaya, Indonesia

## Abstract

The phenomenon that occurs in the community at this time, many elderly gout arthritis as many as 41 of 61 elderly people in Posyandu Wonokromo Surabaya Indonesia who still complain of joint pain suddenly and stiffness in the joints that causes limited movement. This study aims to describe the behavior (cognitive, affective, and psychomotor) of patients with gout arthritis in the elderly. The design of this study uses descriptive research with cross sectional approach. The population in this study were 41 elderly with gout arthritis. The sample in this study were all elderly patients with gout arthritis, with a large sample of 41 respondents. Sampling with Total Sampling technique. This research instrument used a questionnaire and data analysis using descriptive statistics. The results showed that of 41 elderly people with gout arthritis almost half had low cognitive behavior (48.7%), almost half had moderate affective behavior (46%), and almost half had moderate psychomotor behavior (46%). The conclusion of the research is that the elderly who suffer from gout arthritis have low cognitive behavior, moderate affective behavior, and moderate psychomotor behavior. It is expected that all elderly people with gout arthritis, in order to always improve their ability and continue to shift information about the disease gout arthritis in order to improve health and change behavior (cognitive, affective, and psychomotor) to be high.

**Keywords:** Behaviours, Elderly, Gout Arthritis.

## Introduction

Staying healthy and happy in old age is a challenge<sup>1</sup>. Elderly tend to experience health problems caused by decreased function due to aging process, therefore the body will accumulate more metabolic and structural distortion called degenerative diseases<sup>2</sup>. Degenerative diseases that are rapidly developing in the elderly present one of which is gout arthritis<sup>3</sup>. Elderly people with Gout arthritis should have a high level of cognitive, affective, and psychomotor behavior in their health. Eating a drink or high food purine (meat, nuts, organ meats, etc.) and a lack of physical activity (exercise) is a negative behavior

and harmful to the health of the elderly people with gout arthritis. In fact, in the community are found many elderly people who are gout arthritis who still consume drinks or food purine high and lazy activities. So many elderly Gout arthritis sufferers still complain of sudden joint pain (big toe joints, ankles, knees, elbows, wrists, and fingers), feel warm, and stiffness in the joints causing limited movement. Eating foods and high food purine and lazy activities is a habit that is bad for health as well as the incidence of gout arthritis disease in elderly in Indonesia tends to increase. Good health behavior in the elderly is required by each community to emphasize and decrease the incidence rate of gout arthritis<sup>4</sup>.

Gout is a term used for a group of metabolic disorders characterized by elevated uric acid concentrations (hyperuricemic). Gout or uric acid is a disease caused by the filling of the monosodium uric crystals in the body, causing joint pain called gout arthritis<sup>4</sup>. Common factors that because gout include lack of sleep, which can lead to lactic acid buildup. When sleeping, there is a breakdown of lactic acid in the body. If a person experiences

---

### Corresponding Author:

**Chilyatiz Zahroh**

Lecturer, Faculty of Nursing and Midwifery,  
Universitas Nahdlatul Ulama Surabaya, Surabaya,  
Indonesia

e-mail: chilyatiz@unusa.ac.id

adequate sleep, the decomposition of lactic acid in the body will be perfect. If a person experiences less sleep, lactic acid has not been perfectly described so that there is a buildup of lactic acid in the body. Buildup of lactic acid in the body can prevent the production of uric acid through urine. Outside factors can be consumption of food and beverages that can stimulate the formation of uric acid such as foods that have high protein levels including nuts, emping, Melinjo, chocolate, and Drink cola. Consuming food of high purine will cause increased levels of uric acid in the blood, which causes the occurrence of crystallization in the joints. Protein especially derived from animals can increase the levels of uric acid in the blood including the liver, kidneys, brain, lung, and Spleen (Helmi, 2012). It affects the daily activities of the elderly<sup>5,6</sup>.

Health research data in east Java province states that 32.7% of joint diseases cause insecurity in the elderly<sup>7</sup>. Based on the initial data retrieval conducted by the researchers on 03 December 2019, in Wonokromo, Surabaya. There is elderly who suffer from gout arthritis disease which is as much as 41 from 61 elderly. The

phenomenon obtained by researchers from interviews in elderly people with gout arthritis, that the behavior of health is still low because the elderly in RW. 05 Wonokromo Surabaya is rarely get information about Gout arthritis disease and low education level. Efforts that can be made to overcome gout arthritis is to change the behavior. Behavior is complex, including cognitive, affective and psychomotor<sup>8</sup>. The purpose of this research was identifying cognitive, affective, and psychomotor behaviors in the elderly with gout arthritis.

## Method

The design of this research uses descriptive research with cross sectional approaches. The population in this study is elderly people with a gout arthritis of 41 elderly. The samples in this study were all elderly sufferers of gout arthritis, with large samples of 41 elderly sufferers of gout arthritis. Sampling with Total Sampling techniques. This research instrument uses questionnaires and data analysis using descriptive statistics. The research variables used are behaviors (cognitive, affective, and psychomotor) sufferers of gout arthritis in elderly.

## Results

**Table 1. Demographic characters of respondents.**

Socio-demography	Category	N	%
Age (years old)	45-59	4	7.3
	60-74	25	61
	75-90	13	31.7
Gender	Male	11	26.8
	Female	30	73.2
Education level	Basic	36	88
	High	5	12
Information about gout arthritis	Ever	15	37
	Never	26	63

**Table 2. Behaviours (cognitive, affective, and psychomotor) among patients with gout arthritis in elderly.**

Variables	Category	Frequency	Percentage (%)
Cognitive	High	3	7,3
	Middle	18	44
	Low	20	48,7
Affective	High	7	17
	Middle	19	46
	Low	15	37

Variables	Category	Frequency	Percentage (%)
Psychomotor	High	6	15
	Middle	19	46
	Low	16	39

## Discussion

**Behavior (Cognitive):** The results of Table 1 study showed that from 41 elderly people with gout arthritis, almost half (48.7%) Elderly Gout arthritis sufferers have low cognitive behaviors. This is demonstrated by the result of recapitulation of data from the Cognitive Questionnaire positive Statement (knowledge and understanding) Number 1, 2, 3, (application) Number 5, (analysis) number 7, (synthesis) Number 10, and (evaluation) Number 11 almost half the elderly sufferers Gout arthritis replied “Disagree”, in accordance with the statement of researchers supposedly elderly people gout arthritis replied “Agree”. Supported by the theory that Gout arthritis is a disease caused by the saving of the monosodium vein in the body, causing joint pain characterized by the presence of redness and feeling hot [8]. Gout arthritis disease can be caused by eating habits of high food purine (beans, melinjo, organ meats) and high-alcoholic beverages (drinks containing alcohol)<sup>8</sup>. Elderly people with Gout arthritis is easy injuries [9], therefore every exercise should be warming up first. If the elderly lifestyle sufferers Gout arthritis well, then the low risk of complications occurs. Eating nutritious food, regular exercise is a behavior with respect to the improvement and maintenance of elderly health patients with Gout arthritis<sup>1,9</sup>.

While on the negative statement (knowledge and understanding) Number 4, (application) Number 6, (analysis) number 8, (synthesis) Number 9, and (evaluation) number 12 almost half the elderly patients Gout arthritis answered “agree”, in accordance with the statement of researchers should elderly people gout arthritis answered “disagree”. Supported by the theory of Fitriana (2015) The endurance of one’s body grows increasingly declining, so that gout arthritis disease is largely suffered by the elderly. The physical and mental health condition of a person affects the health condition of the body, because when a person suffers from a disease there will be mental health decreases (stress) so it can cause new illness or complications<sup>10</sup>.

**Behavior (Affective):** Based on table 1 shows

that of 41 elderly sufferers of gout arthritis, almost half (46%) Have moderate affective behavior. It is indicated by the recapitulation of the data from the affective questionnaire of positive statements (understanding) Number 2, (participation) Number 3, (assessment/determination of Attitude) Number 5, (organization) Number 7, and (the formation of living patterns) Number 9, 10, 12 almost half of the sufferer Gout arthritis in the elderly answered “disagree”, in accordance with the statement researchers should be gout arthritis in elderly answered “agreed”. The elderly experienced a variety of physical and mental changes. Spiritual development in the elderly, among other developments achieved at this level elderly can think and act by giving examples of ways of loving and giving justice. In the elderly there are also changes that require themselves to adapt continuously. If the process of adjusting yourself with the environment is less successful, it will arise problems. The problems and individual reactions to him will vary greatly depending on his personality. The elderly will be pleased when participating in activities held in the elderly Posyandu, because when attending the activities, the elderly can find and observe a variety of new things such as the counseling or sports together. Elderly often feel unconfident in conveying complaints of illness suffered, with the activity can help elderly in presenting related problems or diseases suffered today, so that at home elderly already know what things to obey.

While on the negative statement (understanding) Number 1, (participation) Number 4, (assessment/determination of Attitude) Number 6, (organization) Number 8, and (the formation of living patterns) Number 11 Almost half of the sufferer Gout arthritis in the elderly answered “agree”, in accordance with the statement researchers should be gout arthritis in elderly replied “disagree”. The elderly thinking process is easy to change, so it can be known when the elderly suffers from a disease of a love by people around then the elderly will feel disliked and the elderly are not interested in responding, because the elderly think that he has felt capable in the problems that he suffered. Elderly are also subjected to changes in sensory system especially

in vision, when observing elderly images/objects often have errors in the meaning of them<sup>11</sup>.

Assessment of affective behavior can be seen through the observation method and interviews in patients directly about the appearance, speech, nature of feelings, perception, and others. The decline in the affective behavior will be evident in the elderly (over 60 years). The above theory is in line with the research results showing that 25 respondents (61%) That is 60-74 years old, decreased affective behavior showed slow speech, motor activity: Tick and lethargic and natural feelings of fear and sadness but the affect shown flat. Based on cross-tabulation results between the ages and the most affective behavior (60%) Early age groups (60-64 years) are in medium category. The opinions are also similar in line with those found by Islamic Guidance and Counseling who conducted research at the Tresna Werdha (BPSTW) Protection Hall of Ciparay Bandung, finding some elderly aged over 60 years experiencing decreased affective behavior such as feelings of sadness and fear in the face of diseases that he suffered.

Nurses play an important role in providing teaching or understanding to the elderly about the importance of maintaining mental health in connection with the decline of affective behavior, so that the elderly do not suffer from impaired affective functions such as feelings of sadness and fear during the illness of Gout arthritis. Thus, the elderly will achieve a good degree of mental health in his old age and have high affective behavior

**Behavior (Psychomotor):** According to table 1 shows that of 41 elderly people with gout arthritis almost half (46%) of moderate psychomotor behavior. This is demonstrated by the recapitulation of the data from the psychomotor questionnaire of positive statements (perception and readiness) of number 2, 3, (guided movements and accustomed movements) number 4, (complex movements) number 7, (Adjustment of movement patterns) number 8, and (creativity) Number 11 almost half the elderly patients Gout arthritis replied "Never", according to the statement of researchers supposedly elderly people gout arthritis answered "always". However, from the positive aspects (creativity) Number 10 almost half the elderly people who gout arthritis answered according to the researcher's statement "always". The elderly is a human life cycle that must be experienced by everyone. In fact, at this time, each time the word "elderly" in mind is a person who is

helpless, and has many health complaints [6], one of the many elderlies who suffer from the disease gout arthritis. The elderly not only as a person who is repossessed and respected, but also serves as an agent of change in the family environment and the surrounding community in creating a healthy family, by utilizing the experience already possessed and enriched with the provision of appropriate health knowledge. The elderly undergoes a change in the musculoskeletal system which is reduced muscle mass and strength such as the strength of hand grasping and foot strength. The risk factor is reduced muscle strength, flexibility and coordination, the limited range of joint motion, increased risks of falling and fracture, therefore the motion pattern in elderly people with Gout arthritis is very limited and the food consumed is limited (should not consume foods high in Purine). Elderly Gout arthritis sufferers are recommended for regular exercise in accordance with the pattern of motion to train the strength of muscles so as not to experience stiffness and reduce pain in the joints<sup>8,9</sup>.

While the negative statements (guided movements and accustomed movements) number 5, (complex movements) number 6, and (adjustment of movement patterns) Number 9 Almost half the elderly people gout arthritis answered "always", should be in accordance with the statement of elderly researchers Gout arthritis replied "never". However, from the negative aspects (perception and readiness) to number 1, and (creativity) number 12 Almost half the elderly Gout arthritis sufferers answered according to the researcher's statement "never". Elderly who are still able to do gymnastics and road moves together, show that a healthy elderly. This signifies that in young times the pattern of life is also certainly healthy. Healthy living should start since young ". exercise is a pattern of motion that must be done routinely by elderly people who are gout arthritis. There is some exercise that can be done by elderly gout arthritis sufferers; Light gymnastics, keep the joints flexible and easy to move to reduce stiffness<sup>12</sup>. Also, warm compress can reduce pain in joints<sup>13</sup>. Yoga, very beneficial for elderly people with gout arthritis can help increase muscle strength and flexibility of the body. Tai-chi, to enhance and maintain muscle strength without the need to use weights. Stretching or stretching, will help the flexibility as well as muscle strength. Regular walking, will get better health, not only burn calories but walking can also strengthen muscles without having to torture joints<sup>12,14</sup>.

## Conclusion

In this study we revealed that (1) elderly people with Gout arthritis almost half has cognitive behavior in the low category in the Posyandu Rekso Werdho V Wonokromo Surabaya; (2) elderly people who have gout arthritis nearly half have affective behavior in the category of being in the Posyandu Rekso Werdho V Wonokromo Surabaya; and (3) elderly people with Gout arthritis almost half has psychomotor behavior in the category of moderate in the Posyandu Rekso Werdho V Wonokromo Surabaya.

**Conflict of Interest:** The author declare that they have no conflict of interest.

**Source of Funding:** This study supported by the Ministry of Education and Culture of the Republic of Indonesia.

**Acknowledgements:** We thank Arif Nur Muhammad Ansori for editing the manuscript.

**Ethical Approval:** This study approved by the Ethics Committee from Universitas Nahdlatul Ulama Surabaya, Surabaya, Indonesia.

## References

- Bakker M, Vissink A, Spoorenberg S, et al. Are edentulousness, oral health problems and poorhealth-related quality of life associated with malnutrition in community-dwelling elderly (aged 75 years and over)? A cross-sectional study. *Nutrients*. 2018; 10.
- World Health Organization. *Global Health and Aging*. USA: NIH Publication; 2011.
- Nowakowski A. Chronic inflammation and quality of life in older adults: A cross-sectional study using biomarkers to predict emotional and relational outcomes. *Health Qual Life Outcomes*. 2014; 12: 141-153.
- Zahroh C, Faiza K. Pengaruh kompres hangat terhadap penurunan nyeri pada penderita penyakit Arthritis Gout. *Journal of Ners and Midwifery*. 2018; 5(3): 82-187.
- Hu S, Lei W, Chao K, et al. Common chronic health problems and life satisfaction among Macau elderly people. *International Journal of Nursing Sciences*. 2016; 3(4): 367-370.
- Zahroh C, Ekawati L, Munjidah A, et al. Quality of Life pada Lansia: Quality of Life in the Elderly. *Jurnal Ilmiah Keperawatan (Scientific Journal of Nursing)*. 2020; 6(2): 248-251.
- Ministry of Health. *Hasil Utama Riskesdas 2018 Provinsi Jawa Timur*. Surabaya: Badan Penelitian dan Pengembangan Kesehatan Puslitbang Humaniora dan Manajemen Kesehatan, Surabaya; 2018.
- Ramsubeik K, Ramrattan LA, Kaeley GS, et al. Effectiveness of healthcare educational and behavioral interventions to improve gout outcomes: A systematic review and meta-analysis. *Therapeutic Advances in Musculoskeletal Disease*. 2018; 10(12): 235-252.
- Alshammari SA, Alhassan AM, Aldawsari MA, et al. Falls among elderly and its relation with their health problems and surrounding environmental factors in Riyadh. *Journal Family and Community Medicine*. 2018; 25(1): 29-34.
- Zahroh C, Anggraini R, Khamida, et al. The relationship of intelligence and health perceptions. *Indian Journal of Public Health Research and Development*. 2020; 11(5): 630-633.
- Montero P, Rodríguez A. Differences between body composition and physiological characteristics of active/inactive elderly women. *International Journal Morpho*. 2018; 36: 262-266.
- Sharpe P, Wilcox S, Schoffman D, et al. Participation, satisfaction, perceived benefits, and maintenance of behavioral self-management strategies in a self-directed exercise program for adults with arthritis. *Evaluation Program Plan*. 2017; 60: 143-150.
- Zahroh C, Nurjanah S, Widyarti N. Abdominal breathing affects blood pressure in hypertension sufferers. *Journal of Public Health in Africa*. 2019; 10: 23-25.
- Andrieieva O, Hakman A, Ashuba V, et al. Effects of physical activity on aging processes in elderly persons. *Journal of Physical Education and Sport*. 2019; 19(4): 1308-1314.

# Clinical Study of Functional Outcome of External Fixator Device as a Primary Definitive Treatment of Open Tibia Fracture

Praveen Garg<sup>1</sup>, Rajvirsinh Sodha<sup>2</sup>, Fahad Bin Hamid<sup>3</sup>, T. Somashekarappa<sup>4</sup>

<sup>1</sup>Associate Professor, Department of Orthopaedics, RMCH, Bareilly, U.P., <sup>2</sup>Junior Resident, Department of Orthopaedics, RMCH, Bareilly, U.P., <sup>3</sup>Assistant Professor, Department of Orthopaedics, RMCH, Bareilly, U.P., <sup>4</sup>Professor and Head, Department of Orthopaedics, RMCH, Bareilly, U.P.

## Abstract

**Background:** Open fractures of leg are quite common in Road traffic accidents. The ideal protocol for open fractures of leg is initial thorough debridement, soft tissue coverage and intramedullary nailing or external fixator application. External fixator may be later converted to internal fixation with reamed or unreamed intramedullary nail or left as a definitive treatment.

**Methodology:** This prospective study was conducted at Rohilkhand Medical College And Hospital from January 2019 to January 2020 on patients presenting with open tibial fracture. Tubular External Fixator was used. Total 30 patients were enrolled in this study.

**Results:** In our study 30 patients were included in which 20 were male and 10 were females with mean age 32.2 years including children and elderly age group there was no age bar. Mean operative time was 60 minutes. Average time for union was 24 weeks.

**Conclusion:** External fixation as a primary definitive treatment for open tibial fracture is a cost effective procedure in developing country with minimal morbidity and mortality.

**Keywords:** Compound fracture, external fixator, Pin.

## Introduction

Open fractures of leg are quite common in Road traffic accidents. The ideal protocol for open fractures of leg is initial thorough debridement, soft tissue coverage and intramedullary nailing or external fixator application. External fixator may be later converted to internal fixation with reamed or unreamed intramedullary nail or left as a definitive treatment.<sup>1</sup>

The goals of open fracture management are prevention of infection, soft tissue coverage, achievement of bony union and restoration of function. Important principles involve antibiotic utilization, timing of initial surgical intervention, thorough debridement, type of wound closure and fixation of fracture after proper alignment.<sup>2</sup>

The management depends on type of injury, contamination of wound, viability of skin and soft tissues and compartment syndrome. Though intramedullary interlocking nailing is used in open fractures of tibia. In reamed nail the infection rate has been reported high. A high incidence of infection has been reported in delayed intramedullary nailing<sup>3</sup>. There is controversy in literature regarding the best way of management of type II and type III open tibia fractures<sup>4</sup>. Ex fix as a definitive procedure reduces the cost of one more surgery.

---

### Corresponding Author:

**Dr. Rajvirsinh Sodha**

Junior Resident, Department of Orthopaedics, RMCH, Bareilly, U.P.

e-mail: sodharajvir@gmail.com

Mobile Number: 9925012456, 7457012288

**Aim and Objectives:** To assess the functional outcome of external fixator device as a primary definitive treatment for open tibia fracture.

**Materials and Method**

The study was done at Rohilkhand Medical College And Hospital from January 2019 to

January 2020.

Total 30 patients were included, and all patients treated with external fixator as definitive treatment after thorough debridement and proper reduction and alignment of fracture.

**Inclusion Criteria:**

Open fractures of both bones of leg type II, type III A and B (Gustilo Anderson)

**Exclusion Criteria:**

Fractures with bone defects

Intra-articular fractures.

**Surgical technique:** The patients with compound fracture injury taken up for surgery on OT table, proper scrubbing of limb and draping done, prophylactic antibiotics was given.

Thorough wound debridement and wound wash with normal saline was done

Proximal and Distal pins applied on arterio-medial aspect of tibia

Anatomical reduction and alignment were done and connecting rods was applied

If the tissue and skin viability is good, a primary closure was done without any tension.

If necessary release incision was given for primary closure of wound.

Wound swab was taken for culture and sensitivity before closure.

Soft tissue coverage by flap or skin grafting was done within two weeks in patients in whom primary closure was not done.

Depending on the culture sensitivity of the organism appropriate antibiotics were continued for ten days.

The pins were cleaned and dressed with beta dine on alternate days.

**Follow Up:** Each patient was evaluated clinically and radiographically at three weeks, six weeks, 3 months, then after every four week to assess the union of the fracture.

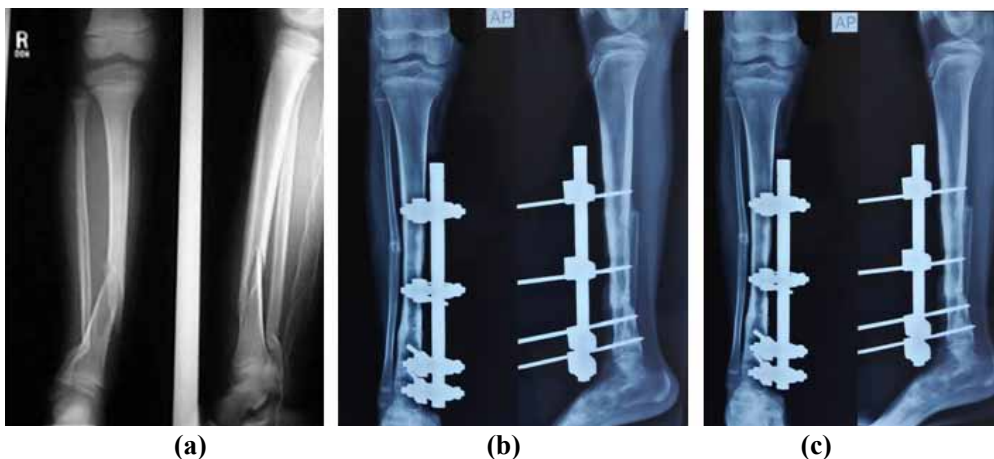
Pin tract infections were treated by dressing, appropriate antibiotics.

Fracture healing was assessed by standard radiographic projections and union defined as dense callus bringing at least three cortices.

Partial weight bearing was allowed at 6 weeks and full weight bearing at around 3 months.

The external fixator was removed when there is union of the fracture. A pop slab was given for two weeks for the healing of pin tracks.

The patients were assessed for healing of soft tissues, fracture union, function of knee and ankle.



**Fig (a) Pre-operative X ray (b) 6 weeks post-operative (c) 12 weeks post-operative**

### Result

In our study 30 patients were included in which 20 were male and 10 were females with mean age of 32.2 years. Mean operative time was 60 minutes. Average time for union was 24 weeks.

The level of fracture was at middle 1/3 in 22 and lower 1/3 in 5 cases and upper 1/3 in 3 cases. The grade of open fracture was type II in 20, type III A in 6 and type III B in 4 patients.

Primary closure was done in 22 patients while secondary closure was done in 5 patients and flap coverage was done in 3 patients. Complication like loss of reduction occurred in 3 patients, pin tract infection was occurred in 6 patients, pin loosening in 1 patient.

The fracture union by 10-12 weeks in 2 patients, by 12-16 weeks in 6 patients, 16-20 weeks in 14 patients, and 20-24 weeks in 8 patients.

Malunion was defined as varus or valgus malalignment of 5 degree or more, anterior or posterior angulation of 10 degree or more, shortening of 1 cm or more or rotational malalignment of 10 degree or more as compared with the contralateral leg.

In our study there were 3 patients had nonunion and 3 patients had delayed union. Pin tract infection was major complication of the external fixator. In our study 6 patients had pin tract infection. This was managed by pin tract dressing and antibiotics.

No patient had osteomyelitis like complication. There was no restriction of range of motion of knee and ankle joint.

### Discussion

Open tibial fractures are associated with infection, soft tissue injury, malunion and non-union thus leads to greater challenge<sup>4,5,6</sup>. These cases should be managed as early as possible to minimize complications. Intramedullary nailing is not possible due to contaminated wound thus external fixator is method of choice. External fixator has advantages of low blood loss and proper wound care.

**1. Comparison of Mean Age:** Mean age in present study was 32.3 years compared to 25.5 years in Irfan S et al<sup>4</sup> study which suggest older age group involved in present study while in A. Velazco et al<sup>5</sup> it was 40.2 Years.

Age group 30-50 are productive age group who have high risk of injury.

**2. Gender Comparison:** Male predominance was found in both studies which may be attributed to higher risk of fracture in this population. In present study male population was 20 and female population was 10 as compared to A. Velazco et al<sup>5</sup> and Ravi Kumar et al<sup>6</sup> has more male population.

**3. Comparison of Level of Fracture:** Most common was Middle 1/3<sup>rd</sup> fracture followed by lower and upper 1/3<sup>rd</sup> in present study and Ravi Kumar et al<sup>6</sup> as in our study middle fracture was 22 and in Ravi Kumar et al<sup>6</sup> was 26 patients. It may be attributed to mechanics of tibial fracture which suggests middle 1/3 having high risk.<sup>5,6</sup>

**4. Comparison of Fracture Union:**

**Table 1: Comparison of Fracture Union:**

Weeks	Present Study	Irfan S et al <sup>4</sup>
10-12	2	1
12-16	6	2
16-20	14	10
20-24	8	2
>25	0	5

In most of cases healing was found between 16-20 weeks in both studies. In Irfan S et al study 5 patients took >25 weeks' time to heal.

**5. Comparison of complications:**

**Table 2: Comparison of complications**

Complications	Present Study	Ravi Kumar et al <sup>6</sup>
Loss of reduction	3	3
Pin tract infection	6	8
Pin loosening	1	1
Delayed Union	3	2
Non-Union	3	3

Pin tract infection was most common complications in both studies which may be due to local site wound contaminations which can be managed with antibiotics and dressing. Loss of reduction occurred in 3 patient which was managed conservatively. Pin loosening was found in 1 patient in each study. Delayed union in 3 patients in present study while Ravi Kumar et al reported 2 patients. There were non-union in 3 patients in present study while Ravi Kumar et al reported 3 patients.



## Conclusion

External fixation as a primary definitive treatment for open tibial fracture is a cost effective procedure in developing country with minimal morbidity and mortality.

**Ethical Clearance:** Taken from Institutional Ethical Committee Rohilkhand Medical College And Hospital

**Source of Funding:** Self

**Conflict of Interest:** Nil

## References:

1. Giannoudis PV, Papakostidis C, Roberts C. A review of management of open fracture of tibia and femur. *JBJS* 2006; 3(88B):281-289
2. Robert W Bucholz, James D Heckman, Charles M, Court Brown. *Rock wood and Green fracture in adults*, 6<sup>th</sup> Edition, 2079. 2014.
3. Michail Beltrias, Olga Sarridou, John Kovam's. External fixation on a primary and treatment for tibial diaphyseal fracture strategies trauma limb reconstruction. 2009; 4(2):81-87
4. Dr. SK Irfan Ali, Dr. Sujai S, Dr. HK MdJunied, Dr. Chethan M H, Dr. Ganesh H and Dr. MK Siddalinga Swamy. Evaluation of the functional outcome in open tibial fractures managed with an Ilizarov fixator as a primary and definitive treatment modality. *International Journal of Orthopaedics Sciences* 2017; 3(2): 436-440
5. A. Velazco, L. L. Fleming. Open Fractures of the Tibia Treated by the Hoffmann External Fixator. *Clinical Orthopedics and related research.*; 1982:(183):125-132.
6. Dr. Ravi Kumar, Dr. Sujai S, Dr. Chethan, Dr. HC Nanjundappa, Dr. Siddalinga Swamy. Results of open fractures of tibia treated by external fixator as primary and definitive procedure. *International Journal of Orthopaedics Sciences* 2017; 3(1): 179-181.

# To Study Preloading and Relative Efficacy of Ringer's Lactate and Pentastarch 6% Prior to Spinal Anaesthesia in Lower Abdominal and Lower Limb Surgeries

Priya Kishnani<sup>1</sup>, Ishaan Batra<sup>2</sup>, Tejash Sharma<sup>3</sup>, Malini Mehta<sup>4</sup>

<sup>1</sup>Assistant Professor, Department of Anaesthesiology, Dhiraj Hospital, Smt. B.K. Shah Medical Institute & Research Centre Sumandeep Vidyapeeth Deemed to be University, Vadodara, Gujarat, <sup>2</sup>Senior Resident, Department of Anaesthesiology, Maulana Azad Medical College, New Delhi, <sup>3</sup>Associate Professor, <sup>4</sup>Professor, Department of Anaesthesiology, Dhiraj Hospital, Smt. B.K. Shah Medical Institute & Research Centre Sumandeep Vidyapeeth Deemed to be University, Vadodara, Gujarat

## Abstract

**Background and Objectives:** Hypotension after spinal anaesthesia remains a common and a serious complication. Various methods have been recommended for the prevention and treatment of this problem. Preloading has become the cornerstone for prophylaxis of hypotension post spinal anaesthesia. This current study reassessed the efficacy of this volume preloading and also compared the efficacy between Ringer's lactate and Pentastarch 6%.

**Method:** In this study, 60 patients (ASA I & II) presenting for elective lower abdominal and lower limb surgeries under spinal anaesthesia were allocated into two groups, group P and group R to receive 5 ml/kg of 6% Pentastarch and 10 ml/kg of Ringer's lactate preload respectively. After institution of spinal anaesthesia in a sitting position with 3.8 ml of Bupivacaine 0.5% (heavy) using 23G Quincke spinal needle, patients were made to assume supine position. The heart rate (HR), systolic blood pressure (SBP) and diastolic blood pressure (DBP) were monitored intra-operatively every 2 minutes for first 10 minutes and every 5 minutes for next one hour and every 15 minutes thereafter. Electrocardiogram (ECG) and oxygen saturation (SpO<sub>2</sub>) were monitored continuously. The amount of ephedrine, used intra-operatively were noted and compared among the different groups.

**Results:** The incidence of hypotension in group R was more than that in group P. There were no significant difference in HR and the SpO<sub>2</sub> between the groups. The difference in mean basal SBP and DBP were statistically insignificant in both groups. Thereafter, the fall in SBP and DBP was more prominent in group R at all time intervals with a statistically highly significant difference between the two groups (p value <0.001). The amount of ephedrine used in group R was more than that used in group P. There were minimal complications like shivering and vomiting which were statistically non-significant. There were no allergic reactions to the fluids used.

**Conclusion:** Volume preloading, still has a substantial role in reducing the incidence and severity of hypotension in patients operated under spinal anaesthesia. Pentastarch 6% is found to be a better agent for preloading, as it is safe and effective in preventing spinal-induced hypotension in patients.

**Keywords:** Spinal anaesthesia, Hypotension, Crystalloids, Colloids.

---

## Corresponding Author:

**Dr. Malini Mehta**

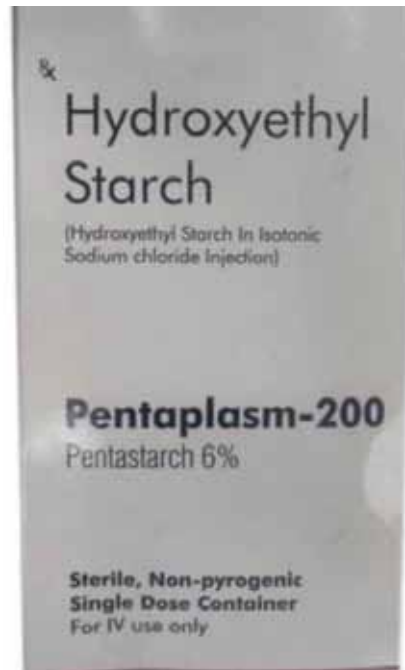
Professor, Department of Anaesthesiology, SBKS MI & RC, SVU, Piparia, Waghodia, Vadodara, India  
e-mail: m\_malini17@yahoo.in

## Introduction

Spinal anaesthesia is most commonly associated with hypotension and bradycardia due to anaesthetised spinal sympathetic nerve fibres.<sup>(1)</sup> One of the most common methods of preventing spinal anaesthesia

induced hypotension is by the “pre-loading” technique described by wollman and marx. Preloading decreases the incidence of hypotension associated with spinal anaesthesia in the first 15 minutes following sub arachnoid injection as compared to patients who did not receive any pre-load.<sup>(2,3)</sup> It has been suggested that pre-loading with colloids is beneficial in preventing spinal anaesthesia induced hypotension as colloids remains in the intra-vascular space for a longer duration so they resist any decrease in intra- vascular volume following spinal anaesthesia. However prophylactic use of colloids is not routinely done due to increased cost, possible de-arrangement of coagulation and risk of anaphylaxis<sup>(4,5)</sup>.

Crystalloids are fluids that contain mainly water and electrolytes. They are used to provide maintenance of water and electrolytes and expand intravascular fluid. Ringer’s lactate is one of the crystalloids that is isotonic with blood, The by- products of the metabolism of Ringer’s lactate in the liver counteract acidosis which is a common complication in fluid loss. Colloids are solutions, which, because of their oncotic pressure are confined mainly to the intravascular space. A colloid will usually expand the intravascular space, Pentastarch 6% is a sub group of hydroxyethyl starch sold under the name of pentaspan. Hydroxy ethyl starch is an artificial colloid obtained from starch, it is composed almost entirely of amylo-pectin, which is a highly branched and more stable component of starch.



**Aims:** To study the effect of preloading and relative efficacy of Ringer’s lactate and pentastarch 6% as preloading solution prior to spinal anaesthesia in lower abdominal and lower limb surgeries.

**Objectives:**

1. To compare the efficacy in terms of haemodynamic response to spinal anaesthesia after administration of Ringer’s lactate and Pentastarch 6% as preloading fluid.
2. To compare complication or side effects if any of both the fluids used for preloading.

**Methodology**

This observational study was undertaken after obtaining approval of the Hospital Ethics committee and written and informed consent from the patients. 60 patients admitted at Dhiraj hospital S.B.K.S M.I and R.C, Piparia, Vadodara, for elective orthopaedics or general surgery cases, meeting the inclusion and exclusion criteria were taken up for this study.

**Inclusion Criteria:**

- The patients belonging to ASA-I and ASA-II
- Age group from 18 to 60 years.

- Only elective Cases.
- Duration of surgery from 2 to 2.5 hours.

**Exclusion Criteria:**

- All contraindications for spinal anaesthesia
- Age less than 18 years or more than 60 years
- Concomitant diseases - diabetes mellitus, hypertension, heart diseases, obesity
- Height less than 150 cms
- ASA III, IV and V.

All patients were examined and a pre-anaesthetic check up was performed a day before the surgery. All investigations were studied and the patients meeting all the inclusion and exclusion criteria were taken for study. All patients had overnight fasting.

After receiving the patient inside the pre-operative room baseline vital signs were recorded using BPL Ultima multiparameter monitor. IV line was secured with 18 gauge cannula. Patients in group R was preloaded with 10ml/kg of Ringer’s lactate solution and in group P with 5ml/kg of Pentastarch 6% solution respectively over a period of 20 minutes just prior to the administration of spinal anaesthesia. All were premedicated with inj. Glycopyrrolate 0.2 mg and inj. Ondansetron 4 mg i.v.

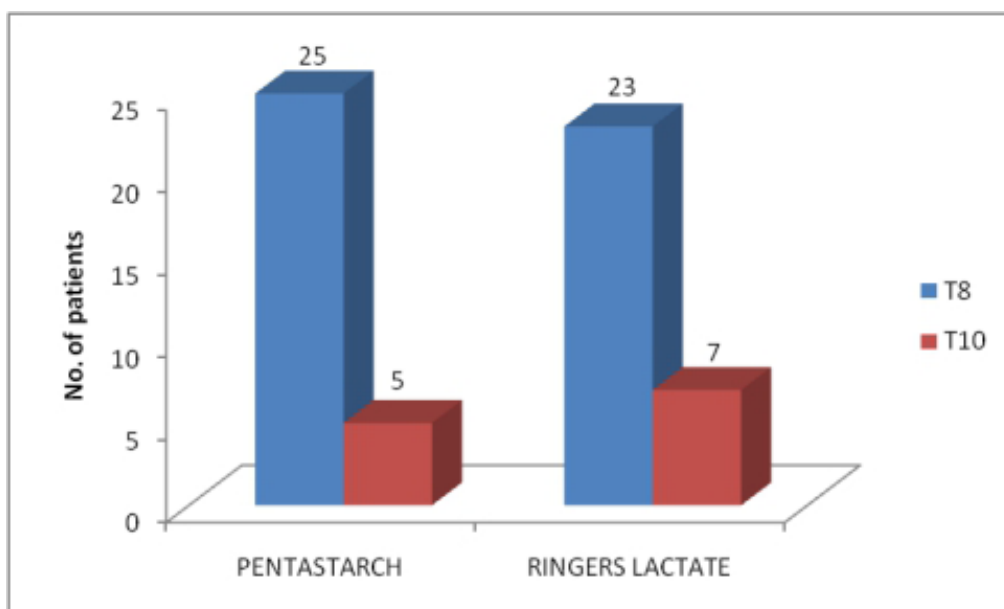
After 10 minutes of preloading period, subarachnoid block was performed with 3.8 ml of bupivacaine 0.5% (heavy) at L3-L4 or L4-L5 interspace using 23 Gauge Quinke’s spinal needle in sitting position. The patient was then positioned supine. Adequate block was obtained and height of block was tested by pinprick method using blunt needle. Hypotension (A decrease in systolic BP by 20% of the baseline value) following spinal anaesthesia was treated with 6 mg bolus dose of ephedrine and additional rapid infusion of Ringer’s lactate solution. All patients were administered O<sub>2</sub> 4 L/min by ventimask throughout the period of surgery.

**Following observations were made:** Electrocardiogram (ECG), heart rate (HR), systolic blood pressure (SBP), diastolic blood pressure (DBP) and oxygen saturation (SpO<sub>2</sub>) were monitored every 2 minutes for the first 10 minutes and every 5 minutes till next 1 hour then every 15 minutes till end of surgery. In addition height of the block, and amount of ephedrine used intra-operatively and any allergic reactions to i.v. fluids were noted.

These observations were analyzed to get information on: Degree of hypotension (decrease in the SBP 20% of the baseline value), bradycardia (HR<60 beats/min), requirement of vasopressor, incidence of nausea and vomiting and allergic reactions.

**Observation And Results**

**Figure 1: Level of Sensory Blockade**

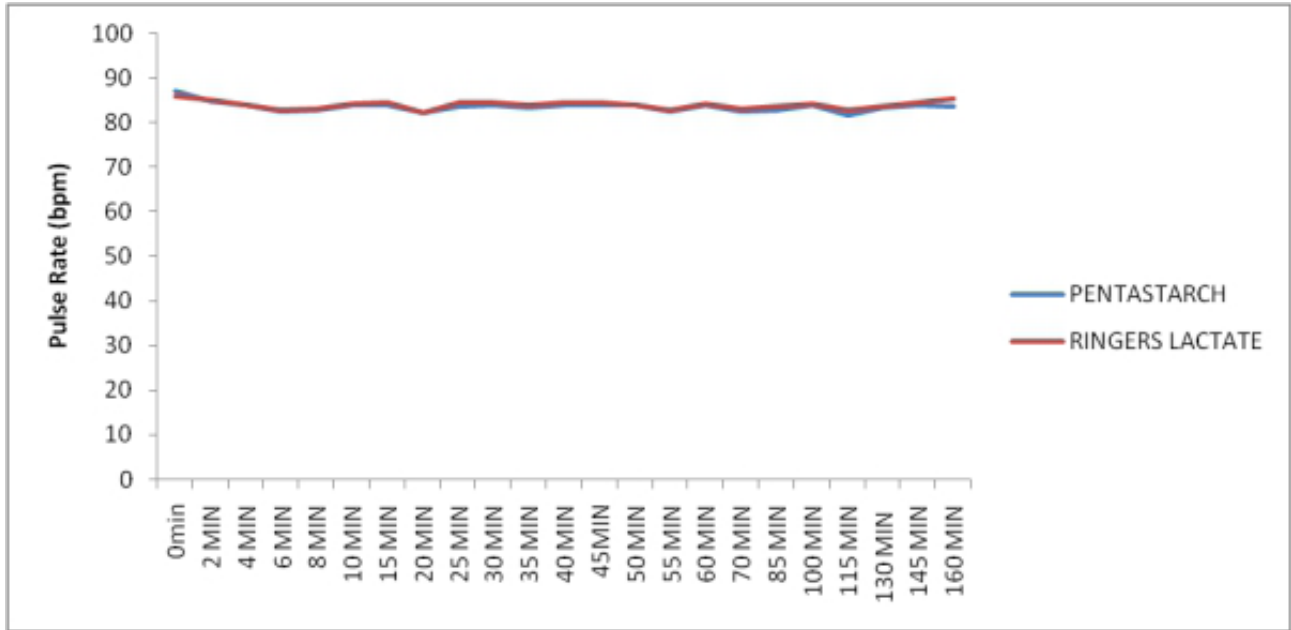


**Figure 1: Level of sensory block achieved in both groups**

Sensory level was tested by needle - prick method, a sensory level of T8 was achieved in 25 patients in group P and in 23 patients in group R, a sensory level of T10

was achieved in 5 patients in group P and in 7 patients in the group R the difference being statistically non – significant (p value >0.05).

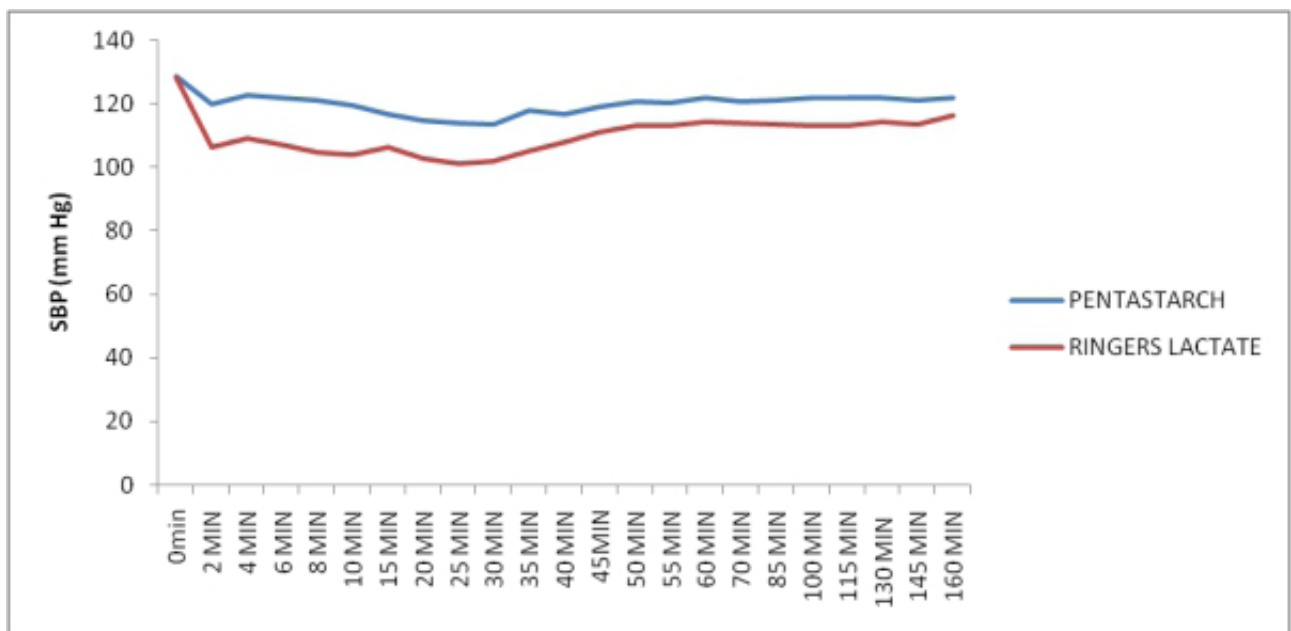
**Figure 2: Mean heart rate (bpm) over various time intervals in both the group**



**Figure 2: Mean heart rate over various time intervals in both groups**

Mean HR variations during the study reveal no statistically significant difference between the two groups with a p value > 0.05 during all time intervals.

**Figure 3: Mean systolic blood pressure (mm Hg) over various time intervals in both the groups.**

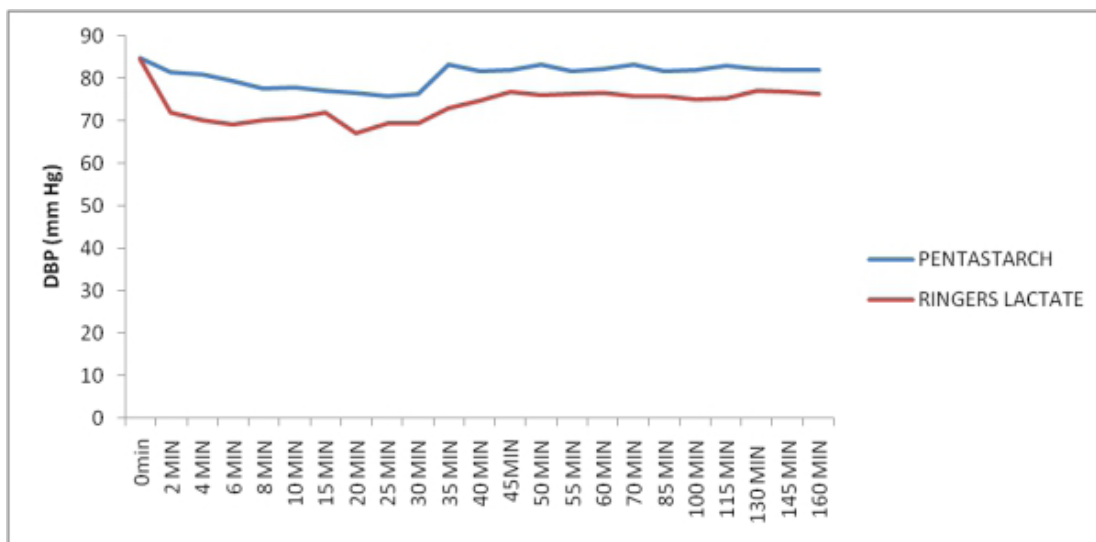


**Figure 3: Mean SBP over various time intervals in both groups**

The mean basal SBP was 128.73 mm Hg in group P and 128.40 mm Hg in group R, the difference between the two groups being statistically non-significant. Thereafter the fall in SBP was more prominent in group R at all time intervals with a statistically highly significant difference between the two groups as shown in the table.

(p value < 0.001). The lowest mean SBP in group R was 101.27 mm Hg at 25 minutes and that in group P was 113.47 mm Hg at 30 minutes, corresponding to a fall in SBP of 21.129 % in group R and a fall of 11.854 % in group P.

**Figure 4: Mean diastolic blood pressure (mm Hg) over various time intervals in both the groups.**

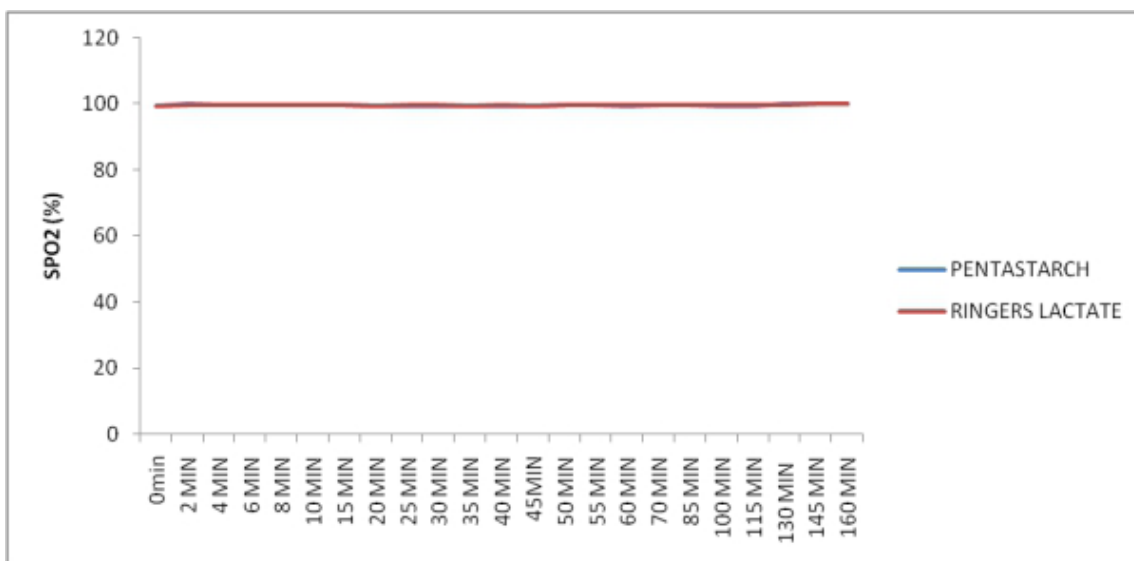


**Figure 4: Mean DBP over various time intervals in both groups**

The mean basal DBP for group P was 84.73mm Hg and that in group R was 84.47mm Hg the difference being statistically non-significant. Thereafter the fall in DBP was more prominent in group R at all time intervals with a statistically highly significant difference between

the two groups as shown in the table.(p value <0.001) The lowest mean DBP was 67mm Hg at 20 minutes in group R and in group P was 75.87mm Hg at 25 minutes, corresponding to a fall in DBP of 20.68% in group R and a fall of 10.45 % in group P.

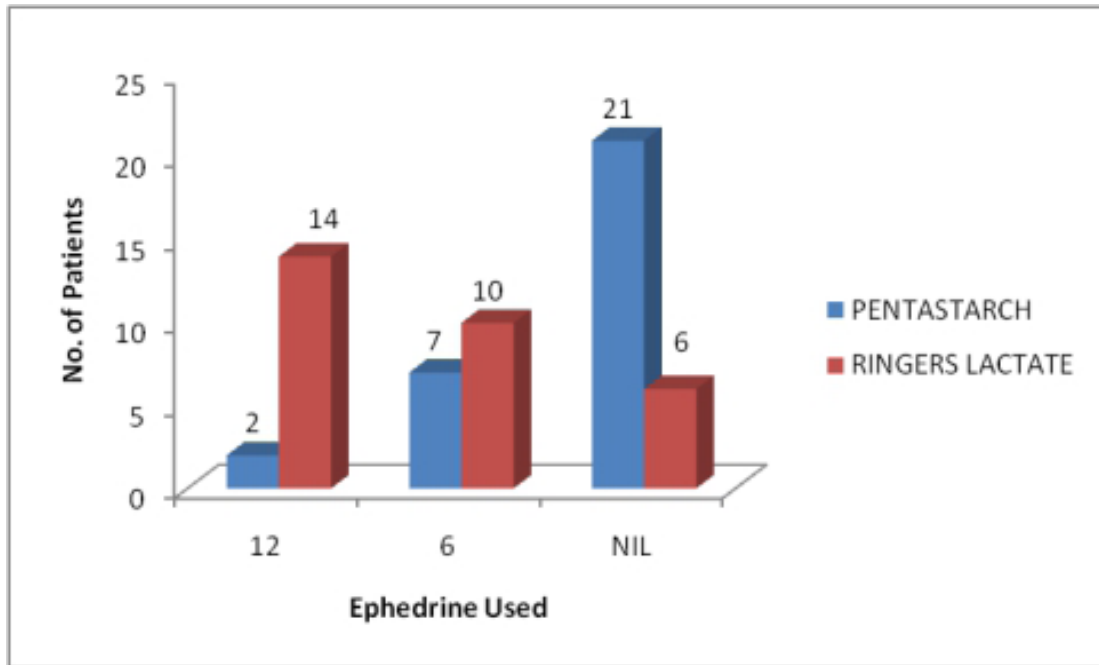
**Figure 5: Mean oxygen saturation (%) over various time intervals in both groups:**



**Figure 5: Mean SpO<sub>2</sub> over various time intervals in both groups**

Mean SpO<sub>2</sub> variations during the study reveal no statistically significant difference between the two groups with a p value > 0.05 during all times.

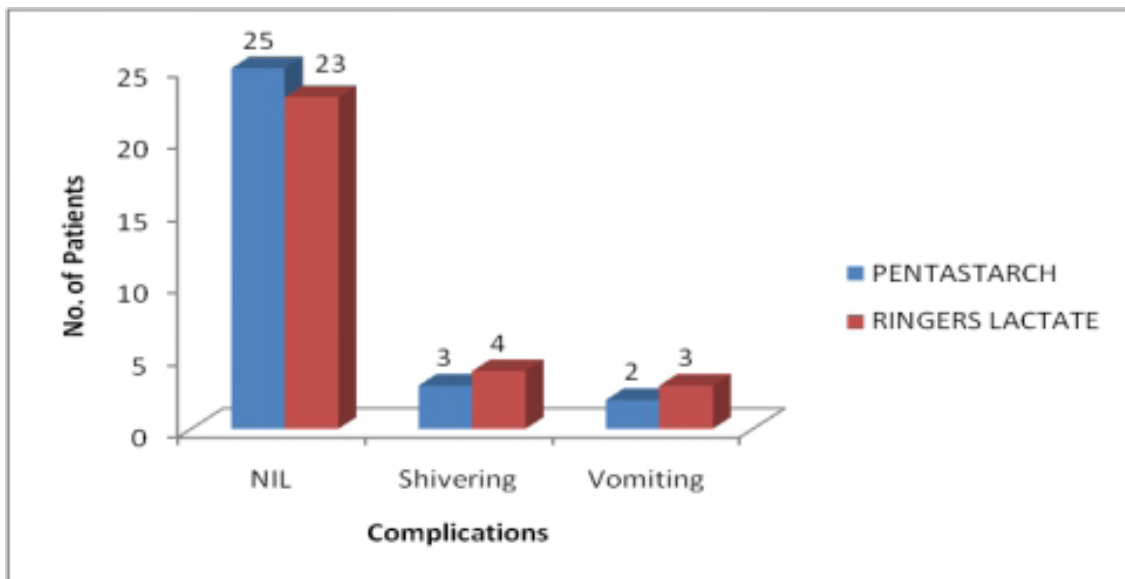
**Figure 6: Ephedrine Used:**



**Figure 6: Amount of ephedrine used in both groups**

The amount of ephedrine used was more in group R as compared to group P. Ephedrine was not at all required in 21 patients in group P (70%) as compared to 6 patients in group R (20%) the difference being statistically highly significant with a p value < 0.001. The amount of cumulative ephedrine used in group P was 66mg as against a use of 228 mg in group R.

**Figure 7: Complications:**



**Figure 7. Incidence of complications in both groups**

There were similar incidences of shivering and vomiting between the two groups.

## Discussion

Hypotension is the commonest problem following spinal anaesthesia for lower abdominal and lower limb surgeries. Blood pressure is usually maintained in spite of vasodilation, by a reflex increase in cardiac output. However, in the presence of spinal anaesthesia induced venodilation, venous return is reduced and so is cardiac output thus causing severe hypotension. Therefore, increase cardiac preload is done before institution of spinal blockade to prevent hypotension.<sup>(6)</sup>

Rout et al, Jackson et al 1994 recommended 1000 ml of a balanced electrolyte solution for prehydration before regional anaesthesia. Although, preloading with 1000 ml of crystalloid decreases the incidence of hypotension but it still remained a frequent event. Some researchers even increased the volume of crystalloid to 2000 ml, but use of large volumes of crystalloid fluid has risk of haemodilution along with decreased oxygen-carrying capacity, and pulmonary oedema in patients with a reduced pulmonary interstitial safety margin, due to a fall in oncotic pressure and an increase in the plasma volume.<sup>(6,7)</sup> Since colloids remain in the vascular compartment for a longer time period than the crystalloids, it is said to require only about one-third to one-fourth as much colloid as crystalloid, for an equivalent amount of venous expansion. Colloid solutions are more expensive than crystalloids and, have other disadvantages, including anaphylaxis.<sup>(6,7)</sup>

Siddik et al, 2000, compared the preloading effect of 500 ml of Heta starch (HES) with 1000 ml of Ringer's lactate in patients undergoing elective caesarean section, they found that the incidence of hypotension was 20% in HES group as against 40% in Ringer's lactate group.<sup>(8)</sup>

Xie et al, 2014, studied crystalloid and colloid preload for maintenance of cardiac output (CO) in patients undergoing total hip replacement and observed that preload with colloid was more effective than crystalloid in maintaining CO which might improve haemodynamic stability.<sup>(9)</sup>

Mandal et al, 2016, compared effects of crystalloid and colloid preload on maternal haemodynamics in elective caesarean section under spinal anaesthesia and found out that the fall of blood pressure was higher in Ringer's lactate group than 6% HES group.<sup>(10)</sup>

In our study, the incidence of hypotension was found to be lower in patients who received 6% Pentastarch

solution as compared to those who were preloaded with Ringer's lactate solution. The results of our study correlate well with the other studies conducted to know the effectiveness of crystalloid and colloids in preventing hypotension post spinal anaesthesia.

Colloids contain larger molecules that did not immediately redistribute, through the extracellular fluid compartment. Hence, they did not decrease plasma colloid oncotic pressure (COP) as much as crystalloid solutions and intravascular volume would be better maintained. Colloid solutions, due to their longer presence in the vascular compartments, maintain a stable haemodynamics where as crystalloid solutions, in larger doses, dilute the plasma proteins resulting in a greater extra-vascular fluid into the extracellular fluid compartment secondary to the fall of plasma colloid oncotic pressure.<sup>(11,12)</sup>

The amount of vasopressor (Ephedrine 6mg boluses) required to treat hypotension was found to be more in group R as compared to group P.

The other important parameters like the age of the patient, height of the patient, weight of the patient, the dose of local anaesthetic used for the subarachnoid block and the level of sensory blockade obtained, were intentionally kept comparable in all the groups as much as possible, to avoid these factors influencing our study.

There were no significant difference in heart rate and the oxygen saturation (SpO<sub>2</sub>) between the groups. The difference in mean basal SBP and DBP were statistically non-significant in both groups. Thereafter, the fall in SBP and DBP was more prominent in group R at all time intervals with a statistically highly significant difference than group P. (pvalue <0.001)

Incidence of nausea, vomiting and shivering were comparable in both the groups.

In this present study, Pentastarch 6% did not produce any allergic reactions. Pentastarch is derived from waxy starch and composed chiefly of amylopectine. The structural similarity to our body glycogen explained its lower antigenic potential, and there was no evidence that it interferes with the clotting in trauma or major surgery patients.

## Conclusion

Pentastarch 6% was better than Ringer's lactate in reducing the incidence of spinal anaesthesia induced



hypotension in lower abdominal and lower limb surgeries with similar incidences of complications like vomiting and shivering.

**Ethical Clearance:** Taken from Sumandeep Vidyapeeth Institutional Ethics Committee (SVIEC).

**Source of Funding:** Self

**Conflict of Interest:** Nil

### References

1. Morgan and Mikhail's. Clinical Anaesthesiology. 5<sup>th</sup> edition. Pgno 937-975.
2. Buggy D, Higgins P, Moran C, O'brien D et al. Prevention of spinal anaesthesia induced hypotension in elderly comparison between preanaesthetic administration of crystalloids, colloids and no prehydration. *Anaesth analo*. 1997;(84):106-10.
3. Casati A, fareeli G etal. Cardiac performance during unilateral lumbar spinal block after crystalloid preload. *Can J anaesth*. 1997; (44): 623-28Ewaldson C, Hahn R. Volume kinetics of ringer solution during induction of spinal and general anaesthesia. *British journal anaesth*. 2001;(87): 406-14.
4. Cyna Am, Andrew M, Middleton P et al. Techniques for preventing hypotension during spinal anaesthesia for caesarean section. *Cochrane database system review*,2006,4,CD002251.
5. Rout CC, Rocke DA.Prevention of hypotension following spinal anaesthesia for caesarean section. *Int Anaesthesiol Clin* 1994;(32): 117-132.
6. Jackson R, Reid JA, Thorburn J. Volume preloading is not essential to prevent spinal induced hypotension at Caesarean section. *Br J Anaesth* 1995; (75): 262-265.
7. Siddik S.M, Aouad M.T, Kai G.E, Sfeir M.M, BarakaA.S. Hydroxy ethyl starch 10% is superior for preloading before spinal anaesthesia for caesarean section. *Can J. anaesth* 2000;(47) :616-21.
8. Xie, Wang et al.Crystalloid and colloid preload for maintaining cardiac output in elderly patients undergoing total hip replacement surgery under spinal anaesthesia. *Journal of biomedical research*2014; (3): 185-90.
9. Mandal, Chattopadhaya et al. Comparison of crystalloid and colloid preload on maternal hemodynamics in elective caesarean section under spinal anaesthesia. *International Journal of Research in Medical Sciences*. 2016;(6):2428-35.
10. Park GE, Hauch MA, Curlin F, Datta S, Bader AM. The effects of varying volumes of crystalloid administered before Caesarean delivery on maternal haemodynamics and colloid osmotic pressure. *Anaesth Analg*, 1996; (83): 299-303.
11. Vercauteren MP, Hoffmann V, Copejans HC, Van Steenberge AL, Adriaensen HA.Hydroxyethyl starch compared withwith modified gelatin as volumeme preloadbefpreload before spinal anaesthesia (76):731-733.
12. Ueyama H, HeYL, Tanigami H, Mashimo T, Yoshia I. Effectsofcrystallocolloid preload on bloodmblood mein the parturient undergoing spinal anaesthesia

# Human Liver Morphology: Anatomical Study about the External Aspects

Priyanka N. Sharma<sup>1</sup>, Nirali Chavda<sup>2</sup>, Hetal V. Vaishnani<sup>3</sup>,  
K.M. Parmar<sup>4</sup>, Kinjal Jethva<sup>5</sup>, Manoj Kulkarni<sup>6</sup>, A.R. Gandotra<sup>7</sup>

<sup>1</sup>Assistant Professor, <sup>2</sup>Tutor, <sup>3</sup>Professor, <sup>4</sup>Associate Professor, <sup>5</sup>Associate Professor, <sup>6</sup>Professor, <sup>7</sup>Professor & HOD, Department of Anatomy, Smt. B.K. Shah Medical Institute and Research Center Sumandeep Vidyapeeth and Institution Deemed to be University, Pipariya, Vadodara, Gujarat, 391760.

## Abstract

Knowledge of the anatomy of liver is a prerequisite for a complete understanding of the mechanics of diagnostic imaging and minimally invasive surgical approaches. So the aim of the study is to carry out the morphological feature of right lobe, left lobe, caudate lobe, quadrate lobe and surfaces of liver. This is retrospective observational study done on 75 human livers irrespective of age and sex in Department of anatomy, Smt. B.K. Shah Medical Institute and Research Center, Vadodara, Gujarat. The livers were studied for morphological variations such as accessory fissure, accessory mini lobe, Quadrant lobe with tongue like projection, Pons hepatis connecting left lobe with quadrate lobe, Riedel's lobe present, Narrow and elongated left lobe, Absence of quadrant lobe, Absence of fissure for ligamentum teres, Bilobed caudate lobe and classified according to Netter's classification. Out of 75 embalmed human liver 23 (30.67%) livers were normal and 52 (69.33%) livers shown one or more than one morphological variation of liver. Out of 52 liver found abnormal fissures were in 23 (30.67%), pons hepatis in 2 (2.66%), Riedel's lobe in 3 (4%), absence of quadrant lobe in 1 (1.33%) deep renal impression and corset constriction observed in 15 (20%) specimens of liver, diaphragmatic deep groove were observed in 1 (1.33%) specimen. The presence of knowing extra lobes and fissure lies in the fact that might help to interpretation during imaging of hepatobiliary system and may intern lead to surgical implication in operation theater.

**Keywords:** *Liver, Accessory fissures, Accessory lobes, Caudate lobe, Quadrate lobe, Pons hepatis, Riedel's lobe, Hepatectomy.*

## Introduction

Knowledge of the anatomy of liver is a prerequisite for a complete understanding of the mechanics of diagnostic imaging and minimally invasive surgical approaches. Liver is one of the key organ of body which

is responsible for detoxifying the blood coming via portal vein, storing glucose, manufacturing cholesterol and secreting bile for digestion of fat. Liver is invariably involved in alcoholism there by causing cirrosis of liver. Liver exhibits various lobes viz right, left caudate and quadrate lobe, also has two fissures viz fissure for ligamentum teres and fissure for ligamentum venosum. It has a porta hepatis for the passage of vessels nerves and exit of hepatic ducts, lymphatics<sup>1</sup>.

There are wide variety of variation in size and number of lobes. It may exhibit accessory lobes. Its important to know these anatomical facts and variations regarding liver as they are of utmost importance to hepatobiliary surgeons. So the aim of the study is to carry out the morphological feature of right lobe, left lobe, caudate lobe, quadrate lobe and surfaces of liver.

---

### Corresponding Author:

**Mrs. Priyanka N. Sharma**

Assistant Professor, Department of Anatomy, Smt. B.K. Shah Medical Institute and Research Center, Sumandeep Vidyapeeth At & Po. Pipariya, Vadodara, Gujarat, 391760.

Mob. No.: 9427877293

e-mail: priyanka.sweet28@gmail.com

## Materials and Method

This is retrospective observational study done in Department of anatomy, Smt. B.K. Shah Medical Institute and Research Center, Vadodara, Gujarat. The ethical approval for the study was taken before the study. There are 75 cadaveric livers of unknown age and sex collected from routine dissection of medical undergraduate student during dissection and preserved in 10% formalin solution. Any damage or pathology of livers were excluded from the study. The livers were studied for morphological variation such as Accessory fissure, Mini accessory lobe, Pons hepatis which connecting quadrate lobe with left lobe of liver, Riedel's lobe present, Elongated and narrow left lobe, Absence of quadrate lobe, Absence of fissure for ligamentum teres, Quadrate lobe with tongue like projection, Bilobed caudate lobe on right lobe, left lobe, caudate lobe, quadrate lobe and surfaces of liver and classified according to Netter's classification<sup>2</sup>. Each morphological variation was documented carefully with photograph. All data were recorded and calculated.

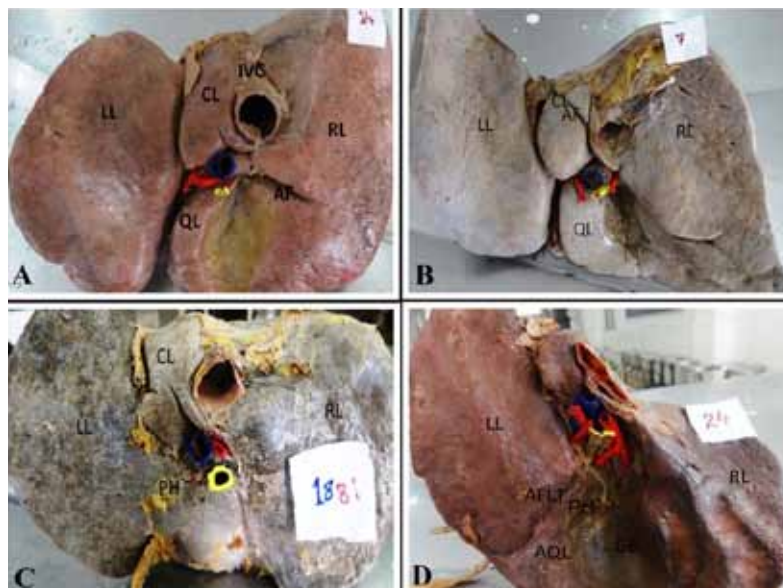
## Results and Discussion

Out of 75 embalmed human liver 23 (30.67%) livers were normal not showing any variant feature. 52 (69.33%) livers shown one or more than one

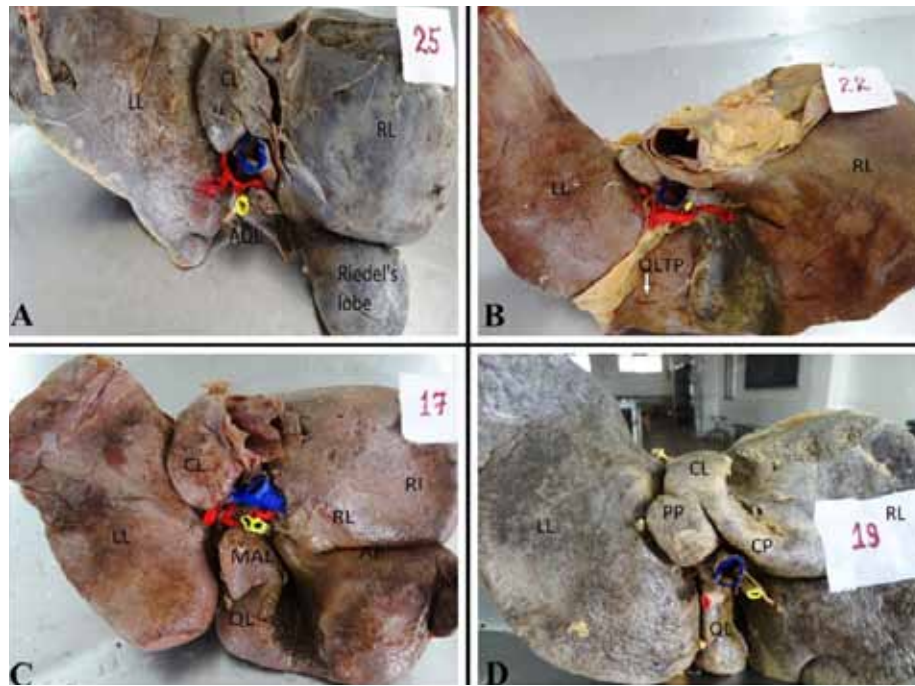
morphological variation of liver. These data suggest a high incidence of morphological variation in the liver.

Very common the accessory fissure on right lobe seen in 13 (17.33%) specimens (Figure 1A, 3A) and accessory fissure on left lobe in 1 (1.33%). Accessory fissure on caudate lobe observed in 5 (6.66%) specimens (Figure 1B) and accessory fissure on quadrate lobe in 4 (5.33%) specimens (Figure 3A). Mini accessory lobe were present in 4 (5.33%) (Figure 2C). Quadrate lobe with tongue like projection were found in 4 (5.33%) specimens (Figure 2B, 2D) and Riedel's lobe which was extra lobe on right lobe were present in 3 (4%) specimens (Figure 2A). Pons hepatis which connecting left lobe to quadrate lobe were seen in 2 (2.66%) specimens (Figure 1C). Narrow and elongated left lobe seen in 7 (9.33%) specimens (Figure 3B).

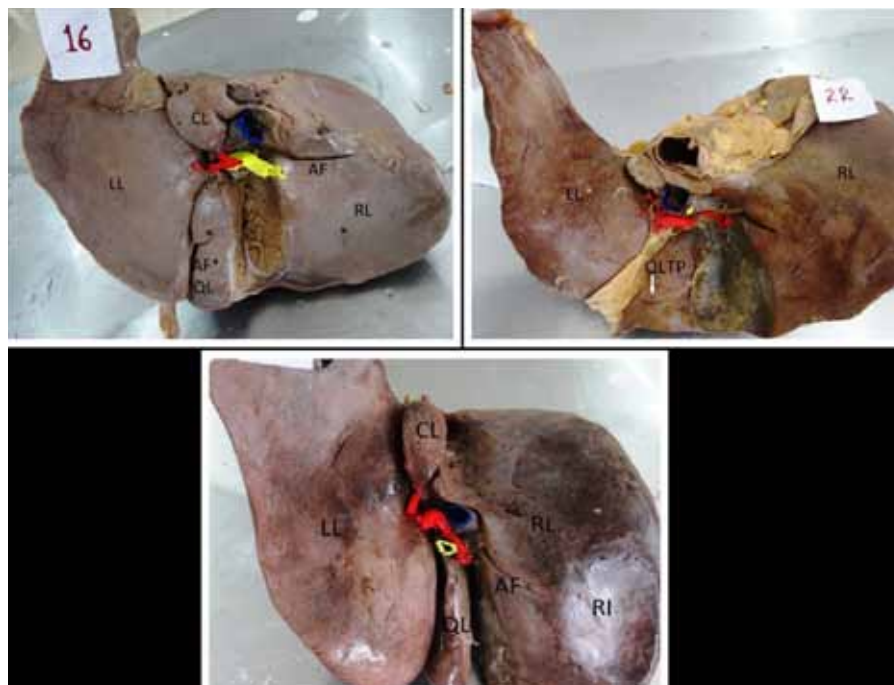
Other variations noted were absence of quadrate lobe in 2 (2.66%) specimen, absence of fissure for ligamentum teres in 2 (2.66%) specimens (Figure 1C, 1D). A complete transverse fissure dividing quadrate lobe in bilobed were present in 2 (2.66%) specimens (Figure 2C). The enlarged papillary process and caudate process found in 2 (2.66%) (Figure 2D) specimens. And also done classification of livers were as stated by Netter's into six types. (Figure 3B, 3C)<sup>2</sup>.



**Figure 1 A:** Liver showing RL- Right Lobe, LL- Left lobe, QL- Quadrate Lobe, CL- Caudate Lobe, AF- Accessory Fissure on Right lobe, IVC- Inferior Vena Cava, **Figure B:** Liver showing RL- Right Lobe, LL- Left lobe, QL- Quadrate Lobe, CL- Caudate Lobe, AF- Accessory Fissure on Caudate Lobe, **Figure C:** Liver showing PH- Pons hepatic connecting left lobe with quadrate lobe, RL- Right Lobe, LL- Left lobe, QL- Quadrate Lobe, CL- Caudate, **Figure D:** Liver showing AFLT- Absence of Fissure for Ligamentum Teres, AQL- Absence of Quadrate Lobe, GB- Gall Bladder, PH- Pons hepatic connecting left lobe with quadrate lobe, RL- Right Lobe, LL- Left lobe, QL- Quadrate Lobe, CL- Caudate.



**Figure 2 A:**Liver showing Riedel’s lobe, AQL- Absence of Quadrate Lobe, RL- Right Lobe, LL- Left lobe, QL- Quadrate Lobe, CL- Caudate, **Figure B:**Liver showing LL- Narrow and Elongated Left lobe, QLTP- Quadrate Lobe with Tongue like Projection, RL- Right Lobe, CL- Caudate, **Figure C:**Liver showing MAL- Mini Accessory Lobe, AS- Accessory Lobe, RI- Deep Renal Impression LL- Left lobe, RL- Right Lobe, CL- Caudate, **Figure D:** Liver showing, CL- Caudate, PP- Large Papillary Process, CP- Long Caudate Process, QL- Quadrate Lobe, LL- Left lobe, RL- Right Lobe.



**Figure 3 A:**Liver showing AF- Accessory Fissure on Right Lobe, AF\*- Accessory Fissure on Quadrate Lobe, RL- Right Lobe, CL- Caudate, LL- Narrow and Elongated Left lobe, **Figure B:** Netter’s Type 4 - Liver showing QLTP- Quadrate Lobe with Tongue like Projection, RL- Right Lobe, CL- Caudate, LL- Narrow and Elongated Left lobe, **Figure C:**Netter’s Type 5 - Liver showing CL- Caudate Lobe AS- Accessory Fissure, LL- Left lobe, QL- Quadrate Lobe, RI- Deep Renal Impression, RL- Right Lobe.

**Table 1: Different morphological features of liver.**

S.No.	Morphological features	Number of specimens	Frequency %
1	Normal	23	30.7
2	Accessory fissures right lobe	13	17.3
3	Accessory fissures on left lobe	1	1.3
4	Accessory fissures on caudate lobe	5	6.7
5	Accessory fissures on quadrate lobe	4	5.3
6	Mini accessory lobe	4	5.3
7	Quadrant lobe with tongue like projection	4	5.3
8	Riedel's lobe present	3	4
9	Pons hepatis connecting left lobe with quadrate lobe	2	2.7
10	Elongated and left lobe	7	9.3
11	Absence of quadrant lobe	2	2.7
12	Absence of fissure for ligamentum teres	2	2.7
13	Superior and Inferior quadrate lobe	2	2.7
14	Bilobed caudate lobe	2	2.7
15	Large papillary process of caudate lobe	1	1.3
16	Long caudate process of caudate lobe	1	1.3

**Table 2: Classification of liver morphology according to Netter<sup>2</sup>**

S.No.	Netter type	Number of specimens
1	Type 1 (Very small left lobe, deep costal impressions)	1
2	Type 2 (Complete atrophy of left lobe)	-
3	Type 3 (Transverse saddle like liver, relatively large left lobe)	1
4	Type 4 (Tongue like process of right lobe)	3
5	Type 5 (Very deep renal impression and corset constriction)	15
6	Type 6 (Diaphragmatic grooves)	2

Congenital anomalies of liver confront are lobes does not developed or a segment, lobes may be malformed or may be tiny. These anomalies may occur due to abnormal cell lines in the septum transversum in which the liver develops<sup>3</sup>. Most of the times the liver exhibits malformation due to any change in the microenvironment during organogenesis<sup>4</sup> and it needs to be researched. Such studies have been carried out by many research workers throughout the world and in the country but no such research work has been carried out in rural Gujarat.

The present study conducted on various lobes of liver. Variations in the fissures were studied by many researchers<sup>5-13</sup>. A study carried out by *Joshi D et al*<sup>6</sup> reported 30% of accessory fissures in their study. Similar another study was conducted by *Patil et al*<sup>14</sup>

and *Chadhari et al*<sup>4</sup> revealed 14% and 17.5% of the livers had accessory fissures. In the present study, the accessory fissures were also present in 30.67% of livers.

Presence of accessory lobes presented on caudate lobe, quadrate lobe and left lobe. It was found to be 5.33% of livers in the present study. The similar finding was seen by *Chaudhari et al*<sup>4</sup>, 3.7%. And *Patil et al* found lower incidence was 2%.

Pons hepatis is connecting left lobe with quadrate lobe. Pons hepatis was seen 2.66% of the liver in the present study. The similar finding was observed by *Chaudhari et al*<sup>4</sup> reported in 1.25%. Where in other studies found higher incidence as *Patil et al* reported 10%, *Joshi et al*<sup>6</sup> reported 30%. Clinically, metastatic

hepatomas have been found originating from the pons hepatitis as well as harboring site of peritoneal disseminated tumor cells.

In present study, it was seen absence of fissure for ligamentum teres in 2.66%. The similar finding was seen by *Nayak et al* reported 1.81 % and *Patil et al* observed 4% incidence in liver. Where in other studies found higher incidence as *Chaudhari et al*<sup>4</sup> reported 11.2%, *Muktyaz et al*<sup>9</sup> seen 9.7%.

The prominent papillary process and long caudate process were seen in 1.25% specimen in our study,

similar to findings of *Nayak et al*<sup>11</sup> and *Chaudhari et al* results. When enlarged papillary process or prominent papillary process it is look like body mass of pancreas in cirrhosis of liver. Caudate lobe enlargement commonly accompanies occlusion of the hepatic veins; along with patchy areas of low and high attenuation on CT.

Elongated and narrow left lobe found in 9.33% incidence in our study which was similar with that of *Chaudhari et al*<sup>4</sup> observed in 12.5%. Where as it was found low incidence in *Nayak et al*<sup>11</sup>, 1.81%.

**Table: 3 Comparison between present study and other studies.<sup>4</sup>**

Morphological features	Chaudhari et al <sup>[4]</sup> (%)	Joshi SD et al <sup>[6]</sup> (%)	Nayak BS <sup>[11]</sup> (%)	Patil S et al <sup>[14]</sup> (%)	Sarita et al <sup>[15]</sup> (%)	Present study (%)
Normal liver	17.5	-	60	56	66	30.7
Accessory Fissures	12.5	30	1.81	10	34	30.7
Accessory Fissures on caudate lobe	3.7	-	-	-	6	6.7
Bilode Quadrate Lobe	7.5	20	-	4	-	2.7
Pons hepatitis connecting left lobe with quadrate lobe	1.25	30	-	10	-	2.7
Absence of fissure for ligamentum teres	11.2	-	1.81	4	-	2.7
Riedel's lobe present	1.25	-	-	-	2	5.3
Elongated left lobe present	12.5	-	1.81	-		9.3
Accessory Mini lobe present	3.7%	-	-	2%		5.3
Large papillary process	1.25%	32%	1.81	-	4	1.3

## Conclusion

It is emphasized the importance of the liver morphology of the Gujarati population. The findings of our study highlights some of variations in fissure and lobes of the liver. With advances in liver surgical procedures like laparoscopic thermal ablation for patients with hepatic tumour and laparoscopic hepatectomy, these variations presume more importance. The presence of knowing extra lobes and fissure lies in the fact that might help to interpretation during imaging of hepatobiliary system and may intern lead to surgical implication in operation theater.

**Acknowledgement:** I express my sincere gratitude to the generous donors who donated their bodies for academic and research purposes. Without cadavers this research would have not been possible.

**Source of Funding:** No funding.

**Conflicts of Interest:** The author declares no conflict of interest.

**Ethical Clearance:** Ethical approval to undertake the present study was obtained from the Institution Ethical Committee (IEC).

## References

1. Standring S. Gray's Anatomy. The anatomical basis of clinical practice 40[1]<sup>th</sup> ed. New York: Churchill Livingstone.2008; 3441-46.
2. Netter FH. Atlas of Human Anatomy. 2ed. New York: 18 Guilford Press. 2000.
3. Daver GB, Bakhshi GD, Patil A, Ellur S, Jain M, Daver NG, Bifid liver in a patient

- with diaphragmatic hernia. *Indian Journal of Gastroenterol.* 2005;24(1):27-28.
4. Chaudhari HJ, Ravat MK, Vaniya VH, Vedi AN, Morphological study of human liver and its surgical importance, *Journal of Clinical Diagnosis Research.* 2017;11(6):AC9-AC12.
  5. Daver GB, Bakhshi GD, Patil A, Ellur S, Jain M, DaverNG, Bifid liver in a patient with diaphragmatic hernia, *Indian Journal of Gastroenterol.* 2005; 24(1):27-28.
  6. Joshi SD, Joshi SS, Athavale SA, Some interesting observations on the surface features of the liver and their clinical implications, *Singapore Medical Journal.* 2009;50(7):715-719.
  7. Macchi V, Feltrin G, Parenti A, De Caro R, Diaphragmatic sulci and portal fissures, *Journal of Anatomy.* 2003;202(3):303-308.
  8. Meirelles GSP, G. D'Ippolito, Liver pseudo lesions in helical CT: pictorial essay, *Radiol Bras.* 2003;36:229-235.
  9. Muktyaz H, Nema U, Morphological variations of liver lobes and its clinical significance in north Indian population, *Global Journal of Medicine and Medical Science.* 2013;1(1):1-5.
  10. Nagato AC, Silva MAS, Trajano ETL, Alves JN, Bandeira ACB, Ferreira TA, Valenca SS, Bezerra FS, Quantitative and morphological analyses of different types of human liver, *Journal of Morphological Sciences.* 2011;28(4):275-279.
  11. Nayak B, A study on the anomalies of liver in the south Indian cadavers. *International Journal of Morphology.* 2013;31(2):658-61.
  12. Pujari BD, Deodhare SG, Symptomatic accessory lobe of liver with a review of the literature. *Journal of Postgraduate Medicine.* 1976;52:234-236.
  13. Sato S, Wantanabe M, Nagasawa S, Laproscopic observations of congenital anomalies of the liver, *Gastrointest Endosc.* 1998; 47 (2):136-140.
  14. Patil S, Sethi M, Kakar S, Morphological study of human liver and its surgical importance. *International Journal of Anatomy and Research.* 2014;2(2):310-314.
  15. Sarita S, Ramani N, Yesender A, Cadaveric study of morphological variations in human liver and its clinical importance, *International journal of medical science and clinical invention.* 2015;2(6):1020-1031.

# Informed Consent to Patients in Root Canal Treatment (Case Study: Melati Dental Clinic Jakarta, Indonesia)

Pudentiana Rr RE<sup>1</sup>, Tedi Purnama<sup>1</sup>, Syifa Yulia Lestari<sup>2</sup>, Yulianti<sup>3</sup>

<sup>1,2</sup>Assistant Professor, <sup>3</sup>Lecturer, Department of Dental Health, Health Polytechnic of Jakarta I, Indonesia,  
<sup>4</sup>Dental Nurse, Melati Dental Clinic Jakarta, Indonesia

## Abstract

Teeth with necrosis require root canal treatment. Before taking any action, the treatment plan that will be carried out along with the risks must be explained clearly to the patient and his family, and then must get informed consent for the treatment plan. The purpose of this study was to the description of informed consent in patients with root canal treatment at the Melati Dental Clinic in Jakarta. **Method:** This research uses descriptive method with research sample using technique total sampling of 50 respondents. The data used are secondary data taken from the patient's medical record. Results: Respondents 33 people (66%) provided complete informed consent and 17 people (34%) did not give complete informed consent. Respondents doing root canal treatment caused by caries as many as 38 people (76%) and respondent root canal treatment caused not because of caries as many as 12 people (24%). Respondents provided complete informed consent in patients with root canal treatment because of caries by 27 people (71%) and giving complete informed consent not because of caries by 6 people (50%). Whereas giving informed consent was incomplete because of caries as many as 11 people (29%) and incomplete informed consent was not due to caries as many as 6 people (50%). Conclusion: Management of Informed Consent in Root Canal Treatment patients at Melati Dental Clinic in Jakarta has been carried out well.

**Keywords:** *Informed Consent, Root Canal Treatment.*

## Introduction

Dental and oral health services are carried out to maintain and improve the degree of public health in the form of improving dental health, dental disease, dental disease treatment and restoration of dental health by the central government, regional governments or the community which are carried out in an integrated, integrated and sustainable manner.<sup>1</sup>

Dental health is an integral part of overall health that can affect quality of life.<sup>2</sup> The most prominent dental

health problems in Indonesia a problem of tooth loss due to dental caries. Dental caries is experienced by 90% of Indonesian people.<sup>3</sup>

The results of the Basic Health Research in 2018 reported that 92.2% of Indonesia's population aged 35-44 years experienced dental health problems; a DMF-T index of 6.9 means that the average number of tooth decay is 6 to 7 teeth per person.<sup>4</sup>

Dental caries is a process of demineralizing tooth hard tissue structures such as dentin and enamel. Dental caries or cavities is a dental and oral health problem that is often experienced by almost all people in Indonesia.<sup>5</sup> According to Tarigan (2013) dental caries is a disease of dental tissue characterized by tissue damage, starting from the surface of the teeth extending towards the pulp. Dental caries can be experienced by anyone and can arise on one or more surfaces, and can extend to deeper parts of the teeth, for example from enamel to dentin or to the pulp.<sup>6</sup>

---

### Corresponding Author:

**Tedi Purnama**

Department of Dental Health, Health Polytechnic of Jakarta I, Wijaya Kusuma Raya Street, No. 47, Jakarta, Indonesia

e-mail: tedypurnama23@yahoo.com



Untreated caries results in disruption of maximal dental function. Tooth decay can be preceded by pulp inflammation and if not treated can continue with pulp death or what is known as pulp necrosis. Teeth with necrosis require root canal treatment, which aims to clear the pulp chamber from infected pulp tissue, then form a root canal for obturation to form an apical seal.<sup>7</sup>

Root canal treatment often requires the removal of enough hard tissue so that it leaves little hard tissue and cannot support the restoration properly because it is easy to crack or fracture. Root canal treatment is done in several visits.<sup>7</sup> Before taking any action, the plan of treatment that will be carried out along with the risks must be explained clearly to the patient and his family, and then must get approval for the action plan.<sup>8</sup>

Informed consent is the consent obtained by the doctor given by the patient or family on the basis of an explanation of the medical action in the form of examination, treatment or any medical action that will be carried out on the patient.<sup>9</sup> Approval of medical treatment can be stated verbally and in writing. Verbal consent where the patient states the patient's consent verbally and does not sign in written form, whereas written consent is needed in the case of broad interventions involving risks where anesthesia or sedation is used as a restorative, invasive or surgical procedure, administration of high risk drugs.<sup>10</sup>

Dentists in providing services to patients need to be vigilant, given the various cases that occur due to carelessness which ultimately lead to legal problems, including due to the incompleteness of one of the means in dentistry services to the public, namely the completeness of medical action approval letters on medical services to patients.<sup>11</sup> Considering the risk of the treatment, in anticipation of a continuing dispute, it is better that the consent given by the patient to the dentist who will treat it be given in writing.<sup>8</sup> Research Herwanda et al (2016) using a questionnaire on young gig doctors at Hospitals Teeth and Mouth Unsyiah, showed that subjects who used informed consent with good criteria were 246 people (95.0%), moderate criteria were 12 people (4.6%), and bad criteria of 1 person (0.4%).<sup>10</sup>

Melati Dental Clinic is a private dental clinic in Central Jakarta that provides general and specialist

dentistry services. The 2019 dental clinic report shows that there are three dental diseases with the highest number, namely pulp necrose, dental caries and pulpitis. This shows that root canal treatment is often done as a treatment for pulp necrose.

Based on the above background the authors are interested in conducting research under the title "Informed Consent in Root Canal Treatment patients in Melati Dental Clinic Jakarta"

## Method

The research design used is descriptive research, is a method of research conducted with the main objective to make a picture or description of a situation objectively.<sup>12</sup> This study was intended to look at the description of giving informed consent to root canal treatment patients at the Melati Dental Clinic in Jakarta. The population in this study were all medical records Jakarta Melati Dental Clinic patients who performed root canal treatment in January to March 2020 amounting to 50 patients. The sampling technique uses total sampling i.e. the entire population is sampled, so the sample this study as many as 50 patients. This study uses secondary data taken from the medical records of elderly people who have performed dental care in the period of January to March 2020, then recorded using the recapitulation sheet specified by the researchers. This research was processed and analyzed in an excel program and presented in the form of a frequency distribution.

## Result

**Table 1. Frequency distribution providing informed consent**

No.	Complete Informed Consent	Frequency	Percentage (%)
1	Yes	33	66
2	Not	17	34
<b>Total</b>		<b>50</b>	<b>100</b>

Table 1 to show that respondent 33 people (66%) received complete consent in root canal treatment and 17 people (34%) received incomplete informed consent

**Table 2. Frequency distribution causes of root canal treatment**

No.	Root canal treatment	Frequency	Percentage (%)
1	Root canal treatment because of caries	38	76
2	Root canal treatment not because of caries	12	24
<b>Total</b>		<b>50</b>	<b>100</b>

Table 2 shows that respondents treated root canals because of caries by 38 people (76%) and treated root canals not because of caries by 12 people (24%).

**Table 3. Frequency distribution of complete informed consent for patients with root canal treatment**

Complete Informed Consent	Root canal treatment			
	Because of caries		Not because of caries	
	n	%	n	%
Yes	27	71	6	50
Not	11	29	6	50
<b>Total</b>	<b>38</b>	<b>100</b>	<b>12</b>	<b>100</b>

Based on table 3, shows that respondents provided complete informed consent for root canal treatment because of caries by 27 people (71%) while giving complete informed consent for root canal treatment not for caries by 6 people (50%). Respondents provided incomplete informed consent for root canal treatment because of caries by 11 people (29%) while incomplete informed consent for root canal treatment was caused not by caries as many as 6 people (50%).

## Discussion

The results of the study gave informed consent obtained by respondents given complete informed consent on root canal treatment as many as 33 people (66%) and incomplete informed consent as many as 17 people (34%). This is in accordance with research Herwanda et al (2016) showed that research subjects using informed consent were 95.0%. So it can be interpreted that previous studies have compliance giving informed consent that is better than the results of research conducted by researchers. This causes the doctor to not comply in giving informed consent because doctors' knowledge about the legal consequences of informed consent is also lacking. Lack of doctor's knowledge regarding the legal consequences of informed consent

can lead to a lack of physician compliance in carrying out informed consent to patients.<sup>13</sup> Strengthened statement Oktarina (2010), every medical action requires informed consent.<sup>9</sup>

Based on the explanation of the Regulation of the Minister of Health of the Republic of Indonesia No. 290/MENKES/PER/III/2008 in Elisa et al 2016, informed consent is a one-sided statement of a patient or the legal one representing it in the form of approval of a medical or dental action plan submitted by a doctor or dentist, after receiving sufficient information to be able to making approval or rejection.<sup>14</sup> In this case, the doctor who is obliged to provide information is the doctor who knows the patient's condition and matters relating to the medical actions to be taken, including the dentist at the Melati Dental Clinic in performing root canal treatment.

Root canal treatment often requires a large amount of hard tissue removal that leaves little hard tissue and cannot support the restoration properly because it is easy to crack or fracture so that it can be done with several visits.<sup>7</sup> Also reinforced statements Budi (2013) to anticipate the occurrence of ongoing disputes, the consent of the patient to the dentist who will treat him should be given in writing.<sup>8</sup>

Results research overview of root canal treatment obtained by respondents 38 people (76%) did root canal treatment because of caries and 12 people (24%) did root canal treatment. This study shows the greater treatment of root canals caused by caries. This is in accordance with research Setyaningsih (2015) that indicated that the treatment of root canal treatment of patients in Hospitals Teeth and Mouth UNEJ was 36% and the main cause was caries.<sup>15</sup> Untreated caries results in disruption of maximal dental function. Tooth decay can be preceded by pulp inflammation and if not treated can continue with pulp death/necrosis. Teeth with necrosis require root canal treatment. Besides the causes of root canal treatment is not due to caries which is caused by other causes for example: trauma, chronic tooth abrasion and chronic periodontitis so that retroinfection occurs.<sup>7</sup>

The results showed that giving informed consent to root canal treatment patients because caries had been done well, although informed consent was still found. That is due to several things that occur including, there is no policy at Melati Dental Clinic in Jakarta in the use of informed consent so that the standard operating procedures for dentists and dental nurses give informed

consent to patients before root canal treatment is not carried out properly, especially if the patient's condition so much that doctors and dental nurses forget to give informed consent. In addition there are usually also a number of patient requests that want to be done quickly because their teeth are sick and some who want to hurry home so that informed consent is incomplete.

### Conclusion

Management informed consent on root canal treatment patients at the Melati Dental Clinic in Jakarta has been implemented well.

**Source Funding:** This study was done by self-funding from the authors.

**Conflict of Interest:** The authors declare that they have no conflict interests.

**Ethical Clearance:** The ethical clearance taken from Ethical Committee of Health Research, Health Polytechnic of Jakarta.

### Reference

- 1 Ministry of Health. Guidelines for Basic Package for Dental and Oral Health Services in Community Health Centers. Jakarta Directorate General of Health Efforts the Ministry of Health Republic of Indonesia. 2012.
- 2 Purnama T, Rasipin R, Ngatemi. Tedi's Behavior Change Model to Improving Brushing Teeth Behavior Parents. *J Appl Health Managemant Technology*. 2020; 2 (1): 1–12.
- 3 Notohartoyo IT, Suratni MAL, Riyadina W, Nainggolan O. Dental Caries Value of Industrial Zone Employees in Pulo Gadung Jakarta. *Research Mediaian and Health Development*. 2011; 21 (4).
- 4 Ministry of Health. Main Results of Basic Health Research in 2018. Ministry of Health Republic of Indonesia. 2018; 1–100.
- 5 Sosiawan A, Heroesoebekti R, Hapsoro A, Santosa LM. Description of Severity of Dental Caries in Women Age 36-45 Years Claket Hamlet Claket Village Pacet District Mojokerto Regency in April 2016. *Dental Public Health Journal*. 2015; 6 (2): 1–12.
- 6 Tarigan R. Dental caries. Jakarta EGC. 2013.
- 7 Triharsa S, Mulyawati E. One-Visit Root Canal Treatment in Necrotic Pulp Accompanied by Crown Restoration of a Metal Fusion Porcelain Jacket with Fiber Reinforced Composite Stakes (Case of Maxillary Right Central Incisor Tooth). *MajIndonesian Dental Medical Center*. 2013; 20 (1): 71–7.
- 8 Budi AT, Jahja M. Application for Intracorona Dental Whitening Care. *Journal of Nursing*. 2018; 6 (1): 42-4.
- 9 Oktarina O. Informed Consent Policy in Dental Services in Indonesia Dental Care Informed Consent Policy in Indonesia. *Jurnal Management of Health Services*. 2010; 13 (01).
- 10 Herwanda H, Rahmayani L, Fadhilla S. Description of the Use of Informed Consent by the Young Dentist at RSM Unsyiah. *Cakradonya Dent J*. 2016; 8 (2).
- 11 Juliawati M. The importance of an informed consent for a doctor's practice tooth. *J PDGI*. 2014; 63 (2): 46–53.
- 12 Notoatmodjo S. Health research methodology. Jakarta: Rineka Cipta; 2010.
- 13 Fikriya K, Sriatmi A, Jati SP. Analysis of Approval of Medical Action (Informed Consent) in the Framework of Hospital Accreditation Preparation in the Central Surgical Installation of Semarang City Hospital. *Journal of Public Health*. 2016; 4 (1): 44-54.
- 14 Elisa F, Busro A, Suharto R. Informed Consent Legal Study on Therapeutic Agreements between Doctors and Underage Patients Based on Minister of Health Regulation No. 290/Minister of Health/Per/III/2008 Regarding the Approval of Medical Measures. *Diponegoro Law J*. 2016; 5 (1): 11.
- 15 Setyaningsih LS. Prevalence of Indications for Endodontic Care in Patients Visiting the 2015 UNEJ RSGM. Jember State University. 2015.

# Assess Knowledge and Attitudes on First-Aid Measures for Selected Domestic Accidents among Caretakers of Under-Five Children

Pushplata Manta<sup>1</sup>, Kanu Mahajan<sup>2</sup>, Kanika Guleria<sup>3</sup>

<sup>1</sup>Nursing Tutor, <sup>2</sup>Nursing Tutor, <sup>3</sup>Assistant Professor, Chitkara School of Health Sciences, Chitkara University Punjab

## Abstract

**Background:** Mishaps are one of the fifth driving reasons for death in industrialized and creating nations. Wounds emerging from mishaps are an expanding general medical issue. Mishaps are a noteworthy reason for dreariness and mortality in kids.

**Objectives:** The present study was undertaken to find out the knowledge level of women regarding domestic accidents among children.

**Method:** A descriptive comparative research design was used for the present study. A study sample of 100 care takers of under- five children (50 residing in rural area and 50 residing in urban area) were selected with help of purposive sampling method. Structured questionnaire was used to assess the knowledge and Likert scale was used to find out the attitude regarding first aid measures regarding selected domestic accidents among under five children.

**Results:** In rural area maximum numbers of care takers had average knowledge regarding domestic accidents i.e. 74%, 22% had good knowledge and 4% had below average. Where as in urban area maximum numbers of care takers had average knowledge regarding domestic accidents i.e. 62%, 33% had good knowledge and 8% had below average. In rural area maximum numbers of care takers had undecided attitude regarding domestic accidents i.e. 64%, 36% had strongly disagree attitude and 0% had strongly agree attitude regarding statements. Where as in urban area maximum numbers of care takers had undecided attitude regarding domestic accidents i.e. 78%, 20% had strongly disagree attitude and 2% had strongly agree attitude regarding statements.

**Conclusion:** The study findings concluded that majority of care takers have average knowledge and undecided attitude towards domestic accidents of under five children. So, the researcher provides the information booklet to enhance and improve knowledge and attitude of care takers towards domestic accidents.

**Keywords:** Mothers, Age, Education, Occupation, Socio-Economic Status.

## Introduction

In this day and age, in the created just as the creating nations, risk wins on the streets, yet it likewise exists in the home and play areas. Consistently, a large number of kids pass on or for all time incapacitated because of inadvertent wounds. In many creating nations, wounds are one of the real reasons for death in youngsters in the age gathering of 1-5 years. Children brea the life into scent and significance, they are an endowment of god and

we are the planters to address their issues, we give the best to them by appropriate consideration, sustenance, love, consideration and great wellbeing.<sup>(1)</sup> It is evaluated that number of passing from residential accidents and injuries in 2005 would extend from 730,000 to 985,000 with projections that passing from wounds will increment by as much as 25% throughout the following decade.<sup>(2)</sup> The damage mortality gauges for the year 2002 recommend that about 9% of all passing in India,

were represented by all wounds share like the worldwide portion of passing because of wounds. Accessible proof from India likewise demonstrates that a great part of the mortality from wounds because of mishaps, murder more kids.

**Material and Method:** Quantative research approach with descriptive comparative research design was adopted to accomplish the objective of the study that is to estimate the knowledge and attitude level on first-aid measures regarding selected domestic accidents among caretakers of under-five children in selected rural and urban areas of District Fatehgarh Sahib, Punjab.

Ethical clearance was obtained from ethical committee of Desh Bhagat University, Mandi Gobindgarh to conduct the study. Written permission had been taken from Municipal committee of Amlah Shansi Mohalla (Urban Area) and Jalalpur and Baronga Buland of (rural area). Confidentiality and anonymity of the study subjects was maintained.

Permission letter was taken from Director of DBUSON and Sarpanch Baronga and Jalalpur of (rural area) and Municipal committee of Amlah (urban area). The study was conducted on a sample of 100 care takers who were selected by using Non-probability purposive sampling technique, out of which 50 care takers were selected from rural area and 50 care takers were selected from urban area of district Fatehgarh Sahib. The demographic Performa sheet was filled by care takers. A self-structured questionnaire was administered to sample to assess their knowledge level regarding domestic accidents of under- five children. Likert scale performa was administer to assess the attitude of care takers regarding domestic accidents.

**Results**

A total 100 samples were interviewed in this study. The knowledge regarding domestic accidents in family were In rural area. maximum Education of care takers(54%) was primary education followed by (42%) was matric and (4%) was secondary education whereas in urban area education of care takers (58%) was primary education, (34%) was matric followed by (4%) was secondary and (4%) was graduate and above. According to family income of the maximum care takers

in rural area (66%) had family income below 10,000 followed by (30%) had family income Rs 10000-20000, (4%) had more than and equal to Rs 30,000, whereas the maximum family income of care takers of under five children in urban area (34%) had family income between 20,000-30,000 followed by (26%) had family income below equal to Rs 10000, (22%) had more than and equal to Rs 30,000 and above followed by the (18%) had Rs 10000-20000. . Maximum care takers of under five children in rural area (46%) had gained information from media followed by (30%) had gained information from relatives, (24%) had gained information from health personals, whereas in urban area (78%) had gained information from media and followed by (10%) had gained information from any other source, (8%) had gained information from mass relatives (4%) from health personals. According to type of accident maximum in rural area had not met any type of accident (82%) (18%) have met type of accident. Where as in urban area (20%) had accident followed by (80%) do not have any accident.

**Table 1: Criterion Measure of knowledge Score among care takers residing in Rural Area and Urban Area N = 100 n<sub>r</sub> = 50 n<sub>u</sub> = 50**

Level of knowledge	Rural Area		Urban Area	
	(f)	(%)	(f)	(%)
Good (21-30)	11	22	15	30
Average (11-20)	37	74	31	62
Below Average (0-10)	02	04	04	08

Maximum Knowledge score: 1  
 Minimum Knowledge score: 0

Table 1 depicted the level of knowledge score among care takers residing in Rural area(22%) had good level of knowledge followed by (74%) had average level of knowledge, followed by (04%) had below average knowledge whereas in urban area (30%) had good level of knowledge followed by (62%) had average level of knowledge and (08%) had below average level of knowledge

Hence it was concluded that the majority of care takers had average knowledge score on first aid measures regarding domestic accidents among rural area and urban area

**Table 2: Criterion Measure of attitude Score of care takers of Rural Area and Urban Area Children****N = 100 n<sub>r</sub> = 50 n<sub>u</sub> = 50**

Level of Attitude	Rural area		Urban area	
	(f)	(%)	(f)	(%)
Strongly agree (38-48)	00	00	01	02
Undecided (27-37)	32	64	39	78
Strongly disagree (16-26)	18	36	10	20

Maximum score: 3

Minimum score: 1

Table 2 depicted the frequency and percentage distribution of level of attitude among caretakers residing in Rural and Urban area. It shows that care takers of rural area(00%) had strongly agree about the statements followed by (64%) had undecided about the statements, followed by (36%) had strongly disagree about the statements whereas care takers of urban area (02%) had strongly agree about the statements followed by (78%) had undecided about the statements and (20%) had strongly disagree attitude towards first aid management for selected domestic accidents.

Hence it was concluded that the majority of care takers had undecided statements on first aid measures regarding domestic accidents among rural area and urban area.

### Discussion

The aim of study was to compare knowledge level and attitude level on first-aid measures for selected domestic accidents among caretakers of under-five children residing in selected rural and urban areas of District Fatehgarh Sahib, Punjab with a view to develop and distribute an information booklet.

The present study shows that care takers of Rural area(22%) had good level of knowledge followed by (74%) had average level of knowledge, followed by (04%) had below average knowledge whereas in urban area (30%) had good level of knowledge followed by (62%) had average level of knowledge and (08%) had below average level of knowledge . These findings are consistent with the findings of **Thein MM, Lee BW, Bun PY**, who conducted a study to assess the knowledge level, attitude level and practices of childhood injuries and their prevention by primary caregivers in Singapore. The study result revealed that primary caregivers had poor knowledge on home accidents and first aid.<sup>(5)</sup>

It shows that care takers of rural area(00%) had strongly agree about the statements and(64%) had undecided about the statements, followed by (36%) had strongly disagree about the statements regarding domestic accidents whereas care takers of urban area(02%) had strongly agree about the statements followed by (78%) had undecided about the statements and (20%) had strongly disagree attitude towards first aid management for selected domestic accidents.

The present study compares the knowledge on first aid measures regarding selected domestic accidents among caretaker of under five children in rural and urban areas. It showed the mean, standard deviation and 't' value of knowledge score of care takers regarding selected domestic accidents. The data showed that the mean knowledge score and standard deviation of urban area care takers (18.0±4.20) was higher than the mean knowledge score of the rural care takers (17.4±3.51). The calculated 't' value of 0.77 was found as statistically non -significant.

This study compared the attitude on first aid measures regarding selected domestic accidents among caretakers of under five children in rural and urban areas. The findings of study showed the mean, standard deviation and 't' value of attitude score of care takers regarding selected domestic accidents. The data showed that the mean knowledge score and standard deviation was higher in urban area (29.3±3.72) as compared to rural care takers (28.0±3.37). The calculated 't' value of 1.80 was found statistically non-significant.

In present study the association between knowledge score of caretakers regarding first aid measures on selected domestic accidents with their demographic variables was seen. The findings of the study showed that there was no significant association of knowledge score with selected demographic variable ( $p \leq 0.05$ ). i.e.gender, religion, type of family, relation with child, Educational status, Family monthly income, source of information, any type of accident, with knowledge of care takers regarding selected domestic accidents among under -five children in selected area of Distt. Fatehgarh Sahib.

The study find the association between attitudes score on first aid measures regarding selected domestic accidents with their demographic variables. The findings of the study showed that there was not any significant association of following demographic variables age,

gender, religion, type of family, relation with child, Educational status, Family monthly income, source of information, any type of accident, with attitude of care takers regarding selected domestic accidents among under-five children in selected area of Distt. Fatehgarh Sahib.

### Conclusion

The finding of this study indicates the need of giving more focus on knowledge regarding domestic accidents in rural areas and creating awareness regarding these accidents through information booklets and health education programmes in the community. Although the knowledge score was good in urban area it also needs to improve the knowledge regarding these types of domestic accidents. The above measure will help to reduce these types of domestic accidents among under five children.

**Ethical Clearance:** Taken from Ethical committee of Desh Bhagat University, Mandi Gobindgarh.

**Source of Funding:** Self

**Conflict of Interest:** Nil

### References

1. Clin J A, Izmir H Y. Accidents and mother's measurements in preschool children. 2010; 4(1):15-21.
2. Suguna TC et al., "Women's awareness about domestic accidents among toddlers," International Journal of Development Research. 2015; 5 (03): 3729-3733
3. Park K. Textbook of Preventive and Social Medicine. 20th Edition Jabalpur(India): Banarsidas Bhanot publications, 2009
4. Mizuta R, Fujita H, Osamura T, Kidowaki T, Kiyosawa N. Department of Pediatrics, Kyoto Second Red Cross Hospital, Japan. PMID: 8351984
5. Thein MM, Lee BW, Bun PY. Study to assess the knowledge level, attitude level and practices of childhood injuries and their prevention by primary caregivers, Pubmed. 2005; 46 (3): 122-126.
6. Bennett LM. Beliefs of adolescent's mothers about parenting and injury prevention. J Pediatric Health Care. 2001 Jul-Aug; 15(4):194-199.
7. Eldosoky RSH. Home related injuries of children: knowledge, attitudes and practice about first aid among rural mothers. East Mediter Health J. 2012; 18(10):1021-7
8. Kamala B, Wilson ML, Hasselberg M. Pattern of childhood falls in a low-income setting, Department of Public Health. 2011.
9. Mahalakshmy T, Dongre AR, Kalaiselvan G. Epidemiology of Childhood Injuries in Rural Puduchery. Department of Community Medicine, J Pediatric. 2011 Jan 4.
10. Bhavaneswary S et al. Prevention of Burn Injury. 2010:312-318
11. Click DC, Graves PE, Kronerfeld JJ, Jackson K. Safety hazards in household with young children, J Pediatr Psychol. 2000; 18 (1): 115-31.
12. Bhavaneswary S et al. Prevention of Burn Injury. 2008 :312-318
13. Chaudhari V, Srivastava, R, Moitra, M. and Desai, V. Risk of Domestic Accidents of under Five Children. The Internet Journal of Family Practice. 2008; 7.
14. Sibel E, Sukran S. Department of Home Economics. The Turkish Journal of Paediatrics. 2006; 48: 56-62
15. Beivens TM. Prevention of Home Accidents. The knowledge and practice of mother prevention of burn between 9 months 9 years. 2006:312-318.

# Anthropometric Assessment of Canthal Distances and Canthal Index of South Indian Region: A Cross-Sectional Study

Radha K.<sup>1</sup>, Srinivasan K.R.<sup>2</sup>

<sup>1</sup>Professor, Dept. of Anatomy, Vinayaka Missions Medical College, Karaikal, Puducherry, India-609 609,

<sup>2</sup>Professor Emeritus, Aarupadai Veedu Medical College, Pondicherry, India-607402

## Abstract

**Background:** Orbitofacial anthropometric measurements can be used in identification of gender and ethnicity in forensic anthropology. It also plays a crucial role used in plastic surgery and for identifying genetic syndromes. Canthus is the term employed to explain the either corner of the eyes. Inner canthus is also called as medial or nasal canthus. Outer canthus, is otherwise called as lateral or temporal canthus. Normal canthal values can function as a guide for the diagnosis of pathology and interventions for craniofacial abnormalities. Thus, it is necessary to have a knowledge about the local data of those parameters since this standard reflects the doubtless different pattern of craniofacial growth resulting from racial, ethnic, sexual and dietary differences. Hence this study is undertaken to find out the normative inner canthal and outercanthal distance measurement in population of South Indian region.

**Aims and Objectives:** The present study was done to find out the normal inner and outercanthal distance and also canthal index of population of South Indian ethnic origin and also to analyse the sexual dimorphism in them.

**Materials and Method:** This descriptive cross-sectional study was conducted on 200 volunteers of age group 18-25 years of both sexes belonging to South Indian region. Innercanthal distance(ICD) and Outer canthal distance(OCD) were measured using digital vernier caliper.Canthal index was calculated. All the data were analysed using SPSS 16.0 version software and correlated with gender.

**Results:** Mean innercanthal distance was found to be  $2.64 \pm 0.51$  cm in males and  $2.51 \pm 0.46$  cm in females respectively in the present study. There is significant sexual dimorphism in ICD . The study also showed outercanthal distance to be  $10.35 \pm 0.81$ cm in males and  $10.19 \pm 1.02$  cm in females respectively. Canthal index was  $25.71 \pm 4.91$  in males and  $24.83 \pm 7.83$  in females. There is no significant sexual dimorphism in OCD and Canthal index.

**Conclusion:** It was observed that all the values were significantly higher in males than females of south Indian ethnic origin. And there is a significant sexual dimorphism in inner intercanthal distance.

**Keywords:** *Innercanthal distance, outercanthal distance, orbitofacial anthropometry.*

## Introduction

The face is the most appealing and attractive structure in the human body. Orbit, the anatomical entity in the face plays a vital role in determining the facial attractiveness. It also influences the visual judgement of healthy person as well as those with facial deformities<sup>[1]</sup>. Anthropometry which is the branch of anthropology measures human physical dimensions<sup>[2]</sup>. Measurements of soft tissue using a anthropometric instrument is considered as a direct quantitative method to assess

physical dimension and the method are non-invasive and easy to perform<sup>[3]</sup>.

Orbitofacial anthropometry has a key role in assessing dysmorphic syndromes, hypertelorism, facial trauma especially naso-orbitoethmoid injury and also in diagnosing neural crest anomalies. It also aids in planning reconstructive surgical procedures of face and getting fruitful outcome.

Canthus is the term used to describe the either



corner of eyes. Inner canthus (medial or nasal canthus) is formed by the medial part of superior and inferior eyelids whereas outer canthus (lateral or temporal canthus) is formed by the lateral part of superior and inferior eyelids<sup>[2]</sup>. Inner intercanthal distance (ICD) is the distance between medial canthi of eyes and Outer canthal distance (OCD) is the distance between lateral canthi of eyes<sup>[4]</sup>.

Canthal measurements become stable once it has reached the adult level most probably in the mid to late twenties<sup>[5]</sup>. Canthal measurements are influenced by age,sex,race and ethnicity.

Normal values of canthal distance helps and serves as a guide to diagnose the pathologies and for early surgical intervention. Knowledge of subtle morphological changes in Dysmorphic syndromes which were diagnosed based on molecular and cytogenetic techniques will help in directing towards the useful diagnostic test<sup>[6]</sup>.

Knowledge of variation in the morphological and anatomical relationships of periorbital structures among different ethnic groups helps the surgeons to retain the ethnical features and to derive an ideal outcome in the reconstructive and cosmetic surgeries. Hence this study is under taken to find out the normative inner intercanthal and outer-intercanthal distance measurement of people of south Indian ethnic origin.

**Materials and Method**

Present study was done with 200 volunteers of south Indian ethnic origin (Males and Females) of age group 19-25 years. Prior to the initiation of study process, approval was obtained from Institutional Ethical Committee, Vinayaka Missions Medical College, Karaikal. Informed,written consent was got from each participant after explaining the study clearly. Those

having orbitofacial deformity, facial trauma,any congenital anomalies involving orbitofacial region were excluded from the study.

All the measurements were taken using digital vernier caliper with the subjects sitting straight with eyes closed and in a relaxed state. Intercanthal distance (ICD) was measured from medial canthus of one eye to medial canthus of the other eye. Outercanthal distance (OCD) was taken from lateral canthus of one eye to the lateral canthus of other eye. All measurements were taken in centimetre. Each measurement was taken twice to avoid error and all the measurements were tabulated in a log book.

Canthal index was calculated using the formula

$$\text{Intercanthal distance/Outercanthal distance} \times 100$$

All measurements were analysed using SPSS software 16.0 version. Descriptive variables were depicted as mean and standard deviation. The mean values of the measurements were compared between either sexes using the independent t test.

**Results**

The study was done on 90 males and 110 females of age group 18-25 years showed the mean value of innercanthal distance as 2.55±0.51cm, the mean value of outercanthal distance as 10.26±0.92 cm and mean canthal index was 25.23±6.71.(Table 1).

**Table I: Descriptive statistics for ICD, OCD, CANTHAL Index**

Variable	N	Range	Mean±SD
ICD	200	0.90-4.31	2.55±0.51
OCD	200	3.38-12.65	10.26±0.92
Canthal Index	200	8.31-81.07	25.23±6.71

**Table II: Gender with variables Mean±sd comparison using independent sample t test**

Variable	Male		Female		t	p value
	N(%)	Mean±SD	N(%)	Mean±SD		
ICD	90(45%)	2.64±0.51	110(55%)	2.51±0.46	2.689	0.008
OCD	90(45%)	10.35±0.81	110(55%)	10.19±1.02	1.195	0.234
CANTHAL Index	90(45%)	25.71±4.91	110(55%)	24.83±7.83	0.935	0.351

Table II shows the mean value of ICD, OCD and CANTHAL INDEX among males and females. All

values are higher in males than females. And there is a significant sexual dimorphism in ICD.

**Table III: Mean values of ICD,OCD And Canthal index of various regions of South India**

State	N	ICD	OCD	Canthal Index
Tamilnadu	132	2.46±0.48	10.21±1.02	24.7±7.65
Kerala	42	2.68±0.39	10.24±0.61	26.2± 3.84
Andhrapradesh	5	2.86±0.50	11.4±0.22	25.15±4.69
Karnataka	21	2.72±0.47	10.35±0.69	26.33±4.44

The ANOVA test had shown that the ICD and OCD significantly varied between regions with (p value -0.006 for ICD and 0.039 for OCD) (Table IV).

**Table IV: Showing values for ICD,OCD AND Canthal index between states**

Variable	F	P value
ICD	4.336	0.006
OCD	2.845	0.039
Canthal Index	0.760	0.518

## Discussion

The dimensions of face and proportions of its components vary in different ethnic groups<sup>[7]</sup>. Ethnicity of South Indian population belongs to Dravidian ethnic group. Dravidians are one of the non-Aryan races of Southeast Asia and are distributed mainly in South India and Ceylon<sup>[8]</sup>. Inter-canthal distance is influenced by the shape of face, race and gender<sup>[9]</sup>. Inner intercanthal distance serves as a guide to estimate width of maxillary central incisors, which is a determinant of facial aesthetics<sup>[10]</sup>.

LeTT et al reported that facial profile can vary in different ethnic groups and that the dominant characteristics of the Asian faces were a wider ICD in relation to shorter palpebral fissures compared to Caucasians<sup>[11]</sup>. Normal values of inner and outer canthal distances, canthal index serves as useful parameters in the evaluation and treatment of congenital or post traumatic deformities of the cephalic and facial regions such as telecanthus, ocular hypotelorism and craniosynostosis.

Laestadius reported that in 78% of adults, the ICD is attained by the age of 1 year, after which the growth in this area is slow in contrast to outer orbital dimension<sup>[12]</sup>. According to Epker and Fish, these values are established by 6–8 years of age and do not change significantly after this time. This stable landmark can be identified, located and measured accurately<sup>[13]</sup>.

Vasanthakumar et al did their study in Malaysian South Indian ethnic adults and found that the outer canthal distance was 97.15 mm in males and 91.78 mm in females which was lower than present study. And they also noted intercanthal distance and canthal index to be 34.1 mm and 35.22 in males; and 32.77 mm and 35.86 in females respectively. These values are very high compared to the values of present study. They have observed sexual dimorphism in all parameters whereas in the present study there is significant sexual dimorphism in intercanthal distance only<sup>[14]</sup>.

The values of inner intercanthal distance found in present study was lower than the normative value found by Farkas et al for Indian population. At the same time, the outer canthal distance was higher than that given by Farkas et al<sup>[15]</sup>. Our study showed the lower inner canthal distance and higher outer canthal distance than that found by Singh J.R. et al<sup>[16]</sup>, Agarwal J<sup>[17]</sup> for Indian population but our study coincides with the findings of Gupta et al<sup>[18]</sup>. The present study showed mean inner intercanthal distance as 2.55±0.51 cm which is low compared to that reported by Harinee<sup>[19]</sup> in her study on Kanyakumari population (Part of Tamilnadu, South India) which is 3.275±0.254 cm whereas mean outer canthal distance coincides with her study value.

## CONCLUSION

The present study which is done on 200 participants of age 18-25 years showed low value for inner intercanthal distance and high outer canthal distance for South Indian population than Indian population as such. This data values will serve as important aiding tool in reconstructive cosmetic surgeries, for diagnosing dysmorphic syndrome by genetic counsellors and for identifying dead or live person by forensic experts.

**Conflict of Interest:** Nil

**Source of Funding:** Self funding.

**Ethical Clearance:** Ethical clearance from the institutional ethical committee obtained for the study

### References

1. P. Vasanthakumar, Pramod Kumar, Mohandas Rao. Anthropometric Analysis of Palpebral fissure dimensions and its position in South Indian Ethnic Adults. *Oman Med J* 2013;28 (1):26-32.
2. Adhikari N, Ambekar MN, KC S. An anthropometric comparison of inner canthal distance, outer canthal distance and canthal index in the Indian and Nepalese undergraduate students of Nepalgunj Medical College. *J Nepal Med Coll.* 2016;14(2):12-4
3. Torres-Restrepo et al.: Agreement between cranial and facial classification through clinical observation and anthropometric measurement among envigado school children. *BMC Oral Health* 2014 14:50.
4. E. A. Osunwoke, A. Elekwa, I. F. Bob-Manuel and S. O. Ojeka. A Study On The Normal Values of Inner Canthal, Outer Canthal, Canthal Index, Interpupillary Distance And Head Circumference of 23 - 42 Years Igbos. *Global Journal of Medical Sciences* Vol 9, No. 1 & 2, 2010: 43-48.
5. Dr. Bipana Manandhar. Study of Canthal Index among Students of Dental College .*JNDA | Vol. 19 No. 2*
6. Sadacharan CM. Orbitofacial assessment of Indian Americans and its significance—an anthropometric study. *MOJ Anat Physiol.* 2015;1(4):85–89. DOI: 10.15406/mojap. 2015.01.00018<sup>4</sup>
7. Wu KH, Tsai FJ, Li TC, Tsai CH, Peng CT, Wang TR. Normal values of inner canthal distance, inter pupillary distance and palpebral fissure length in normal Chinese children in Taiwan. *Acta Paediatr Taiwan* 2000;41:22-7.
8. George S, Bhat V. Inner canthal distance and golden proportion as predictors of maxillary central incisor width in south Indian population. *Indian J Dent Res* 2010;21:491-5.
9. Blumenfeld J. Racial identification in the skull and teeth. *The University of Western Ontario Journal of Anthropology.* 2000; 8(1):22-6.
10. Rehulina Ginting, Dennis and Navashangkari Ravichandran. Comparison of the golden proportion value between the width of maxillary central incisors with the innercanthal distance of Malaysian Indians using golden mean gauge. *International Journal of Applied Dental Sciences* 2017; 3(2): 141-143
11. Le TT, Farkas LG, Ngim RC, Levin LS, Forrest CR. Proportionality in Asian and North American Caucasian faces using neoclassical facial canons as criteria. *Aesthetic Plast Surg.* 2002; 26(1):67
12. Laestadius ND, Aase JM, Smith DW. Normal inner canthal and outer orbital dimensions. *J Pediatr* 1969;74:465-8.
13. Bruce HE, Leward CF. Dento facial deformities. *Integr Orthod Surg Correct* 1999;1:10-2.
14. Vasanthakumar P, Kumar, Mohandas Rao KG. Photogrammetric analysis of palpebral fissure dimensions and its position in Malaysian South Indian Ethnic adults by gender. *North Am J Med Sci* 2012;4:458-62.
15. Leslie G. Farkas, Marko J. Katic, BA, Christopher R. Forrest. International Anthropometric Study of Facial Morphology in Various Ethnic Groups/ Races. *The Journal of Craniofacial Surgery/ Volume 16, Number 4 July 2005.*
16. Singh JR, Banerjee S. Normal values for interpupillary, inner canthal and outercanthal distances in an Indian population. *Hum Hered* 1983;33:326-8.
17. Agrawal J, Yogesh AS, Shukla CK, Banerjee C, Chandrakar AK. Orbitofacial anthropometric assessment of inter-canthal and outercanthal distance measurement in Chhattisgarh region. *Biomed Res- India* 2013 Volume 24 Issue 3
18. Gupta VP, Sodhi PK, Pandey RM. Normal values for intercanthal, interpupillary and outer intercanthal distances in the Indian population. *Int J cline Pract* 2003; 57(1): 25-9.
19. Harinee. T, Orbitofacial Anthropometric Assessment of Inner-Intercanthal and Outer-Intercanthal Distance in Kanyakumari Population- an In vivo Study” <http://repository-tnmgrmu.ac.in/9902>

# Tuberculosis of the Breast: A Challenging Component of Benign Breast Diseases

Rajbangshi M.C.<sup>1</sup>, Deka Sumi<sup>2</sup>, Mahanta Bandana<sup>3</sup>, Mahanta Putul<sup>4</sup>

<sup>1</sup>Associate Professor, Department of Surgery, Gauhati Medical College and Hospital, Guwahati, Assam, India,

<sup>2</sup>Demonstrator of Biochemistry, Gauhati Medical College and Hospital, Guwahati, Assam, India, <sup>3</sup>Associate Professor, Department of Anaesthesiology, Tezpur Medical College and Hospital, Tezpur, Assam, India, <sup>4</sup>Professor, Forensic Medicine and Toxicology

## Abstract

**Introduction:** Tuberculosis (TB) of the breast is a rare manifestation of extra-pulmonary localization of the disease. The incidences vary from a minimum in developed countries to a high in developing countries like India and Africa.

**Materials and Method:** This study was a hospital-based observational study carried out in 75 cases of benign breast disease which were studied with special reference to Tuberculosis of the breast. All patients who were clinically diagnosed as a benign breast lump, above the age of 14-years and among them who were willing to undergo investigations and treatment were included. Ziehl-Neelsen staining was performed in all fine needle aspirates and finally, treatment modality used.

**Results:** The present study involved 67 cases of benign breast lumps and 8 cases of recurrent breast abscesses. Further, it depicts predominant benign breast lumps which were fibroadenoma in 65.7% fibroadenosis in 23.80%, TB breast in 4.50%, ductal papilloma in 2.90% and phyllodes tumour of the breast in 1.5% of cases.

**Conclusion:** For the TB of the breast in India, various treatment modalities are available. With timely diagnosis, the morbidity can be minimised with less amount of suffering.

**Keywords:** Breast diseases; Ziehl-Neelsen staining, fine needle aspiration cytology (FNAC).

## Introduction

Tuberculosis (TB) of the breast is a rare manifestation of extra-pulmonary localization of the disease which accounts for less than 0.1% of breast conditions in developed countries but reaches 3–4% in regions where the disease presents with high incidence (India, Africa).<sup>1</sup> It appears mostly in women of reproductive age, multiparous, lactating. It has been scarcely reported to infect male patients, mainly before puberty, as well as women of older age. The most common presentation is that

of a tumour in the middle or upper-outer quadrant of the breast, with multifocal involvement being rarely documented. The differential diagnosis includes breast cancer and abscess formation. The first case of breast tuberculosis was recorded by Sir Astley Cooper who described it as “scrofulous swelling of the bosom”.<sup>2</sup> Tuberculosis is caused by *Mycobacterium tuberculosis* and affects primarily the lungs. Breast tuberculosis is a rare disease, with an incidence of less than 0.1% of all breast lesions in Western countries and 3–4% in tuberculosis endemic regions, such as India and Africa. It usually affects young lactating multiparous women, although it may also be reported in prepubescent males or elderly women.<sup>2,3</sup> Most commonly, the disease presents as a lump in the central or upper-outer quadrant of the breast, while multiple lumps appear less frequently.<sup>4</sup> The clinician may misdiagnose breast tuberculosis with either breast carcinoma or abscess.<sup>4,5</sup> Diagnosis

---

### Corresponding Author:

**Mahanta Putul**

Professor, Forensic Medicine and Toxicology

e-mail: drpmahanta@gmail.com

Mobile: +9435017802

of breast tuberculosis, therefore, remains a challenge for clinicians and requires a high degree of suspicion. Mammography or ultrasonography are unreliable in distinguishing the breast tuberculosis from carcinoma because of the variable pattern of presentation of such inflammatory lesion. Histopathology plays a pivotal role in the diagnosis. Surgery is reserved only for selected refractory cases.<sup>3</sup>

This paper aims to diagnose tuberculosis of breast and provide appropriate treatment.

### Materials and Method

The present study deals with 75 patients of benign breast diseases with special reference to TB of the breast. The data were collected from the six surgical units of Gauhati Medical College and Hospital, Assam, during the period from 1<sup>st</sup> July 2017 to 30<sup>th</sup> June 2018. All patients who were clinically diagnosed as a benign breast lump, above the age of 14-years and among them who were willing to undergo investigations and treatment were included. Ziehl-Neelsen staining was performed in all fine-needle aspirates.

Evaluation of the cases was done by a thorough clinical breast examination. The breasts are assessed for nodularity and presence of any dominant mass or thickening. The next step was to palpate the regional lymph nodes. These include the supraclavicular, infraclavicular and axillary nodes. Fine needle aspiration cytology (FNAC) was done (Harris Alum – Haematoxylin, Orange G 6 and EA 36 solutions for staining). Ziehl-Neelsen staining to stain mycobacterium tuberculosis and mycobacterium leprae was performed. Ultrasonography of the benign breast tumours was also performed to locate the smooth contours. Round or oval shapes, with weak internal echoes and well defined anterior and posterior margins. Cysts on ultrasound examination, are always well-circumscribed, with smooth margins and have an echo-free centre irrespective of the sensitivity settings. Diagnostic mammography was performed in case of breast abnormality on clinical examination or screening mammography. Calcifications were assessed by it as micro-calcifications and macro-calcifications, mass or cyst is another important change seen on mammograms (non-cancerous, fluid-filled sacs, fibroadenomas). The biopsy was done in all

where mammography shows abnormal results. Before collection of the data ethical approval was taken from the ethics committee.

### Results and Observations

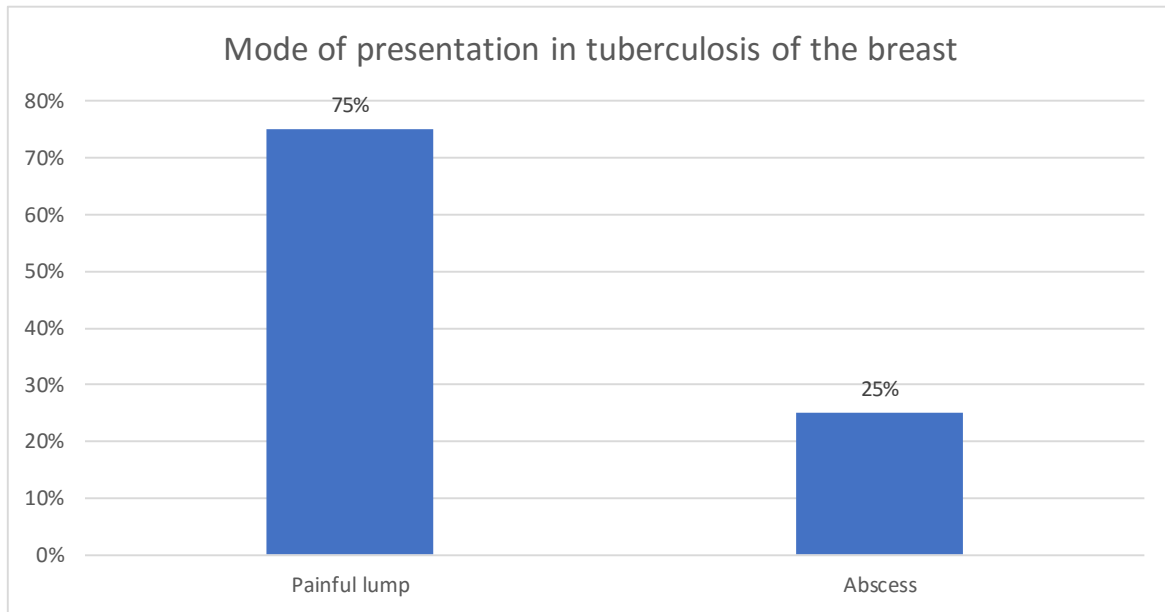
The present study diagnosed 67 cases of the benign breast lump and 8 cases of recurrent breast abscess who attended outpatient department as well those who were admitted in the six surgical units of Gauhati Medical College & Hospital, Guwahati during the period of 1<sup>st</sup> July 2017 to 30<sup>th</sup> June 2018. The data collected from 67 cases are studied based on etiological and clinical backgrounds, the accuracy of diagnostic investigations and finally treatment modality used. During this study, among the patients with a breast lump, only those cases were evaluated who on examination appeared benign and whose ultrasonographic features and FNAC results were benign have been included. All the cases who underwent surgery operated specimen were sent for histopathology.

**Table 1: Incidence of the benign breast lump**

Type	No. of Cases	Percentage
Fibroadenoma	44	65.7%
Fibro adenosis	16	23.8%
TB breast	3	4.5%
Duct papilloma	2	2.9%
Phyllodes tumour	1	1.5%
Duct ectasia	1	1.5%

**Table 1** depicts among 67 cases presented with a palpable lump, among them 44 (65.7%) were diagnosed to be a fibroadenoma, followed by fibro adenosis (23.8%), TB breast (4.5%), Ductal papilloma (2.9%), duct ectasia and phyllodes (1.5% each).

Bar diagram depicts four cases of tuberculosis of the breast were diagnosed, among those three presented as painful lump while others presented as an abscess. 8 cases of recurrent abscesses were included in this study. Pus was sent for Ziehl-Neelsen staining, Bacterial culture and sensitivity and AFB culture. Although Ziehl-Neelsen staining was negative in all of them, AFB culture identified Mycobacterium Tuberculosis, hence the diagnosis of Tuberculosis of the breast was made.



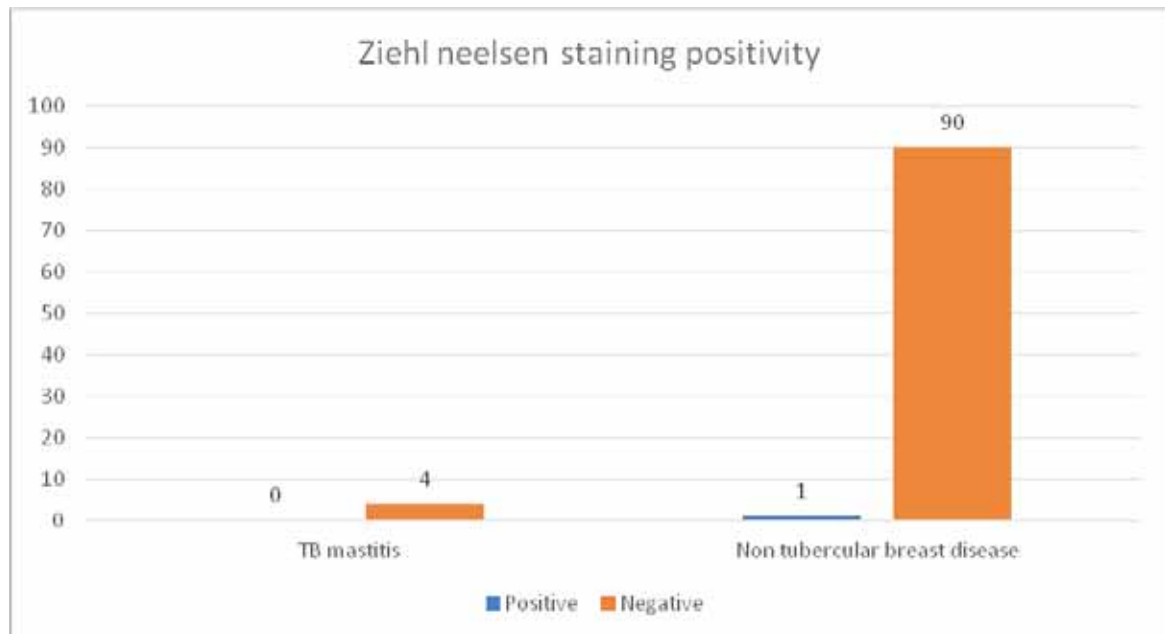
**Figure 1** Bar diagram showing modes of presentation in tuberculosis of the breast

**Table 2: Significance of Ziehl-Neelsen staining in tubercular mastitis**

Ziehl-Neelsen staining	No. of Cases	Percentage
Positive	0	0%
Negative	4	100%

Table 2 depicts Four cases of tubercular mastitis were diagnosed, three of them presented as lumps

while one presented as an abscess. All of them stained negative for Ziehl-Neelsen, however, lumps were histopathologically diagnosed as tuberculosis of the breast. While abscess was empirically started on ATT due to recurrent history. One case of fibroadenoma also stained positive for Ziehl-Neelsen, however, it was histopathologically diagnosed postoperatively to be fibroadenoma and was a false positive.



**Figure 2** Bar diagram showing the significance of Ziehl-Neelsen staining in the diagnosis of tuberculosis of the breast

Figure 2 describes Tuberculous mastitis (TM) occurs far more frequently in women, especially in their reproductive age, and is uncommon in prepubescent and elderly women.

### Treatment Modalities:

**Tuberculosis of the Breast:** In this study 4 cases of tuberculosis of breast were diagnosed. 3 of them presented as lumps and one as an abscess. Lumps were excised due to initial diagnostic uncertainty and abscess was drained by open drainage. Pus was sent for both Ziehl-Neelsen staining and AFB culture. Although Ziehl-Neelsen came out to be negative, AFB culture identified Mycobacterium Tuberculosis. All were given 9 months of antitubercular therapy with 2 months of intensive therapy with ethambutol (E) 1200 mg; rifampicin (R) 450 mg, isoniazid (H) 600 mg and pyrazinamide (Z) 1500 mg., followed by 7 months of ethambutol and isoniazid. Improvement was observed during our period of study, however, long term follows up was not possible.

### Discussion

The relative incidence of various benign breast lumps in were found to be concurrent with other reported series of Sangma et al.,<sup>6</sup> Seema et al.,<sup>7</sup> Amruthavalli et al.,<sup>8</sup> Jagtap et al.,<sup>9</sup> and Abhijit MG et al.<sup>10</sup>

**Significance of Ziehl-Neelsen staining in tuberculosis of breast:** Four cases of tubercular mastitis were diagnosed, three of them presented as lumps while one presented as an abscess. All the lumps stained negative for Ziehl-Neelsen; however, it was histopathologically diagnosed as tubercular mastitis. Abscess aspirate also stained negative for Ziehl-Neelsen. Positivity of Ziehl-Neelsen staining was found to be statistically insignificant. This finding was consistent with the study by Gupta PP et al.<sup>11</sup> On all 7 patients of tuberculosis of breast in which the positive Ziehl-Neelsen stain was only in 38%, and was found to be statistically insignificant for the diagnosis.

**Presentation of tuberculosis of breast:** Among four patients diagnosed with tuberculosis of breast, 3 (75%) of them presented with a lump and 1 (25%) presented as an abscess. Finding was consistent with the study by Mallika Tewari and HS Shukla<sup>12</sup> on 30 patients with Tuberculosis of the breast in which 73% presented with lump and 27% with abscess.

Tuberculous mastitis (TM) occurs far more frequently in women, especially in their reproductive age, and is uncommon in prepubescent and elderly women.<sup>13</sup> This parallels the highest incidence of pulmonary tuberculosis. This could be because the female breast undergoes frequent changes during the period of childbearing activity and is more susceptible to trauma and infection.<sup>14</sup>

### Treatment Modalities:

**Tuberculosis of the Breast:** Our treatment protocol was similar to that followed by Mallika Tewari and HS Shukla.<sup>12</sup> However the protocol followed by Prem Prakash et al.,<sup>11</sup> was of 6 months ATT and observed good response rate in 96% of the cases. In our study, there were only 2 cases of ductal papilloma and single case each of phyllodes tumour and ductal papilloma. Simple mastectomy was performed for the phyllodes tumour and microdiscectomy for ductal papilloma and duct ectasia. Wide excision is usually sufficient for phyllodes tumour however in this case size was large enough to make wide excision improbable. Techniques we followed were similar to the technique followed by Akshara et al.,<sup>15</sup> and Naveen et al.,<sup>16</sup> in their studies on benign breast disease for these lesions.

In the era of minimally invasive surgery, percutaneous drainage has proven a safe and effective alternative to incision and drainage in acute abscesses, while chronic and recurrent abscesses are best treated with the classical means of drainage. The method of percutaneous aspiration combined with irrigation and installation of antibiotics has proved effective in 96% of cases reported in one series.<sup>17</sup> In this current study, only patients with recurrent breast abscess were included. Hence, we performed emergency incision and drainage and pus was sent for culture and sensitivity. Our management method was similar to that followed by different studies on benign breast diseases.<sup>18,19</sup>

### Conclusion

Benign breast diseases are essential to differentiate from malignant ones and also between one another. An appropriate diagnosis is key to have a proper outcome.

**Conflict of Interest:** None declared.

**Ethical Clearance:** Taken.

**Source of Funding:** None declared

**Author Disclosure:** The article is original with the author(s) and does not infringe any copyright or violate any other right of any third party. The article has not been published (whole or in part) elsewhere and is not being considered for publication elsewhere in any form, except as provided herein. The first author has conceived the study design and helped in the collection of data along with author second. The third and fourth author has helped in interpreting the data thus collected and also in writing the manuscript along with the author one and second. All author(s) have contributed sufficiently in the article to take public responsibility for it and have reviewed the final version of the manuscript and approved it for publication.

### References

- Cooper SA. Illustrations of the diseases of the breast Part 1. London: Longmans, Rees, Brown Orme, Green, and Longman; 1829. p. 7
- Luh SP, Chang KJ, Cheng JH, Hsu JD, Huang CS. Surgical treatment for primary mammary tuberculosis – report of three octogenarian cases and review of literature. *Breast Journal* 2008;14:311–312.
- Maroulis I, Spyropoulos C, Zolota V, Tzorakoleftherakis E. Mammary tuberculosis mimicking breast cancer: a case report. *Journal of Medicine Case Reports* 2008;2:34.
- Mirsaeidi SM, Masjedi MR, Mansouri SD, Velayati AA. Tuberculosis of the breast: report of 4 clinical cases and literature review. *East Mediterranean Health Journal* 2007;13:670–676.
- Sriram KB, Moffatt D, Stapledon R. Tuberculosis infection of the breast mistaken for granulomatous mastitis: a case report. *Cases J* 2008 Oct 25;1:273.
- Sangma MB, Maychet, Panda Kishori, Dasiah Simon. (2013). A clinico-pathological study on benign breast diseases. *J clin Diagn Res* 2013 Mar;7(3):503-506.
- Seema Nagger, Irbinder Kour Bali, Prachi Arun, Vinay Kumar, Kalpana Goyal, Parveen Shah, et al. Clinico-pathological study on benign breast diseases in Gurugram NCR. *IOSR Journal of Dental and Medical Sciences (IOSR-JDMS)* 2018 April;17(4):59-62.
- BV Amruthavalli, V Srihari. Clinical study of benign breast diseases. *IOSR Journal of Dental and Medical Sciences (IOSR-JDMS)* 2015 Nov;14(11):34-40.
- Jagtap SV, Nihalani RR, Boral S. Clinicocytological study of breast lump in the non-malignant categories. *Asian Pac J Health Sci* 2018;5(1):107-110.
- Abhijit MG, Anantharaman D, Sumanth B, Ranjani R. Benign breast diseases: experience at a teaching hospital in rural India. *Int J Res Med Sci* 2013;1:73-8.
- Gupta PP, Gupta KB, Yadav RK, Agarwal D. Tuberculous mastitis: A review of seven consecutive cases. *Indian J Tub* 2003;50:47–50.
- Tewari M, Shukla HS. Breast tuberculosis: Diagnosis, clinical features and management. *Indian J Med Res* 2005;122:103–10.
- Jalali U, Rasul S, Khan A, Baig N, Khan A, Akhter R. Tuberculous mastitis. *J Coll Physicians Surg Pak* 2005;15:234–7.
- Raw N. Tuberculosis of the breast. *Br Med J* 1924;J:657–8.
- Gupta A, Gupta AK, Goyal R, Sharma K. A study of clinical profile of benign breast diseases presenting at a tertiary care centre in central India. *Scholar J Appl Med Sci* 2015;3(2C):695-700.
- Gupta A, Gupta AK, Goyal R, Sharma K. A study of clinical profile of benign breast diseases presenting at a tertiary care centre in central India. *Scholar J Appl Med Sci* 2015;3(2C):695-700.
- Naveen N, Avijeet M and Vikrant M. A clinical study of benign breast disease in rural population. *Journal of Evolution of Medical and Dental Sciences* 2013;12:5499-511.
- Leborgne F. Treatment of breast abscesses with sonographically guided aspiration, irrigation, and instillation of antibiotics. *AJR* 2003;181(4):1089–91.
- Abdel Hadi, Maha Bukhari, Huda. Breast infections in non-lactating women. *Journal of family & community medicine* 2005;12:133-7.



# Iron Content as an Indicator for *Legionella* Species in Artificial Water Systems

Rajeshwari Vittal<sup>1</sup>, Juliet Roshini Mohan Raj<sup>2</sup>, Ballamoole Krishna Kumar<sup>3</sup>, Indrani Karunasagar<sup>4</sup>

<sup>1</sup>Senior Lecturer, Nitte University Centre for Science Education and Research, Deralakatte, Mangaluru, India-575018, <sup>2</sup>Assistant Professor, Division of Infectious Diseases, <sup>3</sup>Assistant Professor, Division of Infectious Disease, <sup>4</sup>Director, Nitte University Centre for Science Education and Research, Mangaluru, India-575 018

## Abstract

**Background:** *Legionella* have emerged as a pathogenic group due to increased use and poor maintenance of artificial water environments. World Health Organization considers *Legionella* associated diseases to be underestimated, especially in developing countries due to difficulty in detection. The aim of this study was isolation and culture of *Legionella* spp. from artificial water systems and to test the importance of iron concentration which can be developed as a reliable chemical marker.

**Method:** Thirty samples each were collected from drinking water coolers, cooling towers and shower heads fitted in different houses of Mangaluru city. Isolation and identification of the bacteria were carried out as per the standard protocols followed by determination of iron content prescribed by IS 3025 (Part 53).

**Conclusion:** Our study shows that concentrations of iron, is an important factor that increases the likelihood of *Legionella* spp. Statistically, a concentration of 300 mg Fe/L shows a positive correlation with *Legionella* presence. Therefore, monitoring suspect sites for iron concentration and chelation of available iron, can be developed as respective assays for identifying *Legionella* spp. Furthermore, we show that PCR based detection of *Legionella* is a more robust method than the classical 3-plate method, especially for virulent strains.

**Keywords:** Cooling tower, iron content. *Legionella*, Legionnaires disease, potable water, water distribution systems.

## Introduction

*Legionella*, a genus of Gram negative, non-spore forming bacilli pervasively occurs in all aquatic habitats and is known to enter into the human-made water systems easily<sup>1,2</sup>. They are known to cause the mild to fatal Legionnaire's diseases (LD) and the milder Pontiac fever both commonly known as Legionellosis.

Among the pathogenic species, *L.pneumophila* is the most widely studied species; *L.longbeachae*, *L.bozemanii* and *L.micdadei* are other commonly detected agents of Legionellosis<sup>3</sup>.

In developed countries, 2-9 % of all pneumonia cases are attributed to *Legionella* infection<sup>4-8</sup>. Lower than expected incidence of *L. pneumophila* infections from India are believed to be due to under-reporting

as most of the infections are diagnosed as atypical pneumonia in community establishments and hospitals<sup>7</sup>.

In the absence of a vaccine, the prime preventive measure for infections is reduction/elimination of physical sources of infection. However, despite the repeated recommendations of thorough maintenance of the water systems, little scientific evidence exists to show the effect of regular maintenance in reducing *Legionella* load<sup>8</sup>. Therefore, there is an urgent need to develop novel bio/chemical markers for identification for this group of bacteria or the sites where they can thrive<sup>9</sup>.

The conventional method for isolation of *Legionella* spp. includes pre-treatments followed by culturing on buffered charcoal yeast extract agar supplemented

with cysteine, iron, and antibiotics. In this study, water samples from various municipal sources, we show that the conventional method can give false positive results, therefore, PCR-based detection is a more robust method for detection. Moreover, iron content at the sampled sites and the presence of *Legionella* spp. show a strong statistical correlation, thereby suggesting that local iron concentration at suspect locations can be used as a chemical marker for probable *Legionella* growth.

## Materials and Method

**Sampling:** Ninety samples were collected in total over a period of 2 years, from December 2016 to December 2018. The study was conducted in Nitte University Center for Science Education and Research, Nitte (Deemed to be University), Deralakatte, Mangaluru. Thirty each samples were collected from local drinking water coolers, cooling towers and from shower heads fitted in different houses around Mangaluru city. samples were collected by strictly following the Indian Standard: Method of sampling and test for water and wastewater guidelines. All samples were processed within 4 hours of collection.

**Isolation and culturing of samples:** Isolation of *Legionella* from collected samples was performed as per US Centre for Disease Control and Prevention guidelines 2005. Briefly, each water samples were filter concentrated in a biological safety cabinet by pouring the samples onto a sterile membrane filtration funnel containing 0.2  $\mu\text{m}$ , 45 mm diameter polycarbonate membrane filter. After filtration, the filter was removed aseptically from the holder with sterile filter forceps and placed into a centrifuge tube containing 5 ml sterile water. The centrifuge tube was then vortexed for 1 minute to recover bacteria and organic material from the filter. Buffered charcoal yeast extract (BCYE) supplemented with glycine, vancomycin, cycloheximide and polymyxin B (GVPC) antibiotics was used for isolation of *Legionella*. 2 BCYE plates and GVPC plates were inoculated with 100  $\mu\text{l}$  suspension each and spread with a sterile spreader. The plates were incubated at 35  $^{\circ}\text{C}$  in a candle jar for 72 hours.

*Legionella pneumophila* ATCC 33152 procured from LGC Promochem, Bangalore was used as a positive control for all the experiments. The lyophilized culture was resuscitated as per manufacturer's instructions.

**PCR for detection of *Legionella* species:** Template DNA was prepared by centrifuging the growth

suspension at  $12000 \times g$ , for 5 minutes. The supernatant was discarded and the pellet uniformly resuspended in 100  $\mu\text{l}$  sterile 100 mM Tris-EDTA by gentle vortexing. The resuspension was placed in a dry bath at 98  $^{\circ}\text{C}$  for 10 minutes and then flash cooled on ice. the cooled resuspension was used as the DNA template without further purification. 10 pM standard 16S JFP species specific primers were used for the detection of *Legionella pneumophila* and *Legionella* spp. Further, extracted DNA was used in a nested PCR for virulence detection by dot (defective organelle trafficking) amplification.

**Determination of iron content:** The iron content of each sample was measured by 1, 10 phenanthroline method as prescribed by IS 3025 (Part 53).

## Results and Discussion

*Legionella* infections are primarily spread by man-made water systems and devices such as showers, whirlpool spas, and cooling towers which release contaminated aerosols. Inhalation of these aerosols especially by those with compromised immune systems leads to the infection<sup>10</sup>. WHO predicts that incidences of *Legionella* related disease outbreaks are under-reported in developing countries due to lack of clinical awareness. Reports of *Legionella pneumophila* incidence from India are limited in number and are mostly from clinical samples. Our study primarily aimed at determining the prevalence of *Legionella pneumophila* and its related species in the geographical location of Mangaluru, India and to determine chemical indicators. Isolation of *Legionella* species by culture technique and enrichment followed by molecular detection was performed for each sample. According to CDC protocol, *Legionella* spp. is positive on both BCYE and GVPC plates. Growth on GVPC plates is a unique characteristic of *Legionella* spp. and is used as confirmatory test, as other species are not known to grow on it. Cysteine deficient GVPC plates are used as a control, since cysteine supplement is essential for *Legionella* growth. Based on morphological features, both the agar plates in all the samples, predominantly showed round pearl-white colonies (Fig 1). Thus, suggesting that all the samples were positive for *Legionella* (Table 1). However, some control samples without cysteine supplement also showed *Legionella* like colonies on the agar plates. Repeated experiments showed growth of *Legionella* like colonies in a fraction of control samples, indicating experimental design problem. In our experiments, the 3-plates method for definitive identification of *Legionella* based on growth

characteristics, provided a fraction of false positive results. This demands for a more robust method for detection of *Legionella* spp. Thus, standard PCR with species specific primers and nested PCRs were set with dot gene specific primers to check the virulence of the samples (Table S1).

Agarose gel-electrophoresis of the PCR products showed that from drinking water coolers, of the 30 samples, only 1 sample was tested positive and, 9 samples showed positive from cooling towers. Out of 29 tested positive in culture method from showerheads only 2 samples of 30 were positive (Fig 2). All the samples showing positive PCR for JFP-16S also showed positive for virulence gene (Figure 2 and Table 2). Thus, PCR method showed a higher specificity than culturing method in detection of *Legionella* spp.

Cooling towers are a part of the air-conditioning systems present in industries and hospitals, which use water to efficiently cool air via heat transfer<sup>4,10,11</sup>. The proportion of *Legionella* culture-positive cooling towers that have been reported from surveys conducted in Asia, Australia, Europe, and the United States is approximately 40%<sup>8,12</sup>. In this study, about a one third of the samples (30%) were positive for *Legionella* spp. by highly sensitive PCR detection and all the samples (30%) harboured the virulence genes used in the study.

*Legionella* spp. have been frequently isolated from hospital shower heads but the question of whether aerosols of shower water or other exposures to potable water containing *L. pneumophila* may cause Legionnaires disease is yet unresolved. There have been limited reports on the presence and implications of *Legionella* in domestic shower heads. Shower heads from residences across Mangaluru reported 9 of 30 samples positive for *Legionella*. Drinking water is another source that is not generally checked for *Legionella* since the pathogen is generally contracted by aerosol spray. On an experimental basis, we looked into the presence of *Legionella* in drinking water from coolers and found 1 of 30 samples positive. The low temperatures of water in these coolers could probably be controlling the growth of this organism. However, the presence of *Legionella* in water that is considered potable is still a public health concern.

The biggest hurdle in testing for this organism is its fastidious nature. The conventional culturing technique is gold standard but takes as long as 14 days to confirm

a result. Rapid detection method are the need of the hour for disease prevention and management of outbreaks if any<sup>13</sup>. Modern techniques like polymerase chain reaction, immunofluorescence and flow cytometry have been reported for rapid detection, but the cost of routine testing and availability of these facilities in testing laboratories across developing countries is very limited. Chemical parameter testing like estimation of iron is a relatively simple method that can be carried out without any requirement of sophisticated equipment and the process takes less than 4 hours to report the result.

To characterize *Legionella* harbouring surfaces, we looked for essential nutrients that *Legionella* needs for survival and flourishing. From the list of nutritional elements in *Legionella* culture medium, iron is an essential nutrient that can be easily detected and quantified by sensitive assays. Further, since iron is freely available in the environment in many different forms it can be expected to be a promising candidate as a chemical marker for the development of rapid detection of *Legionella*. Iron is an essential nutrient for *L. pneumophila* because its growth depends on the presence of iron in its culture medium and also plays a key role in its pathogenesis<sup>14</sup>. Recently there have been reports to implicate that the presence of cast iron rusting plays an important role in the development of *Legionella* in water distribution systems.

Interestingly, majority of the sites tested in our study had iron concentration higher than 300 mg/l. Routine BCYE and GVPC media used to culture *Legionella* is supplemented with 250 mg/l of iron for optimal growth. Among the different sites, cooling tower samples showed the highest proportion, at 80 % of samples with iron concentration >300 mg/ml. Drinking water coolers and showerheads showed high iron concentrations in 53 and 43 % samples respectively (Table 3). This proportionality of high iron concentration correlates with PCR positive *Legionella* samples, where cooling towers showed highest number of positive samples at 30 % while drinking water coolers and showerheads showed 2 and 6 % PCR positive samples, respectively (Table 4). It is noteworthy that all the PCR positive *Legionella* samples had iron concentration higher than 75 mg/l showing that low environmental iron concentrations are not conducive for growth. As hypothesized iron could be used as an indicator for *Legionella* in routine testing of water. Our study indicates that while concentrations up to 75 mg/l do not show a correlation with the presence of *Legionella* but 300 mg/l iron concentration is a strong

indicator of *Legionella* and thus can be used for routine monitoring.

Our study also shows that environmental monitoring should be an important and regular practice for preventive measures, which could begin with sites that are likely to have high local iron concentration. The

WHO recommends that health care facilities should have a general water safety plan as a part of infection control and these plans should address microbial growth in addition to control of external contamination by *Legionella* and should include ancillary equipment like shower heads and medical devices.

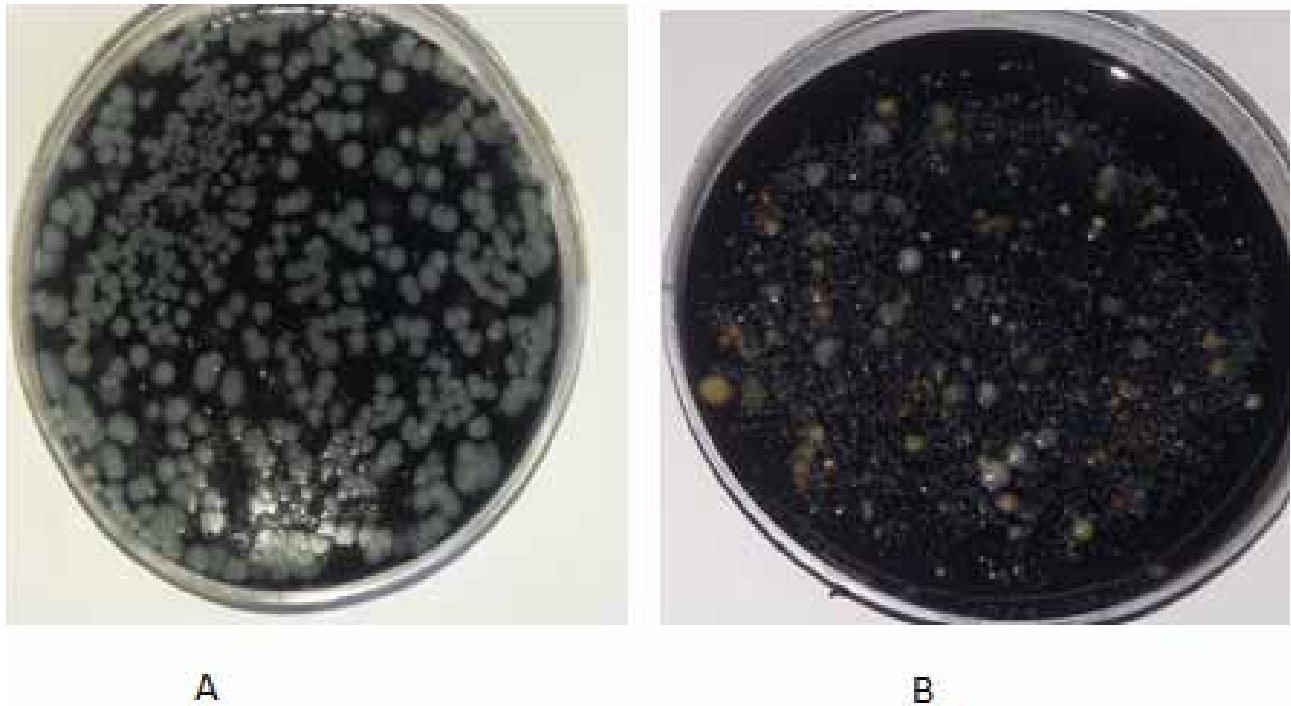


Figure 1: Representative *Legionella spp.* cultures, showing typical round pearl-white colonies on (a) GVPC and (b) BCYE agar plates.

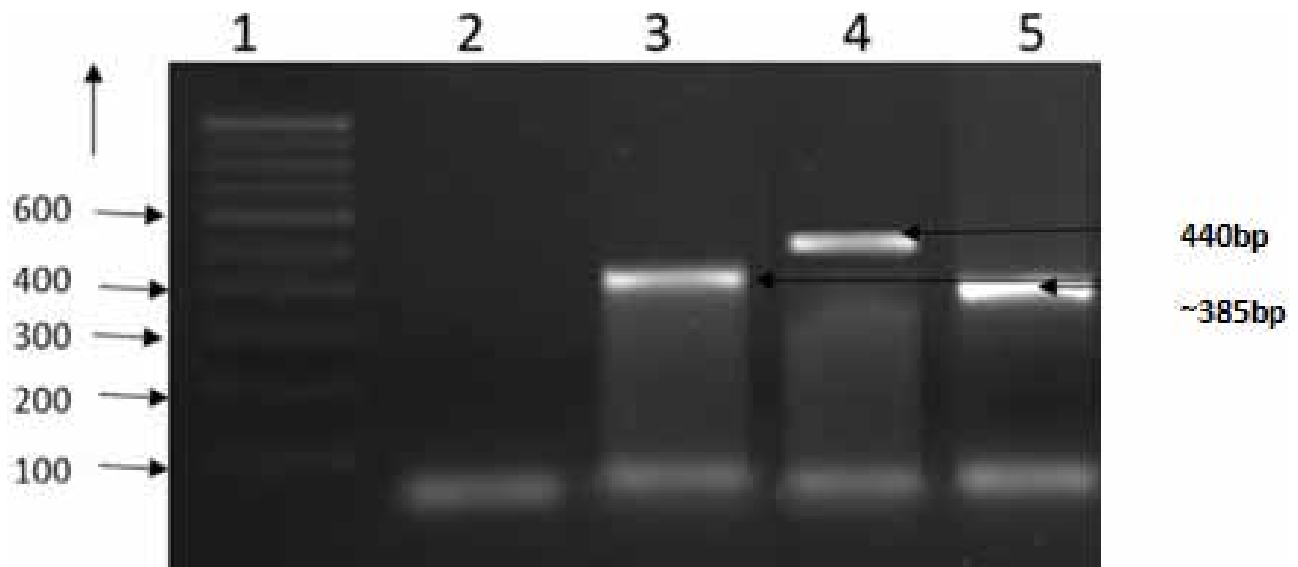


Figure 2. Representative agarose gel electrophoresis of one of the cooling tower samples. Lane 1: DNA ladder, lane 2: negative control, lane 3: JFP gene with expected size of 386 bp, lane 4: dot A step 1 product with expected size of 440 bp, lane 5: dot F step 2 product with expected size of 387 bp.

**Table 1: Summary of *Legionella* positive cultures based on 3-plate method.**

Sample Source	No. of samples	No. of positive BYCE plates	No. of positives GVPC plates	No. of positive GVP(w/cysteine)-plates
Drinking water coolers	30	30	30	10
Cooling towers	30	30	29	15
Showerheads	30	30	30	30

**Table 2: Summary of *Legionella* positive samples from different sources.**

Sample source	Growth on GVCP	PCR
Drinking water coolers	30	1
Cooling towers	29	9
Showerheads	30	2

**Table 3: Iron concentration range from samples across different sites.**

Source	<75 mg/l	75-300 mg/l	>300 mg/l
Drinking water coolers	5	9	16
Cooling towers	1	5	24
Showerheads	5	12	13

**Table 4: Iron concentration of PCR positive *Legionella* samples.**

Sample ID	Sample source	Iron concentration (mg/l)
K5	Drinking water	80
CT1	Cooler water	731
CT2	Cooler water	731
CT7	Cooler water	3300
CT15	Cooler water	1299
CT16	Cooler water	567
CT17	Cooler water	75
CT27	Cooler water	92
CT28	Cooler water	92
CT29	Cooler water	153
G1	Shower head	136
G6	Shower head	200

**Table S1: List of primers.**

Primer	Sequence 5'- 3'	Amplicon (size bp)
JFP	AGGGTTGATAGGTTAAGAGC	386
JRP	CCAACAGCTAGTTGACATCG	
dotF	ATTGTCTCGCGCGATTGC	440
dotRM	CTTCCATTGAGTTTCACCAAATCA	
dotFK	GGTGATGGTTAATAATGATCCGGC	387
dotRM	CTTCCATTGAGTTTCACCAAATCA	

## Conclusion

*Legionella* species were found to be prevalent in artificial water systems. The misconception that *Legionella* related diseases occur in developed countries alone should be overcome by public awareness and routine environmental monitoring. Our study indicates that 300 mg Fe/L is a reliable indicator of *Legionella* in case of cooling towers and thus can be used as first line of testing for potential sites for *Legionella* growth.

**Conflict of Interest:** Nil

**Sources of Funding:** Nitte (Deemed to be University) through the faculty research grant NURG/STF/07/7-2015.

**Ethical Clearance:** Obtained from K.S HEGDE MEDICAL ACADEMY Institutional Ethics Committee, Reference No: INST.EC/EC/021/2015-2016.

## References

- Steinert M, Hentschel U, Hacker J. *Legionella pneumophila*: an aquatic microbe goes astray. *FEMS microbiology reviews*. 2002 Jun 1;26(2):149-62.
- Newton HJ, Ang DK, Van Driel IR, Hartland EL. Molecular pathogenesis of infections caused by *Legionella pneumophila*. *Clinical microbiology reviews*. 2010 Apr 1;23(2):274-98.
- Long SS, Pickering LK, Prober CG. *Principles and practice of pediatric infectious diseases*, Elsevier Health Sciences. Philadelphia, PA. [Google Scholar]. 2012.
- Parr A, Whitney EA, Berkelman RL. Legionellosis on the rise: a review of guidelines for prevention in the United States. *Journal of Public Health Management and Practice*. 2015 Sep;21(5):E17.
- Chaudhry R, Dhawan B, Dey AB. The incidence of *Legionella pneumophila*: a prospective study in a tertiary care hospital in India. *Tropical doctor*. 2000 Oct;30(4):197-200.
- Chaudhry R, Sreenath K, Arvind V, Vinayaraj EV, Tanu S. *Legionella pneumophila* serogroup 1 in the water facilities of a tertiary healthcare center, India. *Emerging infectious diseases*. 2017 Nov; 23(11):1924.
- Anbumani S, Gururajkumar A, Chaudhury A. Isolation of *Legionella pneumophila* from clinical & environmental sources in a tertiary care hospital. *Indian Journal of Medical Research*. 2010 Jun 1;131(6):761.
- Llewellyn AC, Lucas CE, Roberts SE, Brown EW, Nayak BS, Raphael BH, Winchell JM. Distribution of *Legionella* and bacterial community composition among regionally diverse US cooling towers. *PLoS one*. 2017 Dec 20;12(12):e0189937.
- Atlas RM. *Legionella*: from environmental habitats to disease pathology, detection and control. *Environmental Microbiology*. 1999 Aug;1(4):283-93.
- Leoni E, De Luca G, Legnani PP, Sacchetti R, Stampi S, Zanetti F. *Legionella* waterline colonization: detection of *Legionella* species in domestic, hotel and hospital hot water systems. *Journal of Applied Microbiology*. 2005 Feb;98(2):373-9.
- Xu L, Luo ZQ. Cell biology of infection by *Legionella pneumophila*. *Microbes and infection*. 2013 Feb 1;15(2):157-67.
- Türetgen I, Sungur EI, Cotuk A. Enumeration of *Legionella pneumophila* in cooling tower water systems. *Environmental monitoring and assessment*. 2005 Jan 1;100(1-3):53.
- Benowitz I, Fitzhenry R, Boyd C, Dickinson M, Levy M, Lin Y, Nazarian E, Ostrowsky B, Passaretti T, Rakeman J, Saylor A. Rapid identification of a cooling tower-associated legionnaires' disease outbreak supported by polymerase chain reaction testing of environmental samples, New York City, 2014–2015. *Journal of environmental health*. 2018 Apr;80(8):8.
- Reeves MW, Pine L, Hutner SH, George JR, Harrell WK. Metal requirements of *Legionella pneumophila*. *Journal of clinical microbiology*. 1981 Apr 1;13(4):688-95.

# Deleted















# Practice of Documentation at Casualty of Tertiary Care Hospital: An Interventional Study

Ramasamy R.<sup>1</sup>, Ganesh Rajendiran<sup>2</sup>, Kagne R.N.<sup>3</sup>

<sup>1</sup>Assistant Professor, Department of Forensic Medicine & Toxicology, TMCH, Chennai, <sup>2</sup>Assistant Professor, Department of Forensic Medicine & Toxicology, SMVMCH, Puducherry, <sup>3</sup>Professor, Department of Forensic Medicine & Toxicology, SMVMCH, Puducherry

## Abstract

A medical record plays a major role for the patient and health care sector in terms of treatment and making policies on certain diseases. In any suit of negligence, this medical record will help the doctors to defend them. Many a times the complete and accurate documentation only have helped the medical fraternities from getting entangled in various consumer cases made by the patient against the doctors. Even though we have seen so many negligence cases on doctors, documentations are still incomplete in any medical record. There are studies shown that the average time spent by a doctor on a medical record is very less and the scenario is much worse when it comes to critical areas of the hospitals like casualty where the time is very precious in treating the patient and not much of importance is given for documentation. So to identify the current practice of documentation of medical records, this study was carried out to assess the documentation practice of the admission case sheets in the casualty of SMVMCH, Puducherry. An intervention was done to improve the completeness of documentation in the casualty and post-intervention analysis was also done. The results of the study showed that the percentage of documentation out of the 34 variables documented in the admission case sheets found to have significant deficiencies. But following the intervention on improving the documentation there has be a significant decrease of the deficiencies in the documentation practice on all those 34 variables.

**Keywords:** *Medical record, Documentation, Casualty and Admission case sheet.*

## Introduction

In a tertiary care hospital, medical records serve as a tool to provide better clinical care and to act as a means of communication between care providers.<sup>1</sup> Completed ocumentation of this medical record is very important, because the deficiencies in this documentation, have made the doctor's defenseless in medical negligence cases filed against them in the court.<sup>2</sup> Casualty being the first place of contact, a properly documented medical record is needed proper diagnosis and treatment.<sup>3</sup> Thus in view of a good patient care and to prevent a health care

provider from negligence suits, a standardized medical record documentation is very essential. This needs to stress on the "Golden Rule" in documentation i.e. "**If it isn't written down, you didn't do it.**"<sup>4</sup> Following the Honourable Supreme Court judgement in the year 1995, stating that "doctors also come under the perview of the Consumer Protection Act, 1986 which makes the medical faternity liable under the consumer forum for deficiencies in the quality care and treatment". To safeguard the physicians from these forums, the only defensive evidence was proper documentation which is the need of the hour.<sup>5</sup> So our study helps in identifying various deficiencies in the documentation of medical records mainly the admission case sheet in the casualty, followed by analysis and an interventional methodology to improve the same in the casualty, there by helping the patient to have a better care and the doctors to safeguard from litigations by having a proper documentation practice.

---

### Corresponding Author:

**Dr. Ganesh Rajendiran**

Assistant Professor, Department of Forensic Medicine & Toxicology, SMVMCH, Madagadipet, Puducherry  
e-mail: fm.ganeshr@smvmch.ac.in

Tel. +917094604964

## Materials and Method

The study was conducted at Department of Forensic Medicine, Sri Manakula Vinayagar Medical College and Hospital, Puducherry, after getting approval from the Institutional Ethics Committee approval (IEC NO-97/16). It was a hospital based cross-sectional study with pre and post interventional analysis, conducted for periods of 18 months from November, 2016 to April 2018. The case sheets of patients admitted under the department of medicine, surgery and orthopaedic in casualty were used as study sample. The total sample size was calculated, by using "Open Epi software version 3.0" taking into account the improvement in the documentation of case sheets from 16.0 % to 28.0 % based on previous study with 95% confidential interval and 80% power, as 680 case sheets. Out of total 680 case sheets, 340 case sheets were studied during the pre-interventional period and 340 case sheets during the post-interventional period using simple randomized sampling method. All case sheets of patients admitted to Casualty by the concerned departments were taken for the study. **Exclusion Criteria:** Out Patient case sheets attending casualty, Case sheets of patients referred to other hospitals, Case sheets of patients admitted to casualty by other than the Medicine, Surgery and orthopaedics department faculty. The checklist proforma for case sheets was prepared after going through the guidelines on documentation by Medical Council of India, admission case sheet format of our hospital and review of literature. The checklist proforma was scrutinized and validated by the faculty from the department of Medicine, Surgery and Orthopaedics. **A total of 34 variables were identified from the admission case sheets and grouped into 6 categories for analysis purpose as follows: Category A: Socio-demographic variables** (1.Patient name, 2.Address, 3.Age, 4.Sex, 5.Income, 6.Hospital number, 7.Date of patient), **Category B: History variables** (8.Narrated by, 9.Referred by, 10.Brought by, 11.Presenting complaints, 12.Past history, 13.Personal history, 14.Family history), **Category C: Physical examination and vitals variables** (15.General examination, 16.Blood pressure, 17.Pulse rate, 18.Respiratory rate, 19.Glasgow coma scale), **Category D: Systemic examination variables** (20.CVS examination, 21.RS examination, 22.Abdominal examination, 23.CNS examination, 24.ENT/Eye examination, 25.Oral cavity examination),

**Category E: Management variables** (26.Provisional diagnosis, 27.Plan of management, 28.Investigation) and **Category F: Doctor's variables** (29.Signature of the doctor, 30.Name of the doctor, 31. Designation, 32.Registration number, 33.Date, 34.Time). 340 case sheets of the patients admitted under the Department of Medicine, Surgery and Orthopaedics in emergency Department were recorded in checklist proforma before intervention. The variables in the checklist were entered in "Microsoft Excel" analysed in "Epi data analysis software version 2.2.2.186" and the deficiencies were identified. Intervention was done in the form of workshop to the faculties and post graduates of Medicine, Surgery and Orthopaedics Departments. The deficiencies found in the admission case sheets were highlighted and its importance in both improving patient care and legal implications on doctor's side were discussed. After the intervention, again the checklist proforma was filled up from 340 case sheets of patients during the post-interventional period. The difference between the documentation in the case sheet for pre and post interventional periods were assessed using Chi Square test. P value <0.05 was considered as statistically significant. The completeness of documentation in the case sheet was compared between pre and post interventional periods.

## Results

Total of 680 admission case sheets were analyzed, out of which 340 case sheets were analyzed in the pre intervention period and 340 case sheets in the post intervention period. Out of 340 admission case sheets in the pre-interventional period, 226 case sheets were of Medicine, 66 case sheets of Surgery and 48 case sheets of Orthopedics department. In the post-intervention, 192 case sheets belonged to Medicine, 89 case sheets to Surgery and 59 case sheets to Orthopedics.

However 340 pre and 340 post interventional admission case sheets of all three departments were collectively analysed and result were compared for this study. On Comparison of "**Socio-demographic variables**" (Table No. 1), except the variable of documenting Hospital number, rest all variable showed a significant increase in the practice of documentation in the post-intervention period.

**Table No 1: Comparison of pre and post interventional documentation of socio demographic variables**

S.No.	Socio demographic variables	Pre intervention (N=340)	Post intervention (N=340)	p value
		Number (%)	Number (%)	
1	Patient name	311 (91.5)	335 (98.5)	<0.001
2	Address	133 (39.1)	178 (52.4)	<0.001
3	Age	278 (81.8)	323 (95.0)	<0.001
4	Sex	277 (81.5)	321 (94.4)	<0.001
5	Date	219 (64.4)	259 (76.2)	<0.001
6	Income of patient	0 (0.0)	5 (1.5)	0.031
7	Hospital number	224 (65.9)	238 (70.0)	0.250

Table no 2 shows the details of documentation of “**History variables**” in the admission case sheets during the pre- and post- intervention period and its comparison analysis. Except the variables like referred by and past history, rest all variable showed a significant increase in the practice of documentation in the post-intervention period.

**Table No 2: Comparison of pre and post interventional documentation of history related variables**

S.No.	History variables	Pre-intervention (N=340)	Post-intervention (N=340)	p value
		Number (%)	Number (%)	
1	Narrated by	3 (0.9)	10 (2.9)	0.050
2	Brought by	143 (42.1)	177 (52.1)	0.009
3	Personal history	186 (54.7)	240 (70.6)	<0.001
4	Family history	96 (28.2)	150 (44.1)	<0.001
5	Referred by	11 (3.2)	20 (5.9)	0.098
6	Presenting complaints	340 (100.0)	340 (100.0)	NA
7	Past history	330 (97.1)	329 (96.8)	0.825

On comparison between the documentation practice of “**Physical examination and Vitals variables**” it was observed from the study that variables like BP, Pulse rate and General examination were documented properly even during the pre- intervention period itself.(Table No 3).

**Table No 3: Comparison of pre and post interventional documentation of Physical examination and Vitals variables**

S.No.	Physical examination and vitals variables	Pre intervention (N=340)	Post intervention (N=340)	p value
		Number (%)	Number (%)	
1	Blood pressure	316 (92.9)	310 (91.2)	0.394
2	Pulse rate	315 (92.6)	300 (90.3)	0.272
3	General examination	331 (97.4)	332 (97.6)	0.806
4	Coma scale	5 (1.5)	11 (3.2)	0.205
5	Respiratory rate	17 (5.0)	23 (6.8)	0.328

In this study, it was observed that doctors were proper in documenting the important variables like CVS, RS, CNS and Abdomen examination under the category of “**Systemic examination variables**”. (Table No 4).



**Table No 4: Comparison of pre and post interventional systemic examination related variables**

S.No.	System examination Variables	Pre intervention (N=340)	Post intervention (N=340)	p value
		Number (%)	Number (%)	
1	CVS examination	336 (98.8)	336 (98.8)	1.000
2	RS examination	335 (98.5)	336 (98.8)	0.737
3	Abdomen examination	335 (98.5)	335 (98.5)	1.000
4	CNS examination	331 (97.4)	329 (96.8)	0.650
5	ENT/Eye examination	153 (45.0)	142 (41.8)	0.395
6	Oral cavity examination	121 (35.6)	129 (37.9)	0.525

The study has shown that doctors have documented variables like Investigation and Provisional diagnosis without any fail in the admission case sheets during the pre- and post- intervention period under the category of “**Diagnosis related variables**” but during pre-intervention period documentation of Plan of management wasn’t done properly but later on after the intervention it was done properly. (Table No 5).

**Table No 5: Comparison of pre and post interventional management related variables**

S.No.	Diagnosis related variables	Pre intervention (N=340)	Post intervention (N=340)	p value
		Number (%)	Number (%)	
1	Plan of management	275 (80.9)	300 (88.2)	0.008
2	Investigation	329 (96.8)	336 (98.8)	0.067
3	Provisional diagnosis	337 (99.1)	339 (99.7)	0.316

In this study even though the doctors were found to be only proper in documenting their signature apart from other variables under the category of “**Documentation of doctor related variables**” during the pre-intervention period, later on after the intervention, significant improvement was observed in all the other variables as the doctors understood the importance of documenting these variables properly. (Table No 6).

**Table No 6: Comparison of pre and post interventional doctor information related variables**

S.No.	Documentation of doctor variables	Pre intervention (N=340)	Post intervention (N=340)	p value
		Number (%)	Number (%)	
1	Signature	320 (94.1)	336 (98.8)	<0.001
2	Name of doctor	222 (65.3)	320 (94.1)	<0.001
3	Designation	271 (79.7)	316 (92.9)	<0.001
4	Registration number	176 (51.8)	298 (87.6)	<0.001
5	Date of treatment	219 (64.4)	259 (76.2)	<0.001
6	Time	4 (1.2)	11 (3.2)	0.068

## Discussion

In our study total number of sample size was 680 case sheets which includes 340 case sheets of pre intervention period and 340 case sheets of post intervention period,

taking into consideration of 34 variables from the admission case sheet, similar study was conducted by Vahedi HS et al, titled “an impact of educational intervention on medical record documentation in

Iran” with 900 sample which including 300 medical records on pre interventional periods, 300 records on post interventional periods after 1 month and also 300 medical records on post interventional periods after 6 months and they have recorded 17 variables from all the medical record including progress sheets and admission sheets.<sup>6</sup>

In our study documentation of patient identity related variables in pre interventional period showed that the name of the patient was recorded 91.5%, address 31.9%, age 81.8% and sex was recorded in 81.5% where the other study of Saravi PM et al, study titled on “documentation of medical records in hospital of Mazandaran university of medical science in 2014” showed that the demographic findings was recorded in 95% history sheet, 90% on progress notes, 77% on admission notes and 61% of summary seats.<sup>7</sup>

Some A et al, study titled on “audit of medical record in 2010” showed that socio demographic characteristic of name, age, sex, residence, occupation, marital status and religion were available in 26 to 99% of the case sheets. This study conducted on 368 medical record on the department of medicine, surgery, obstetrics and gynaecology and paediatrics. Name of the patient were recorded in 100% on medicine and surgery department and totally 99.73%, age of the patient were recorded 98.1%, sex of the patient were recorded 91%, residence were recorded in 72.6 % of medical records.<sup>8</sup>

Bhanot K et al, titled on “Completeness in clerking: the surgical admission proforma” showed that address and age were recorded 100%, date and time of admission in and hospital number were recorded 96% in traditional clerking before proforma induced.<sup>9</sup> In our study documentation of personal history was recorded in 54.7 % on pre interventional period. Pastor G et al, 2010 study titled “the use of a pro-forma improves the quality of the emergency medical charts of patients with acute stroke” showed that personal history was recorded 98 % on medical records before introducing pro-forma.<sup>10</sup>

Khoshbaten M EM et al, titled an “The study of determination of re-education students and the faculty role in the improvement of medical record data files, proceeding of the 10<sup>th</sup> medical science education” showed that the training workshop will positively effect on documentation of medical records.<sup>11</sup> Tavakoli N et al, titled an “The study of inpatient medical records on hospital educations”: an interventional study showed that

intervention and qualitative and quantitative analysis of medical records will improve the documentation of medical records as well as it’s decrease the medical record deductions for more than 50%.<sup>12</sup>

Farzandipour et al, titled an “A pilot study of the impact of an educational intervention aimed at improving medical record documentation” showed that the diagnostic accuracy was not increased in single brief intervention.<sup>13</sup> The study by Tinsley et al<sup>14</sup> and other study by O Brien et al<sup>15</sup> sought that the documentation could be increased by education when it was reinforced with support of faculty members with regular feedback and also training regarding their charting quality.

## Conclusion

The following conclusions were made from the study i.e. awareness about the completeness of documentation on medical records was present only certain areas of documentation like documenting the patient name, presenting complaints and systemic examination, whereas other areas had not been given much importance while documenting. Explaining the medical fraternity in modes of intervention on the importance of documenting medical records in present era of evidence based medical education and increasing cases of medical negligence against doctors has been more useful by evidencing significant improvement in the documentation practice of case sheets in this study. But still there is more scope for improving the documentation process by having frequent interventions and using structured documents customized for each department in a user friendly manner.

**Conflict of Interest:** Nil

**Source of Funding:** Self

## References

1. Farhan J, Jummaa S-AI, Rajhi AAI, Rayes HAI, Nasser AAI. Documentation and coding of medical records in a tertiary care centre. *Annals of Saudi Medicine*. 2004; 25(1):46-49.
2. Srinivasalu K, Namburi VT, Samhitha ABS. Study on documentation of medical records. *Medico Legal Update*. 2016; 16:154-159.
3. Hripcsak G, Sengupta S, Wilcox A, Green RA. Emergency department access to a longitudinal medical record. *Journal of the American Medical Informatics Association*. 2007; 14:235-238.

4. Murphy BJ, Principles of good medical record documentation. *Journal of Medical Practice Management*. 2001; 16:258-60.
5. Jethani J. Medical records – It's important and relevant law. *AECs illumination*. 2004; 4(1):10-13.
6. Vahedi HS, Mirfakhrai M, Vahidi E, Saeedi M. Impact of an educational intervention on medical records documentation. *World Journal of Emergency Medicine*. 2018; 9(2):136-140.
7. Saravi BM, Asgaril Z, Siamian H, Farahabadi EB. Documentation of medical records in Hospitals of Mazandaran University of Medical Sciences in 2014: a quantitative study. *Acta Informatica Medica*. 2016; 24(3):202-206.
8. Some A, Outtara S, Barro S, Bambara M, Dao B. Audit of medical records. *Sante (Montrouge, France)*. 2010; 20(3):167-171.
9. Bhanot K, Abdi J, Bamania P, Samuel M et al. Completeness in clerking: The surgical admission proforma. *Annals of Medicine and Surgery*. 2017; 19:1-6.
10. Pastor AG, Morcillo AC, Henriques CF, Otero DF et al. The use of proforma improves the quality of the emergency medical charts of patients with acute stroke. *Neurologia*. 2011; 6(9):533-539.
11. Khoshbaten M EM, Isazade KH, Ghafarufard S. Determination of re-education student and the faculty role in the improvement of medical record data files, proceedings of the 10<sup>th</sup> medical science education. *Specialty Journal of Medical Education*. 2010; 6(1):23-24.
12. Tavakoli N, Jahanbakhsh M, Akbari M, Baktashian M, et al. The student of the inpatient medical record on hospital education: an interventional study. *Journal of Education and Health Promotion*. 2015; 4:38.
13. Farzandipour MMZ, Jeddi RF, Gilsi H, Shokrizadeh AL, et al. A pilot study of the impact of an educational interventional aimed at improving medical record documentation. *Journal of Royal College of Physicians of Edinburgh*. 2013; 43(1):29-34.
14. Tinsely JA. An educational intervention to improve residents' inpatient charting. *Academic psychiatry*. 2004; 28(2):136-139.
15. O'Brien KE, Chandramohan V, Nelson DA, Fischer JR, et al. Effect of a physician directed educational campaign on performance of proper diabetic foot exam in an outpatient setting. *Journal of General Internal Medicine*. 2003; 18(4):258-265.

# Risk Factors for Neonatal Death in Female Workers Mothers in Indonesia

Ratna Dwi Wulandari<sup>1</sup>, Agung Dwi Laksono<sup>2</sup>, Astridya Paramita<sup>3</sup>, Pramita Andarwati<sup>3</sup>, Naillul Izza<sup>3</sup>

<sup>1</sup>Lecturer, Faculty of Public Health, Universitas Airlangga Surabaya, Indonesia, <sup>2</sup>Researcher, National Institute of Health Research and Development, The Ministry of Health, The Republic of Indonesia, Jakarta, Indonesia,

<sup>3</sup>Researcher, Functional Unit of Health Technology Innovation, The Republic of Indonesia, Jakarta, Indonesia.

## Abstract

Female worker mothers have a greater risk of neonatal death during childbirth. The study aimed to analyze the risk factors for neonatal death among female worker mothers in Indonesia. The study used data of the 2017 Indonesia Demographic and Health Survey. With stratification and multistage random sampling, 18,061 female worker mothers aged 15-49 years old with live births in the last 5 years were sampled. The final analyzed using a binary logistic regression test. The results of the study found that female worker mothers with the wealth status of the poorer category had 0.738 times the probability of experiencing neonatal death compared to the poorest. Female worker mothers with wealth status in the middle category have a probability of 0.702 times compared to the poorest to experience neonatal death. Meanwhile, the richest female worker mothers had a probability of 0.662 times compared to the poorest to experience neonatal death. Meanwhile, female worker mothers who made ANC visits  $\geq 4$  times had a probability of 0.331 times compared to female worker mothers who made ANC visits  $< 4$  times. It could be concluded that there were 2 factors which are the risk factors for neonatal death among female worker mothers in Indonesia, namely poverty and ANC visits  $< 4$  times.

**Keywords:** Neonatal death, maternal health, female worker, risk factor.

## Introduction

The third goal of the Sustainable Development Goals, which was formulated and agreed upon to be achieved by all countries without exception, is to ensure a healthy life and support the welfare of all for all ages. One of the targets set to achieve this goal is to reduce the neonatal mortality rate to at least less than 12 per 1,000 births by 2030<sup>1</sup>.

Neonatal mortality is death that occurs before the baby is 28 days old. Neonatal Mortality Rate is the number of live births that died within the first 28 days of

life, per 1,000 live births in a given year. Based on the age group of infants, neonatal mortality is categorized into two, namely early neonatal mortality and late neonatal death. Early neonatal mortality is the death of a live-born baby within the first week of life or 7 days after birth, which is also called perinatal death (infants aged 0-7 days). Late neonatal mortality is the death of a live-born baby at the age of more than 7 days to 28 days, that is, the second to the fourth week of life. In general, neonatal mortality is caused by endogenous factors, namely factors that the child carries from birth, which is obtained from the parents at conception or during pregnancy, as well as conditions during and after delivery such as the occurrence of nosocomial infections from the ward or due to bleeding diseases in newborn baby<sup>2</sup>.

Global data in 2018 shows that 2.5 million children die in their first month of life, of which around 7000 newborn deaths occur every day with about one-third dying on the day of birth and nearly three-quarters

---

### Corresponding Author:

**Ratna Dwi Wulandari**

Faculty of Public Health, Universitas Airlangga  
Surabaya, Indonesia, Campus C Mulyosari Surabaya,  
Indonesia

e-mail: ratna-d-w@fkm.unair.ac.id

of them dying within the first week of life. Neonatal mortality decreases more slowly than mortality in children 1-59 months of age<sup>3</sup>. Meanwhile, Indonesia recorded a fairly high neonatal mortality rate. Analysis of the Indonesian Demographic and Health Survey in 2017 reports that the Neonatal Mortality Rate in Indonesia reaches 15 neonates per 1000 live births. This achievement is higher than the achievement recorded by countries in the region<sup>4</sup>.

Female workers are suspected of having a greater risk of experiencing neonatal death because of their dual duties to support daily family needs and pregnancy care. A previous study informed that female workers had a 1.52 times greater risk of experiencing neonatal death than non-female workers<sup>5</sup>. Meanwhile, another study informed that women who do not work are more likely to experience neonatal pulse 0.576 times compared to female workers<sup>6</sup>. Based on the background description, the study was aimed at analyzing the risk factors for neonatal death among female worker mothers in Indonesia.

## Materials and Method

The study used data from the 2017 Indonesian Demographic Data Survey (IDHS) as analysis material. The 2017 IDHS sample was determined through stratification and multistage random sampling. The unit of analysis in this study was female worker mothers, 15-49 years old, who had given birth in the last 5 years. Several 18,061 respondents were sampled.

Neonatal death is death in the neonatal period or the first twenty-eight days of life. Other variables analyzed as independent variables were a place of residence, age groups, education level, wealth status, parity, antenatal care (ANC), complication during pregnancy, childbirth assistance, and place of delivery. Place of residence divided into urban and rural. Age is the respondent's

last birthday. The education level is the last educational certificate the respondent has.

Wealth status was a wealth of respondents compiled based on the index of goods ownership quintile stated by the respondent. The five categories were the poorest (quintile 1), poorer (quintile 2), middle (quintile 3), richer (quintile 4), and richest (quintile 5). Parity is the number of living children a woman has ever born. In this study, parity was divided into two, namely primiparous (<2 children), and multiparous ( $\geq 2$  children).

Complications during pregnancy were the respondent's acknowledgment of complications experienced during pregnancy until delivery. These problems consist of: prolonged labor, vaginal bleeding, fever, convulsions, baby in the wrong position, swollen limbs, faint, breathlessness, tiredness, and others<sup>4</sup>. Childbirth assistance was divided into two categories, namely non-health workers and health workers. Meanwhile, the place of delivery consists of non-healthcare facilities and healthcare facilities.

Statistical analysis using chi-square was carried out to select the variables. Estimates were performed using binary logistic regression because of the nature of the dependent variable. All statistical analyses were carried out using SPSS 22 software.

## Results and Discussion

The information in Table 1 shows that in both categories, neonatal death is dominated by female worker mothers who live in rural areas. The two categories of neonatal death were also dominated by female worker mothers in the 35-39 age group who had secondary education. Based on wealth status, the two categories of neonatal death were dominated by the poorest female worker mothers.

**Table 1. Descriptive statistics of female worker mothers characteristics in Indonesia (n = 18,061)**

Variables	Neonatal Death				P
	No		Yes		
	n	%	n	%	
<b>Place of Residence</b>					0.056
Urban	8211	46.6%	178	41.9%	
Rural(ref.)	9425	53.4%	247	58.1%	

Variables	Neonatal Death				P
	No		Yes		
	n	%	n	%	
<b>Age groups</b>					0.686
15-19 yo.	93	0.5%	2	0.5%	
20-24 yo.	1001	5.7%	20	4.7%	
25-29 yo	2939	16.7%	67	15.8%	
30-34 yo.	4716	26.7%	108	25.4%	
35-39 yo.	5030	28.5%	119	28.0%	
40-44 yo.	3037	17.2%	86	20.2%	
45-49 yo. (ref.)	820	4.6%	23	5.4%	
<b>Education level</b>					***<0.001
No education (ref.)	556	3.2%	21	4.9%	
Primary	5199	29.5%	156	36.7%	
Secondary	8125	46.1%	184	43.3%	
Higher	3756	21.3%	64	15.1%	
<b>Wealth status</b>					***<0.001
Poorest (ref.)	5358	30.4%	177	41.6%	
Poorer	3045	17.3%	67	15.8%	
Middle	2937	16.7%	59	13.9%	
Richer	2987	16.9%	65	15.3%	
Richest	3309	18.8%	57	13.4%	
<b>Parity</b>					***<0.001
Primiparous	2088	11.8%	20	4.7%	
Multiparous (ref.)	15548	88.2%	405	95.3%	
<b>ANC</b>					***<0.001
< 4 times (ref.)	11214	63.6%	358	84.2%	
≥ 4 times	6422	36.4%	67	15.8%	
<b>Complication during pregnancy</b>					0.078
No	5744	82.0%	65	74.7%	
Yes (ref.)	1259	18.0%	22	25.3%	
<b>Childbirth assistance</b>					***<0.001
Non-health worker (ref.)	10305	58.4%	318	74.8%	
Health worker	7331	41.6%	107	25.2%	
<b>Place of delivery</b>					***<0.001
Non-Healthcare (ref.)	11532	65.4%	339	79.8%	
Healthcare	6104	34.6%	86	20.2%	

**Note:** \* p <0.05; \*\* p <0.01; \*\*\* p <0.001.

Table 1 shows that the two categories of neonatal death are also dominated by multiparous female worker mothers, and have incomplete ANC visits (<4 times).

Meanwhile, based on complications during pregnancy, the two categories of neonatal death were dominated by female worker mothers who did not experience

complications during pregnancy. The two categories of neonatal death are also dominated by female worker mothers who are accompanied by health workers during childbirth, and who do childbirth in non-healthcare.

Table 2 provides the results of the multivariate test with binary logistic regression. There are 6 variables

included in the final stage of determining risk factors for neonatal death among female worker mothers in Indonesia. The results of the analysis found that 2 variables were proven as risk factors for neonatal death among female worker mothers in Indonesia.

**Table 2. The result of binary logistic regression of the risk factors for neonatal death among female worker mothers in Indonesia (n=18,061)**

The Predictors	The Neonatal Death			
	Sig.	OR	CI (95%)	
			Lower Bound	Upper Bound
Education status: No education	-	-	-	-
Education status: Primary	0.798	0.941	0.589	1.502
Education status: Secondary	0.607	0.882	0.545	1.425
Education status: Higher	0.344	0.768	0.445	1.326
Wealth status: Poorest	-	-	-	-
Wealth status: Poorer	*0.043	0.738	0.550	0.991
Wealth status: Middle	*0.027	0.702	0.514	0.960
Wealth status: Richer	0.191	0.812	0.594	1.109
Wealth status: Richest	*0.020	0.662	0.468	0.937
Parity: Primiparous	0.245	0.745	0.454	1.223
Parity: Multiparous	-	-	-	-
ANC:< 4 times	-	-	-	-
ANC:≥ 4 times	***<0.001	0.331	0.229	0.480
Childbirth assistance: Non-health worker	-	-	-	-
Childbirth assistance:Health worker	0.917	1.025	0.640	1.643
Place of delivery: Non-healthcare	-	-	-	-
Place of delivery: Healthcare	0.520	1.175	0.718	1.922

**Note:** \*p <0.05; \*\*p <0.01; \*\*\*p <0.001.

First, female worker mothers with the wealth status of the poorer category had 0.738 times the probability of experiencing neonatal death compared to the poorest (OR 0.738; 95% CI 0.550-0.991). Female worker mothers with wealth status in the middle category had a probability of 0.702 times compared to the poorest to experience neonatal death (OR 0.702; 95% CI 0.514-0.960). Meanwhile, the richest female worker mothers had a probability of 0.662 times compared to the poorest to experience neonatal death (OR 0.662; 95% CI 0.468-0.937).

Information on the results of this analysis indicates that poverty is one of the risk factors for neonatal death among female worker mothers in Indonesia. The same findings of information were also found in the previous studies<sup>7,8</sup>. The results of the analysis informed that the richest group also had a risk of neonatal death, although the number was less than the other groups. This finding contradicts most studies which reveal that the low economic status (poorest, poorer, middle) is more at risk of neonatal mortality<sup>9-11</sup>. This information suggests that the economic status of the family, at any level, is likely to increase the risk of neonatal mortality. So that a more

comprehensive program approach is needed to reduce neonatal mortality.

The reason female workers leave their children to return to work early after childbirth is the demand to make a living for their families<sup>12,13</sup>. This condition also explains a large number of neonatal mortality rates in the group of working mothers with the poorest, poorer, and poor economic status. The pressure to make a living is greater in this group. The provision of paid leave for working mothers is one of the initiatives in the neonatal mortality reduction program recommended by WHO and ILO. Output in the form of maternal and neonatal health levels was found to be better for working mothers who received paid maternity leave for longer<sup>14,15</sup>.

Second, female worker mothers who performed ANC completely ( $\geq 4$  times) were 0.331 times more likely than female worker mothers who performed ANC incompletely (OR 0.331; 95% CI 0.229-0.480). The results of this analysis inform that doing ANC incompletely, or  $< 4$  times, is one of the risk factors for neonatal death among female worker mothers in Indonesia.

The findings of this analysis are in line with the recommendation of the Indonesian government which states that the ANC during pregnancy is done at least 4 times, namely in the first trimester 1 time, in the second trimester 1 time, and in the third trimester 2 times<sup>16</sup>. This information also confirms the results of previous studies in several countries that ANC is a positive determinant for preventing neonatal death<sup>17-20</sup>. Meanwhile, a study in Afghanistan informed that ANC by skilled providers reduced the risk of neonatal death to 0.7 times compared to non-skilled providers<sup>21</sup>.

### Conclusions

Based on the research results, it could be concluded that 2 factors are the risk factors for neonatal death among female worker mothers in Indonesia. These two factors were poverty and incomplete ANC.

It is recommended that the government issue a policy that can encourage companies that employ female worker mothers to facilitate the ANC process when they are pregnant, especially for poor female worker mothers. Working mothers in the formal sector need to be paid maternal leave for at least 12 weeks after giving birth to provide opportunities for mothers to care for their babies. For mothers working in the informal

sector, it is necessary to think about providing a social safety net in the form of maternal cash benefits that can be implemented together with the National Health Insurance. This policy is needed to reduce neonatal death in Indonesia.

**Acknowledgments:** The author would like to thank the ICF International, who has agreed to allow the 2017 IDHS data to be analyzed in this article.

**Source of Funding:** Self-funding

**Conflict of Interests:** Nil

**Ethical Clearance:** The 2017 IDHS has passed ethical tests from the National Institute for Health Research and Development of the Indonesian Ministry of Health. The use of the 2017 IDHS data for this study has received permission from ICF International through its website: <https://dhsprogram.com/data/new-user-registration.cfm>.

### References

1. SDG Indonesia 2030. Goal 03 SDGs (Tujuan 03 SDGs) [Internet]. 2020 [cited 2020 Aug 25]. p. 3. Available from: <https://www.sdg2030indonesia.org/page/11-tujuan-tiga>
2. UNICEF. Neonatal mortality. 2019.
3. World Health Organization. Newborns: reducing mortality [Internet]. 2019 [cited 2020 Aug 25]. p. 1. Available from: <https://www.who.int/en/news-room/fact-sheets/detail/newborns-reducing-mortality>
4. National Population and Family Planning Board, Statistics Indonesia, Ministry of Health, The DHS Program. Indonesia Demographic and Health Survey 2017 [Internet]. Jakarta; 2018. Available from: <https://www.dhsprogram.com/pubs/pdf/FR342/FR342.pdf>
5. Faisal A. Factors Associated with Infant Mortality in Indonesia 2003-2007 (Faktor-Faktor Yang Berhubungan dengan Kematian Bayi di Indonesia Tahun 2003-2007). Universitas Indonesia Jakarta, Indonesia; 2010.
6. Wulandari RD, Laksono AD. Is parity a predictor of neonatal death in Indonesia? Analysis of the 2017 Indonesia demographic and health survey. *Indian J Forensic Med Toxicol*. 2020;14(3):2161-6.
7. Vijay J, Kumar Patel K. Risk factors of infant mortality in Bangladesh. *Clin Epidemiol Glob*



- Heal. 2020;8(1):211–4.
8. Morakinyo OM, Fagbamigbe AF. Neonatal, infant and under-five mortalities in Nigeria: An examination of trends and drivers (2003-2013). *PLoS One*. 2018;12(8):Article number e0182990.
  9. Afshan K, Narjis G, Qureshi IZ, Cappello M. Social determinants and causes of child mortality in Pakistan: Analysis of national demographic health surveys from 1990 to 2013. *J Paediatr Child Health*. 2020;56(3):457–72.
  10. Lu SSM, Stewart Williams J, Sommar JN. Inequalities in early childhood mortality in Myanmar - Association between parents' socioeconomic status and early childhood mortality. *Glob Health Action*. 2019;12(1):Article number 1603516.
  11. Khajavi A, Pishgar F, Dehghani M, Naderimigham S. Socioeconomic inequalities in neonatal and postneonatal mortality: Evidence from rural Iran, 1998-2013. *Int J Equity Health*. 2017;16(1):Article number 83.
  12. Baxter J. Is money the main reason mothers return to work after childbearing? *J Popul Res*. 2008;25:141–160.
  13. Schmidt E-M, Rieder I. All about the money? Parents' justification patterns behind their parental leave arrangements. *SWS - Rundschau*. 2016;56(4):489–508.
  14. Hewitt B, Strazdins L, Martin B. The benefits of paid maternity leave for mothers' post-partum health and wellbeing: Evidence from an Australian evaluation. *Soc Sci Med*. 2017;182(97–105).
  15. Aitken Z, Garrett CC, Hewitt B, Keogh L, Hocking JS, Kavanagh AM. The maternal health outcomes of paid maternity leave: A systematic review. *Soc Sci Med*. 2015;130:32–41.
  16. Laksono AD, Rukmini R, Wulandari RD. Regional disparities in antenatal care utilization in Indonesia. *PLoS One*. 2020;15(2):e0224006.
  17. Laksono AD, Wulandari RD. Understanding Neonatal Death in Urban Area in Indonesia. *Medico-Legal Updat*. 2020;20(2):825–9.
  18. Wulandari RD, Laksono AD. Antenatal Care as Predictor of Neonatal Death in Rural Indonesia. *Int Med J [Internet]*. 2020;25(2):511–8. Available from: <https://www.seronejhou.com/article/antenatal-care-as-predictor-of-neonatal-death-in-rural-indonesia>
  19. Basha GW, Woya AA, Tekil AK. Determinants of neonatal mortality in Ethiopia: An analysis of the 2016 Ethiopia demographic and health survey. *Afr Health Sci*. 2020;20(2):715–23.
  20. Mersha A, Bante A, Shibiru S. Neonatal mortality and its determinates in public hospitals of Gamo and Gofa zones, southern Ethiopia: Prospective follow up study. *BMC Pediatr*. 2019;19(1):Article number 499.
  21. Kibria GMA, Burrowes V, Choudhury A, Sharmeen A, Ghosh S, Mahmud A, et al. Determinants of early neonatal mortality in Afghanistan: An analysis of the Demographic and Health Survey 2015. *Global Health*. 2018;14(1):Article number 47.

# Barriers to Antenatal Care Utilization in Indonesia

Ratna Dwi Wulandari<sup>1</sup>, Agung Dwi Laksono<sup>2</sup>, Tety Rachmawati<sup>2</sup>, Rukmini Rukmini<sup>2</sup>

<sup>1</sup>Faculty of Public Health, Universitas Airlangga, Surabaya, Indonesia. Campus C Mulyorejo Surabaya, Indonesia,

<sup>2</sup>Researcher, National Institute of Health Research and Development, Indonesian Ministry of Health, Jakarta, Indonesia

## Abstract

MMR data in Indonesia fluctuates according to the data source used. Based on Indonesia Demographic and Health Survey data, MMR in Indonesia in 1990 was 390 per 100,000 live births, in 2004/2007 it was 228/100,000 live births, then increased sharply in 2008-2012 by 359/100,000 live births. Whereas based on the 2015 SUPA data, MMR in Indonesia decreased by 305 per 100,000 per live birth. This study aims to analyze the barrier to  $\geq 4$  ANC visits during pregnancy. The analysis uses the 2017 Indonesian Demographic and Health Survey data. Stratification and multistage random sampling method get 15,351 respondents. Barrier determination was done using Binary Logistic Regression. The barriers consisted of the following variables: young age, low education, high parity, poverty, not having health insurance, not being able to read, not being exposed to the media, never using the internet, not knowing the danger signs of pregnancy, and belief in traditional birth attendants.

**Keywords:** *Antenatal care, healthcare utilization, the barrier of utilization, mother and child health.*

## Introduction

Maternal Mortality Rate (MMR) is an indicator of the level of women's health that illustrates the level of access, integrity, and effectiveness of the health sector. Therefore, MMR is often used as an indicator of the welfare level of a country. Since 1988, the Indonesian Ministry of Health has focused its policy on improving maternal health and well-being, as MMR's reaction is still high in Indonesia. Starting from the "Safe Motherhood" program in 1988, the Dear Mother Movement in 1996, the National Strategic Plan for Making Pregnancy Safer in 2001-2010, Birth Assurance in 2011, to the National Action Plan for Acceleration in Decreasing Maternal Mortality Rates 2013-2015<sup>1</sup>.

MMR data in Indonesia fluctuates according to the data source used. Based on Indonesia Demographic

and Health Survey Data, MMR in Indonesia in 1990 was 390 per 100,000 live births, in 2004/2007 it was 228/100,000 live births, then increased sharply in 2008-2012 by 359/100,000 live births. Whereas based on the 2015 SUPA data, MMR in Indonesia decreased by 305 per 100,000 per live birth<sup>1</sup>.

One of the policies to reduce MMR in Indonesia is an effort to improve the quality of health services, especially pregnant woman examination services by professionals who are following integrated Antenatal Care (ANC) service standards. Minimum ANC standard services include 1) Measure Weigh; 2) Measure the circumference of the upper arm; 3) Measure blood pressure; 4) Measure fundal height; 5) Calculate fetal heart rate; 6) Determine the fetal presentation; 7) Give TT immunization; 8) Give blood plus tablets (Fe); 9) Check routine and specialized laboratories (blood type examination, blood hemoglobin level check, urine protein check, blood sugar level check, malaria blood test, syphilis test, HIV test, and smear examination); 10) Management or handling of cases<sup>2</sup>.

Several recent studies have shown that health-seeking behavior is influenced by individual and household factors, including education, marital status,

---

### Corresponding Author:

**Ratna Dwi Wulandari**

Faculty of Public Health, Universitas Airlangga,  
Surabaya, Indonesia. Campus C Mulyorejo Surabaya,  
Indonesia

e-mail: ratna-d-w@fkm.unair.ac.id

wealth status, health insurance<sup>3</sup>, and health belief<sup>4</sup>. Besides, external factors such as the availability of information and media exposure also contribute to health-seeking behavior<sup>5</sup>.

This study was conducted to analyze the barrier of the use of  $\geq 4$  ANC visits during pregnancy in women aged 15-49 years old who gave birth in the last five years in Indonesia. The results of this study are useful for the Ministry of Health to determine the acceleration of ANC utilization policy of at least 4 visits during pregnancy to reduce maternal mortality in Indonesia.

## Materials and Method

This research was conducted using secondary data from the 2017 Indonesian Demographic Data Survey (IDHS). The IDHS was part of the International Demographic and Health Survey program conducted by the Inner City Fund. The 2017 IDHS sampling method was done by stratification and multistage random sampling. With the analysis unit of women aged 15-49 years old who had given birth in the last 5 years, a sample size of 15,351 women was obtained.

Following recommendations from the Ministry of Health, ANC was performed at least 4 times during pregnancy, which was at least 1 time in the first trimester, at least 1 time in the second trimester, and at least 2 times in the third trimester<sup>6</sup>. Other variables analyzed are the place of residence, age, marital status, education level, parity, wealth status, health insurance, literacy, media exposure, frequency of media, use of the internet, know the danger of pregnancy, and belief in traditional birth attendants. Barrier determination was done using Binary Logistic Regression because of the nature of the dependent variable. All statistical analyses were carried out using SPSS 21 software.

## Results and Discussion

Table 1 is a statistical description of the socio-demographic characteristics of respondents. There are significant differences between women who make  $< 4$  ANC visits compared to women who make  $\geq 4$  ANC visits in all socio-demographic categories. Women who make  $\geq 4$  ANC visits are more dominant in urban areas and the 30-34 age group.

**Table 1. Socio-Demographic of Respondents (n=15,351)**

Variables	ANC		All	P
	<4 visits	$\geq 4$ visits		
<b>Place</b>				0.000***
• Urban	627(34.45%)	6941(51.30%)	7568(49.30%)	
• Rural(ref.)	1193(65.55%)	6590(48.70%)	7783(50.70%)	
<b>Age</b>				<0.001***
• 15-19	102(5.60%)	314(2.32%)	416(2.71%)	
• 20-24	309(16.98%)	2105(15.56%)	2414(15.73%)	
• 25-29	394(21.65%)	3453(25.51%)	3847(25.06%)	
• 30-34	408(22.42%)	3555(26.27%)	3963(25.82%)	
• 35-39	351(19.29%)	2705(19.99%)	3056(19.91%)	
• 40-44	201(11.04%)	1156(8.54%)	1357(8.84%)	
• 45-49 (ref.)	55(3.02%)	243(1.80%)	298(1.94%)	
<b>Marital</b>				<0.001***
• Single/Never in union (ref.)	8(0.44%)	20(0.15%)	28(0.18%)	
• Married/Living with partner	1702(93.52%)	13141(97.12%)	14843(96.69%)	
• Widowed/Divorced	110(6.04%)	370(2.73%)	480(3.13%)	
<b>Education</b>				<0.001***
• No education(ref.)	88(4.84%)	116(0.86%)	204(1.33%)	
• Primary	695(38.19%)	3164(23.38%)	3859(25.14%)	

Variables	ANC		All	P
	<4 visits	≥4 visits		
• Secondary	857(47.09%)	7771(57.43%)	8628(56.20%)	
• Higher	180(9.89%)	2480(18.33%)	2660(17.33%)	
<b>Parity</b>				<0.001***
• <2	459(25.22%)	4296(31.75%)	4755(30.98%)	
• 2-4	1013(55.66%)	8394(62.04%)	9407(61.28%)	
• >4 (ref.)	348(19.12%)	841(6.22%)	1189(7.75%)	
<b>Wealth status</b>				<0.001***
• Poorest (ref.)	913(50.16%)	3160(23.35%)	4073(26.53%)	
• Poorer	368(20.22%)	2663(19.68%)	3031(19.74%)	
• Middle	260(14.29%)	2630(19.44%)	2890(18.83%)	
• Richer	171(9.40%)	2589(19.13%)	2760(17.98%)	
• Richest	108(5.93%)	2489(18.39%)	2597(16.92%)	
<b>Health insurance</b>				<0.001***
• No(ref.)	851(46.76%)	4988(36.86%)	5839(38.04%)	
• Yes	969(53.24%)	8543(63.14%)	9512(61.96%)	

Note: \*p<0.05; \*\*p<0.01; \*\*\*p<0.001.

Table 1 informs that women who make ANC visits during pregnancy are dominated by women who are married or living with partners. The education level category is dominated by secondary education women. Table 1 shows that women who made ANC visits during pregnancy were dominated by women who had parity 2-4 and were very poor. Dominance is also shown by women who are covered by health insurance.

Table 2 is a statistical description of the characteristics of knowledge and information exposure of respondents aged 15-49 years old who gave birth in the last five years in Indonesia. Table 2 informs that there are significant differences between women who make <4 ANC visits compared with women who make ≥4 ANC visits during pregnancy in all categories.

Table 2 shows that women who were able to read whole sentences were exposed to the media less than once a week, and had never used the internet were more dominant in both ANC frequency categories. While in the “know the danger sign of pregnancy” category, the group of women who made ≥4 ANC visits during pregnancy was dominated by those who knew. While the group of women who made ≥4 ANC visits during pregnancy was dominated by those who did not know. Table 2 informs us that in both categories ANC frequencies were dominated by women who did not believe in traditional birth attendants.

**Table 2. Knowledge and exposure of information (n=15,351)**

Variables	ANC		All	P
	<4 visits	≥4 visits		
<b>Literacy</b>				<0.001***
• Cannot read at all (ref.)	180(9.89%)	324(2.39%)	504(3.28%)	
• Able to read only part of sentences	96(5.27%)	251(1.85%)	347(2.26%)	
• Able to read whole sentence	1540(84.62%)	12939(95.62%)	14479(94.32%)	
• Blind/visually impaired	4(0.22%)	17(0.13%)	21(0.14%)	

Variables	ANC		All	P
	<4 visits	≥4 visits		
<b>Media exposure</b>				<0.001***
• No (ref.)	185(10.16%)	414(3.06%)	599(3.90%)	
• Yes	1635(89.84%)	13117(96.94%)	14752(96.10%)	
<b>Frequency of media</b>				<0.001***
• Less than once a week (ref.)	1394(76.59%)	9109(67.32%)	10503(68.42%)	
• At least one a week	426(23.41%)	4422(32.68%)	4848(31.58%)	
<b>Use of internet</b>				<0.001***
• Never (ref.)	1349(74.12%)	7029(51.95%)	8378(54.58%)	
• Yes, last 12 months	428(23.52%)	6221(45.98%)	6649(43.31%)	
• Yes, before last 12 month	43(2.36%)	281(2.08%)	324(2.11%)	
<b>Know the danger sign of pregnancy</b>				<0.001***
• No (ref.)	1061(58.30%)	4406(32.56%)	5467(35.61%)	
• Yes	759(41.70%)	9125(67.44%)	9884(64.39%)	
<b>Belief in traditional birth attendant</b>				<0.001***
• No (ref.)	1661(91.26%)	13034(96.33%)	14695(95.73%)	
• Yes	159(8.74%)	497(3.67%)	656(4.27%)	

Note: \*p<0.05; \*\*p<0.01; \*\*\*p<0.001.

Table 3 shows the results of the binary logistic regression test which illustrates the barrier of using ANC in Indonesia. As reference is <4 ANC visits during pregnancy. Table 3 shows that women in the 15-19 age group were 0.286 times more likely than women in the 44-49 age group to make ≥4 ANC visits during pregnancy. While women in the 20-24 age group were

0.569 times more likely than women in the 44-49 age group. This shows that younger age is a barrier to make ≥4 ANC visits during pregnancy. A study in Angola from a different perspective also found similar results. The study found that older women had better chances of utilizing ANC<sup>7</sup>.

**Table 3. Binary Logistic Regression of ANC Utilization (n=15,351)**

Predictor	≥4 ANC visits			
	P	OR	Lower Bound	Upper Bound
Place: Urban	0.905	0.993	0.879	1.121
Age: 15-19	<0.001***	0.286	0.185	0.443
Age: 20-24	0.003**	0.569	0.392	0.827
Age: 25-29	0.195	0.790	0.554	1.128
Age: 30-34	0.668	0.927	0.655	1.312
Age: 35-39	0.849	1.034	0.734	1.458
Age: 40-44	0.799	0.955	0.668	1.364
Marital: Married/Living with partner	0.487	1.360	0.571	3.238
Marital: Widowed/Divorced	0.326	0.639	0.261	1.562
Education: Primary	0.013*	1.593	1.104	2.300

Predictor	≥4 ANC visits			
	P	OR	Lower Bound	Upper Bound
Education: Secondary	0.007**	1.713	1.161	2.526
Education: Higher	0.507	1.155	0.755	1.767
Parity: <2	<0.001***	3.930	3.142	4.915
Parity: 2-4	<0.001***	2.627	2.215	3.115
Wealth status: Poorer	<0.001***	1.528	1.323	1.764
Wealth status: Midle	<0.001***	1.807	1.530	2.134
Wealth status: Richer	<0.001***	2.328	1.907	2.842
Wealth status: Richest	<0.001***	3.127	2.441	4.006
Insurance: Yes	<0.001***	1.408	1.266	1.566
Literacy: Able to read only part of sentences	0.554	0.902	0.640	1.270
Literacy: Able to read whole sentence	0.016*	1.385	1.061	1.807
Literacy: Blind/visually impaired	0.680	1.273	0.404	4.010
Media exposure: yes	0.004**	1.366	1.106	1.687
Frequency of media: At least one a week	0.196	0.920	0.810	1.044
Internet: Yes. last 12 months	<0.001***	1.413	1.215	1.644
Internet: Yes. before last 12 month	0.647	1.085	0.766	1.537
Know the danger sign of pregnancy: Yes	<0.001***	1.900	1.703	2.121
Belief in traditional birth attendant: Yes	<0.001***	0.527	0.432	0.643

**Note:** \* p<0.05; \*\* p<0.01; \*\*\* p<0.001.

The women with primary education are 1.593 times more likely than no education women to make ≥4 ANC visits during pregnancy. While women with secondary education were 1.713 times more likely than no education. This condition shows that uneducated is a barrier to ≥4 ANC visits during pregnancy. The result is similar to previous research that found the same phenomenon<sup>8</sup>. The higher a person's education, the better her chance in utilizing health services, because she knows about her needs, and knows how to fulfill them<sup>9-11</sup>.

The research shows that have many children is a barrier to making ≥4 ANC visits. The results of this analysis are in line with studies conducted in Eastern Ethiopia. The study found that primiparous and multiparous women had lower birth preparedness and complication readiness than primiparous women. Having many children was also informed as a predictor of neonatal death in Indonesia<sup>12,13</sup>

Wealth status in all categories there is a better chance than the poorest women. The richer the more likely it is to make ≥4 ANC visits. This condition shows that

poverty is a barrier to ≥4 ANC visits during pregnancy. Moreover, the women who were covered by health insurance had 1.408 times more likely than women who were not covered by health. This shows that not having health insurance is a barrier to making ≥4 ANC visits during pregnancy.

Poor and without health insurance were found as barriers to get ≥4 ANC visits. These two conditions are interrelated. In general, it is known that health insurance can increase public access to health care facilities<sup>14</sup>. The same condition also applies to accessibility to get ≥4 ANC visits. Not having health insurance is a barrier to getting ≥4 ANC visits during pregnancy. Health financing policies in Indonesia try to reduce this barrier by providing subsidies for contributions to the National Health Insurance mechanism. It is hoped that this policy can improve the access of the poor to health services, including the ANC<sup>15</sup>.

Table 3 informs us that in the literacy category, women who were able to read whole sentences were 1.385 times more likely than women who could not read

at all to make  $\geq 4$  ANC visits. This condition shows that the inability in literacy is a barrier to make  $\geq 4$  ANC visits during pregnancy. This finding is in line with the results of research in Afghanistan which found that women who could read were three times better than those who could not read when using ANC<sup>16</sup>. Literacy ability is a determining factor in the level of knowledge of obstetric danger signs and perceptions of the need for obstetric care<sup>17</sup>.

Table 3 shows that women who were exposed to the media were 1.366 times more likely than women who were not exposed to the media to make  $\geq 4$  ANC visits. This shows that media exposure is a barrier to making  $\geq 4$  ANC visits during pregnancy. While the frequency of media exposure did not show any influence on the ANC frequency. Moreover, the women who used the internet last 12 months were 1.413 times more likely than women who never used the internet. This shows that never using the internet is a barrier to making  $\geq 4$  ANC visits during pregnancy. This condition is in line with the inability to read and low education, as well as its effects, being ignorant of the danger signs of pregnancy.

Table 3 shows that women who knew the danger sign of pregnancy were 1.900 times more likely than women who did not know the danger sign of pregnancy. This shows that ignorance of the danger sign of prevention is a barrier to making  $\geq 4$  ANC visits. While the women who believe in traditional birth attendants are 0.527 times more likely than women who do not believe in traditional birth attendants. This shows that belief in traditional birth attendants is a barrier to make  $\geq 4$  ANC visits during pregnancy. Indonesia has thousands of ethnic groups. There are still many health beliefs that exist among these tribes. This condition encourages Indonesian women to still trust traditional birth attendants<sup>4</sup>.

### Conclusions

Based on the results of the study, it could be concluded that 10 variables become a barrier for Indonesian women to make  $\geq 4$  ANC visits during pregnancy. The barriers consisted of the following variables: young age, low education, high parity, poverty, not having health insurance, not being able to read, not being exposed to the media, never using the internet, not knowing the danger signs of pregnancy, and belief in traditional birth attendants.

**Acknowledgments:** The author would like to thank

the ICF International, who has agreed to allow the 2017 IDHS data to be analyzed in this article.

**Source of Funding:** Self-funding

**Conflict of Interest:** The authors declare no conflict of interest, financial or otherwise.

**Ethical Clearance:** The 2017 IDHS has received ethical clearance from the National Ethics Commission. Utilization of the 2017 IDHS data in this study has been permitted by ICF International through its website: <https://dhsprogram.com/data/new-user-registration.cfm>.

### References

1. Communication and Community Service Bureau Ministry of Health Republic of Indonesia. The Ministry of Health Encourages Development in the 4.0 Era (Kemenkes Dorong Pembangunan SDM Era 4.0.) [Internet]. Jakarta; 2019. Available from: <http://www.depkes.go.id/article/print/19031200002/kemenkes-dorong-pembangunan-sdm-era-4-0.html>
2. Directorate General of Community Health Development. Guidelines for Integrated Antenatal Services (Pedoman Pelayanan Antenatal Terpadu). Jakarta: Ministry of Health of the Republic of Indonesia; 2010.
3. Wulandari RD, Laksono AD. Relationship between Midwife Ratio and Performance of Maternal and Child Health Programs in Indonesia (Hubungan antara Rasio Bidan dengan Kinerja Program Kesehatan Ibu dan Anak di Indonesia). *Bul Penelit Sist Kesehat*. 2019;22(3):208–214.
4. Laksono AD, Soerachman R, Angkasawati TJ. Case Study of Muyu Ethnic's Maternal Health in Mindiptara District-Boven Digoel (Studi Kasus Kesehatan Maternal Suku Muyu di Distrik Mindiptana, Kabupaten Boven Digoel). *J Reprod Heal*. 2016;07/03:145–55.
5. Bago J-L, Lompo ML. Exploring the linkage between exposure to mass media and HIV awareness among adolescents in Uganda. *Sex Reprod Healthc*. 2019;21:1–8.
6. National Population and Family Planning Board, Statistics Indonesia, Ministry of Health, The DHS Program. Indonesia Demographic and Health Survey 2017 [Internet]. Jakarta; 2018. Available from: <https://www.dhsprogram.com/pubs/pdf/FR342/FR342.pdf>

7. Rosário EVN, Gomes MC, Brito M, Costa D. Determinants of maternal health care and birth outcome in the Dande Health and Demographic Surveillance System area, Angola. *PLoS One*. 2019;14(8):Article number e0221280.
8. Tayfur I, Günaydin M, Suner S. Healthcare Service Access and Utilization among Syrian Refugees in Turkey. *Ann Glob Heal*. 2019;85(1).
9. Wulandari RD, Laksono AD. Education as predictor of the knowledge of pregnancy danger signs in Rural Indonesia. *Int J Innov Creat Chang*. 2020;13(1):1037–51.
10. Rohmah N, Yusuf A, Hargono R, Laksono AD, Masruroh, Ibrahim I, et al. Determinants of teenage pregnancy in Indonesia. *Indian J Forensic Med Toxicol*. 2020;14(3):2080–5.
11. Laksono AD, Wulandari RD. Predictors of Hospital Utilization Among Papuans in Indonesia. *Indian J Forensic Med Toxicol*. 2020;14(2):2319–24.
12. Wulandari RD, Laksono AD. Is parity a predictor of neonatal death in Indonesia? Analysis of the 2017 Indonesia demographic and health survey. *Indian J Forensic Med Toxicol*. 2020;14(3):2161–6.
13. Laksono AD, Wulandari RD. Understanding Neonatal Death in Urban Area in Indonesia. *Medico-Legal Updat*. 2020;20(2):805–9.
14. Laksono AD, Soedirham O, Saptandari P, Wulandari RDRD. Study of family size among tenggerese in Indonesia. *Int J Innov Creat Chang*. 2020;13(4):964–78.
15. Agustina R, Dartanto T, Sitompul R, Susiloretni KA, Suparmi, Achadi EL, et al. Universal health coverage in Indonesia: concept, progress, and challenges. *Lancet*. 2019;393(10166):75–102.
16. Azimi MW, Yamamoto E, Saw YM, Kariya T, Arab AS, Sadaat SI, et al. Factors associated with antenatal care visits in Afghanistan: secondary analysis of Afghanistan Demographic and Health Survey 2015. *Nagoya J Med Sci*. 2019;81(1):121–31.
17. Oguntunde O, Nyenwa J, Yusuf FM, Dauda DS, Salihu A, Sinai I. Factors associated with knowledge of obstetric danger signs and perceptions of the need for obstetric care among married men in northern Nigeria: A cross-sectional survey. *BMC Pregnancy Childbirth*. 2019;19(1):Article number 123.



# A Questionnaire Based Study Evaluating Awareness for Organ and Body Donation and Cadaveric Dissection among the General Population Attending Medical and Dental Hospital

K.M. Parmar<sup>1</sup>, Hetal Vaisnani<sup>2</sup>, Nirali Chavda<sup>3</sup>, Priyanka Sharma<sup>4</sup>, Kinjal Jethava<sup>1</sup>

<sup>1</sup>Associate Professor, <sup>2</sup>Professor, <sup>3</sup>Tutor, <sup>4</sup>Assistant Professor, Dept of Anatomy, Smt. B.K. Shah Medical Institute & Research Center Sumandeep Vidyapeeth and Institution Deemed to be University, Piparia, Vadodara Gujarat

## Abstract

**Introduction:** This study intended to assess the awareness among subjects regarding body donation and cadaveric dissection and their willingness to donate body.

**Methodology:** A cross sectional study conducted in Anatomy Department, SBKS Medical Institute and Research Centre, Vadodara. A self-administered questionnaire containing 18 questions was to be filled by the participants in 15 minutes. Responses of participants were collected and analysed.

**Results:** 130 participants were enrolled, 47.69% were males while 52.31% were females. Majority (38.46%) were  $\geq 45$  years in age. Around 41.54% of the participants had received no schooling. Majority of the participants were unaware of the Organ (54.62%) and Body donations (63.85%), however, around 51.54% of the subjects were aware of the cadaveric dissections occurring in medical colleges. Also, 50.77% agreed for body donations. As compared to males, higher proportion of females were aware of the organ (47.1%) and body (38.2%) donations and 61.8% females were willing to donate bodies. Higher proportion of subjects in the age groups of 26-45 years were aware of organ (52.3%) and body (38.6%) donation and cadaveric dissection (65.9%), however, proportionately more subjects in the age group of 18-25 years (77.8%) were willing to donate body. A higher proportion of subjects with college education were aware of the organ (84.6%) and body (92.3%) donation and cadaveric dissection (92.3%) and were also willing to donate body (92.3%).

**Conclusion:** Gender, education and socioeconomic background have an impact on organ/body donation and willingness to donate body.

**Keywords:** Body donation, Cadavers, Female, Male, Participants.

## Introduction

One of the fundamental subjects for medical student is Human Anatomy. With the surge in the number of medical colleges and number of students in medical

colleges the demand of cadavers has risen drastically.<sup>[1]</sup> However, there is mismatch in demand and availability of the same. This makes it necessary to increase the awareness among the masses about body donation and thus to meet the ever increasing requirements of the medical colleges.<sup>[2]</sup> The first step in this direction can be taken by spreading the awareness among the patients attending medical and dental colleges. This study intended to assess the awareness among participants regarding body donation and cadaveric dissection and their willingness to donate body. The findings of this study would help set goals and take necessary steps for increasing awareness among masses.

---

### Corresponding Author:

**Dr. K.M. Parmar**

Associate Professor, Dept of Anatomy, Smt. B.K. Shah Medical Institute & Research Center Sumandeep Vidyapeeth and Institution Deemed to be University, Piparia, Vadodara Gujarat

## Materials and Method

This was a cross sectional study conducted in Department of Anatomy of SBKS Medical Institute and Research Centre, Piparia, Vadodara from December 2019 to February 2020. A self-administered questionnaire was to be filled by the participants. The questionnaire evaluated awareness, attitude, knowledge and willingness towards body/organ donation based on 18 points scale. Subjects were given questionnaire in the vernacular language and were asked to clarify doubts if any, prior to filling the questionnaire. The questionnaire had multiple choice questions and a separate space for providing personal option was also provided for each question. The researcher made the participants fill questionnaire in their presence and did not allow cross discussion among participants while filling it. Duly filled and signed questionnaire were collected from the participants. Each participant was given 15 minutes for filling the questionnaire.

A total of 130 participants, attending medical and dental outpatient department and providing written informed consent for participation in the study and agreeing to fill the questionnaire were enrolled in the study.

### Inclusion Criteria:

- i. Patients attending OPD department of medical and dental hospital
- ii. Patients aged 18 years and above

- iii. Those willing to give written informed consent for participation in the study

### Exclusion Criteria:

- i. Medical and dental students, doctors and faculty members were excluded
- ii. Those that did not give consent for participation in the study

The study was conducted an aim to study gender and age group based difference in awareness and willingness for organ and body donation and to evaluate familiarity with cadaveric dissection. The study also evaluated the impact of literacy on the awareness. The subjects were divided as those having no school education, those with primary, secondary, higher secondary and college education.

Data was entered in MS excel and analysed. Frequencies and percentages were calculated. Significance was assed using Chi square test.

## Results

A total of 130 questionnaire were collected and analysed.

Of the total subjects enrolled, 47.69% were males while 52.31% were females as shown in table 1. The age distribution of the population showed that a higher proportion of males and females were  $\geq 45$  years in age.

**Table 1: Gender and Age distribution of participants**

Gender Distribution	Males		Females		Total		P-value
	N	%	N	%	N	%	
	62	47.69%	68	52.31%	130	100%	0.0212
Age group (years)	N	%	N	%	N	%	
18-25	17	27.42%	19	27.94%	36	27.69%	
26 – 44	21	33.87%	23	33.82%	44	33.85%	
$\geq 45$	24	38.71%	26	38.24%	50	38.46%	0.0412

When the literacy of the study group was evaluated, it was observed that higher proportion of the females (45.59%) had no schooling as compared to males. The

literacy of the population was on lower side as shown in table 2.

**Table 2: Literacy status of participants**

Literacy	Males		Females		Total		P-value
	N	%	N	%	N	%	
No schooling	23	37.10%	31	45.59%	54	41.54%	0.0113
Primary	8	12.90%	15	22.06%	23	17.69%	
Secondary	12	19.35%	9	13.24%	21	16.15%	
Higher secondary	11	17.74%	8	11.76%	19	14.62%	
College educated	8	12.90%	5	7.35%	13	10.00%	

Majority of the participants were unaware of the Organ (54.62%) and Body donations (63.85%), however, around 51.54% of the subjects were aware of the cadaveric dissections occurring in medical colleges. Also, 50.77% agreed for body donations.

**Table 3: Awareness and willingness among participants**

Awareness/Willingness among participants	Aware		Not aware	
	N	%	N	%
Organ donation	59	45.38%	71	54.62%
Body donation	47	36.15%	83	63.85%
Cadaveric Dissection	67	51.54%	63	48.46%
Willingness for donation	66	50.77%	64	49.23%

Gender based evaluation of awareness of donation showed that as compared to males, higher proportion of females were aware the organ (47.1%) and body (38.2%) donations and 61.8% females were willing to donate bodies. (Table 5).

**Table 4: Gender based evaluation of awareness**

	Organ donation				Body donation				Cadaveric Dissection				Willingness for donation			
	Aware		Not aware		Aware		Not aware		Aware		Not aware		Yes		No	
	N	%	N	%	N	%	N	%	N	%	N	%	N	%	N	%
Males	27	43.5%	35	56.5%	21	33.9%	41	66.1%	30	48.4%	32	51.6%	24	38.7%	38	61.3%
Females	32	47.1%	36	52.9%	26	38.2%	42	61.8%	37	54.4%	31	45.6%	42	61.8%	26	38.2%

Age group based evaluation, as shown in table 6, suggested that higher proportion of subjects in the age groups of 26-45 years were aware of organ (52.3%) and body (38.6%) donation and cadaveric dissection (65.9%), however, proportionately more subjects in the age group of 18-25 years (77.8%) were willing to donate body.

**Table 5: Age based evaluation of awareness**

Age groups	Organ donation				Body donation				Cadaveric Dissection				Willingness for donation			
	Aware		Not aware		Aware		Not aware		Aware		Not aware		Yes		No	
	N	%	N	%	N	%	N	%	N	%	N	%	N	%	N	%
18-25	14	38.9%	22	61.1%	12	33.3%	24	66.7%	22	61.1%	14	38.9%	28	77.8%	8	22.2%
26 - 44	23	52.3%	21	47.7%	17	38.6%	27	61.4%	29	65.9%	15	34.1%	24	54.5%	20	45.5%
≥45	22	44.0%	28	56.0%	18	36.0%	32	64.0%	22	44.0%	28	56.0%	14	28.0%	36	72.0%

As shown in table 7, a higher proportion of subjects with college education were aware of the organ (84.6%) and body (92.3%) donation and cadaveric dissection (92.3%) and were also willing to donate body (92.3%).

**Table 6: Literacy based evaluation of awareness**

Literacy	Organ donation				Body donation				Cadaveric Dissection				Willingness for donation			
	Aware		Not aware		Aware		Not aware		Aware		Not aware		Yes		No	
	N	%	N	%	N	%	N	%	N	%	N	%	N	%	N	%
No schooling	11	20.4%	43	79.6%	9	16.7%	45	83.3%	15	27.8%	39	72.2%	15	27.8%	39	72.2%
Primary	9	39.1%	14	60.9%	7	30.4%	16	69.6%	11	47.8%	12	52.2%	11	47.8%	12	52.2%
Secondary	13	61.9%	8	38.1%	6	28.6%	15	71.4%	12	57.1%	9	42.9%	12	57.1%	9	42.9%
Higher secondary	15	78.9%	4	21.1%	13	68.4%	6	31.6%	17	89.5%	2	10.5%	16	84.2%	3	15.8%
College educated	11	84.6%	2	15.4%	12	92.3%	1	7.7%	12	92.3%	1	7.7%	12	92.3%	1	7.7%

## Discussion

Organ and body donation is a noble cause. The need to spread awareness among the masses about organ/body donation led to conduct of this study. The intent was to evaluate the awareness of general public about organ/body donation. In Current study, it was view that forty thirty eight percentages. of the subjects were aware of organ donations while only 36.15% subjects were aware of body donation. However, in the study by Charmode SH, et al. overall awareness about organ donation and body donation was 63.39 %and 70.09 %, respectively. This was higher compared to our study, the reason for the same may be due to the fact the study by Charmode SH, et al. was conducted in medical and dental students whereas our study was conducted in patients attending medical and dental OPD.<sup>[1]</sup> The fact that our hospital receives drainage from rural population may also have impact on the outcome of the study. The reasons for the same are as follows: a higher proportion of subjects lack literacy, this is reflected from the fact that 41.54% of the subjects received no schooling while 17.69% subjects had received primary education. Dope SA et al have highlighted the fact that education background of the subjects influences their understanding of organ/body donations and also influences their willingness to donate body.<sup>[2]</sup>

Charmode SH, et al. also observed that medical students as compared to other student were more acquainted with cadaveric dissection and had better awareness regarding organ donation (91.86%) and body donation (94.18%) as compared to general public/patient (nonacquainted group). Similar findings were also observed by Chung CK et al and P Burra, Burra P, et al.<sup>[4,5]</sup>

In the study by Dope SA et al where in the data was collected from patients visting the hospital, it was observed by the authors that total 68% people were knowledge about body donation and were also aware that cadavers or donated bodies were purpose for the medical student study. <sup>[2]</sup> Bharambe V K et al in their study conducted in patients attending OPD observed that 78% participant were aware of Organ donation concept but 22% were unaware of the same.<sup>[3]</sup>Chung CK et al in a study conducted in medical students observed that among the student of 3, 4 and 5<sup>th</sup> years, 67% of the questions correctly, while only of years 1 and 2 students answered correctly. <sup>[4]</sup>Panshewdikar P et alobserved that 76.84% of the enrolled subjects were aware about the body donation.<sup>[6]</sup> Singh LP and Vyas PC in their study conducted in nursing staff observed that all the staff members were aware of the donation process.<sup>[7]</sup> Tamuli RP et al observed in their study that 79.17% (285) of participants were aware about organ donation: <sup>[8]</sup>

In the present study 50.77% of the subjects were willing to donate body. The willingness was more among females and in those that had higher educated. It was also high in those in the age group of 18-25 years, this may have been due to the fact that young and educated are more aware of the importance of body donations. Those that rejected the idea of body donation gave religion as the reason for the same, majority of the times. In the study by Dope SA et al around 41% person did not believe in body donation and religious beliefs was the commonest reason behind the same. Also, 10% of the total believed donated bodies were being misused. <sup>[2]</sup> Even in the studies by Charmode SH, et al, Bilgel H et al and Tamuli RP et al a higher proportion of females were willing to donate bodies and showed better awareness of the concept of organ and body donations.<sup>[9]</sup>

Balajee KL observed in their study that 88% of the subjects were aware of organ donation and awareness was highest (98.8%) in the 18–30 years age group, male 91% and those educated to higher secondary and above 100%.<sup>[10]</sup>

Thus it can be seen that there are various factors that influence the awareness of the population regarding organ/body donation and their willingness to donate body.

### Conclusions

Females have better awareness of the process of organ/body donation and have proportionately higher willingness to donate body. Education and socioeconomic background have an impact on it.

**Ethical Clearance:** Taken from Sumandeep Vidyapeeth University committee.

**Source of Funding:** Self

**Conflict of Interest:** Nil

### References

1. Charmode SH, et al. A Study of Sexual Dimorphism and Age Related Differences in Awareness and Willingness regarding Organ and Body Donation. *Indian Journal of Anatomy*. 2018 Nov – Dec;7(6): 605-9. DOI: <http://dx.doi.org/10.21088/ija.2320.0022.7618.6>
2. Dope S A, Bhusari PA, Kulkarni PR, Diwan CV. Body donation – The life after death. *IMJ*.2015;2(4):2016- 20.
3. Bharambe V K et al. Awareness regarding body and organ donation amongst the population of an urban city in India. *Nitte University Journal of Health Sci*. Vol. 5(4); December 2015:5157.
4. Chung CK, Ng CW, Li JY, et al. Attitudes, knowledge, and actions with regard to organ donation among Hong Kong medical students. *Hong Kong Med J*. 2008;14(4):278-285.
5. Burra P, et al. Changing Attitude to Organ Donation and Transplantation in University Students during the Years of Medical School in Italy. *Trans. Proceedings*. 2005;37 (2):54750.
6. Panshewdikar PN, et al. Awareness of body donation and embalming among medicos: questionnaire based study. *Int J Anat Res* 2018;6(1.2):4968-72.
7. Singh LP, Vyas PC. Voluntary Body Donation-A Survey of Awareness Among nursing Staff. *IJMSIR*. 2018 July; 3(4): 25 – 26.
8. Tamuli RP, Sarmah S, Saikia B. Organ donation - “attitude and awareness among undergraduates and postgraduates of North-East India”. *J Family Med Prim Care*. 2019;8(1):130-136. doi:10.4103/jfmpc.jfmpc\_206\_18
9. Bilgel H, Sadikoglu G, Bilgel N. Knowledge and Attitudes about Organ Donation among Medical Students. *Transplantationsmedizin*. 2006; 18. Jahrg: S. 91.
10. Balajee KL, Ramachandran N, Subitha L. Awareness and Attitudes toward Organ Donation in Rural Puducherry, India. *Ann Med Health Sci Res*. 2016;6(5):286-290. doi:10.4103/amhsr.amhsr\_63\_15

# Assessment of Scapula Muscle Strength in Housemaids

Riddhi Shroff<sup>1</sup>, Ankita Jain<sup>2</sup>

<sup>1</sup>Assistant Professor, School of Physiotherapy, D.Y. Patil University, Nerul, Navi Mumbai,

<sup>2</sup>Clinical Physiotherapist, Bangalore, D.Y. Patil Hospital, Nerul, Navi Mumbai-40005

## Abstract

**Introduction:** Neck and upper limb musculoskeletal disorders are a major source of disability which is also resulting in economic loss. Housemaids are exposed to repetitive tasks which causes them to be at high risk of neck pain. This result in increased burden on health care costs and also adds to reduced work productivity. The aim of the study is to evaluate scapula muscle strength in housemaids to determine magnitude of the problem.

**Methodology:** A total of 100, divided as 50 participants in housemaid group with neck pain and 50 age matched normal individuals in the asymptomatic group were recruited for the study. Self made questionnaire and scapula muscle strength were tested using push - pull dynamometer.

**Results and Discussion:** The study highlights the weakness of scapula muscle strength with neck pain in housemaids as compared to asymptomatic group. This gives us an insight into significance of scapula muscle strength in neck pain cases which will help us in formulating effective treatment strategies for treating neck pain cases.

**Keywords:** Neck, Pain, Housemaids, Strength, Scapula.

## Introduction

Neck pain is a commonly treated musculoskeletal condition by health care professionals. It has been estimated that the annual prevalence of neck pain in the general population is 30- 50% with the prevalence of activity limitations due to neck pain ranging between 11-14%.<sup>[1,2]</sup>

Neck and upper limb Musculoskeletal Disorders (MSDs) represent a major source of disability globally and have resulted in a major socio-economic affection.<sup>[3,4,5]</sup> The majority of individuals who experience acute neck pain symptoms do not seek medical care, which further progresses to chronic neck pain. It has a prolonged negative impact on health care expenditures.<sup>[6]</sup>

Housekeeping is a physically challenging job which requires repetitive tasks specially with upper limb. There are various push-pull activities that stresses biomechanical structures which leads to exposure of many high-risk factors for neck and upper limb (MSDs).<sup>[7,8,9]</sup> Studies conducted across countries have demonstrated a high magnitude of the neck and upper limb

MSDs among housekeepers.<sup>[7,10,11,12]</sup> Coming to India, where lower socioeconomic strata of women are involved as housemaids for maximum hours in a day, which involves extensive household chores that predisposes them to a constant risk of developing various neck and upper limb related musculoskeletal disorders.

Previous studies have demonstrated impaired cervical flexor muscle performance in subjects with neck pain.<sup>[13]</sup> Exercises directed toward these muscles has been shown beneficial.<sup>[14]</sup> There is emerging evidence that scapulothoracic muscle weakness may also be associated with neck pain.<sup>[15,16]</sup>

---

### Corresponding Author:

Riddhi Shroff

Postal Address: B/19, Modi Nagar, Mathuradas road, Kandivali West, Mumbai-400067

Mobile: 9769491687

e-mail: riddhishroff89@gmail.com

The purpose of this study was to examine

scapulothoracic muscle strength in housemaids on the side of neck pain compared to the unaffected side. A second purpose was to compare muscle strength of housemaids with age matched normal subjects without neck pain.

## Materials and Method

After the institutional ethics committee approval. 50 participants in housemaid neck pain group and 50 age matched normal individual in the asymptomatic group were recruited for the study in the age group of 18 and 60 years of age.

Housemaid Neck Pain group had to have one of the following- Central and/or unilateral neck pain for more than 1 month, Limitation in neck range of motion, referred shoulder girdle or upper extremity pain.

To be included in the asymptomatic group, participants should have no complaint of neck and shoulder pain. Individuals were excluded from either group if they had evidence of central nervous system involvement, pathological reflexes, or demonstrated positive neurologic signs consistent with nerve root compression. Individuals were not eligible to participate if they reported previous spinal surgery.

**Procedure:** Five Scapula-humeral muscle groups were tested with Hydraulic Push-Pull Dynamometer. During testing of External and Internal rotators of Shoulder joint, subjects were seated with proper body alignment in a high sitting position, with towel roll under the axilla, and with both feet placed flat on the foot stool. Middle and lower trapezius were checked by adopting prone position with towel placed under the forehead. Modified Kendall position was used to test serratus anterior in supine position. The “break test” was used for the testing procedures.<sup>[17]</sup>

The maximal force is resisted by the examiner, applied by the subject. The “breaking force” is the amount of force required to overcome a maximal effort muscle contraction in order to move the limb from the initial starting position.<sup>[18]</sup> Three trials were done for all the muscles were tested using this technique.

## Results

**Table 1: Demographic Details**

Variable	Neck Pain group	Asymptomatic group
Age	42±3.41	42±3.41
Duration of working (hours)	14±1.24	10±1.77
Rest periods (hours)	1±0.66	1± 0.85

**Table 2: Intra Group Strength**

Variable	Painful side	Non Painful side	P value
External Rotators	3.97	4.33	0.001
Internal Rotators	4.52	5.39	0.000
Middle Trapezius	6.94	7.43	0.000
Lower Trapezius	6.88	7.38	0.001
Serratus Anterior	8.85	9.26	0.001

**Table 3: Inter Group Strength**

Variable	Neck Pain group	Asymptomatic group	P value
External Rotators	3.97	4.55	0.000
Internal Rotators	4.52	5.45	0.000
Middle Trapezius	6.94	7.50	0.000
Lower Trapezius	6.88	7.78	0.000
Serratus Anterior	8.85	9.51	0.000

## Discussion

The results of this study suggest statistically significant lower scapulothoracic muscle strength values in housemaids with neck pain compared to asymptomatic individuals. The mean scores of the strength values were lower on the painful side in housemaids with neck pain. There is a strong interrelationship between chronic neck and scapula dysfunction. This can be attributed to close association between the scapula and the cervical spine which is connected through the axioscapular muscles.<sup>[19,20]</sup>

One potential reason for impaired scapulothoracic muscle strength in housemaids with neck pain is during strength testing, subjects did not exert maximum effort as pain might be a barrier.<sup>[21]</sup> Secondly, our study shows that housemaids are involved in long working hours with inadequate rest breaks. This results in prolonged repetitive movements which is exhausting. Also, the worker is unable to recover in the short rest periods of time between work duration, thus exposing at increased neck and upper limb MSDs.<sup>[22]</sup>

In our study, the scapula muscle strength of subjects with neck pain were significantly weaker on the affected side of neck pain as compared to asymptomatic group. These changes in scapular kinematics can also be associated to altered serratus anterior muscle recruitment pattern also, muscle performance such as force imbalance in the upper and lower trapezius muscle, and flexibility deficits in the anatomical location surrounding the scapula which may restrict normal scapular movement during daily activity.<sup>[23-26]</sup> Movement pattern correction plays a vital role of muscle-recruiting strategies in rehabilitation.

Recovering the normal activation of the serratus anterior and trapezius muscles is essential for neck and shoulder disorder rehabilitation.<sup>[27]</sup> Proper firing patterns and recruitment of muscles require coupling of the serratus anterior muscle with the upper, middle, and lower trapezius muscles, consequently resulting in “force couples,” which are considered necessary for normal scapular orientation.<sup>[28, 29]</sup> Previous study have shown that the main goal was to inhibit the over activity of muscle and to facilitate the muscle with weak activity for postural control.<sup>[27]</sup>

Thus, the early diagnosis of scapula muscle involvement in neck pain in housemaids will help in planning effective interventions which can help

the housemaids with limitations faced in their work activities.

## Conclusion

The study demonstrates statistically significant weakness of scapula muscle strength with neck pain in housemaids as compared to asymptomatic groups. This gives us an insight into significance of scapula muscle strength in neck pain cases which will help us in formulating effective treatment strategies for treating neck pain cases.

**Ethical Clearance:** It is obtained from institutional ethics committee

**Source of Funding:** It is self funded

**Conflict of Interest:** Nil

## References

1. Hogg-Johnson S, van der Velde G, Carroll LJ, Holm LW, Cassidy JD, Guzman Jet al. The burden and determinants of neck pain in the general population: results of the Bone and Joint Decade 2000–2010. Task Force on Neck Pain and its associated Disorders. *J Manip Physiol Ther* 2009; 32(2 Suppl):46–60.
2. Cote P, van der Velde G, Cassidy JD, Carroll LJ, Hogg-Johnson S, Holm LW et al. The burden and determinants of neck pain in workers: results of the Bone and Joint Decade 2000–2010 Task Force on Neck Pain and Its Associated Disorders. *J Manip Physiol. Ther* 2009; 32(2 Suppl):70–86.
3. Coyte PC, Asche CV, Croxford R, Chan B. The economic cost of musculoskeletal disorders in Canada. *Arthritis Rheum* 1998;11:315–25.
4. Mäkelä M, Heliövaara M, Sievers K, Knekt P, Maatela J, Aromaa A. Musculoskeletal disorders as determinants of disability in Finns aged 30 years or more. *J Clin Epidemiol.* 1993;46:549–59.
5. Picavet H, Schouten J. Musculoskeletal pain in the Netherlands: prevalences, consequences and risk groups, the DMC 3-study. *Pain* 2003;102:167–78.
6. Nordin M, Carragee EJ, Hogg-Johnson S, et al: Assessment of neck pain and its associated disorders: results of the Bone and Joint Decade 2000–2010. Task Force on Neck Pain and Its Associated Disorders. *Spine* 2008;33(4 Suppl):101–122.
7. European Agency for Safety and Health at



- Work: E-fact 39 - Cleaners and musculoskeletal disorders. 2008. <https://osha.europa.eu/en/tools-andpublications/publications/e-facts/efact39>.
8. Bell AF, Steele JR. Risk of musculoskeletal injury among cleaners during vacuuming. *Ergonomics* 2012;55:237–47.
  9. Canadian Centre for Occupational Health and Safety: Hotel Housekeeping. 2016. [https://www.ccohs.ca/oshanswers/occup\\_workplace/hotel\\_housekeeping.html](https://www.ccohs.ca/oshanswers/occup_workplace/hotel_housekeeping.html)
  10. El Tayeb I, Ghareeb N, Zalat M. Prevalence of musculoskeletal problems among full time lady servants in Doqqi area, Cairo. *Egypt J Occup Med* 2013;37:47–59.
  11. Mammen R. Assessment of physical workload, ergonomic problems and prevalence of pain among low wage hotel housekeepers in Orlando; 2017.
  12. Frumin E, Joan M, Pamela V, John H, Peter O, Niklas K et al. Workload-related musculoskeletal disorders among hotel housekeepers: employer records reveal a growing national problem; 2006.
  13. Falla D, Jull G, Hodges P. Patients with neck pain demonstrate reduced electromyographic activity of the deep cervical flexor muscles during performance of the craniocervical flexion test. *Spine* 2004; 29(19): 2108-2114.
  14. Jull GA, Falla DL, Vicenzino B, Hodges PW. The effect of the rpeutic exercise on activation of the deep cervical flexor muscles in people with chronic neck pain. *Man Ther* 2009;14(6): 696–701.
  15. Petersen SM, Wyatt SN. Lower trapezius muscle strength in individuals with unilateral neck pain. *J Orthop Sports Phys Ther* 2011; 41(4): 260-265.
  16. Shahidi B, Johnson C, Curran-Everett D, Maluf K. Reliability and group differences in quantitative cervicothoracic measures among individuals with and without chronic neck pain. *BMC Musculoskelet Disord* 2012; 13: 215
  17. Guihem G, Cornu C, Guevel A. Neuromuscular and muscle-tendon system adaptations to isotonic and isokinetic eccentric exercise. *Ann Phys Rehab Med* 2010; 53:319-341.
  18. Lewis VM, Merritt JL, Piper SM, Sinaki M. Correlations between isotonic and isometric measurements of trunk muscle strength. *Arch Phys Med Rehabil* 1987; 68:639.
  19. Behrsin JF, Maguire K. Levator scapulae action during shoulder movement: A possible mechanism for shoulder pain of cervical origin. *Aust J Physiother* 1986;32:101–6.
  20. Gwendolen J, Michele S, Deborah F, Julia T, Shaun L. Whiplash, headache and neck pain. 1st edn. Churchill Livingstone, 2008.
  21. Shannon M. P, Nathan A.D, Chad E.C. Scapulothoracic muscle strength in individuals with neck pain. *Journal of Back and Musculoskeletal Rehabilitation* 2016;29: 549–555.
  22. Sintayehu D.W, Awrajaw D, Daniel H.C. The impact of work-related risk factors on the development of neck and upper limb pain among low wage hotel housekeepers in Gondar town, Northwest Ethiopia: institution-based cross-sectional study. *Environmental Health and Preventive Medicine* 2019;24:27.
  23. Ludewig PM, Cook TM. Alterations in shoulder kinematics and associated muscle activity in people with symptoms of shoulder impingement. *Phys Ther* 2000;80:276–91.
  24. Cools AM, Witvrouw EE, Declercq GA, et al. Scapular muscle recruitment patterns: trapezius muscle latency with and without impingement symptoms. *Am J Sports Med* 2003;31:542–9.
  25. Borstad JD, Mathiowetz KM, Minday LE, et al. Clinical measurement of posterior shoulder flexibility. *Man Ther* 2007;12:386–9.
  26. Borich MR, Bright JM, Lorello DJ, et al. Scapular angular positioning at end range internal rotation in cases of glenohumeral internal rotation deficit. *J Orthop Sports Phys Ther* 2006;36:926–34.
  27. Boyoung Im, Young Kim, Yijung Chung, Sujin Hwang. Effects of scapular stabilization exercise on neck posture and muscle activation in individuals with neck pain and forward head posture. *J. Phys. Ther. Sci* 2016. 28: 951–955.
  28. Lindstrøm R, Schomacher J, Farina D, et al. Association between neck muscle coactivation, pain, and strength in women with neck pain. *Man Ther* 2011, 16: 80–86.
  29. Wegner S, Jull G, O’Leary S, et al. The effect of a scapular postural correction strategy on trapezius activity in patients with neck pain. *Man Ther* 2010, 15: 562–566

# Effectiveness of Piriformis Stretching and Intermittent Lumbar Traction along with Spinal Extension Exercises in Lumbar Disc Herniation: Comparative Study

Rituraj Verma<sup>1</sup>, Taruna Verma<sup>2</sup>, Vikas Sharma<sup>3</sup>, Yash Pratap<sup>4</sup>, Sanghamitra Jena<sup>5</sup>, Sajjad Alam<sup>6</sup>

<sup>1</sup>Associate Prof., HOD Physiotherapy dept, Galgotias University, <sup>2</sup>Assistant Prof., Galgotias University, <sup>3</sup>Assistant Prof., Galgotias University, <sup>4</sup>Associate Prof., Galgotias University, <sup>5</sup>Assistant Prof., Galgotias University, <sup>6</sup>Associate Prof., Galgotias University

## Abstract

**Objective:** To compare the effect of Piriformis Stretching and Intermittent Lumbar Traction along with Spinal Extension Exercises in Lumbar Disc Herniation.

**Sample:** Total 30 subjects were taken for the study.

**Design:** Pre-test & post-test design.

**Method:** 30 subjects fulfilling selection criteria participated in the study. All of them were told about the procedure of study. All their queries were answered satisfactorily, and informed consent was taken from them. Intermittent lumbar traction, piriformis stretching, and spinal extension exercises were given to the participants. In the beginning of treatment, they were given VAS, Roland- Morris Low Back Pain and Disability Questionnaire and Oswestry Low Back Pain Disability Questionnaire. They were asked to fill these questionnaires. After 1 week protocol of treatment they were again told to fill these outcome measures. The participants were selected for the inclusion and exclusion criteria of the study. The patient consent was taken to be comfortable and relaxed.

**Conclusion:** Study suggests that Piriformis Stretching along with Spinal Extension Exercises plays a significant role in reducing pain and disability as compared to traction along with Spinal Extension Exercises. By using Piriformis Stretching, in a short period of time, patients are able to carry out functions of daily living smoothly.

**Keywords:** Pain, Disability, Lumbar disc herniation (LDH), tumor necrosis factor (TNF).

## Introduction

Herniated disc is a musculoskeletal disorder responsible for sciatica and occurs due to rupture of the annulus fibrosus, following the displacement of the central mass of the intervertebral disc into the dorsal or dorso-

lateral disc spaces<sup>1</sup>. Lumbar disc herniations are believed to result from annular degeneration that leads to a weakening of the annulus fibrosus, leaving the disc susceptible to annular fissuring and tearing<sup>2</sup>. Lumbar disc resolves their symptoms without substantial medical intervention<sup>3</sup>. It mainly affects individual between 30 & 50 years of age<sup>4</sup>. Furthermore, the complete natural history of his disorder is inadequately described, although a variety of anecdotal as well as level 4-5 evidence exists, suggesting that 90% of been estimated to be attack is 37 and in 76% of cases there is prior history of low back pain within the previous ten years<sup>5</sup>. Lumbar disc herniation is a common condition that frequently affects the spine in young and middle age patient<sup>6</sup>.

---

### Corresponding Author:

**Dr. Rituraj Verma**

Associate professor, Galgotias University

Address: 184/14, Vasundhara, Ghaziabad

e-mail: rituraj.verma@galgotiasuniversity.edu.in

Mobile No.: 9953434095

Symptomatic herniation of the nucleus pulposus in the lumbar spine affects 1%-2% of the general population sometime during their lives<sup>7</sup>. Symptomatic herniation of the nucleus pulposus is most prevalent in men during the fourth and fifth decades of life<sup>8</sup>. Although the majority of disc herniations occur at the L2-L3, L4/5 or L5/S1 level<sup>9</sup>. The majority of spinal disc herniation cases occur in the lumbar region (95% in L4- L5 or L5-S1)<sup>10</sup>.

**Methodology:** A total number of 30 subjects were included for the study, who fulfilling inclusion and exclusion criteria volunteered to take part in the study. Subjects were recruited from Divine Physiotherapy Clinic, Vasundhara, consent statement was taken from the subjects to be apart of the study. The Demographic data of the subjects were analyzed by pre-post paired, unpaired t-test, by using SPSS14.

**Inclusion Criteria:** Both males and females of age group 35-45 years, both males and females having Lumbar disc herniation (L4-L5 level), Low back pain involving lower extremities, Sciatica.

**Exclusion Criteria:** Mentally challenged, Pregnancy, Children and old age people, Congenital pathology of lumbar spine, Surgery of lumbar spine, Infectious disease, Cervical and thoracic herniated disc

**Outcome Measures:** 1) Visual Analogue Scale, 0-10 grades 2) The Roland - Morris Low Back Pain and Disability, having 24 Questionnaire 3) Oswestry Low Back Pain Disability having 10 statement Questionnaire, includes, pain intensity, personal care (washing, dressing etc.), lifting, walking, sitting, standing, sleeping, sex life, social life and travelling.

## Methodology

30 subjects fulfilling selection criteria participated in the study. All of them were told about the procedure of study. All their queries were answered satisfactorily, and informed consent was taken from them. Intermittent lumbar traction, piriformis stretching, and spinal extension exercises were given to the participants. In the beginning of treatment, they were given VAS, Roland-Morris Low Back Pain and Disability Questionnaire and Oswestry Low Back Pain Disability Questionnaire. They were asked to fill these questionnaires. After 1-week protocol of treatment they were again told to fill these outcome measures. Data was collected in the data collection form. All the patients were asked to perform spinal extension exercises (dog-bird, Cat-cow, Half cobra) 10 second hold and 10 repetitions once a day for one week. Intermittent lumbar traction was given to 15 subjects for 15 minutes once a day for one week, Piriformis stretching were given to another 15 subjects with 30 second hold and 4 repetitions once a day for oneweek.

**Data Analysis:** To analyze the effect of Piriformis Stretching and Intermittent Lumbar Traction on total 30 (15 PS and 15 ILT) subjects, post scores & post-post scores of pain were analyzed by using Mean, Standard Deviation and t-test. Paired t- test was used to find out any significant differences between pre-post test and unpaired t-test was used between post-post test of pain to assess which intervention significantly reduce the pain for assigned duration and frequency.

### Comparison of Visual Analogue Scale (Piriformis Stretching) between Pre and Post Test:

Variable	Group	Treatment	N	Mean	S. D.	Standard Error Mean	D.F	t-value
Visual Analogue Scale	Pre-Test	Piriformis Stretching	15	7.26	.59	.15	14	15.19*
	Post-Test		15	2.86	1.06	.27		

\*Significant at 0.01 level df = 14, At 0.01 t-value of the Table is 2.97

### Comparison of Visual Analogue Scale (Intermittent Lumbar Traction) between Pre and Post Test:

Variable	Group	Treatment	N	Mean	S.D.	Standard Error Mean	DF	t-value
Visual Analogue Scale	Pre-Test	Intermittent	15	7.26	.88	.22	14	12.58*
	Post-Test	Lumbar Traction	15	4.46	.91	.23		

\*Significant at 0.01 level df=14, At 0.01 t-value of the Table is 2.97

**Comparison of Visual Analogue Scale between Post Test (Piriformis Stretching) and Post Test (Intermittent Lumbar Traction):**

Variable	Group	Treatment	N	Mean	S. D.	Standard Error Mean	D.F.	t-value
Visual Analogue Scale	Post-Test	Piriformis Stretching	15	2.86	1.06	.27	28	4.42*
	Post-Test	Intermittent Lumbar Traction	15	4.46	.91	.23		

\*Significant at 0.01 level df=28, At 0.01 t-value of the Table is 2.76

**Comparison of Oswestry between Post Test Piriformis Stretching) and Post Test (Intermittent Lumbartraction):**

Variable	Group	Treatment	N	Mean	S. D.	Standard Error Mean	D.F.	t-value
Oswestry	Post-Test	Piriformis Stretching	15	29.68	8.39	2.16	28	1.57**
	Post-Test	Intermittent Lumbar Traction	15	35.65	12.07	3.11		

\*\* Not Significant at 0.01 level df=28, At 0.01 t-value of the Table is 2.76

**Comparison of Roland Morris Back Pain and Disability (Intermittent Lumbar Traction) Pre and Posttest:**

Variable	Group	Treatment	N	Mean	S. D.	Standard Error Mean	DF	t-value
Roland Morris Back Pain and Disability	Pre-Test	Intermittent Lumbar Traction	15	19.46	2.89	.74	14	16.65*
	Post-Test		15	9.60	1.29	.33		

\*Significant at 0.01 level df=14, At 0.01 t-value of the Table is 2.97

**Comparison of Roland Morris Back Pain and Disability between Post Test (Piriformis Stretching) and Post Test (Intermittent Lumbar Traction):**

Variable	Group	Treatment	N	Mean	S. D.	Standard Error Mean	D.F.	t-value
Roland Morris Back Pain and Disability	Post-Test	Piriformis Stretching	15	5.00	2.00	.51	28	7.47*
	Post-Test	Intermittent Lumbar Traction	15	9.60	1.29	.33		

\*Significant at 0.01 level df=28, At 0.01 t-value of the Table is 2.76

**Result**

The results of this study support that Piriformis stretching will be more effective and significant in reducing pain and disability (due to LDH) than Intermittent Lumbar Traction.

**Future Scope and Research:** Present study was limited to 35-45 age group. Further research examining the effects of both PS and ILT on individuals in younger and older age groups would be of interest. Future research must include a follow-up of at least 15 days/16 days to check the short term/long term effects of PS and ILT.

**Conclusion**

Study suggests that Piriformis Stretching along with Spinal Extension Exercises plays a significant role in reducing pain and disability as compared to traction along with Spinal Extension Exercises.

**Ethical Clearance:** Prior Patient consent form was taken.

**Source of Funding:** Self

**Conflict of Interest:** Nil

## References

1. Barros Filho, TEP, Basile Junior R, Coluna. Vertebral: diagnóstico e tratamento das principais patologias. Sao Paulo: Savier,1995.
2. Saal JA. Natural history and non-operative treatment of lumbar disc herniation. *Spine*. 1996; 21(24suppl): 2S-9S.
3. Schoenfeld AJ, Weiner BK et al. Treatment of lumbar disc herniation. *International Journal of General Medicine*.2010;3:209-214.
4. Garrido E. Lumbar disc herniation in the pediatric patient. *Neurosurg clin N Am*.1993;4(1):149-52.
5. BellGR, Rothman RH. The conservative treatment of sciatica. *Spine (Phila Pa 1976)*1984;9(1):54-6.
6. Anderson PA, McCormickPC et al. Randomized controlled trials of the treatment of lumbar disc herniation. *J Am Acad Orthop Surg*. 2008;16:566-573.
7. Deyo RA, Tsui-wu YJ. Descriptive epidemiology of low back pain and its related medical care in the United States. *Spine(Phila Pa 1976)*.1987;12:264-8.
8. Boden SD, Davis DO, Dina TS, Patronas NJ, Wiesel SW. Abnormal magnetic resonances cans of the lumbar spine in asymptomatic subjects. A prospective investigation. *J Bone Joint Surg Am*. 1990;72:403-8.
9. Frymoyer JW. Back pain & sciatica. *N Eng/J Med*. 1988;318:291-300. 10) Krishna V. Lumbar disc herniation. *Orthopaedic Muscul Sys* 1.2012;1:101.
10. Atlas SJ, Chang Y, Kammann E, Keller RB, Deyo RA, Singer DE. Long-term disability and return to work among patients who have a herniated lumbar disc: the effect of disability compensation. *J Bone Joint Surg Am*. 2000;82(1):4-15.
11. Matsui H, Kanamori M, Ishihara H, Yudoh K, Naruse Y, Tsuji H. Familial predisposition for lumbar degenerative disc disease. A case-control study. *Spine (Phila Pa 1976)*. 1998;23(9):1029-34.
12. Choi G, Raiturker PP, Kim MJ, Chung DJ, Chae YS, Lee SH. The effect of early isolated lumbar extension exercise program for patients with herniated disc undergoing lumbar discectomy. *Neurosurgery*.
13. Nachemson AL. Instability of the lumbar spine. Pathology, treatment, and clinical evaluation. *Neurosurg Clin N Am* 1991;2:785-90.
14. Hahne AJ, Ford JJ. Functional restoration for a chronic lumbar disk extrusion with associated radiculopathy. *Phys Ther* 2006;86:1668-80.
15. Weber H. The natural history of disc herniation and the influence of intervention. *Spine (Phila Pa 1976)* 1994;19:2234-8.
16. Svensson GL, Wendt GK, Thomee R. Evaluation of a structured physiotherapy treatment model for patients with lumbar disc herniation. *J Rehabil Med* 2014;46:234-46.
17. Kalb S, Martirosyan NL, Kalani MYS, Broc GG, Theodore N. Genetics of the degenerated intervertebral disc. *World Neurosurg*. 2012;77(3-4):491-501.

# Cassava Leaves Extract (*Manihot esculenta*) Prevents the Decrease of Albumin Serum Level in Mice with Gentamicin-Induced Hepatotoxicity

Rosita Dewi<sup>1</sup>, Rena Normasari<sup>2</sup>

<sup>1</sup>Lecturer, Histology Department, Faculty of Medicine, University of Jember, <sup>2</sup>Lecturer, Pathology Anatomy Department, Faculty of Medicine, University of Jember, Jalan Kalimantan No. 37 Kampus Tegalboto, Jember, 6812, East Java, Indonesia

## Abstract

Gentamicin is effectively used for the treatment of gram-negative bacterial infection but it has a hepatotoxic effect. Lipid peroxidation and suppression of endogenous antioxidants by gentamicin increases the production of reactive oxygen species which leading to necrosis of hepatocyte. Cassava leaves (*Manihot esculenta*) contain phenolic compounds, flavonoids, vitamin C, carotene, and iron which act as antioxidant and enzymatic antioxidant cofactor which can inhibit lipid peroxidation. This research aimed to determine the influence of cassava leaves extract to serum albumin level in mice with gentamicin-induced hepatotoxicity. Mice were divided into groups N, K (gentamicin 80 mg/kg b.w.); P1, P2, P3 (gentamicin 80 mg/kg b.w. and cassava leaves extract 150 mg/kg b.w., 300 mg/kg b.w., 450 mg/kg of b.w. for 14 days). Serum albumin level in group K was decreased compared to group N; group P1, P2, P3 were respectively gradually increased. One Way Anova analysis showed significant difference among groups ( $p < 0.05$ ). Post Hoc Tukey test showed that serum albumin level in group P3 was significantly different from group K ( $p < 0.05$ ). It can be concluded that cassava leaves extract prevent the decrease of serum albumin level in mice with gentamicin-induced hepatotoxicity.

**Keywords:** *Cassava leaves, hepatotoxicity, gentamicin, albumin.*

## Introduction

Liver is the largest organ in the body that plays an important role in the metabolism and detoxification of various types of chemicals<sup>1-4</sup>. Related to this function, liver cells are very susceptible to damage. The level of liver cell damage depends on the type, dose, and duration of exposure to chemicals<sup>5</sup>. Chemicals such as drugs can induce liver damage<sup>6</sup>. The pathogenesis of liver damage involves inhibition of the mitochondrial respiration chain which will increase the number of reactive oxygen

species (ROS) and decrease the amount of adenosine triphosphate (ATP). Generation of ROS and ATP depletion triggers intracellular damage, inflammation, and death of liver cells through the necrosis pathway<sup>6-8</sup>. Laboratory tests to support the diagnosis of liver damage include liver enzymes, namely increased alanine transaminase (ALT) and aspartate transaminase (AST), increased bilirubin, and decreased albumin; examinations of liver imaging include ultrasound, CT-scan, MRI; and liver biopsy<sup>6,9</sup>. Albumin level can be used as a predictor of prognosis for liver damage<sup>10</sup>.

A six-year study in Denmark reported that six patients underwent liver transplants and nine patients died of liver damage with the etiology of antibiotic use<sup>10</sup>. A 16-year Cohort study in Italy stated that 23.4% of liver damage was caused by antibiotics<sup>9</sup>. In the United States (US), 50% of 1600-2000 cases of acute liver failure per year are caused by drugs and 30% of patients who

---

### Corresponding Author:

**Rosita Dewi**

Histology Department, Faculty of Medicine, University of Jember

e-mail: rosita.fk@unej.ac.id

undergo liver transplantation die<sup>6</sup>. Another study in the US stated the incidence of acute drug-induced liver failure 0.59 per 1,000,000 population with antibiotics as the second highest etiology<sup>10</sup>.

Gentamicin which is used in the treatment of severe infections by gram-negative bacteria in the US is the cause of hepatotoxicity<sup>11</sup>. The nephrotoxic and ototoxic effects of gentamicin have been extensively studied, while the hepatotoxic effects have not been extensively studied. Structural damage and similar declines in liver function were reported due to gentamicin 80 mg/kg b.w. for 7 days<sup>12</sup>. Lipid peroxidation by gentamicin will cause cell membrane damage which will result in cell necrosis. The effect of gentamicin suppression on endogenous enzymatic and nonenzymatic antioxidants will increase the production of reactive oxygen species (ROS) which not only damage lipid membranes but also proteins and nucleic acids.<sup>2,3,11</sup>.

Plants are widely used as a source of natural antioxidants that are safe and effective<sup>2,3</sup>. One example of food plants widely processed and consumed in Indonesia and contain high antioxidants is cassava (*Manihot esculenta*). The part that is used as a source of antioxidants is the leaves. Cassava leaves contain phenolic phytochemical components, flavonoids, vitamin C, carotene, and iron as enzymatic antioxidant cofactors<sup>13-16</sup>. In addition, chlorophyll in cassava leaves also acts as an antioxidant which is a major barrier to oxidation reactions<sup>17</sup>. The content of vitamin C in cassava leaves almost reaches four times the content of vitamin C in cassava tubers, while the carotene content is only found in cassava leaves<sup>16,18</sup>.

Antioxidant compounds in cassava leaves can provide electrons to free radicals which can inhibit chain reactions and stabilize free radical components<sup>13,14,16</sup>. Therefore, administration of cassava leaves extract is expected to prevent liver damage caused by oxidative stress by gentamicin. If the liver damage can be prevented, the function of the liver in synthesizing albumin will not be disrupted. The effect of cassava leaves extract on serum albumin level in cases of hepatotoxicity has not been studied. Therefore, the authors will examine whether cassava leaves extract can prevent the decrease of serum albumin level in mice with gentamicin-induced hepatotoxicity.

## Materials and Method

Cassava leaves used in this study were from Jember,

Indonesia. Cassava leaves were washed and dried in the sun. Simplisia dried leaves were mashed using a blender and then sieved until a fine powder is obtained which was then macerated using 70% ethanol solvent. Maceration results were processed into extracts using a rotary evaporator.

This study used a post test only control group design. As research subjects, 25 male mice (*Mus musculus*) aged 2-3 months and body weight  $\pm 20$  grams were divided into five random groups consisting of normal (N), control (K) with 80 mg gentamicin/kg b.w., treatment group 1 (P1) with gentamicin 80 mg/kg b.w. and cassava leaves extract 150 mg/kg b.w., treatment group 2 (P2) with gentamicin 80 mg/kg b.w. and cassava leaves extract 300 mg/kg b.w., and treatment group 3 (P3) with gentamicin 80 mg/kg b.w. and cassava leaves extract 450 mg/kg b.w. Gentamicin was peritoneally injected and cassava leaves were orally (p.o.) administered to the mice every day for 14 days.

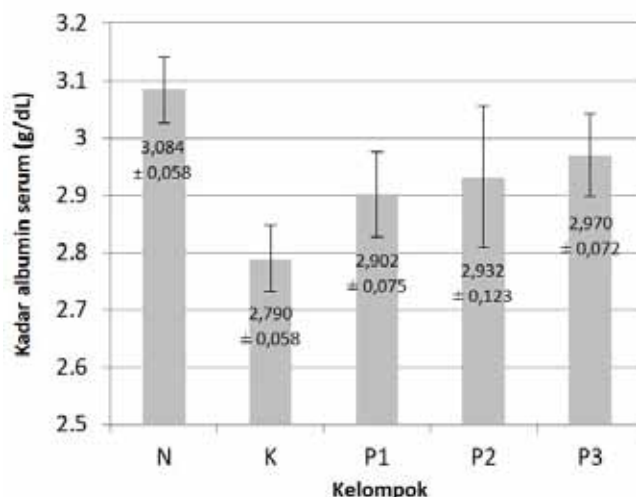
The serum albumin level of mice was measured using the photometric method with a wavelength of 546 nm (DiaSys Diagnostic Systems). Data on serum albumin level of mice were analyzed using One Way Anova statistical test with a confidence level of 95%. Differences between groups were analyzed using the Post Hoc Tukey HSD test and the strength of the correlation between the dose of cassava leaves extract and serum albumin level of mice was analyzed using the Pearson correlation test.

## Results

The serum albumin level of mice in the K group decreased compared to group N and the serum albumin levels of mice in the P1, P2, and P3 groups increased respectively (Figure 1). Analysis using the One Way Anova statistical test showed a significance value of 0,000 which meant that there were significant differences among groups. In the Post Hoc Tukey HSD statistical test, it can be seen differences between groups. Serum albumin level of mice between group N and group K showed sig. 0,000 which meant that administration of gentamicin 80 mg/kg b.w. for 14 days significantly decreases serum albumin level in mice. Serum albumin level of mice between groups K and P1 and groups K and P2 did not show significant differences (sig. 0.222 and 0.076). Cassava leaves extract 150 mg/kg b.w. and 300 mg/kg b.w. for 14 days prevent the decrease of serum albumin level in mice but not significant. Significant

differences were found between groups K and P3 (sig. 0.016) which meant that the administration of cassava leaves extract 450 mg/kg b.w. for 14 days could prevent significant the decrease of serum albumin level in mice.

However, serum albumin level of mice between groups P2 and N and groups P3 and N did not show significant differences (sig. 0.051 and 0.208). Pearson correlation test resulted an R value of 0.627.



**Figure 1. Mice serum albumin levels**

N: normal group, K: control group (gentamicin 80 mg/kg b.w. i.p. for 14 days), P1: treatment group 1 (gentamicin 80 mg/kg b.w. i.p. and cassava leaves extract 150 mg/kg b.w. p.o. for 14 days), P2: treatment group 2 (gentamicin 80 mg/kg b.w. i.p. and cassava leaves extract 300 mg/kg b.w. p.o. 14 days), P3: treatment group 3 (gentamicin 80 mg/kg b.w. i.p. and cassava leaves extract 450 mg/kg b.w. p.o. for 14 days).

## Discussion

Administration of gentamicin at dose of 80 mg/kg b.w. i.p. for 14 days reduced serum albumin level in mice ( $p < 0.05$ ). In another study, administration of gentamicin 100 mg/kg b.w. every other days for 21 days also significantly reduced rat albumin level<sup>3</sup>. Albumin is a protein found in the highest amount in plasma. Albumin plays an important role in maintaining plasma osmotic pressure and acts as an endogenous and exogenous transporter<sup>19</sup>. Albumin is synthesized by the liver and excreted rapidly into the circulatory system so that if there is a liver injury, its level in the blood will decrease<sup>4,19</sup>. Increased intracellular enzymes of ALT and AST liver and albumin depletion reflect liver or hepatocyte damage<sup>3</sup>.

In this study, decreased albumin level was caused by

gentamicin-induced hepatotoxicity. In previous studies, the average score of hepatocyte damage in the gentamicin-induced mice group showed significant differences with the normal mice group ( $p < 0.05$ ). The results of liver microscopic observations due to gentamicin induction are parenchymal degeneration, hydropic degeneration, and necrosis<sup>20</sup>. The characteristics of hepatocytes undergoing parenchymous degeneration are swollen cells, cloudy cytoplasm and granular; characteristics of hepatocytes undergoing hydropic degeneration are visible vacuoles in the cytoplasm and pale cytoplasm; the characteristics of hepatocytes undergoing necrosis are shrinking cell nuclei (picnosis), cell nuclei breaking into fragments (karyokinesis), lysis cell nuclei (karyolysis), and lysis cell membranes<sup>5,8,21</sup>. Hepatocyte necrosis is classified as zonal necrosis which is generally found in zone 3 and can also be found in zone 1<sup>22,23</sup>. In another study, administration of gentamicin 80 mg/kg b.w. for seven days showed hepatocyte necrosis, widening of sinusoids, vacuole formation in hepatocytes, and leukocyte infiltration<sup>12</sup>.

Gentamicin use slightly above the therapeutic dose has the potential to cause hepatotoxicity. About 5-10% of patients treated with gentamicin have liver damage<sup>12</sup>. Many studies have examined the effect of gentamicin on



changes in levels of intracellular antioxidant enzymes such as superoxide dismutase (SOD), glutathione (GSH), and catalase and changes in level of lipid peroxidation products such as malondialdehyde (MDA). Administration of gentamicin 100 mg/kg b.w. i.p. every other days for 21 days significantly reduced SOD and GSH levels and increased MDA level in rat liver<sup>3</sup>; gentamicin 100 mg/kg b.w. i.p. for seven days decreased GSH level and significantly increased MDA level in rat liver<sup>11</sup>; gentamicin 100 mg/kg b.w. i.p. for three days significantly reduced levels of GSH, SOD, and liver catalase in mice<sup>1</sup>; gentamicin 40 mg/kg b.w. i.p. for seven days can significantly reduce GSH and increase MDA in rat liver<sup>2</sup>.

Cassava leaves are used as a source of natural antioxidants that can provide protection against cells from the influence of free radicals. The leaves contain carotene which is the most active provitamin A and high in vitamin C (7052 µg carotene and 130 mg of vitamin C every 100 grams)<sup>15,18,25</sup>. Carotene and vitamin C are classified as exogenous non-enzymatic secondary antioxidants that can capture free radicals and prevent chain reactions in lipid peroxidation<sup>15,16,26,27</sup>. Antioxidant compounds provide electrons to free radical molecules resulting them as stable molecules<sup>13,14</sup>.

A study analyzing the phytochemical components of methanol extract and water extracts of boiled cassava leaves and simplicia showed the presence of flavonoids and phenolic compounds in cassava leaves. These compounds are also classified as secondary antioxidants. Flavonoids are polyphenol compounds with phenolic hydroxyl groups that make them have antioxidant activity by inhibiting the activity of superoxide anions, lipid peroxide radicals, and hydroxyl radicals<sup>16,26,27</sup>. As the leaves grow older, the flavonoid levels increase<sup>17</sup>. Cassava leaves extract used in this study was not processed by boiling. Processing cassava leaves by boiling reduces levels of phenolic compounds and flavonoids by 30%. Phenolic and flavonoid compounds are unstable so that they are easily damaged by heating during the boiling process<sup>13</sup>. In addition, the carotene can also be damaged by heating<sup>25</sup>. Plants with green leaves contain iron which can act as a co-factor of intracellular antioxidant enzymes, namely catalase which functions as a catalyst for the chemical reaction of hydrogen peroxide into water<sup>14,26,28</sup>. Chlorophyll in cassava leaves is also a major barrier to oxidation reactions. Chlorophyll level will increase with increasing time until the leaves develop fully and then decrease in old leaves<sup>17</sup>.

The serum albumin level of mice in the group administered gentamicin and cassava leaves extract 450 mg/kg b.w. were significantly different compared to the group of mice that were administered gentamicin without cassava leaves extract. However, serum albumin level of mice in the group that was administered cassava leaves extract 300 mg/kg b.w. was not different from the normal group. This indicated that cassava leaves extract 300 mg/kg b.w. could prevent the decrease of serum albumin level so that it was equal to normal serum albumin level. R value of 0.627 (0.6- <0.8) in the Pearson correlation test showed a strong correlation between the dose of cassava leaves extract and serum albumin level in mice. A positive R value means that the dose of cassava leaves extract and serum albumin level of mice are directly proportional. The higher the dose of cassava leaves extract, the higher the serum albumin level of mice<sup>29</sup>.

## Conclusion

From the results of this study, it can be concluded that cassava leaves extract prevents the decrease of serum albumin level in mice with gentamicin-induced hepatotoxicity.

**Ethical Clearance:** Ethical Committee for Research, Faculty of Medicine, University of Jember, Jember, East Java, Indonesia.

**Source of Funding:** Self-funding

**Conflict of Interest:** Nil

## References

1. Chandel SS, Sahu RK. Protective Effect of Dietary Inclusion of Aegle marmelos fruit on gentamicin-induced hepatotoxicity in rats. *Int J Green Pharm* 2017; 11: 597–603.
2. Almohawes ZN. Protective Effect of Melatonin on Gentamicin Induced Hepatotoxicity in Rats. *J Pharmacol Toxicol* 2017; 12: 129–135.
3. Galaly SR, Ahmed OM, Mahmoud AM. Thymoquinone and Curcumin Prevent Gentamicin-Induced Liver Injury by Attenuating Oxidative Stress, Inflammation and Apoptosis. *J Physiol Pharmacol* 2014; 65: 823–832.
4. Guyton, Hall. *Guyton and Hall Textbook of Medical Physiology*. 12th ed. Singapore: Elsevier Inc., 2011.

5. Prasetiawan E, Sabri E, Ilyas S. Gambaran Histologis Hepar Mencit (*Mus musculus* L.) Strain DDW setelah Pemberian Ekstrak N-Heksan Buah Andaliman (*Zanthoxylum acanthopodium* DC.) selama Masa Pra Implantasi dan Pasca Implantasi. *Saintia Biol* 2015; 1: 1–6.
6. Fisher K, Vuppalanchi R, Saxena R. Drug-Induced Liver Injury. *Arch Pathol Lab Med* 2015; 139: 876–887.
7. David S, Hamilton JP. Drug-Induced Liver Injury. *Natl Institutes Heal Public Access* 2010; 6: 73–80.
8. Istikhomah, Lisdiana. Efek Hepatoprotektor Ekstrak Buah Pepada (*Sonneratia caseolaris*) pada Tikus Putih (*Rattus norvegicus*). *Unnes J Life Sci* 2015; 1: 1–8.
9. Licata A, Minissale MG, Calvaruso V, et al. A Focus on Epidemiology of Drug-Induced Liver Injury: Analysis of a Prospective Cohort. 2017; 21: 112–121.
10. Björnsson ES. Global Epidemiology of Drug-Induced Liver Injury (DILI). *Curr Hepatol Reports* 2019; July 16: 1–6.
11. Khaksari M, Esmaili S, Abedloo R, et al. Palmatine Ameliorates Nephrotoxicity and Hepatotoxicity Induced by Gentamicin in Rats. *Arch Physiol Biochem* 2019; June 26: 1–6.
12. Noorani AA, Gupta KA, Bhadada K, et al. Protective Effect of Methanolic Leaf Extract of *Caesalpinia bonduc* (L.) on Gentamicin-Induced Hepatotoxicity and Nephrotoxicity in Rats. *Iran J Pharmacol Ther* 2011; 10: 21–25.
13. Hasim, Falah S., Dewi L.K. Effect of Boiled Cassava Leaves (*Manihot esculenta* Crantz) on Total Phenolic, Flavonoid and its Antioxidant Activity. *Curr Biochem* 2016; 3: 116–127.
14. Normasari R, Dewi R, Rachmania S. Efek Ekstrak Daun Singkong terhadap Perbaikan Struktur dan Fungsi Ginjal Mencit yang Diinduksi Gentamisin. *J Agromedicine Med Sci* 2017; 3: 1–6.
15. Obeten KE, Odey SA, Udo-Affah G, et al. Effect of Aqueous Extract of Cassava (*Manihot esculenta*) Leaf on The Morphology and Micro-Anatomy of The Liver of Wister Rats. *Int J Anat Res* 2017; 5: 4031–4035.
16. Rachman F, Hartati S, Sudarmonowati E, et al. Aktivitas Antioksidan Daun dan Umbi dari Enam Jenis Singkong (*Manihot utilissima* Pohl). *Biopropal Ind* 2016; 7: 47–52.
17. Solikhah R., Purwantoyo E, Rudyatmi E. Aktivitas Antioksidan dan Kadar Klorofi Kultivar Singkong di Daerah Wonosobo. *Life Sci* 2019; 8: 86–95.
18. Depkes. Daftar Komposisi Bahan Makanan. Jakarta: Bharata Karya Aksara, 1995.
19. Moman RN, Varacallo M. Albumin Physiology. NCBI Bookshelf; January, <https://www.ncbi.nlm.nih.gov/books/NBK459198/>(2018).
20. Dewi R, Normasari R. Protective Effect of Cassava Leaf Extract on Gentamicin-Induced Hepatotoxicity In Mice. *J Agromedicine Med Sci* 2019; 5: 168–173.
21. Sari WN, Saebani, Dhanardhono T. Pengaruh Pemberian Butylated Hydroxytoluene (2,6-Di-Tert-Butyl-4-Methylphenol) Per Oral Dosis Bertingkat terhadap Gambaran Histopatologis Ginjal. *J Kedokt Diponegoro* 2018; 7: 1344–1357.
22. Krishna M. Patterns of Necrosis in Liver Disease. *Clin Liver Dis* 2017; 10: 53–56.
23. Kleiner DE. Recent Advances in the Histopathology of Drug-Induced Liver Injury. *Surg Pathol Clin* 2018; 11: 297–311.
24. Winarsi H. Antioksidan Alami dan Radikal Bebas: Potensi dan Aplikasinya dalam Kesehatan. Yogyakarta: Kanisius, 2007.
25. Meiliana, Roekistiningsih, Sutjiati E. Indonesian Journal of Human Nutrition. *Indones J Hum Nutr* 2014; 1: 23–34.
26. McDowell LR, Wilkinson N, Madison R, et al. Vitamins and Minerals Functioning as Antioxidants with Supplementation Considerations. *Proceeding Florida Rumin Nutr Symp*, [dairy.ifas.ufl.edu/rns/2007/McDowell.pdf](http://dairy.ifas.ufl.edu/rns/2007/McDowell.pdf) (2007).
27. Samber LN, Semangun H, Prasetyo B. Karakteristik Antosianin sebagai Pewarna Alami. *Pros Semin Nas X Pendidik Biol FKIP UNS* 2013; 10: 1–4.
28. Liu RM, Pravia KAG. Oxidative Stress and Glutathione in TGF- $\beta$ -Mediated Fibrogenesis. *Free Radic Biol Med* 2010; 48: 1–15.
29. Dahlan MS. Statistik untuk Kedokteran dan Kesehatan. 6th ed. Jakarta: Epidemiologi Indonesia, 2014.

# Common Warts Treatment by Intralesional (60,000 Versus 120,000) IU of Vitamin D3, Comparative Study

Ruya Thamer Ihsan Mahmoud<sup>1</sup>, Mazin Hamid Ayyash<sup>2</sup>

<sup>1</sup>Scholar Researcher, M.B.Ch.B., Kirkuk University 2010-2011,

<sup>2</sup>Assistant Professor, FICMS, Higher Diploma in Laser, College of Medicine, Tikrit University

## Abstract

**Background:** Wart is common disease cause by infection with HPV, there are many modalities for treatment most of them resolve wart with many side effects as scars and recurrence.

**Objective:** To identify the significant difference between two doses of intralesional vitamin D3 (60,000 vs 120,000) iu injection in treatment of warts.

**Patients and Method:** A total of 47 patients were included in the study divided into two groups. Group A received intralesional 60,000 iu of vt.D3, and group B received intralesional 120,000 iu vt. D3 into each lesion with maximum of five warts treated in one session. Four sessions was done every 2 weeks in both groups. Follow-up was done for 4 months after last session of treatment for any recurrence.

**Results:** In group A: complete response in 77.7%, partial response in 6.67%, minimal response in 6.67%, and no response in 6.67% of patients. About 60% of patients with multiple warts showed complete clearance of distant untreated warts. In group B: complete response in 66.7%, partial response in 6.67%, minimal response in 20%, and no response in 6.67% of patients. There was no significant difference between both groups. No recurrence was observed in both groups in the follow-up period.

**Conclusions:** Immunotherapy by both intralesional MMR vaccine and vitamin D3 is simple, well-tolerated, and effective.

**Keywords:** HPV, treatment, vitamin D3, warts.

## Introduction

**Wart:** are benign cutaneous tumor and less commonly occur mucous membrane and caused by Human papilloma viruses (HPVs).

Common warts are hyperkeratotic, exophytic, dome-shaped papules or plaques that are commonly associated with HPV-1, -2, -4, -27, or -57. spontaneous resolution may occur within 2 years in 65%–78% of warts, for most patients. <sup>[1]</sup>

It replicates simultaneously with differentiation of keratinocytes, leading to the maturation of viral particles in the granular cell layer. The viral particles are released at same time with exfoliation of the verruca, causing spread to other regions.<sup>[3]</sup>

There is no viremic phase during the life cycle,

therefore a systemic immune response is avoided. In addition, small amount of viral proteins is expressed in the basal and spinous cell layers of the epidermis, where they would be most likely to be recognized by Langerhans cells and infiltrating lymphocytes. <sup>[2]</sup>

Clinical types of warts; Verruca vulgaris, Palmoplantar warts, Verruca plana, Filiform warts, Periungual wart, Mucosal wart. Diagnosis: warts are usually diagnosed clinically; Characteristic warty appearance with a rough, dry stippled surface, paring the surface of the wart will reveal capillary loops close to the surface and often causes bleeding. <sup>[4]</sup>

**Treatment Involved:** First line; Salicylic acid, Glutaraldehyde, Formalin, Occlusion, Topical 5-fluorouracil, Caustics, Retinoic acid, Vitamin D analogues

Second line; Cryotherapy, Laser, Hyperthermia, Surgery, Photodynamic therapy

Third line; Podophyllin and podophyllotoxin, Imiquimod, Topical immunotherapy, Intralesional immunotherapy, Interferon, H2 receptor antagonists, Zinc, Oral retinoids, Intralesional bleomycin, Cidofovir, Psychological method.

**Vitamin D;** It is a group of fat-soluble secosteroids responsible for enhancing intestinal absorption of calcium, magnesium, and phosphate, and has multiple other biological effects. [1] In humans, the important compounds in this group are vitamin D3 (also known as cholecalciferol) and vitamin D2 (ergocalciferol). [7]

#### The Mechanism of Action of Vitamin D3 Analogues

Cells in the skin have receptors for Vitamin D3 analogues are keratinocytes, Langerhans' cells, melanocytes, fibroblasts and endothelial cell [6], so

1. It works through Vitamin D receptor (VDR) to regulate cell growth, differentiation and immune function. It inhibits the proliferation of keratinocytes and modulates epidermal differentiation
2. Vitamin D prevent production of several pro-inflammatory cytokines by T-cell clones, including IL-2 and IFN- $\gamma$ .
3. It inhibits interleukin-6 (from B cell) and interleukin-8 (that produced from macrophage).
4. It inhibits transcription of granulocyte-macrophage colony-stimulating factor and messenger ribonucleic acid.
5. It block activity of cytotoxic T cells and Natural Killer cells.[8]

### Patient and Method

The study was conducted in the departments of dermatology of Salahuddin-General Hospital in Tikrit city and Azadi Teaching Hospital in Kirkuk city, Iraq. From Nov. 2019 to 30 June 2020. It was an opened, a comparative and a therapeutic trial study to estimate the efficacy of the vit. D3 in different two doses to treat wart. A total of 47 patients were enrolled in the study. 27 of them treated with 60,000 IU of vit. D3 as group (A) and other 20 patient treated with 120,000 IU of vit.

D3 as group (B). The study targeted male and female from 9 to 60 years old. Exclusion criteria involved Immunosuppressed patient. Pregnant women's. Lactating women's. Patient on other treatments modalities of wart in previous 2 weeks of injection. Prior history of hypersensitivity to vit. D3 .

### Clinical Response:

- Clinical response determined by reduce in the number and size of warts.
- Complete response achieve when all of wart included (treated warts and distant warts) resolved completely 100%.
- Moderate response achieve when >50% to <100% reduce in both size and number of lesion.
- Mild response achieve when 1% to <50% of reduction occur. [5]

### Materials

- 27 gauge insulin syringe.
- vit. D3 ampule 300,000 IU/ml.

#### Method of Administration of Vitamin D3 Injection:

We give slow gentl intralesional injection of vitamin D3 without local anaesthesia after proper encouragement and reassurance to the patients.

- Patients in group 1 A (no. = 27) were treated with 60,000 IU vit. D3 (0.2ml of 1ml of vit. D3 300,000 IU) whereas group 2 B (no. = 20) were treated with 120,000 IU vit. D3 (0.4ml of 1ml of vit. D3 300,000iu), vit. D3 injected to the base of wart with 27 gauge insulin syringe (Figure 18).
- The injections were repeated 2weeks apart; for 4 sessions.
- The large number of wart treated in single session were 5 warts.
- Follow up of recurrence will obtained after 4 months of last injection.

### Results

Demographics and clinical informations of the patients in each groups were mentioned in table 1 with no statistically significant difference between both groups.

Data	Group A (no.=27)	Group B (no.=20)	P. value t. Test
Dose of vt.D3	60,000iu	120,000iu	
<b>Sex</b>			
Male	9 (33.3%)	9 (45%)	
Female	18 (66.6%)	11 (55%)	
Ratio: F:M	Ratio 2:1	Ratio: 1.2:1	
<b>Age (years)</b>			
<25	19 (70%)	16 (80%)	
>25	8 (29.6%)	(20%)	
Min-Max	3 - 48	8 - 50	
Mean± SD	19.3 ± 12.6	20 ± 10.5	
Median	18	19	
<b>Previous Treatment</b>			
No	15 (55.5%)	11 (55%)	
Yes	12 (44.4%)	9 (45%)	
<b>No. of wart</b>			
Single	9 (33%)	11 (55%)	
Multiple	18 (66.6%)	9 (45%)	
Maximum diameter of treated wart	40 mm	35 mm	
Mean of diameter before treatment	10.7 mm	16.9 mm	
Mean of diameter after treatment	1.18 mm	4.9 mm	
<b>Duration in months</b>			
Min-Max	2 - 36	3 - 24	
Mean± SD	11.2 ± 10.5	12.65 ± 8.5	
Median	6	12	
Rate of complete response	21 (77.7%)	11 (55%)	P. Value = 0.20 t. Test= 1.475743
<b>Type of wart</b>			
Verruca vulgaris	21 (77.7%)	17 (85%)	P. Value = 0.214
Periungual	6 (22.2%)	1 (5%)	
Filiform	0 (0%)	2 (10%)	
<b>Side effect of vt.D3 injection</b>			
Yes	15 (55.5%)	17 (85%)	
No	12 (44.5%)	3 (15%)	
Relapse	1 (4.7%)	0 (0%)	

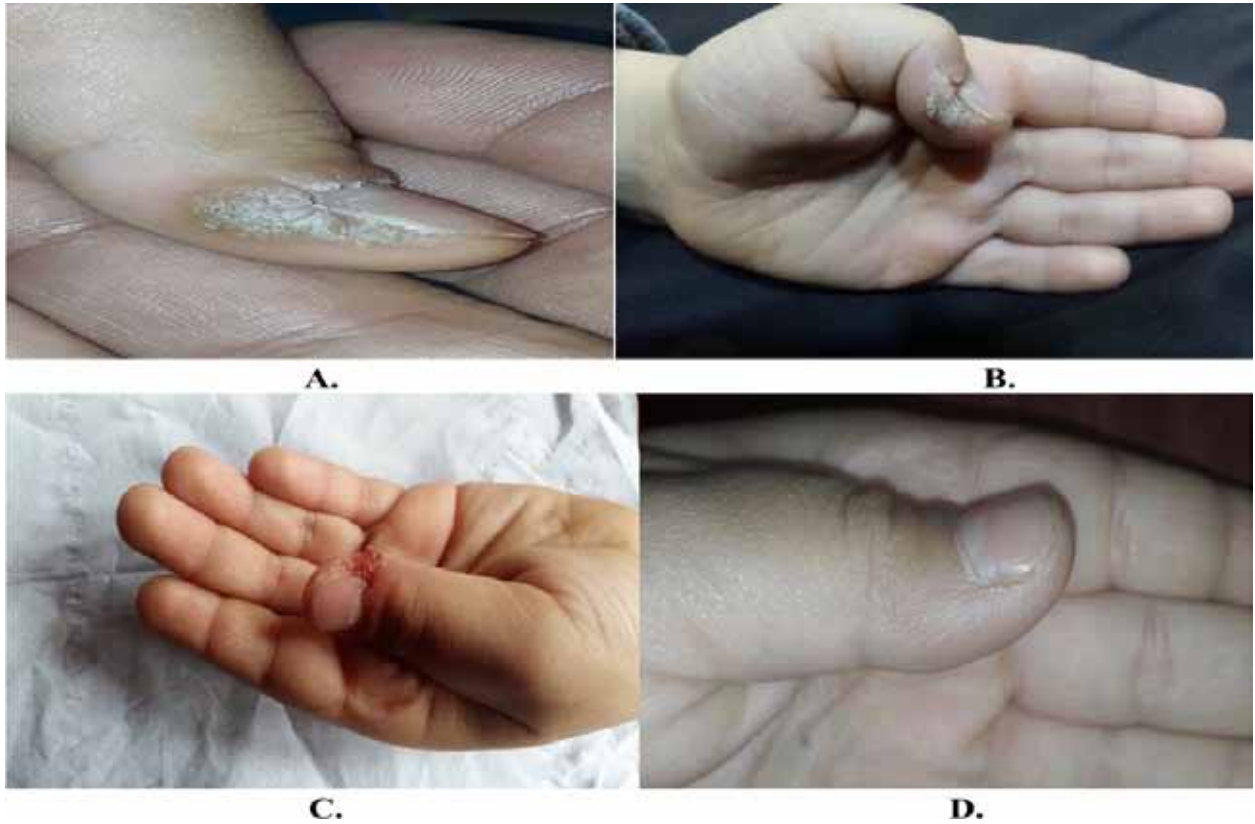
Regarding to the response of wart to treatment (table 1) show that group **A** has 77.7% complete response, 14.8% moderate response and 7.4% mild response (2 patients of 27 while in group **B** has 55% complete response, 35% moderate response and 10% mild response with no significant difference between groups ( $p$  value =0.3130).

Relationship between clinical response and numbers of sessions shown in table 2, group **A** there's 6 patients (28.5%) of patients have complete response after 2

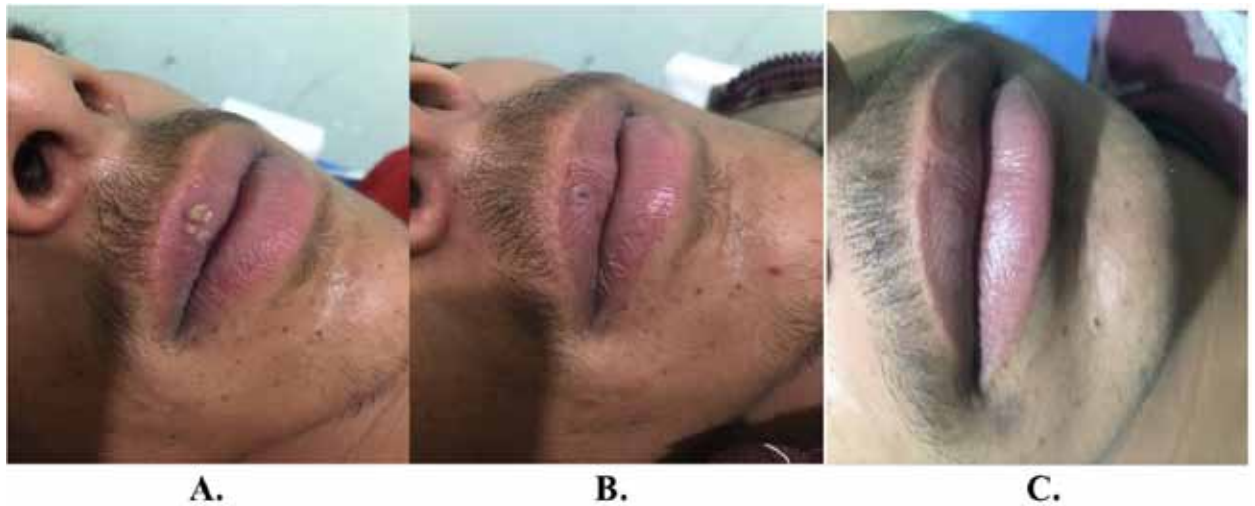
sessions figure 1,9 patients (42.8%) show complete response after 3 sessions and 6 patients (28.5%) show complete response after 4 sessions while others show partial response after 4 sessions. In group **B** there's 5 patients (45.5%) show complete response after 2 sessions figure 2, 4 patients (36.5%) show complete response after 3 sessions and 2 patients (18.2%) show complete response after 4 sessions while other patients have partial response after 4 sessions. No significant difference between groups ( $p$  value =0.879).

**Table 2: Relationship between complete response and number of sessions.**

No. of sessions	Group A No.=21	Group B No.=11	p. value
2	6 (28.5%)	5 (45.5%)	0.879
3	(42.8%)	4 (36.6%)	
4	6 (28.5%)	2 (18.2)	



**Figure 1: Periungual wart for 11 years old boy since 1 year durations (A) before treatment, (B) after 2 weeks of treatment, (C) after 2 sessions, and (D) complete response after 3 sessions of treatments with vt.D3 60.000 IU.**



**Figure 2: Filiform wart on upper lips of 19 years old man for 5 months duration (A) before treatment, (B) after 2 weeks of 1<sup>st</sup> session, and (C) after the second session of treatment with vt. D3 120,000 IU.**

Regarding reduction of the diameter of the wart (table 3), in group A the total diameter before treatment was 289mm reduced to 32mm there's significant difference ( $p = 0.004428$ ), while in group B the total

diameter of wart before treatment was 337mm reduced to 97mm after treatment also there's significant difference ( $p=0.0000317$ ). (Figure 33) show mean of diameters in both groups before and after injection.

**Table 3: Comparison of clinical response regarding diameter of wart in both groups.**

Status of wart Diameters	Group A	Group B
Before	289 mm	337 mm
Mean $\pm$ SD	11 $\pm$ 9.3	17 $\pm$ 10.8
After	32 mm	97 mm
Mean $\pm$ SD	1 $\pm$ 2.7	5 $\pm$ 7
P value	0.004428	0.0000317

Regarding to sides effect table 4 show in group A 15 patients (55.5%) developed sides effect including erythema, pain, swelling and itching at site of injection with one patient developed pustule at site of injection.

In group B 17 patients (85%) developed the same sides effect at site of injection with one patient developed vasovagal attack after injection immediately and resolved within minutes, other patient developed ulcer at site of injection. ( $p= 0.545$ ).

**Table 4: Side effects incidence in both groups.**

Side effects	Group A (No.=27)	Group B (No.=20)	P value
Negative	12 (44.4%)	3 (15%)	0.545
Positive	15 (55.5%)	17 (85%)	
Erythema	2 (13.3%)	2 (11.7%)	
Pain	1 (6.6%)	1 (5.8%)	
Itching	0 (0%)	2 (11.7%)	
Swelling	2 (13.3%)	0 (0%)	
All of them	10 (66.6%)	12 (70.5%)	

Regarding clearance of distal warts in group A there's one patient with distal wart who has no improvement while in group B there's 5 patients 3 (60%) of them getting improved of distal wart spontaneously with treatment of target wart.

There was no significant relation between clinical response and either age, sex, site of wart, type of wart and duration of disease in each groups.

## Discussion

In our study there's 32 from 47 patients with complete clearance 68% and 11 patients with moderate response 23.5% and 4 patients with mild response 8.5%.

## Our results match with many studies as:

Shalmoud et al (2020) reported 66.7% of patient's complete response, 6.67% had partial response, 20% had minimal response, and 6.67% had no response. <sup>[9]</sup>

Raghukumar et al (2017) reported complete response in 90%, partial response in 6.66%, and no response in 3.33%. <sup>[10]</sup>

Aktaş et al (2016) recorded complete clearance in 70%, 15% had a partial response, and 15% showed no response. <sup>[11]</sup>

Kavya *et al* (2017)<sup>19</sup> study revealed complete clearance in 78.57%, 14.28% had a partial response, and 7.14% showed minimal response. <sup>[5]</sup>

Regarding to high complete response rate in study of Raghukumar *et al* may related to high dose (600,000 IU) uses.

Also our results match with Chia-Han Yeh M *et al* (2019) who has fourteen studies with 480 patients in which 59.9% patients (95%CI: 45.5%-72.9%) receiving intralesional vitamin D3 injection achieved complete resolution. <sup>[12]</sup>

Kareem *et al* (2019) who involved 30 patients as cases group who received intralesional injection of 0.2 mL of vitamin D3 (300,000 IU) into the base of mother wart for two sessions, 1 month apart, photographs were taken before injection then after 1 month and 3 months of injection. Complete clearance of the target injected warts occurred in 40% of patients, partial response occurred in 23.3% in patients in cases group; and there was no change in 36.7% of patients. <sup>[13]</sup>

Relatively there is low rate of complete response in this study which may be due to less numbers of injection with long duration between each session.

El Sayed *et al* (2020) there's 3 groups of patients group 1 treated with intralesional 2% zinc sulfate, group 2 intralesional 2% vt. D3 and group 3 intralesional normal saline for 4 sessions each 2 weeks the complete response rate with vt. D3 in this study was 62.9% and this rate is relatively similar to our study. <sup>[14]</sup>

In our study there's no significant difference between group **A** and **B** in clinical response to different doses of vitamin D3 which was in group **A** 21 patients from 27 patients with complete response 77.7% and in group **B** 11 patients from 20 patients with complete clearance 55% ( $p$  value = 0.20)( $t$  test = 1.475743), but there's a significant difference in the reduction of the diameter of the wart which was in group **B** 337mm before treatment and be 93mm with  $p$  value 0.0000317 compare to group **A** which was 289mm before treatment and be 32 mm after treatment with  $p$  value 0.004428.

This result refers to ability of 120,000 IU of vitamin **D3** to be superior on 60,000 IU of vitamin **D3** in treatment of wart but the results of nonsignificant difference in other measures between two groups may be due to the larger diameter of the warts in group **B** which may require for more sessions to achieve the better response.

Regarding to the complete response and numbers of sessions it was in group **A** 6 patients (28.5%) after 2 sessions, 9 patients (42.8%) show complete response after 3 sessions and 6 patients (28.5%) show complete response after 4 sessions while others show partial response after 4 sessions with no significant difference ( $p$  value = 1) mean  $\pm$  SD was  $3 \pm 7.9$ . In group **B** there's 5 patients (45.5%) show complete response after 2 sessions, 4 patients (36.5%) show complete response after 3 sessions and 2 patients (18.2%) show complete response after 4 sessions mean  $\pm$  SD was  $2.7 \pm 2$ , while other patients have partial response after 4 sessions with no significant difference ( $p$  value = 0.121). No significant difference between groups ( $p$  value = 0.879).

Regarding clearance of distal warts in group **A** there's one patient with distal wart who has no improvement while in group **B** there's 5 patients 3 (60%) of them getting improved of distal wart spontaneously with treatment of target wart.

Regarding to sides effect in group **A** 15 patients (55.5%) developed sides effect including erythema, pain, swelling and itching at site of injection with one patient developed pustule at site of injection.

In group **B** 17 patients (85%) developed the same sides effect at site of injection with one patient developed vasovagal attack after injection immediately and resolved within minutes, other patient developed ulcer at site of injection and there is no significant difference between two groups ( $p$  = 0.545).

Regarding to the recurrence of wart after 4 months of last injection for each wart in completely cured patients was one patient in group **A** (4.7%) while no recurrence in group **B**.

There were no significant relation between clinical response and either age, sex, site of wart, type of wart or duration of disease in each groups as in Shalmoud *et al*.<sup>[9]</sup>

**Conflict of Interest:** None

**Funding:** Self

**Ethical Clearance:** Not required

## Reference

1. Salman S, Ahmed M, Ibrahim A. Intralesional immunotherapy for the treatment of warts: A



- network meta-analysis. *J AM ACAD DERMATOL.* 2018;80(4).
2. Howley PM, Lowy DR. Papillomaviruses. In: Knipe DM, Howley PM, editors. *Fields virology.* 5th ed. Philadelphia: Lippincott Williams & Wilkins; 2001. p. 2299–354.
  3. Khanna N. *Illustrated Synopsis of Dermatology and Sexually Transmitted Diseases.* 5th ed. Delhi/India: Elsevier; 2016.
  4. KANG S, AMAGAI M, MARGOLIS D. *Fitzpatrick's Dermatology.* 9th ed. New York: McGraw-Hill Education; 2019.
  5. Kavya M, Shashikumar B. Safety and efficacy of intralesional vitamin D3 in cutaneous warts: An open uncontrolled trial. *Cutaneous and Aesthetic surgery.* 2017;10(2):90-94.
  6. Al Ghamdi, K. M., & Khurram, H. (2011). Successful treatment of peri-ungual warts with diluted bleomycin using translesional multipuncture technique: A pilot prospective study. *Dermatologic Surgery,* 37(4), 486–492.
  7. Shahriari M, Kerr PE, Slade K, et al. Vitamin D and the skin. *Clin Dermatol.* 2010;28(6):663-668.
  8. Gautam D, Agarwal D, Nikalji D. *DYP SURVIVAL GUIDE FOR POST GRADUATE DERMATOLOGY EXAMINATION PART-II.* 2nd ed. India: Torrent Pharmaceuticals; 2013.
  9. Shaldoum DR, Hassan GFR, El Maadawy EH, El-Maghraby GM. Comparative clinical study of the efficacy of intralesional MMR vaccine vs intralesional vitamin D injection in treatment of warts. *J Cosmet Dermatol.* 2020;00:1–8.
  10. Raghukumar S, Ravikumar BC, Vinay KN, et al. Intralesional Vitamin D3 Injection in the Treatment of Recalcitrant Warts: A Novel Proposition. *J Cut Med Surg.* 2017;21(4):320-324.
  11. Aktaş H, Ergin C, Demir B, et al. Intralesional vitamin D injection may be an effective treatment option for warts. *J Cutan Med Surg.* 2016;20(2):118-122.
  12. Chia-Han Yeh M, Tsai T-Y, Huang Y-C, Intralesional vitamin D3 injection in the treatment of warts: A systematic review and meta-analysis, *Journal of the American Academy of Dermatology* (2019)
  13. Kareem IMA, Ibrahim IM, Mohammed SFF, Ahmed AA-B. Effectiveness of intralesional vitamin D3 injection in the treatment of common warts: Single-blinded placebo-controlled study. *Dermatologic Therapy.* 2019;32:e12882.
  14. El Sayed MH, Sayed FS, Afify AA. Intralesional zinc sulfate 2% vs intralesional vitamin D in plantar warts: A clinicodermoscopic study. *Dermatol Ther.* 2020;33(3):e13308. doi:10.1111/dth.13308

# Using of Glycated Albumin Rather than Glycated Hemoglobin for assessing Glycaemic Control in Hemodialysis Patients with Type II Diabetes Mellitus

Salahaldin M. Fahad<sup>1</sup>, Rashied M. Rashied<sup>2</sup>, Waleed N. Jaffal<sup>3</sup>

<sup>1</sup>PH.D. Student, Department of Biology, College of Sciences, University of Anbar, Iraq, <sup>2</sup>Assistant Professor (Animal Physiology), Department of Biotechnology, College of Sciences, University of Anbar, Iraq, <sup>3</sup>Assistant Professor (Consultant Urologist), Department of Surgery, College of Medicine, University of Anbar, Iraq

## Abstract

Diabetes mellitus (DM) is a global epidemic that is correlated with long-term damage and causes dysfunction of many organs like the kidney leading to diabetic nephropathy (DN) which need for hemodialysis (HD) to protect progressive renal decline. This study was designed to evaluate the significance of glycated albumin (GA), compared with fasting blood sugar (FBS) and glycated hemoglobin (HbA1c), were evaluated as an indicator of glycemic control, also determinant of insulin. This study was conducted on 95 patients at age range (30-70) years, and patients include (35) HD patients with diabetes, (35) HD patients without diabetes and (25) Type 2 diabetes mellitus, who attended at Ramadi General Hospital and (25) samples as control included in this study. This study showed that HbA1c% was significantly lower than simultaneous FBS and GA% in HD patients in comparison with in diabetic patients and control, as illustrated in significantly shallow slope of regression line between FBS with HbA1c and FBS with GA. Also, GA% was nearly corresponding between before and after one hemodialysis in HD patients compared with HbA1c. In conclusion, GA provides a better measure to estimate glycemic control in HD patients with diabetes compared with HbA1c.

**Keywords:** Chronic kidney disease, Diabetes mellitus, Glycated Albumin, HbA1C, Hemodialysis.

## Introduction

Diabetes mellitus (DM) is a metabolic disorder of carbohydrate leading persistent high level of blood glucose due to insufficient amount of insulin. Chronic hyperglycemia is associated with damage and causes dysfunction of several organs such as kidney<sup>(1;2)</sup>. Chronic kidney disease (CKD) is progressive loss of kidney function over a period of months or years<sup>(2)</sup>. The single most common of CKD is diabetic nephropathy (DN), which occurs as a result of microangiopathy caused by diabetes and is one of the most important disorders leading to renal failure. Strict glycemic control

is beneficial in preventing complications of diabetic nephropathy<sup>(3)</sup>. Hemodialysis (HD) is successful in prolonging the life of end-stage renal disease (ESRD) patients. Selecting reliable clinical biomarkers to monitor glycemic control is critical in HD patients with diabetes. Glycated hemoglobin (HbA1c) and glycated albumin (GA) are biomarkers used for estimating glycemic control<sup>(4)</sup>. At present, HbA1c is widely used as a gold standard index for glycemic control in clinical practice. However, the HbA1c levels may be erroneous in patients with CKD because of numerous factors as anemia and the management of erythropoietin (EPO). GA has been developed as an index for glycemic control and it measures specifically the glycation product of albumin. To date, GA has been suggested as a more reliable and sensitive glycemic index to replace HbA1c in diabetic patients with CKD<sup>(5)</sup>, because it is not influenced by anemia and associated treatments<sup>(4)</sup>. The main aim of this study was assess whether GA might provide a

---

### Corresponding Author:

**Salahaldin M. Fahad**

PH.D. Student, Department of Biology, College of Sciences, University of Anbar, Iraq  
e-mail: salahalden615@gmail.com

better indicator than HbA1c for glycemetic control in HD patients with diabetes.

## Materials and Method

The Specimens collection were started from April, 2019 till end of June 2019. HD patient with diabetes (35) and HD patient without diabetes (35) samples were collected from the Industrial Renal department and T2DM patients (25) from the Diabetes Center for Treatment at Ramadi General Hospital. For the purpose of comparison, (25) samples as control. Before the collection of samples, a careful history was taken from each patient according to a questionnaire. From each patient and control, (5 ml) of blood were obtained by venipuncture. The blood samples were divided into two aliquots; 2ml was dispensed in EDTA tube and used for HbA1c which determination by fast ion-exchange resin separation method for the detection of HbA1c in human blood according to<sup>(6)</sup>, which provided from human company/Germany. While 3ml was dispensed in plain tube to collect serum, the serum were used in estimation FBS and GA. FBS determination according to <sup>(7)</sup>method, which provided with kit from linear company/Spain. **Determination of Gaby ELISA:** According to Cat.No:YHB1374method as cited by

manufacturing company kit, which provided from Shanghai company/China. This kit uses enzyme-linked immune sorbent assay based on biotin double antibody sandwich technology to assay Human GA. To measure the percent of GA, the conversion formula supplied with kit was applied to all subjects; the formula is  $GA\% = ([GA \text{ concentration}/\text{Total albumin}]/1.14 \times 100) + 2.9$ .

**Statistical:** The statistical analyses were carried out using SPSS version 25. One way ANOVA test was used to find means and standard deviation (SD) for all variables of the study. The difference significances in proportions analyzed by LSD test. The correlations between variables were confirmed by Pearson correlation analysis. P-value >0.05 were considered to be significant.

## Results and Discussion

**Variation of FBS Levels during Study Period of 60 day:** The results in table (1) corresponds with Inaba *et al.*,<sup>(8)</sup> who recorded that FBS in HD patients with diabetes for three measures was stable. These results no corresponds with Lin *et al.*,<sup>(9)</sup> who found that the mean FBS levels after the first year of hemodialysis were stable.

**Table (1): The mean levels of FBS between the four study groups.**

Groups	N	Mean±SD FBS1 (60 day) Before of GA & HbA1C meas.	Mean±SD FBS 2 (30 day) Before of GA & HbA1C meas.	Mean±SD FBS 3 (0 day) at GA & HbA1C meas.	T- test P value
Control	25	89±19	88.4±18.6	88.2±16.3	0.165 <sup>NS</sup>
Diabetes	25	218.5±44.6	216.8±46.3	211.8±48.4	0.547 <sup>NS</sup>
HD patients with diabetes	35	189.8±58.8	188.5±61.5	187.6±60.8	0.371 <sup>NS</sup>
HD patients without diabetes	35	94.8±11.6	92±12.4	90.7±9.6	0.252 <sup>NS</sup>
<b>Total</b>	<b>120</b>	<b>148.3±70.7</b>	<b>146.2±68.5</b>	<b>144.5±68.7</b>	<b>0.124<sup>NS</sup></b>

\*NS: Mean non-significant differences at  $P \leq 0.05$ .

These results suggested that glycemetic control of control group and patients groups were stable during the study period (60 days) before determined of GA and HbA1c and a single determination immediately before HD can be indicative of glycemetic control in HD diabetes patients. The stable glycemetic control during the preceding 2 mo may negate the different impact of acute glycemetic control changes between HbA1c and GA in this study. In the first month of hemodialysis, the

average FBS levels reflect the initial degree of glycemetic control achieved at this stage of hemodialysis therapy. The 3- months FBS levels reflect the long-term glycemetic control of hemodialysis therapy and the general condition of the hemodialysis patient at this stage<sup>(9)</sup>.

**Determination of Average Fasting Blood Sugar (FBS) Level:** Table (2) showed average of FBS was a significant increase in diabetic group (215±11.1)

mg/dl, followed by HD patients with diabetes group (188.7±18.39)mg/dl compared with other groups, while the average of FBS was decreased in control group

and HD patients without diabetes were (88.5±4.88 and 92.2±2.7) mg/dl respectively compared with other groups.

**Table (2): The mean of average FBS between four study groups.**

Groups	N	Mean±SD of Average FBSNV(70-100) mg/dl
Control	25	88.5 ± 4.88 <sup>a</sup>
Diabetes	25	215 ± 11.1 <sup>b</sup>
HD patients with diabetes	35	188.7 ± 18.39 <sup>c</sup>
HD patients without diabetes	35	92.2 ± 2.7 <sup>a</sup>
<b>Total</b>	<b>120</b>	<b>146.1 ± 26.36</b>

\*Different Letters (a, b, c): Means significant difference at P ≤0.05.

The results in table (2) agreement with Khalaf, <sup>(10)</sup>; Abid Hammed, <sup>(11)</sup>who recorded that the significantly higher in diabetic patients and HD patients with diabetic compared to control, but our results disagreed in another part of study by Abid Hammed, <sup>(11)</sup> when demonstrated non-significant difference between diabetic patients and HD patients with diabetes. The level of blood glucose normally represents balance between the inflow of glucose into blood and its uptake by the tissue. This result demonstrated an increase in gluconeogenesis in diabetic patients which is the predominant mechanism responsible for increased hepatic glucose output in patients with T2DM and it is correlated with fasting plasma glucose level. The fasting hyperglycemia has

been result from an increased rate of glucose production which including increased rate of hepatic glycogenolysis and gluconeogenesis. While in HD patients, FBS affects by dialysis fluid, and changes in glucose levels in the dialysis fluid during and after hemodialysis <sup>(10;11)</sup>.

#### **Determination of Glycohemoglobin (HbA1c):**

Table (3) showed mean HbA1C was a significantly increased in diabetic patients (10.41±1.16) % compared with other groups, also a significant increase in HD patients with diabetes (8.194±1.22)%. While the mean of HbA1C was decreased in HD patients without diabetes and control were (5±1.23 and 5.31±0.76)% respectively.

**Table (3): The mean of HbA1c percent between four study groups.**

Groups	N	Mean±SD of HbA1C NV(4.5-6.2)%
Control	25	5.31±0.76 <sup>a</sup>
Diabetes	25	10.41±1.16 <sup>b</sup>
HD patients with diabetes	35	8.194±1.22 <sup>c</sup>
HD patients without diabetes	35	5 ± 1.23 <sup>d</sup>
<b>Total</b>	<b>120</b>	<b>7.13±1.86</b>

\*Different letters (a, b, c): Means significant difference at P ≤0.05.

The results in table (3) agreed with Hadi and Sultan, <sup>(12)</sup> who recorded that the HbA1C increased in diabetic patients compared with control. Also agreed with Abid Hammed, <sup>(11)</sup>who showed that HbA1C was significantly higher among T2DM (10.6±1.6) % and

HD patients with diabetes (8.5±1.8) %, compared with control (4.8 ± 0.7)%. The rise in the HbA1c levels was associated with the increasing level of FBS in diabetic groups, indicating that testing of HbA1c appears as a measure of chronic hyperglycemia in diabetic patients.

The HbA1c has been used as an objective marker of average glycemic control because the levels of HbA1c in the blood reflect the glucose levels which erythrocyte has been exposed during its lifetime of the RBC<sup>(13)</sup>. Thus, the elevation of HbA1C levels in our study indicates reduced control of blood glucose levels<sup>(10)</sup>.

**Determination of GA:** Table (4) showed that the mean GA% was a significantly increased in diabetic patients and HD patients with diabetes were (30.5±4.15 and 29.2±4.5)% respectively, while the mean of GA% was decreased in control (16.1±1.8)% followed by HD patients without diabetes (17±1.12) %.

**Table (4): The mean of GA percent between four study groups.**

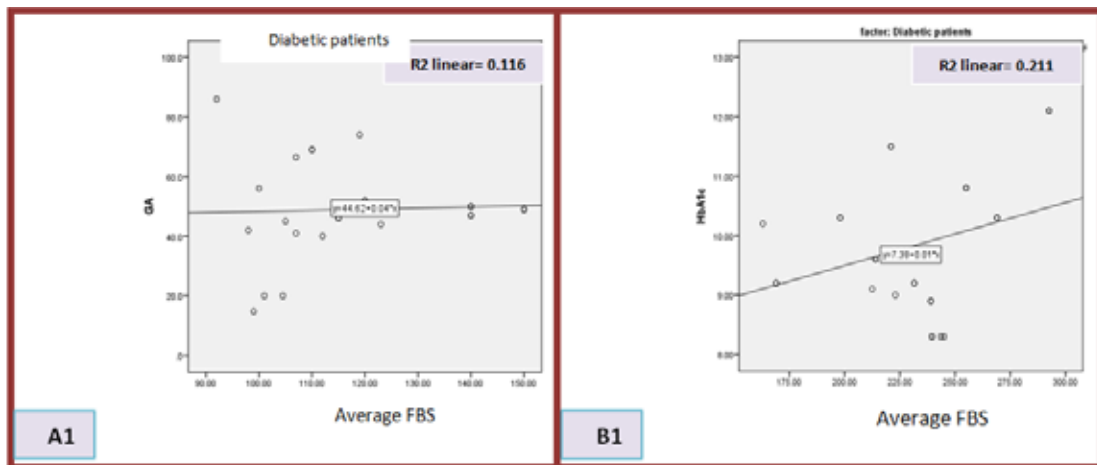
Groups	N	Mean±SD of GA%, NV(>18)%
Control	25	16.1±1.8 <sup>a</sup>
Diabetes	25	30.5±4.15 <sup>b</sup>
HD patients with diabetes	35	29.2±4.5 <sup>b</sup>
HD patients without diabetes	35	17 ±1.12 <sup>a</sup>
<b>Total</b>	<b>120</b>	<b>23.78±13.05</b>

\*Different Letters (a, b, c): Means significant difference at P ≤0.05.

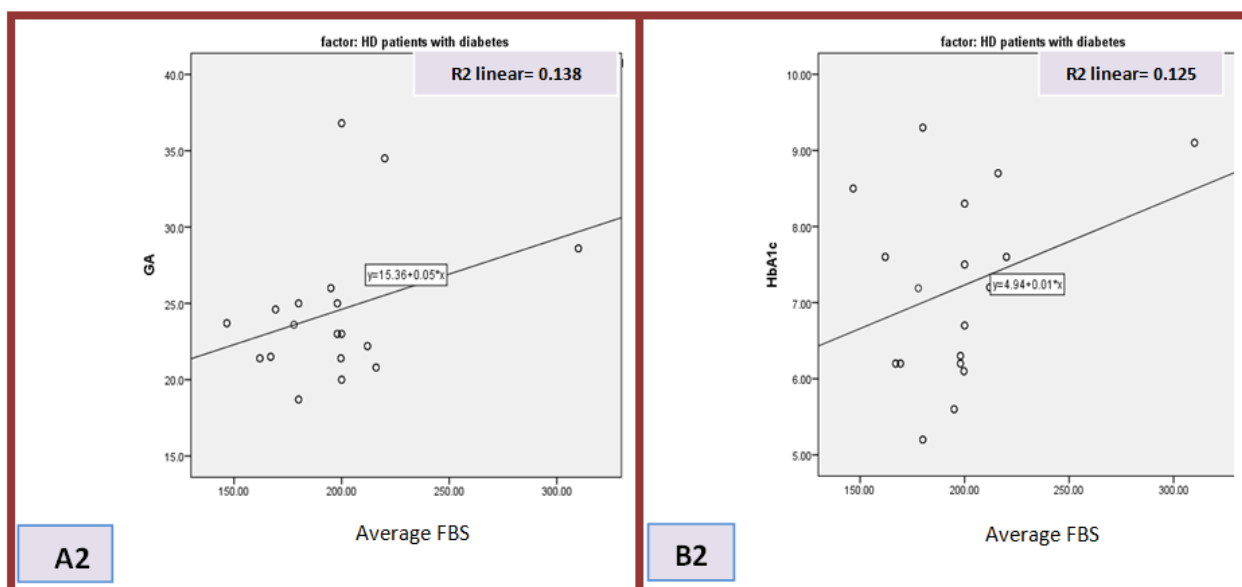
Results in table (4) consistent with Lu *et al.*,<sup>(3)</sup>;Chen *et al.*,<sup>(14)</sup> who recorded that mean of GA% increase in HD patients with diabetes compared with HD patients without diabetic and control. And consistent with Fukami *et al.*,<sup>(15)</sup> who recorded that the mean of GA% was increased in diabetes patients compared with control. GA concentrations could accurately reflect the glycaemic control in such patients without being influenced by anaemia and hypoalbuminemia. GA may be desirable in diabetic patients with ESRD complicated with both renal anaemia and hypoalbuminemia. While in HD patients without diabetes, increased GA and impaired renal function should be closely monitored for the development of arterial stiffness<sup>(15)</sup>.

**Correlation between FBS with GA% or FBS with HbA1c% in study groups.**

There were significant and positive correlations between FBS with GA% (r =0.34, P < 0.01; Figure (1) A1) and (r =0. 371, P < 0.01; Figure (2) A2) or FBS with HbA1c% (r =0.459, P < 0.01; Figure (1) B1) and (r =0.356, P < 0.01; Figure (2) B2) in diabetic patients and HD patients with diabetic respectively. As shown, the correlation between FBS and GA% was similar between HD patients with diabetes and diabetic patients, but FBS and HbA1c% seemed to be significantly lower in HD patients with diabetes than in diabetic patients.



**Figure (1):Correlation between average FBS values with GA% (Figure A2) or average FBS values with HbA1c% (Figure B2) in diabetic patients group.**



**Figure (2): Correlation between the average FBS values with GA % (Figure A3) or average FBS values with HbA1c% (Figure B3) in HD patients with diabetic group.**

**Effect of a Single HD Session on GA% and HbA1c%:** These results show that serum GA% were almost identical between before and after a single HD session in HD patients with diabetes were  $(29.4 \pm 4.71$  and  $29.3 \pm 4.5)$  respectively. While HbA1c also identical between before and after a single HD but to a lesser degree from GA, where in HD patients with diabetes were  $(8.5 \pm 1.83$  and  $8.19 \pm 1.2)$  respectively.

**The ratio of GA/HbA1C in study groups:** The GA/HbA1c ratio was (3.0) in control groups and (2.93) in diabetic patients with no significant difference between these two groups. Also the GA/HbA1C ratio showed no significant difference between HD patients with diabetes (3.5) and HD patients without diabetes (3.3).

The results in figures (1, 2) identify with the finding of study by Inaba *et al.*,<sup>(8)</sup> who recorded that the significant and positive correlations between average FBS with serum GA. Also identify with Gan *et al.*,<sup>(4)</sup> who found that GA showed a strong correlation with mean FBS and supply a more reliable marker of glycemic control, compared with HbA1c which showed heterogeneity correlation with average FBS was indicated in HD patients. The results in table (5) agreed with Gan *et al.*,<sup>(4)</sup> who indicated that the GA is superior to HbA1C in estimating glycemic control in HD patients with diabetes. While GA/HbA1c ratio symmetrical with Inaba *et al.*,<sup>(8)</sup> who recorded that GA/HbA1c ratio was (2.9) in diabetic patients group and it raised significantly in the HD patients with diabetes was (3.81).

These data clearly indicated that the substances that accumulated into uremic serum did not affect GA values at all. The only factor that associated independently with GA value was the average FBS, which associated to a greater degree with GA compared with HbA1c<sup>(16)</sup>. Although the specificity and positive predictive value of HbA1c were acceptable, they were not promising; thus, to confirm diagnosis, we can not only rely on a slight elevation of HbA1c. The elevated GA/HbA1c ratio in diabetic dialysis patients, relative to diabetic subjects without nephropathy, strongly suggests that HbA1c was falsely reduced in diabetic subjects on hemodialysis. HD patients draw iron and vitamin B12 for the purpose of anemia correction such as external ESA. These treatment increases the development of immature RBC, which ultimately changes the original structure of the hemoglobin. Such RBCs are given inadequate exposure time to go through the process of glycosylation, which may result in lower concentration of HbA1c. The lower level of HbA1c may thus offer a false impression about the overall glycemic regulation<sup>(15; 16)</sup>.

**Conclusion:** GA is a better marker for detecting short term glycemic control in HD patients with diabetes and the assessment of glycemic control by HbA1c in those patients might lead to underestimation, where the principle of treatment of DN is based on tight control of hyperglycemia.

**Ethical Clearance:** In this study all patients provided written informed consent before participation

in this study, which was approved by institutional ethics committees (university of Anbar\ ethical approval committee).

**Source of Funding:** Self.

**Conflict of Interest:** Nil

### References

- Freitas PA, Ehlert LR, Camargo JL. Glycated albumin: a potential biomarker in diabetes. *Archives of endocrinology and metabolism*. 2017 Jun;61(3):296-304.
- George SV, Pullockara JK, Kumar SS, Mukkadan JK. A study to assess changes in the hematological profile in chronic kidney disease. *The Pharma Innovation*. 2015 Aug 1;4(6, Part A):1.
- Lu CL, Ma WY, Lin YF, Shyu JF, Wang YH, Liu YM, Wu CC, Lu KC. Glycated albumin predicts long-term survival in patients undergoing hemodialysis. *International journal of medical sciences*. 2016;13(5):395.
- Gan T, Liu X, Xu G. Glycated albumin versus HbA1c in the evaluation of glycemic control in patients with diabetes and CKD. *Kidney International Reports*. 2018 May 1;3(3):542-54.
- Kim IY, Kim MJ, Lee DW, Lee SB, Rhee H, Song SH, Seong EY, Kwak IS. Glycated albumin is a more accurate glycaemic indicator than haemoglobin A1c in diabetic patients with pre-dialysis chronic kidney disease. *Nephrology*. 2015 Oct;20(10):715-20.
- Nuttall FQ. *Diabetes Care*. 1998; 21:1475-1480.
- Young DS. *Effects of drugs on clinical laboratory tests*, 5<sup>th</sup> ed AACC press. 2005.
- Inaba M, Okuno S, Kumeda Y, Yamada S, Imanishi Y, Tabata T, Okamura M, Okada S, Yamakawa T, Ishimura E, Nishizawa Y. Glycated albumin is a better glycemic indicator than glycated hemoglobin values in hemodialysis patients with diabetes: effect of anemia and erythropoietin injection. *Journal of the American Society of Nephrology*. 2007 Mar 1;18(3):896-903.
- Lin YC, Lin YC, Chen HH, Chen TW, Hsu CC, Wu MS. Determinant effects of average fasting plasma glucose on mortality in diabetic end-stage renal disease patients on maintenance hemodialysis. *Kidney international reports*. 2017 Jan 1;2(1):18-26.
- Khalaf DT. Evaluation of Heat Shock Protein 60 and its autoantibodies in Patients with Diabetes Mellitus Type1. M.Sc. Thesis. College of Education for Pure Sciences. University of Anbar. Iraq.2018.
- Abid Hamed SM. Study of Relationship between Several Interleukins and Some Biochemical Parameters in Type II Diabetics Patients. Ph. Thesis. College of Science, University of Anbar.2019
- Abdul Hadi FS, Sultan AS. The effects of type 2 diabetes mellitus on the levels of glycated hemoglobin, testosterone, leptin and calcium in Iraqi male patients. *GJBB*. 2016;5(2):164-70.
- Moulani MR, Gawali PS. Effect of Iron deficiency on glycation of hemoglobin in non diabetics. *Annals of Clinical Chemistry and Laboratory Medicine*. 2016;2(2):4-7.
- Chen CW, Drechsler C, Suntharalingam P, Karumanchi SA, Wanner C, Berg AH. High glycated albumin and mortality in persons with diabetes mellitus on hemodialysis. *Clinical chemistry*. 2017 Feb 1;63(2):477-85.
- Fukami K, Shibata R, Nakayama H, Yamada K, Okuda S, Koga M. Serum albumin-adjusted glycated albumin is a better indicator of glycaemic control in diabetic patients with end-stage renal disease not on haemodialysis. *Annals of Clinical Biochemistry*. 2015 Jul;52(4):488-96.
- Zaman SB, Hossain N, Rahman AE, Islam SM. Can glycated hemoglobin act as a reliable glycemic indicator in patients with diabetic chronic kidney disease? evidence from the Northeast of Thailand. *Medical Journal of Indonesia*. 2017 Aug 18;26(2):102-8.

# Pattern of Head Injuries in Deaths Due to Two-Wheeler Road Traffic Accidents

S.M. Krishna Sagar<sup>1</sup>, Divya Reddy Pannala<sup>2</sup>, K.V. Ramanamurthy<sup>3</sup>, K. Rajender Kumar<sup>4</sup>

<sup>1</sup>Assistant Professor, Department of Forensic Medicine, Mahavir Institute of Medical Sciences, Vikarabad,

<sup>2</sup>Assistant Professor, Department of Forensic Medicine, RVM Institute of Medical Sciences, Siddipet, <sup>3</sup>Professor, Department of Forensic Medicine, Osmania Medical College, Hyderabad, <sup>4</sup>Professor & Head, Department of Forensic Medicine, Gandhi Medical College, Secunderabad

## Abstract

**Background:** In India, from the past two decades, along with urbanization, industrialization, population explosion and migration of people, there has also been rapid growth in the field of road transportation. Cons of this can be seen in the form of increased deaths due to RTA.

**Method:** We conducted a cross sectional study in department of forensic medicine, Gandhi Medical College, Hyderabad including all cases of accidental deaths due to two-wheeler, aged above 6 years between October 2014 to May 2016.

**Results:** Majority cases were in the age group of 21-30 years, 27 (25.7%) and males 89(84.8%). Majority victims encountered accident due to skid 40(38.1%) and head on collision being common 50(47.6%). Linear fracture of vault was found in almost half cases, 53(50.5%). Subdural and subarachnoid haemorrhage were the most common one we encountered.

**Conclusions:** Males in productive age group encountered fatal RTA and also linear fracture, SDH and SAH were common pattern of injury seen in them. Stringent laws and awareness have to be created to reduce the fatalities.

**Keywords:** Head injury, road traffic accident, two-wheeler, skull fracture, intra cranial haemorrhage.

## Introduction

Road traffic accidents have become a growing health and development problem. Approximately 1.35 million people die each year because of road traffic crashes in the world. More than 90% of road traffic deaths occur in low and middle income countries.<sup>1</sup>

In India, the increase in motorization along with expansion of the road network has brought not only rural economic development but also some adverse effects

such as the increase in road accidents and among them most common are two wheelers as they constitute main vehicle fleet.<sup>2</sup>

RTA are likely to be seen in the age group 15-44 years and the usual causative factors being defective vehicle, due to defective rider and due to defective environment.<sup>2,3</sup>

The most prominent and vulnerable part of human body is head which made it more vulnerable for injury in road traffic accidents.<sup>2</sup> The most common cause of TBI normally reported in our country are road traffic accidents (RTA) accounting for 60%, followed by falls and assaults contributing to 25% and 10% of traumatic brain injuries, respectively.<sup>4</sup>

Head injury has been defined as “a morbid state, resulting from gross or subtle structural changes in the

---

### Corresponding Author:

**Dr. Divya Reddy Pannala**

Assistant Professor, Department of Forensic Medicine, RVM Institute of Medical Sciences, Siddipet

e-mail: divyarpannala@gmail.com

Mobile Number: 9966253961



scalp, skull and/or the contents of skull, produced by mechanical forces. It has also been defined as physical damage to the scalp, skull or brain produced by an external force however, such force/impact, responsible for the injury need not be applied directly to the head.<sup>5</sup>

Thus, the study was taken up to determine the pattern of head injuries in people died due to accidents involving two wheelers which are subjected to post-mortem examinations along with the socio demographic factors of the victims

## Method

This was a cross sectional study done in Forensic Medicine department of Gandhi Medical College and Hospital, Secunderabad. The study included all cases of accidental deaths due to two wheeler road traffic accidents which were admitted in Gandhi hospital and died eventually and also spot deaths which were directly brought to mortuary for post mortem examination over a study period of 2 years (October 2014- May 2016). Both rider and pillion rider who died due to head injuries with history of two wheeler road traffic accidents and aged above 6 years were included in the study and cases whose deaths occurred due to other vehicles and pedestrian deaths due to two wheelers were excluded. Socio demographic variables and details about manner of death were obtained from reliable attendants of the

deceased, hospital records, police records and inquest reports submitted with autopsy requisition in each case by concerned police officers. Other details from the postmortem examination and reports. The family members, relatives and friends were fully explained about the questionnaire and then verbal consent was taken from each individual before asking about the relevant details pertaining to the study and thus a total of 105 cases were analysed.

Statistical analysis: Data was analysed using SPSS software and descriptive analysis was done. Data were presented in the form of tables, text, and figures.

## Results

The mean age of the cases included in the study was 38.17±15.15 years. The cases mostly belonged to age group 21-30 (25.7%) followed by 31-40 years (23.8%), 41-50 years (18.1%), 51-60 years 16(15.2%), 11-20 years 9(8.5%), 61-70 years 5(4.7%), >70 years 3(2.8%) and <10 years 1(0.95%). Males comprised a majority of cases and constituted 89(84.8%) compared to females which was 16(15.2%). Considering geographical distribution of cases, 77 (73.3%) were from rural area and 28 (26.7%) from urban area. Nearly half of them belonged to lower socio-economic status 48 (45.7%) followed by middle class, 42 (40%) and upper class 15(14.3%).

**Table 1 Characteristics of vehicle and related variables**

Variable		Number (n)	Percentage (%)
Vehicle used by case during the time of accident	With gear	75	71.4%
	Without gear	30	28.5%
Rider/Pillion rider	Rider	94	89.5%
	Pillion rider	11	10.5%
Hit by type of vehicle	Two-wheeler	27	25.7%
	Four-wheeler	20	19.1%
	Heavy vehicle	18	17.2%
	Self-fall	40	38.1%
Type of collision during accident	Head on	50	47.6%
	Rear end	20	19%
	Self-skid	35	33.3%

In this study most of the cases used with gear vehicles, 75(71.4%) and were riding 94(89.5%) them at the time of accident. The major cause of accident

was self-fall, 40(38.1%) due to skid and when accident was due to vehicle, then it was mostly two-wheeler, 27 (25.7%) and the collision was head on, 50 (47.6%).

**Table 2 Type of skull fracture due to head injury**

Variable	Number (n)	Percentage (%)
Linear	53	50.5%
Depressed	9	8.6%
Compressed	8	7.6%
Crush	3	2.9%
Compressed & depressed	8	7.6%
Linear & compressed	1	1.0%
Operated	7	6.7%
Nil	16	15.2%

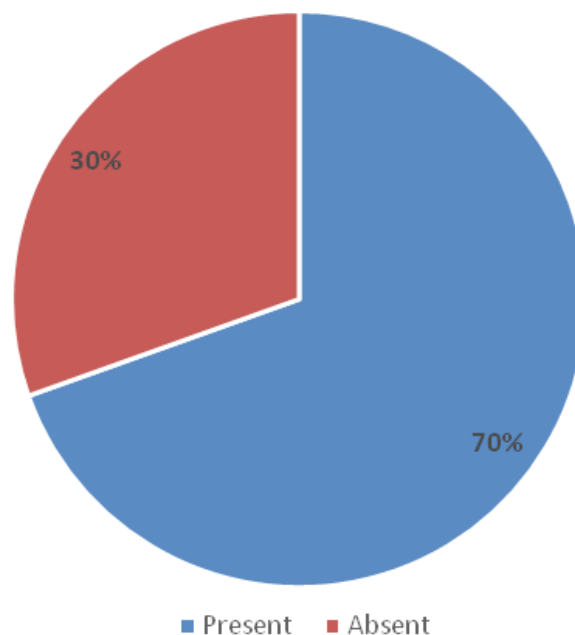
**Table 3 Pattern of head injury**

Variable		Number (n)	Percentage (%)
Contusion	Yes	88	83.8%
	No	17	16.2%
Laceration	Yes	45	42.9%
	No	60	57.1%
Abrasion	Yes	54	51.4%
	No	51	48.6%

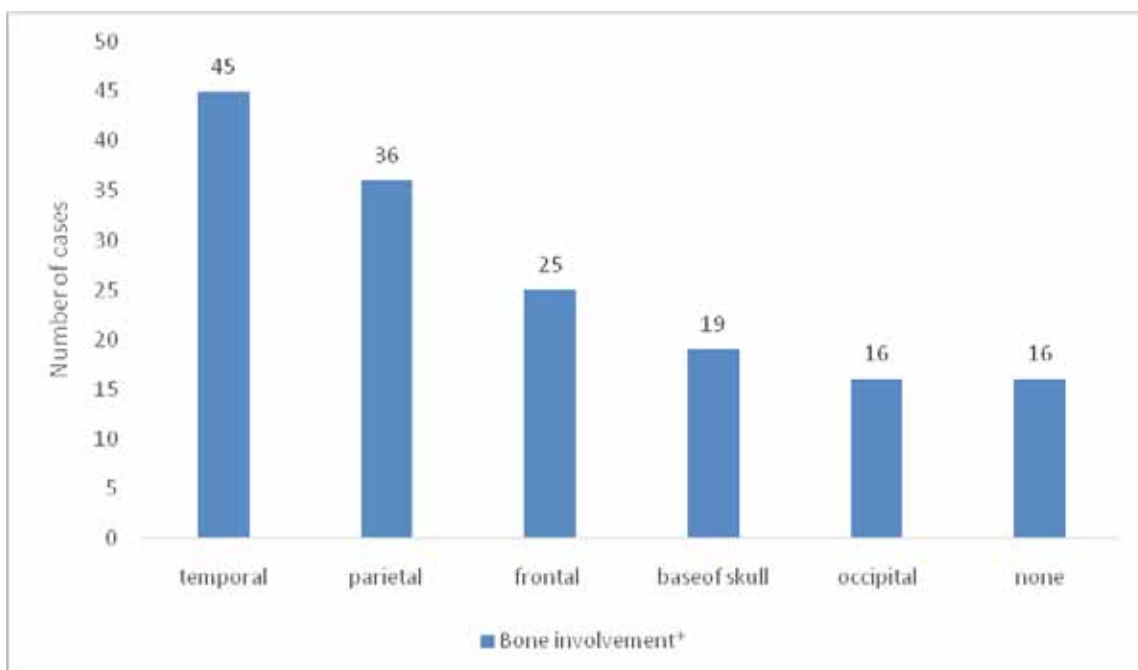
Linear fracture, 53(50.5%) was the most common type of skull fracture and temporal bone was most involved. Contusion, 88(83.8%) was the commonest injury and in 70% of cases there were other associated injuries involving other parts of body. Among the

intracranial haemorrhages, a combination of SDH and SAH accounted for 42(40%) cases followed by combination of SAH and ICH 20 (19%) cases and SDH alone accounting for 16 (15%) cases, 7 (6.6%) cases were SAH, 4(3.8%) ICH, 2 (1.9%) EDH and rest of the cases, there were multiple combination of intracranial lesions.

[Depicted in Table-2,3 and Figure-1,2]



**Figure-1 Associated injuries along with head injury**



**Figure-2 Bone involved in skull fracture (multiple answers)**

## Discussion

This was a two-year study taken up in the forensic department of a tertiary care centre, Gandhi Medical college, Hyderabad, Telangana, India.

In this study, the cases mostly belonged to age group 21-30 (25.7%) followed by 31-40 years (23.8%), similar findings were seen in Mallikarjuna SK et al.<sup>6</sup> study where as in the study done by Amir et al.<sup>7</sup>, 29.8% were in the age group 30-39 years and 27.6% were in the age group 20-29 years.

Males comprised a majority of cases and constituted 84.8% compared to females which was 15.2%. The male to female ratio in the present study is 5.6: 1 indicating male preponderance, which is similar to the study done by Menon et al.<sup>8</sup> and Amir et al.<sup>7</sup>

The cases were mostly from rural area (73.3%) and majority of them belonged to lower socio-economic status (45.7%) and middle class (40%), while the study done by Ranjana Singh et al.<sup>9</sup> showed that urban cases (64%) outnumbered rural (36%). Likewise, according to WHO, more RTA fatalities in India were among low socio-economic groups.<sup>9</sup>

In this study most of the cases used with-gear vehicles, 71.4% similar to study done by Lohith Naik et al.<sup>10</sup>. More than 2/3 rd of the cases, 89.5% were riding vehicle at the time of accident as seen even in the study done by M. Seethalakshmi et al.<sup>11</sup>. The major cause of accident was self-fall which 38.1%, reason being skid and when accident was due to vehicle collision, it was mostly two-wheeler, 25.7% and the collision was head on, 47.6% where as in study done by M. Seethalakshmi et al.<sup>11</sup>, it was collision with light motor vehicle.

In this study, linear fracture, 50.5% was the most common type of skull fracture and temporal bone was most involved. Contusion, 83.8% was the commonest injury and in 70% of cases there were other associated injuries involving other parts of body. Similar findings were seen in the study by M. Seethalakshmi et al.<sup>11</sup>, where temporo-parietal region was the most common region involved in fracture and among injuries, 42.8% were abrasions. 68% were contusions and 34% were lacerations and more than 70% cases had associated injuries involving other parts of body.

Like wise, in a study done by Pathak et al.<sup>12</sup> most of the victims of fatal head injury were having linear fracture of either skull vault or base of the skull or

both which was 43%, especially in the thin areas of temporo-parietal bone. Another study by Rajeshwar et al.<sup>2</sup> also reiterated the findings our study and showed that majority of victims who died from head injury had association with injuries to thoraco-abdominal area and extremities which was 50.64% of total cases and only 15.86% deceased showed head injury without any other associated injuries.

Among the intracranial lesions, a combination of SDH and SAH accounted for 40% cases followed by combination of SAH and ICH 19% cases and SDH alone accounting for 15% cases, 6.6% cases were SAH, 3.8% ICH, 1.9% EDH and rest in rest of the cases there were multiple combination of intracranial haemorrhage. Similar findings were seen in the study by Amir et al.<sup>7</sup> where intra cranial haemorrhage was seen in 85.9% of cases and of all bleeds SAH accounted for 55.8%. Even in studies conducted by Pathak et al.<sup>12</sup> and Rajeshwar et al.<sup>2</sup> SAH and SDH were the common type of bleeds among intra cranial haemorrhage.

## Conclusion

This study reveals that fatalities due to RTA are remarkably high in productive (21-40) year age group, and most victims are males belonging to rural area and low socio-economic class. Linear fracture involving temporal bone and SAH were also common. Road safety awareness programs must be regularly conducted to bring awareness amongst adults. Strict laws, compulsion of helmet usage for both rider and pillion rider and behaviour change communication activities may be game changer in prevention of such high fatalities.

Further study has to be conducted on the factors involved in RTA which may help in better understanding of the situation.

**Ethical Clearance:** Taken from the Institutional Ethical Committee of the medical college.

**Conflict of Interest:** Nil

**Source of Funding:** Nil

## References

1. WHO. Road traffic injuries. Fact sheet . World Health Organization. [online] [Last accessed on 2020 June 24]. Available from: <https://www.who.int/news-room/fact-sheets/detail/road-traffic-injuries>.

2. Pate RS, Hire RC, Rojekar MV. Pattern of head injury in central India population. *International Journal of Research in Medical Sciences*. 2017 Aug;5(8):3515-9.
3. Pal R, Ghosh A, Kumar R, Galwankar S, Paul SK, Pal S, Sinha D, Jaiswal AK, Moscote-Salazar LR, Agrawal A. Public health crisis of road traffic accidents in India: Risk factor assessment and recommendations on prevention on the behalf of the Academy of Family Physicians of India. *Journal of family medicine and primary care*. 2019 Mar;8(3):775.
4. Agrawal A, Munivenkatappa A, Shukla DP, Menon GR, Alogolu R, Galwankar S, Kumar SS, Momhan PR, Pal R, Rustagi N. Traumatic brain injury related research in India: An overview of published literature. *International journal of critical illness and injury science*. 2016 Apr;6(2):65.
5. American College of Surgeons Committee on trauma. Resources for the optimal care of the injured patient, Chicago III. American College of Surgeons 1993.
6. Mallikarjuna SK, Krishnappa P. Prevalence of maxillofacial injuries by motorized two wheeler road traffic accidents in Bangalore city. *Dent Traumatol*. 2009 Dec;25(6):599-604. doi: 10.1111/j.1600-9657.2009.00832.x. Epub 2009 Oct 14.
7. Amir A, Hoda MF, Khalil S, Kirmani S. Pattern of head injuries among victims of road traffic accidents in a tertiary care teaching hospital. *Indian Journal of Community Health*. 2013 Jun 30;25(2):126-33.
8. Menon A, Pai VK, Rajeev A. Pattern of fatal head injuries due to vehicular accidents in Mangalore. *J Forensic Leg Med*. 2008 Feb;15(2):75-7. doi:10.1016/j.jflm.2007.06.001. Epub 2007 Sep 27.
9. WHO. Road traffic injuries. Fact sheet No. 358. World Health Organization. [online] [Last accessed on 2020 May 2020]. Available from: <http://www.who.int/news-room/fact-sheets/detail/road-traffic-injuries> .
10. Naik L, Kainoor S, Sangram R, Neeta PN. Epidemiological study of two wheeler traffic accident victims in medicolegal autopsies. *IJFMTS*. 2016 Oct;1(1):11-3.
11. Seethalakshmi M, Sudalaimuthu R, Mahendran J, Nagendrakumar A. Study of injury pattern in human beings in road traffic accidents involving two wheelers. *Journal of Evolution of Medical and Dental Sciences*. 2015 Sep 24;4(77):13436-59.
12. AkhileshPathak, N.L. Desania and Rajesh Verma. Profile of road traffic accidents and Head Injury in Jaipur (Rajasthan). *J. Indian Acad Forensic Med*, 30(1).

# Maxillofacial Trauma and Alcohol Abuse: A Descriptive Cross Sectional Study

S. Devakumari<sup>1</sup>, T. Vijhayapriya<sup>2</sup>, Nandini Biradar<sup>3</sup>, P. Amudha<sup>4</sup>, D.S. Dinesh<sup>5</sup>, S. Devameena<sup>6</sup>

<sup>1</sup>Oral and Maxillofacial Surgeon, Associate Professor and HOD, Department of Dentistry, Indira Gandhi Medical College & Research Institute (Govt.), Puducherry-605008, India, <sup>2</sup>Associate Professor, Department of Ophthalmology, Indira Gandhi Medical College & Research Institute (Govt.), Puducherry-605008, India, <sup>3</sup>Associate Professor, Department of Dentistry, Bidar Institute of Medical Sciences, Bidar, Karnataka-585401, India, <sup>4</sup>Assistant Professor, Department of Ophthalmology, Indira Gandhi Medical College & Research Institute (Govt.), Puducherry-605008, India, <sup>5</sup>Professor and HOD, Department of Conservative Dentistry and Endodontics, Sri Venkateswara Dental college and Hospital, ARIYUR, Puducherry-605008, India, <sup>6</sup>Senior Lecturer, Department of Prosthodontics and Crown and Bridge, Sri Venkateswara Dental College and Hospital, ARIYUR, Puducherry-605008, India

## Abstract

**Background:** To assess the relationship of alcohol abuse in maxillofacial trauma in a tertiary care hospital, Puducherry, South India.

**Materials and Method:** A descriptive cross sectional study was done by retrieving the patient's inpatient and operative records from the year 2011 to 2018. The parameters that were assessed includes association of the alcohol during injury, etiology, demographic data and the type of fracture.

**Conclusion:** The descriptive analysis of the facial fractures in Puducherry, INDIA provides an insight in to type of facial fractures and their etiology recorded in patients with alcohol abuse during injury. These kinds of studies in the particular geographical region are important in developing prevention strategies.

**Keywords:** Alcohol abuse, maxillofacial, fracture, mandible, zygoma.

## Introduction

Alcohol consumption is an increasing social trend nowadays in any part of India. Over indulgence of alcohol and injuries under the influence of alcohol is commonly encountered in maxillofacial trauma management settings. Face is the most targeted part of the body for all interpersonal violence throughout the world. Interpersonal violence and alcohol consumption has an inseparable correlation. Roads should have made safer for all citizens because a large percentage of

population—children, pedestrians, cyclists, motorcyclists, and the elderly are most vulnerable<sup>1</sup>. Indian researches on road safety measures claim that alcohol consumption is a threat to our civilization leading to premature life loss and downstream ones economic status. This must be prevented by a holistic approach on this firing issue<sup>2</sup>. According to WHO, RTA accounts for 9 th position of DALY (*disability-adjusted life year*) loss but in 2020 it can reach to third position<sup>3,4,5</sup>. With the present scenario of alcohol consumption due to increase social activities in young adults, we conducted a descriptive cross sectional study on the influence of alcohol and the correlation with maxillofacial trauma patterns in Puducherry, south India.

---

## Corresponding Author:

**Dr. P. Amudha MBBS. DNB**

Assistant Professor, Department of Ophthalmology, Indira Gandhi Medical College & Research Institute (Govt.), Puducherry-605008, India

## Materials and Method

The descriptive study was carried out for the period of 7 years (2011-2018) at the Department of Dentistry,

IGMC & RI after getting ethical committee clearance (IEC no: 17/163/IEC/PP/2018).In patient records were retrieved and data were entered in a structured proforma. Data retrieved were analysed using SPSS SOFTWARE - 24. The compiled data were analysed using descriptive and inferential statistics. The parameters that were assessed include association of the alcohol during injury, etiology, demographic data and the type of fracture.

**Inclusion Criteria:** Maxillofacial trauma victims of both the genders in the age group of 18 to 65 years were included in the study.

Maxillofacial fractures that had occurred when patient was under the influence of alcohol (H/O alcohol consumption within six hours before the trauma)

Patients with isolated maxillofacial fractures

Patients who underwent surgery for maxillofacial fractures

RTA involving -motorised/non motorised two wheelers (both as riders and pillion riders),

- Light motor vehicles/heavy motor vehicles
- and pedestrians vs. any motorised vehicle

Self fall under the influence of alcohol

Interpersonal assault

**Exclusion Criteria:**

Pregnant females

Unconscious patients

Poly trauma

Pan facial fractures

Maxillofacial fractures treated by conservative method

Soft tissue injuries without fractures

Isolated Dentoalveolar fractures

The study population of 100 (N=100) samples fulfilled the above criteria and were included in the study.

**Results**

Out of 163 patients operated for 7 years (2011-2018) in the Department of Dentistry,100 patients suffered maxillofacial fracture under the influence of alcohol (N=100).

**Table 1: Frequencies and proportions of parameters assessed.**

Parameters	Group	Frequency	Percent
Age	20 and below	9	9.0
	21-30	33	33.0
	31-40	24	24.0
	41-50	24	24.0
	51-60	8	8.0
	>60	2	2.0
Gender	Male	94	94.0
	Female	6	6.0
Etiology	Assault	14	14.0
	RTA	60	60.0
	Self fall	26	26.0
Type of Fracture	Angle Mandible	22	22.0
	Body Mandible	12	12.0
	Condyle Mandible	14	14.0
	Parasymphysis Mandible	8	8.0
	Symphysis Mandible	4	4.0
	Lefort I Maxilla	1	1.0
	Lefort II Maxilla	2	2.0
	Lefort III Maxilla	1	1.0
	Zygoma	10	10.0
	Zygomatic Arch	26	26.0

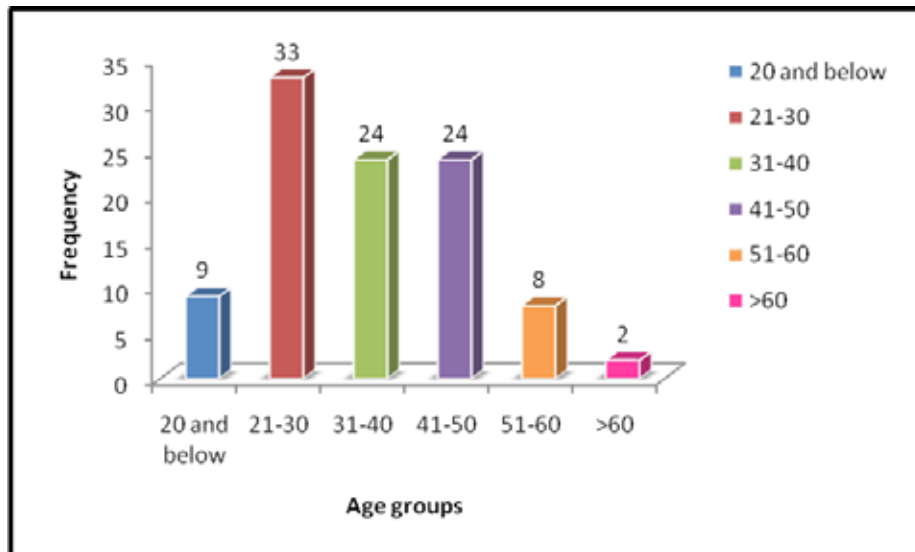


Fig:1 Frequency –age group.

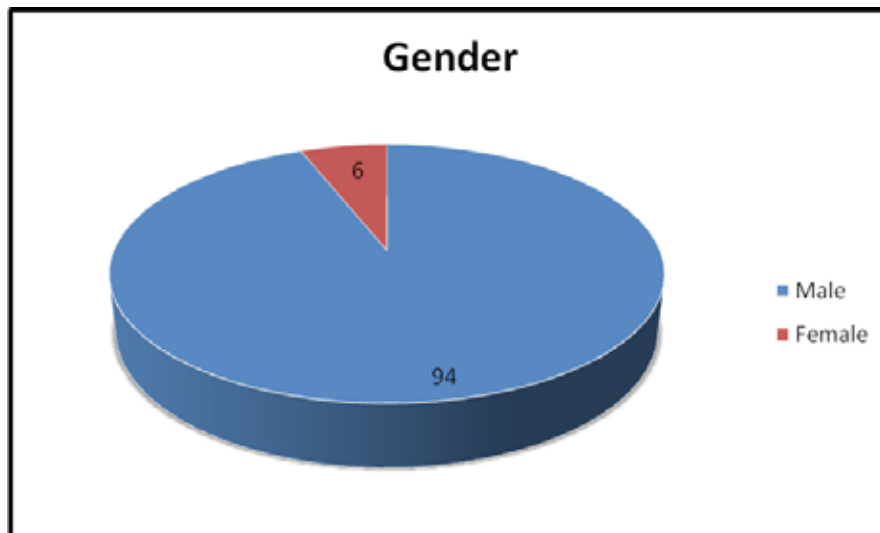


Fig:2 Gender distribution

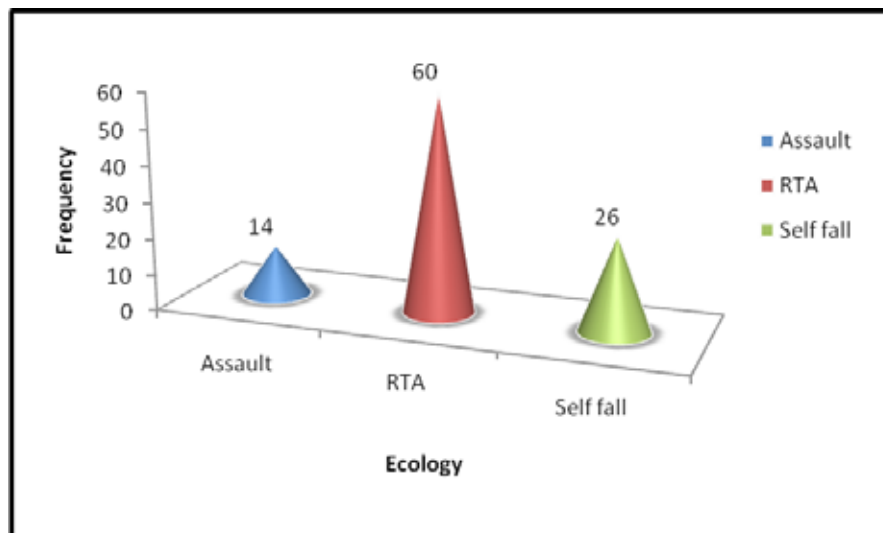


Fig :3 Frequency-Etiology

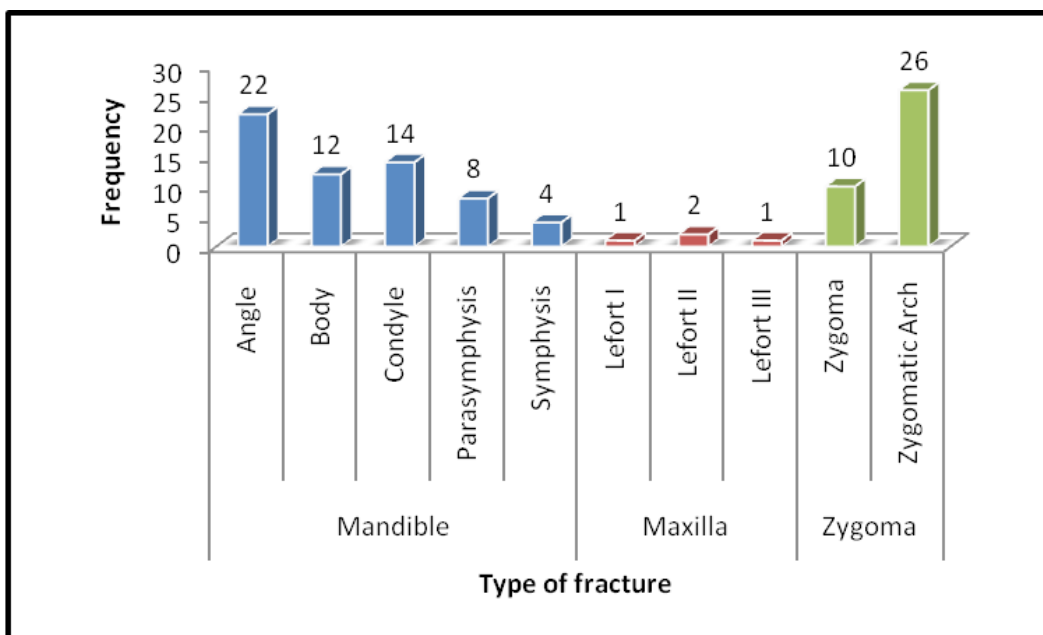


Fig :4 Frequency- type of fracture

Table 2: Association between etiology and the age group

Etiology	Age Group												Total		Chi Square	P Value
	≤20		21-30		31-40		41-50		51-60		>60		N	%		
	N	%	N	%	N	%	N	%	N	%	N	%				
Assault	4	44.4	3	9.1	2	8.3	5	20.8	0	0.0	0	0.0	14	14.0	13.036	0.222
RTA	4	44.4	19	57.6	16	66.7	14	58.3	5	62.5	2	100.0	60	60.0		
Self fall	1	11.1	11	33.3	6	25.0	5	20.8	3	37.5	0	0.0	26	26.0		

Table 3: Distribution of fracture in different age groups

Etiology	Age Group												Total		Chi Square	P Value
	≤20		21-30		31-40		41-50		51-60		>60		N	%		
	N	%	N	%	N	%	N	%	N	%	N	%				
Angle Mandible	3	33.3	8	24.2	5	20.8	5	20.8	1	12.5	0	0.0	22	22.0	66.707	0.019
Body Mandible	1	11.1	4	12.1	4	16.7	2	8.3	1	12.5	0	0.0	12	12.0		
Condyle Mandible	3	33.3	4	12.1	2	8.3	4	16.7	1	12.5	0	0.0	14	14.0		
Para symphysis Mandible	0	0.0	6	18.2	1	4.2	0	0.0	0	0.0	1	50.0	8	8.0		
Symphysis Mandible	0	0.0	0	0.0	0	0.0	3	12.5	0	0.0	1	50.0	4	4.0		
Lefort I Maxilla	1	11.1	0	0.0	0	0.0	0	0.0	0	0.0	0	0.0	1	1.0		
Lefort II Maxilla	0	0.0	0	0.0	0	0.0	1	4.2	1	12.5	0	0.0	2	2.0		
Lefort III Maxilla	0	0.0	1	3.0	0	0.0	0	0.0	0	0.0	0	0.0	1	1.0		
Zygoma	1	11.1	2	6.1	2	8.3	5	20.8	0	0.0	0	0.0	10	10.0		
Zygomatic arch	0	0.0	8	24.2	10	41.7	4	16.7	4	50.0	0	0.0	26	26.0		



**Table 4: Association between type of fracture and etiology**

Type of fracture	Etiology						Total		Chi Square	P Value
	Assault		RTA		Self fall					
	N	%	N	%	N	%	N	%		
Angle Mandible	8	57.1	11	18.3	3	11.5	22	22.0	29.877	0.039
Body Mandible	2	14.3	5	8.3	5	19.2	12	12.0		
Condyle Mandible	0	0.0	12	20.0	2	7.7	14	14.0		
Parasymphysis Mandible	1	7.1	6	10.0	1	3.8	8	8.0		
Symphysis Mandible	0	0.0	3	5.0	1	3.8	4	4.0		
Lefort I Maxilla	0	0.0	0	0.0	1	3.8	1	1.0		
Lefort II Maxilla	0	0.0	2	3.3	0	0.0	2	2.0		
Lefort III Maxilla	0	0.0	1	1.7	0	0.0	1	1.0		
Zygoma	2	14.3	7	11.7	1	3.8	10	10.0		
Zygomatic Arch	1	7.1	13	21.7	12	46.2	26	26.0		

Frequencies of different parameters assessed (table -1) shows males at the age group of 21 to 30 years suffered maxillofacial injuries under the influence of alcohol. RTA was the most common etiology and Mandibular fracture is the commonest type of fracture encountered.

On assessment of age distribution (fig-1) it reveals that the most vulnerable age group is 21 to 30 years followed by 31 to 40 yrs and 41 to 50 years with equal frequency. Males (94%) suffered maxillofacial trauma under the influence of alcohol in a larger proportion compared to females (fig-2). RTA is the most common etiology followed by self fall and then assault (fig-3).

On assessment of type of fracture (fig-4), the most common fracture encountered were fracture Mandible (symphysis, parasymphysis, angle, body, ramus and condyle of the mandible). Mandibular fracture (60%) was followed by fracture zygoma (36%) (zygomatico maxillary complex and the zygomatic arch). In mandibular fracture the common subtype encountered was angle of the mandible followed by mandibular condyle.

On analysis of the association between the parameters such as age and the etiology of trauma under the influence of alcohol (table-2), the most vulnerable age group being 21 to 30 years and they succumbed to RTA was elicited.

Association between the commonest types of fracture in the vulnerable age group of 21 to 30 years

(table-3) revealed that this particular age group had fracture Mandible more commonly than fracture Zygoma.

Further, the association between the etiology and the type of fracture (table-4) revealed that most of the RTA resulted in fracture Mandible followed by fracture Zygoma.

#### Discussion:

Alcohol drinking is a severe socio economic issue in India. Consumption of alcohol small amounts every day, drinking alcohol 6 hrs before driving, binge drinking everyday or occasionally in a week all leads to RTA<sup>6</sup>. RTA is the major etiology of maxillofacial trauma in developing countries like India<sup>7</sup>. Alcohol abuse and its relationship to trauma had reached massive proportions<sup>8</sup>.

Alcohol with blood levels 0.04 g/dl can hinder in patients decision making and does not make them to realise the foreseen danger, 0.05g/dl increases the risk by 1.83% and affects treatment and prognosis in RTA management<sup>9,10,11</sup>. In India alcohol breath testing is done randomly on susceptible drivers in police checkpoints. Alcohol breathe testing and alcohol blood testing is done on crash drivers in the hospitals but a clear data on this is lacking. Thailand is the only south East Asian country to enforce special blood alcohol concentration limit<sup>12</sup>.

Alcohol interferes with neuro transmission and the function of brain receptors<sup>13</sup>. This decrease in function makes people fearless and less bothered about legal or

health implications<sup>14</sup>. Alcohol consumption reduces cognitive behaviour and reduces a person's problem solving ability in a conflicting situation. Further it causes increase in aggressiveness and increases emotional responses<sup>15-18</sup>. Adeyoma et al<sup>19</sup> recorded that 90% of fatalities in developing countries were because of RTA under alcohol abuse.

Use of restraints such as helmets and seat belts is of paramount importance in preventing maxillofacial trauma. Bekal et al<sup>20</sup> recorded that the incidence of maxillofacial trauma increased due to non utilisation of restraining devices in and around Bengaluru, India. Helmets are not gender specific. In India a common misconception is that full facial helmets are meant for males and semi helmets are meant for females. This renders most of the females vulnerable to facial fractures. Although use of restraints such as helmets and seat belts are mandatory in any part of India, the compliance is less. Bekal et al<sup>20</sup> and Pandey et al<sup>21</sup> recorded maxillofacial fractures in RTA because of not wearing helmets or not wearing seat belts.

In our study males were commonly affected than females which are in concurrence with most of the studies published from India<sup>22,23</sup>. Puducherry city, capital of the union territory is a former French colony and a major tourist attraction. The city attracts lots of tourists and workers from adjoining rural area. The main modes of transportation are two wheelers and hence the recorded maxillofacial trauma was high in males as males are the earning members in developing country like India. We recorded maxillofacial trauma in six females who were pillion riders without use of helmets or wearing semi helmets under the influence of alcohol.

Mandible is the most common fracture encountered in this region (60%). This can be explained by the fact that most of the injuries are due to RTA involving motorised two wheelers without the use of helmets. The next common type of fracture being zygoma and zygomatic arch (36%). The type of fractures recorded were similar to the study recorded by Kapoor et al<sup>24</sup>.

### Conclusion

The descriptive study, maxillofacial trauma under alcohol abuse clearly reveals the association of the trauma under the influence of alcohol in and around Puducherry. Use of restraining devices, proper maintenance of faulty roads, rehabilitation of drunk and drive crash drivers to prevent repeated injury are mandatory.

### References

1. Pal R, Ghosh A, Kumar R, Galwankar S, Paul SK, Pal S, Sinha D, Jaiswal A K, Moscote-Salazar LR, Agrawal A. Public health crisis of road traffic accidents in India: Risk factor assessment and recommendations on prevention on the behalf of the Academy of Family Physicians of India. *J Family Med Prim Care* 2019;8:775-83.
2. Jaiswal AK, Krishna S, Agarwal A, Ghosh A, Pal R. Alcohol and road safety: Investigation and legal aspects. *Al Ameen J Med Sci* 2018;11:154-60.
3. Pal R, Agarwal A, Galwankar S, Swaroop M, Stawicki SP, Rajaram L, et al. The 2014 Academic College of Emergency Experts in India's INDO-US Joint Working Group (JWG) White Paper on "Developing Trauma Sciences and Injury Care in India." *Int J Crit Illn Inj Sci* 2014;4:114-30.
4. Pal R. Injury science in India: Call for the action. *Indian J Prev Soc Med* 2012;43:229-32
5. HO. Report of the Committee on Road Safety and Traffic Management, The Secretariat for the Committee on Infrastructure Planning Commission, Government of India [online] Available from: [www.infrastructure.gov.in](http://www.infrastructure.gov.in).
6. Watt K, Purdie DM, Roche AM, McClure RJ. Risk of injury from acute alcohol consumption and the influence of confounders. *Addiction* 2004; 99:1262-73
7. Karne M, Mishra S, Ashish T, et al. Study of pattern of injuries by road traffic accident on National Highway-24. *International Journal of Contemporary Surgery* 2017;5:37-41.
8. Rehm J, Gmel G, Sempos CT, et al. Alcohol-related morbidity and mortality. *Alcohol Res Health* 2003;27(1):39-51.
9. Gururaj G. Alcohol and road traffic injuries in South Asia: Challenges for prevention. *J Coll Physicians Surgeons Pakistan* 2004;14:713-8.
10. Gururaj G. The effect of alcohol on incidence, pattern, severity and outcome from traumatic brain injury. *J Indian Med Assoc* 2004;102:157-60, 163.
11. McLean A, Holubowycz OT. Alcohol and the risk of accident involvement. Alcohol, drugs and traffic safety Proceedings of the 8th International Conference on Alcohol, Drugs and Traffic Safety, Stockholm; 1980:15-9
12. Regional report on status of road safety: WHO

- South-East Asia region. [online] Available from: [http://www.searo.who.int/entity/disabilities\\_injury\\_rehabilitation/documents/9789290223559/en](http://www.searo.who.int/entity/disabilities_injury_rehabilitation/documents/9789290223559/en)
13. Pihl RO, Peterson JB, Lau MA. A biosocial model of the alcohol aggression relationship. *J Stud Alcohol Suppl* 1993;11:128–39
  14. Pihl RO, Hoaken PN. Biological bases of addiction and aggression in close relationships. In: Wekerle C, Wall AM, editors. *The violence and addiction equation: theoretical and clinical issues in substance abuse and relationship violence*. New York: Brunner-Routledge; 2001. p. 25–43.
  15. Peterson JB, Rothfleisch J, Zelazo P, Pihl RO. Acute intoxication and cognitive functioning. *J Stud Alcohol* 1990;51:114–22.
  16. Sayette MA, Wilson GT, Elias MJ. Alcohol, aggression: a social information processing analysis. *J Stud Alcohol* 1993;54:399–407.
  17. Pliner P, Cappell H. Modification of affective consequences of alcohol: a comparison of social and solitary drinking. *J Abnorm Psychol* 1974;83:418–25.
  18. Rhem J, Room R, Graham K, Monteiro M, Gmel G, Sempos CT. The relationship of average volume of alcohol consumption and patterns of drinking to burden of disease: an overview. *Addiction* 2003;98:1209–28.
  19. Adeyemo WL, Ladeinde AL, Ogunlewe MO, et al. Trends and characteristics of oral and maxillofacial injuries in Nigeria: a review of the literature. *Head Face Med* 2005;1:7
  20. Bekal M, Brijesh K, Suresha KR. Retrospective analysis of the effect of alcohol abuse and restraining device on maxillofacial injury- a study of 225 cases. *J. Evolution Med. Dent. Sci.* 2019;8(47):3526-30
  21. Pandey S, Roychoudhury A, Bhutia O, et al. Study of the pattern of maxillofacial fractures seen at a tertiary care hospital in North India. *J Maxillofac Oral Surg* 2015;14(1):32-9
  22. Shankar AN, Shankar VN, Hegde N, et al. The pattern of the maxillofacial fractures-a multicenter retrospective study. *J Craniomaxillofac Surg* 2012; 40(8):675-9
  23. Gupta R, Suryanarayan S, Sharma A, et al. Traumatic mandibular fractures: pendulum towards closed reduction. *The World Articles in Ear, Nose and Throat* 2010;3:1-3
  24. Kapoor P, Kalra N. A retrospective analysis of maxillofacial injuries in patients reporting at a tertiary care hospital in East Delhi. *Int J Crit Illn Inj Sci* 2012;2(1):6-10

# Histopathological Grading and Enzyme Histochemical Study of the Placenta in Gestational Diabetes Mellitus Pregnant Women

Sahar A.H. AL-Sharqi<sup>1</sup>, Amal Kadhem Chalooob<sup>2</sup>, Ilham Abd Allah Ali Al-Saleem<sup>3</sup>

<sup>1</sup>Assistant Professor, Department of Biology, College of Science, Mustansiriyah University, Baghdad/Iraq,

<sup>2</sup>Assistant Professor, Department of Basic Science, College of Dentistry, Mustansiriyah University, Baghdad/Iraq,

<sup>3</sup>Lecturer, Department of Biology, College of Science, Al-Mosul University, Mosul/Iraq

## Abstract

Gestational diabetes mellitus (GDM) constitutes carbohydrate metabolism disorders that lead to severe and sometimes life-threatening complications of pregnancy.

**Materials and Method:** 40 placenta biopsies with blood samples were taken from gestational diabetic pregnant women and 20 placenta biopsies with blood samples were taken from healthy pregnant women, the tissues were fixed, processed, embedded and cutting separately depending on procedure for enzyme histochemical and routine histological technique and the blood was centrifuged.

**Results:** The histological changes in the GDM group represented by villous oedema in approximately (30%) of the GDM group, an excessive amount of collagen fibres in the villous stroma (57.5%). Syncytial knots were formed (70 %) in addition to an excessive number of cytotrophoblast cells in about (65 %). The stromal fibrinoid deposition was noticed in (52.5 %). Hypo-vascular villi are seen in (32.5%) also, atherosclerosis of the uteroplacental arteries in (40%) of biopsies. In enzyme histochemistry, the villous stroma of the GDM group has a strong reaction to the G-6-P enzyme. There is a significant increase ( $p < 0.05$ ) in serum blood sugar, cholesterol, blood urea in the GDM group when compared with the normoglycemic group.

**Conclusions:** The increment of serum blood sugar caused histological and enzyme histochemical alteration during pregnancies.

**Keywords:** *Gestational Diabetes Mellitus, placenta, Histopathological, Enzyme histochemical.*

## Introduction

Gestational diabetes mellitus (GDM) is defined as a condition of glucose intolerance that appears during pregnancy<sup>1</sup>. This type of diabetes accompanies the pregnancy period and disappears after birth. It is a medical complication that affects about 3-10 % of pregnant women, and it appears more in women with a family history of the disease.<sup>2</sup>

Diabetes occurs during the second trimester of pregnancy<sup>3</sup>, but most of it occurs in the third trimester of pregnancy, as the mother is likely to develop diabetes after childbirth, especially type-2 diabetes mellitus<sup>4</sup>. The causes of GDM in some women are not known in a specific way, but there are contributing factors in the occurrence of the disease, including the interference of the hormones required by the fetus's growth that is an obstacle to the work of insulin<sup>5</sup>, and that weight gain may lead to increased insulin resistance and insulin resistance will deprive the fetus of the benefit of the effect of insulin product<sup>6</sup>. The placenta during pregnancy produces additional amounts of the hormone (Cortisol) and other hormones that are anti-insulin, such as progesterone and human chorionic gonadotrophin and the human placental lactogen<sup>7</sup>. All of these hormones increase the level of glucose in beta cells. Beta-cells in the pancreas is

---

### Corresponding Author:

**Sahar A.H. AL-Sharqi**

Assistant Professor, Department of Biology, College of Science, Mustansiriyah University, Baghdad/Iraq

e-mail: saharalsharqi@uomustansiriyah.edu.iq

unable to produce sufficient amounts of insulin to offset this increase in the level of glucose or there was insulin resistance by the mother (Maternal insulin resistance) as this increases the possibility of a case of excess glucose in the pregnant mother (Hyperglycemia) or what it is called GDM<sup>8,9</sup>. The incidence of complications of GDM in Iraq has increased dramatically in recent years and the health importance of pregnant women and the complications that occur during pregnancy.

The current study aimed to identify some of the histopathological, enzyme histochemical and biochemical changes accompanying these complications.

## Materials and Method

1. **Study Samples:** The 60 placenta tissue and blood samples were obtained for pregnant women from Baghdad Teaching Hospital and based on the medical diagnosis by the gynaecologist. A questionnaire was completed containing much information about the pregnant woman, the diseases she had during pregnancy and the laboratory tests that were performed. The women under study were divided into two groups: The first group of 40 pregnant women with GDM, age ranging from 20-43 years. The second group 20 normoglycemic pregnant women, age ranging from 18-40 years.
2. **Tissues collection:** Placental tissue biopsies were collected and dissected from the central part of the placental bed after normal vaginal deliveries or caesarian section and prepared for histopathological and enzyme histochemical analysis as follows:  
  
The fragments for the histopathological study were then immediately fixed in formalin 10%, dehydrated in a graded ethanol sequence and embedded in paraffin according to a standard protocol, sectioned at 5  $\mu$ m and installed for the staining with Hematoxylin-Eosin (H & E) on glass slides and examined under the microscope<sup>10</sup>. The fragments for enzyme histochemical study were then immediately fixed and dehydrated in a mixture of equal volumes of cold acetone and absolute alcohol for 24 hours for demonstration of Glucose-6-Phosphatase (G-6-Pase) were based on the modified procedure described by<sup>11</sup>.
3. **Blood samples collection:** The 5 ml of venous blood was drawn for each of the women from the study

groups, the blood was placed in a test tube and left at laboratory temperature 15-25 ° C until the thrombus was formed, then the thrombus was separated by the centrifuge at 3000 rpm for five minutes, a serum was withdrawn and preserved -20°C until laboratory tests.

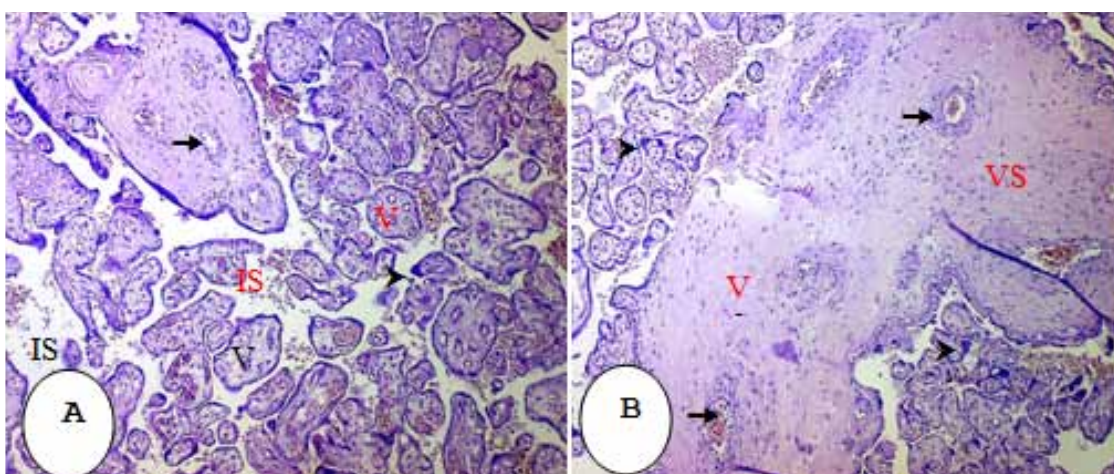
4. **Biochemical test:** Serum Glucose, Cholesterol and Urea were determined by an enzymatic method with the commercially available kit (Rondox).
5. **Statistical Analysis:** All results are expressed as Mean values  $\pm$  Standard Deviation or as N (%). For computation, we used the SPSS program version 25 for Windows (SPSS Inc., Chicago, IL, USA) software package. Differences were considered as significant if  $p < 0.05$ .

## Results and Discussion

- A. **Placental tissues:** Placental tissue from normoglycemic, chorionic villi test appeared as vascular villous stroma surrounded by multinucleated syncytiotrophoblastic layer with indistinct cell borders and darkly stained nuclei. Very rarely we have been able to distinguish villous cytotrophoblastic cells that behave as ovoid, greatly variable in thickness, with well-defined cell borders and light cytoplasm staining. The villous stroma consisted of a core of connective tissue that had several bundles of collagen fibres and flattened fibroblasts. There were 2-5 dilated capillaries lined with fetal blood in the villous stroma (Fig. 1A & B).

All the placenta obtained from the two groups were stained with H & E histological stain. On examination of these sections with a light microscope, our result recognized several histological changes with different proportions. These changes are listed in (Table -1) as following:

Villous oedema was easily seen in the placenta stained, it was seen in 12 placentae (30 %) of the GDM group. However, we couldn't find placentae with villous oedema in the normoglycemic group, (Fig. 2A). Other studies found that one of the pathological features of placentae in hyperglycemic pregnant women is villous oedema<sup>12</sup>. The intervillous distance was of various extent, but some of the distance was vast when compared with normal placentae resulting from intervillous oedema with the increased amount of fibrinoid<sup>6</sup>



**Figure (1): Light microscopical appearance of normoglycemic pregnant women placenta showing microvilli (V) with narrow intervillous spaces (IS) and syncytial knots (head arrows). The villous stroma (VS) shows blood vessels (arrows) containing bloodcells, (A & B: H & E staining, X10).**

On the other hand, an excessive amount of collagen fibres in the stroma of the villi was easily demonstrated, stromal fibrosis was observed in 2 placentae (10%) of the normoglycemic group, but increased up to 23 placentae (57.5%) from GDM group, (Fig. 2B). This results matched with other studies that observed a histological change in GDM placentae represented by stromal fibrosis<sup>6</sup>

Syncytial knots were formed in more than one-third of the examined villi, in 28 placentae (70 %) from the GDM group. However, this deviation from the normoglycemic group was noticed only in 4 placentae (20 %) (Fig. 2C). More than previous paper observed Syncytial knots in placentae of GDM pregnant women<sup>6,13</sup>. Immoderate forming Syncytial knots is a relationship with placental pathology, and a knotting indicator is employed to estimate riskiness.<sup>14</sup>

In GDM group cases an excessive number of cytotrophoblast cells have been frequently observed. This change was observed in the normoglycemic group in only 2 placentae (10 %), in the GDM group in 26 placentae (65 %). El Sawy et al<sup>6</sup> and other study<sup>15</sup>

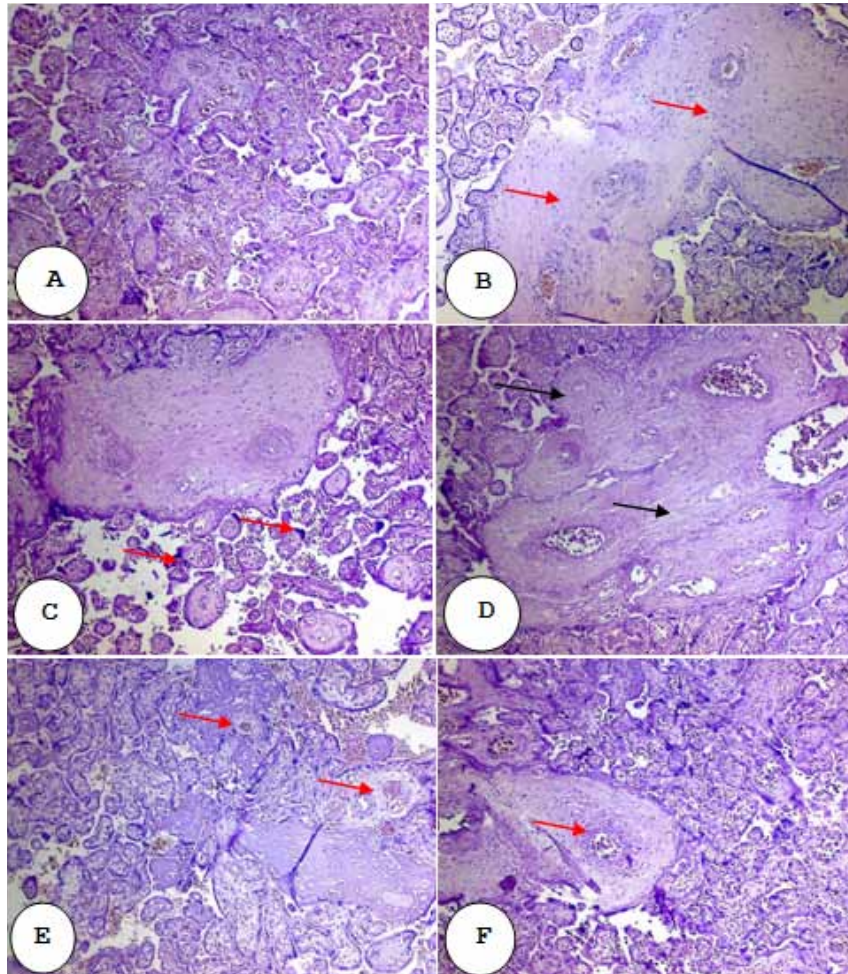
confirm that one of indicator of placenta tissue of GDM pregnant is cytotrophoblast cells proliferation<sup>6</sup>.

Stromal fibrinoid deposition affecting of the villi was observed in the normoglycemic group 4 placentae (20 %). Although it was found in 21 placentae (52.5 %) in placentae obtained from the GDM group, (Fig. 2D). Another study confirms that the morphological feature of villous tissue in GDM of women is fibrin deposit<sup>13</sup>. Hypo-vascular villi are seen in 3 placentae (15%) of the normoglycemic group and 13 placentae (32.5%) of the GDM group, (Fig. 2E). A study on placenta tissue in hyperglycemic pregnancy noticed alterations in vascularity repeating by surprisingly hypovascular and these had a smaller diameter and show a wavy course compared with normal villi.<sup>16</sup> Also, atherosclerosis of the uteroplacental arteries appears as multiple foamy cells within the walls of the vessels. It was seen only in one placenta from the normoglycemic group (5%), and in 16 placentae (40%) from the GDM group, (Fig. 2F). A study found that placental atherosclerosis occurred in 28.94% of the group with GDM compared to 10.52% of the group with normoglycemic pregnancy<sup>17</sup>.

**Table – 1: Histological grading of placental tissues in GDM and normoglycemic groups**

Histological finding	Normoglycemic group N=20 (%)	GDM group N=40 (%)	P-Value
Villous edema	0 (0 %)	12 (30 %)	0.01
Stromal fibrosis	2 (10 %)	23 (57.5 %)	0.01
Syncytial knots	4 (20 %)	28 (70 %)	0.01

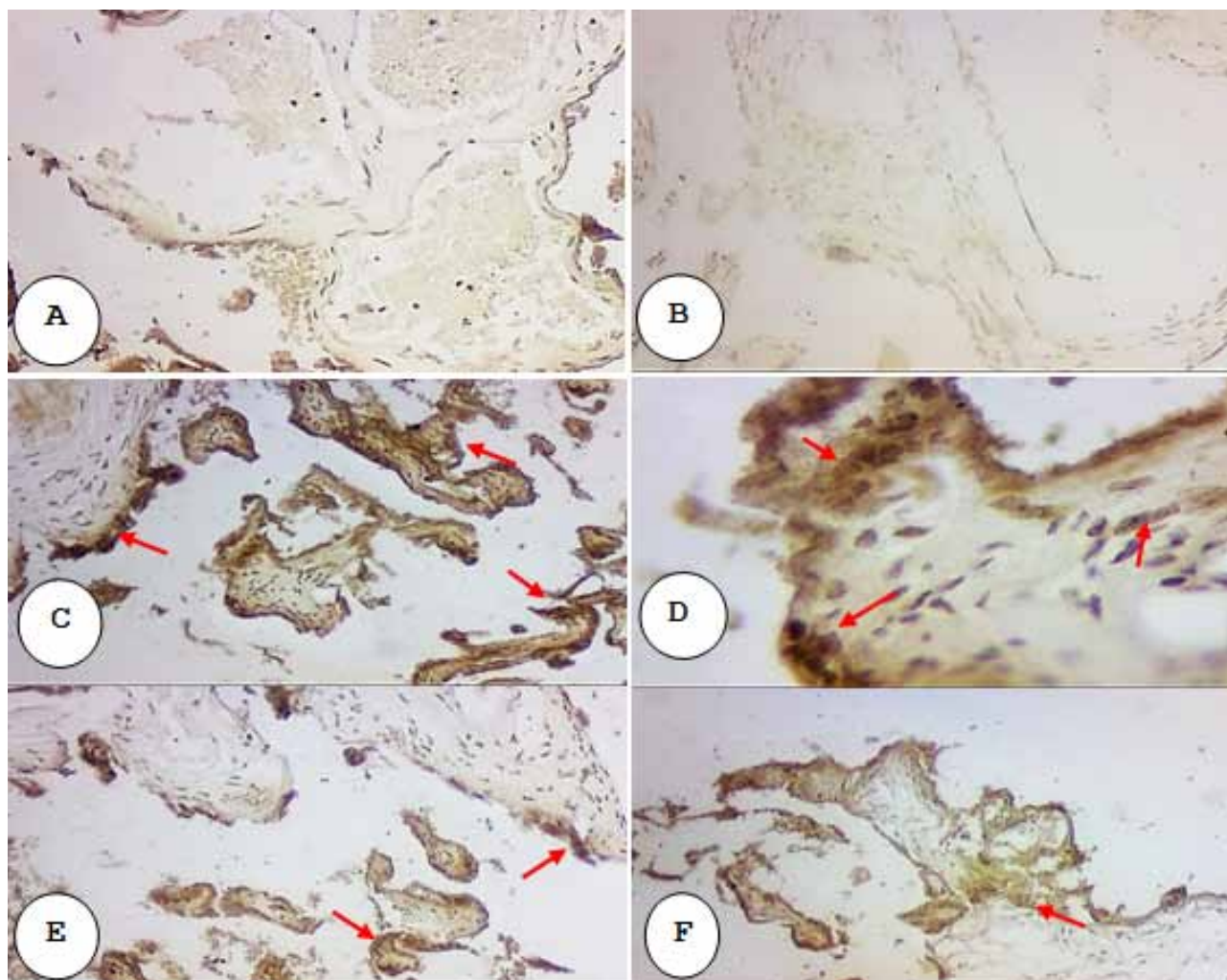
Histological finding	Normoglycemic group N=20 (%)	GDM group N=40 (%)	P-Value
Cytotrophoblastic cell hyperplasia	2 (10 %)	26 (65 %)	0.01
Fibrinoid deposition	4 (20 %)	21 (52.5 %)	0.01
Hypo-vascular villi	3 (15 %)	13 (32.5 %)	0.01
Atherosclerosis of uteroplacental vessels	1 (5 %)	16 (40 %)	0.01



**Figure (2): Light microscopical appearance of GDM placenta showing, (A):Villous oedema (B):stromal fibrosis (red arrows), (C):Syncytial knots (red arrows), (D):Fibrinoid deposition (black arrows), (E):Hypo-vascular villi (red arrows), (F):Atherosclerosis of uteroplacental vessels (A & B:H & E X10).**

**B-Enzyme histochemical of Glucose – 6 - phosphatase:** The placental tissues acquired from normoglycemic women or other maternal disorders exhibiting a weak reaction to the enzyme G-6-Pase (Fig. 3A & B). The villous stroma showed more dense activity to the G-6-Pase (Fig. 3C & D), while the trophoblastic showed moderate activity to G-6-Pase in the placental tissue of GDM pregnancy (Fig. 3E & F). The G-6-Pase plays the important role of supporting glucose during starvation, an enzyme product mainly in the kidney and the <sup>18</sup>. The moderate reactive with normoglycemic proof that it presents in the placenta and this was in a match with

other studies that detect the G-6-Pase histochemically in the syncytiotrophoblasts of the placenta<sup>19</sup>. In our study we found that there is a strong activity of the enzyme in hyperglycemic tissue, the previous result confirms that by documentation 2-3fold increasing the activity of G-6-Pase in the liver of diabetic<sup>20</sup>. G-6-Pase is an enzyme that analysis Glucose 6-phosphate, lead to the formation of a free glucose and phosphate group.<sup>21</sup> When the activity of G-6-Pase increases, free glucose also increases and our results from the increased blood sugar in hyperglycemic pregnancy supporting these results.



**Figure (3): The light microscopical appearance of placental tissue: A & B obtained from normoglycemic showing a weak reaction to the G-6-Pase (arrows), C & D: strong reaction to the G-6-Pase in syncytiotrophoblast (red arrows) and cytotrophoblast cells, E & F: moderate reaction to the G-6-Pase, in placenta GDM(G-6-Pase, X10).**

**C-Biochemical study:** The serum level of glucose for both healthy pregnant women and GDM pregnancy is shown in (Table -2). A significant ( $p < 0.05$ ) increase is found in the mean value of the glucose in GDM pregnancy ( $173.82 \pm 2.47$  mg/dl) compared with that of the healthy pregnancy ( $84.04 \pm 2.3$  mg/dl).

High glucose or diabetes during pregnancy may be caused by a decrease or resistance to the hormone insulin by placenta hormones such as progesterone or human placental lactogen, or as a result of the increase in the secretion of the hormone cortisol that occurs during pregnancy<sup>(22,23)</sup>. Jansson et al<sup>24</sup> showed that the high level of glucose from its normal level leads to an increase in its transmission to the placenta. Also, the imbalances

in carbohydrate metabolism during pregnancy lead to many complications for the mother<sup>25</sup>.

While the serum cholesterol level is found to be significantly ( $p < 0.05$ ) increased in the mean of GDM pregnancy when compared with that of a healthy pregnancy. Table (2) showed the mean of GDM pregnancy to be ( $224.50 \pm 7.68$  mg/dl), while in a healthy pregnancy is ( $184.80 \pm 4.34$  mg/dl). The increase of total cholesterol level in the serum of women with GDM in the current study supports the results study of Quinlivan and Lam<sup>26</sup>, and its rise can be attributed to the occurrence of a disorder of fat metabolism ((Dyslipidemia) as a result of the disease<sup>27</sup>. Several studies have shown approaches during the and beyond the pregnancy, adverse metabolic consequences of diabetes<sup>28</sup>.



Recently, the high levels of cholesterol can cause atherosclerosis, research has shown that low density lipoprotein cholesterol LDL-C is not the only type of cholesterol that increases the risk of atherosclerosis, and that any non-HDL-C cholesterol, such as very-low-density lipoprotein cholesterol (VLDL-C) and apolipoprotein B, that increase that risk<sup>29</sup>. Study of Ryckman et al<sup>30</sup> found that women with previous GDM Insulin resistance elevate the VLDL-C abnormalities contained in non-high-density lipoprotein cholesterol (HDL-C) along with (LDL-C) and lipoprotein of intermediate density.

Recently, blood urea has been documented to be associated with diabetes mellitus (DM), commonly regarded as one of the markers of kidney functions<sup>31</sup>. On the one hand, (DM) cause kidney disease, and on

the other hand, kidney disease may increase the risk of (DM), including urea or other uraemic elements<sup>32,33</sup>. Our result showed the level of serum urea shows an increase in GDM pregnancy as compared with a healthy pregnancy, (Table 2). The mean value of serum urea in GDM pregnancy is found to be (28.12±1.06 mg/dl), and in a healthy pregnancy is (21.5±1.2 mg/dl). Statistically, there is a significant (p<0.05) difference between the two groups.

This result is consistent with many researchers who indicated that the GDM condition leads to a rise in the level of urea in the blood serum, and this rise is due to the physiological change as a result of the pathological condition which leads to a decrease in the rate of glomerular filtration rate (GFR). This causes a rise in the level of urea in the blood serum<sup>34,35</sup>.

**Table 2: Serum Glucose, Cholesterol and Urea level in GDM and Normoglycemic women.**

Study Groups	Glucose (mg/dl)	Cholesterol (mg/dl)	Urea (mg/dl)
Pregnant women with GDM	173.82±2.47	224.50±7.68	28.12±1.06
Normoglycemic women	84.04±2.3	184.80±4.34	21.5±1.2

## Conclusions

The hyperglycemia during pregnancy leads to the serious histological changes in placenta representing by oedema in stromal villi, fibrinoid deposition, hypovascular, atherosclerosis of uteroplacental arteries. The villous stroma showed more dense activity to the G-6-P enzyme that indicates to increase the sugar content in it and the study found a strong relationship between hyperglycemia during pregnancy and the rise of serum cholesterol and urea in blood serum.

**Ethical Clearance:** This study was agreed by the Ethics and Research Committee of the Baghdad Teaching Hospital, Medical city, Baghdad, Iraq.

**Source of Funding:** This research was not funded by association.

**Conflict of Interest:** None

## References

- Michelle C, Michael P, Clyde R, Gernot D, Martha L. Defective insulin signalling in placenta from pregnancies complicated by gestational diabetes mellitus. *European Journal of Endocrinology*. 2009; 160: 567–578.
- Qazi A, Amin F, Aneela Q, and Mazhar ul H. Gestational diabetes mellitus; still a great problem. *Professional Med J*. 2016;23(1): 015-019.
- Barke TL, Goldstein JA, Sundermann AC, Reddy AP, Linder JE, Correa H, Velez-Edwards DR, and Aronoff DM. Gestational diabetes mellitus is associated with increased CD163 expression and iron storage in the placenta. *Am J Reprod Immunol*. 2018; 80(4): e13020. doi:10.1111/aji.13020.
- Plows JF, Stanley JL, Baker PN, Reynolds CM and Vickers MH. The Pathophysiology of Gestational Diabetes Mellitus. *Int. J. Mol. Sci*. 2018, 19, 3342
- Martino J, Sebert S, Segura MT, García-Valdés L, Florido J, Padilla MC, Marcos A, Rueda R, Mc Ardle HJ and Budge H, Symonds ME, and Campoy C. Maternal Body Weight and Gestational Diabetes Differentially Influence Placental and Pregnancy Outcomes. *J Clin Endocrinol Metab*, January 2016, 101(1):59–68. doi: 10.1210/jc.2015-2590.
- El Sawy, N.A. Iqbal, MS and Alkushi, AG.

- Histomorphological Study of Placenta in Gestational Diabetes Mellitus. *Int. J. Morphol.*, 2018; 36(2):687-692.
7. Castillo-Castrejon M, and Powell TL. Placental nutrient Transport in Gestational Diabetic Pregnancies. *Frontiers in Endocrinology*. 2017; 8 : Article 306. doi: 10.3389/fendo.2017.00306.
  8. Desoye G and Hauguel-de Mouzon SH. The Human Placenta in Gestational Diabetes Mellitus. *Diabetes care*, 2007;30(Supplement2): 5120-5126.
  9. Mejia JF, Hirschi KM, Tsai KYF, Long MG, Tullis BC, Eliza E. K. BitterEEK, et al. Differential placental ceramide levels during gestational diabetes mellitus (GDM). *Reproductive Biology and Endocrinology* (2019) 17:81. <https://doi.org/10.1186/s12958-019-0523-6>
  10. Suvaran SK, Layton C and Bancroft JD. Bancroft's theory and practice of histological techniques. Eight edition, Churchill livingstone Elsevier. 2019.
  11. Vacca, L.L. Laboratory manual of histochemistry. Raven press books, Ltd:1985: 308-310.
  12. Tewari V, Tewari A and Bhardwaj N. Histological and histochemical changes in placenta of diabetic pregnant females and its comparison with normal placenta. *Asian Pacific Journal of Tropical Disease*. 2011; 1(1): 1-4
  13. Meng Q, Shao L, Luo X, Mu Y, Xu W, Gao C, Gao L, Liu J, and Cui Y. Ultrastructure of Placenta of Gravidas with Gestational Diabetes Mellitus. *Obstet Gynecol Int*. Volume 2015, Article ID 283124, 9 pages <http://dx.doi.org/10.1155/2015/283124>
  14. Fogarty NME, Ferguson-Smith AC and Burton GJ. Syncytial Knots (Tenney-Parker Changes) in the Human Placenta: Evidence of Loss of Transcriptional Activity and Oxidative Damage. *The American Journal of Pathology*. 2013;183(1):144-152.
  15. Aires MB and Veríssimo dos Santos AC. Effects of maternal diabetes on trophoblast cells. *World J Diabetes*. 2015; 6(2): 338-344.
  16. Jirkovská M, Kučera T, Kaláb J, Jadrníček M, Niedobová V, Janáčková J, Kubínová L, Moravcová M, Zizka Z, Krejčí V. The branching pattern of villous capillaries and structural changes of placental terminal villi in type 1 diabetes mellitus. *Placenta*. 2012; 33(5):343-351.
  17. Morales CML, Zurita ORB, Heredia RG, Miguel Cruz López MC, Araceli Méndez Padrón AM, Juan Antonio Matute Briseño JAM. Placental atherosclerosis and markers of endothelial dysfunction in infants born to mothers with gestational diabetes] *Med Clin (Barc)*. 2016;147(3):95-100.
  18. Van Schaftingen E and Isabelle Gerin I. The glucose-6-phosphatase system. *Biochem. J*. 2002; 362, 513-532 (Printed in Great Britain).
  19. Matsubara, S., Takizawa, T. and Sato, I. Glucose-6-phosphatase is present in normal and pre-eclamptic placental trophoblasts : ultrastructural enzyme histochemical evidence. *Placenta* 1999;20: 81-85
  20. Arion, W. J. and Nordlie, R. C. Liver glucose-6-phosphatase and pyrophosphate-glucose phosphotransferase : effects of fasting. *Biochem. Biophys. Res. Commun*. 1965; 20, 606-610
  21. Ghosh A, Shieh JJ, Pan CJ, Sun MS, Chou JY. The catalytic center of glucose-6-phosphatase. HIS176 is the nucleophile forming the phosphohistidine-enzyme intermediate during catalysis. *The Journal of Biological Chemistry*. 2002; 277 (36): 32837-42. doi:10.1074/jbc.M201853200. PMID 12093795
  22. Newbern D and Freemark M. Placental hormones and the control of maternal metabolism and fetal growth. *Curr Opin Endocrinol Diabetes Obes*. (2011);18:409-16.
  23. Drife, J. and Magowan, B. Medical disorders in pregnancy. In: *Clinical Obstet & gynecol*. 2004; pp:327- 329.
  24. Jansson, T.; Strand, Y.K.; Wennergren, M. and Powell, T. (2001). Placental glucose transport in gestational diabetes mellitus. *Am. J. Obstet. Gynecol*;184(2): 111-16.
  25. Graf-Schaefer, V.M.; Buchanan, T.A.; Xiang, A. Patterns of congenital anomalies and relationship to initial maternal fasting glucose levels in pregnancies complication by type 2 and gestational diabetes. *Am. J. Obstet. Gynecol*. (2000);182(2): 313- 320.
  26. Quinlivan, JA and Lam, D. Cholesterol Abnormalities are Common in Women with Prior Gestational Diabetes. *Journal of Diabetes and Metabolism*. 2013;4 (4):1-4.
  27. Schaefer-Graf UM, Meitzner K, Ortega-Senovilla H, Graf K, Vetter K, Abou-Dakn M, et al. Differences in the implications of maternal lipids on fetal metabolism and growth between gestational diabetes mellitus and control pregnancies. *Diabet*

- Med. 2011;28:1053–9.60.
- 28- Quinlivan JA, Julania S, Lam L . Antenatal dietary interventions in obese pregnant women to restrict gestational weight gain to Institute of Medicine recommendations: a meta-analysis. *Obstet Gynecol.*(2011);118: 1395-1401.
  29. Robinson JG, Wang S, Jacobson TA. Meta-analysis of comparison of effectiveness of lowering apolipoprotein B versus low-density lipoprotein cholesterol and nonhigh-density lipoprotein cholesterol for cardiovascular risk reduction in randomized trials. *Am J Cardiol* 2012;110:1468–76.
  30. Ryckman, KK, Spracklen, CN, Smith, CJ, Robinson,JG and Saftlas, AF. Maternal lipid levels during pregnancy and gestational diabetes: a systematic review and meta-analysis. *BJOG* 2015; 122:643–651.
  31. Xie Y, Bowe B, Li T, Xian H, Yan Y, Al-Aly Z. Higher blood urea nitrogen is associated with increased risk of incident diabetes mellitus. *Kidney Int.* 2018;93:741-752.
  32. Allison SJ. Diabetes: urea inhibits insulin secretion in CKD. *Nat Rev Nephrol.* 2016;12:581.
  33. Feng P,Guangli W,Qian Y, Wei Z and Chongke Z. First-trimester blood urea nitrogen and risk of gestational diabetes mellitus.*J Cell Mol Med.* 2020;24:2416–2422.
  34. Beharier O, Shoham-Vardi I, Pariente G, Ruslan S,Roy K, Yael B, et al. Gestational diabetes mellitus is a significant risk factor for long-term maternal renal disease. *J Clin Endocrinol Metab* 2015;100:1412–1416.
  35. Rawal S, Sjurdur F O, Louise G G, Ronald CM, Stefanie NH, Charlotta G, et al. Gestational Diabetes Mellitus and Renal Function: A Prospective Study with 9- to 16-Year Follow-up After Pregnancy. *Diabetes Care.* 2018;41:1378–1384.

# Subjective Assessment of Satisfaction Degree and Psychosocial Status of Patients with Highly Atrophic Mandible Treated by Implant-retained Over-denture

Salah A. Al Omoush<sup>1</sup>, Wijdan R. El Manaseer<sup>2</sup>, Firas Al Soleihat<sup>3</sup>, Kifah D Jamani<sup>4</sup>

<sup>1</sup>Assoc. Prof. BDS. MSc–Pros. PhD., <sup>2</sup>Assis. Prof. DDS. MS–Pros. PhD., <sup>3</sup>Prof. BDS. PhD., Department of Conservative Dentistry, School of Dentistry, the University of Jordan, Amman 11842, Jordan, <sup>4</sup>Prof. BDS. PhD., Department of Prosthodontics, School of Dentistry, the University of Jordan, Amman 11842, Jordan

## Abstract

This study aimed at assessing patient's satisfaction with new optimized conventional complete upper and lower dentures as compared to their previous problematic conventional dentures. A random sample of patients was selected (group 1). Each patient was provided with new optimized conventional upper and lower dentures (group 2), then a subset who were not satisfied with the optimized lower prostheses were provided with two implant-retained lower over-dentures (group 3). Self-assessment questionnaires were voluntarily filled by the participants. Male-female differences were assessed using the two independent samples t-test. Inter-group differences were evaluated using the two dependent samples t-test. Significant differences were found between sexes in group 2, but not in group 3, in the direction of females being less satisfied than males especially with the lower denture, and between the groups in a number of variables in the direction of more satisfaction with the lower dentures among group 3 as compared to group 2. Meanwhile, group 2 and 3 were found to be equally satisfied with the upper denture.

**Keywords:** Patient's satisfaction; conventional complete denture; optimized conventional complete denture; two implant retained lower over-denture; atrophic edentulous mandibular ridge

## Introduction

In most societies, the need for complete dentures is increasing due to edentulism. Although, implant-retained overdentures may be considered the best option in the rehabilitation of edentulous individuals, conventionally made complete dentures will remain an important treatment option in the oral health care for the growing elderly population due to economic reasons<sup>[1,2]</sup>. Residual ridge resorption is a complex biophysical process<sup>[3, 4]</sup>. More pronounced resorption happen in the

mandible than maxilla with an average rate of 0.2 mm annually<sup>[5-8]</sup>.

Treating with atrophied ridges poses a clinical challenge to dentists that associated with unpleasant appearance, pain and discomfort as a result of unstable and non-retentive dentures<sup>[3, 6, 9-11]</sup>.

Clinical experience and dental research reported various problems associated with edentulism<sup>[12-14]</sup>. To improve health care quality, patient perceptions are crucial, therefore, assessment and treatment outcomes are very important<sup>[15]</sup>. As well as complete dentures therapy<sup>[16-19]</sup>.

Two main method have been used to assess and evaluate the acceptance of dental prostheses. The first method is objective assessment of masticatory function and speech articulation<sup>[20-23]</sup>. The second method is by evaluation of patient's perception of treatment by self-assessment tools (questionnaires)<sup>[24]</sup>.

---

### Corresponding Author:

**Firas Alsoleihat**

**Address:** Professor, Department of Conservative Dentistry, School of Dentistry, the University of Jordan, Amman 11842, Jordan

e-mail: [firas.alsoleihat@ju.edu.jo](mailto:firas.alsoleihat@ju.edu.jo)

Mobile Number: +962772690096

Edentulous patients showed a moderate level of satisfaction<sup>[25-27]</sup>. For instance, 3% to 40% of patients were reported to be unable to adapt to their dentures among removable partial dentures wearers 2, 28. Patient satisfaction with complete dentures seems to be a complex socio-cultural issues<sup>[29]</sup>. Denture quality showed controversial impact on satisfaction. Some authors have observed that most of denture quality criteria do not correlate with patient satisfaction<sup>[30,31]</sup>. In another study<sup>[32]</sup> patients were satisfied despite technical problems, but satisfaction increased as denture quality improved, mainly regarding retention and stability. Other studies firmly presented a strong correlation between denture quality and patient satisfaction<sup>[33, 34]</sup>.

Patient satisfaction with implant retained complete dentures has also been evaluated by subjective and objective method. For example, satisfaction with mandibular implant-retained over-dentures, retained by ITI<sup>®</sup> dental implants, was assessed subjectively for six years of use. It was reported that an extremely high proportion (95%) were satisfied with their new prostheses with respect to function, comfort and social rehabilitation<sup>[36]</sup>. In a multi-center study, Boerrigter et al.<sup>[37]</sup> carried out a comparative investigation using self-assessment questionnaires in two groups of 150 patients who had long-standing mandibular denture problems. Patients in the first group were treated with mandibular over-dentures retained by two implant fixtures, opposed by optimized maxillary complete dentures. Patients in the second group were provided with new optimized complete dentures in both jaws, as a control group. It was reported that patients treated with implant-retained over-dentures appeared to be more satisfied than the control group, and this was reflected in the overall satisfaction with denture function, aesthetics, comfort and speech. While it was reported that in general terms more than half of the control group was satisfied with the new conventional dentures, it appeared that only a small number of patients were satisfied with the conventional mandibular dentures.

## Materials and Method

The study sample consisted (12 females and 18 males) aged between 35 and 75 years, and with a mean age of 60.1 years (SD = 8.4).

Before starting examining the patients, all ethical approval that acquired were signed. Patients then were examined thoroughly and their complaints were recorded

and classified according to Cawood and Howell<sup>[38]</sup> as demonstrated in (Table 1).

Upon clinical examination, they approved to be subjected to preprosthetic surgery. All the pre-prosthetic procedures in form of alveoloplasty were carried out for the five patients. ADMIX technique advocated by McCord and Tyson<sup>[35]</sup> was used.

After three months of using the new dentures, four of the patients were satisfied with their optimized lower dentures in conjunction with the usage of denture adhesive glue (SUPER COREGA-Ireland)<sup>[26]</sup>.

Three months after later, patients were again asked about their opinions with respect to masticatory function, using the same questionnaire where a comparison was made between the optimized conventional dentures and the implant-retained mandibular over-dentures. The same self-assessment questionnaire was filled by all patients to compare if any significant changes were improved in comparison with optimized conventional dentures (Table 2).

Statistical differences between males and females in the variables considered were examined by the two independent samples *t*-test, and the differences between the groups were assessed using the two dependent samples *t*-test (SPSS, Version 17.0, Inc., Chicago, IL). The 0.05 level was chosen as the threshold value for statistical significance.

**Findings:** No statistically significant differences were found between males and females in the average overall satisfaction with the lower dentures between group 2 and 3, and with upper dentures between group 2. Although there was a relative difference, the level of satisfaction differs after 3 months between Males and females.

There were no statistically significant differences between the sexes between the third group with regard to all responses to the questionnaire questions. However, significant differences were found between males and females between Group 2 in the mean scores for responses to a number of specific questions asked in the questionnaire.

The two-sample *t*-test showed that there was no significant difference in the mean overall satisfaction with the upper denture between Group 2 and Group 3. The mean overall satisfaction with the lower teeth

was significantly higher between Group 3 compared to Group 2.

It was found that the average degree of abstinence from wearing upper dentures was zero in groups 2 and 3.

Average scores were found for the following variables: abstinence from wearing lower dentures, refusal to participate in social activities, and negative

impact on self-confidence - significantly lower among group 3 compared to group 2.

Median scores for the following variables: pain from wearing a lower denture, slipping of the lower denture while eating, problems with speech, chewing problems, and a denture being considered a foreign body were significantly higher among Group 2 compared to Group 3.

**Table 1: Descriptive data about the participants of the study.**

Level of education (n)	Duration of edentulism (n)	Shape of the residual ridge (n)			No. of previous dentures (n)		Fabricated by (n)		Faults found in the old CD/s (n)
		Upper	Lower		< 3 sets	(n)	GP	(n)	
Illiterate (5)	< 5 yrs (3)		Upper	Lower	< 3 sets	(10)	GP	(25)	No post-dam (5)
School (15)	5-10 yrs (7)	Well-developed	(28)	-	> 3 sets	(20)	DT	(5)	Peripheral Under-extended (15)
College (7)	10-15 yrs (15)	Moderately resorped	(2)	(10)			-	-	Centric off (5)
University (3)	> 15 yrs (5)	Severely resorped	-	(20)					

CD = complete denture; GP = General Practitioner; DT = Dental Technician.

**Table 2: Response to questions concerning oral functions of dentures before and after treatment.**

Questions	Variables	Optimized (n out of 30)				Implant-OD (n out of 26)			
		0	1	2	3	0	1	2	3
Scale (0-3)									
Did you wear your dentures all the time?	UD LD	30 -	- -	- 10	- 20	26 26	- -	- -	- -
Does your lower denture cause pain?		-	5	23	2	26	--	-	-
Does your lower denture slip while eating?		-	8	18	4	26	-	-	-
Does your lower denture cause speech problem?		-	14	15	1	26	-	-	-
Do you have chewing problem with your dentures?		-	6	14	10	23	2	-	-
Did you refuse social invitations because of dentures?	Male Female	- -	5 -	13 5	- 7	16 -	- 2	- -	- -
Does the denture affect your self-confidence?	Male Female	- -	5 -	13 5	- 7	16 -	- 2	- -	- -
Do you consider the denture part of your body?		-			30	26	-	-	-
Overall satisfaction (Scale 0-10)	UD LD	> 5 = (30) >5 = (4) <5 = (20) 5 = (6)				> 5 = (26) > 5 = (26)			
Will you do the surgery again?		90-95% (yes)							

OD = over-denture; UD = upper denture; LD = lower denture.

## Discussion

The ultimate goal is patient satisfaction<sup>2</sup>. Therefore, restoring mandibular function is crucial. Male-female differences has been previously studied<sup>[39]</sup>. It has been suggested that females report pain symptoms, and they recall health problems to more than males do<sup>[40]</sup>. This study revealed no differences between males and females satisfaction with either the upper or the lower dentures among group 2. However, the satisfaction level was greater in males and the difference was almost approaching statistical significance in the case of the upper denture among group 2. Regarding group 3 upper denture, males were significantly more satisfied than females.

Significant Male-female differences among group 2 were found in a number of the mean scores for the responses to the specific questions asked in the questionnaire, where females showed significantly more refusal of engagement into social activities and adverse impact on self-confidence. On the other hand, in another study, both male and female edentulous patients were well-satisfied with their social ability after wearing the prosthesis<sup>[41]</sup>. Few studies investigating oral prostheses have reported sex differences. Moroi and Coworkers studied the effect of oral prostheses on the quality of life of head and neck cancer patients, and they reported that in both a cancer group wearing maxillofacial prostheses, as well as in a control group wearing conventional dentures, females rated most variables lower than the males<sup>[42]</sup>. In a study by Panek et al, found that males could adapt more easily to new removable partial dentures than females. The need for “three and more visits for adjustment after delivery” was found to be significantly more common among females than males<sup>[43]</sup>. In another study, elderly females were less satisfied with conventional dentures than elderly males with regards to aesthetics and ability to chew, but equally satisfied with implant over-dentures<sup>[44]</sup>. The quality of satisfaction has been found that males were more satisfied than females. There was equal satisfaction level in comfort and social status of both the groups<sup>[45]</sup>. Females and males differences in perceptions could be explained by either physical or psychological differences between the sexes. It has been suggested that variety of factors may contribute, including hormonal alterations<sup>[46]</sup>, blood pressure<sup>[47]</sup>, and psychological factors<sup>[48]</sup>. Furthermore, sex role expectancies and anxiety may moderate sex differences<sup>[48]</sup>.

Several long-term studies have confirmed that implant-retained dentures provide satisfactory results with only two implants in the lower jaw<sup>[49-51]</sup>. Therefore conventional dental treatment is not considered the standard of care<sup>[52,53]</sup>. In this study, the level of satisfaction was greater, with lower dental implant retention among group 3 than the optimal conventional denture among group 2.

Refraining from wearing the lower denture, refusal of engagement into social activities, and the adverse impact on self-confidence were found to be significantly lower among group 3 as compared to group 2. Kutkut et al.<sup>[54]</sup> in a systematic review stated the same; treating conventional complete denture wearers with implants to retain their dentures led to obvious improvements of patients’ satisfaction with their oral status as measured by questionnaires and interviews. In the majority of the studies, implant-retained over-dentures were superior to conventional complete dentures with regards to efficacy, satisfaction, and quality of life<sup>[49-53]</sup>.

## Conclusion

Within the limitations of the present study, it can be concluded that two-implant retained lower denture is the most satisfactory in case of severely atrophic edentulous mandibular ridge while the optimized upper complete denture provides adequate satisfaction for such patients without the need for dental implants.

**Conflict of Interest:** Nil.

**Source of Funding:** Self.

**Ethical Clearance:** Taken from institutional ethical committee.

**Acknowledgements:** The authors would like to express our deepest appreciation and sincere gratitude to all the participants in this study for their cooperation and understanding. This research was conducted at the School of Dentistry of the University of Jordan.

## References

1. Carlsson GE. Facts and fallacies: an evidence base for complete dentures. *Dent Update* 2006; 33:134-6, 138-40, 142.
2. Carlsson GE, Omar R. The future of complete dentures in oral rehabilitation. A critical review. *J Oral Rehabil* 2010; 37:143-56.
3. Wyatt CCL. The effect of prosthodontic treatment

- on alveolar bone loss: A review of the literature. *J Prosthet Dent* 1998; 80:362-6.
4. Whitmyer C, Esposito SJ, Alperin S. Longitudinal treatment of a severely atrophic mandible: a clinical report. *J Prosthet Dent* 2003;90:116-20.
  5. Atwood DA. Reduction of residual ridges: A major oral disease entity. *J Prosthet Dent* 1971; 26:266-79.
  6. Tallgren A. The continuing reduction of the residual alveolar ridges in complete denture wearers: a mixed-longitudinal study covering 25 years. *J Prosthet Dent* 1972; 27:120-32.
  7. Xie Q, Närhi TO, Nevalainen JM, Wolf J, Ainamo A. Oral status and prosthetic factors related to residual ridge resorption in elderly subjects. *Acta Odontol Scand* 1997; 55:306-13.
  8. Li, B. & Wang, Y. Contour changes in human alveolar bone following tooth extraction of the maxillary central incisor. *J Zhejiang Univ Sci B* 2014; 15:1064-71.
  9. Kelly E. Changes caused by a mandibular removable partial denture opposing a maxillary complete denture. *J Prosthet Dent* 1972; 27:140-50.
  10. Carlsson GE, Thilander H, Hedegard B. Histologic changes in the upper alveolar process after extractions with or without insertion of an immediate full denture. *Acta OdontolScand* 1967; 25:21-43.
  11. Kalk W, De Baat C. Some factors connected with alveolar bone resorption. *J Dent* 1989; 17:162-5.
  12. Turker SB, Sener ID, Özkan YK. Satisfaction of the complete denture wearers related to various factors. *Arch GerontolGeriatr* 2009; 49:e126-e129.
  13. Assuncao WG, Barao VA, Delben JA, Gomes EA, Tabata LF. A comparison of patient satisfaction between treatment with conventional complete dentures and overdentures in the elderly: a literature review. *Gerodontol* 2010; 27: 154-62.
  14. Emami E, Allison PJ, De Grandmont P, Rompre PH, Feine JS. 2010. Better oral health related quality of life: type of prosthesis or psychological robustness? *J Dent* 2010; 38:232-6.
  15. Siriwardena AN, Gillam S. 2014. Patient perspectives on quality. *Qual Prim Care* 2014; 22:11-5.
  16. Hassel AJ, Rolko C, Grossmann AC, Ohlmann B, Rammelsberg P. Correlations between self-ratings of denture function and oral health-related quality of life in different age groups. *Int J Prosthodont* 2007; 20:242-4.
  17. Michaud PL, De Grandmont P, Feine JS, Emami E. Measuring patient-based outcomes: is treatment satisfaction associated with oral health-related quality of life? *J Dent* 2012; 40:624-31.
  18. Stober T, Danner D, Lehmann F, Seche AC, Rammelsberg P, Hassel AJ. Association between patient satisfaction with complete dentures and oral health-related quality of life: two-year longitudinal assessment. *Clin Oral Investig* 2012; 16:313-8.
  19. Gjengedal H, Berg E, Boe OE, Trovik TA. Self-reported oral health and denture satisfaction in partially and completely edentulous patients. *Int J Prosthodont* 2011; 24:9-15.
  20. Devlin H, Wastell DG. The mechanical advantage of biting with the posterior teeth. *J Oral Rehabil* 1986; 13:607-10.
  21. Bohnenkamp DM, Garcia LT. Phonetics and tongue position to improve mandibular denture retention: a clinical report. *J Prosthet Dent* 2007; 98:344-7.
  22. Van der bilt A. Assessment of mastication with implications for oral rehabilitation: a review. *J Oral Rehabil* 2011; 38:754-80.
  23. Veyrone JL, Lassauzay C, Nicolas E, Peyron M-A, Woda A. Mastication of model products in complete denture wearers. *Arch oral biol* 2008; 52:1180-5.
  24. Abdul Fatah F, Yacob N, Ramli H, Mohammad N, Zahid DM, Salleh AZ, et al. Patient's perception towards cosmetic dentistry in relation to Islamic principle. *Adv Sci Lett* 2017; 23:4925-8.
  25. Wu JH, Yang YH, Wang CH, Lee HE, Du JK. Effects of denture maintenance on satisfaction levels of Taiwanese elderly using removable partial dentures: a pilot study. *Gerodontol* 2012; 29:e458-63.
  26. Bellini D, Dos Santos MB, De Paula PriscoDa Cunha V, Marchini L. Patients' expectations and satisfaction of complete denture therapy and correlation with locus of control. *J Oral Rehabil* 2009; 36:682-6.
  27. Gaspar MG, Dos Santos MB, Dos Santos JF, Marchini L. Correlation of previous experience, patient expectation and the number of post-delivery adjustments of complete dentures with patient satisfaction in a Brazilian population. *J Oral*



- Rehabil 2013; 40:590-4.
28. Mazurat NM, Mazurat RD. Discuss before fabricating: communicating the realities of partial denture therapy. Part I: patient expectations. *J Can Dent Assoc* 2003; 69:90-4.
  29. Marchini L. Patients' satisfaction with complete dentures: an update. *Braz Dent J* 2014; 17:5-16.
  30. Fenlon MR, Sherriff M. Investigation of new complete denture quality and patients' satisfaction with and use of dentures after two years. *J Dent* 2004; 32:327-33.
  31. Anastassiadou V, Robin Heath M. The effect of denture quality attributes on satisfaction and eating difficulties. *Gerodontology* 2006; 23:23-32.
  32. Costa APSD, Machado FCDA, Pereira ALBP, Carreiro ADFP, Ferreira MÂF. Qualidade técnica e satisfação relacionadas às próteses totais. *CiêncSaúdeColetiva* 2013; 18:453-60.
  33. Celebic A, Knezovic-Zlataric D, Papic M, Carek V, Baucic I, Stipetic J. Factors related to patient satisfaction with complete denture therapy. *J Gerontol Biol Sci Med Sci* 2003; 58:M948-53.
  34. Bilhan H, Erdogan O, Ergin S, Celik M, Ates G, Geckili O. Complication rates and patient satisfaction with removable dentures. *J Adv Prosthodont* 2012; 4:109-15.
  35. McCord JF, Tyson KW. A conservative prosthodontic option for the treatment of edentulous patients with atrophic (flat) mandibular ridges. *Br Dent J* 1997; 182:469-72.
  36. Geertman ME, van Waas MA, van't Hof MA, Kalk W. Denture satisfaction in a comparative study of implant-retained mandibular overdentures: a randomized clinical trial. *Int J Oral Maxillofac Implants* 1996; 11:194-200.
  37. Boerrigter EM, Stegenga B, Raghoobar GM, Boering G. Patient satisfaction and chewing ability with implant-retained mandibular overdentures: a comparison with new complete dentures with or without preprosthetic surgery. *J Oral Maxillofac Surg* 1995; 53:1167-73.
  38. Cawood JJ, Howell RA. A classification of the edentulous jaws. *Int J Oral Maxillofac Surg* 1988; 17:232-6.
  39. Berkley KJ. Sex differences in pain. *Behav Brain Sci* 1997; 20:371-80; discussion 435-513.
  40. Bingefors K, Isacson D. Epidemiology, co-morbidity, and impact on health-related quality of life of self-reported headache and musculoskeletal pain--a gender perspective. *Eur J Pain* 2004; 8:435-50.
  41. Seenivasan MK, Banu F, Inbarajan A, Natarajan P, Natarajan S, Anand Kumar V. The Effect of Complete Dentures on the Quality of Life of Edentulous Patients in the South Indian Population Based on Gender and Systemic Disease. *Cureus* 2019; 11:e4916.
  42. Moroi HH, Okimoto K, Terada Y. The effect of an oral prosthesis on the quality of life for head and neck cancer patients. *J Oral Rehabil* 1999; 26:265-73.
  43. Panek H, Krawczykowska H, Dobosz A, Napadlek P, Panek BA, Sosna-Gramza M. Follow-up visits as a measure of adaptation process to removable prostheses. *Gerodontology* 2006; 23:87-92.
  44. Pan S, Awad M, Thomason JM, Dufresne E, Kobayashi T, Kimoto S, et al. Sex differences in denture satisfaction. *J Dent* 2008; 36:301-8.
  45. Singh BP, Pradhan KN, Tripathi A, Tua R, Tripathi S. Effect of sociodemographic variables on complete denture satisfaction. *J Adv Prosthodont* 2012; 4:43-51.
  46. Kuba T, Quinones-Jenab V. The role of female gonadal hormones in behavioral sex differences in persistent and chronic pain: clinical versus preclinical studies. *Brain Res Bull* 2005; 66:179-88.
  47. Fillingim RB, Maixner W. The influence of resting blood pressure and gender on pain responses. *Psychosom Med* 1996; 58:326-32.
  48. Logan HL, Gedney JJ. Sex differences in the long-term stability of forehead cold pressor pain. *J Pain* 2004; 5:406-12.
  49. Meijer HJ, Raghoobar GM, van't Hof MA. Comparison of implant-retained mandibular overdentures and conventional complete dentures: a 10-year prospective study of clinical aspects and patient satisfaction. *Int J Oral Maxillofac Implants* 2003; 18:879-85.
  50. Meijer HJ, Raghoobar GM, Batenburg RH, Visser A, Vissink A. Mandibular overdentures supported by two or four endosseous implants: a 10-year clinical trial. *Clin Oral Implants Res* 2009; 20:722-8.
  51. Cune M, Burgers M, van Kampen F, de Putter C,

- van der Bilt A. Mandibular overdentures retained by two implants: 10-year results from a crossover clinical trial comparing ball-socket and bar-clip attachments. *Int J Prosthodont* 2010; 23:310-7.
52. Feine JS, Carlsson GE, Awad MA, Chehade A, Duncan WJ, Gizani S, et al. 2002. The McGill consensus statement on overdentures. Mandibular two-implant overdentures as first choice standard of care for edentulous patients. Montreal, Quebec, May 24-25, 2002. *Int J Oral Maxillofac Implants* 2002; 17:601-2.
53. Thomason JM, Feine J, Exley C, Moynihan P, Muller F, Naert I, et al. Mandibular two implant-supported overdentures as the first choice standard of care for edentulous patients--the York Consensus Statement. *Br Dent J* 2009; 207:185-6.
54. Kutkut A, Bertoli E, Frazer R, Pinto-Sinai G, Fuentealba Hidalgo R, Studts J. 2018. A systematic review of studies comparing conventional complete denture and implant retained overdenture. *J Prosthodont Res* 2018; 62:1-9.

# Valuable Dental Materials from *Salvadora Persica* Plants

Salah A. Jassim<sup>1</sup>, Kafa K. Hammud<sup>2</sup>, Bassam Alsheekhly<sup>3</sup>

<sup>1</sup>Professor, College of Dentistry, Al Iraqia University, Baghdad, Iraq, <sup>2</sup>Research Scholar, Directorate of Materials Research, Ministry of Science and Technology, Baghdad, Iraq, <sup>3</sup>Tutor, College of dentistry, Al Iraqia University, Baghdad, Iraq

## Abstract

Due to their popular uses, *Salvadora persica* (Miswak) plant possesses several bioactive effects and it is important to focus on their valuable effectiveness, especially on dental and oral health. The present review deals with many sections to obtain suitable knowledge about miswak such as chemical compositions, bioactivity, partitioning of active materials, method of obtaining miswak extract and the potent of this plant on dental and oral health according to their antioxidant, antifungal, antibacterial, antimicrobial, antiphlogistic, antimycotic, anticarcinogenic, anticandidal, anti-inflammatory and anti-plaque properties.

**Keywords:** *Miswak, Salvadora persica, compositions, bioactivity, dental.*

## Introduction:

*Salvadora persica L.* (Miswak) is a tree from *Salvadoraceae* family, *Mongnoliopsida* Class naturally grown in the Saudi Arabia, Iran, India, and parts of Africa and are spread to all Islamic countries. By World Health Organization (WHO), it is considered as a safe tool for oral tooth hygiene. It has several known names derived from "Miswak" word like siwak, sewak, miswak beside arak<sup>(1)</sup>.

Chewing sticks of *Salvadora persica* have different names in different languages, such as miswak, mastic, koyoji, in Arabic, Latin and Japanese languages respectively<sup>(2)</sup>.

Miswak is a natural plant widespread and used as an effective oral hygiene tool depending on its chemical, medicinal, and mechanical characters<sup>(3,4,5)</sup>. Miswaq, arak or chewing sticks are different synonyms for a plant which was used before 7000 years ago by Babylonians,

then Roman and Greeks followed by ancient Egyptians and millions of Muslims all over the world<sup>(6)</sup>.

Active components in Miswak plant parts<sup>(1,7)</sup> are varied in their chemical formula, structure, concentration, action, extraction method, and others. They may be organic or inorganic, charged or neutral, water- or fat-soluble.

Miswak has antioxidant, antifungal, antibacterial, anti-inflammatory effects and it possesses anti-plaque properties<sup>(8,9,10,11,12,13)</sup>.

**Summary from chemical, biological, and pharmaceutical notes:** Extract of miswak exerts important medicinal activities depending on its chemical contents. It contains benzyl isothiocyanate, alkaloids, tannins, glycosides, terpenes, flavonoids, fatty acids, silicon, potassium, sodium, calcium, magnesium, manganese, phosphorus, fluorine, sulfur, and others (Figure 1). These active components may be ranged in their concentration reflecting environmental impacts on any plant especially natural one<sup>(1,14,15,16)</sup>.

Aqueous extract of its root, stem, or leaf has an effective inhibition impact on some bacteria ranged from low to moderate, but not high antimicrobial response<sup>(17,18,19,20)</sup> as a result of presence several organic and inorganic compounds<sup>(21,22,23)</sup>.

---

## Corresponding Author:

**Prof. Dr. Salah A. Jassim**

Professor, College of Dentistry, Al Iraqia University, Baghdad, Iraq

e-mail: drsalahalmula@gmail.com

Mobile: +9647714586076

Any plant part having various active components which are responsible of different influence upon specific biological problem<sup>(22,23,24,25)</sup>. Miswak used to treat diuretic, gastritis, anacylost-omiasis, gonorrhoea, inflamm-atory, hypolipidemic, anti-pyretic, ulcers caused by alcohol or psychological stress, and hypoglycemic. Lowering chol- esterol plasma or oral *Candidiasis* of patient with renal transplant situation can be achieved with miswak using. Also, it possesses other important agents to treat analgesic, malaria, alexiteric, astringent, leucoder- ma, scabies, venereal, and other diseases. Miswak applications are in general in dental hygiene but it showed a noticeable influence in viral resistance, wound healing, antiphlogistic, anastringent, and antimycotic activities, gingiva,-stimulation and depressant activity<sup>(1,26,27,28,29,30,31,32,33,34,35,36,37)</sup>.

Ahmad and Ahamed in their published article<sup>(28)</sup> reviewed miswak chemical contents and its actions in biological systems. Also, in this review<sup>(28)</sup> and other published papers researchers<sup>(25,27,30,32,34,36)</sup> ensured that miswak phytochemical contents varied from organic to inorganic materials with remarkable properties (Figure 1.). For example, they contain many elements support like silicon in the form of silicate providing the necessary strength to perform its mechanical action. Many fatty acids, polysaccharides, phenol and furan derivatives in lignins, thio- compounds, and sterols are presented in plants parts varied in their concentrations like palmitic acid, myristic acid, lauric acid, salvadoside, salvadoraside, salvadorine, trimethyl amine, sitosterol, liri dendrin, syringing, rutin, quercetin, different amide forms, ascorbic acid,  $\beta$ -sitosterol, mustard oil, tannins, saponins, beside high fluoride and chloride contents (Figure 1.)<sup>(25,27,30,32,34,36)</sup>. According to a published study, miswak root contains oil that may be obtained by steam distillation consisting of benzyl isothiocyanate as the major component beside flavonoids,  $\alpha$ -pinene, and limonene<sup>(21)</sup>. Essential oil of this plant currently under review had a major content of benzyl thiocyanate and benzyl nitrile with less than 7% of benzaldehyde, carvacrol, aniline and naphthalene. Here, ascorbic acid (vitamin C) with thio – compound and all plant active components present a defense wall against bleeding, plaque, gingival bleeding and inflammatory actions<sup>(29)</sup>.

Various studies showed the capability of miswak extract to form new composites having metal oxide or polymer with qualified properties differed from

the original material. The properties of the obtained composites may have a raise in chemical, physical, biological, or mechanical characters. Miswak extract is considered as an effective substance when mixed with other materials to produce homogenized nanocomposite, confirming that this step is an eco-friendly method with good results comparing with the absence of extract use<sup>(38,39)</sup>.

Benzyl thiocyanate abbrev- iated by BITC is the main component in miswak and other plants with various biological activities and according to <http://pubchem.ncbi.nlm.nih.gov/website>, BITC is used as food flavor with warning that it causes eye and respiratory irritation as a pure chemical.

**Bioactivity of miswak:** Evaluation of the biological effects of chemicals depend upon several factors such as chemical structure, biological target, concentration, physical conditions, pH, ...etc.

For example, thiocyanate, nitrate, sulfate, or chloride ion that found in Miswak<sup>(40)</sup> influenced oxygen, some amino acid or monosaccharide transport, phosphorylation. Bacteria or virus can be inhibited by several mechanisms including enzyme action on sulfhydryl group and this group can be reacted with hypothiocyanite – Hydrogen peroxide catalyzed by lactoperoxidase<sup>(41,42,43)</sup> as shown in Figure 2. Hypothiocyanite anion production may be increased or inhibited with the presence of plant extract like miswak extract to control acid production effect on tooth. These anions may be released during hydrolysis with variation in concentration in all plant parts<sup>(44)</sup>.

In biological systems, oxidation – reduction reaction may occur by the same starting materials with different products depending upon pH or enzyme. Glucosionlate group found in various plant families as a secondary products of metabolic pathways with three subgroups containing aliphatic  $\alpha$ - amino acids, glucose, and sulfur atom<sup>(44)</sup>.

Hydrolysis of this group is influenced by the pH factor producing nitrate, sulfate, and glucose at low pH while neutral condition give organic isothiocyanate compounds beside sulfate and glucose. Myrosinase enzyme catalyzes organic isothiocyanates to their alcohol and thiocyanate. These isothiocyanates act as signaling, anticarcinogenic, and detoxification molecules beside others biological actions<sup>(42,45,46,47,48,49)</sup>.

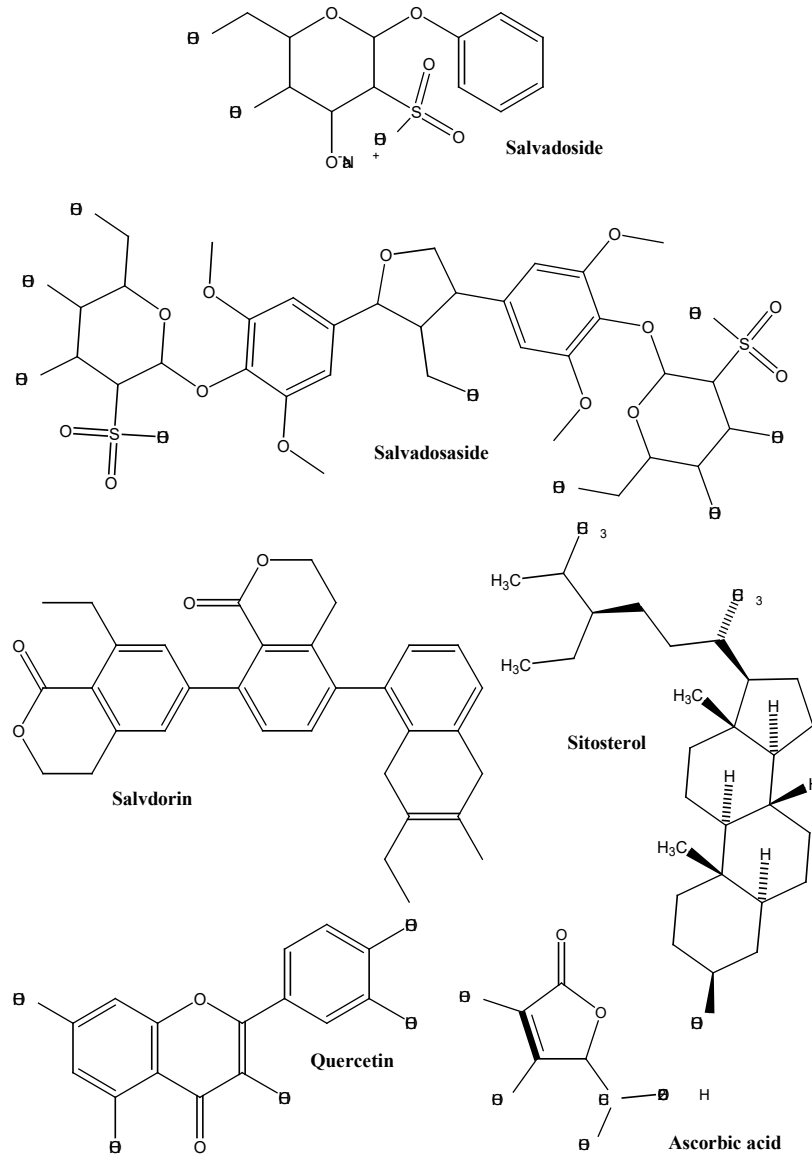


Figure 1. Chemical structures of several active components in miswak.

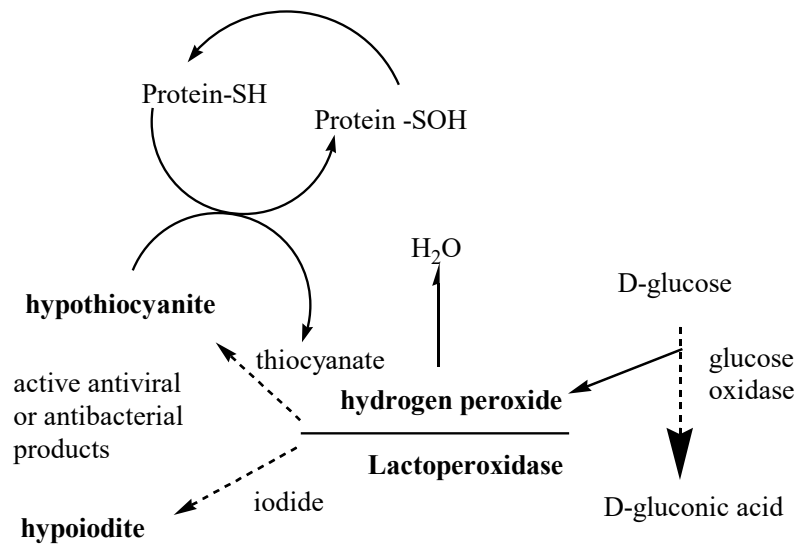


Figure 2. Antimicrobial products mechanism.

Nitrogen organic and inorganic components may be presented in any plant parts that may converted to another different compounds causing various effects depending upon their chemical structures and other factors. Oxidation – Reduction of nitrogen compounds like ammonia, urea, nitrate, nitrite, amino acid, peptide, protein, ... etc. may result in ecosystem antimicrobial activity<sup>(50,51,52)</sup>.

Organic and inorganic nitrogen – sulfur compounds in plants varied in their structures and functions in plants itself or in other biological systems<sup>(53,54,55,56,57)</sup>.

Thiocyanate is one of these active acidic component found in various biological systems by being a part of human or enter human body through daily intake plants or animal products<sup>(58)</sup>. This important metabolism product utilizes several important actions even with its low concentration in human tear (150µM), human breast milk (100 nM), while cow milk (170 µM) through its bacteriostatic function. Accumulation of it leads to biological toxicity that can be lowered by renal elimination in human. Thiocyanate- hydrogen peroxide system catalyzed by peroxidase enzyme produces the antimicrobial agent (hypothiocyanous acid, HOSCN) that crosses cell wall of bacteria then reacting with sulfhydryl (-SH), nitrogen, or selenium containing material to form (S-S), (S-O), (S-N), or (S-Se) bonds giving its antibacterial performance in many sites like oral cavity and saliva. This HOSCN may inhibit the growth of oral fungi or echovirus towards improving lung role<sup>(59,60,61,62,63,64)</sup>.

In general, thiocyanate is less toxic than cyanide (CN<sup>-</sup>) and it is eliminated by kidney. This toxicity did not prevent researchers from using thiocyanate as an oral under controlling dose to avoid sensitizing or suicide cases in Central Nervous, thyroid, skin, or renal system or any related toxicity of SCN<sup>-</sup> as a metabolite of cyanogenic drug, dietary, or smoking<sup>(65,66,67)</sup>.

Chlorine atom in its ionic form is another important micronutrient found in plant parts with biological importance even at low needed concentration<sup>(68)</sup>. It controls many activities in plant and other biological systems like electric charge balance, cell osmotic, enzyme, ionic, pH, and water regulations that contribute in other biological performances such as growth, ion – ion interchangeable operation, or disease resistance. Published articles confirmed that chloride ion can be replaced by other important anions (phosphate, sulfate,

or nitrate). This replacement is with important influence because chloride accumulation causes salt stress and toxicity, especially in plants and microbiological systems<sup>(69,70,71)</sup>.

The essential micronutrient (Cl<sup>-</sup>) can be found in almost biological systems as a consequence of high solubility of its salts in water towards various maintaining functions<sup>(51,72)</sup> such as catalytic protein or enzyme activator in plant or animal, controlling carbon dioxide concentration in cell, oxygen role in photosystem II or redox processes, energy production and consuming, fungicide treatment, and anion : cation balance.

Bio- data showed that chloride ion have a noticeable cell membrane crossing of different bio-systems and this transportation can be done in cooperation with necessary cations and/or anions. This collaboration produces nitrogen fixation, photosynthesis of organic or inorganic nitrogen compounds towards effective regulation or accumulation between acidic and basic compounds or ions depending on required and/or produced energy for each process. These cooperative processes raise some important bio-functions like plant growth and production of active components or macromolecules for example in plant tissues<sup>(70,71,73)</sup>.

In conclusion, all the mentioned activities of active components may be performed in the target bio-system or its production. So, these organic/inorganic active ingredients varied in their concentrations, extraction method, contributions with other ingredients, and applications. Their roles under question mainly based on structure, medium, and target. For example, chloride plays major role in cell expansion accompanied by other ions and organic molecules. Also, biological activity of any ingredient can be performed through enzyme catalysis that needs specific anion assistance. So, miswak have different active organic and inorganic compounds work together to achieve the biological actions.

**Partitioning of the important chemical components in miswak<sup>(74)</sup>:** Mohamed et al. (2018) was able to separate the active chemical compounds of miswak by cutting 1.1 kg of miswak roots to small pieces and treated them with alcoholic solvent (75% ethanol) by cold soaking. After filtration step, the filtrate was concentrated under reduced pressure to obtain brown residue. To the dried extracts, 200 mL distil water and 400 mL petroleum ether was added. The upper layer (petroleum ether) was introduced into silica gel column

and n-Hexane-Ethyl acetate was used to elute the two compounds. Fractionation of compounds was carried out using 5% and 7% acetonitrile in water ( $H_2O:CH_3CN$ ). Compound (3) was eluted by 5% and compound (4) eluted by 7%. The aqueous layer was treated with 150 mL 0.2N HCl and 300ml chloroform and shaken for 16 hrs. The chloroform layer was subjected to silica gel column and  $CHCl_3$ -MeOH was used as elution agent. 1% MeOH was used to elute compound (2) and 15% MeOH is suitable to elute compound (1).

Ammonium hydroxide was added to the aqueous layer until pH reach 11, then 400 mL of chloroform was added and mixed well.

Alkaloid Rich Fraction can be obtained by chloroform evaporation. After this fraction was subjected to column of silica gel, 78% MeOH in  $H_2O$  can elute compound (5), while compound (6) can be obtained by direct crystallization

From 1.1 kg of miswak roots, the above partition process can produce the following amounts:

8 mg sulphur-containing imidazoline alkaloid (*persicaline*) **compound (4)**.

13mg Benzyl-thiocarbamicacid-O-ethyl ester **compound (3)**.

30 mg hexadecanoic acid benzylamide **compound(1)**.

18 mg benzyl isothiocyanate **compound(2)**.

21 mg N-benzyl-2-phenylacet- amide **compound(5)**

7 mg Benzylurea **compound(6)**

**Literature review of the method of obtaining miswak extract:** The collected roots were washed, dried, and grinded to small size, followed by treating with 50% (v/v) ethanol in distill water by mixing the ratio of 1:10 root/solvent in dark space at 25C° for 24 hr, then filter paper (Whatman No. 1442) used to filter the solution twice. The liquid concentrated by vacuum rotary evaporator at high temp, to get a dark brownish miswak extract<sup>(75)</sup>.

Collected miswak were dried at the shade and then powdered by grinder to fine particles. Using soxhlet extractor, the powder was treated with different solvents such as methanol, ethanol and the mixture of both

solvents. After drying step, the extracts were weighed in DMSO for antibacterial activity purpose<sup>(76)</sup>.

Miswak were cutted into small pieces after washing step by distil water and kept 14 days at room temp. to be full dry. 100 g of dried miswak powder were mixed with either 1L of 95% methanol (as alcoholic solvent) or 1L distil water (as aqueous solvent). Filtration step were carried out using Whatman filter paper no, 1 and then the filtrates were concentrated using vacuum evaporator at 60 °C (for both water and alcoholic solvent). The extracts stored under -20 °C for the later use<sup>(77)</sup>.

By tap water, roots of miswak were washed and then (300-400) g in 1500 mL 80% ethanol were dissolved for 0.5 hr. at 80 °C. The filtration step was carried out using cotton wool. To be sure for complete extraction, the residue was dissolved again in 1 L of the same solvent for 5 min. using water bath at boiling point degree and kept overnight to be filtered again by a cotton wool. Both filterates (step 1 and 2) were mixed and concentrated by rotary evaporator at 40 °C. The produced extracts were stored at -80°C<sup>(78)</sup>.

After drying the miswak plants for 10 days at room temperature, they were cutted by Omni mixer to small parts. 20 grams of the dried powder were mixed with 100 mL of deionized water and kept to soak at 4°C for 24 hrs. and then centrifuged at low temperature (4°C) and then filter the supernatants by very small pore membrane (0.45 µm) membrane. finally, freezedried was carried out to get dry miswak.

Saleh et al. used different types of solvents such as acetone, ethanol, methanol (all were 80 percent in water) in addition to distilled water where percent of miswak to solvent was (1:10, wt/v). After filtration step, the extracts were concentrated by vacuum evaporator<sup>(79)</sup>.

Chevalier (2003) use modified procedure to obtain miswak extracts. After cutting the sticks of miswak to small pieces, food blender was used to ground the pieces to powder. Sterile hot distilled water was added to miswak powder with 1:10, wt/v (miswak:water) and left to sock at 37°C for 48 hrs. then the mixture was filtered by 0.45 µm pore filter paper. Drying of the extracts was established by incubation system at 37°C. The final extracts were stored at *sterilized* vials in refrigerator system<sup>(80)</sup>.

Firas et al. used soxhlet extractor to recover *Salvadora persica L.* by methanol solvent for 10 hrs.

The experiment still continued until the solvent became colorless. Rotary vacuum evaporator was used at 40 °C to concentrate the extracts and kept store until use<sup>(81)</sup>.

Darmani et al. mixed 1.5:10 w/v of miswak powder: sterile water for 48 hrs. at 4°C after drying the fresh sticks at room temperature for 2 days, (miswak powder was obtained using ball mill). The treated material was centrifuged and filtered by 0.45 µm pore filter paper<sup>(82)</sup>.

**Miswak as potent dental materials:** The *Salvadora persica* (the scientific name for Miswa) has great beneficial effects on the oral cavity, like the silica and sodium bicarbonate which are constituents of miswak, work as abrasive materials, reduce the tooth stains and improve its whiteness<sup>(83)</sup>.

Plaque and gingivitis usually reduce in Miswak users due to the “Tannic Acid” which is an astringing material<sup>(84,85)</sup>.

Other constituents can protect the tooth enamel by a layer of resin, while alkaloid has a bacteriocidal effect<sup>(86,87)</sup>, supported by sulfur present in *Salvadora persica*<sup>(88)</sup>.

Calculus formation usually inhibited by high concentration of chlorine<sup>(87)</sup>.

Inhibition of demineralization and promotion of remineralization is achieved due to the calcium saturation of saliva of Miswak users<sup>(89)</sup>.

Benzylisothiocyanate (BITC), one of the *S. Persica* root showed a virucidal activity specially against herpes simplex, also it can inhibit the growth of *Streptococcus mutans*, as many reports support its fungistatic action against *Candida albicans*<sup>(90,91,92)</sup>.

Depending on significant effects of Miswak extracts against the oral cavity pathogens, it is recommended to use Miswak as a dental hygiene method to prevent tooth caries.

High concentrations of Miswak extract works as good as chemical oral disinfectant (e.g. Triclosan and chlorhexidine) showing antibacterial actions<sup>(4,89,90,91,92,93,94)</sup>. Also Alcoholic and aqueous extract of *S. persica* showed anticandidal activity<sup>(93,95)</sup>.

Different investigations showed significant inhibition of the growth of different oral pathogens like *Candida albicans* and *actinomyces naeslundii*<sup>(91)</sup>.

Himawan H. et al. observed that Miswak is more potent than ordinary toothpaste in its ability to reduce the amount of plaque accumulation in fixed orthodontic. Two groups (20 patients for each group) were examined, 95% reduction in the plaque score was recorded when Miswak is used, against 65% reduction in the ordinary toothpaste<sup>(96)</sup>.

Almas K. studied the effect of miswak and Chlorahexidine Gluconate (CHX) on the removal efficiency of smear layer. He recorded that miswak was more potent than CHX to remove the layer. He also observed that dentinal tubules were more opened in both etched (periodontal and healthy dentin)<sup>(97)</sup>.

Organic acids are produced due to the fermentation of sucrose which is metabolized by biofilm bacteria resulting in decrease the plaque pH which causes dental caries according to Stephan curve. Lower pH can demineralize the enamel and cause caries. Because of strong taste of miswak, rinsing with its extract increases salivary flow and secretion from parotid gland which leads to raise the pH plaque after half hr. and prevents dental caries<sup>(98)</sup>.

Mixture of miswak (3.5%) and monofluorophosphate (0.8 %) enhance significantly the plaque reduction and improve the gingival index<sup>(99,100)</sup>.

## Conclusion

Miswak (as chewing sticks) is one of the most popular important herbs used for *good dental health due to its active chemical components which are considered the main keys of the potent bioactive properties that relate to its therapeutic characteristics*. Miswak is considered (by World Health Organization/WHO) as a safe tool for healthy tooth. Anti-plaque properties of miswak is very significant to prevent dental caries. Antioxidant, antiphlog- istic, anticarcinogenic, antifungal, antimicrobial, antibacterial, antimycotic, and anticandidal behaviors of miswak represent the real reasons of its therapeutic characteristics for oral tooth health.

**Conflict of Interest:** Nil

**Sources of Funding:** Self-funding.

**Ethical Clearance:** Not required



## References

- Ahmad H, Rajagopal. *Salvadora persica* L. (Miswak) in dental hygiene. *Saudi J Dent Res.* 2014; 5(2), 130-134.
- Mohammad M, and Saeed A. A review of the therapeutic effects of using miswak (*Salvadora Persica*) on oral health, *Saudi Med J.* 2015;36(5): 530–543.
- Hyson J. History of the toothbrush. *J Hist Dent.* 2003;51:73-80.
- AlOtaibi M, Batwa S, Bergstrom J, and Batwa M. The effectiveness of chewing stick miswak on plaque removal. *Saudi Dent J.* 2006;18(3):125-133.
- Darout I, Christy A, Skaug N, Egeberg P. Identification and quantification of some potentially antimicrobial anionic components in miswak extract. *Indian J.Pharmacol.* 2000; 32, 11-14.
- Chawla H.S. A new natural source for topical fluoride. *J Indian Dent Assoc.* 1983; 55:419-422.
- Albaptain R, Azeem M, Wondimu Z, Lindberg T, Karin A, and Gustafsson A. Investigations of a Possible Chemical Effect of *Salvadora persica* Chewing Sticks. *Evid. Based Complementary Altern. Med.* 2017; 2017:2576548. doi: 10.1155/2017/2576548.
- Bayan A, Ismail A, Chandraprabha M, Ahmed Al., Amr A. *Salvadora persica* (Miswak): Antioxidant and Promising Antiangiogenic Insights, *Am J Plant Sci,* 2018;9(6):1228-1244.
- Abhishek G., Shikhar V., Pradeep K., Sharad S., Rawat A., *Phytochemical and Antioxidant Studies of Salvadora persica* L. Stem & Twig. *Indian J Pharm Educ.* 2015;49(1):71-75.
- Fayez N, Mustafa N, Zohaib K, Muhammad S, and Khalid A. Role of *Salvadora persica* chewing stick (miswak): A natural toothbrush for holistic oral health. *Eur J Dent.* 2016;10(2):301–308.
- Jamal A, Khalid A, Siddique, A. A review on phytochemical and miswak (*Salvadora persica* Linn). *J Pharm Bioallied Sci.* 2011;3(1): 113-117.
- Saddiq A, Monagi H. Fungicidal Impact of *Salvadora persica* L. (Miswak) Extract on Growth of Foodborne Pathogens, *Aspergillus* Species. Dose response. 2019;17(3):15593258- 1987621.
- Noumi E, Snoussi M, Hajlaoui H, Valentin E, Bakhrouf A., Antifungal properties of *Salvadora persica* and *Juglans regia* L. extracts against oral *Candida* strains. *Eur J Clin. Microbiol Infect Dis.* 2010; 29(1): 81-8.
- Bahabri F. Application of spectroscopic techniques for the identification of organic and inorganic constituents of *Salvadora persica* from Saudi Arabia. *Physica A.* 2000; 276, 346-351.
- Halawany H. A review on miswak (*Salvadora persica*) and its effect on various aspects of oral health. *Saudi Dent J.* 2012; 24(2):63-69.
- AbdelKader M, Alam P, AlQarni M, Salkini M. High – Performance Thin-Layer Chromatographic method for the estimation of benzyl thioisocyanate in *Salvadora persica* root extract and dental care herbal products. *J. Planar Chromatogr.* 2017;30(3):211-215.
- Al-Lafi T, Ababneh H. The effect of the extract of the miswak (chewing sticks) used in Jordan and the Middle East on oral bacteria. *Int. Dent. J.* 1995; 45:218-222.
- AlMas K, AlBagieh N. The antimicrobial effect of bark and pulp extracts of miswak, *Salvadora persica*. *Biomed. Lett.* 1999; 60:71-75.
- Abd El Rahman H, Skaug N. George W. In vitro antimicrobial effects of crude miswak extracts on oral pathogens. *Saudi Dent J.* 2002;14:26-32.
- Sofrata A, Claesson R, Lingström P, Gustafsson A. Strong antibacterial effect of miswak against oral microorganisms associated with periodontitis and caries. *J Periodontol.* 2008;79:1474-1479.
- AlAli F, AlLafi T. GC-MS analysis and bioactivity testing of the volatile oil from the leaves of the toothbrush tree of *Salvadora persica* L. *Nat Prod Res.* 2003; 17:189-194.
- Abdel Kader M, Alam P, AlQarni M, Salkini M. High– Performance Thin-Layer Chrom- atographic method for the estimation of benzyl thioisocyanate in *Salvadora persica* root extract and dental care herbal products. *J. Planar Chromatogr.* 2017;30(3):211-215.
- Farooqi M, Srivastava J. The tooth-brush tree (*Salvadora persica*). *Quart. J. Crude Drug Res.* 1968; 8, 1297-1299.
- Garbouri S, Karlson A, Palsson K. Tick repellent properties of three Libyan plants. *J Med Entomol.* 2009; 46(6), 1415-1419
- Kamil M, Jayaraj A, Ahmed F, Gunaseklar C, Samuel S, Habibul M, Chan K. Pham- acognostic

- and phytochemical studies on *Salvadora persica*. *J Pharm Pharmacol.* 1999; 227, 51-58.
26. Mansour M, Al Khateeb T, Al Mazraoo A. The analgesic effect of miswak. *Saudi Dent J.* 1996; 8, 87-91.
27. Alili N, Türp J, Kulik E, Waltimo T. Volatile compounds of *Salvadora persica* inhibit the growth of oral *Candida* species. *Arch. Oral Biol.* 2014; 59(5), 441-447.
28. Ahmad H, Ahamed N. Therapeutic properties of miswak chewing sticks: A review. *African J Biotechnol.* 2012;11(83):14850-14857.
29. Noumi E, Snoussi M, Trabelsi N, Hajlaoui H, Ksouri R, Valentin E, Bakhrouf A. Antibacterial, anticandidal, antio-xidant activities of *Salvadora persica* and *Juglans regia* L. extracts. *JMed Plants Res.* 2011;5(17):4138-4146.
30. Sher H, Al Yemeni M, Yaha S, Arif H. Ethnomedicinal and ecological evaluation of *Salvadora persica* L.: a threatened medicinal plant in Arabian Peninsula. *J Med Res.* 2010;4(12):1209-1215.
31. Khalessi A, Pack W, and Tompkins G. An in vivo study of the plaque control efficacy of Persica™: a commercially available herbal mouthwash containing extracts of *Salvadora persica*. *Int Dent J.* 2004;54: 279-283.
32. Ahmed S, ElGengaihi E, ElSayed M, Schung E. Preliminary phytochemical and propagation trial with *Salvadora persica* L. *Agric For Res.* 2008; 58(1-2):135-138.
33. Amoian B, Moghadamnia A, Barzi S, Sheykhholeslami S, Rangjani A. *Salvadora persica* extract chewing gum and gingival health: Improvement of gingival and probe-bleeding index. *Compl Therp Clin Prac.* 2010;16(3):121-123.
34. Eid M, Selim H, AlShammery A. The relationship between chewing sticks (miswak) and periodontal health . Part I. Review of the literature and profile of the subjects. *Quintessence Int.* 1990; 21(11), 913-917
35. Trovato A, Galati E, Rossitto A, Moriforte M, D'Aquino A, Forestieri A. Hypoglycemic effects of *Salvadora persica* L. in the rat. *Phytomed.* 1998;5(2), 129-132.
36. Khalil A. Benzyl amides from *Salvadora persica*. *Arch. Pharm. Res.* 2006;29(11), 952-956.
37. Sanogo R, Monforte M, Daquino A, Rossitto A, Maur D, and Galati E. Antiulcer activity of *Salvadora persica* L.: structural modifications. *Phytomed. Int. J. Phytotherp. Phytopharmacol.* 1999;6(5),363 – 366.
38. (a) ElTatari A., de Soet J., de Gee A., Abou Shelib M., and Amerongen W. Influence of *Salvadora persica* (miswak) extract on physical and antimicrobial properties of glass ionomer cement. *Eur Archives Paediatr Dent.* 12, 22-25 (2011); (b) Savaş S. Structural properties and mechanical performance of *Salvadora persica* L. (Miswak) reinforced polypropylene composites. *Polym Compos.* 40, E663-E677 (2018).
39. Ahmadi R, Ghanbarzadeh B., Ayaseh A, Kafil H, Özyurt H, Katourani H, and Ostadrahimi A. The antimicrobial bio-nanocomposite containing non-hydrolyzed cellulose nanofiber (CNF) and miswak (*Salvadora persica* L.) extract. *Carbohydr Polym.* 2019;214:15-25.
40. Yarbrough J, Rake J, Eaagon R. Bacterial inhibitory of nitrate inhibition of active transport, but not of group translocation and of intercellular enzymes. *Appl Environ Microbiol.* 1980;39, 831-834.
41. Carlsson J, Edlun M, Häström L. Bactericidal and cytotoxic effects of hypochlorite – hydrogen peroxide mixtures. *Infect. Immun.* 1984;44(3),581-586.
42. (a) AlShehri S, Duley J, Bansal N. Xanthine oxidase-lactoperoxidase system and innate immunity: biochemical actions and physiological roles. *Redox Biol.* 2020;34, 101524; (b) Cegolon L. Investigation hypochlorite against SARS-CoV-2. *Int J Hyg Environ Health.* 2020; 227, 113520.
43. Kalanaraman B. Teaching the basics of redox biology to medical and graduate students: oxidants, antioxidants and disease mechanisms. *Redox Biol.* 2013; 1(1), 244-257
44. Ishida M, Hara M, Fukino N, Kakizaki T, Morimitsu Y. Glucosinolate metabolism, functionality, and breeding for the improvement of Brassicaceae vegetables. *Breed Sci.* 2014; 64(1), 48-59.
45. Rouzaud G, Young S, Duncan A. Hydrolysis of glucosinolate to isothiocyanates after ingestion of raw or microwaved cabbage by human volunteers. *Cancer Epidemiol Biomarker Prev.* 2004;13(1), 125-131.

46. Johnson I. Glucosinolates: bioavailability and importance to health. *Int J Vit. Nutr Res.* 2002; 72, 26-31.
47. Luke L, Wagstaff C. Enhancement of glucosinolate and isothiocyanate profiles in Brassicaceae crops: addressing challenges in breeding for cultivation, storage, and consumer-related traits. *J Agric Food Chem.* 2017; 65, 9379-9403.
48. Lugasi A, Varga T. non-nutritive biologically active plant components: glucosinolates, their sources and their nutritional significance. *Orv Hetil* 2006; 147(29), 1361-1368.
49. Bo S, Fadda M, Fedele D, Pellegrini M, Ghigo E, Pellegrini N. A critical review on the role of food and nutrition in the energy balance. *Nutr.* 2020; 12(4), 1161.
50. Kraiser T, Gras D, Gutiérrez A, González B, Gutiérrez R. A holistic view of nitrogen acquisition in plants. *J. Exp. Bot.* 2011; 62(4), 1455-1466.
51. Aibara I, Miwa K. Strategies for optimization of mineral nutrient transport in plants: multilevel regulation of nutrient –dependent dynamic of root architecture and transporter activity. *Plant Cell Physiol.* 2014; 55(12), 2027-2037.
52. Kiba T, Krapp A. Plant nitrogen acquisition under low availability: regulation of uptake and root architecture. *Plant Cell Physiol.* 2016; 57(4), 707-714.
53. Aune T, Thomas E. Accumulation of hypothiocyanite ion during peroxidase –catalyzed oxidation of thiocyanate ion. *Eur J Biochem.* 1977; 80, 209-214.
54. Cooper R, Williams J. Elemental sulphur as an induced antifungal substance in plant defence. *J Exp Bot.* 2004;55, 1947-1953.
55. Cooper R, Williams J. Elemental sulphur is produced by diverse plant families as a component of defense against fungal and bacterial pathogens. *Physiol. Mol. Plant Pathol.* 2003; 63, 3-16.
56. Tea I, Gentr T, Nault N, Boyer V, Lummerzheim M, and Kleiber D. Effect of foliar sulfur and nitrogen fertilization on wheat storage protein composition and dough mixing properties. *Cereal Chem.* 2004; 81,759-766.
57. Tolocka M, Turpin B. Contribution of organosulfur compounds to organic aerosol mass. *Environ Sci Technol.* 2012; 46, 7978-7983.
58. Xulu B, Ashby M. Small molecular, macromolecular, and cellular chloramines react with thiocyanate to give human defense factor hypothiocyanite *Biochem.* 2010;49, 2068-2074.
59. Schultz C, Ahmed M, Dawes C, Mantsch H. Thiocyanate level in human saliva: quantitation by Fourier Transform Infrared Spectroscopy. *Anal Biochem.* 1996; 240, 7-12.
60. Ashby M, Inorganic chemistry of defensive peroxidases in human oral activity. *J Dent Res.* 2008;87, 900-914.
61. Thomas E, Milligan T, Joyner R, Jefferson M. Antibacterial activity of hydrogen peroxide in the lactoperoxidase-hydrogen peroxide –thiocyanate system against oral streptococci. *Infect Immun.* 1994; 62, 529-535.
62. Klebanoff S, Clem W, Luebke R. The peroxidase-thiocyanate-hydrogen peroxidase antimicrobial system. *Biochim Biophys Acta* 1966; 17, 63 – 72.
63. Hawkins C. The role of hypothiocyanous acid (HOSCN) in biological systems. *Free Radic. Res.* 2009; 43, 1147-1158.
64. Chandler J, Day B. Thiocyanate: a potentially useful therapeutic agent with host and antioxidant properties. *Biochem Pharmacol.* 2012;84(11),1381-1387.
65. Bhunia F, Saha N, Kaviraj A. Toxicity of thiocyanate to fish, plankton, worm, and aquatic ecosystem. *Bull Environ Contamin Tox.* 2000;64,197-204.
66. Trugo L, Finglas P. *The Encyclopedia of food and nutrition*, 8<sup>th</sup> Edition, Elsevier Science Ltd, New York, USA, 2003.
67. Smith R. Cyanate and thiocyanate: acute toxicity. *Proceed Soc Exp Biol Med.* 1973; 142(3), 1041-1044.
68. Hänsch R, Mendel R. Physiological functions of mineral micronutrients (Cu, Zn, Mn, Fe, Ni, Mo, B, Cl). *Curr. Opin Plant Biol.* 2009; 12, 259-266.
69. White P, Broaley M. Chloride in soil and its uptake and movement within the plant: a review. *Annals Bot.* 2001;88, 967 -988.
70. Broadley M, Brown P, Cakmak I, Ma J, Rengel Z, F. Zhao F, Marschner P. *Function of nutrients: micronutrient. Marschner’s mineral nutrition of higher plants*, 3<sup>rd</sup> edition, Academic Press, San Diego, USA, 2012.
71. Franco-Navarro J, Brumós J, Rosales M, Cubero-

- Font P, Talón M, Colmenero-Flores J. Chloride regulates leaf size and water relations in tobacco plants. *J Exp Bot.* 2016; 67(3), 873-891.
72. Raven J. Chloride: essential micronutrient and multifunctional beneficial ion. *J Exp Bot.* 2017; 68(3), 359-367.
73. Xu G, Magen H, Tarchitky J, Kafkafi U. Advances in chloride nutrition of plants. *Adv. Agron.* 1999; 68, 97-150.
74. Mohamed F, Wael M, Omer B, Ali El, Persicaline, A New Antioxidant Sulphur-Containing Imidazoline Alkaloid from *Salvadora persica* Roots, *Molecules.* 2018, 23, 483:1-13
75. Alhamdi R, Tanomand A, F. Kamounah F, Ayaseh A, Ganbarov K, Yousefi M. Katourani A, Yousefi B, and Kafil H. Fabrication and characterization of a titanium oxide (TiO<sub>2</sub>) nanoparticles reinforced bio-nanocomposite containing miswak (*Salvadora persica*) extract – the antimicrobial, thermo-physical, and barrier properties. *Int J Nanomed.* 2019;14:3439-3454.
76. Abd ElLatif H, Sulaiman A. A., Antibacterial activity of Miswak (*Salvadora persica*) extracts against isolated and genetically identified oral cavity pathogens, *Technol. Health Care.* 2016;24:S841–S848
77. Mohamed S., Ahmed M., Mohamed A., Hany G., and Abduljabbar H., Antibacterial Activity of *Salvadora persica* L. (Miswaak) Extracts against Multidrug Resistant Bacterial Clinical Isolates, *Evid. Based Complementary Altern. Med.* 2016:1-5.
78. Mohamed M, Abdul Aziz A, Ibrahim A, Ali A, Mostafa E, EL-Gaaly G, Assessment of antioxidant activities in roots of Miswak (*Salvadora persica*) plants grown at two different locations in Saudi Arabia Saudi. *Res J Biol Sci.* 2015; 22, 168–175.
79. Saleh A, Jalaluddin A. Antioxidant capacity of chewing stick miswak *Salvadora persica*. *BMC Complement Altern Med.* 2013,13:40.
80. Kadhum S, Sabah N, Mauyad S. Antifungal efficiency of Miswak & Cardamom Extract on Some Virulence Factors of *Candida albicans* as Oral Pathogen. *Biolo J Kufa univ.* 2011; 3(2): 1-7.
81. Firas A, Khudir D. In Vitro Antimicrobial Activity of *Salvadora persica* L. Extracts Against Some Isolated Oral Pathogens in Iraq. *Turk J Biol.* 2008;32:57-62
82. Darmani H, Nusayr T, Al-Hiyasat A. Effects of extracts of miswak and derum on proliferation of Balb/C 3T3 fibroblasts and viability of cariogenic bacteria. *Int J Dent Hygiene.* 2006;4, 62–66
83. El Mostehy M.R, Al-Jassem AA, Al-Yassin IA. Miswak as an oral health device. Preliminary chemical and clinical evaluation. *Hamdard.* 1983;26:41-50.
84. H.S. A new natural source for topical fluoride. *J Indian Dent Assoc.* 1983; 55:419-422.
85. Kubota K, Tanaka T, Murata Y, Hirasawa M. Effect of tannic acid on adherence of *Candida* to denture base. *J Den Res.* 1988; 67:183.
86. Dorland WA. Newman. *Dorland’s Illustrated Medical Dictionary.* 27th ed. Philadelphia: W.B.Saunders Co. 1988.
87. Almas K. Miswak (chewing stick) and its role in oral health. *Postgrad Dent.* 1993; 3:214-18
88. Grant J. Miswak-toothbrushes that grow on trees. *Today’s– FDA.* 1990; 2:60.
89. Jaishree T, JareenAJ. The Miracle Twig –Miswak. *Int JAppl Dent Sci.* 2017; 3(2): 66-70.
90. Al-Bagieh NH. Antiherpes simplex virus type 1 activity of benzylisothiocyanate. *Biomed.Lett.* 1992; 47:67-70
91. Al-Bagieh NH. Effect of benzylisothiocyanate on the growth and acid production of *Candida albicans*. *Biomed Lett.* 1998;58:139-145.
92. Al-BagiehNH, WeinbergED. Benzylisothiocyanate: a possible agent for controlling dental caries. *Microb Lett.* 1998; 39:143-151.
93. Al-Bagieh NH, Idowu A, Salako NO. Effect of aqueous extract of miswak on the in vitro growth of *Candida albicans*. *Microbios Lett.* 1994; (80) 107-113.
94. Ali H, Konig CM, Khalid SA. Evaluation of selected Sudanese medicinal plants for their in vitro activity against hemoflagellates selected bacteria, HIV-1-RT and tyrosine kinase inhibitory, and for cytotoxicity. *J. Ethnopharmacol.* 2002;83:219-228.
95. Deborah K, Mecky I., Olipa D, Cosam C, and Zakaria H. Screening of Tanzanian medicinal plants for anti-*Candida* activity, *BMC Complement Dent pract.* 2006;6:11, 1-10
96. Himawan H, Talitha A. The effectiveness of using siwak toothpaste on plaque accumulation in fixed orthodontic applications users. *Asian J Pharm*

- Clin Res. 2020;13(3):113-115.
97. Khalid A. The Effect of *Salvadora Persica* Extract (Miswak) and Chlorahexidine Gluconate on Human Dentin: A SEM Study. *J. Contemp. Dent. Pract.* . 2002;3(3);1-10.
  98. Sote E. The relative effectiveness of chewing sticks and toothbrush on plaque rem- oval. *Afr Dent J.*1987;1:48–53.
  99. Stafa M., Sadek S. The efficacy of Miswak concentrate, tooth paste: I. Clinical report, *Egypt Dent J.* 1987;33;75-84
  100. Walter H, Lewis, Memory P.F. Elvin-Lewis, *Medical Botany: Plants Affecting Human Health*, 2<sup>nd</sup> ed., Willey, page 412, 2003.

# Serological Tests Assessment in Patients Suspected to have Celiac Disease Attending the Gastroenterology and Hepatology Teaching Hospital in Baghdad

Samer Nema Yassen Alkemawy<sup>1</sup>, Shymaa Nema Hamed Alsaltani<sup>2</sup>

*M.B.Ch.B, D.M, F.I.B.M.S (Internal Medicine), F.I.B.M.S (Gastroenterology & Hepatology), Lecturer, Iraq/ University of Kufa/College of Medicine, <sup>2</sup>M.B.Ch.B, F.I.B.M.S (Family Medicine), Family Physician Specialist, Iraq/Ministry of Health/Najaf Health Circle*

## Abstract

**Background:** Celiac disease is characterized by small intestinal malabsorption of nutrients after the ingestion of wheat gluten or related proteins from rye and barley, villus atrophy of the small intestinal mucosa, prompt clinical and histologic improvement following strict adherence to a gluten-free diet, and relapse when gluten is retaken.

**Aim of the Study:** Evaluation of patients seeking gastroenterology and hepatology teaching hospital/medical city/Baghdad with suspected celiac disease regarding serological investigation, histological findings and genetic testing, to determine sensitivity, specificity, positive predictive value and negative predictive value for every test.

**Patients and Method:** The study is a cross sectional descriptive analytic study conducted at the teaching hospital of gastroenterology and hepatology/Baghdad/Iraq during a period from the 1<sup>st</sup> of February 2018 to the 1<sup>st</sup> of April 2019. After thorough history and Clinical examination patients with suspected celiac disease were sent for serological investigation (TTG IgA and IgG), (antigliadin IgA and IgG), all patients were sent for endoscopic examination for duodenal biopsies with subsequent histological assessment. Patients who failed to be confirmed (positive serology and negative histology or vice versa) were sent either for HLA genotyping or for IgG Deaminated gliadin peptide. Sensitivity & specificity were measured for each test.

**Results:** A total of 140 suspected celiac disease patients involved in this study. Mean age was 18.9 years and ranged from 2 years to 60 years. Male represented 36.4% of the cases while female represented 63.6%. Only 19 patients show positive family history of celiac disease (13.6 %). Regarding associated autoimmune diseases, the majority (111 patients) have no associated diseases (79.3%) while the other patients who have associations most of them show positive association with type 1 DM (16.4%).

Fifty patients (35.7%) presented with short stature, (25.7%) came with diarrhea. The other symptoms vary between bloating and distention, unexplained anemia and weight loss. Constipation was seen in one patient. tTG IgA and tTG IgG showed high sensitivity, specificity, positive predictive value and negative predictive value while antigliadin antibody failed to show these significant results.

---

### Corresponding Author:

**Dr. Samer Nema Yassen Alkemawy**  
M.B.Ch.B, D.M, F.I.B.M.S (Internal Medicine),  
F.I.B.M.S (Gastroenterology & Hepatology), Lecturer,  
Iraq/University of Kufa/College of Medicine  
e-mail: samern.alfatlawy@uokufa.edu.iq  
Telephone +964-781-3207201

**Conclusion:** The use of serologic markers in celiac is easy, direct, noninvasive and reliable and could be benefit in the diagnosis and monitoring of the disease. More specifically, both the tTG-IgA/IgG are very good markers in the diagnosis of CD. This study confirmed the high specificity and sensitivity of tTG, and

the low results of AGA, but celiac serology does not replace the biopsy in the diagnosis but is useful as an assistant for diagnosis.

**Keywords:** *Celiac Serological Tests, Transglutaminase Antibody, Antigliadin Antibody, Deamidated Gliadin Antibody, Antiendomysial Antibody, HLA DQ2/DQ8, Marsh Classification, Duodenal Biopsy, Villous Atrophy, Chronic Diarrhea, Malabsorption, Gluten*

## Introduction

**Definition:** Celiac disease is characterized by small intestinal defect of absorption of nutrients after the taking of gluten or proteins from rye and barley, small bowel mucosal villus atrophy, prompt clinical and improvement in histology after adherence to a gluten-free diet, and relapse when gluten is retaken again.<sup>(1,2,3)</sup>

**Classification:**<sup>(4,5, 6)</sup>

**Classic disease** —

**Atypical celiac disease** —

**Silent celiac disease** —

**Latent celiac disease** —

**Who should be tested?**

Testing for celiac disease should be considered in the following patients<sup>(2,7)</sup>:

- Gastrointestinal symptoms
- Extra intestinal signs and symptoms such as iron deficiency anemia, folate or vitamin B12 deficiency, persistent elevation in serum aminotransferases, short stature, delayed puberty,
- Patients with type 1 diabetes mellitus
- Asymptomatic first-degree relatives.

**Serum Antibody Assays:**

A variety of serologic studies have been described to aid in the diagnosis of celiac disease, including:<sup>[8,9,10]</sup>

- EMA IgA
- tTG IgA
- tTG IgG
- DGP IgA
- DGP IgG

**Anti-tissue transglutaminase antibodies:** The

antigen against which antiendomysial antibodies are directed is tissue transglutaminase-2 (tTG)<sup>[11]</sup>. Anti-tTG antibodies were highly sensitive and specific for the diagnosis of celiac disease in most reports<sup>[12,13,14]</sup>.

The accuracy of IgA anti-tTG has been improved more by the use of human in place of the non-human tTG used in earlier kits<sup>[15]</sup>.

**Antigliadin Antibody Assays:** Antigliadin antibody (AGA) tests are not recommended due to their low positive predictive value in a general population<sup>[16,17]</sup>. The second generation AGA test (deamidated gliadin peptide [DGP]) uses synthetic gliadin peptides that mimic tTG-modified gliadin sequences to capture serum IgA or IgG against DGP<sup>[9, 10]</sup>. Anti-DGP assays are preferred over anti-AGA due to their higher specificity.

Patients on a gluten-free diet with negative serologies should undergo HLA DQ2/DQ8 testing to determine if the patient is genetically susceptible to celiac disease. If HLA DQ2/DQ8 testing is negative, celiac disease is excluded<sup>[17]</sup>.

**Small Bowel Biopsy:** Patients with a positive serology, and patients with a high probability of celiac disease (>5 percent), regardless of the serology, should undergo an upper endoscopy with small bowel biopsy to confirm the diagnosis of celiac disease.<sup>[18]</sup> The mucosa of duodenal wall may appear atrophied with loss of folds, have a nodular appearance or the folds may be scalloped, but such findings are not always present and may be seen with other causes<sup>[19][20]</sup>. The histologic features range from a mild alteration characterized only by increased intraepithelial lymphocytes (IEL), to a flat mucosa with complete loss of villi, enhanced epithelial apoptosis, and crypt hyperplasia<sup>[4,6,21]</sup>. The histologic findings in celiac disease can be described using the Marsh-Oberhuber<sup>[22]</sup>. Quantitative histology (villous height, crypt depth, density of IELs per 100 enterocytes) provides the most sensitive and accurate method to monitor disease activity over time<sup>[23,24]</sup>.

### **Suggestive clinical features but negative serologic tests:**

There are four main possibilities in those with suggestive clinical features but negative serologic tests:<sup>[25,26,27,28]</sup>

- IgA deficiency. In such patients, testing for IgG deamidated gliadin peptide antibodies should be performed. Other, less accurate, IgG-based tests include IgG anti-tissue transglutaminase antibodies
- Low gluten diet.
- Falsely negative. IgA or IgG deamidated gliadin peptide antibody testing may be useful.
- Irritable bowel syndrome, nonceliac gluten sensitivity

### **Materials and Method**

**Participants and study design:** This study was a cross sectional descriptive analytic study conducted at the teaching hospital of gastroenterology and hepatology/ Baghdad/Iraq during a period from 1<sup>st</sup> of February 2018 to the 1<sup>st</sup> of April 2019.

**Subjects and sampling method:** After thorough history and clinical examination of the patients referred to the hospital due to variable clinical symptoms and signs compatible with coeliac disease, subjects were recruited according to convenient sampling method and a convenient sample of 140 patients was studied which were sent for serological investigation (TTG IgA and IgG), (AGA IgA and IgG), all patients were sent for endoscopic examination for duodenal biopsies with histological assessment. Patients who failed to be confirmed were sent either for the new test IgG DGP or for HLA genotyping.

#### **Inclusion Criteria:**

1. Chronic diarrhea or loose stools.
2. Abdominal pain, abdominal distention and flatulence not responding to medication.
3. Malabsorption and steatorrhea.
4. Unexplained Wt. loss.
5. Failure to thrive.
6. Unexplained anemia.

7. At-risk family members

#### **Exclusion Criteria:**

1. Crohn's disease
2. Chronic liver disease
3. H.pylori gastritis, Peptic ulcer duodenitis
4. Giardiasis
5. Malnourished patients due to chronic debilitating disease

**Blood Sample:** The sample was then analysed for TTG, antigliadin, Some of the patients who showed discrepancy of their results were sent for IgG Deamidated Gliadin peptide in the Central Health Laboratory in Baghdad or for HLA test in the teaching hospital of Alkarama in Baghdad.

**Serological Tests:** Serum tTG and AGA performed by ELISA based to the manufacturers.

**Genotyping:** Coeliac disease-associated HLA genotyping was performed in Alkarama hospital in Baghdad by specialized lab.

**Upper gastrointestinal endoscopy:** Upper gastrointestinal endoscopies with duodenal biopsies were offered regardless of serology results by specialized gastroenterologist.

**Histology:** Biopsies were interpreted in the pathology department in the gastroenterology and hepatology teaching hospital by specialized pathologist to read the small intestinal histological features, according to the modified Marsh criteria:

The reference standard for celiac disease diagnosis was considered Marsh grade  $\geq 2$ .<sup>[29]</sup>

**Ethical Aspects:** The Institution's Ethical Committee approval was obtained prior to the enrolment of subjects.

**Statistical Analysis:** Data were analyzed by the statistical package of social sciences version 25. Statistics of the variables was expressed as medians, ranges, frequencies and percentage, as appropriate and calculated by chi-squared test. Odds ratio (OR) and the 95% confidence interval of OR were calculated, Level of significance of  $\leq 0.05$ , considered as significant difference or association.



## Results

**tTG IgA Serology:** From the patients who were found to be marsh 0 or 1, only 2 patients tested positive for TTG IgA those was sent for IgG DGP or HLA and the results was negatives and so they are regarded as (false positives) while 48 patients tested negative (true negatives). From the patients who were found to be

marsh 2 or 3, 84 patients tested positive for TTG IgA (true positives) while only 6 patients tested negative those was sent for IgG DGP or HLA and the results were positives and so they are regarded as (false negatives). From these results we concluded that sensitivity, specificity, PPV and NPV of **TTGIgA** were 93.3%, 96%, 97.6% and 88.8% respectively (Table 1).

**Table 1: Sensitivity, specificity, PPV and NPV of TTG IgA**

		Histology			
		Marsh 2, 3a,3b and 3c	Marsh 0,1		
TTG IgA	Positive	84	2	Sensitivity	93.3 %
				Specificity	96 %
	Negative	6	48	Positive predictive value	97.6 %
				Negative predictive value	88.8 %

**tTG IgG Serology:** From patients with marsh 0 or 1 only 4 patients tested positive for TTG IgG so some of those was sent for IgG DGP and another for HLA and the results was negative and so they are regarded as (false positives) while 46 patients tested negative (true negatives).

From the patients who were found to be marsh 2 or 3, 85 patients tested positive for TTG IgG (true positives) while only 5 patients tested negative and those was sent for IgG DGP or HLA and the results were positive and so they are regarded as (false negatives). From these results we concluded that sensitivity, specificity, PPV and NPV of **TTG IgG** were 94.4%, 92%, 95.5% and 90.1% respectively (Table 2).

**Table 2 Sensitivity, specificity, PPV and NPV of TTG IgG**

		Histology			
		Marsh 2, 3a,3b and 3c	Marsh 0,1		
TTG IgG	Positive	85	4	Sensitivity	94.4 %
				Specificity	92 %
	Negative	5	46	Positive predictive value	95.5 %
				Negative predictive value	90.1 %

**Antigliadin IgA Serology:** From the patients who were found to be marsh 0 or 1, 13 patients tested positive for anti gliadin IgA those was sent for IgG DGP or HLA and the results was negative and so they are regarded as (false positives) while 37 patients tested negative (true negatives). From the patients who were found to be marsh 2 or 3, 33 patients tested positive for anti gliadin IgA (true

positives) while 57 patients tested negative those was sent for IgG DGP or HLA and the results were positive and so they are regarded as (false negatives). From these results we concluded that sensitivity, specificity, PPV and NPV of **anti gliadin IgA** were 36.6%, 74%, 71.7% and 39.3% respectively (Table 3).

**Table 3: Sensitivity, specificity, PPV and NPV of anti gliadin IgA**

		Histology			
		Marsh 2, 3a,3b and 3c	Marsh 0,1		
Antigliadin IgA	Positive	33	13	Sensitivity	36.6 %
				Specificity	74 %
	Negative	57	37	Positive predictive value	71.7 %
				Negative predictive value	39.3 %

**Antigliadin IgG Serology:** From the patients who were found to be marsh 0 or 1, 7 patients tested positive for anti gliadin IgG those was sent for IgG DGP or HLA and the results was negative and so they are regarded as (false positives) while 43 patients tested negative (true negatives). From the patients who were found to be marsh 2 or 3, 22 patients tested positive for anti gliadin IgG (true

positives) while 68 patients tested negative those was sent for IgG DGP or HLA and the results were positive and so they are regarded as (false negatives). From these results we concluded that sensitivity, specificity, PPV and NPV of **anti gliadin IgG** were 24.4%, 86%, 75.8% and 38.7% respectively (Table 4).

**Table 4 Sensitivity, specificity, PPV and NPV of anti gliadin IgG**

		Histology			
		Marsh 2, 3a,3b and 3c	Marsh 0,1		
Antigliadin IgG	Positive	22	7	Sensitivity	24.4 %
				Specificity	86 %
	Negative	68	43	Positive predictive value	75.8 %
				Negative predictive value	38.7 %

**Discussion**

Celiac disease is a common disorder, which affects 1% of individuals [30]. There are many disorders, with environmental and genetic effects contributing to the etiology of celiac disease [31]. HLA locus is the main influence affect celiac disease [32].

In the present study age distribution of cases showed that celiac disease is more in children than in adults. as shown in table 2 which show that from 90 patients who are proved to be celiac disease the frequency of children is 64 patients versus only 26 adults so that, the results of this study are similar to results that obtained by other researchers, especially with results of AL-Kenzawi, when he showed that children account a large number of celiac patients in Iraq country [33].

Also these results come in agreement with the results of Al-Saadi and Abid, when they studied patients with celiac disease in Karbala and showed that 64% of patients were children [34] and the results of another study

which took 509 patients referred to the immunology department in Baghdad teaching labs and showed that large number of CD cases were children [35].

In general CD in children is more than other ages, might be attributed to introduction of large amount of gluten or exposure to the gluten without breastfeeding might increase the risk of CD in children [36], or might be due to other factors such as infections [37].

In the present study Gender distribution of cases showed that the majority of cases that are proved to be celiac disease were females (72.2 %) and the remaining (27.7 %) were males as shown in table 2 so that, this agrees with Green, when he reported that CD was 2 to 3 times higher in females [30]. Also, agrees with results of Fasano A [38] and Giorgio F [39] showed that the prevalence of celiac disease is 1.5 to 2 times higher in females.

In general, some genetic loci are related to sex, also sex-dependent HLA associations are seen because

female patients are carry DQ2 and/or DQ8 molecules while DQ2/DQ8 negative celiac mostly are males<sup>[40]</sup>, or role of sex hormones in immune regulation which may explain sex varieties<sup>[41]</sup>.

In the present study significant numbers of CD patients have positive family history and this agrees with the results of Vitoria JC showed that the risk of having CD is higher in siblings than in parents of patients with CD<sup>[42]</sup> and agree with the research done India showed that CD prevalence among first-degree relatives was 8.2% (14/169). CD prevalence between siblings is (15.6%)<sup>[43]</sup>.

CD Prevalence in the first degree relatives vary between 2.8% to 8.2%<sup>[42]</sup>. The variability can be clarified by study the methodology and the differences of the genetics of the studied population. It is mentioned that this prevalence increases in families with two or more cases of CD<sup>[44]</sup>.

The present study shows significant association between type 1 DM and celiac disease and this comes in agreement with the results of other research that done in British Columbia who confirmed the prevalence of CD in diabetes type one<sup>[45]</sup> and come in agreement with other research done in Iraq showed that the proportions of patients with CD and type one diabetes who were positive for anti gliadin IgA and IgG, tTG IgA IgG were 20%, 23.53%, 20% and 24.71%, respectively, which were higher than those of control subjects significantly<sup>[46]</sup>

### Conclusion

- Celiac serology does not replace small bowel biopsy in the diagnosis of celiac disease but is useful as an adjunct to biopsy.
- Serological tests are easy, noninvasive and are benefit both for diagnosis and monitoring.
- The study showed the high sensitivity & specificity of tTG, and the low results of the AGA.

**Ethical Clearance:** Taken from The Institution's Ethical Committee approval

**Source of Funding:** Self

**Conflict of Interest:** nil

### References

1. Rostom A, Dubé C, Cranney A, Saloojee N, Sy R, Garritty C, Sampson M, Zhang L, Yazdi F, Mamaladze V, Pan I. Celiac disease. *Evid Rep Technol Assess (Summ)*. 2004 Jun;104(104):1-6.
2. James SP. National Institutes of Health consensus development conference statement on celiac disease, June 28–30, 2004.
3. Ludvigsson JF, Leffler DA, Bai JC, Biagi F, Fasano A, Green PH, Hadjivassiliou M, Kaukinen K, Kelly CP, Leonard JN, Lundin KE. The Oslo definitions for coeliac disease and related terms. *Gut*. 2013 Jan 1;62(1):43-52.
4. Troncone R, Greco L, Mayer M, Paparo F, Caputo N, Micillo M, Mugione P, Auricchio S. Latent and potential coeliac disease. *Acta Paediatrica*. 1996 May;85:10-4.
5. Zanini B, Caselani F, Magni A, Turini D, Ferraresi A, Lanzarotto F, Villanacci V, Carabellese N, Ricci C, Lanzini A. Celiac disease with mild enteropathy is not mild disease. *Clinical Gastroenterology and Hepatology*. 2013 Mar 1;11(3):253-8.
6. Fry L, Seah PP, McMinn RM, Hoffbrand AV. Lymphocytic infiltration of epithelium in diagnosis of gluten-sensitive enteropathy. *Br Med J*. 1972 Aug 12;3(5823):371-4.
7. Rubio-Tapia A, Hill ID, Kelly CP, Calderwood AH, Murray JA. ACG clinical guidelines: diagnosis and management of celiac disease. *The American journal of gastroenterology*. 2013 May;108(5):656.
8. Kelly CP, Bai JC, Liu E, Leffler DA. Advances in diagnosis and management of celiac disease. *Gastroenterology*. 2015 May 1;148(6):1175-86.
9. Sugai E, Vázquez H, Nachman F, Moreno ML, Mazure R, Smecuol E, Niveloni S, Cabanne A, Kogan Z, Gómez JC, Mauriño E. Accuracy of testing for antibodies to synthetic gliadin-related peptides in celiac disease. *Clinical Gastroenterology and Hepatology*. 2006 Sep 1;4(9):1112-7.
10. Prince HE. Evaluation of the INOVA diagnostics enzyme-linked immunosorbent assay kits for measuring serum immunoglobulin G (IgG) and IgA to deamidated gliadin peptides. *Clin. Vaccine Immunol.*. 2006 Jan 1;13(1):150-1.
11. Dieterich W, Ehnis T, Bauer M, Donner P, Volta U, Riecken EO, Schuppan D. Identification of tissue transglutaminase as the autoantigen of celiac disease. *Nature medicine*. 1997 Jul;3(7):797.
12. Dieterich W, Laag E, Schöpfer H, Volta U, Ferguson A, Gillett H, Riecken EO, Schuppan D. Autoantibodies to tissue transglutaminase as

- predictors of celiac disease. *Gastroenterology*. 1998 Dec 1;115(6):1317-21.
13. Sulkanen S, Halttunen T, Laurila K, Kolho KL, Korponay-Szabó IR, Sarnesto A, Savilahti E, Collin P, Mäki M. Tissue transglutaminase autoantibody enzyme-linked immunosorbent assay in detecting celiac disease. *Gastroenterology*. 1998 Dec 1;115(6):1322-8.
  14. Hopper AD, Cross SS, Hurlstone DP, McAlindon ME, Lobo AJ, Hadjivassiliou M, Sloan ME, Dixon S, Sanders DS. Pre-endoscopy serological testing for coeliac disease: evaluation of a clinical decision tool. *Bmj*. 2007 Apr 5;334(7596):729.
  15. Tonutti E, Visentini D, Bizzaro N, Caradonna M, Cerni L, Villalta D, Tozzoli R. The role of antitissue transglutaminase assay for the diagnosis and monitoring of coeliac disease: a French–Italian multicentre study. *Journal of clinical pathology*. 2003 May 1;56(5):389-93.
  16. Corrao G, Corazza GR, Andreani ML, Torchio P, Valentini RA, Galatola G, Quaglino D, Gasbarrini G, Di Orio F. Serological screening of coeliac disease: choosing the optimal procedure according to various prevalence values. *Gut*. 1994 Jun 1;35(6):771-5.
  17. Casella S, Zanini B, Lanzarotto F, Villanacci V, Ricci C, Lanzini A. Celiac disease in elderly adults: clinical, serological, and histological characteristics and the effect of a gluten-free diet. *Journal of the American Geriatrics Society*. 2012 Jun;60(6):1064-9.
  18. Pallav K, Leffler DA, Tariq S, Kabbani T, Hansen J, Peer A, Bhansali A, Najarian R, Kelly CP. Noncoeliac enteropathy: the differential diagnosis of villous atrophy in contemporary clinical practice. *Alimentary pharmacology & therapeutics*. 2012 Feb;35(3):380-90.
  19. Shah VH, Rotterdam H, Kotler DP, Fasano A, Green PH. All that scallops is not celiac disease. *Gastrointestinal endoscopy*. 2000 Jun 1;51(6):717-20.
  20. Cammarota G, Martino A, Pirozzi GA, Cianci R, Cremonini F, Zuccalà G, Cuoco L, Ojetti V, Montalto M, Vecchio FM, Gasbarrini A. Direct visualization of intestinal villi by high-resolution magnifying upper endoscopy: a validation study. *Gastrointestinal endoscopy*. 2004 Nov 1;60(5):732-8.
  21. Rubin CE, Brandborg LL, Phelps PC, Taylor HC. Studies of celiac disease: I. The apparent identical and specific nature of the duodenal and proximal jejunal lesion in celiac disease and idiopathic sprue. *Gastroenterology*. 1960 Jan 1;38(1):IN1.
  22. Oberhuber G, Granditsch G, Vogelsang H. The histopathology of coeliac disease: time for a standardized report scheme for pathologists. *European journal of gastroenterology & hepatology*. 1999 Oct;11(10):1185-94.
  23. Cummins AG, Alexander BG, Chung A, Teo E, Woenig JA, Field JB, Thompson FM, Roberts-Thomson IC. Morphometric evaluation of duodenal biopsies in celiac disease. *The American journal of gastroenterology*. 2011 Jan;106(1):145.
  24. Rubio-Tapia A, Rahim MW, See JA, Lahr BD, Wu TT, Murray JA. Mucosal recovery and mortality in adults with celiac disease after treatment with a gluten-free diet. *The American journal of gastroenterology*. 2010 Jun;105(6):1412.
  25. Carroccio A, Mansueto P, Iacono G, Soresi M, D'alcamo A, Cavataio F, Brusca I, Florena AM, Ambrosiano G, Seidita A, Pirrone G. Non-celiac wheat sensitivity diagnosed by double-blind placebo-controlled challenge: exploring a new clinical entity. *The American journal of gastroenterology*. 2012 Dec;107(12):1898.
  26. Hadithi M, von Blomberg BM, Crusius JB, Bloemena E, Kostense PJ, Meijer JW, Mulder CJ, Stehouwer CD, Pena AS. Accuracy of serologic tests and HLA-DQ typing for diagnosing celiac disease. *Annals of internal medicine*. 2007 Sep 4;147(5):294-302.
  27. Kurppa K, Collin P, Viljamaa M, Haimila K, Saavalainen P, Partanen J, Laurila K, Huhtala H, Paasikivi K, Mäki M, Kaukinen K. Diagnosing mild enteropathy celiac disease: a randomized, controlled clinical study. *Gastroenterology*. 2009 Mar 1;136(3):816-23.
  28. Charan J, Biswas T. How to calculate sample size for different study designs in medical research?. *Indian journal of psychological medicine*. 2013 Apr;35(2):121.
  29. Ludvigsson JF, Bai JC, Biagi F, Card TR, Ciacci C, Ciclitira PJ, Green PH, Hadjivassiliou M, Holdaway A, Van Heel DA, Kaukinen K. Diagnosis and management of adult coeliac disease: guidelines from the British Society of Gastroenterology. *Gut*.

- 2014 Aug 1;63(8):1210-28.
30. Green PH, Cellier C. Celiac disease. *New England Journal of Medicine*. 2007 Oct 25;357(17):1731-43.
  31. Rostami-Nejad M, Ishaq S, Al Dulaimi D, Zali MR, Rostami K. The role of infectious mediators and gut microbiome in the pathogenesis of celiac disease. *Archives of Iranian Medicine (AIM)*. 2015 Apr 1;18(4).
  32. Da Silva Neves MM, González-García MB, Nouws HP, Delerue-Matos C, Santos-Silva A, Costa-García A. Celiac disease diagnosis and gluten-free food analytical control. *Analytical and Bioanalytical Chemistry*. 2010 Jul 1;397(5):1743-53.
  33. AL-Kenzawi A A H.(2006). Evaluation of immunological and pathological assays for diagnosis celiac disease in Iraqi patients .Msc. th. Baghdad Univ;45.
  34. Al-Saadi HA, Abid AH. Celiac disease in Karbala. *Journal of Kerbala University*. 2009;7(2):51-61.
  35. Kamil L M.(2015). Evaluation of coeliac disease serological markers. *J. Fac. Med. Baghdad*;57(2):156-159.
  36. Ivarsson A, Persson LÅ, Nyström L, Ascher H, Cavell B, Danielsson L, Dannaeus A, Lindberg T, Lindquist B, Stenhammar L, Hernell O. Epidemic of coeliac disease in Swedish children. *Acta Paediatrica*. 2000 Feb;89(2):165-71.
  37. Mariné M, Farre C, Alsina M, Vilar P, Cortijo M, Salas A, Fernández-Bañares F, Rosinach M, Santaolalla R, Loras C, Marquès T. The prevalence of coeliac disease is significantly higher in children compared with adults. *Alimentary Pharmacology & Therapeutics*. 2011 Feb;33(4):477-86.
  38. Fasano A, Catassi C. Current approaches to diagnosis and treatment of celiac disease: an evolving spectrum. *Gastroenterology*. 2001 Feb 1;120(3):636-51.
  39. Giorgio F, Principi M, Losurdo G, Piscitelli D, Iannone A, Barone M, Amoroso A, Ierardi E, Di Leo A. Seronegative celiac disease and immunoglobulin deficiency: where to look in the submerged iceberg?. *Nutrients*. 2015 Sep;7(9):7486-504.
  40. Megiorni F, Mora B, Bonamico M, Barbato M, Montuori M, Viola F, Trabace S, Mazzilli MC. HLA-DQ and susceptibility to celiac disease: evidence for gender differences and parent-of-origin effects. *The American Journal of Gastroenterology*. 2008 Apr;103(4):997.
  41. Green PH, Stavropoulos SN, Panagi SG, Goldstein SL, McMahon DJ, Absan H, Neugut AI. Characteristics of adult celiac disease in the USA: results of a national survey. *The American Journal of Gastroenterology*. 2001 Jan;96(1):126.
  42. Vitoria JC, Arrieta A, Astigarraga I, Garcia-Masdevall D, Rodriguez-Soriano J. Use of serological markers as a screening test in family members of patients with celiac disease. *Journal of Pediatric Gastroenterology and Nutrition*. 1994 Oct;19(3):304-9.
  43. Grover R, Puri AS, Aggarwal N, Sakhuja P. Familial prevalence among first-degree relatives of celiac disease in North India. *Digestive and Liver Disease*. 2007 Oct 1;39(10):903-7.
  44. Mustalahti K, Sulkanen S, Holopainen P, Laurila K, Collin P, Partanen J, Mäki M. Coeliac disease among healthy members of multiple case coeliac disease families. *Scandinavian Journal of Gastroenterology*. 2002 Jan 1;37(2):161-5.
  45. Gillett PM, Gillett HR, Israel DM, Metzger DL, Stewart L, Chanoine JP, Freeman HJ. High prevalence of celiac disease in patients with type 1 diabetes detected by antibodies to endomysium and tissue transglutaminase. *Canadian Journal of Gastroenterology and Hepatology*. 2001;15(5):297-301.
  46. Jabour HJ, Rahman SA. The prevalence of Celiac Disease in Iraqi children and adolescents with type 1 Diabetes Mellitus. *Journal of Pharmaceutical Sciences and Research*. 2018 Sep 1;10(9):2289-91.

# Evaluating the Sensitivity of (miR-378) as a Circulatory Screening Biomarker for Diabetic Cardiomyopathy: Comparative Study

Sana Abdul-Jabbar Ali<sup>1</sup>, Hyder Hashim Al-Shlah<sup>2</sup>, Mais Mazin Al-Hamdani<sup>3</sup>, Oday Jasim Al-salihi<sup>2</sup>

<sup>1</sup>Assistant Lecturer, Al-Safwa University, Iraq, <sup>2</sup>Prof., Faculty of Medicine/Babylon University/Iraq,

<sup>3</sup>Assistant Lecturer, Faculty of Pharmacy/Al-Ayn University/Iraq

## Abstract

**Background:** Diabetic cardiomyopathy is one of the serious complication of diabetes mellitus, with a silent development and it is often underestimated, Currently available diagnostic techniques are limited in their ability to identify patients who present with uncommon symptoms or silent myocardopathy in its early stages.

**Aim:** To evaluate role of miRNA-378 compared to GLS as a sensitive biomarker for early detection of subclinical diabetic cardiomyopathy.

**Method:** This case control study involved 75 DM2 patients from Merjan Medical City in addition to age and sex-matched 25 apparently healthy subjects . The echocardiographic assessment for GLS was done for control group (H) and normotensive diabetic patients and these patients were divided into (CD) group without cardiomyopathy, and (M)group with cardiomyopathy diagnosed by negative GLS and positive GLS, respectively. Group (F) include Hypertensive and/or ischemic diabetic patients with overt heart failure . conventional Echocardiography was performed to all patients and control groups, all of them were of normal EF, except group F who have EF less than 40%. Bloodsampling was done for all and miRNA extraction and analysis done according to the manufacturer recommendations.

**Results:** There is significant elevation in miR-378 Ct value between H in one side & other three diabetic gps. (CD, M, F) as presented in table (3-17) ( $p < 0.05$ ). There is significant elevation in miR-378 Ct value in M than CD groups. There is significant elevation in Ct value in F than M gp. ( $p=0.000$ ). In the ROC curve (AUC) was 0.965. The sensitivity and specificity were 0.978 and 0.646, respectively according to the chosen cut-off value.

**Conclusion:** This study showed that miRNA-378 could be regarded as a novel sensitive biomarker which could play a significant role for early detection of subclinical diabetic cardiomyopathy.

**Keywords:** *Diabetic cardiomyopathy, screening, GLS, sensitivity, miRNA-378.*

## Introduction

Diabetic cardiomyopathy was first described by Rubler in 1972<sup>[1,2]</sup>. The term describes several mechanisms involved in the pathogenesis of this entity

including changes in myocardial structure and metabolism that are not directly attributed to other co-morbidities such as coronary artery disease (CAD) or hypertension. Left ventricular hypertrophy, myocardial lipotoxicity, increased oxidative stress, cell death from apoptosis, impaired contractile reserve, altered substrate utilization as free fatty acids (FFA), mitochondrial dysfunction and fibrosis are among the mechanisms involved with these changes in structure and metabolism contributing to the progression of heart failure<sup>[2]</sup>. In particular,

---

### Corresponding Author:

**Sana Abdul-Jabbar Ali**

Assistant Lecturer, Al-Safwa University, Iraq

e-mail: saagzz2012@yahoo.com

fibrosis is one of the abnormalities that can be evaluated with the newer imaging techniques. Cardiac magnetic resonance (CMR) is the gold standard in the assessment of myocardial fibrosis given that T1 sequences separate normal from fibrotic tissue<sup>[3]</sup>. Nonetheless, CMR is not widely available, and it is time and cost consuming with longer and exhausting protocols. Speckle tracking echocardiography has been validated against magnetic resonance imaging<sup>[4,5]</sup>. Global longitudinal strain (GLS) is the simplest deformation parameter specified by Speckle tracking echocardiography and probably the closest to routine clinical application<sup>[6]</sup>. Quantitative assessment of myocardial function is now possible with this technique<sup>[7]</sup>. Routine use of Speckle tracking echocardiography in daily clinical practice is not cost-effective in this scenario and currently impractical for large-scale population screening. Therefore, assessment of individual risk factors becomes very important in clinical practice especially in primary care settings. More than half of patients with heart failure have preserved ejection fraction (HFpEF) <sup>[8]</sup>. Monitoring of the serum biomarkers such as brain natriuretic peptide (BNP), cardiac troponins and MMPs is a cornerstone of clinical management of DbCM. However, these markers are expressed in <60% of cases, In several studies, BNP proved to be a suboptimal screening test to detect pre-clinical LV dysfunction or LVH <sup>[9, - 11]</sup>. For all these reasons novel sensitive markers are needed. Although many substances have been suggested as biomarkers for DbCM, none have qualified for clinical use. Diagnosis and therapies are difficult because of a lack of specific biomarkers and imaging techniques. There is a need to anticipate the progression of heart failure in patients with diabetes and for that reason we propose a strategy of non-invasive analysis of inflammation-fibrosis LVD. The detection of appropriate biomarkers could potentially permit routine population-wide screening, allowing early diagnosis and anticipation of cardiac

dysfunction, and stratify these subclinical cases<sup>[12, 13]</sup>. MicroRNAs (miRNAs) are short noncoding RNAs that modify gene expression by regulating mRNA stability or translation during various disease processes. Each mRNA regulates expression of multiple genes. Dysregulated miRNAs are potentially involved in the pathogenesis of DbCM <sup>[14]</sup>. There are multiple miRNAs that have been implicated with the progression of disease. After release from the cell, these molecules remain stable in extracellular fluids and can be measured by quantitative polymerase chain reaction (qPCR)<sup>[15]</sup>. Clinical studies have proposed peripheral blood microRNAs (miRNAs) as sensitive, specific and non-invasive biomarkers for the early monitoring of alterations in cardiac viability, structure, and function. Distinctive circulating miRNA signatures with clinical value have been described in various cardiomyopathies and type 2 diabetes and its related vascular complications<sup>[16]</sup>. miRNA-378 has emerged as a new biomarker in diabetic heart failure and has a strong relationship with inflammation and fibrosis <sup>[17]</sup>. The goal of the present study was to evaluate the usefulness of miR-378, as a serum biomarkers of DbCM in an unselected patient sample. To determine whether this miRNAs would be equally appropriate as serum biomarkers, it was tested in this study in a group consisting of 75 diabetic patients. The utility of that miRNA as a serum biomarker was evaluated by comparing its sensitivity to that of GLS.

### Subjects, Materials and Method

**Subjects:** From May 2018 to April 2019, a total of 75 patients with DM2 and 25 control subjects who were aged 40–65yr were prospectively enrolled from Diabetic Center, CCU, and Echo Unit in Merjan Medical City (M.M.C.) admitted as diagnosed cases of DM2 by expert physicians. Each 25 patients group has a definite characters as in table (1).

**Table (1): Diagnostic criteria of study groups**

CD group	Normotensive diabetic patients without cardiomyopathy diagnosed by negative strain echo study
M group	Normotensive diabetic patients with cardiomyopathy diagnosed by positive strain echo study
F group	Hypertensive and/or ischemic diabetic patients with heart failure diagnosed by conventional echo study
H group	Apparently healthy subjects with negative strain echo study

**Clinical Evaluation:** All subjects underwent a questionnaire include: medical history which involve: history of DM2 and its duration, ischemic heart disease,

hypertension, family history of DM2, medications already taken and alcohol consumption history. Previous history of ischemic heart disease (IHD) was considered

positive if there was any history of admission to CCU with records by physician suggestive of IHD. The absence of ischemia and structural abnormalities was verified in groups M, CD, and H. Nonischemic is defined by normal resting ECG and negative stress ECG test. Structural abnormalities were excluded by normal resting conventional echo study having EF% >50%.

The questionnaire includes also socio demographic measures involving: age, gender. In addition to those

the questionnaire includes anthropometric measures involving BMI which was calculated from the measured height and weight and categorized into the following categories: normal BMI <25, over weight BMI (25-29.9) and obese  $\geq 30 \text{ kg/m}^2$ . All were subjected to clinical examination including, heart rate and blood pressure. Further clinical details are shown in Supplementary Table (2).

**Table (2): Clinical data for patients in all study groups and control subjects**

Variables	Groups			
	CD group	M group	F group	H group
Total number (n)	25	25	25	25
Age/Mean $\pm$ SD	52.76 $\pm$ 6.3	53.04 $\pm$ 6.2	58.44 $\pm$ 5.9	50.88 $\pm$ 8.1
Gender	Male	14	15	18
	Female	11	10	7
BMI (Kg/m <sup>2</sup> )/Mean $\pm$ SD	26.4 $\pm$ 4.1	32.1 $\pm$ 5.3	30.6 $\pm$ 3.5	29.2 $\pm$ 5.9
Family history of DM2	+ve	19	17	18
	-ve	6	8	7
HbA1c%	8.5 $\pm$ 2.3	8.9 $\pm$ 2.3	9.1 $\pm$ 2.2	4.4 $\pm$ 0.27

## Method

**Echocardiography:** The gold standard biomarker of diagnosis was GLS% which was defined as the average longitudinal strain at end-systole in 18 segments. By regarding cut-off value of GLS = -18% according to (Islam E. Shehata et al<sup>[18]</sup> who reported that a GLS cutoff of <-18.1% was able to accurately “predict subclinical LV systolic dysfunction”.

**Strain echocardiography:** Speckle tracking strain mode was selected on the echo-machine during apical 4, 2 and 3-chamber imaging and three consecutive cycles were recorded at a frame rate of 60 to 80 frame/sec. The LV is divided into 6 walls (inferoseptum, lateral, anterior, inferior, posterior and anteroseptal walls) every wall is divided into basal, mid and apical segments except the anteroseptum and posterior wall divided into basal and mid segments only, the global PLSL value for each participant were calculated as the average of values of the 16 segments<sup>[18]</sup>.

The adequacy of the tracking was verified visually, and if tracking was deemed suboptimal, a manual

adjustment of both the endocardial and epicardial border was performed. If tracking was still judged unsatisfactory, the subjects were excluded from the analysis. Strain curve were extracted from an average of three cycles of tissue Doppler imaging data, using an IBM computer and developmental software (Formtest V6.1; GE Vingmed).

**Blood collection and Laboratory method:** Venous blood was acquired by venipuncture without anticoagulant treatment. Samples were centrifuged and subsequently aliquoted and stored at -80°C prior to analysis. For RNA isolation, an miRNeasy Mini Kit (Sigma/USA) was used to extract total RNA from 500  $\mu\text{l}$  of serum. Reverse transcription (RT) was performed using a TaqMan MicroRNA Reverse Transcription Kit (Sigma/USA). The RT product was preamplified, and level of miR-378-5p (assay MIRAP00354) were measured by qPCR using a TaqMan miRNA assay (Applied Biosystems). miRNA species with CT value  $\geq 35$  were considered below the detection threshold. The serum miRNA expression levels in individual samples were determined by a TaqMan probe-based RT-qPCR



on a 7300 Real-Time PCR Sequence Detection System (Applied Biosystems). Because U6 and 5S rRNA are degraded in serum samples and the lack of a consensus housekeeping miRNA for the RT-qPCR analysis of serum miRNAs, miRNA expression was normalized to serum volume [19]. For serum and exosome samples. Influence of haemolysis was discarded by analysing the Ct values of miR-23a and miR-451a [20].

**Statistical Analysis:** Statistical analysis was performed using SPSS version 20. Data were expressed as (mean  $\pm$  SD). ANOVA test was used to compare means of more than 2 groups. P values less than (0.05) were considered significant. Receiver operating characteristic (ROC) analysis was performed to evaluate the discriminatory power of the markers analyzed. We chose Ct = 20.06 as the cutoff value to evaluate sensitivity and specificity of miRNA-378 in this study.

## Results and Discussion

**The difference in miRNA-378 circulating level in different study groups:** There is significant elevation in the Ct value of miR-378 with the progression of the diabetic cardiomyopathy as presented in table (4) indicating its down regulation as the disease progress. This result agreed with (Rui Guo et al) who classify miR-378 as anti-hypertrophic miRNAs as it is downregulated with the development of DbCM [21].

This result disagreed with (Sarah Costantino,) who stated that miR-378 is one of key initiators of apoptosis, were significantly overexpressed in the diabetic heart and intensive glycemic control was unable to revert these changes [22]. The complex biology of miRNAs may also influence the respective findings. The miRNA profile of a given cell is highly specific to the stressor which it is exposed and suggests that miRNA expression in the human heart is dynamically regulated as a function of the pathophysiological context [23].

There is significant elevation in miR-378 Ct value between H & other three diabetic gps. (CD, M, F) as presented in table (5)  $p < 0.05$ ; which represent its relevance to DM2. This result agreed with (Ivana Knezevic et al) who reported that in tissues such as fibroblasts and fetal hearts, where insulin-like growth factor receptor-1 (IGF1R) levels are high, we found either

absent or significantly low miR-378 levels, suggesting an inverse relationship between these two factors [24]. IGF-R are hybrid receptors which are more abundant when insulin receptors are down-regulated in response to the hyperinsulinemia as seen in insulin-resistant patients with DM2 as stated by Liam J. Murphy [25] Also it agreed with (Assmann et al [26]) who stated that it is downregulated with DM2. miR-378 down regulation relevance to DM2 approved by (Yong Zhang et al [27]) when they found that Tg mice had a significant overall increase in body O<sub>2</sub> consumption, CO<sub>2</sub> production, and energy expenditure.

The significant elevation in miR-378 Ct value in M than CD groups indicate its downregulation with the development of cardiomyopathy in its subclinical state as that miR-378 downregulated in case of hypertrophy development and oxidative stress increase [28]. These findings confirm the potential role of these modulators in identifying DbCM in relevance to their role in mitochondrial metabolism of cardiomyocyte via FoxO-1 as presented by (Puthanveetil, P. [29]) who stated that overexpression of FoxO1 mimics a hyperglycemic effect on vascular endothelium and also that hyperglycemia-induced endothelial dysfunction is mediated through FoxO1. miR-378 mimics reduced Akt phosphorylation also resulted in decreased phosphorylation of FoxO1, ultimately leading to FoxO1 activation. This effect was also perceived in a H<sub>2</sub>O<sub>2</sub>-induced oxidative stress model in rat cardiomyocytes. So downregulation of miR-378 resulted in increased expression of FoxO1 which resulted in mitochondrial dysfunction trigger cardiac cell death in diabetic heart disease.

There is significant elevation in Ct value in F than M gp. ( $p = 0.000$ ) which indicate more downregulation of miR-378 in F gp. than M gp. as presented in table (5). This lower expression may be due to different pathophysiological background related to hypertension & ischemia as concluded by (Jan Fiedler et al [30]) who published that presence of miR-378 attenuated ischemia-induced apoptosis by inhibiting caspase-3 expression in cardiac myocytes and blunted cardiac hypertrophy and dysfunction upon cardiac overload by targeting Ras signaling. So may be the ischemic hypertensive metabolic changes resulted in downregulation of miR-378.

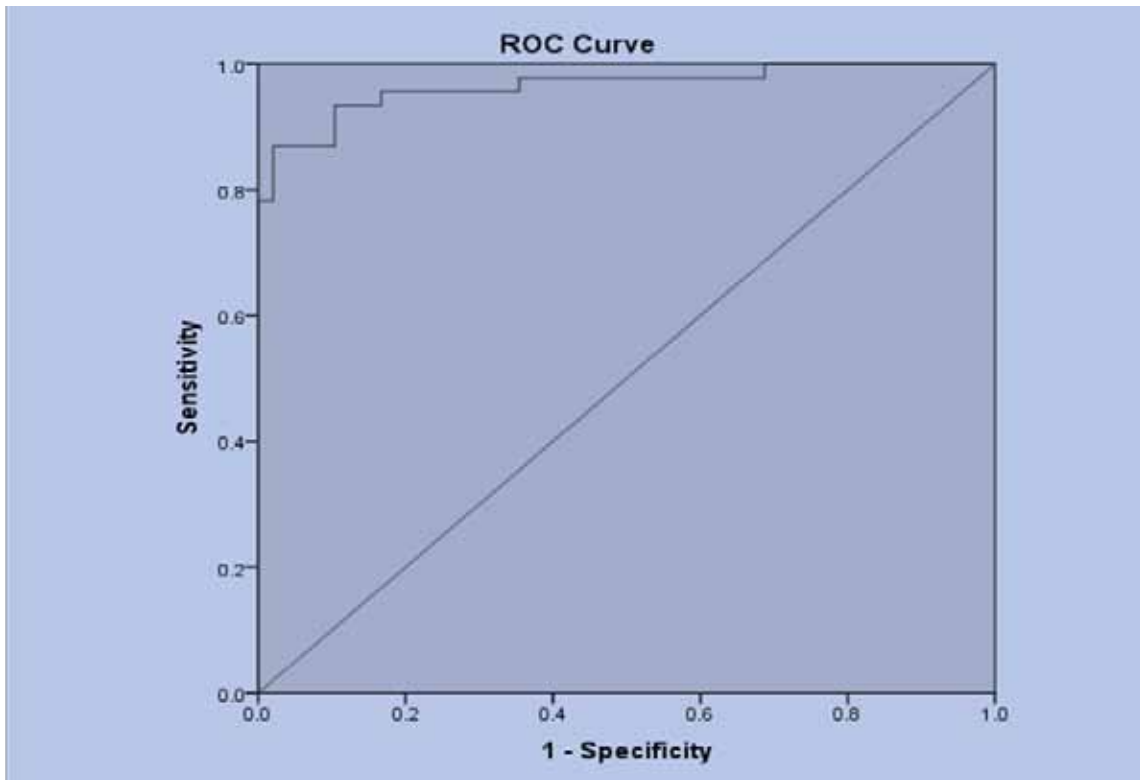
**Table (4) ANOVA–All Groups with Ct of miR-378**

Descriptive				
Ct of miR-378				
Groups	Mean	Std. Deviation ±	95% Confidence Interval for Mean	
			Lower Bound	Upper Bound
CD	19.6	2.1	18.80208	20.54192
F	30.4	3.4	28.97827	31.89006
H	17.6	2.9	16.30735	18.89526
M	25.9	3.4	24.39589	27.45138

**Table (5): Comparison between groups**

Multiple Comparisons					
Dependent Variable: Ct of miR-378					
LSD					
Groups		Mean Difference	p-value	95% Confidence Interval	
				Lower Bound	Upper Bound
H	CD	-2.070	.020	-3.80996-	-.33143-
	F	-12.832	.000	-14.58941-	-11.07632-
	M	-8.322	.000	-10.11752-	-6.52714-
M	CD	6.251	.000	4.49190	8.01137
	F	-4.510*	.000	-6.28734-	-2.73372-

\*The mean difference is significant at the 0.05 level



**Figure (1): ROC curves for miRNA-378 Ct value in all study groups**

**miRNA-378 as a screening marker:** To evaluate the potential diagnostic value of miRNA-378, the ROC curve has been used. For cut-off value, values exceeding the cut-off are positive, while those below the cut-off are negative.

It is found that the area under the ROC curve (AUC) was 0.965 (Fig. 1). The sensitivity and specificity were 0.978 and 0.646, respectively. The cut-off Ct value was 20.06, it was appeared to have independent associations with the clinical end-points that are studied. As a blood-based marker, the miR-378 characteristics as highly sensitivemay improve the screening values of DbCM. These results suggested that miR-378 may be highly sensitive and moderately specific enough to detect DbCM.

The extremely high sensitivity (0.978) of miR-378 to identify DbCM patients from non-symptomatic diabetic individuals exceeded our most optimistic expectations.

These findings strengthen the clinical applicability of circulating miR-378 as a biomarker of diabetic cardiomyopathy in type 2 diabetes patients.

### Conclusion

Serum miR-378 expression level can be regarded as a non-invasive tool to improve the detection, prediction, and monitoring of cardiac-related complications in the early stages of diabetes.

### Ethical Issues:

- a. Approval of scientific committee of the Clinical Biochemistry Department in Babylon Medical College/University of Babylon/Iraq.
- b. Approval of Babylon Health Directorate/Ministry of Health & Information Center for Research & Development of Babylon Province.
- c. The objectives and methodology were explained to all participants in the current study and their vocal consent was gained.

**Conflict of Interest:** The authors declare no competing interest on this paper.

**Funding:** Self-funding by all authors in equal percentage.

### References

1. Rubler S, Dlugash J, Yuceoglu YZ, et al. New type of cardiomyopathy associated with diabetic glomerulosclerosis. *Am J Cardiol.* 1972;30:595---602.
2. Boudina S, Abel ED. Diabetic cardiomyopathy, causes and effects. *Rev Endocr Metab Disord.* 2010;11:31---9.
3. Saeed M, Van TA, Krug R, et al. Cardiac MR imaging: current status and future direction. *Cardiovasc Diagn Ther.* 2015;5:290---310.
4. Amundsen BH, Helle-Valle T, Edvardsen T, et al. Noninvasive myocardial strain measurement by speckle tracking echocardiography: validation against sonomicrometry and tagged magnetic resonance imaging. *J Am Coll Cardiol.* 2006;47:789---93.
5. Saito M, Okayama H, Yoshii T, et al. Clinical significance of global two-dimensional strain as a surrogate parameter of myocardial fibrosis and cardiac events in patients with hypertrophic cardiomyopathy. *Eur Heart J Cardiovasc Imaging.* 2012;13:617---23.
6. Yingchoncharoen T, Agarwal S, Popovic ZB, et al. Normal ranges of left ventricular strain: a meta-analysis. *J Am Soc Echocardiogr.* 2013;26:185---91.
7. Mor-Avi V, Lang RM, Badano LP, et al. Current and evolving echocardiographic techniques for the quantitative evaluation of cardiac mechanics: ASE/EAE consensus statement on methodology and indications endorsed by the Japanese Society of Echocardiography. *Eur J Echocardiogr.* 2011;12:167---205.
8. Hogg K, Swedberg K, McMurray J. Heart failure with preserved left ventricular systolic function; epidemiology, clinical characteristics, and prognosis. *J Am Coll Cardiol.* 2004;43:317---27.
9. Fang ZY, Schull-Meade R, Leano R, Mottram PM, Prins JB, Marwick TH. Screening for heart disease in diabetic subjects. *Am Heart J* 2005 Feb 1;149(2):349-354.
10. Redfield MM, Rodeheffer RJ, Jacobsen SJ, Mahoney DW, Bailey KR, Burnett JC. Plasma brain natriuretic peptide to detect preclinical ventricular systolic or diastolic dysfunction. A community-based study. *Circulation* 2004;109:3176-3181.
11. Kiencke S, Handschin R, von Dahlen R, et al. Pre-clinical diabetic cardiomyopathy: prevalence, screening, and outcome. *Eur J Heart Fail* 2010

- Sep;12(9):951-957.
12. Devereux RB, Roman MJ, Paranicas M, et al. Impact of diabetes on cardiac structure and function: the Strong Heart Study. *Circulation* 2000;101:2271-2276.
  13. Swoboda PP, McDiarmid AK, Erhayiem B, et al. Diabetes mellitus, microalbuminuria, and subclinical cardiac disease: identification and monitoring of individuals at risk of heart failure. *J Am Heart Assoc* 2017 Jul 1;6(7), e005539.
  14. Quiat D, Olson EN. MicroRNAs in cardiovascular disease: from pathogenesis to prevention and treatment. *J Clin Invest* 2013 Jan;123(1):11-18 <https://doi.org/10.1172/JCI62876>.
  15. de Gonzalo-Calvo, D., Cenarro, A., Civeira, F. & Llorente-Cortes, V. microRNA expression profile in human coronary smooth muscle cell-derived microparticles is a source of biomarkers. *Clin Investig Arterioscler.* 28, 167–177 (2016).
  16. Ortega, F. J. et al. Profiling of circulating microRNAs reveals common microRNAs linked to type 2 diabetes that change with insulin sensitization. *Diabetes Care.* 37, 1375–1383 (2014).
  17. Guo R, Nair S. Role of microRNA in diabetic cardiomyopathy: from mechanism to intervention. *Biochim Biophys Acta (BBA)-molecular basis Dis.* 2017;1863(8):2070–7.
  18. Shehata IE, Eldamhory AS, Shaker A. Early predictors of left ventricular dysfunction in hypertensive patients: comparative cross-section study. *Int J Cardiovasc Imaging.* 2020;1–10.
  19. Wang J, Pei Y, Zhong Y, Jiang S, Shao J, Gong J. Altered Serum MicroRNAs as Novel Diagnostic Biomarkers for Atypical Coronary Artery Disease. 2014;9(9).
  20. Blondal, T. et al. Assessing sample and miRNA profile quality in serum and plasma or other biofluids. *Method.* 59, S1–6 (2013).
  21. Guo R, Nair S. Role of microRNA in diabetic cardiomyopathy: from mechanism to intervention. *Biochim Biophys Acta (BBA)-molecular basis Dis.* 2017;1863(8):2070–7.
  22. Costantino S, Paneni F, Lüscher TF, Cosentino F. MicroRNA profiling unveils hyperglycaemic memory in the diabetic heart. *Eur Heart J.* 2015;37(6):572–6.
  23. Waldenström, A., Genneback, N., Hellman, U. & Ronquist, G. Cardiomyocyte microvesicles contain DNA/RNA and convey biological messages to target cells. *PLoS One.* 7, e34653 (2012).
  24. Knezevic I, Patel A, Sundaresan NR, Gupta MP, Solaro RJ, Nagalingam RS, et al. A novel cardiomyocyte-enriched MicroRNA, miR-378, targets insulin-like growth factor 1 receptor implications in postnatal cardiac remodeling and cell survival. *J Biol Chem.* 2012;287(16):12913–26.
  25. Liam J. Murphy, Insulin-Like Growth Factor-I: A Treatment for Type 2 Diabetes Revisited, *Endocrinology*, Volume 147, Issue 6, 1 June 2006, Pages 2616–2618
  26. Assmann TS, Recamonde-Mendoza M, Costa AR, Puñales M, Tschiedel B, Canani LH, et al. Circulating miRNAs in diabetic kidney disease: case-control study and in silico analyses. *Acta Diabetol.* 2019;56(1):55–65.
  27. Zhang Y, Li C, Li H, Song Y, Zhao Y, Zhai L, et al. miR-378 activates the pyruvate-PEP futile cycle and enhances lipolysis to ameliorate obesity in mice. *EBioMedicine.* 2016;5:93–104.
  28. Nagalingam RS, Sundaresan NR, Gupta MP, Geenen DL, Solaro RJ, Gupta M. A cardiac-enriched microRNA, miR-378, blocks cardiac hypertrophy by targeting Ras signaling. *J Biol Chem.* 2013;288(16):11216–32.
  29. Puthanveetil P. FoxO1-miRNA interacting networks as potential targets for mitochondrial diseases. *Drug Discov Today.* 2019;24(1):342–9.
  30. Fiedler J, Baker AH, Dimmeler S, Heymans S, Mayr M, Thum T. Update on non-coding RNAs in vascular disease—from basic discoveries to clinical applications. *Cardiovasc Res.* 2018.

# Using the Digital Occlusal Analysis (T-Scan NOVUS) in Diagnosis the MFDS in Iraqi Patients During Lateral Excursion Movements

Sanaa Abdul Hameed Hussein<sup>1</sup>, Jamal N. Ahmed<sup>2</sup>

<sup>1</sup>Researcher B.D.S M.Sc., <sup>2</sup>B.D.S., M.S., Ph.D. Prof., College of Dentistry, University of Baghdad, Iraq

## Abstract

The aim of the study is to evaluate the effectiveness of digital occlusal analysis (T- scan) in diagnosis the patients with MFDS during lateral excursion movements. Method and materials: participants with full dentition and angle class I relation. Patients diagnosed based on DC/TMD criteria, digital occlusal analysis including (disclusion time, occlusion time) registered by T-Scan NOVUS device during the excursion movements in both (Right and Left) sides. Results: Non-significant differences between the age groups, a significant differences between the gender groups and the females were more prevalent than the males, all the means values of occlusal parameters (disclusion time, occlusion time) were higher in MPDS patients group than healthy control group, Highly significant difference according (disclusion time, occlusion time) are documented between MPDS patients and the healthy control in lateral excursion movements (R & L). Conclusion: This study concluded, that the digital occlusal analysis measured by T scan Novus devise is a more accurate and objective method in diagnosis the patients with MPDS during lateral excursion movements.

**Keywords:** Occlusion time, disclusion time, occlusal force, MFDS, T-scan, OT, DT, lateral excursion.

## Introduction

Myofascial pain is one of the most common types of chronic musculoskeletal pain in clinical medicine<sup>(1,2)</sup>. A hyperirritable spot in a palpable taut band of skeletal muscle fibers, and having MTrPs is necessary to confirm the diagnosis of myofascial pain<sup>(3)</sup>. Several possible mechanisms can lead to the development of myofascial trigger points, including low-level muscle contractions, contractures, direct trauma, muscle overload, postural stress<sup>(4,5,6)</sup>. Dynamic stability in relation to the TMJ is the characteristic of the joint to achieve normal function<sup>(7)</sup>.

T-Scan is a digital occlusion analysis system that records and measures tooth contact, force, and timing

in real-time (8, 9 and 10). The Disclusion Time is defined as the duration of time that working and non-working molars and premolars are in contact during a mandibular excursive movement<sup>(11)</sup>. The more time taken for excursive movement (>0.4sec) leads to longer compression of the periodontal ligament, thereby leading to muscle hyperactivity<sup>(12)</sup>. The time reported from the first occlusal contact until reaching the maximum intercuspation is known as Occlusion Time (OT)<sup>(13)</sup>. According to the manufacturer, OT is recommended as less than 0.2 seconds<sup>(14, 15)</sup>. OT has been considered as a capable description of occlusion<sup>(16)</sup>.

## Method and Materials

This study was designed and conducted in the department of oral medicine in the teaching hospital of College of Dentistry/University of Baghdad in period from April 2019 to February 2020. The participants were selected according to the Diagnostic Criteria for Temporomandibular Disorders<sup>(17)</sup> after obtaining ethical approval from the institutional ethical committee and written informed consent. The participants completed

---

### Corresponding Author:

**Sanaa Abdul Hameed Hussein**

Researcher B.D.S M.Sc., College of Dentistry,  
University of Baghdad, Iraq  
e-mail: dr.sanaa1985@yahoo.com

a self-reported questionnaire, containing information about personal, medical, and dental histories.

Digital occlusal analysis including Disclusion time (DT) and Occlusion time (OT) registered using the T-Scan NOVUS system (T-Scan, Tekscan, Inc., S. Boston, MA, USA) system, shown in figure (1). Subjects with full dentition, Angle class I relation and no history of any systemic diseases related to both groups (patients and controls) which included in this study, while any patient has ongoing treatments or recently treated from TMJ disorders excluded from this study.

Analysis of data was carried out using the available statistical package of SPSS-25. The significance of difference of different means (quantitative data) were tested using Paired-t-test for difference of paired observations (or two dependent means. The significance of difference of different percentages (qualitative data) were tested using Pearson Chi-square test ( $\chi^2$ -test) with application of Yate's correction or Fisher Exact test whenever applicable. Statistical significance was considered whenever the P value was equal or less than 0.05.



**Figure 1: T-Scan (Novus) device**

## Results

One hundred and ten (110) participant were included in this study with age range (18-43) years old and divided into two main groups: diseased group (show signs and symptoms of myofascial pain syndrome) with (85) patients and (25) healthy controlled free from signs and symptoms of MPDS. The male: female ratio of the DG

was (17:68) and within the control group was (10:15). Table (1) showed the demographic characteristic of the study groups. There were no significant differences  $P > 0.05$  according to the age between the two study groups while according to gender this study reported a significant difference  $P \leq 0.05$  and the females were more predominant than males.

**Table (1) Demographic characteristic of the study groups.**

		Diseased group		Control group		P value
		No	%	No	%	
Age (Years)	<20y	11	11.9	1	4.0	0.356 <sup>NS</sup>
	20---29	28	33.3	10	40.0	
	30---39	31	36.9	12	48.0	
	=>40y	15	17.9	2	8.0	
	Mean±SD (Range)	30.5±8.3		30.5±6.3		
Gender	Male	17	20.0	10	40.0	0.012 <sup>S</sup>
	Female	68	80.0	15	60.0	

\*Significant difference between proportions using Pearson Chi-square test at 0.05 level, NS: Non-Significant, SD: Standard Deviation, No: Number, % Percentage

Table (2) represented the descriptive Statistics of [Disclusion time test] parameter in the studied groups during lateral excursion movement (Right and left). The results showed the mean values in diseased group

were higher than control group also a highly significant difference  $P < 0.01$  has been documented between the diseased and control groups.

**Table (2) Descriptive Statistics of [Disclusion time test] parameter in the studied groups distributed for different locations**

Locations	Groups	No.	Mean	SD	P-vale <sup>(*)</sup>
Right Lateral	Diseased	85	0.54	0.45	0.020 <sup>S</sup>
	Control	25	0.15	0.14	
Left Lateral	Diseased	85	0.69	0.46	0.056 <sup>S</sup>
	Control	25	0.24	10.69	

NO: Number; S: significant  $P \leq 0.05$

As shown in table (3) the occlusion time test parameter showed a significant difference  $P \leq 0.05$  between the diseased group and control group during the

excursion movements (R & L) and with average mean values higher in diseased group than control group.

**Table (3) Descriptive Statistics of [Occlusion time test] parameter in the studied groups during lateral excursion movements (R & L)**

Locations	Groups	No.	Mean	SD	P-vale <sup>(*)</sup>
Right Lateral	Diseased	85	0.57	0.39	0.053 <sup>S</sup>
	Control	25	0.10	0.28	
Left Lateral	Diseased	85	0.45	0.34	0.036 <sup>S</sup>
	Control	25	0.12	0.16	

S: Sig. at  $P < 0.05$ , SD slandered deviation, NO: number

## Discussion

This study illustrated that no differences  $P > 0.05$  in age groups while according to the gender a significant difference  $P \leq 0.05$  was reported among studied groups. Also, the study showed MFDS is more common in females than males, with several studies registered a high prevalence of TMDs in females patients<sup>(18,19,20)</sup> which agree with current study. Pain intensity in women with TMD during the menstrual cycle was the highest and was associated with high concentrations of estrogen<sup>(21)</sup>, this result was in agreement with other recent study reported by<sup>(22)</sup> that demonstrated the presence of estrogen receptors in women's TMJs changes metabolic functions, increasing ligament laxity. Other potential reasons include neurophysiologic and psychosocial reasons that result in more severe and more frequent pain in females than in males<sup>(23)</sup>. The finding of gender difference s associating with TMD pain symptoms supports the previous studies<sup>(24, 25)</sup>. The previous findings stated that TMD is most common among 20- to 40-year-olds<sup>(26, 27, 28)</sup>, and these with agree the present study that showed a significant differences in TMD pain symptoms between age groups, but this study was in contrast with<sup>(29)</sup>. In certain cases of TMD or OFP, the etiology is at least partially related to occlusion in the form of excessive forces on individual teeth (high spots) or interferences to function<sup>(30)</sup>. These conditions can be readily detected by the T-Scan but not by just analyzing marks on the teeth<sup>(31)</sup>. The T-Scan measures both the relative force on each tooth and timing of the contacts, the practitioner can pinpoint any occlusal problem without guessing<sup>(32)</sup>. Prolonged excursive frictional contacts increase the total time PDL mechanoreceptors are compressed in excursive movements, where the PDL compression time is equal to the DT duration of that same excursion<sup>(33)</sup>. The more time the excursive interferences contact, the longer time the PDL are compressed, resulting in prolonged durations of masticatory muscle contractions<sup>(34)</sup>. The fact that mentioned above displayed in current study which all means of the diseased group were higher than the control group this agree with previous study documented by<sup>(35)</sup>. Ciavarella *et al.*,<sup>(36)</sup> illustrated that the prolonged disocclusion time, frequency of premature contacts and asymmetry in the occlusal force, intracapsular joint disorder lead to various temporomandibular joint related problems and this with agree with current study. Significantly longer disclusion time, higher posterior frictional contacts, and more TMD symptoms were observed in the post-orthodontic group, suggesting that orthodontic treatment

increases posterior tooth friction. Computerized occlusal analysis is an objective diagnostic tool determining the quality of excursive movements following orthodontic treatment<sup>(37)</sup>.

Specifically, Disclusion Time Reduction (DTR) of all molars and premolars to  $< 0.5$  seconds per lateral excursion has been shown to reduce muscle hyperactivity levels and their related myogenous symptoms pre to post treatment. Different authors using this technique have reported statistically significant differences in Disclusion Time durations, muscle contraction levels, Time-to-Muscle Shutdown durations, and rapid muscular TMD symptom resolutions<sup>(38)</sup>. This study has considered occlusion time (OT) and has shown that the differences between healthy patients and those suffering from MPS were statistically highly significant and the average values of occlusion time were longer in comparison to the control group, The results of this study are similar to the results of studies carried out by Baldini, Nota and Cozza in Italy<sup>(39)</sup>: occlusion time longer by 0.18 s was recorded among investigative groups whereas the results were statistically significant, also is agree with Wang and Yin who reported average value of occlusion time was  $1.36 \pm 0.03$  s longer than in the control group, whereas the average in patients with TMDs was as high as  $2.05 \pm 0.06$ <sup>(40)</sup>. When compared between current study and Agne Dzingute *et al.*,<sup>(41)</sup> previous study was in contrary statically but is agree about the TMD group has the average value 0.045 s longer in comparison to the control group related to OT. The T scan results showed both occlusion time and disclusion time in the patients with TMD disorders are significantly extended than the normal subjects<sup>(42)</sup>.

## Conclusion

This study concluded, MPDS is more prevalent in the females than males, Occlusal parameters included (DT and OT) recorded by digital occlusal analysis (T-scan) showed with more average values in MFDS patients than the control group and a high significant difference  $P \leq 0.01$  recorded between them. So the digital occlusal analysis measured by T scan Novus devise is a more accurate and objective method in diagnosis the patients with MPDS during lateral excursion movements.

**Conflict of Interest:** None

**Funding:** Self

**Ethical Clearance:** Not required



## References

1. Shah JP, Thaker N, Heimur J, Aredo JV, Sikdar S, Gerber L. Myofascial trigger points then and now: a historical and scientific perspective. *Pm R*. 2015;7(7):746–761.
2. Simons DG. New views of myofascial trigger points: etiology and diagnosis. *Arch Phys Med Rehabil*. 2008;89(1):157–159.
3. Gerwin RD. Myofascial trigger point pain syndromes. *Semin Neurol*. 2016;36(5):469–473
4. Bron, C., Dommerholt, J. D. (2012). Etiology of myofascial trigger points. *Current pain and headache reports*, 16(5), 439-444
5. Fernández-de-las-Peñas, C., Cuadrado, M. L., Arendt-Nielsen, L., Simons, D. G., Pareja, J. A. (2007). Myofascial trigger
6. Gerwin, R. D. (2001). Classification, epidemiology, and natural history of myofascial pain syndrome. *Current pain and headache reports*, 5(5), 412-420.
7. Kuntamukkula, S., Sinha, R., Tiwari, P. K., & Paul, D. (2018). Dynamic Stability Assessment of the Temporomandibular Joint as a Sequela of Open Reduction and Internal Fixation of Unilateral Condylar Fracture. *Journal of Oral and Maxillofacial Surgery*. doi:10.1016/j.joms.2018.06.014
8. Davies S, Gray RM. What is occlusion? *Br. Dent. J*. 2001;191:235.
9. Kerstein RB. T-scan III applications in mixed arch and complete arch, implant -supported prosthodontics. *Dent. Implantol. Update*. 2008;19:49–53
10. Trpevska V, Kovacevska G, Benedeti A, Jordanov B. T-scan III system diagnostic tool for digital occlusal analysis in orthodontics - a modern approach. *Prilozi*. 2014;35:155–160. doi: 10.2478/prilozi-2014-0020
11. Kerstein R. Disclusion time measurement studies: stability of disclusion time: a 1 year follow up. *J Prosth Dent*. 1994;72:164–8.
12. Prafulla Thumati, Rakhi Manwani, Minal Mahantshetty. The effect of reduced disclusion time in the treatment of myofascial pain dysfunction syndrome using immediate complete anterior guidance development protocol monitored by digital analysis of occlusion. *The Journal of Craniomandibular & Sleep Practice* 2014 VOL. 32 NO. 4
13. Kerstein, Robert & Grundset, K.. (2001). Obtaining measurable bilateral simultaneous occlusal contacts with computer-analyzed and guided occlusal adjustments. *Quintessence International*. 32. 7-18.
14. Kerstein RB, Wright NR. Electromyographic and computer analyses of patients suffering from chronic myofascial pain-dysfunction syndrome: before and after treatment with immediate complete anterior guidance development. *J Prosthet Dent*. 1991 Nov;66(5):677-86.
15. Kerstein, R, B. Non-Simultaneous Tooth Contact In Combined Implant and Natural Tooth Occlusal Schemes. *Practical Periodontics and Aesthetic Dentistry* 2001;13 (9);751-e. 2014; 28(1): 6–27.
16. Cheng, H. J., Geng, Y. & Zhang, F. Q. [The evaluation of intercuspal occlusion of healthy people with T-Scan II system]. *Shanghai kou qiang yi xue=Shanghai journal of stomatology* 21, 62–65 (2012).
17. Schiffman E, Ohrbach R, Truelove E, Look J, Anderson G, Goulet JP et al Diagnostic Criteria for Temporomandibular Disorders (DC/TMD) for Clinical and Research Applications: recommendations of the International RDC/TMD Consortium Network and Orofacial Pain Special Interest Group. *J Oral Facial Pain Headach*
18. Lamot U, Strojan P, Popovic KS. Magnetic resonance imaging of temporomandibular joint dysfunction—correlation with clinical symptoms, age, and gender. *Oral Surg Oral Med Oral Pathol Oral Radiol* 2013;116: 258–63
19. Guarda-Nardini L, Piccotti F, Mogno G, Favero L, Manfredini D. Age-related differences in temporomandibular disorder diagnoses. *Cranio* 2012;30:103–9.
20. Poveda Roda R, Bagan JV, Díaz Fernández JM, et al. Review of temporomandibular joint pathology. Part I: classification, epidemiology and risk factors. *Med Oral Pathol Oral Cir Bucal*. 2007;12:E292–E298
21. Le Resche L, Drangsholt M. Epidemiology of orofacial pain: prevalence, incidence, and risk factors. In: Sessle BJ, Lavigne GJ, Lund JP, et al., editors. *Orofacial pain: from basic science to clinical management*. Chicago (IL) Quintessence Publications; 2008. p. 13–18
22. Chisnoiu AM, Picos AM, Popa S, et al. Factors involved in the etiology of temporomandibular

- disorders – a literature review. *Clujul Med.* 2015;88:473–478
23. Dao T T, Le Resche L. Gender differences in pain. *J Orofa Pain Summer* 2000;14(3):169-84; discussion 184-95
  24. Bueno CH, Pereira DD, Pattussi MP, et al. Gender differences in temporomandibular disorders in adult populational studies: A systematic review and meta-analysis. *J Oral Rehabil.* 2018;45(9) 720–729
  25. L€ovgren A, H€aggman-Henrikson B, Visscher CM, et al. Temporomandibular pain and jaw dysfunction at different ages covering the lifespan – a population based study. *Eur J Pain.* 2016;20(4):532–540.
  26. Sessle BJ, Lavigne GJ, Lund JP, et al. Orofacial pain. *From Basic Science to Clinical Management.* 2nd ed. Chicago: Quintessence Publishing; 2008. p. 1–264.
  27. Poveda Roda R, Bagan JV, DÍaz Fernández JM, et al. Review of temporomandibular joint pathology. Part I: classification, epidemiology and risk factors. *Med Oraln Pathol Oral Cir Bucal.* 2007;12:E292–E298
  28. Le Resche L, Drangsholt M. Epidemiology of orofacial pain: prevalence, incidence, and risk factors. In: Sessle BJ, Lavigne GJ, Lund JP, et al., editors. *Orofacial pain: from basic science to clinical management.* Chicago (IL) Quintessence Publications; 2008. p. 13–18
  29. Qvintus, V., Sipilä, K., Le Bell, Y., & Suominen, A. L. (2020). Prevalence of clinical signs and pain symptoms of temporomandibular disorders and associated factors in adult Finns. *Acta Odontologica Scandinavica*, 1–7. doi:10.1080/00016357.2020.1746395
  30. Dawson PE. Position paper regarding diagnosis, management, and treatment of temporomandibular disorders. *The American Equilibration Society. J Prosthet Dent.* 1999 Feb;81(2):174-8.
  31. Carey JP, Craig M, Kerstein RB, Radke J. Determining a relationship between applied occlusal load and articulating paper mark area. *Open Dent J.* 2007;1:1-7.
  32. Kerstein R, Radke J. Clinician accuracy when subjectively interpreting articulating paper markings. *Cranio.* 2014 Jan;32(3):13-23.
  33. Maness WL, Benjamin M, Podoloff R, Bobick A, Golden RF. Computerized occlusal analysis: a new technology. *Quintessence Int* 1987;18:287-92
  34. Santana-Mora U, Cudeiro J, Mora-Bermúdez MJ, Rilo- B, Ferreira-Pinho JC, Otero-Cepeda JL, et al. Changes in EMG activity during clenching in chronic pain patients with unilateral temporomandibular disorders. *J Electromyogr Kinesiol* 2009;19:e543-9.
  35. Karan Abrol and Sakshi Abrol .T- Scan – The dental advisor. *International Journal of Applied Dental Sciences* 2019; 5(2): 2
  36. Ciavarella D, Mastrovincenzo M, Sabatucci A, Parziale V, Granatelli F, Violante F, Bossù M, Lo Muzio L, Chimenti C. Clinical and computerized evaluation in study of temporo-mandibular joint intracapsular disease. *Minerva Stomatol.* 2010 Mar;59(3):89-101.
  37. Qadeer, S., Abbas, A. A., Sarinnaphakorn, L., & Kerstein, R. B. (2016). Comparison of excursive occlusal force parameters in post-orthodontic and non-orthodontic subjects using T-Scan® III. *CRANIO®*, 36(1), 11–18. doi:10.1080/08869634.2016.1259785
  38. Thumati P, Manwani R, Mahantshetty M. The effect of reduced Disclusion Time in the treatment of myofascial pain dysfunction syndrome using immediate complete anterior guidance development protocol monitored by digital analysis of occlusion. *Cranio.* 2014 Oct;32(4):289–99. PMID: 25252768
  39. Baladin, Nota A, Cozza P. The association between occlusion time and temporomandibular disorders. *J Electromyogr Kinesiol.* 2015;25(1):15-154
  40. Wang, C., & Yin, X. (2012). Occlusal risk factors associated with temporomandibular disorders in young adults with normal occlusions. *Oral Surgery, Oral Medicine, Oral Pathology and Oral Radiology*, 114(4), 419–423. doi:10.1016/j.oooo.2011.10.039
  41. Agne Dzingute\*, Gaivile Pileickiene, Ausra Baltrusaityte. Digital occlusal evaluation in patients with temporomandibular joint disorders. *Dzingute A, Pileickiene G, Baltrusaityte A. Digital occlusal evaluation in patients with temporomandibular joint disorders. Mol Med Ther.* 2017;1(1):8-13.
  42. Satheesh B. Haralur. Digital Evaluation of Functional Occlusion Parameters and their Association with Temporomandibular Disorders. *Journal of Clinical and Diagnostic Research.* 2013 Aug, Vol-7(8): 1772-1775.

# Awareness on Nutritional Anemia and its Prevention among Adolescent Girls

Santhi P.<sup>1</sup>, G. Ambujam<sup>2</sup>

<sup>1</sup>Research Scholar, Associate Professor, Vinayaka Mission's College of Nursing, Karaikal, Vinayaka Missions' Research Foundation-DU, Salem, <sup>2</sup>Dean & Professor of Surgery, Research Guide, Vinayaka Mission's Medical College, Karaikal, Vinayaka Missions' Research Foundation-DU, Salem

## Abstract

**Background:** Adolescence is the period of rapid growth with physical & physiological development and profound biological, emotional, social, and cognitive changes in human beings. Nutritional anemia is the common & worldwide public health problem among adolescent girls and overall prevalence of nutritional anemia varies from 40-90%. It may produce adverse effects like increased risk of morbidity and mortality and affects adolescent's future health.

**Objective:** This study aimed to assess the awareness on nutritional anemia and its prevention among adolescent girls.

**Method:** A non experimental descriptive design was adopted to assess awareness on nutritional anemia and its prevention among adolescent girls at Keezhakasakudi, Karaikal. A total of 60 adolescent girls between 10-15 years of age were selected by convenience sampling technique. Data was collected by using self structured interview schedule. Both descriptive and inferential statistics were used to analysis the gathered data.

**Results:** The study results reported that the majority 63% (38) of adolescent girls had inadequate awareness, 27% (16) had moderately adequate awareness and only 10% (6) had adequate awareness on nutritional anemia and its prevention. The overall mean was 9.6 with standard deviation±2.49. The results of the present study also revealed that there was statistically significant association between level of awareness on nutritional anemia with age of the adolescent girls.

**Conclusion:** Nutritional anemia as the major non communicable disease and contributing negative impact on health, it necessitates the need to organize counseling programs to adolescent girls in schools and colleges with much emphasis on impact of nutritional anemia on future health.

**Keywords:** Awareness, Nutritional anemia, Prevention, Adolescent girls.

## Introduction

Adolescence is the period of lifetime between 10 to 19 years of age as per WHO. It is the period where

there is rapid growth with physical & physiological development and profound biological, emotional, social, and cognitive changes in human beings.<sup>[1]</sup>Adolescent period forms the basis of development of many habits which may persist for lifelong including eating habits. Adolescence needs extra nutrients to meet their increasing demands of rapid growth and development. Majority of adolescents develop nutritional anemia due to lack of necessary nutrients in the diet, imbalanced diet, craving for junk foods and fast foods, having the habit of skipping meals and peer group influence

---

### Corresponding Author:

**Mrs. P. Santhi, M.Sc. (N)**

Associate Professor, Vinayaka Mission's College of Nursing, Karaikal, Vinayaka Missions' Research Foundation-DU, Salem

e-mail: psanthi03@gamil.com

in deciding eating choices. Nutritional anemia is a universal problem of adolescent girls particularly in low economic under developed and developing countries including India.<sup>[2]</sup> Nutritional anemia is the common & worldwide public health problem among adolescent girls and overall prevalence of nutritional anemia among adolescent girls in Northwest Ethiopia was 25.5%<sup>[3]</sup>. Prevalence of anemia among adolescent girls differs in different parts of India and findings of research studies revealed that 35.9% in Karaikal<sup>[4]</sup> 48.63% in Tamil Nadu,<sup>[5]</sup> 50% in Bihar,<sup>[6]</sup> 78.3% in Mumbai,<sup>[7]</sup> 78.5% in UttarPradesh,<sup>[8]</sup> 78.8% in Odisha,<sup>[9]</sup> 84.3% in rural south India<sup>[10]</sup> and 90% in Nagpur.<sup>[11]</sup> Low socioeconomic class, dietary diversity, household food status, living status, literacy level, parasitic infestation, haemolytic disease, malaria, menstrual abnormalities and bioavailability of iron are the contributing factors for anemia among adolescent girls.<sup>[12]</sup> Nutritional anemia in adolescent girls may lead to decreased oxygen carrying capacity of the blood which in turn caused decreased work capacity, inability concentrate in academic activity and problems in menstruation.<sup>[13]</sup> It may also produce impact on their future life when the adolescence enters into reproductive age; it may produce adverse effects like increased risk of morbidity and mortality during antenatal, intra natal & postnatal period and also low birth weight babies.<sup>[14]</sup> Hence it is necessary to know the existing level of awareness among adolescent girls in order to adhere to the preventive steps to reduce its prevalence.

**Statement:** A study to assess the awareness of nutritional anemia and its prevention among adolescent girls at Keezhakasakudi village, Karaikal

#### **Objectives:**

- To assess the awareness on nutritional anemia and its prevention among adolescent girls
- To associate the level of awareness on nutritional anemia and its prevention with demographic variables of adolescent girls.

#### **Materials and Method**

A non experimental descriptive design was adopted to assess awareness on nutritional anemia and its prevention among adolescent girls at Keezhakasakudi village, Karaikal for this study. Convenience sampling technique was used to select 60 adolescent girls of 10-15 years for the study. A pretested self structured interview schedule was used to collect the data from the participants. The tool consisted of two sections. Section A consisted

of 12 items on demographic profile of adolescent girls such as age, educational, mother's education & occupation, father's education & occupation, monthly family income, religion, type of family, No. of children, Age at menarche and mode of getting information related to nutritional anemia. Section B included 20 items of multiple choice questions regarding awareness on nutritional anemia and its prevention which included meaning, causes, clinical features and prevention of nutritional anemia. The reliability of the tool was tested by split half method. ( $r=0.8$ ) Pilot study was carried out for six participants to check the feasibility and practicability of the study. It was found feasible to conduct the study. After explaining the purpose of the study, informed oral consent was obtained from each adolescent girl. Self structured interview schedule was administered to each participant to collect the data. It took 15 – 20 minutes to collect information from each participant. Descriptive statistics such as mean, mean percentage, standard deviation were used to analysis level of awareness. Inferential statistics such as chi-square was used to associate the level of awareness with demographic variables.

#### **Results**

- The study results revealed that the majority 35% (21) of the adolescent girls were between the ages of 14-15 years
- The highest 35% (21) of study participants were in 6<sup>th</sup> standard and the least 16.7% (10) were in 9<sup>th</sup> standard.
- With regard to the mother's educational status, the majority 25% (15) were illiterate and the less 15% (9) had primary and secondary education.
- Based on the mother's occupation the highest 28.3% (17) were government employees and 20% (12) had self employment.
- With respect to father's educational level, the greater 38.3% (23) had primary education and only 10% (6) had higher secondary education and 31.7% (19) of the study participant's father were employed in private organization.
- The majority 30%(17) had monthly family income above Rs. 15,001/- and the least 20%(12) had monthly family income less than Rs. 5000/-
- The maximum 75% (45) of study participants belonged to Hindu religion and living in a nuclear family.

- The study result also revealed that the highest 56.7% (34) of family had only one child in their family.
- The majority of adolescent girls 35% (21) had menarche at the age of 13-16 years.
- The maximum 28.3 % (17) of adolescent girls reported that the major source of information obtained was through Radio and Television
- The results of the present study revealed that the mean value of awareness on meaning of nutritional anemia was 1.45, on causes of nutritional anemia were 2.15, on clinical features were 2.55 and on prevention were 4.45.
- The study results also reported that the majority 63% (38) of adolescent girls had inadequate awareness, 27% (16) had moderately adequate awareness and only 10% (6) had adequate awareness on nutritional anemia and its prevention. The overall mean was found to be 9.6 with standard deviation±2.49.
- The results of the present study also revealed that there was statistically significant association between the level of awareness on nutritional anemia with only one demographic variable the age of the adolescent girls ( $\chi^2= 10.2$ ) at  $p<0.05$  and there was no association between awareness on nutritional anemia with other demographic variables such as educational status, parents educational status and occupation, monthly family income, type of family, number of children in the family, religion and the sources of information.

### Discussion

The result of present study revealed that the highest percentage of adolescent girls 68%(38) had inadequate awareness on nutritional anemia and its prevention,27%(16) had moderately adequate awareness and only 10%(6) had adequate awareness on nutritional anemia and its prevention. This was supported by the study conducted by Gracy. S & N Junior Sundresh<sup>[15]</sup> on knowledge regarding prevention and management of anemia among adolescent girls, in Bhadravathi showed

that majority of adolescent girls (57%) had inadequate knowledge, only (43%) had moderate level of knowledge and none of the adolescent girls had adequate knowledge. The findings of the present study corresponded with another study conducted by Premaletha T & Safeena S<sup>[16]</sup> on Prevalence of anaemia and knowledge of adolescent girls regarding anaemia in higher secondary Schools of Thiruvananthapuram corporation which reported that 51% had poor knowledge, 38% had average knowledge and only 11% had good knowledge regarding anemia.

The findings of present study revealed that the overall mean of awareness on nutritional anemia was found to be 9.6 which showed moderate awareness. Still there is widespread prevalence of anemia among adolescent girls and there is a need to change the attitude and behavior of adolescents to combat anemia. The findings of present study was found less than the study results conducted by Chandrasekhar M et al<sup>[17]</sup> on assessment of Knowledge of Adolescent Girls Regarding the Prevention of Iron Deficiency Anemia in Selected Rural Areas of Mysore which found the mean knowledge score of adolescent girls was 12.58. Hence it is necessary to organize health education programme with more focus on specific issues and information on anemia such as healthy dietary pattern including intake iron and vitamin C rich foods, reducing junk foods, fast foods and avoiding tea and coffee to enhance iron absorption and proper utilization of deworming and iron supplementation provided by school health programme.

**Table 1: Percentage distribution of level of awareness on nutritional anemia and its prevention among adolescent girls**

Level of Awareness	Frequency	Percentage
Inadequate	38	63
Moderately adequate	16	27
Adequate	6	10
<b>Total</b>	<b>60</b>	<b>100</b>

**Table 2: Mean, standard deviation & mean percentage of level of awareness on nutritional anemia and its prevention**

Items	Maximum attainable score	Mean	SD	Mean Percentage
Meaning	3	1.45	1	13.68
Causes	5	2.15	1.35	20.28
Clinical Features	4	2.55	1	24.06
Prevention	8	4.45	1	41.98

### Conclusion

Nutritional anemia as the major non communicable disease is prevailing among adolescent girls and contributing negative impact on physical health as well as their academic performance and cognitive ability. It is necessary to create awareness on nutritional anemia and its prevention with multiple audio visual aids to enhance desired behavior change among adolescent girls. This also necessitates the need to organize counselling programs to adolescent girls in schools and colleges with much emphasis on impact of nutritional anemia on future health.

**Conflict of Interest:** Nil

**Source of Funding:** Self

**Ethical Clearance:** Taken from Institutional Research committee.

### References

- Jodhun BM, Pem D, Jeewon R. A systematic review of factors affecting energy intake of adolescent girls. *Afr Health Sci.* 2016;16(4):910-922.
- Gonete et al. Prevalence and associated factors of anemia among adolescent girls attending high schools in Dembia District, Northwest Ethiopia. *Archives of Public Health* 2018; 76:79
- Mujibur Rahman. K. et al. Prevalence of Iron Deficiency Anemia among Reproductive Age Group Women. *Journal of Clinical and Diagnostic Research.* 2019 Mar; 13(3): LC06-LC106. Available from DOI: 10.7860/JCDR/2019/36623.12706
- Chandrakumari AS, Sinha P, Singaravelu S, Jaikumar S. Prevalence of Anemia Among Adolescent Girls in a Rural Area of Tamil Nadu, India. *J Family Med Prim Care.* 2019 Apr;8(4):1414-1417. Available from DOI: 10.4103/jfmpc.jfmpc\_140\_19.
- Kumari R, Bharti RK, Singh K, Sinha A, Kumar S, Saran A, Kumar U. Prevalence of Iron Deficiency and Iron Deficiency Anaemia in Adolescent Girls in a Tertiary Care Hospital. *J Clin Diagn Res.* 2017 Aug;11(8):BC04-BC06. Available from DOI: 10.7860/JCDR/2017/26163.10325.
- Srinivas V, Mankeshwar R. Prevalence and determinants of nutritional anemia in an urban area among unmarried adolescent girls: A community-based cross-sectional study. *Int J Med Public Health.* 2015;5:283-8.
- Arya AK, Lal P, Kumar N, Barman S. Prevalence of anemia among adolescent girls in an urban slum of Kanpur, Uttar Pradesh. *Int J Med Sci Public Health.* 2017;6(9):1378-1381.
- Pattnaik S Pattnaik L Kumar A Sahu T. Prevalence of Anemia among adolescent girls in a rural area of Odisha and its epidemiological correlates. *Indian Journal of Maternal and Child Health.* 2012;15(1)
- Anandi. C & Yoganandh. Prevalence and factors influencing anaemia among adolescent females in rural area of South India. *Indian Journal of Basic and Applied Medical Research;* 2017; 6(3): 258-265
- Upadhye JV et al. Assessment of anaemia in adolescent girls. *Int J Reprod Contracept Obstet Gynecol.* 2017;6(7):3113-3117
- Rekha Kumari et al., Prevalence of Iron Deficiency and Iron Deficiency Anaemia in Adolescent Girls in a Tertiary Care Hospital, Bihar. *Journal of Clinical and Diagnostic Research.* 2017. 11(8): 04-06
- Gowdhaman. N, C Kameshvell & Devaki Vijayalakshmi. Prevalence of Anaemia and its associated factors among children in suburban Puducherry - A cross sectional study. 2017. Accessed through <http://www.semanticscholar.org/author>[Accessed on 12.01.2020]

13. Abbaspour N, Hurrell R, Kelishadi R. Review on iron and its importance for human health. *J Res Med Sci.* 2014;19(2):164-74.
14. Kumari S et al. Maternal and severe anaemia in delivering women is associated with risk of preterm and low birth weight: A cross sectional study from Jharkhand, India. *One Health.* 2019; 19(8):100098. Available from DOI: 10.1016/j.onehlt.2019.100098.
15. Gracy. S & N Junior Sundresh. Knowledge regarding prevention and management of anemia among adolescent girls, in Bhadravathi. *Global Journal for Research Analysis.* 2017; 6(7):54-55
16. Premaletha T, Safeena S. Prevalence of anaemia and knowledge of adolescent girls regarding anaemia. *J PaediatrNurs Sci.* 2019;2(3):74-6.
17. Chandrasekhar M et al. Study to assess the Knowledge of Adolescent Girls Regarding the Prevention of Iron Deficiency Anemia in Selected Rural Areas of Mysore with a View to Develop an Information Booklet on Prevention and Management of Iron Deficiency Anemia. *Asian J. Nur. Edu. and Research.* 2016; 6(1): 74-78. Available from DOI: 10.5958/2349-2996.2016.00015.X

# Incidence and Predictors of Postoperative Acute Kidney Injury in Non-Cardiac Surgery

Sara Mary Thomas<sup>1</sup>, Bhavika Sangada<sup>2</sup>, Sanam Vasava<sup>3</sup>, Lokesh Akkineni<sup>4</sup>, Chaitri Shah<sup>5</sup>

<sup>1</sup>Associate Professor, <sup>2</sup>Associate Professor, <sup>3</sup>Assistant Professor, Department of Anaesthesiology, Smt. B.K. Shah Medical Institute & Research Centre, Sumandeep Vidyapeeth Deemed to be University, Vadodara, Gujarat, India, <sup>4</sup>Medical Director (MD Anaesthesia) Akhila Health Services, Charla, Karimnagar, Telangana, <sup>5</sup>Professor, Department of Anaesthesia, SMS MC Hospital, Ahmedabad, Gujarat, India

## Abstract

**Background and Aims:** Incidence of Postoperative (Postop) Acute Kidney Injury (AKI) and related comorbidities can be prevented by identifying various preoperative and intraoperative predictors in the patients. Early recognition of risk factors and timely intervention can reduce morbidity and mortality related to AKI in a patient with preoperative normal renal function .

**Method:** This prospective observational cohort study was done in 100 patients undergoing major noncardiac surgery under spinal, epidural or general anaesthesia, who were having normal preoperative renal function. Intraoperative predictors of AKI monitored were bloodloss, hypotension, duration of surgery, volume of fluid infused, urine output (UOP), use of vasopressor and diuretics. Postoperatively urine output and serum creatinine level were noted for 3 days. Postoperative AKI was defined and classified as per RIFLE criteria.

**Results:** Total 33% patients were diagnosed to have Postop AKI and the major risk factors identified were duration of surgery, volume of fluid given intraoperatively, blood loss and UOP postoperatively (p value <0.001). Non significant risk factors were demographic data, mode of anaesthesia given, diuretic usage, drug therapy.

**Conclusion:** We concluded in our study that in patient with preoperative normal renal function undergoing noncardiac surgery various predictors for AKI can be identified early and optimised for better outcome. These factors are duration of surgery, blood loss, volume of fluid infused.

**Keywords:** Acute kidney injury, Diuretics, non cardiac surgery, RIFLE criteria, S.creatinine.

## Introduction

Acute kidney injury (AKI) is defined as “A syndrome that manifest within 48 hours and characterized by rapid decline in Glomerular filtration rate (GFR), retention of Blood urea nitrogen (BUN) and creatinine.”<sup>[1]</sup>

The etiology of Acute Renal Failure (ARF) is multifactorial and most common is ischemia leading to acute tubular necrosis.<sup>[2]</sup> Others are various toxin injury and rhabdomyolysis. The development of ARF postoperatively in non cardiac surgeries can increase morbidity, mortality and postoperative (postop) hospital stay and cost.<sup>[3]</sup> There are only few studies available that hypothesised incidence of postop AKI in non cardiac and non vascular surgeries having normal preoperative renal function,hence we initiated this study to identify preoperative, intraoperative and postoperative predictors that can be useful to prevent outcome related to AKI.

---

### Corresponding Author:

**Dr. Lokesh Akkineni**

Medical Director (MD Anaesthesia) Akhila Health Services, Charla, Karimnagar, Telangana

e-mail: sara.cinosh@gmail.com

Mobile No.: 9646500158

**Aims and Objectives:** The aim of this study is to predict and identify the risk factors for Postop AKI in



non cardiac surgical patients with baseline normal renal function.

**Material and Method**

After approval from the institutional ethical committee and written informed consent, hundred patients of either sex had been enrolled in this prospective, observational, cohort study. Patients undergoing major non cardiac surgeries under spinal, epidural or general anaesthesia having preoperative normal renal function were included in this study. Patients who were undergoing cardiac or vascular surgery, having altered renal function, sepsis and who were given radioactive contrast 48 hours before surgery were excluded from the study. Preoperative complete haemogram, blood sugar, urine examination, Serum (S.) creatinine, S.urea, S.electrolytes, Electrocardiogram (ECG), Chest Xray and other relevant investigations

were done. GFR was calculated using Cockcroft - Gault formula. Intraoperative predictors monitored were type of anaesthesia, duration of surgery (more than 2 hours), blood loss, occurrence of intraoperative hypotension (Systolic Blood Pressure [SBP]<90 mm of Hg), volume of intravenous fluid, vasopressor used and Urine output (UOP). Postoperatively UOP, S.creatinine and urea were noted for 3 days. AKI was defined and classified as per RIFLE criteria<sup>[4]</sup>(increase in S.creatinine >0.3 mg/dl above baseline or >1.5 times

within 48 hours, decrease in UOP <0.5 ml/kg/hour for at least 6 hours postoperatively.)

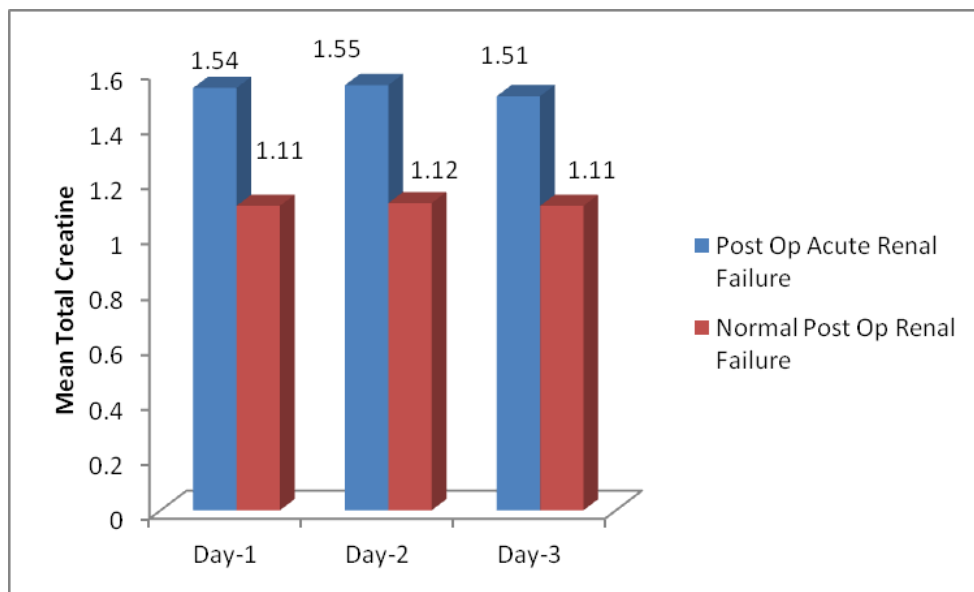
**Statistical Analysis:** The result of continuous variables were given as mean ± SD. The difference between the two group was assessed by unpaired ‘t’ test. P value <0.05 was considered significant.

**Observation and Results**

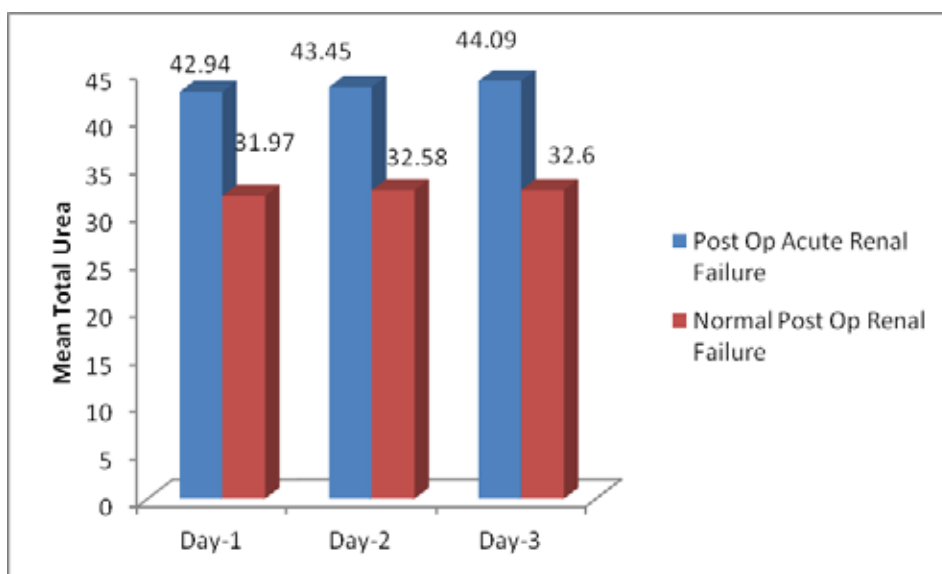
A total of 100 cases were reviewed and 33% of patients were diagnosed to have Post op AKI according to RIFLE criteria.

The preoperative mean serum creatinine and serum urea levels were comparable in both groups . Among the 67 patients who had normal post-operative renal function had mean pre-operative serum creatinine value of 1.18±0.19, while among the 33 patients who developed post op ARF had pre op mean serum creatinine value of 1.18±0.165, p value of 0.914 which was statically non-significant. Similarly mean pre-operative blood urea value in both groups were 37.91±4.4779 and 38.42±5.512 respectively and p value was 0.632 which was also statistically non-significant.

There were significant increase in Serum Creatinine and Serum Urea levels in Day 1,2,3 in 33% of patients who developed Post op AKI as depicted in Graph 1 and 2.



**Graph 1: Mean of Total Creatinine 72Hrs.**



**Graph 2: Mean of Total Urea 72Hrs**

There was significant decrease in urine output in Postop Day 1,2,3 in patients who developed Postop AKI as compared to those who had normal Postop renal function as shown in Table 1.

**Table 1: Mean of Total Urine Output 72Hrs**

Postop Day	Urine Output (ml)		p-value
	Postop Acute Renal failure (n=33)	Normal Postop Renal Function (n=67)	
1	730.94±344.546	1297.01±432.484	<0.001
2	690.61±299.426	1264.15±379.57	<0.001
3	730.3±377.521	1241.73±369.891	<0.001

On evaluating the predictors for Post op Acute Kidney Injury, it was found that, both groups were comparable with respect to their demographic profile .Both groups did not differ significantly with respect to type of anaesthesia provided – spinal anaesthesia, general anaesthesia and epidural anaesthesia (p value – 0.78, 0.58 and 0.44 respectively). Diabetes Mellitus and Hypertension were not found to be significant risk factors for Postop AKI (p value-0.357, 0.022 respectively.)

The significant intraoperative parameters were duration of surgery, volume of fluid used and blood loss. It was found that longer duration of surgery, increased blood loss and increased volume of intravenous fluid played a significant role in the development of Postop AKI as shown in Table 2.

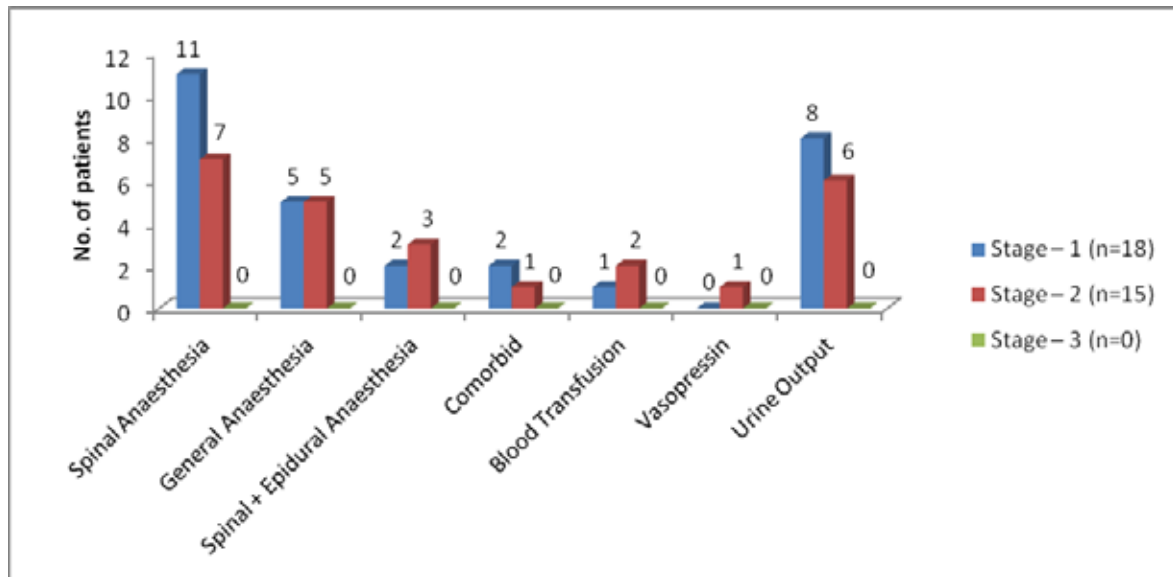
**Table 2 : Mean of Intra Operative Data**

	Post op Acute Renal failure (n=33)	Normal post op Renal Function (n=67)	p-value
Duration of Sx (hours)	2.9139±0.69652	1.9422±0.6987	<0.001
Vol. of Fluid in Sx (ml)	2374.55±617.789	1718.81±482.545	<0.001
Blood loss (ml)	398.79±84.512	190±119.598	<0.001

S<sub>x</sub>– Surgery, Vol- Volume.

The patients in our study were staged according to RIFLE criteria and also along with the parameters as depicted in Graph 3. In our study, most of the Acute

Kidney Injury patients belonged to Stage 1 and 2 and there were none in Stage 3.



**Graph 3: RIFLE Criteria staging according to parameters.**

**Discussion**

In our study of 100 patients, who were operated for non cardiac surgeries, the incidence of Postop Acute Kidney Injury according to RIFLE criteria was 33%. Based on RIFLE criteria staging of Acute Kidney Injury, most of the patients belonged to Stage 1 and 2 and none were in Stage 3. The rate of perioperative AKI is difficult to know precisely as it is dependent on definitions used and type of surgery studied .In the cardiac surgery population, ARF defined as 25% increase in creatinine, occurs in 17% of these high risk surgical patients according to Fengwang MD et al. [5] After aortic aneurysm repair, incidence of renal failure have been reported as 15%to 46%. [6]

Kheterpal et al[3] studied a total of 65,043 cases, with pre-operative normal renal function operated for noncardiac surgeries and noted an incidence of renal failure defined by GFR less than 50 mL/min as 0.8%.

In our study, co morbid diseases like Diabetes Mellitus and Hypertension were not significantly related to the development of Postop AKI whereas the study which was done in cardiac patients with co morbid conditions mentioned above by Robert C. Albright et al[7] found significant changes in the renal function

which were more so in Hypertensive patients than in patients with Diabetes Mellitus.

We had included in our study, patients undergoing major non cardiac surgeries under Spinal, Epidural or General Anesthesia and we concluded that there were no significant changes in the renal functions postop because of the mode of anesthesia given for surgery. This was in concordance with the results found by Marijana et al[8] in hisstudy.

The significant intra operative predictors which we had found in our study were duration of surgery, volume of fluid given and the total blood loss. The patients who developed postop AKI had longer duration of surgery with greater blood loss and increased volume of intravenous fluid administered to compensate hypotension as compared to those who had normal postop renal function. Kheterpal et al[3] studied patients with preoperative normal renal function posted for noncardiac surgery and developed a preoperative renal-risk index that identified the following independent risk factors for postop renal failure : age, emergent surgery, liver disease, body mass index, high-risk surgery, peripheral vascular occlusive disease and chronic obstructive pulmonary disease (requiring chronic broncho dilator therapy).[3] The

intraoperative risk factors which he identified were : use of a vasopressor infusion, mean number of vasopressor bolus doses administered, administration of furosemide or mannitol, units of packed red blood cells required and hypotension defined as Mean Arterial Pressure less than 50mmHg.

Namrata Khanal et al(2007)<sup>[9]</sup> studied the factors predicting renal outcome in patients developing acute renal failure in pregnancy. She concluded that Ante-Partum Haemorrhage and prolonged oliguria were strong predictors of irreversible renal failure. This inference highlighted the need for early recognition of the predictors and the importance of trained birth attendants and antenatal care.

Sean A Josephs et al (2009)<sup>[10]</sup> from his observations reflected that there is no single therapy that will prevent perioperative AKI. Clinical risk factors are similar but not identical in different surgical populations. He concluded that there were more likelihood of reducing perioperative AKI through better optimization and management of the many comorbidities and hemodynamic derangements that have been shown to impact renal function.

### Conclusion

In our study we observed that the incidence of Postop Acute Kidney Injury in non Cardiac Surgery was 33% according to RIFLE criteria. The highly predictive factors were duration of surgery, blood loss and volume of fluid infused.

We can conclude that the incidence of postop AKI can be decreased by early recognition and by optimising the comorbidities and predisposing factors.

**Ethical Clearance:** Taken from institutional ethics committee of Sumandeep Vidyapeeth deemed to be University.

**Source of Funding:** Self

**Conflict of Interest:** Nil

### Reference

1. Kathleen D. Liu, Glenn M. Chertow. Acute Renal Failure. Harrison's Principles of Internal Medicine 1752-1753
2. Thadhani R, Pascual M, Bonventre JV. Acute Renal Failure. N Engl J Med 1996;334:1448-1460
3. Kheterpal S, Tremper KK, Englesbe MJ, et al. Predictors of Postoperative Acute Renal Failure after Non Cardiac Surgery in Patients with Previously Normal Renal Function. Anaesthesiology 2007;107:892-902
4. S.M.Bagshaw et al. A comparison of the RIFLE and AKIN Criteria for Acute Kidney Injury in Critically ill Patients. Nephrol Dial Transplant (2008) 23:1569-1574 Doi: 10.1093/ndt/gfn009 Advanced Access publication 15 February 2008.
5. Feng Wang, MD MSc; Jean-Yves Dupuis, MD; Howard Nathan, MD; Kathryn Williams, MS .An Analysis of the Association Between Preoperative Renal Dysfunction And Outcome in Cardiac Surgery .CHEST 2003;124:1852-1862
6. Barratt J, Parajasingam R, Sayers RD et al. Outcome of acute renal failure following surgical repair of ruptured abdominal aortic aneurysm. Eur J Vasc Endovasc Surg. 2000;20:163-168.
7. Robert C. Albright, JR DO . Acute renal failure : A Practical update. Mayo Clin Proc. Jan.2001;76:67-74
8. Marijana Tadic, MD; Carla Sala, MD et al. Blood Pressure, Heart Rate Variability and Renal Function in Nonsmoker and Smoker Hypertensive Patients . The Journal of Clinical Hypertension DOI:10.1111/jch.12635:1-3
9. Namrata Khanal et al Factors Predicting the Outcome of Acute Renal Failure in Pregnancy Journal of the College of Physician and Surgeons. Pakistan 2010, Vol. 20(9):599-603
10. Sean A Josephs, MD Charuhas V. Thakar MD. Perioperative Risk Assessment, Prevention and Treatment of Acute Kidney Injury. INTERNATIONAL ANAESTHESIOLOGY CLINICS 2009 Volume 47, Number 4:89-105.

# Gender Differences in Life Satisfaction: The Moderation Role of Social Support among Older Persons

Sarah Al-ja'freh<sup>1</sup>, Rabia Allari<sup>2</sup>, Ayman M. Hamdan-Mansour<sup>3</sup>

<sup>1</sup>Lecturer; Department of Medical Sciences, Al-Balqa Applied University. Salt, 19117 Jordan, <sup>2</sup>Assistant Professor, Faculty of Nursing, Al Ahliyya Amman University. Salt. Jordan, <sup>3</sup>Professor, Mental Health Nursing, School of Nursing, the University of Jordan

## Abstract

**Introduction:** Life satisfaction among older persons is one significant component of quality of life. However, differences related to gender and moderation role of social support might affect life satisfaction. **The purpose** of this study was to examine the moderation effect of perceived social support on the relationship between gender and life satisfaction among older persons.

**Method:** A predictive-exploratory approach was used. Data collected from 966 persons at age of 60 years or older using a structured interview format.

**Results:** In general, older persons had moderate to a high level of life satisfaction and perceived social support. Perceived social support had a significant moderation effect on the relationship between gender and life satisfaction ( $F_{7,913} = 52.37, p < .001; R^2 = .152$ ).

**Conclusion:** Life satisfaction among older persons is influenced by social support indicating importance of creating and enhancing the supportive system available to older persons.

**Keywords:** *Life Satisfaction; Older Persons; Social Support; Gender.*

## Introduction

Worldwide, number of older persons, aged 60 years or above, by the year 2030 will reach 1.4<sup>[1]</sup>. By 2050, 80% of older people will be living in low- and middle-income countries<sup>[2]</sup>. The elderly population in Jordan (over age of 60) in the year 2015 reached 0.4 million, including 49.1% females and 50.9% males<sup>[3]</sup>. The number will increase to reach 8.6% by year 2030<sup>[4]</sup>. Such a situation might impact the quality of life among older persons and their psychological wellbeing causing further health problems<sup>[5-7]</sup>. The literature indicated that older persons

suffer from a myriad of physical and psychosocial morbidities which may decline their quality of life (QoL) and affecting their life satisfaction<sup>[8-10]</sup>. Older women and men found to be different in their health needs, that consequently, influencing their perception of life satisfaction and quality of life (QoL)<sup>[11-12]</sup>.

Life satisfaction is one of the three major indicators of subjective well-being (SWB) that reflects the overall assessment of feelings and attitudes about one's quality of life<sup>[13]</sup>. While some researchers reported that differences among older males and females in life satisfaction existed, others found no significant differences<sup>[11]</sup>. Furthermore, studies suggested a stronger association of life satisfaction and incidence of chronic diseases in older women than in older men<sup>[14-15]</sup>. Being a female is connected to lower perception of life satisfaction which explains higher morbidity rates among older women<sup>[16]</sup>. Evidences showed that social support associate with lower health cost and higher perception of wellbeing among older persons<sup>[17]</sup>. It has also been found that

---

### Correspondence Author:

**Ayman M. Hamdan Mansour RN, MSN, PhD**

Professor, Mental Health Nursing, School of Nursing,  
the University of Jordan

e-mail: a.mansour@ju.edu.jo

Tel: 00962796383002

older persons with high level of social support are more capable to maintain their health and daily activities<sup>[18]</sup>. Although literature explored adequately older person's health and well-being<sup>[19-22]</sup>, the inter connectedness of age, gender, and life satisfaction addressing the role of social support as a moderating factor has little attention. Therefore, the purpose of study was to examine the moderation effect of perceived social support from family, friends, and others on the relationship gender and life satisfaction in a sample of older persons with chronic illnesses in Jordan the specific aims were:

- To examine the moderating effect of perceived social support on the relationship between gender and life satisfaction among older person diagnosed with chronic illness?
- To test the differences in life satisfaction in relation to gender among older person diagnosed with chronic illness?

## Materials and Method

**Design:** A cross sectional, predictive explorative design was used. Data collected using structured interview format.

**Sample and Setting:** A total of 996 older persons agreed and completed the questionnaire of a total of 1200 approached forming 83% response rate. Multistage sampling technique was used. Inclusion criteria included: all those above the age of 60 years and able to read and write in Arabic. Exclusion criteria included persons who are physically and mentally incompetent to answer the survey questions according to their next of kind statements.

**Data collection Procedures:** Data collection started after ensuring ethical approval from the University of Jordan. Privacy and confidentiality maintained and guaranteed for the participants. Structured format of data collection was used in the respondents' households by research team. The family members acted as co-signer of the consent form. The questionnaires were presented in Arabic language.

**Instrumentation:** The data collected using the Arabic version of scales. The instruments were:

1. The Arabic version of the Satisfaction with Life Scale<sup>[23]</sup> was used to measure Life satisfaction<sup>[24]</sup>. The scale is a five items scale measuring general

life satisfaction. Respondents are asked to make their responses on a seven-point scale ranging from strongly disagree (1) to strongly agree (7). The higher the score the higher the life satisfaction is. The scores of the total scale range from 5 to 35 and interpreted as follow: 31- 35 (extremely satisfied), from 26-30 (satisfied), from 21-25 (slightly satisfied), 20 (neutral), from 15-19 (slightly dissatisfied), from 10-14 (dissatisfied), and 5 – 9 (extremely dissatisfied). The scale has good reliability with Cronbach's alpha of .79<sup>[23]</sup>.

2. The Arabic version of the Multidimensional Scale of Perceived Social Support<sup>[25]</sup> was used to measure Perceived social support<sup>[26]</sup>. The scale is a 12-item tool measuring perceived social support from family, friends and others the respondents are expected to make their responses on a 7-point Likert scale ranging from very strongly disagree (1) to very strongly agree (7). The higher the score is the higher the perceived social support. This scale had good internal consistency with Cronbach's alpha of .83<sup>[25]</sup>.

**Sociodemographic factors** included information related to age, gender, marital status, education level, type of chronic diseases if they have, duration of diagnosis of the disease, and smoking status.

## Results and Discussion

**Descriptive Characteristics:** The analysis showed that age ranged from 60 to 100 years with a mean of 68.0 (SD = 7.3). of them, 54.0% (n = 538) were males and 46.0% (n = 456) were females. The majority of the older persons (68.6%, n = 683) were married, and 107% (n = 107) had fulltime work. of them, 28.1% (n=280) have comorbid diagnoses of medical diagnosis, compared to 26% (260) are not diagnosed with any medical (or do not know). For more details see table 1.

**Table 1: Descriptive characteristics of the older persons (N=996)**

Variable		n	%
Gender	Male	538	54.0
	Female	456	46.0
Education level	≤ High School	770	77.3
	≥ High School	226	22.7

Variable		n	%
Marital status	Single	21	2.1
	Married	683	68.6
	Divorce	34	3.4
	Widow	257	25.8
Working status	Don't work	549	55.1
	Full time	107	10.7
	Part time	56	5.6
	Retired	278	27.9
Smoking status	Yes	264	26.5
	No	732	73.5

**Life satisfaction:** The mean score of life satisfaction (LS) was 24.1 (SD = 5.9) ranging from 5 to 35 with 50% (n = 498) have a score of 26 or higher indicating a satisfied level. According to level of satisfaction, the analysis showed that 7.8% (n = 78) are extremely satisfied compared to 1.9% (n = 19) extremely dissatisfied.

**Perceived Social support (PSS):** The mean total score of PSS was 62.1 (SD = 12.9) ranging from 12 to 84. The lowest mean scores for the domains was for PSS-friends (M = 17.6, SD = 5.8), while for PSS family and others were almost equal (M = 22.2, SD = 5.1; M = 22.1, SD = 4.9, respectively).

**Model testing:** Moderation effect of perceived social support on the relationship between gender and life satisfaction

Path analysis, two-model multiple hierarchical regression analysis, was used to examine the hypothesis. In block-1, gender was entered and in block-2 perceived social support has been entered. Initially, gender have been regressed using standardized linear regression model on life satisfaction. The analysis showed that the model was not statistically significant (F = 1.91, p = .310). The model was able to explain only 0.5% (R<sup>2</sup> = .005) of variation in life satisfaction in relation to gender among older persons. Analysis has shown that gender was not a significant predictor.

**Table 3: Regression examining moderation effect of perceived social support on the relationship between gender and life satisfaction (N =996)**

Variables	Block 1		Block 2	
	β	p-value	β	p-value
Gender	-.523-	.226	-.549-	.170
PSS-FA			.163	p <.001
PSS-FR			.120	p <.001
PSS-OTHER			.256	p <.001
R <sup>2</sup>	.005		.151	
R <sup>2</sup> <sub>adj</sub>	.001		.146	
R2 change	.146		p <.001	
e	.97		.70	

PSSFA: perceived social support from family; PSSFR: perceived social support from friends; PSSOTHER: perceived social support from others.

In block-2, in which perceived social support from family, friends and others added to test its moderation effect, the analysis showed that the model was statistically significant (F = 52.37, p <.001) with R<sup>2</sup> = 0.152 and adjusted R<sup>2</sup> = .145. The R<sup>2</sup> value of .152 indicates that almost 15% of the variation in the relationship between gender and life satisfaction is related to the moderation effect of perceived social support. The variation has been improved largely with inclusion of perceived social

support from model 1 to model 2 where the magnitude of R<sup>2</sup> changes value is .146 indicating the perceived social support has great moderation effect on the relationship between gender and life satisfaction among older person (see table 3). In general, the results infer that adding perceived social support from family, friends and others has buffered the negative influence of gender on the life satisfaction.

**Differences in life satisfaction related to selected demographics:** The analysis showed no significant differences related to gender ( $t = .08, p = .941$ ). However, using the univariate analysis to examine the differences between males and females in their life satisfaction controlling for type of medical diagnosis, the analysis showed a significant difference ( $F_{1,996} = 8738.7, p < .001$ ). Males had higher mean score ( $M = 24.5, SD = 5.7$ ) than females ( $M = 23.9, SD = 7.1$ ). Significant differences found between males and females controlling for duration of medical diagnosis with mean score for males ( $M = 24.5, SD = 5.6$ ) higher than females ( $M = 23.8, SD = 7.0$ ).

## Discussion

Older persons are struggling to manage their biopsychosocial needs within limited available resources in the developing countries<sup>[5]</sup>. The literature asserted that older persons are suffering from number of psychological and physical deteriorations<sup>[27-30]</sup>. This study is extending the body of knowledge identifying the role of social support as moderating factor on the relationship between life satisfaction and gender. The findings of the study provide a new perspective of understanding that the relationship between ageing and the biopsychosocial wellbeing of older persons. We have found that social support is one core component of older persons' quality of life due to the effect of social support on the life satisfaction regardless of gender of the older persons. Males and females are not simply similar in their social functions. Women are assuming different roles in the Arabian culture in which most of women's responsibilities are geared towards home-related and family-related matters indicating that women need more social support than men. However, we found that older men and women regardless of their age need an equal social support to successfully maintain their life satisfaction. The results are not in line with other studies<sup>[31]</sup> who found that perceived social support was more closely related to life satisfaction for women than for men. One explanation is that older women preserve their social roles through maintaining their strong connectedness with their adult male and female children. In Arabian culture, adult male and female children are obliged to seek more constant appraisals from their mothers than fathers in all their life matters. This would explain the higher level of social support that older women received than men. This also explains what we have also found that age and gender of older persons are not significantly related to the level of life

satisfaction supporting previous report<sup>[30-31]</sup> who found no significant differences in life satisfaction in relation to sociodemographic factors.

However, when controlling for health characteristics (type and duration of medical diagnosis) we found significant differences in life satisfaction in relation to gender in which older males were more satisfied with their lives than older females. Such findings would sustain the notion that life satisfaction is complicated within social context. This would suggest that life satisfaction among older persons cannot be measured using global life satisfaction scale. There is a need to develop a measure that emphasizes the social and psychological context of gender role among older persons.

One limitation of this study is that the sample the study is cross sectional in which a longitudinal approach measuring life satisfaction at various points of life would be more informative.

## Conclusion

Given the results of the present study, specifically understanding the relationship between ageing, gender, and biopsychosocial wellbeing, the results indicated that adding perceived social support from family, friends and others has buffered the negative influence of gender on the perception of life satisfaction. Older male persons had higher life satisfaction than females controlling for health-related factors. The study implies that social support is one particular factor to consider while attempting to explain or intervene to improve quality of life among older person.

**Conflicts of Interest:** the authors declare no conflict

**Funding:** None

**Ethical Clearance:** The study was approved by the scientific research committee at the University of Jordan (#10/2017-2018).

## References

1. United Nation (UN) (2017) World population ageing. [https://www.un.org/en/development/desa/population/publications/pdf/ageing/WPA2017\\_Highlights.pdf](https://www.un.org/en/development/desa/population/publications/pdf/ageing/WPA2017_Highlights.pdf)
2. World health organization (WHO) (2018) fact sheet (ageing and health). <https://www.who.int/news-room/fact-sheets/detail/ageing-and-health>
3. Help Age International (2018). <http://www.>



- helpage.org/global-agewatch/population-ageing-data/country-ageing-data/?country=Jordan. (Last accessed: 3 February 2020).
4. Department of Statistic (2015). Population and housing census 2015. DOS. Amman.
  5. Al Khatib A, Hamdan-Mansour A, BaniHani M. Theoretical perspectives of hospitalized older patients and their health-related problems and quality of care: systematic literature review. *The Open Public Health Journal* 2017; 10: 215-225.
  6. Khatib A, Hamdan- Mansour A, Ratrout H, Alenezi A, Chahien T. Testing the effectiveness of integrated elderly care model on quality of care and health outcomes among hospitalized elderlies in West Bank. *Malaysia Journal of Public Health Medicine* 2020; 20(1): 82-89.
  7. Mahadeen A, Hamdan-Mansour A, Halabi J, Habashneh S, Bani Kenanah A. Psychosocial wellbeing of infertile couples in Jordan. *East Mediterr Health J.* 2018; 4(2):169-176.
  8. Chiaranai C, Chularee S, Srithongluang S. Older people living with chronic illness. *GeriatrNurs* 2018; 39(5): 513-520
  9. Darawad M, Hammad S, Samarkandi SA, Hamdan-Mansour A, Khalil A. Evaluating the psychometric properties of the Arabic version of diabetes distress scale among Arabic patients with Diabetes Mellitus. *J PsychosocNursMent Health Serv* 2017; 55 (9): 43-51
  10. Dreidi H, Hamdan-Mansour A. Pain, Sleep Disturbance, and Quality of Life Among Palestinian Patients Diagnosed with Cancer. *J Cancer Edu* 2016; 31 (4): 796–803.
  11. Zhao C, Wong L, Zhu Q, Yang H. Prevalence and correlates of chronic diseases in an elderly population: A community-based survey in Haikou. *PLoS one* 2018; 13(6).
  12. Hamdan-Mansour A, Nawafeh D, Hanouneh S, Al Omari H. Psychosocial aspects of patients diagnosed with Diabetes Mellitus type –II in Jordan. *Int J Diabetes Dev Ctries* 2016; 36 (1): 65-69. DOI 10.1007/s13410-015-0423-z.
  13. Diener E, Tay L. Subjective well-being and human welfare around the world as reflected in the Gallup World Poll. *Int J Psychol* 2015; 50(2): 135-149
  14. Rathaur A, Mishra S. Study on institutionalized and non-institutionalized elderly people. *J Nurs Home Res Sci* 2016; 2: pp.77-79.
  15. Darawad M, Alfasfos N, Saleh Z, Saleh A, Hamdan-Mansour A. Predictors of delay in seeking treatment by Jordanian patients with acute coronary syndrome. *Int EmergNurs* 2016; 26: 20-25. DOI: 10.1016/j.ienj.2015.09.003.
  16. Oshio T. Gender differences in the associations of life satisfaction with family and social relations among the Japanese elderly. *J Cross Cult Gerontol* 2012; 27(3): 259-274
  17. Böhm AW, Mielke GI, da Cruz MF, Ramires VV, Wehrmeister FC. Social support and leisure-time physical activity among the elderly: A population-based study. *J Phys Act Health* 2016; 13(6): 599-605
  18. Angner E, Ghandhi J, Purvis KW, Amante D, Allison J. Daily functioning, health status, and happiness in older adults. *Journal of Happiness Studies.* 2013; 14(5): 1563-1574
  19. Hajian-Tilaki K, Heidari B, Hajian-Tilaki A. Are gender differences in health-related quality of life attributable to sociodemographic characteristics and chronic disease conditions in elderly people? *Int J Prev Med* 2017; 8
  20. Hamdan-Mansour A. Sociodemographic correlates of somatic symptoms of older persons in Jordan. *Jordan Med J* 2017; 51 (3): 119-130.
  21. Hamdan-Mansour AM, Al Abeiat DD, Alzoghaibi IN, Ghannam BM, Hanouneh S I. Psychosocial and sociodemographic correlates of life satisfaction among patients diagnosed with cancer in Jordan. *J Cancer Edu* 2015; 30(1): 31-36
  22. Darawad MW, Hammad S, Mosleh S, Samarkandi OA, Hamdan-Mansour A, Khalil AA, Arabiat D. Psychosocial correlates of diabetes self-management practices. *Iran J Public Health* 2017; 46(6): 771
  23. Hamdan Mansour A, Shehadeh J, Puskar K, El-Hneiti M, Haourani E. Investigating Physical, Psychological and Social Well-being of Older Persons in Jordan. *Curr Aging Sci* 2017; 10(3): 217-223
  24. Diener ED, Emmons RA, Larsen RJ, Griffin S. The satisfaction with life scale. *J Person Assess* 1985; 49(1): 71-75
  25. Amer N, Hamdan-Mansour A. Psychosocial predictors of suicidal ideation among patients diagnosed with chronic illnesses in Jordan. *Issues Ment Health Nurs* 2014; 35: 864–871.

26. Zimet GD, Dahlem NW, Zimet SG, Farley GK. The multidimensional scale of perceived social support. *J Person Assess* 1988; 52(1):30-41.]
27. Jaradat AKM, Abood MH. Life-satisfaction and social support among the elderly living in care homes and those living in their own homes. *J Edu Psychol Sci* 2016; 17(01).]
28. Hamdan-Mansour A, Marmash L, Elayyan R, Hyarat S. Difference in perception between nurses and patients related to patients' health locus of control. *Int J NursPract* 2014; 20: 242-249.
29. Attallah M, Hamdan-Mansour A, Al-Sayyed M, Aboshaiqa A. Patient Satisfaction with the quality of nursing care provided: the Saudi experience. *Int J NursPract* 2013; 19: 584–590
30. Hamdan-Mansour A, Constantino R, Farrell M, Doswell W, Gallagher ME, Safadi R, Shishani K, Banimustafa R. Evaluating the Mental Health of Jordanian Women in Intimate Partner Abuse. *Issues in Mental Health Nursing*. 2011; 32:614–623.
31. Berg AI, Hassing LB, McClearn GE, Johansson B. What matters for life satisfaction in the oldest-old? *Aging Ment Health* 2016; 10(3): 257-264.]

# Effects of Emotional Intelligence on Multi-cultural Cognition and Multi-cultural Attitude in Undergraduate Nursing Students in Korea

Seong Mihyeon<sup>1</sup>, Chung Soojin<sup>2</sup>, Hong Hyonjoo<sup>3</sup>, Song Jihyun<sup>4</sup>, Hwang Wonju<sup>5</sup>

<sup>1</sup>Department of Nursing, Changshin University. Assistant Professor, MSN, PhD, <sup>2</sup>Department of Nursing, Graduate School, Kyung Hee University. Doctoral student, MSN, <sup>3</sup>National Center for Mental Health, RN, MSN, PhD, <sup>4</sup>Department of Nursing, Cheju-Halla University. Assistant Professor, MSN, PhD, <sup>5</sup>College of Nursing Science, Kyung Hee University. Associate Professor, MPH, PhD

## Abstract

**Introduction:** The purpose of this study was to provide basic data to develop effective multicultural education programs related to emotional intelligence by understanding its relationship with multicultural cognition, and the attitude of college students in the nursing science departments.

**Method:** A descriptive correlational survey design was administered on a total of 197 nursing students in Korea. The collected data were analyzed using descriptive statistics, t-test, ANOVA, and multiple regression analysis, with the SPSS/WIN 21.0 program.

**Result:** The multicultural perception was  $3.61 \pm 0.40$  out of 5, and the multicultural attitude was  $4.52 \pm .61$  out of 6. Emotional intelligence which comprises multicultural cognition ( $p < .001$ ), and multicultural attitude ( $p < .001$ ), all had a positive correlation with multicultural attitude ( $p < .001$ ).

**Discussion:** To develop multicultural education programs for nursing students and college students, it is necessary to develop and apply differentiated intervention strategies using emotional intelligence.

**Implications for nursing:** This can contribute to promote flexibility of nursing students and help them adapt themselves to clinical practice.

**Keywords:** Emotional Intelligence, Multicultural cognition, Multicultural attitude, Nursing students.

## Introduction

**Necessity of the research:** Historically, Korea's society shows unity in its characteristics, but this slowly changed as modern society brought about advancement in transportation and communication, along with the

exchange of people and goods, which changed the society into a more multicultural one<sup>1</sup>. The result of a survey conducted by the Ministry of Social and Public Administration with a number of foreign residents in Korea shows that long-term foreign residents comprise 3% of the whole population in Korea<sup>2</sup>.

In order to create a harmonious coexistence between the local society and newcomers, an alteration in the health service providers should be one important matter that should be discussed<sup>3</sup>. However, since the preference of professionals affect the health services provided and causes inequality, it is important that nurses and doctors avoid an exclusive stance and accept the differences within the society<sup>4,5</sup>. Furthermore, healthcare is expanding more multiculturally and is an important

---

### Corresponding Author:

**Wonju Hwang**

College of Nursing Science, Kyung Hee University, 26 Kyungheedaero, Dongdaemun-gu, Seoul 02447, Korea  
Tel: +82-2-961-0305

Fax: +82-2-961-9398

e-mail: hwangwj@khu.ac.kr

point in healthcare education. This means that education regarding multiculturalism should be emphasized.

Despite these efforts, there are still existing discriminations and prejudices in the current Korean society, and these views influence the interaction of patients and nurses themselves<sup>6,7</sup>. Therefore, emotional intelligence is an important term that should be viewed in terms of multiculturalism education. Thus people with this characteristic show strength in dealing with biases and controlling their emotions.

Emotional intelligence is the ability to control one's own emotions and understand that of others in different situations<sup>8</sup>. This manifests the optimistic view of the psychological state one is currently in. In the different situations one may be exposed to in the clinical field, this ability is important since one must control one's own feelings and provide healthcare services to the patients. Therefore, this is an important ability that healthcare providers must learn through education<sup>9</sup>.

In some studies, the main factors that affect the Korean university students' perspective of multiculturalism and biases are categorized into personal, tendency, experience, and capability factors. Furthermore, out of these factors, the cultural capability factor is a part of emotional intelligence, and this factor interacts with the following knowledge and the acknowledgement<sup>10</sup>.

Studies show that emotional intelligence is deeply related to self-efficiency, and it plays an intermediary role for problem behaviors. In the same perspective, the relationship between emotional intelligence and personal factors that influence stress and anxiety in healthcare providers in the clinical field is also a growing issue in nursing science<sup>11,12</sup>.

Previous research implies that emotional intelligence is related to one's ability to smoothly solve problems and deal with stressful situations<sup>13,14</sup>. Therefore, without any exposure to multiculturalism in the education process, emotional intelligence is thought to have a positive influence on healthcare providers in the clinical field. However, further research on this subject is still insufficient.

Finding and identifying the exact relationship between emotional intelligence and the cognition of multiculturalism is critical in nursing education. In the rapidly changing multicultural medical arena, nursing should be done under the firm implication of a thorough

understanding of multiculturalism in all health service providers. It is important that nursing education ensures this is met. Thus, this current study was conducted to determine the actual relationship between emotional intelligence and the development of multiculturalism-related educational programs.

### **Research Objective:**

1. To understand the emotional intelligence and the acknowledgement of multiculturalism of nursing students.
2. To realize the difference in emotional intelligence, acknowledgement, and attitude of multiculturalism based on general characteristics of nursing students.
3. To understand the relationship between emotional intelligence and the acknowledgement of multiculturalism.
4. To understand the effects of emotional intelligence on the acknowledgement of multiculturalism

### **Research Method**

1. **Research Design:** This study was a descriptive research study with the objective of understanding the effects of emotional intelligence on the acknowledgement of multiculturalism. This study also analyzed the emotional intelligence and the acknowledgement of multiculturalism in nursing students.
2. **Research Subject:** The participants were nursing students from S city to J city. The sample size included 200 people, calculated using the G-power 3.1.1 program. The effect size needed in multi-regression analysis was 0.25, with power  $(1-\beta) = 0.80$ , and significant level  $(\alpha) = .5$ . The results showed that 180 participants were appropriate, and an elimination rate of 10% was considered, resulting in a sample of 200 participants. However, in the final analysis, 3 participants were excluded due to missing information and inadequate responses to the survey.
3. **Research Tools:**
  1. **Emotional Intelligence:** Emotional intelligence is a term used to describe the ability to understand one's feelings and those of others, and the acknowledgment of these feelings before getting into action<sup>8</sup>. This study used a scale that was adapted from WLEIS (Wong & Law's Emotional

Intelligence Scale<sup>15</sup>) by Jung<sup>16</sup>. Permission was granted for its use. This scale consists of 4 questions on self- emotional understanding, 4 questions on emotional understanding of others, 4 questions on emotional control, and 4 questions on emotional application. The Likert Scale is used to rates responses, where 1= highly unlikely and 7= highly likely. Higher scores indicate higher emotional intelligence. Validity verification was also done, which showed reliability with Cronbach's  $\alpha= 0.87$  (when the tool was created), and  $\alpha= 0.89$  (when the research was conducted)

## 2. Acknowledgement of Multiculturalism:

Acknowledgement of multiculturalism is the level measuring how much nurses accept and respect the cultural differences in a society<sup>17</sup>. The tool designed by Kim<sup>18</sup> for teenagers was used, and permission for the use of such was granted. Eight questions regarding acceptance of differences, 6 on sensitivity towards differences, and 6 on openness towards differences were asked, totaling to 20 questions. The Likert Scale was used to rate responses, where 1 = highly unlikely and 5= highly likely, with higher scores indicating a higher level of acknowledgement. The scales's validity was measured, with reliability showing Cronbach's  $\alpha= 0.89$  (when the tool was created),  $\alpha= 0.82$  (when the study was conducted)

3. **Attitude towards multiculturalism:** This is an owned property regarding the consistent reaction towards the multicultural society and recognize the cultural difference between various cultures<sup>19</sup>. The tool adapted from MASQUE (Munroe Multicultural Attitude Scale Questionnaire<sup>20</sup>) by Kang and Lim<sup>19</sup> was used, excluding questions that overlap with questions from the "Acknowledgment of Multiculturalism" portion. Six questions regarding different cognitions, 4 regarding openness and acceptance, and 4 regarding willingness to get in action were included resulting in a total number of 14 questions. A Likert-type scale was used to rate responses, with 1= highly unlikely and 6= highly likely, with higher scores indicating a more optimistic attitude towards multiculturalism. Validity was measured, with reliability indicating Cronbach's  $\alpha= 0.89$  (when the tool was created),  $\alpha= 0.92$  (when the study was conducted).

4. **Data collection:** The data collection period was from December 1, 2016 to March 1, 2017. Before data collection, all participants were informed about

the precautions and the data usage. They were informed that data will be used only for research purposes and will be handled anonymously. The participants provided their written informed consent. Furthermore, 10 pre-surveys were done to ensure that the participants fully understood the survey questions.

The research was approved by the research ethics review committee in the institution (approval number: KHSIRB-16-071 (RA)).

5. **Data Analysis:** The collected data were analyzed using the IBM SPSS/WIN 21.0 program. The degree of the subjects' general properties, emotional intelligence, acknowledgement and attitude towards multiculturalism were expressed using real numbers, average, and standard deviation. The difference between the three terms were found using the Independent t-test and One-way ANOVA. The relationship between the three terms were analyzed using the Pearson's correlation coefficient, and multiple regression analysis was done to determine the effect of emotional intelligence on the acknowledgement and attitude of the participants toward multiculturalism.

## Results

1. The degree of the subjects' emotional intelligence, acknowledgement and attitude towards multiculturalism.

*Emotional Intelligence* – Out of 7 points, subjects' average =  $4.80 \pm 0.72$

*Acknowledgement of multiculturalism*—Out of 5 points, subjects' average =  $3.61 \pm 0.40$

*Attitude towards multiculturalism*—Out of 5 points, subjects' average =  $4.52 \pm 0.61$  (Table 1)

2. The difference between emotional intelligence, acknowledgement and attitude towards multiculturalism based on general properties of subjects

Results showed meaningful differences in emotional intelligence between participants who had experience regarding multiculturalism other than major education and those who had no experience at all. ( $t= 2.34, p= .020$ )

Results regarding the difference between degrees of acknowledgement towards multiculturalism regarding the participants' general characteristics showed the

highest results in grade 2 (3.75 ±0.46), followed by grade 3 (3.58 ±0.39), grade 1 (3.56 ±0.40), and grade 4 (3.55 ±0.32) (F= 2.84, p=.039). Participants who had experiences of activities regarding multiculturalism had higher scores than those who had no experiences at all (t=2.30, p=.023). Participants who had received education on multiculturalism other than their majors had higher scores (t= 2.66, p=.009). Those who have friends from different cultures also had higher scores (t=2.01, p=.046).

Questions regarding relations with multicultural societies were answered by 1) *do not know firsthand, but have talked to them* (3.80 ± 0.43), 2) *have known them and lived with them in the same neighborhood* (3.72 ±0.43), 3) *only seen them on TV or in movies* (3.58 ±0.23), and 4) *do not know them firsthand, but have seen them in the neighborhood* (3.56 ±0.40) (F=2.50, p=.044). Results regarding differences in attitudes towards multiculturalism based on participants' general properties showed higher scores in participants who have experienced various practical trainings than those who have not (t=3.97, p<.001). Higher scores were also recorded in participants who have multi-cultural friends (t=2.95, p=.010). Questions regarding contacts with multicultural societies in the previous year were answered by 1) *very often* (3.72 ±0.60), 2) *sometimes* (3.65 ±0.39), and 3) *not at all* (3.52 ±0.34) (F=3.14, p=.046). Questions regarding the necessity of multiculturalism education in the nursing education system were answered by 1) *very necessary* (3.80 ±0.34), 2) *a little bit necessary* (3.54 ±0.40), and 3) *so-so* (3.50 ±0.39) (F=8.17, p<.001).

**1. The relationship between emotional intelligence, acknowledgement and attitude towards multiculturalism:** Emotional intelligence is in direct proportion with acknowledgement and attitude (both p<.001), while acknowledgement is in direct proportion with attitude (p<.001). Thus, this means that participants with higher emotional

intelligence have higher acknowledgement and positive attitudes, and higher acknowledgement led to more optimistic attitudes. (Table 2).

**2. Factors influencing acknowledgement and attitude towards multiculturalism:** Multi-regression analysis was performed to determine the effects of emotional intelligence on a participant's acknowledgement and attitude towards multiculturalism. The results are shown in Tables 3 and 4.

Along with emotional intelligence, grades, experience of practical training, education experience, existence of multicultural friends, experience with multicultural members, frequency of contacts with them, and necessity of multiculturalism education were independent variables. The results showed the following: Durbin Watson statistics was 2.039, indicating no influence since the number is close to 2; tolerance = 0.661, lower than 0.1; VIF was lower than 10, thus there were no problems in multicollinearity. The analysis using these independent variables were meaningful (F=5.775, p<.001), and estimated the acknowledgement of multiculturalism of nursing students in grade 2, necessity of multicultural education, and emotional intelligence (28.0%). (Table 3)

Along with attitude towards multiculturalism, practical training experience, existence of multicultural friends, experience with multicultural members, and necessity of multicultural education were independent variables. Results showed the following: Durbin Watson statistics was 1.826, indicating no influence since the number is close to 2; tolerance = 0.715, lower than 0.1, VIF was lower than 10, thus there were no problems in multicollinearity. The analysis using these independent variables was significant (F=7.422, p<.001). Influence factors were estimated as practical training experience, necessity of multiculturalism education, and emotional intelligence (24.7%). (Table 4).

**Table 1. Emotional Intelligence, Multicultural Awareness and Multicultural Attitude (N=197)**

Variables	Mean±SD	Minimum	Maximum	Range
Emotional Intelligence	4.80±0.72	2.94	6.44	3.50
Multicultural Awareness	3.61±0.40	2.33	4.80	2.47
Multicultural Attitude	4.52±0.61	2.71	6.00	3.29

**Table 2. Correlational Relationships among the Variables (N=197)**

Variables	Emotional Intelligence	Multicultural Awareness	Multicultural Attitude
	r (p)	r (p)	r (p)
Emotional Intelligence	1		
Multicultural Awareness	.40(<.001)	1	
Multicultural Attitude	.37(<.001)	.69(<.001)	1

**Table 3. Factors Influencing Multicultural Awareness (N=197)**

Variables	B	S.E.	β	t	p	VIF
(Constant)	3.012	.418		7.210	<.001	
Grade*						
1st	.038	.070	.041	.542	.588	1.555
2nd	.215	.072	.230	2.998	.003	1.600
3rd	.038	.068	.042	.557	.578	1.584
Experience of clinical practice in of multicultures†	.149	.104	.096	1.428	.155	1.231
Experience of multicultural education beside major curriculum‡	.066	.058	.073	1.128	.261	1.133
Foreign friends§	.063	.071	.063	.890	.375	1.364
Relationship with foreigner¶						
Neighborhood well known	.112	.133	-.081	-.842	.410	2.528
Neighborhood not known	-.166	.101	-.161	-1.638	.103	2.620
Not known, but have talked	.055	.110	.047	.500	.617	2.369
Not known, have seen in street	-.097	.087	-.122	-1.112	.268	3.276
Contact with foreigner¶						
None	-.121	.107	-.147	-1.135	.258	4.575
Sometimes	-.053	.099	-.066	-.531	.596	4.222
Necessity of nursing education about foreigners¶¶						
None	.068	.363	.012	.187	.852	1.144
Little necessary	-.196	.064	-.223	-3.048	<.001	1.464
Necessary	-.241	.060	-.295	-3.996	<.001	1.481
Emotional Intelligence	.179	.036	.321	5.022	<.001	1.116

R<sup>2</sup>=.339, Adjusted R<sup>2</sup>=.280, F=5.775(p<.001), D-W=2.039

B=Unstandardized Coefficients; S.E=Standard Error; β=Standardized Coefficients; D-W=Durbin-Watson

Dummy variables: \*4th, †None, ‡None, § None, ¶Never seen except on TV or movie, ¶Frequently, ¶¶Very necessary.

**Table 4. Factors Influencing Multicultural Attitude (N=197)**

Variables	B	S.E.	β	t	p	VIF
(Constant)	3.422	.303		11.294	<.001	
Experience of clinical practice in institute of multicultures*	.505	.157	.212	3.212	.002	1.137
Foreign friends†	.054	.108	.035	.499	.618	1.294
Relationship with foreigner‡						
Neighborhood well known	.242	.193	.114	1.248	.214	2.165

Variables	B	S.E.	$\beta$	t	p	VIF
Neighborhood not known	-.073	.152	-.064	-.481	.631	2.397
Not known, but have talked	.145	.164	.080	.885	.377	2.137
Not known, have seen in street	-.063	.131	-.052	-.482	.630	3.004
Necessity of nursing education about foreigners <sup>§</sup>						
None	-.375	.561	-.044	-.669	.504	1.106
Little necessary	-.245	.100	-.182	-2.453	.015	1.433
Necessary	-.300	.094	-.239	-3.207	.002	1.447
Emotional Intelligence	.259	.055	.303	4.729	<.001	1.068
R <sup>2</sup> =.285, Adjusted R <sup>2</sup> =.247, F=7.422(p<.001), D-W=1.826						

B=Unstandardized Coefficients; S.E.=Standard Error;  $\beta$ =Standardized Coefficients; D-W=Durbin-Watson  
 Dummy variables: \*None, †None, ‡Never seen except on TV or movie, § Very necessary

## Discussion

This study was conducted with the objective of estimating the degree of emotional intelligence, acknowledgement and attitude towards multiculturalism, and finding the correlation between these three terms.

The average emotional intelligence scores of nursing students was 4.80±.72, which is higher than the results shown in Shin and Park's study<sup>13</sup> of 4.76. This was also lower than Song and Shin's study<sup>21</sup>, which had an average score of 4.95 although they used the same research tools. Since the emotional intelligence levels are similar in previous studies, this current study demonstrated that nursing education requires care based on empathy and consideration towards patients, as well as emotional intelligence and intellectual areas in caring for patients. Lee and Gu<sup>22</sup> reported that emotional intelligence levels can be heightened through education and training. Thus, an education strategy to enhance emotional intelligence levels is needed for healthcare providers to exert their full abilities in the healthcare field. This is needed for evidence that emotional intelligence is the driving force for nurses to be able to exhibit their professional skills<sup>23</sup>. However, emotional intelligence showed differences based on individuals' social and psychological backgrounds<sup>24</sup>.

Thus, for an exact analysis of the degree of intelligence, a comparison study between nurses and other professionals must be conducted. Multiculturalism-related education showed meaningful statistical differences in emotional intelligence levels. However, it was difficult to obtain information on all the lectures organized in each university's education process,

therefore this was excluded when performing this study. This section may be improved through further discussion and research. Further, additional studies regarding the effects of multiculturalism related education on emotional intelligence levels and acknowledgement of multiculturalism is needed since this research showed statistical differences in that area.

The acknowledgement of multiculturalism was influenced by practical training experience, the existence of multicultural friends, experience with multicultural members, frequency of contact with multicultural members, and the necessity of multiculturalism-related education. On the other hand, attitude was influenced by practical training experience, existence of multicultural friends, experience with multicultural members, and frequency of contact with multicultural members. Kim and Lim's<sup>25</sup> study indicated this factor being the existence of multicultural friends, and Jeon et al.'s<sup>26</sup> study indicated the factor as being experience with multi-cultural members. These studies both showed similar results with the current study. In the relationship between emotional intelligence, acknowledgement and attitude towards multiculturalism, emotional intelligence was directly proportional to acknowledgement and attitude. On the other hand, acknowledgement was directly proportional to attitude. In other words, acknowledgement could affect attitude, and both could affect emotional intelligence.

The results of this research imply that the influencing factors of acknowledgement and attitude towards multiculturalism are emotional intelligence, necessity of multiculturalism related education, and practical



training experience. First, emotional intelligence is an influencing factor in the acknowledgement and attitude towards multiculturalism, but comparison is difficult due to the lack of antecedent studies<sup>27</sup>. These results showed that for a successful nursing education to be achieved, an education method for heightening emotional intelligence is essential.

Second, since the necessity of multiculturalism-related education is also an influencing factor, acknowledgement and attitude-based education is needed for a suitable approach to diversity in the nursing field<sup>28</sup>. This result is similar to Hwang et al.'s study<sup>29</sup>, which showed that multicultural related lectures raised the standard regarding attitudes toward multiculturalism. Therefore, for an effective healthcare and approach, education regarding multiculturalism must be carried out in advance.

Lastly, multiculturalism related practical training is an influencing factor as well. This means that opportunities for nursing students to meet actual multicultural members and interaction with their cultures must be provided during the education process<sup>30</sup>.

This study shows significance in the fact that it provided basic information in designing an education process for nursing students to meet multicultural members and gain the abilities to understand them. To raise levels of acknowledgement and attitude towards multiculturalism, examples (North Korean deserters, married foreign residents, emigrant workers), and policies regarding them must be included in lectures, and an education method to raise emotional intelligence must be developed and included as well.

## Conclusion

The objective of this study was to find out the relationship between emotional intelligence, acknowledgement and attitude towards multiculturalism through comparison between the significant factors. The final results have shown that acknowledgement and attitude are indeed related. Therefore, emotional intelligence is necessary for healthcare providers to take a flexible stance towards multiculturalism and fully understand it.

For further research, the following must be kept in mind. First, a research to create an education program using emotional intelligence for nursing students and to verify them is necessary. Second, this study used only a

few nursing students as study participants, so a general statement cannot be applied to all nursing students. Thus, future research should expand the research bounds.

**Acknowledgments:** The authors would like to thank the students who participated in this study and shared their experiences with us.

**Funding:** This research received no specific grant from any funding agency in the public, commercial, or not-for-profit sectors.

**Declaration of Conflicting Interests:** The Author(s) declare(s) that there is no conflict of interest.

## References

1. Shin, SJ. A Study on the social workers' cultural competence for multi-cultural practice. *Discourse and Policy in Social Science*, 2013;6(2), 61–88.
2. Security Administration. Statistics on the status of foreign residents in local governments in 2016 [online]; 2016. [cited 2018 January 2]. Available from: [http://www.mois.go.kr/frt/bbs/type010/commonSelectBoardArticle.do?bbsId=BBSMSTR\\_000000000008&ntfId=60494](http://www.mois.go.kr/frt/bbs/type010/commonSelectBoardArticle.do?bbsId=BBSMSTR_000000000008&ntfId=60494).
3. Reimann JO, Talavera GA, Salmon M, Nuñez JA, Velasquez RJ. Cultural competence among physicians treating Mexican Americans who have diabetes: a structural model. *Social Science & Medicine*. 2004;59(11):2195-205.
4. Benjamins MR, Whitman S. Relationships between discrimination in health care and health care outcomes among four race/ethnic groups. *Journal of Behavioral Medicine*. 2014;37(3):402-13.
5. Chae DH, Park YH, Kang KH, Lee TH. A study on factors affecting cultural competency of general hospital nurses. *Journal of Korean Academy of Nursing Administration*. 2012;18(1):76-86.
6. Glittenberg JA. Transdisciplinary, transcultural model for health care. *Journal of Transcultural Nursing*. 2004;15(1):6-10.
7. Kang HY, Han SY. A study on social distance of nursing students toward minority groups in a Metropolitan city. *Journal of Korean Public Health Nursing* 2013;27(1):166-78.
8. Nam KA, Jeong GH. Analysis of prejudice toward foreigners by nurses and physicians in Korea. *Journal of Korean Public Health Nursing*.

- 2013;27(3):437-49.
9. Goleman D. Emotional intelligence. New York: Bantam Books; 1995.
  10. SunGok YH, Park SD, Lee YS. Research trends on multicultural perception and attitude of Korean college Students. *Multiculture & Peace*. 2013;7(2):173-203.
  11. Lee KH, Song JS. The Effect of emotional intelligence on self-efficacy and job stress of nurses-mediating role of self-efficacy. *Journal of Korean Academy of Nursing Administration*. 2010;16(1):17-25.
  12. Downey L, Johnston P, Hansen K, Birney J, Stough C. Investigating the mediating effects of emotional intelligence and coping on problem behaviours in adolescents. In Austin EH and Saklofske DH (eds). *Emotional Intelligence*. *Australian Journal of Psychology*. 2010;62(1):20-9.
  13. Shin EJ, Park YS. Emotional intelligence, ego resilience, stress in clinical practice of nursing students. *Journal of the Korea Academia-Industrial Cooperation Society*. 2013;14(11):5636-45.
  14. Yang SY. The effect of emotional intelligence and self-efficacy on clinical competence of the nursing students. *The Journal of The Korea Contents Association*. 2015;15(6):370-8.
  15. Wong CS, Law KS. The effects of leaders and follower emotional intelligence on performance and attitude: An exploratory study. *The Leadership Quarterly*. 2002;13(3):243-74.
  16. Jung HY. Effectiveness of emotional leadership and emotional intelligence of foodservice employees on organizational performance in contracted food service management company [dissertation]. [Seoul]: Yonsei University; 2006.
  17. Kim JA, Choi J. Correlation and influencing factors of multicultural awareness and cultural sensitivity among Korean nursing students. *Journal of Multicultural Education Studies*. 2016;9(4):67-88.
  18. Kim NY. Development and validation of the multicultural awareness scale for adolescents [master's thesis]. [Seoul]: Sung Kyun Kwan University; 2012.
  19. Kang HJ, Lim EM. Validation study of multicultural attitude scale for Korean university students. *Asian Journal of Education*. 2012;13(4):35-57.
  20. Munroe A, Pearson C. The Munroe multicultural attitude scale questionnaire: a new instrument for multicultural studies. *Educational and Psychological Measurement*. 2006; 66(5):819-34.
  21. Song HY, Shin SH. The effects of emotional intelligence on the career decision-making self-efficacy and career decision levels of the nursing students. *Journal of the Korea Academia-Industrial Cooperation Society*. 2016;17(9):628-40.
  22. Lee OS, Gu MO. Development and effects of emotional intelligence program for undergraduate nursing students: mixed method research. *Journal of Korean Academy of Nursing*. 2014;44(6):682-96.
  23. Beydler KW. The role of emotional intelligence in perioperative nursing and leadership: Developing skills for improved performance. *AORN Journal*. 2017;106(4):317-23.
  24. Afolabi OA. Roles of personality types, emotional intelligence and gender differences on prosocial behavior. *Psychological Thought*. 2013;6(1):124-39.
  25. Kim NH, Lim SY. Relationships between multicultural awareness, multicultural attitude and multicultural efficacy among nursing students. *Journal of Multicultural Education Studies*. 2014;7(4):169-84.
  26. Jeon MS, Kim HJ, Ka YR, Kim JW, Kim JS, Park SH, et al. Recognition and attitude of multicultural in undergraduate students. *Journal of the Korean Society for Multicultural Health*. 2013;3(1):9-14.
  27. Ponterotto JG, Ruckdeschel DE, Joseph AC, Tennenbaum EA, Bruno A. Multicultural personality dispositions and trait emotional intelligence: an exploratory study. *The Journal of Social Psychology*. 2011;151(5):556-76.
  28. Beard KV. Examining the impact of critical multicultural education training on the multicultural attitudes, awareness and practices of nurse educators. *Journal of Professional Nursing*. 2016;32(6):439-48.
  29. Hwang HY, Chyn YE, Hur J. Effects of multicultural understanding subject on the empathy and multicultural attitude of nursing student. *Journal of the Korea Academia Industrial Cooperation Society*. 2015;16(1):106-15.
  30. Kim JH. A study about cultural sensitivity and stereotype about immigrant women among nursing students. *Journal of Digital Convergence*. 2014;12(7):305-14.

# Characteristic of CD4+CD25+ T Cells in Chronic Myeloid Leukemia Patients Treated with Imatinib Mesylate with Different BCR-ABL Transcripts Levels Response

Shahla'a Fadhil Sabir<sup>1,2</sup>, Wifaq Mahmood Ali Alwatar<sup>3</sup>, Bassam Francis Matti<sup>4,5</sup>

*Lecturer, The National Center of Hematology, Al-Mustansiriyah University, Baghdad, Iraq, <sup>2</sup>Microbiology & Immunology Department, College of Medicine, University of Baghdad, Baghdad, Iraq, <sup>3</sup>Assist. Prof. Unit of clinical & communicable disease, College of Medicine, University of Baghdad, Baghdad, Iraq, <sup>4</sup>Consultant Adult Clinical Hematology Department, Baghdad Teaching Hospital, Medical City, Baghdad, Iraq, <sup>5</sup>Bone Marrow Transplant Center, Medical City, Baghdad, Iraq*

## Abstract

**Background:** Several clinical trials on cancer showed a correlation between elevated levels of regulatory T cells with either poor prognosis or poor response to some therapies. Hence, in this study we tried to measure the regulatory T cells (CD4+CD245+) count and to evaluate the program death receptor 1 (PD1) as a one of the main suppressive mechanisms that regulatory T cells use in CML patients with different molecular response to imatinib therapy. **Method:** Flow cytometry technique was used to analyze 30 sample of optimal molecular response of CML patients (BCR-ABL transcripts  $\leq 0.1\%$ ) and 30 sample of failure molecular response patients (BCR-ABL transcripts  $>1\%$ ) with or without hematological failure, in order to assess the CD4+CD25+ T cells (Tregs) and PD1 expression on these cells. Thirty samples age and gender matched were used as healthy controls. **Results:** A high proportion of CD4+CD25+ T cells was found in failure groups compared to control and optimal groups ( $P < 0.001$ ), while there was no significant difference between control and optimal groups with ( $P = 0.481$ ). A cutoff value of CD4+CD25+ T cells at  $>33.7\%$  was highly significant with high sensitivity and specificity. This value can be used to determine the failure from the optimal CML responders. There was no noticeable differences ( $P = 0.125$ ) in PD1+ expression among CD4+CD25+ T cells. **Conclusion:** A high percentage of Treg cells in the failure CML group might be an indication of immune escape of leukemic cells in those patients compared to the other investigated groups.

**Keywords:** CML, Imatinib mesylate, CD4+CD25+ Tregs, PD1.

## Introduction

In hematological malignancies, such as chronic myeloid leukemia (CML), CD8+ T cells are down-regulated in patients at time of diagnosis<sup>(1)</sup>, as the immune system becomes impaired favoring immune escape of the leukemic cells<sup>(2)</sup>. CML is characterized by the presence of BCR-ABL fusion oncogene that encodes BCR-ABL1 oncoproteins that have high tyrosin kinase

activity (3). Imatinib mesylate, a selective tyrosine kinase inhibitor, is considered the first TKI in CML management, accomplishing high response rates and overall survival, nevertheless; some of CML patients still develop treatment failure<sup>(3)</sup>. The TKI treatment responses are more potent in patients with less exhausted T cells<sup>(4)</sup>. A subset of CD4+ cells defined as a regulatory T cells (Tregs), which are reported as CD4+CD25+, express a high level of CD25+ (IL-2Ra), and can exhibit a suppressive function<sup>(5)</sup>.

---

### Corresponding Author:

**Shahla'a Fadhil Sabir**

Microbiology & Immunology Department, College of Medicine, University of Baghdad, Baghdad, Iraq  
e-mail: shahlaa\_fadhil@yahoo.com

Tregs control effector immune cells by humoral and cell to cell contact mechanisms<sup>(6)</sup>. Host environment and PD1 signaling play an important role in Treg development<sup>(7)</sup>. In malignancy, Tregs considered a vital suppressive immunocyte in tumor microenvironment

(TME) and are characterized by PD1 and PDL1 expression, and this demonstrated its contribution to the tumor progression (7).

In the CML treatment era, the main goal is to achieve a durable deep molecular response for treatment-free remission to stop TKI therapy. The immunological response and its effect in responder patients of CML may have a substantial value for those with a lack of overt relapse (8). From other view, the poor immunological response in CML can be part of targeted therapy to induce better response and to control TKI response failure.

Here in this study, we are trying to understand the dynamics of immune escape in CML patients by assessing Treg cells, that express CD4+CD25+ and PD1+ among different molecular response levels of CML patients undergoing imatinib therapy.

## Materials and Method

**Subjects:** This study was conducted between Nov.2018-Dec.2019 at Baghdad Teaching Hospital/ Medical City and The National Center of Haematology. Sixty patients with CML were enrolled in the present study, age >18 years old and on imatinib mesylate therapy for more than 1 year duration. Patients were grouped according to treatment response and the level of BCR-ABL transcripts. Treatment response criteria were defined according to the European Leukemia-Net (ELN) guidelines (9). Thirty patients were classified as an optimal responders (p210 BCR-ABL transcript levels  $\leq 0.1\%$ ) and 30 patients were classified as had a failure molecular response to therapy with or without loss of hematological response (p210 BCR-ABL transcript levels  $>1\%$ ). This study was approved by the scientific ethics committee/faculty of medicine, university of Baghdad. Thirty age and gender matched samples without history of hematological or chronic disease were taken as a control group. At time of sampling, blood count indices were obtained and calculated by automated blood count analyzer.

**Monoclonal antibodies and flow cytometry analyses:** The flow cytometry analysis was performed on peripheral blood at a maximum interval of 24 hours. Fluorescently labeled monoclonal antibodies (mAbs) included [anti-CD45 (FITC), anti-CD4 (APC/CY7), anti-CD25 (APC) and anti-CD279 (PE/CY7)] purchased from (Biolegend, USA), flow cytometry staining was

performed according to Biolegend immunofluorescence staining protocol. Data analyzed with DIVA software version 2016 using an immunological gate (SSC/CD45), along with CD4 marker were used to differentiate CD4+T-lymphocyte in all studied groups. At least 100,000 events were analyzed for each sample.

**Statistical analysis:** Data analysis was done with SPSS 22.0.0 (Chicago, IL). For comparison between different groups, one-way ANOVA is used, and post Hoc Tukey test is used to confirm which groups are significant. Receiver operator curve (ROC) is used to see the validity of Tregs in recognizing failure cases from optimal, ( $P \leq 0.05$ ) were considered statistically significant.

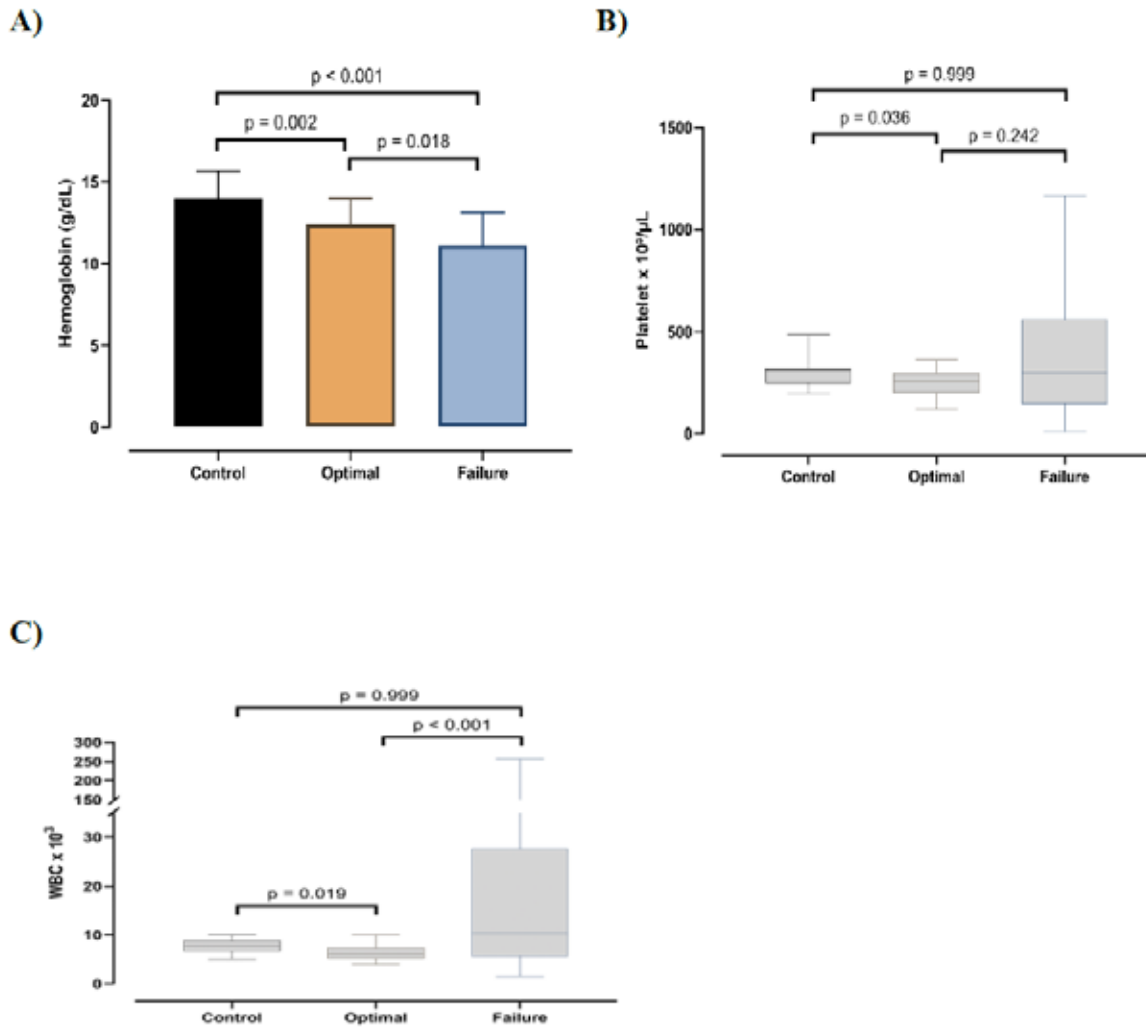
## Results

**General characterization of Patients and control group:** Out of 60 CML patients on imatinib therapy, 30 patients were with optimal response with (mean age  $43.47 \pm 13.14$  years; mean disease duration  $73.7 \pm 37.6$  months; M;F ratio 1.72:1) and 30 patients were with failure response with (mean age  $50.13 \pm 13.61$  years; mean disease duration  $69.4 \pm 46.4$  months; M;F ratio 0.76:1). Thirty healthy volunteer age and gender matched were included and evaluated as control samples with (mean age  $46.33 \pm 8.84$  years; M;F ratio 1.14:1).

**Patient's characteristics according complete blood count were included:** Haemoglobin (mean $\pm$ SD) levels for the control, optimal response and failure response were ( $14.00 \pm 1.68$  g/dL,  $12.38 \pm 1.59$  g/dL and  $11.11 \pm 2.04$  g/dL, respectively) with a significant difference among studied groups as shown in (Fig. 1A).

Regarding the platelets count (plt $\times 10^3/\mu$ L), the median for the control group was 312, range (247.3-322.3), for optimal response was 254.5, range (201.3-297.5) and for failure response was 300, range (146.8-559.8), with a significant difference only between optimal responder CML and control group as shown in (Fig. 1B).

The median for white blood cells count (WBC $\times 10^3/\mu$ L) for control was 7.63, range (6.65-8.81). For optimal response was 6.0, range (5.15-7.29). For failure response patients was 10.4, range (5.6-27.68), with no significant difference only between control and failure CML response group ( $P = 0.999$ ) as shown in (Fig. 1C).



**Figure 1: Patients characteristics according complete blood count among different CML groups and control group. A) Hemoglobin levels B) Platelet count C) WBCs count.**

All CML cases were categorized according to imatinib therapy response depending on the results of QPCR for p210 BCR-ABL transcripts and peripheral blood indices for each patient. There was a significant difference ( $P < 0.001$ ) between failure response group with mean ( $28.4 \pm 25.1\%$ ) and optimal response group with mean ( $0.02 \pm 0.03\%$ ) regarding the BCR-ABL transcript levels. All patients with optimal response were with major molecular response (p210 BCR-ABL transcripts  $\leq 0.1\%$ ), and 19(63.3%) of them had molecular response with BCR-ABL level ( $0.1 - >0.0032\%$ ) log3 & 4 reduction in BCR-ABL1 transcripts levels, while the other responders patients with 11(36.7%) had BCR-ABL ( $\leq 0.0032$ ) log4.5 & 5 reduction levels.

Among failure responders patients, there were 93.3% had (BCR-ABL transcripts  $>1\%$ ). 15(50%) out of them had a failure hematological response (FHR)

and failure molecular response (FMR), 13(43.3%) had only FMR and there were only 2(6.7%) with BCR-ABL levels between ( $> 0.1 - 1\%$ ) had FHR.

By the flow cytometry analysis of CD4+CD25+ T cells and PD1 expression among these cells in CML patients treated with imatinib therapy (Fig. 2). The (mean $\pm$ SD) of CD4+T cells percentage for the control, optimal and failure response patients were ( $37.70 \pm 7.96\%$ ,  $38.39 \pm 8.55\%$  and  $35.86 \pm 9.55\%$ , respectively) with ( $P = 0.5$ ). Among these CD4+ T cells the median of CD4+CD25+ Tregs percentage for the control was 8.8, range (4.8-16.2), for optimal response 16.6, range (5.2-50.2) and for failure response patients was 71.7, range (52.0-92.8). There was no significant difference between control and optimal groups with ( $P = 0.481$ ), while there was a significant increase in percentage of CD4+CD25+ Tregs in failure groups compared to the control and

optimal groups ( $P = <0.001$ ) for both as shown in (Table 1; Fig. 3).

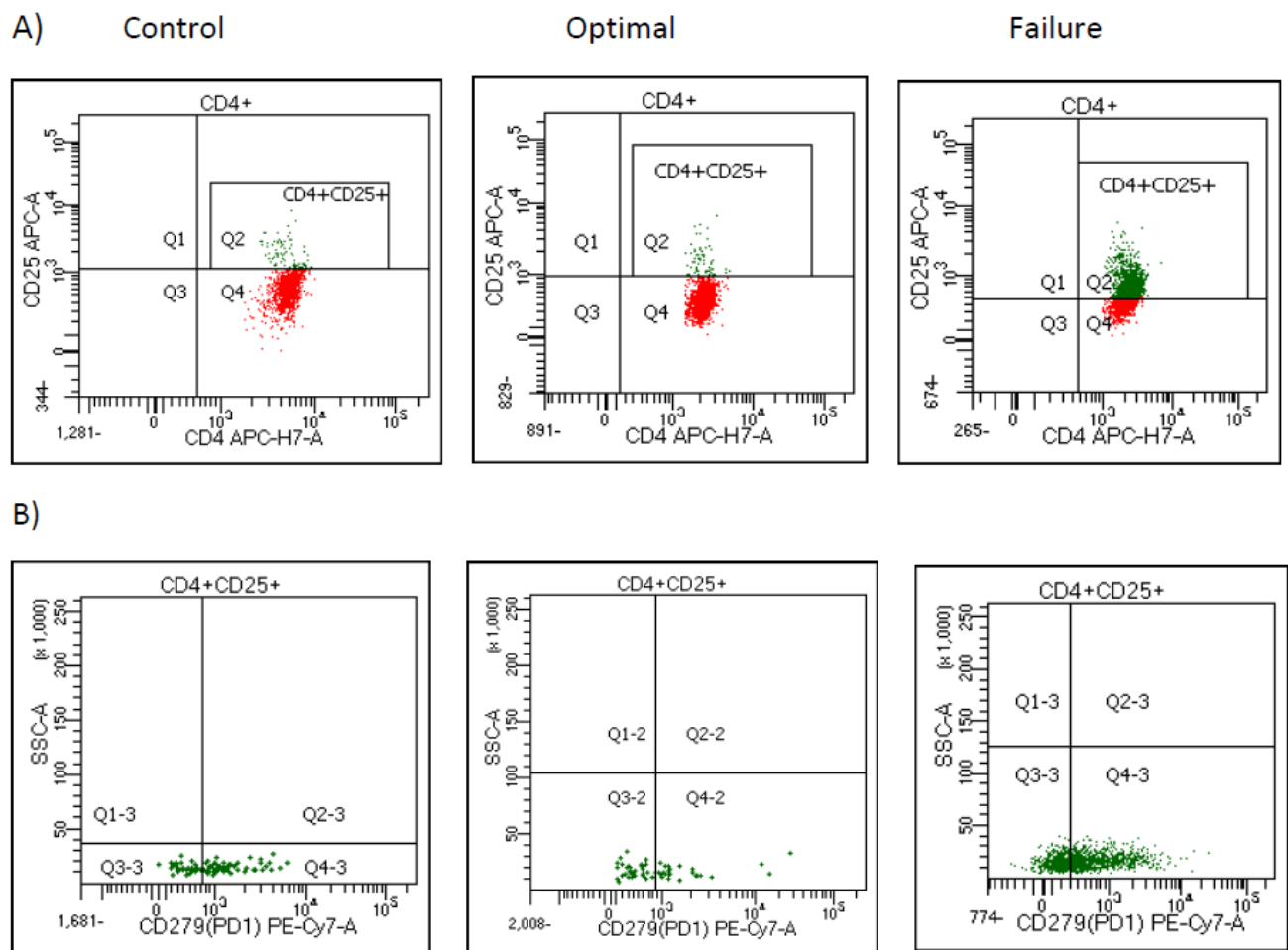
Regarding PD1 expression, data demonstrate no significant differences ( $P = 0.125$ ) in PD1+ among

CD4+CD25+ T cells, although data fail to reach significance but there was a higher expression in PD1 percentage in failure groups compared to optimal and control groups (Table 1).

**Table 1: Assessment of CD4+CD25+ T cells percentage among different CML patients and control group.**

Percentage (%)	Control (30)	Optimal (30)	Failure (30)	P value
*CD4+	37.70±7.96	38.39±8.55	35.86±9.55	0.511
# CD4+CD25+ in CD4+ T cells (range)	8.8(4.8-16.2)	16.6(5.2-50.2)	71.7(52.0-92.8)	<0.001
*PD1+ in CD4+ CD25+ cells	65.30±18.88	61.70±18.96	71.60±18.56	0.125

\*Presented using their mean ± standard deviation, # Presented using their median (interquartile range)



**Figure 2: Flow cytometric analysis among different CML groups and control group.**

A) Gate for CD4+CD25+Tregs in all CD4+ T cells B) Gate for PD1 expression in CD4+CD25+ Tregs.

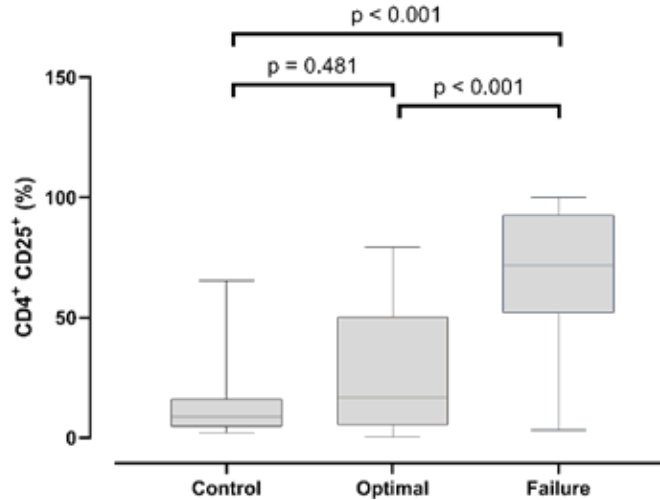


Figure 3: Percentage of CD4+CD25+ T cells among different CML groups and control group.

Receiver operating characteristic (ROC) curve analysis was applied in order to determine a cutoff value of CD4+CD25+ Tregs by comparing their percentage among studied groups. Data failed to discriminate between optimal response and healthy control as shown

in (Table 2). However, a cutoff value at (>33.7 %) was highly significant with high sensitivity and specificity that can be utilized to discriminate failure from optimal responders as shown in (Table 3).

Table 2: The Roc analysis for CD4+CD25+ Tregs percentage in studied groups

Groups/%CD4+CD25+	AUC	Explanation	95%CI of AUC	P value	Cut off %	SN	SP
Optimal vs Healthy	0.619	Poor	0.484 to 0.741	0.115	-	-	-
Optimal vs Failure	0.864	Good	0.751 to 0.939	<0.001	>33.7	96.7	70

AUC: area under the curve, CI: confidence interval, SN: sensitivity, SP: specificity

### Discussion

Imatinib mesylate has an influence on the immune cells that can be both suppressive or stimulating<sup>(10)</sup>. There is a clear discordance in immune response among CML patients, exemplified by the presence of many patients losing their response during the TKI treatment, whereas some others can develop deep molecular response, making the choice of stopping TKI treatment feasible for those patients<sup>(11)</sup>.

In this study, we include 60 patients of CML with mean age 46.8±13.7, range (18-75) years old, the male:female ratio 1.14:1 which is comparable to ELN 2020 review as a younger age distribution among Asian population was <50 years old<sup>(12)</sup>. This study showed that the peripheral blood indices were lower

in hemoglobin level and higher in WBC counts among failure group compared to the control and the optimal responders groups. This is related to bone marrow suppression by an increased leukemic clone cells due to loss of TKI response and transformation of CML patient to an advanced stage. The optimal responders CML patients also showed a lower hemoglobin level than the control group, which might be linked to the effect of long usage of imatinib treatment as the mean duration of treatment in our cohort where 73.7 ± 37.6 months, this is agree with Moura *et al.*,<sup>(13)</sup>. The median platelets count among all studied groups was within normal range and this doesn't exclude presence of different phases of CML in this study.

Among CML patients with failure molecular response to imatinib therapy, there was significant (P =

<0.001) higher median of CD4+CD25+Tregs (71.7%) in comparison to both optimal responders patients (16.6%) and control group (8.8%), without significant differences between the control group and the optimal responders patients. The presences of Tregs with high median level among non-responders CML patients, may reflect the suppression degree of immune effector cells response to the increased leukemic clone cells, and this may be through contribution of Tregs to inhibit the immune response to the disease activity. Conversely, the optimal responder CML patients showed much lower median level than the patients with failure response to therapy, with non-significant difference with the control group. This might be due to that the leukemic cell burden among the responders patients to imatinib therapy were much lower, indicating the efficacy of treatment that directly or indirectly reduced the Tregs counts and reconstitute the immune function. Our results are in line with Larmonier *et al.*,<sup>(10)</sup> who found through in vivo and in vitro investigations that imatinib therapy decreased Treg frequency and impaired their immune suppressive function. Recent study showed that imatinib treated CML patients in complete molecular remission exhibited selective depletion of effector Treg cells and significant increase in effector memory CD8+ T cells while non-complete molecular remission did not<sup>(14)</sup>.

Moreover, studies showed CD4+CD25+ Treg cells depletion reinstated an efficient anti-tumor immune response leading to complete tumor regression<sup>(15)</sup>. The possibility that the function of Tregs may also influence patients with cancer has been suggested by previous studies on CLL<sup>(16)</sup> and lymphoma malignancies<sup>(17)</sup>. Therefore, in relation to CML disease, the immunosuppressive properties of regulatory T cells seem to be particularly important in disease control status.

Our study established a cutoff value of CD4+CD25+ T cells at >33.7% which might be a good biomarker to distinguish between failure and optimal responders to TKI treatment.

In present study, the data analysis didn't show noticeable difference in mean levels of PD1 expression on Tregs among the studied groups, despite the higher mean level in failure responders CML patients. This may relate to the extent of PD-1 mediated inhibition depending on the strength of the TCR signal, where as PD-L1 expression on non-lymphoid tissues and its potential interaction with PD1 may subsequently determine the

extent of immune responses<sup>(18)</sup>. Park *et al.*,<sup>(19)</sup> suggested that PD1 expression in Tregs and the PD1/PDL1 interplay is responsible for T cells exhaustion and can inhibit their proliferation and cytokines releasing.

## Conclusion

CML disease undergoing TKI therapy is immune responsive disease, this response determined by the degree and type of CML molecular response, which may play a vital role in controlling the disease activity in advanced stage and deeper molecular response in patient who achieved MMoR. Our observation highlights the importance of Treg function and its interaction with PD1 among CML patients. Furthermore, our findings might turn the focus of the new therapies towards targeting these escape mechanisms.

**Conflict of Interest:** None

**Funding:** Self

**Ethical Clearance:** Not required

## Références

1. Hughes A, Clarkson J, Tang C, Vidovic L, White DL, Hughes TP, Yong AS. CML patients with deep molecular responses to TKI have restored immune effectors and decreased PD-1 and immune suppressors. *Blood, The Journal of the American Society of Hematology*. 2017 Mar 2;129(9):1166-76.
2. Tarafdar A, Hopcroft LE, Gallipoli P, Pellicano F, Cassels J, Hair A, Korfi K, Jørgensen HG, Vetric D, Holyoake TL, Michie AM. CML cells actively evade host immune surveillance through cytokine-mediated downregulation of MHC-II expression. *Blood, The Journal of the American Society of Hematology*. 2017 Jan 12;129(2):199-208.
3. Hochhaus A, Saussele S, Rosti G, Mahon FX, Janssen JJ, Hjorth-Hansen H, Richter J, Buske C, ESMO Guidelines Committee. Chronic myeloid leukaemia: ESMO Clinical Practice Guidelines for diagnosis, treatment and follow-up. *Annals of Oncology*. 2017 Jul 1;28(suppl\_4):iv41-51.
4. Brück O, Blom S, Dufva O, Turkki R, Chheda H, Ribeiro A, Kovanen P, Aittokallio T, Koskenvesa P, Kallioniemi O, Porkka K. Immune cell contexture in the bone marrow tumor microenvironment impacts therapy response in CML. *Leukemia*. 2018 Jul;32(7):1643-56.



5. Wu CP, Qing X, Wu CY, Zhu H, Zhou HY. Immunophenotype and increased presence of CD4+ CD25+ regulatory T cells in patients with acute lymphoblastic leukemia. *Oncology Letters*. 2012 Feb 1;3(2):421-4.
6. Tanaka A, Sakaguchi S. Regulatory T cells in cancer immunotherapy. *Cell research*. 2017 Jan;27(1):109-18.
7. Cai J, Wang D, Zhang G, Guo X. The role of PD-1/PD-L1 Axis in Treg development and function: implications for Cancer immunotherapy. *OncoTargets and therapy*. 2019;12:8437.
8. Hughes A, Yong AS. Immune effector recovery in chronic myeloid leukemia and treatment-free remission. *Frontiers in immunology*. 2017 Apr 24;8:469.
9. Baccarani M, Deininger MW, Rosti G, Hochhaus A, Soverini S, Apperley JF, Cervantes F, Clark RE, Cortes JE, Guilhot F, Hjorth-Hansen H. European LeukemiaNet recommendations for the management of chronic myeloid leukemia: 2013. *Blood*. 2013 Aug 8;122(6):872-84.
10. Larmonier N, Janikashvili N, LaCasse CJ, Larmonier CB, Cantrell J, Situ E, Lundeen T, Bonnotte B, Katsanis E. Imatinib mesylate inhibits CD4+ CD25+ regulatory T cell activity and enhances active immunotherapy against BCR-ABL- tumors. *The Journal of Immunology*. 2008 Nov 15;181(10):6955-63.
11. Mahon FX, Etienne G. Deep molecular response in chronic myeloid leukemia: the new goal of therapy?. *Clinical Cancer Research*. 2014 Jan 15;20(2):310-22.
12. Hochhaus A, Baccarani M, Silver RT, Schiffer C, Apperley JF, Cervantes F, Clark RE, Cortes JE, Deininger MW, Guilhot F, Hjorth-Hansen H. European LeukemiaNet 2020 recommendations for treating chronic myeloid leukemia. *Leukemia*. 2020 Mar 3:1-9.
13. Moura MS, Benevides TC, Delamain MT, Duarte GO, Percout PO, Dias MA, Zulli R, Souza CA, Lorand-Metze I, Pagnano KB. Evaluation of anemia after long-term treatment with imatinib in chronic myeloid leukemia patients in chronic phase. *Hematology, transfusion and cell therapy*. 2019 Dec;41(4):329-34.
14. Tanaka A, Nishikawa H, Noguchi S, Sugiyama D, Morikawa H, Takeuchi Y, Ha D, Shigeta N, Kitawaki T, Maeda Y, Saito T. Tyrosine kinase inhibitor imatinib augments tumor immunity by depleting effector regulatory T cells. *The Journal of experimental medicine*. 2020 Feb 3;217(2).
15. Beyer M, Kochanek M, Giese T, Endl E, Weihrauch MR, Knolle PA, Classen S, Schultze JL. In vivo peripheral expansion of naive CD4+ CD25high FoxP3+ regulatory T cells in patients with multiple myeloma. *Blood*. 2006 May 15;107(10):3940-9.
16. Beyer M, Kochanek M, Darabi K, Popov A, Jensen M, Endl E, Knolle PA, Thomas RK, von Bergwelt-Baildon M, Debey S, Hallek M. Reduced frequencies and suppressive function of CD4+ CD25hi regulatory T cells in patients with chronic lymphocytic leukemia after therapy with fludarabine. *Blood*. 2005 Sep 15;106(6):2018-25.
17. Álvaro T, Lejeune M, Salvadó MT, Bosch R, García JF, Jaén J, Banham AH, Roncador G, Montalbán C, Piris MA. Outcome in Hodgkin's lymphoma can be predicted from the presence of accompanying cytotoxic and regulatory T cells. *Clinical Cancer Research*. 2005 Feb 15;11(4):1467-73.
18. Freeman GJ, Long AJ, Iwai Y, Bourque K, Chernova T, Nishimura H, Fitz LJ, Malenkovich N, Okazaki T, Byrne MC, Horton HF. Engagement of the PD-1 immunoinhibitory receptor by a novel B7 family member leads to negative regulation of lymphocyte activation. *The Journal of experimental medicine*. 2000 Oct 2;192(7):1027-34.
19. Park HJ, Park JS, Jeong YH, Son J, Ban YH, Lee BH, Chen L, Chang J, Chung DH, Choi I, Ha SJ. PD-1 upregulated on regulatory T cells during chronic virus infection enhances the suppression of CD8+ T cell immune response via the interaction with PD-L1 expressed on CD8+ T cells. *The Journal of Immunology*. 2015 Jun 15;194(12):5801-11.

# Effect of Segmented Sleeping on the Academic Performance of Medical Students. A Questionnaire Survey

Shalini S.P.<sup>1</sup>, Balaji K.<sup>2</sup>, Yuvaraj Maria Francis<sup>3</sup>, Gunapriya Raghunath<sup>4</sup>, Vijayalakshmi S.<sup>5</sup>

<sup>1</sup>Phase I MBBS, Saveetha Medical College and Hospital, Thandalam, Chennai, India, <sup>2</sup>Tutor, Department of Anatomy, Saveetha Medical College and Hospital, Thandalam, Chennai, India, <sup>3</sup>Assistant Professor, Department of Anatomy, Saveetha Medical College and Hospital, Thandalam, Chennai, India, <sup>4</sup>Professor & Head, Department of Anatomy, Saveetha Medical College and Hospital, Thandalam, Chennai, India, <sup>5</sup>Professor, Department of Anatomy, Saveetha Medical College and Hospital, Thandalam, Chennai, India

## Abstract

**Background:** Sleep is a basic need of every individual, essential for a better quality of life and performance in the activity of daily living. Humans spend a third of their life sleeping. Even then, sleep disturbance is the common health issue in modern society which promotes late-night gatherings and shift-based work. Segmented sleep is one or many naps with one core sleep where the awake period also takes place in two or more sessions. Segmented sleep is considered to be an unhealthy practice today, is the way that our ancestors slept until the last few centuries.

**Aim and Objectives:** The study aims to assess the effect of segmented sleep patterns among medical students and correlating it with the academic performance of them.

**Method and Materials:** This study was done on 300 students with both male and female participants. A questionnaire was developed after the elaborated discussion and circulated among the students. The data was then analyzed using Microsoft Excel 2010.

**Results:** The overall quality of the sleep, regardless of how long participants slept was highly satisfactory in 61% and about 47% of participants spend 6–7 sleeping hours. Segmented sleeping among the participants has a positive impact on academic performance which was both, directly and indirectly, related to the amount of time spent by the participants in their studies.

**Conclusion:** Segmented sleep is the most natural way of treating sleep deprivation among the adolescent. Therefore, the segmented sleep pattern can be inducted in the daily schedule and then modifying to suit the individual's lifestyle.

**Keywords:** *Academic performance, Adolescence, Segmented Sleep, and Sleep deprivation.*

## Introduction

Sleep is the natural phenomenon that occurs in

every individual when the body and mind undergo a temporary state of rest. The individual is physically dormant and consciousness is suspended where the awareness about the environment is reduced. An average healthy individual spends approximately one-third of the life in sleeping and a normal individual need between seven to nine hours of sleep per day to stay healthy and function properly. Sleep is one of the four basic physiological needs namely hunger, thirst, sex, and sleep. The occurrence of sleep in the individual is still a mystery. Sleep has many functions such as development, growth, differentiation, repair, and learning or memory

---

### Corresponding Author:

**Mr. Balaji Karunakaran**

Tutor, Department of Anatomy, Saveetha Medical College & Hospital, Saveetha Institute of Medical & Technical Sciences, Thandalam, Chennai, Tamil Nadu, India 602 105

Mobile No.: 9894763124

e-mail: mevsig@gmail.com

consolidation, which occurs throughout the life span.<sup>1</sup> Adequate sleep plays an important role in the physical and mental wellbeing of the individual especially enhances the cognitive skills, memory retention, levels of concentration and performance of all the activities. Eight hours of continuous sleep in a day of an individual is considered a normal sleeping pattern and it is also known as monophasic sleep. However, there is also an alternative to normal sleeping patterns, called polyphasic or segmented sleep, which is one or many naps with one core sleep. The factors determining the sleep include sleep patterns, number of naps, core sleep length, and the time intervals. Any disturbance in these factors may lead to sleep deprivation, fails to get required sleep. The prevalence of sleep disorders ranges from 22% to 65% in the general population and about 28% of the medical students have insomnia symptoms.<sup>2-4</sup> An increased risk of sleep deprivation was reported in medical students.<sup>5</sup> Adequate sleep is positively linked with the general well-being of the individual and their performance in day to day activities.<sup>6,7</sup> Sleeping pattern of the medical students is an important factor for successful academic performance. Hence this study was done to investigate the effect of segmented sleeping on the academic performance of medical students.

### Method and Materials

This cross-sectional study was done from 2019 to 2020 academic year in the Department of Anatomy, Saveetha Medical College and Hospital, Saveetha Institute of Medical and Technical Sciences, Chennai after getting institutional ethical committee approval (Approval No: SMC/IEC/2020/03/143). The participants were 300 medical students from phase I and II MBBS. A questionnaire was developed and finalized after the elaborated and repeated discussion which was later circulated among the students. The questionnaire was designed with informed consent and questions enquiring about the demographic profile, total sleep time per day, number of naps in a day, sleep latency, and total study hours per day. The data was then analyzed using Microsoft Excel 2010.

### Results

Out of 300 students, 183 (61%) were females and 117 (39%) were males. The mean age was 18.9 years with a range of 18 to 21 years. Among the participating students, 55.9% stay in the hostel provided by the

educational institute itself, 35.3% are day scholars and 8.8% resided out-campus such as paying guests and rented houses near the campus.

About 47% of participants spend 6 – 7 sleeping hours, 32% of participants spend less than 5 hours, 12% spend about 8 – 9 hours and a small number of students (9%) spend more than 10 hours in sleeping on weekdays, during weekends, all the participants spend 1-2 hours excess in sleeping (Figure 1). More than half of the participants (56%) suffer from slight to moderate delay in sleep induction, time taken to fall asleep during night time and 2% of the participants suffered a severe delay in sleep induction. The overall quality of the sleep regardless of how long participants slept was highly satisfactory in 61%, moderately satisfactory in 37%, and unsatisfactory in 2% (Figure 2). Similarly, participants had issues in awakening after sleep (27%) and awakening during sleep (28%).

The majority of the participants (56.1%) spend less than 5 hours of sleep in a night time. The interesting finding was that 85.1 % of the participants have the habit of sleeping after the college hours and 50% of them were involved in the post-lunch nap. 32.4% of the participants know about segmented sleeping. Among the hostelers, 86% of the participants practice segmented sleep, whereas only 53% of the day scholars practice it. (Figure 3)

Less number of participants (11.8%) practice segmented sleeping and among them, 45.1% of participants positively responded that segmented sleeping helped to spend extra time in studies.

On comparing different correlates with participants segmented sleeping, it was found that segmented sleeping had a better impact on the academic performance which was both, directly and indirectly, related to the amount of time spent by the participants in their studies. (Table 1) It was also found that segmented sleeping was a better determinant of performance than the monophasic sleep where participants had a single continuous one, regardless of the number of hours spend on sleep.

Participants, who practice monophasic sleep, also had excessive daytime sleepiness 52% which affected their day to day activities including academic performance. Whereas participants who practice segmented sleeping had reported only 8% excessive daytime sleepiness.

## Discussion

Segmented sleeping is human's naturally evolved system, well-practiced by ancestors for a long time which was scientifically proved among Romans.<sup>8</sup> The study done by Barbato G et al 1994 demonstrated the experiment on 14 individuals in which the body reverts to a segmented sleeping on the induction of removal of modern lighting.<sup>9</sup> The prevalence of sleep disorders is common in females than males, the gender difference is mainly due to men report adverse effects of sleep quality, whereas females more specifically concentrate on a single symptom.<sup>10</sup> The sleep pattern among medical students on working days and holidays that students slept for more than 8 hours and there was a significant change in the sleep initiation which happened after midnight and wake up the late morning the next day which is normally seen in adolescents. A shift of about 2hrs from the normal is seen in these subjects.<sup>11-13</sup>

In 2017, Philips reported negative linear correlations between academic performance and sleep patterns.<sup>14</sup> Medical students who scored "A" in their academic examination had a higher sleep duration when compared with "B" and "C" scoring students.<sup>15</sup> This significant difference between the students does not explain the students sleeping pattern whether it was monophasic or segmented sleeping. Hence the increase in mean sleep duration with segmented sleeping may also increase academic performance. The modern trend of participating insocial gathering for recreation especially late-night gatherings lead to change in the sleeping patterns among different classes of the society. Further, monophasic sleep used by those who went to sleep later may still have been the segmented sleeping pattern in their second sleep.<sup>16</sup>

Genzel et al. reported a significant correlation between sleep quality during the semester and the pre-clinical board exam performance among medical students. Further, the sleep quality after the board exams for the next year was investigated where the relationship could not be determined. In another study by the same author also concluded that the relationship between sleep quality during the semester and the academic performance in the board exam could not be determined.<sup>17</sup> The limitations of this study are excluding a few factors such as academic stress, and personal issues which may affect academic performance. Moreover,

this study was conducted with participants of only one medical college which need to be elaborate to more sample size. The results of this study are very peculiar. Most participants with lower academic performance found to have monophasic sleep which with short sleep duration may affect sleep quality, sleep efficiency, and sense of sleepiness almost every day. Participants who practice segmented sleep scored better in academic performance were able to get adequate sleep, better sleep quality. Hence with the proper and correct way of segmented sleeping, the academic performance of the students can be improved.

To summarize, the present study evaluated the relationship between academic performance and segmented sleep. The results could show that sleep quality was linked with academic performance. Medical students who suffer from sleep quality issues, which have so far been underestimated health issues should be addressed with segmented sleep pattern with the proper method to improve the academic performance and overall well-being.

## Conclusion

Sleep deprivation is one of the most common health issues among adolescents in modern society which is also a cause of poor academic performance. Segmented sleeping can be an answer to achieve better academic performance when it is practiced properly. The students, teaching faculties, and health professionals need to understand the role of segmented sleeping to improve academic performance. The educational institution should appoint a student psychologist who is also a sleep expert for counseling the students about the importance of quality sleep by segmented sleep for better academic achievement and a healthy lifestyle.

**Table 1: Showing the academic performance of participants based on their sleeping pattern**

Marks in Percentage	Monophasic sleep (%)	Segmented Sleep (%)
> 80	2	1
60 - 80	12	19
40 - 60	23	28
< 40	9	6

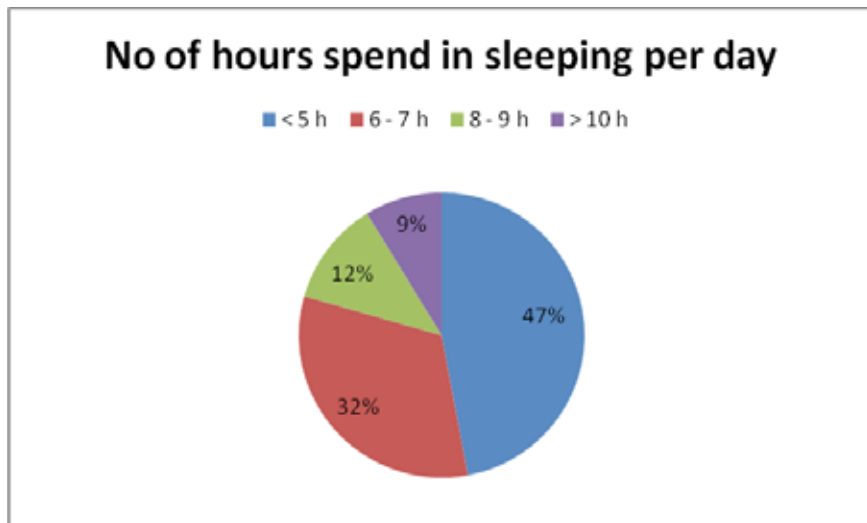


Figure 1: Showing the number of sleeping hours per day among the participants



Figure 2: Showing the sleep quality of the participants

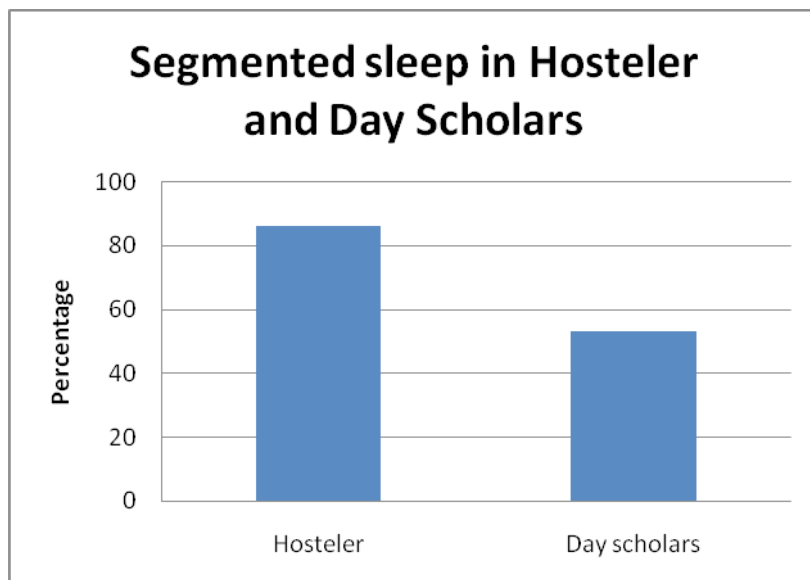


Figure 3: Showing the segmented sleep among hostelers and day scholars

**Acknowledgments:** The authors are thankful to all the faculties of the Department of Anatomy, Saveetha Medical College and Hospital, Saveetha Institute of Medical And Technical Sciences (SIMATS), Chennai, India, for the support and gratitude to carry out this work.

**Funding:** Self-funding

**Conflicts of Interest:** The authors don't have any conflicting interests.

### References

1. Curcio G, Ferrara M, De Gennaro L. Sleep loss, learning capacity and academic performance. *Sleep Med Rev.*2006;10(5):323–337.
2. Jewett ME, Dijk DJ, Kronauer RE, Dinges DF. Dose-responsere-relationship between sleep duration and human psychomotor vigilance and subjective alertness. *Sleep.* 1999; 22(2):171–179.
3. Roth T, Ancoli-Israel S. Daytime consequences and correlates of insomnia in the United States: Results of the 1991 National Sleep Foundation Survey II. *Sleep.* 1999; 22:S354–S358.
4. Foley DJ, Monjan AA, Brown SL, Simonsick EM, Wallace RB, Blazer DG. Sleep complaints among elderly persons: An epidemiologic study of three communities. *Sleep.* 1995; 18(6):425–432.
5. Loayza HMP, Ponte TC, Carvalho CG, Pedrotti MR, Nunes PV, Souza CM, Zanette CB, Voltolini S, Chaves ML. Association between mental health screening by self-report questionnaire and insomnia in medical students. *Arq Neuropsiquiatr.*2001; 59(2–A):180–185.
6. Parkerson Jr GR, Broadhead WE, Tse CK. The health status and life satisfaction of first-year medical students. *Acad Med.* 1990; 65(9):586–588.
7. Eliasson AH, Lettieri CJ, Eliasson AH. Early to bed, early to rise! Sleep habits and academic performance in college students. *Sleep Breath.* 2010; 14(1):71–75.
8. Nissin, Laura. Sleeping culture in Roman literary sources. *Arctos.* 2015; 49.
9. Barbato G, Barker C, Bender C, Giesen HA, Wehr TA, Extended sleep in humans in 14 hour nights relationship between REM density and spontaneous awakening Electroencephalography and clinical Neurophysiology. 1994; 90: 291-297
10. Niemi PM, Vainiomaki PT. Medical students' distress – quality, continuity and gender differences during a six-year medical programme. *Med Teach* 2006; 28(2):136–141.
11. Pelayo RP, Thorpy MJ, Glovinsky P. Prevalence of delayed sleep phase syndrome among adolescents. *Sleep Res.*1998;17:391
12. Regestein QR, Pavlova M. Treatment of delayed sleep phase syndrome. *Gen Hosp Psychiatry.* 1995;17:335-345.
13. Ando K, Kripke DF, Ancoli-Israel S. Estimated prevalence of delayed and advanced sleep phase syndromes. *Sleep Res.* 1995;24:509.
14. Phillips, A. J. K., Clerx, W. M., O'Brien, C. S., Sano, A., Barger, L. K., Picard, R. W., Lockley, S. W., Klerman, E. B., & Czeisler, C. A. Irregular sleep/wake patterns are associated with poorer academic performance and delayed circadian and sleep/wake timing. *Scientific Reports*, 2017; 7(1):3216.
15. Mirghani HO, Mohammed OS, Almutadha YM, Ahmed MS: Good sleep quality is associated with better academic performance among Sudanese medical students. *BMC Res Notes.* 2015; 8:706.
16. Ekirch, A. Roger. "Sleep We Have Lost: Pre-Industrial Slumber in the British Isles." *The American Historical Review* 2001; 106(2): 343-86.
17. Alotaibi AD, Alosaimi FM, Alajlan AA, Khalid A. Rahman BA, The relationship between sleep quality, stress, and academic performance among medical students *J Family Community Med.* 2020; 27(1): 23–28.

# Study *ndvB* gene Expression in *Pseudomonas aeruginosa* Producing Biofilm

Shamam Tahseen Ismail<sup>1</sup>, Mohammed Ibraheem Nader Altaai<sup>2</sup>

<sup>1</sup>Researcher Scholar, <sup>2</sup>Professor, Institute Genetic Engineering and Biotechnology for Post Graduated Studies, University of Baghdad, Designation Department of genetic engineering in institute of genetic engineering and biotechnology for post graduated studies, university of Baghdad, Adress Iraq-Baghdad-Al-Jadiriya-University of Baghdad

## Abstract

*Pseudomonas aeruginosa* have ability to form biofilm, this biofilm responsible for wide infections and antibiotic resistance development. A novel mechanism to antibiotic resistance mechanisms utilized by biofilm represented by the presence of *ndvB* gene encodes a glucosyltransferase enzyme involved in the formation of this glucans, this glucan mediated sequestration antibiotic away from their cellular targets. In this study was collected 145 samples from burns patients and identification by biochemical tests and Vitek-2 compact. The studied the biofilm formation was measured using micro titer plate method we found that 49 isolates (100%) of *P.aeruginosa* were biofilm positive and measured minimal biofilm inhibitory concentration (MBIC) of biofilm *P.aeruginosa* positive biofilm used cefepime as antibiotic was tested using microtiter plate microdilution method (MBIC) values (1gm/ml). Molecular detection of *ndvB* gene was measured using PCR 100% of isolates were found to contain *ndvB* gene. Expression of *ndvB* gene was significantly high in biofilm isolates using sub-MBIC values of cefepime. Expression of *ndvB* gene was significantly high in biofilm isolates using glucose with concentration 1% and 2%. This study we concluded biofilm formation is an important trait of *P.aeruginosa* that is a cause of antibiotic resistance. *ndvB* gene expression responsible for the biofilm resistance mechanism in *P. aeruginosa* biofilms.

**Keywords:** *Pseudomonas aeruginosa*, *ndvB*, biofilm.

## Introduction

*Pseudomonas aeruginosa* is an opportunistic pathogen that give rise to a high rate of mortality and morbidity in hospitalized patients with compromised immune systems and infections are being very hard to be treated, because of the increasing number of antibiotic resistant strains, becoming one of the main problems in hospitals<sup>(1)</sup>. *P.aeruginosa* is capable to compose biofilms in numerous surfaces, biofilms promote the bacterium to adhere and survive on the surfaces and medical devices<sup>(2)</sup>. Biofilms are micro colonies composed of multiple

microbial species like as community organization leading to stay survival in harsh conditions, bacterial cells of biofilm are more resistant than planktonic cells<sup>(3)</sup>. The insistence these microorganisms in the environment can provide as a source of transmission in the hospital environment<sup>(4)</sup>. The biofilm contain matrix has been contain a mixture of polymers, including: nucleic acids extracellular DNA (eDNA), proteins and polysaccharides. Exopolysaccharide matrix that borders the cells in the biofilm prevents spread of the antimicrobial agents through the biofilm and keep the cells of the biofilm in community together<sup>(5)</sup>. Biofilm contains many genes *ndvB* gene is one of these genes protect biofilm cells from antibiotics. The *ndvB* gene, encodes the glucosyltransferase enzyme that responsible for the formation of cyclic glucans, the glucans are cyclic polymers of 12 to 15  $\beta$ - (1 $\rightarrow$ 3) linked glucose molecules with phospho glycerol substitutions<sup>(6)</sup>. This study aimed to detection of the biofilm formation,

---

### Corresponding Author:

**Shamam Tahseen Ismail**

Researcher Scholar, Institute Genetic Engineering and Biotechnology for Post Graduated Studies, University of Baghdad

e-mail: shamamrf86@gmail.com

antibiotic susceptibility pattern of *P.aeruginosa* isolated from clinical samples and measure the gene expression of *ndvB* gene among isolates forming biofilms.

## Materials and Method

**Bacterial Isolates:** In this study, a total of (145) samples (swab) were collected from patients suffering from burns. A total of samples was collected from (Medical City Specialist and Al-Yarmook General Teaching Hospital), The isolates were collected during the study period from initial November/2019 finished in the end of February/2020.

**Sample collection and bacterial identification:** All samples were cultured on multiple media (Blood agar, MacConkey agar and Cetrimide agar) were used to identify the bacteria, pure colonies with appropriate of the phenotypic characterization based on physiological, morphological, and further tested by conventional biochemical tests including catalase test, oxidase test, Lactose fermentation test, Hemolysin production test, Pigment production test and growth at 42°C leading to identification as *P.aeruginosa*.

### Antibiotic susceptibility testing

Antibiotic susceptibility test AST of all isolates was determined by Vitek-2 automated susceptibility testing system using GN-AST cards to all 49 *P.aeruginosa* isolates against twelve antimicrobial agents : amikacin, tobramycin, gentamicin, cefepime, ceftazidime, imipenem, meropenem, ciprofloxacin, ticarcillin–clavulanic acid, piperacillin and colistin. These isolates showed different susceptibility.

**Biofilm susceptibility assay:** *Pseudomonas aeruginosa* biofilms were measured by microtitre plate method to determine biofilm production. In this method, the *P.aeruginosa* isolates were grown overnight at 37°C in Mueller-Hinton Broth (MHB) containing 1% glucose. Then, microtitre plates were inoculated with 125 µl bacterial suspension adjusted to 0.5 McFarland. Microtiter plate were incubated at 24 hrs at 37°C. After biofilms formed on the walls of micro titer plate are stained with 150 µl of 0.1% crystal violet for 10 min. Then, plate washing twice with phosphate-buffered saline (PBS) (pH 7.2) to discharge crystal violet stain. After air drying process of wells of microplate. The microplate is re-solubilized by 150µl of 95% ethanol. Then, plate was measured at 570 nm by a microtiter

plate reader<sup>(7)</sup>. According the optical density of the samples were classified Mean OD value (> 0.240) as strong biofilm, (0.120 - 0.240) as moderate biofilm and (< 0.120) as weak biofilm<sup>(8)</sup>.

**Determination of minimum biofilm inhibitory concentration (MBIC):** After forming biofilms on 96-well plates previously described<sup>(7)</sup>. The minimum biofilm inhibitory concentration (MBIC) were measured. Prepared nine folds dilution in the different range (100mg/ml, 10mg/ml, 1mg/ml, 0.1mg/ml, 0.01mg/ml, 0.001mg/ml, 0.0001mg/ml, 0.00001mg/ml, 0.000001mg/ml). The antimicrobial agent cefepime, were diluted using Mueller-Hinton broth (MHB). Then, added 100µl of each serial fold dilutions of antibiotics concentration into the each wells of the plates. Negative control contained only as sterility MHB. All the plates were incubated at 37°C for 24 h. After incubated the microtiter plate was washed with sterile water. Then, the measured optical density at 650 nm was measured after incubation. The MBIC was determined as the concentration at which the absorbance is equal to or less than that of the negative control<sup>(9)</sup>.

**Polymerase chain reaction (PCR):** The amplified *ndvB* gene were by PCR using a specific primer Forward (5'-GGCCTGAACATCTTCTTCACC-3') and (5'GATCTTGCCGACCTTGAAGAC-3') Reverse<sup>(10)</sup>. Amplification of *ndvB* gene were performed the amplification of *ndvB* gene was performed as follows: initial denaturation step at 95°C for 5min (one cycle), followed by 30 cycles consisting of denaturation at 95°C for 30s, annealing at 56°C for 30s and extension at 72°C for 30s, and final extension at 72°C for 10 min. The PCR products were visualized following electrophoresis on 1% agarose gels and staining with ethidium bromide.

**quantitative real-time PCR (RT-qPCR):** It was used to measure the expression of *ndv B* gene to antibiotic resistance after treated with it has been used the concentration (0.0001) as sub-inhibitor MBIC. After that, RNA extraction was done using general RNA extraction kit (Promega, USA) according to manufacture instructions. To measure the *ndvB* gene expression, a pair of primers specific for *ndvB* gene Forward (5'-GGCCTGAACATCTTCTTCACC-3') and (5'GATCTTGCCGACCTTGAAGAC-3') Reverse<sup>(10)</sup>. For a control the primers Forward (5'CCTGACCCGTCGCCACAAC-3') and Reverse (5'CGCAGCAGGATGCCGACGCC-3') were used to amplify and quantify mRNA of the expressed



bacterial *gyrB* gene<sup>(11)</sup>. The qPCR real-time PCR) was programmed as following; 95°C for 15 min and 40 cycles each cycle consists of 95°C for 60sec, 56°C for 30sec and 72°C for 30sec. After adding glucose in concentration (1% and 2%). The measure expression of *ndvB* gene after treated with glucos at concentrations of 1% and 2%, the same *ndvB*, control primer *gyrB* gene and the programs were used.

**Findings:** The study period, 49 *P.aeruginosa* isolates were identified from 145 clinical specimens from burns patients. The antibiotic susceptibility patterns of the *P.aeruginosa* isolates by Vitek-2 compact that (57.14%) of the isolates were Multi-Drug Resistant (MDR). It was found that, among 49 isolates of *P.aerugenosa* isolates.

The results of resistance to antibiotics percentage among isolates show in (table 1).

**Table 1: These isolates showed different susceptibility towards these antibiotics**

Type of antibiotic	No & percentage (%)
Ticarcillin	40 (81.65%)
Ticarcillin-clavulanic acid	40 (81.65%)
Piperacillin	40 (81.65%)
Cefepime	38 (77.55%)
Amikacin	36 (73.50%)
Tobramycin	36 (73.50%)
Gentamicin	36 (73.50%)
Meropenem	36 (73.50%)
Ciprofloxacin	32 (65.30%)
Imipenem	28 (57.14%)
Ceftazidime	24 (48.96%)
Colistin	49 (100%)
Chi-square ( $\chi^2$ )	9.891 **
P-value	0.0001

\*\* (P<0.01).

After measuring 49(100%) from 49 isolates were biofilmpositive were used microtiter tissue culture plate method. Where it is found 4 moderate biofilm and 45 strong biofilmas shown in (table 2). The minimum biofilm inhibitory concentration (MBIC) (0,0001mg/ml) of cefepime against 49 positive biofilm measured by using microtiter plates serial dilutions method.

**Table 2: Pseudomonas aeruginosa isolates ability to produce biofimby using (MTP) method**

Biofilm produce	No	Percentage
Strong (+++)	45	91.8 %
Moderate (++)	4	8.8 %
Total	49	100 %
Chi-square ( $\chi^2$ )	---	14.286 **
P-value	---	0.0001

\*\* (P<0.01).

According to PCR *ndvB* gene were found in 49 (100%) from the 49 *P.aeruginosa* isolates. Then, study of gene expression was conducted by select 5 *P.aerugenosa* isolates. The study showed that increase gene expression of *ndvB* gene to the highest biofilm and moderate biofilm according to method (MTP), after treated with the cefepime using a concentration (0.0001gm/ml)the dose of sub-MBIC. Furthermore,increase gene expression of *ndvB* gene to the highest and moderate biofilm which measured the to5isolates were tested after treated with glucose using a concentration (1% and 2%).

## Discussion

The present study showed(2) that *P.aeruginosa* isolates responsible for burnsinfenctions that occur in hospital and the emergence of resistant *P.aeruginosa* infections and resistance to antimicrobial agents make it considered is Multi-Drug Resistant (MDR)this is agreement with Emamiet al.<sup>(12)</sup>.

The results of resistance percentage among isolates, to sub-catogeries, the highest prevalence of resistance to antibiotic was detected with Ticarcillin 40(81.65%), Ticarcillin-clavulanic acid 40(81.65%), Piperacillin 40(81.65%), Cefepime 38(77.55%), Amikacin 36(73.5%), Tobramycin 36(73.5%), Gentamicin 36(73.5%), Meropenem 36(73.5%), Ciprofloxacin 32(65.3%) were respectively, but less with Imipenem 28(57.14%), and Ceftazidime 24(48.96%) respectively and all *P.aeruginosa* 49(100%) of isolates sensitive with colistinthis is agreement with

Memar et al<sup>(13)</sup> because of *P.aeruginosa* have high intrinsic resistance to toxic molecules surrounded toxic molecules by a poorly permeable of the outer membrane that allows extrusion mechanisms, such as efflux systems are able to export antibiotics and thus, to

impair the interaction of drugs with their cellular targets. At least four efflux pumps of the resistance-nodulation-cell division (RND) family can significantly increase the resistance of *P.aeruginosa* to antibiotics when overproduced upon mutations<sup>(14)</sup>.

The ability all isolates of *P. aeruginosa* to produce biofilm was detected by using standard microtiter plates. All *P.aeruginosa* isolates had the ability of biofilm production. The association between biofilm formation and antibiotic resistance revealed that biofilm production was significantly higher among MDR *P.aeruginosa* isolates this agreement with Abidiet al<sup>(15)</sup>. The results showed determine the minimum biofilm inhibitory concentration MBIC value of cefepim to the 49 *P. aeruginosa* isolates (1gm/ml). The highest antibacterial effect against biofilm of *P. aeruginosa* isolates by an absorbance values were able to kill 100% of all biofilm isolates in a 24 h after the treatment with cefepim were compared with the absorbance values of the control, cefepime demonstrated excellent activity against *P.aeruginosa* this result was in agreement with Khan et al<sup>(16)</sup>.

The PCR tests of *ndvB* gene confirms the occurrence of *P. aeruginosa* gene in mainly in all clinical isolates this agreement with Hall et al<sup>(17)</sup>. The gene expression of *ndvB* gene increased after the treatment with the cefepim because of *ndvB* gene has a new resistance mechanism through formation of periplasmic glucans. These glucans function in biofilm-specific antibiotic resistance prevents cell death by sequestering antibiotic molecules in the periplasm and away from their cellular (cytoplasmic) targets<sup>(5)</sup>. While the gene expression of *ndvB* gene increased after the treatment with the glucose 1% and 2%. The glucose stimulate the expression of *ndvB* gene therefore, the expression increased of *ndvB* gene when used of glucose after treatment, this study is compatible with we investigated<sup>(18)</sup>. The glucose increase biofilm formation ability of *P.aeruginosa*, this is because of the *ndvB* gene encodes the glucosyltransferase enzyme that responsible for the formation of cyclic glucans. The glucans are cyclic polymers of 12 to 15  $\beta$ - (1  $\rightarrow$  3) linked glucose molecules with phospho glycerol substitutions<sup>(6)</sup>.

### Conclusion

The ability of *P.aeruginosa* to form biofilm that cause of antibiotic resistance, sub-inhibitor MBIC to cefepime of biofilm positive *P.aeruginosa* isolates to

was associated with increased *ndvB* gene expression and increased glucose molecules in biofilm leads to increased ability of *P.aeruginosa* to form biofilm therefore, increased *ndvB* gene expression.

**Conflict of Interest:** Nil

**Source of Funding:** Self

**Ethical Clearance:** The principles and the experimental protocol in this study was approved by the Medico-Legal Directorate, Ministry of health, Baghdad, Iraq.

### References

1. Maurice NM, Bedi B, Sadikot RT. Pseudomonas aeruginosa Biofilms: Host Response and Clinical Implications in Lung Infections. *Am J Respir Cell Mol Biol.* 2018;58(4):428-439.
2. Lalancette C, Charron D, Laferrière C, et al. Hospital Drains as Reservoirs of Pseudomonas aeruginosa: Multiple-Locus Variable-Number of Tandem Repeats Analysis Genotypes Recovered from Faucets, Sink Surfaces and Patients. *Pathogens.* 2017;6(3):36.
3. Frösler J, Panitz C, Wingender J, Flemming HC, Rettberg P. Survival of Deinococcus geothermalis in Biofilms under Desiccation and Simulated Space and Martian Conditions. *Astrobiology.* 2017;17(5):431-447.
4. Esteves DC, Pereira VC, Souza JM, et al. Influence of biological fluids in bacterial viability on different hospital surfaces and fomites. *Am J Infect Control.* 2016;44(3):311-314
5. Ciofu O, Tolker-Nielsen T. Tolerance and Resistance of Pseudomonas aeruginosa Biofilms to Antimicrobial Agents-How P. aeruginosa Can Escape Antibiotics. *Front Microbiol.* 2019;10:913.
6. Sadovskaya I, Vinogradov E, Li J, Hachani A, Kowalska K, Filloux A. High-level antibiotic resistance in Pseudomonas aeruginosa biofilm: the *ndvB* gene is involved in the production of highly glycerol-phosphorylated  $\beta$ -D-glucans, which bind aminoglycosides. *Glycobiology.* 2010;20(7):895-904.
7. Jaffar N, Miyazaki T, Maeda T. Biofilm formation of periodontal pathogens on hydroxyapatite surfaces: Implications for periodontium damage. *J Biomed Mater Res A.* 2016;104(11):2873-2880.

8. Mathur T, Singhal S, Khan S, Upadhyay DJ, Fatma T, Rattan A. Detection of biofilm formation among the clinical isolates of Staphylococci: an evaluation of three different screening method. *Indian J Med Microbiol.* 2006;24(1):25-29.
9. Adukwu EC, Allen SC, Phillips CA. The anti-biofilm activity of lemongrass (*Cymbopogon flexuosus*) and grapefruit (*Citrus paradisi*) essential oils against five strains of *Staphylococcus aureus*. *J Appl Microbiol.* 2012;113(5):1217-1227.
10. Mohammed, N. A., Abd Alla I. M. (2018). Antibiotic resistance and *ndvB* gene expression among biofilm producing *Pseudomonas aeruginosa* isolates. *Journal Article*,17(4), 222-228
11. Aghamollaei H, Moghaddam M. M, Kooshki H, Heiat M, Mirnejad, R, & Barzi, N. S. Detection of *Pseudomonas aeruginosa* by a triplex polymerase chain reaction assay based on *lasI/R* and *gyrB* genes. *Journal of Infection and Public Health.* 2015;8(4), 314–322.
12. Emami S, Nikokar I, Ghasemi Y, et al. Antibiotic Resistance Pattern and Distribution of *pslA* Gene Among Biofilm Producing *Pseudomonas aeruginosa* Isolated From Waste Water of a Burn Center. *Jundishapur J Microbiol.* 2015;8(11):e23669.
13. Memar M. Y. et al. Colistin, an option for treatment of multiple drug resistant *Pseudomonas aeruginosa*. 2016:130-136]
14. Li XZ, Plésiat P, Nikaido H. The challenge of efflux-mediated antibiotic resistance in Gram-negative bacteria. *Clin Microbiol Rev.* 2015;28(2):337-418.
15. Abidi SH, Sherwani SK, Siddiqui TR, Bashir A, Kazmi SU. Drug resistance profile and biofilm forming potential of *Pseudomonas aeruginosa* isolated from contact lenses in Karachi-Pakistan. *BMC Ophthalmol.* 2013;13:57.
16. Khan HA, Baig FK, Mehboob R. Nosocomial infections: epidemiology, prevention, control and surveillance. *Journal of Tropical Biomedicine.* 2017;7(5), 478-482.
17. Hall CW, Hinz AJ, Gagnon LB, et al. *Pseudomonas aeruginosa* Biofilm Antibiotic Resistance Gene *ndvB* Expression Requires the RpoS Stationary-Phase Sigma Factor. *Appl Environ Microbiol.* 2018;84(7):e02762-17.
18. She P, Wang Y, Liu Y, et al. Effects of exogenous glucose on *Pseudomonas aeruginosa* biofilm formation and antibiotic resistance. *Microbiologyopen.* 2019;8(12):e933.

# Prevalence of Child Physical Abuse among School Children in Mosul City\North of Iraq

Shatha Abdul-Rahman H. Al-Ghurairi<sup>1</sup>, Eman Al- Khafaf<sup>2</sup>, Hana A. Al seed<sup>3</sup>

<sup>1</sup>PhD Community Medicine, Lecturer, Clinical Nursing Sciences Department, Nursing College, Mosul University, Iraq, <sup>2</sup>Msc Nursing Psychiatry, Lecturer, Clinical Nursing Sciences Department, Nursing College, Mosul University, Iraq, <sup>3</sup>Bsc. Nursing, Clinical Nursing Sciences Department, Nursing College, Mosul University, Iraq

## Abstract

**Background and Aims:** Physical abuse is the most critical problem in Mosul city children and the extent of physical abuse is currently unknown. Aim of this study to determine the prevalence of physical abuse among sample of Mosul schoolchildren, aged 12–18 years.

**Material and Method:** A cross-sectional study was carried out from 1<sup>st</sup>, December 2018 to 4<sup>th</sup> March 2019. The settings chosen by multicultural sampling with a systematic sampling technique of 800 child (396 male and 404 female) using a self-reported questionnaire.

**Result:** A total of 800 intermediate school children, age group 14-15 years represent 43.6%, male to female ratio 1:1, 36.1% of these had experienced physical abuse and 32.6% abused by mothers. The relationship between the parent educations and father's job shows high significant rate 0.000, 0.004.

**Conclusion:** physical abuse Mosul city had high prevalent in comparison with others. Psychological and physical problems of children were the main predictors.

**Keywords:** *Physical abuse of children, violence against children, Mosul City.*

## Introduction

Our children are often faced with choices that affect their development and safety. One way we do this is to talk with our children<sup>[1,2]</sup>. Child abuse defined as physical injury, emotional abuse, sexual abuse or non-accidental injuries or trauma inflicted on a child by another person were an active act of maltreatment of children, which can take place in several settings: at home, at school, in the streets, in the workplace<sup>[1]</sup>. A safe environment that supports and promotes children, dignity and development. More than 3 million reports of child abuse are received each year, including half a million reports of child sexual abuse. As a major youth-serving organization<sup>[1]</sup>. Parental intimate and partner violence is strong evidence for an overlap between child physical abuse and intimate partner. Child physical abuse (CPA) injuries can include bruises, broken bones, burns, and abrasions. CPA happens in all age groups; however, youth ages 12 to 17 have the highest rate of injury from physical abuse<sup>[3,4,5,6]</sup>. The youngest children are

the most sensitive to violence and injuries can become severe and cause lifelong consequences or even be life threatening. Shaken baby syndrome and Munchausen by proxy are examples of such severe types of CPA against small children<sup>[1,3,7,8]</sup>. Factors associated with the CPA are: The proportions of male/female perpetrators are often equal in survey studies<sup>[5,9,10,11,12]</sup>. Addiction and mental disorders/mental functional disorders could lead to poor impulse control. Parent's own history of abuse as a child now seems to be partly broken in Sweden<sup>[13]</sup>. Parental support for corporal punishment has a powerful predictor of violence against children<sup>[3,4,5,6]</sup>. Financial difficulties, parental educational level, unemployment, low socioeconomic status, traumatic experiences of war, medical health problems and single-parent households are all well-known conditions that have been reported as risk factors<sup>[4,5,6,7,8]</sup>. Younger children are more often subjected to abuse than older children are: Disability/chronic disease, behavioral problems are aggressive outbursts, disobedience, attention deficits and other externalizing problems, poor

health status, poor mental and/or physical health in adulthood<sup>[8,9,10,11,12,13,14]</sup>.

The objectives of this survey was to measure and describe the CPA aged 12–18 years old, assess differences in the abused children by gender, age, socioeconomic status, parental education, to distinguish the type of response of the child to the insult.

### Methodology

Prior to the actual collection date, a formal administrative approval was obtained. A descriptive cross sectional design was carried out from 1<sup>st</sup> December 2018 to 4<sup>th</sup> March 2019. The data was collected from intermediate school (boys and girls). The setting chosen by multicultural sampling taking the most crowded schools in public low and high socioeconomic discrete overall of the left and right sides of Nineveh province. A systematics amp ling technique (every three child)

were chosen from the school setting's consisted of(800) child. This divided into(396) male and (404) female through interviewing with children. Data collection form is constructed after reviewing many articles written on this topic. To ensure the validity of the study questionnaire,method and procedures proposed to carried out before the beginning of collection of sample so 6 experts in different specialists related to the field of the present study were chosen. They were asked to review the questionnaire for clarity and adequacy in order to achieve the present study objective. Most of them had agreed that the questionnaire were clear, relevant and adequacy, certain modification were employed based on the experts recommendations and suggestions. Collection and data analysis is done by the researcher manually. Tabulated and presented in a descriptive form. Percentage and chi square are used in calculation and description of the results by SPSS Program version 25.

### Results

**Table 1: Social and demographic characteristics of study sample**

Demographic Characteristics	Estimate	Freq.	%
Age	12-13 years	220	27.5
	14-15 years	349	43.6
	15 years and above	231	28.9
Gender	Male	396	49.5
	Female	404	50.5
Type of Family	Single Family	505	63.1
	Multiple Family	295	36.9
Number of the children in the Family	2-3	106	13.3
	4-5	254	31.8
	5 or more	440	55.0
Type of Housing	Possess	525	65.6
	Rent	275	34.4
House Rooms	1-2	169	21.1
	3-4	491	61.4
	5 or more	140	17.5
<b>Total</b>		<b>800</b>	<b>100.0</b>

Table 1:shows that age group 14-15 year represent 43.6%. male to female ratio approximately 1:1.

**Table 2: Abuse characteristic of the study samples**

<b>The Abuse Children</b>	<b>Estimate</b>	<b>Freq.</b>	<b>%</b>
Child Abuse	Not Abused	511	63.9
	Abused	289	36.1
Who Hits the Child	Father	230	28.8
	Mother	261	32.6
	Brothers	188	23.5
	Sisters	42	5.3
	Friends	55	6.9
	In School	24	3.0
Age of the child when started he\ she hits	1-2	150	18.8
	3-5	101	12.6
	6-8	147	18.4
	9-12	198	24.8
	13-15	139	17.4
	16 or more	65	8.1
Why the child hits	Study	332	41.5
	Bad manners	167	20.9
	Others	301	37.6
The child trust	Parents	496	62.0
	Friends	123	15.4
	None	181	22.6
Total		800	100.0

Table 2:36.1% is the prevalence of abuse in family sample and 32.6% of children abused by their mothers.

**Table 3: Psychological and medical problem of the study sample**

<b>The Problems</b>	<b>Estimate</b>	<b>Freq.</b>	<b>%</b>
The child have psychological problem	Yes	215	26.9
	No	585	73.1
Psychological problem	Non	585	73.1
	Speech difficulty	21	2.6
	Aggressive	17	2.1
	Depression	17	2.1
	Escape from school	116	14.5
	Others	44	5.5
The child have medical problem	Yes	213	26.6
	No	587	73.4
Medical problem	Non	587	73.4
	Difficulty concentrating	120	15.0
	Disability	5	.6
	Epileptic fit	5	.6
	Hereditary	43	5.4
	Thalassemia	36	4.5
	Incontinence	4	.5

Table 3 shows that children not have psychological and medical problem in 73.1% and 73.4 respectively.

**Table 4: The child response after hits of the study samples**

Type of Child Response	Freq.	%
Social withdrawal	223	27.9
Refuse eating	203	25.4
Hostility Towards His Family	67	8.4
Hurt himself	29	3.6
Escape from school	69	8.6
Indifference	146	18.3
Other	63	7.9
<b>Total</b>	<b>800</b>	<b>100.0</b>

Table 4 shows the child response after hits the children for family in the study is social withdrawal in 27.9%.

**Table 5: The relationship between the parent educations, Jobs with child Abuse**

Parent Educations	Items	Not Abused		Abused		Chi-seq.	P.value
		Freq.	%	Freq.	%		
Father Education	Illiterate Stage	49	9.5	26	9	34.95	0.000
	Read and write Stage	109	21.3	74	25.6		
	Elementary Stage	32	6.2	37	13		
	Intermediate Stage	118	23	25	8.6		
	Junior high Stage	79	15.5	40	13.8		
	Graduate Stage	124	24.5	87	30		
Mother Education	Illiterate Stage	18	3.5	30	10.3	62.27	0.000
	Read and write Stage	107	21	83	28.7		
	Elementary Stage	117	23	47	16.3		
	Intermediate Stage	75	14.6	42	14.5		
	Junior high Stage	76	14.8	69	24		
	Graduate Stage	118	23	18	6.2		
Father Job	Employee	167	32.6	131	45.5	13.45	0.004
	worker with skills	240	47	105	36.2		
	worker without skills	88	17.2	43	14.8		
	Unemployed	16	3.2	10	3.5		
Mother Job	Housewife	354	69.2	192	66.5	0.68	0.407
	Employee	157	30.8	97	33.5		
Total		511	100.0	289	100.0		

Table 5 shows the relationship between the parent educations, job and child abuse shows high significant rate 0.000.

**Table 6: The relationship between the social factors with child abuse**

Social Factors	Items	Not Abused		Abused		Chi-seq.	P.value
		Freq	%	Freq	%		
Family Income	Less than 300 thousand dinars	108	21.1	90	31.1	13.1	0.004
	400-800 thousand dinars	238	46.5	108	37.3		
	One Million	114	22.4	55	19		
	More than one million	51	10	36	24.6		
The father suffers from financial loss	Yes	161	31.5	87	30.1	0.170	0.680
	No	350	68.5	202	69.9		
Presence of stress at work	Always	25	5	65	24.5	72.84	0.00
	Sometime	147	28.8	103	20		
	Never	339	66.2	121	23.5		
Absence of Father	Yes	229	44.8	86	29.7	17.53	0.000
	No	282	55.2	203	70.3		
Marital Problem	Yes	141	57.5	64	22.2	2.87	0.090
	No	370	72.5	225	77.8		
Alcoholic Father	Yes	18	3.5	21	7.2	5.58	0.018
	No	493	96.5	268	92.8		
<b>Total</b>		<b>511</b>	<b>100.0</b>	<b>289</b>	<b>100.0</b>		

Table 6 shows that highly significant with family income, presence of stress at work, absence of father, and alcoholic father.

### Discussion

The home is supposed to provide support and safety for children but can also be the place where children suffer abuse and other adverse treatment by their parents. To the best of our knowledge, this article is the first published the extent of CPA in Mosul city. In such circumstances primary and intermediate schools provide a best numerical indicator. What is taken for granted in Iraq could not be assumed neither in western countries, higher income countries and more developed countries nor in other developing countries, because of impact of wars, embargo and disasters. Thus, the findings of the present study may differ if it is compared with other findings taken in another period of time or another place. Therefore, the figure of prevalence of CPA in student 36.1%. This study which could be quite helpful indicator of the problem of CPA in student in Mosul City. Review of the literature revealed a wide range of reports regarding the prevalence of CPA in children. Globally, prevalence of reported CPA varies from 2% to 62%<sup>[14,15]</sup>. In US In 2006, 16%. In 2008 It's very likely that many more children are physically abused than the

number that are reported<sup>[12,16,17]</sup>. In 2015, 63.4% were alleging child abuse and neglect<sup>[11]</sup>. This is correlated with the present study.

Our study shows 1:1 ratio similar gender distribution of CPA. In Sweden was stated that 50% of the girls and 28% of the boys had been exposed to CPA<sup>[13]</sup>. In US study more than one-half 54.1% of victims were female, 45.0% were men, and 0.9 percent were of unknown sex<sup>[14]</sup>. These results not correlated with the present study because of our culture that we are anxious more about female. Epidemiological studies suggest that CPA are more prevalent among children from low socioeconomic environments. 80% of this maltreatment is perpetrated by parents with poverty, in our study the association was significant in low to middle income families. Furthermore, mental health problems, low educational achievement, alcohol and drug misuse, having been maltreated oneself as a child, and family breakdown or violence between other family members are all important risk factors for parents abusing their children. These official cases are also generally skewed towards the lower end of the socioeconomic spectrum<sup>[2,3,5,6]</sup>,



this is correlated with the current study according to the presence of stress at work, mother and father education and father job. Moreover, Researches have shown that abuse may impair the healthy development of the brain. Chronic abuse can have significant and broad consequences. Physical, mental, and emotional development may all suffer<sup>[12]</sup>. Sweden study showed that 70% of the children who reported self-injurious behaviors also reported history of some type of abuse<sup>[13]</sup> Physical abuse, emotional abuse, and neglect were also associated with an almost 3-fold increased risk of developing eating disorders and others was associated with a 5-fold increased risk of developing bulimia Nervosa. Physical abuse was associated with a doubling of the odds of childhood behavioral and conduct disorder with a significantly increased risk of suicidal behavior compared with non-abused individuals<sup>[14]</sup>. Other study indicated that abuse in childhood increased the likelihood of adult criminal behavior by 28% and violent crime by 30%<sup>[12,14]</sup>.

The investigator recommend that traumatic event often trigger the development of CPA and its sequel may be eased by mediation of many factors such as: improve socioeconomic status of families to reduce stress.

### Conclusion

This cross-sectional study aimed to determine the prevalence of CPA among sample of Mosul schoolchildren, using a self-reported questionnaire. A total of 800 intermediate school children, age group 14-15 years represent more than one third, similar male to female ratio, more than one third of these had CPA and abused by mothers. Quarter of them had psychological problem. The relationship between the parent educations and father's job shows high significant rate.

**Recommendation:** The prevalence of physical in Mosul city is high and solutions should be sought to correct the problem engaging political and social leaders, the mass media, law enforcement agencies, parents and educators through research studies done to establish what works in this field.

**Funding:** This research was carried out at the researcher's own expense.

**Ethical Considerations:** The ethical letter was written in Arabic language as it is an official language for writing letters in the college of nursing Mosul-Iraq.

**Conflict Interest:** Nil

### References

1. Del Abuso C P, los Padres U G and suoficina D E. How to Protect Your Children From Child Abuse: A Parent's Guide. America .2005. 1-24 [www.scouting.org/pubs/ypt/pdf/46-072.pdf](http://www.scouting.org/pubs/ypt/pdf/46-072.pdf). 2010.1-69
2. Bcheraoui C. El, Kouriye H. and Adib S.M. Physical and verbal/emotional abuse of school children, Lebanon. .EMHJ. 18(10). 1011-1020.
3. Christian C W. Child Physical Abuse: An Overview. University of Pennsylvania, USA. 2012
4. Kjellgren C, Svedin Go and Nilsson D. Child Care in Practice; Child Physical Abuse: Experiences of Combined Treatment for Children and their Parents: APilotStudy:2013.19(3)275\_290<http://www.tandfonline.com/loi/cccp20>.
5. Portable Guides to Investigating Child Abuse. Battered Child syndrome: investigation Physical Abuse and homicide. U S department of justice. Office of juvenile justice and delinquency prevention. Office of justice program. 2002.1-20
6. Maneta EMD and Cohen sh, Waldinger R. Links Between Childhood Physical Abuse and Intimate Partner Aggression: The Mediating Role of Anger Expression. Violence and victims. Research linking childhood physical abuse (CPA) and adult intimate. With the Compliments of Springer Publishing Company, Violence and Victim 2012. 27(3):315-328.
7. Trauernicht G. The right to protection ending violence against children. 2013. 02:59.1-44
8. National commit . A Literature Review into Children Abused and/or Neglected Prior Custody 36. Studies related to interventions to address anti-social and offending behavior. 2008
9. del Abuso C P, los Padres U G and suoficina D E. How to Protect Your Children From Child Abuse: A Parent's Guide. America .2005. 1-24 [www.scouting.org/pubs/ypt/pdf/46-072.pdf](http://www.scouting.org/pubs/ypt/pdf/46-072.pdf)
10. Day C, Hibbert P. and Cadman S. A Literature Review into Children Abused and/or Neglected Prior Custody; Youth Crime Section, Policy and Research Division, Nacro. Youth justiceboard 2008. 1-69 [www.yjb.gov.uk](http://www.yjb.gov.uk)
11. Identifying and Responding to All Forms of Abuse in Victorian Schools. PROTECT Identifying signs

- of child abuse. Education state of vectoria. Protect. Small book. 2016.1-69
12. Kolko D. Questions & Answers About Child Physical Abuse. National child traumatic stress network NCTSN. 2011.1-5. [www.NCTSN.org](http://www.NCTSN.org).
  13. Annerbäck ME. Child Physical Abuse characteristics, prevalence, health and risk-taking. Department of Clinical and Experimental Medicine. Child and Adolescent Psychiatry Linköping University Sweden. 2011.1-99
  14. Norman R E, Byambaa M, Rumna De, Butchart3 A, Scott J. The long-term health consequences of child physical abuse, emotional abuse, and neglect: A systematic review and meta-analysis: PLOS Medicine | 2012 9(11):1-31. [www.plosmedicine.org](http://www.plosmedicine.org)
  15. Committee on the Rights of the Child. General comment. The right of the child to freedom from all forms of violence. Convention on the Rights of the Child. 2011.(13). 1-29
  16. Heisler Kand Mary EU.S. Department of Health & Human Services Administration for Children and Families Administration on Children. Child maltreatment. Youth and Families Children's Bureau. 2015. SW Washington, [kurt.heisler@acf.hhs.gov](mailto:kurt.heisler@acf.hhs.gov) Children's Bureau
  17. Perry, B. Child Abuse/Children Exposed to Family Violence Information Sheet. The destructive impact of domestic violence on children. In Alberta Children and Youth Services, Family violence it's your business: Community resource guide 2005.9-10 [http://www.child.alberta.ca/home/images/familyviolence/FVP\\_Communi-07643q\tyResourceGuide](http://www.child.alberta.ca/home/images/familyviolence/FVP_Communi-07643q\tyResourceGuide)
  18. Dwyer K., Strang H and National Committee on Violence. Violence Against Children.. Printed in Australia by R. D. RUBIE, Commonwealth Government Printer, Canberra. The right to protection: Ending violence against children. 1989.3-8.

# Quintessential Conceptualization of Bone Graft

Shipra Jaiswal<sup>1</sup>, Amit Wadhawan<sup>2</sup>, Mehvish Saleem<sup>3</sup>

<sup>1</sup>Post Graduate Student, Department of Periodontology, Subharti Dental College And Hospital, Swami Vivekanand Subharti University Meerut, <sup>2</sup>Professor, Department of Periodontology, Subharti Dental College and Hospital, Swami Vivekanand Subharti University Meerut, <sup>3</sup>Senior Lecturer, Department of Periodontology, Subharti Dental College and Hospital, Swami Vivekanand Subharti University Meerut

## Abstract

As we know that healthy periodontium, is affected in most of the periodontal diseases. Which further leads to damage of hard and soft tissues. To attain back the lost structures the use of bone grafts have shown promising results. Managed either by mechanically recontouring it or by grafting techniques. Replacement grafts are widely accepted as bone formation by promoting for periodontal regeneration. There are many bone graft material which are used as bone substitute to fill the defect site the graft material acts like scaffold on which body react it by certain bone mechanism helps to regenerate new bone. This article give an overview on history, rationale and objectives of bone replacement grafts, Biology of bone healing, Indications for bone grafting include, Ideal requirements of bone grafts, List of bone graft according to origin.

**Keywords:** Alloplast, bone allograft, bone autograft, periodontal regeneration, xenograft

## Introduction

Modern periodontics aims to maintain the healthy teeth and their supporting structures and the main goal is to control the infection and regenerate the lost supporting structures. Replacement of bone grafts are widely accepted as bone formation by promoting for periodontal regeneration. There are many bone graft material which are used as bone substitute to fill the defect site the graft material acts like scaffold on which body react it by certain bone mechanism helps to regenerate new bone. The basic principle of tissue regeneration is to stimulate a cascade of wound healing events. Hence, this review article focuses on the concept of bone graft discussing about various bone graft materials available and through light on the recent bone grafts.<sup>1</sup>

**History of Bone Grafts:** Historically, autogenous grafts were the first bone replacement grafts to be reported

for periodontal application. Allogeneic freeze-dried bone allografts were first introduced to periodontics in the early 1970's, while Demineralized freeze-dried bone allografts gained wider application in the late 1980's with an even increasing market share in 1990's.<sup>2</sup> Way back bone grafts used for reconstructing intraosseous by Hegedus in 1923.<sup>3</sup> further revived in 1965 by Nabers and O'leary, they used shavings of cortical bone removed by hand chisels during osteoplasty and ostectomy and they were used to treat one, two-wall defect.<sup>4</sup> Allografts of iliac bone and marrow were used by Schallhorn et al. in 1970.<sup>5</sup> The era of hydroxyapatite (HA) in regenerative science dates back to 1950s when bioceramics were used as an inert scaffold for filling of the bone defects.<sup>6</sup> Yukna in 1990 did a clinical 6-month study on hard tissue replacement (HTR) polymer (HTR synthetic bone) and showed a significant defect fill and improved attachment level relative to open flap debridement (OFD).<sup>7</sup> Bio-Oss is a bovine bone from which all inorganic components are removed and used for regeneration by Richardson et al. in 1999.<sup>8</sup>

---

## Corresponding Author:

**Dr. Shipra Jaiswal**

Post Graduate Student, Department of Periodontology,  
Subharti Dental College and Hospital, Swami  
Vivekanand Subharti University-250005  
e-mail: jaiswallshipra@gmail.com

**Rationale and Objectives of Bone Replacement Grafts:** Periodontal therapy is directed not only at inflammation control but also at pocket reduction and correction of associated bone defects. When applicable,

regeneration of the lost bone and periodontal attachment improves the support of the tooth and hopefully its long-term prognosis. At the present time, bone replacement grafts are the only modality of therapy for which there is histologic evidence, in humans, of regeneration of new attachment composed of new bone, cementum and periodontal ligament coronal to the base of a previous osseous defect<sup>9</sup>.

**Clinical Objectives of Bone Grafting:**

The objectives of bone grafting procedure in patients with periodontitis are as follows<sup>10</sup>:

1. Probing depth reduction
2. Clinical attachment gain
3. Bone fill of osseous defects and
4. Regeneration of new bone
5. Establish a healthy maintainable environment.

Numerous case reports and controlled clinical trials have provided clinical data on achieving histologic analysis, however, can accurately determine whether any true periodontal regeneration has developed because this is the only method that reveals the type of wound healing that occurs next to the root surfaces after grafting is undertaken.<sup>11</sup>

**Ideal characteristics of bone graft are as follows:**

1. Nontoxic
2. Non-antigenic
3. Resistant to infection
4. No root resorption
5. Strong and resilient
6. Easily adaptable
7. Readily and sufficiently available
8. Minimal surgical procedure
9. Stimulates new attachment

Based on these scientifically acceptable criteria, New attachment apparatus has been observed after certain autogenous and allogeneic grafts.<sup>12</sup>

**Biology of Bone Healing:**

1. Actively forms new bone
2. Induces bone formation

3. Creates passive surface for bone formation
4. Provides mechanical obstruction

The transplantation of bone or biosynthetic materials to repair skeletal defects is now an accepted surgical technique. Materials reported to have been used include cancellous, cortical, and corticocancellous bone, osteochondral plugs or synthetic material. Bone grafts provide osteogenic potential (primary osteogenesis or (osteoinduction) and scaffolding for in growth of new elements (osteoconduction).<sup>13</sup> Bone has the unique ability to heal completely and regain its original structure and mechanical properties; repaired tissue consists of new bone rather than scar tissue. The net biologic activity of the graft is the sum of its inherent biologic activity, its capacity to activate surrounding host tissues and its ability to support the in growth of host osteogenic tissue. During incorporation the graft site goes through several concurrent phases.<sup>14</sup> Bone graft success depends on the host recipient site, local growth factors of the host bed, bone graft viability, the volume of bone grafted and the structural function of the bone graft. Motion at the graft/host bone or soft tissue interface will impede or prevent revascularization.<sup>15</sup>

- The use of bone grafting or replacement materials is based on these materials may facilitate formation of alveolar bone, periodontal ligament and root cementum through one of the following mechanisms<sup>16</sup>:

1. Contain bone forming cells (osteoneogenesis).
2. Serve as scaffold for bone formation (osteoconduction).
3. Contain bone-inducing substances (osteoinduction).

**Indications:**

- Deep intraosseous defects of varying morphology
- Shallow intraosseous defects
- Furcations and shallow wide crater defect
- Ridge augmentation
- Combined procedure with GTR
- Peri-implant regenerative therapy.

**Ideal Requirements of Bone Grafts**

1. Should be immunologically acceptable
2. Should be resistant to infection
3. Should be biocompatible

4. Should be easily available
5. Should be cost effective

#### **Bone Graft According to Origin:**

**Autogenous Grafts:** Autogenous bone graft, which is harvested from the patient's own body, is considered ideal because of its osteoconductive and osteoinductive properties and because it contains a source of osteoprogenitor cells. It is still considered the gold standard among graft materials because they are superior at retaining cell viability. It combines all properties required in a bone graft material: osteoinduction (bone morphogenetic proteins (BMPs) and other growth factors), osteogenesis (osteoprogenitor cells) and osteoconduction (scaffold). Autogenous type of graft is harvested either from intraoral or extraoral donor sites. The intraoral sites include edentulous ridges, tori, maxillary tuberosity or healing bony wound or extraction sites as well as mandibular ramus and chin area. The extraoral sites most commonly used are iliac crest and ribs.<sup>17</sup>

**Allograft Graft:** An allograft, formerly called as homograft, is a tissue graft between individuals of same species but of non-identical genetic composition. Allografts are grafts transferred between genetically dissimilar members of the same species. Allografts are probably incorporated into existing bone by a process similar to that of autogenous bone grafts, but proceed more slowly as a result of the absence of living cells. In animal studies, allografts have been found to possess bone-stimulating proteins and, consequently, osteoinductive properties.<sup>18</sup> Use of any substitute graft material and the possibility of transfer of disease from donor to recipient as well as the presence and significance of immune responses to foreign antigens. Thus, bone banks accredited by responsible organizations exist for the purpose of supplying the surgeon with safe and effective bone tissue that is suitable for intended clinical application. The goals of bone banking are to preserve the physical integrity of the graft and the inductive protein, to reduce its immunogenicity, and to ensure sterility.<sup>19</sup>

**Freeze-Dried Bone Allograft (FDBA):** Freeze drying removes approximately 95% of the water from bone by a process of sublimation in a vacuum. Although freeze drying kills all cells, the morphology, solubility, and chemical integrity of the original specimen are maintained relatively intact. Freeze Dried Bone

Allograft (FDBA), but a number of synonyms exist (ground cortical, ground cancellous, freeze dried bone, etc.). Changes in particle size affects mainly handling characteristics, and many clinicians choose grafting materials on this basis.<sup>20</sup>

**Demineralized Freeze-Dried Bone Allograft (DFDBA):** Demineralized freeze-dried bone allograft (DFDBA) is nothing but freeze-dried bone allograft that is decalcified. The advantage is that, decalcification exposes the bone matrix proteins and hence induces osteogenesis. DFDBA is used because it contains bone morphogenetic protein (BMP), which induces new bone formation during the healing process.

**Xenografts:** Initially the term heterograft was used for these materials, but today they are termed as 'Xenografts' after the Greek word "xeno" which means foreign. Xenografts are surgical grafts transplanted between different species. Two sources of xenografts are commercially marketed as particulate bone replacement grafts in clinical practice bovine bone and natural coral. In order to render the animal bone non antigenic and safe for transplantation to human subjects, drastic chemical means were employed to remove the organic fraction of bone or markedly alter it. However this invariably produced an inert osseous product, which when placed in surgical defects has not been able to stimulate, even passively, new bone formation.<sup>21</sup> Recently, new processing and purification method have been utilized which make it possible to remove all organic components from a bovine bone source and leave a non-organic bone matrix in an unchanged inorganic form.

**Anorganic Bone:** Anorganic bone is a bone from which organic material is extracted by means of ethylenediamine and sterilized by autoclaving. The use of this material was encouraged because of the protracted sequestration of the graft particles and slow resorption.<sup>22</sup>

**Anorganic Bovine-Derived Bone Xenograft (BDX):** Anorganic bovine bone is the hydroxylapatite "skeleton" that retains the macroporous and microporous structure of cortical and cancellous bone remaining after chemical or low-heat extraction of the organic component. For example- A unique regenerative product is PepGen P-15®, a calcined bovine bone (1,100°C; hydroxyapatite) coated with a pentadecapeptide (P-15, a part of the sequence of collagen). In summary, bovine-derived hydroxyapatite bone replacement grafts increase the available surface area that can act as an

osteoconductive scaffold due to their porosity and have a mineral content comparable to that of human bone, allowing them to integrate with host bone.<sup>23</sup>

**Anorganic Porcine-Derived Bone Xenograft:**

A natural replicate of autologous bone, OsteoBiol Gen-Osconserves the same intimate structures (matrix and porous form) and presents a high osteoconductive activity.

**Alloplast:** Alloplastic materials are synthetic, inorganic, biocompatible, and/or bioactive bone graft substitutes, which are claimed to promote bone healing through osteoconduction. The available alloplastic materials are Plaster of Paris, polymers, calcium carbonate, and ceramics. Ceramics can be classified into resorbable (e.g., tricalcium phosphate and resorbable HA) and nonresorbable (dense HA, porous HA, and bioglass).

**Calcium Phosphate Ceramics:** Larger number of ceramics are available, the calcium phosphate type has been of particular interest because of the close chemical and crystal resemblance of some of these materials to bone mineral. Commonly used calcium phosphate ceramics for periodontal regeneration are essentially of two types: The relatively nonresorbable HA(Ca<sub>10</sub>(PO<sub>4</sub>)<sub>6</sub>(OH)<sub>2</sub>) or the resorbable tricalcium phosphates (Ca<sub>3</sub>(PO<sub>4</sub>)<sub>2</sub>).

**Hydroxyapatite:** The HA products used in periodontology are of two forms: A particulate nonresorbable ceramic form and a particulate resorbable nonceramic form. In controlled clinical studies, grafting of intrabony periodontal lesions with HA resulted in an attachment level gain of 1.1–3.3 mm which was greater as compared with nongrafted surgically debrided controls by Galgut et al. in 1992.<sup>24</sup>

**Tricalcium Phosphate:** Tricalcium phosphate has been shown to stimulate bone formation, and is comparable or in most cases superior in this regard to HA as described by Fetner et al. in 1994.<sup>25</sup> It has been shown to stimulate bone formation to a greater extent than HA, but to a much lesser extent than bioglass as described by Wilson and Low in 1992.<sup>26</sup> Cultured human fibroblasts have been demonstrated to attach readily to the surface of calcium phosphate ceramics. HA acts as an amphoteric ion exchanger. Selective accumulation of calcium and phosphate ion occurs as a consequence of the negative charges on the HA surface. This leads to the formation of more apatite and stimulates the formation

of new bone.

**Plaster of Paris:** Plaster of Paris is biocompatible and porous, thereby allowing fluid exchange, which prevents flap necrosis. Plaster of Paris resorbs completely in 1 or 2 weeks. Its usefulness in human cases has not been proven.

**Hard Tissue Replacement Polymer:** HTR polymer is a nonresorbable, microporous biocompatible composite of poly-methylmethacrylate and polyhydroxyethylmethacrylate, a resorbable polylactic acid polymer. The polymer does not produce an inflammatory or immune response in contact with bone or soft tissue as described by Yukna in 1990.<sup>27</sup>

**Bio-Active Glasses and Ceramics:** Bioglasses are composed of Si-CaO-Na<sub>2</sub>O-P<sub>2</sub>O<sub>5</sub> and are resorbable or not resorbable depending on the relative proportion of these components. When bioglasses are exposed to tissue fluids, a double layer of silica gel and calcium phosphate is formed on their surface. They have been extensively used in conjunction with medical and dental implants because they develop a layer of hydroxy-carbonate-apatite on their surface following exposure to body fluids. When used on the surface of metal implants, this layer incorporates collagen fibrils and in this way produces a mechanically strong bond between implant and the adjacent bone surface as described by Hench and West in 1996.<sup>28</sup>

**New Innovations Pepgen P-15:** It is a bone grafting material used to fill periodontal osseous defects that is composed of anorganic bovine-derived HA bone matrix combined with a synthetic cell-binding peptide.

Growth factor-enhanced matrix 21S Growth factor-enhanced matrix (GEM) 21S is a synthetic grafting system for bone and periodontal regeneration composed of a purified recombinant growth factor and a synthetic calcium phosphate matrix.

## Conclusion

The use of bone graft in the field of dentistry worldwide has shown great acceptance by the patient. Though the current technologies can be considered as mature, many developments and improvements are made to mimic the biological properties of a human closely. Different kind of materials with different property has been used from way back and till date to treat different type of defects.

**Ethical Clearance:** Taken From Subhatri Dental College Meerut.

**Source of Funding:** Self

**Conflict of Interest:** Nil

### References

- Sukumar S, Drizhal I. Bone grafts in periodontal therapy. *Acta Medica (Hradec Kralove)* 2008;51:203-7
- Liu X, Shi B, Zheng Q, Li C. Alveolar bone grafting and cleft lip and palate. *Plast Reconstr Surg* 2017;140:359–360.
- Hegedus Z. The rebuilding of the alveolar process by bone transplantation. *Dent Cosmos* 1923; 65:736.
- Nabers CL, O'leary TJ. Autogenous bone transplants in the treatment of osseous defects. *J Periodontol* 1965;36:5-14.
- Schallhorn RG, Hiatt WH, Boyce W. Iliac transplants in periodontal therapy. *J Periodontol* 1970;41:566-80
- Dubok, V.A. Bioceramics—yesterday, today, tomorrow. *Powder Metall Met Ceram.* 2000; 39: 381–394.
- Yukna RA. HTR polymer grafts in human periodontal osseous defects. I 6-month clinical results. *J Periodontol* 1990;61:633-42.
- Richardson CR, Mellonig JT, Brunsvold MA, McDonnell HT, Cochran DL. Clinical evaluation of Bio-Oss: A bovine-derived xenograft for the treatment of periodontal osseous defects in humans. *J Clin Periodontol* 1999;26:421-8
- Needleman IG, Worthington HV, Tucker RJ. Guided tissue regeneration for periodontal infra-bony defects. *Cochrane Database Syst Rev* 2006;8:724-766
- Kumar J, Jain V, Kishore S, Pal S. Journey of bone graft materials in periodontal therapy. *J Dent and Allied Sci* 2016;3:30-34.
- Mellonig JT, Bowers GM. Regenerating bone in clinical periodontics. *J Am Dent Assoc* 1990;121:497-502.
- Gerald M, Bowers. Histologic Evaluation of New Attachment Apparatus Formation in Humans Part I. *J Periodontol* 1989;60:664-674.
- Wang W, Yeung, K. Bone grafts and biomaterials substitutes for bone defect repair-A review. *Bio Mate* 2017; 2: 224–247.
- Stevenson S. Bone Grafting, *Vet Clin North Am Small Anim Pract.* 1999;29:1207-1219.
- Stevenson S, Emery S, Goldberg V. Factors Affecting Bone Graft Incorporation. *Clini Ortho* 1996;324:66-74.
- Auer J. Principles in Fracture Treatment, in Auer J (ed): *Equine Surgery.* Philadelphia W.B. Saunders 1992:812-832.
- Froum SJ, Thaler R, Scopp IW, Stahl SS. Osseous autografts. Clinical responses to bone blend or hip marrow grafts. *J Periodontol* 1975;46:515-521.
- Hallman M, Thor A. Bone substitutes and growth factors as an alternative complement to autogenous bone for grafting in implant dentistry. *J Periodontol* 2000;71:172-192.
- Grover V, Kapoor A, Malhotra R, Sachdeva S. Bone allografts-A review of safety and efficacy. *Indian J Dent Res* 2011;22:496-550.
- Carlson ER, Marx RE, Buck RE. The potential for HIV transmission through Allogenic bone: A review of risks and safety. *Oral Surg Oral Med Oral Pathol Oral Radiol Endod* 1995;80:17-23.
- Emmings, Fred G. Chemically modified osseous material for restoration of bone defects. *J Periodontol* 2000;71:385.
- Krejci, Farha CF. Osseous grafting in periodontal therapy. Part I osseous graft material. *Comp Cont Edu Dent* 1987;10:95-100.
- Krejci, C, Bissada, N, Farah C, Greenwell H. Clinical Evaluation of Porous and Nonporous Hydroxyapatite in the Treatment of Human Periodontal Bony Defects. *J Periodontol* 1987;58: 521–528.
- Galgut PN, Waite IM, Brookshaw JD, Kingston CP. A 4-year controlled clinical study into the use of a ceramic hydroxylapatite implant material for the treatment of periodontal bone defects. *J Clin Periodontol* 1992;19:570-7
- Fetner E, Martigan MS, Low SB. Periodontal repair using PerioGlas in non-human primates: Clinical and histologic observations. *Compend Contin Educ Dent* 1994;12:932-9.
- Wilson J, Low SB. Bioactive ceramics for periodontal treatment: Comparative studies in the Patus monkey. *J Appl Biomater* 1992;3:123-9.

27. Yukna RA. HTR polymer grafts in human periodontal osseous defects. I 6-month clinical results. *J Periodontol* 1990;61:633-42.
28. Hench LL, Splinter RJ, Allen WC, Greenlee TK Jr. Bonding mechanism at the interface of ceramics prosthetic materials. *J Biomed Mater Res Symp* 1972;2:117-41.



# Role of Mental Health in Understanding and Preventing Suicide

Smita Satapathy<sup>1</sup>, Madhubrata Mohanty<sup>2</sup>

<sup>1</sup>Ph.D. Research Scholar, Faculty of Legal Studies, Siksha 'O' Anusandhan, Bhubaneswar, Odisha, India,

<sup>2</sup>Associate Professor, Faculty of Legal Studies, Siksha 'O' Anusandhan, Bhubaneswar, Odisha, India

## Abstract

Suicide is an important mental health problem in our society, as it is in most of the world's developed nations. It's an affliction that robs us of some of our community's most active leaders. It is a most troubling type of mental disease to imagine, a mental disorder in which the victim's pain and fear causes him to prefer death to his misery. Suicide is widespread. Most communities have earlier treated suicide as a felony and have instituted laws to restrict the act and prosecute those who attempt it whereas the notion have changed and now individuals who try or commit suicide are frequently viewed as depressed or mentally unstable. This Covid(Corona virus) pandemic had made the situation worse because many people are taking help from professionals for the first time due to severe increase of anxiety and stress. During this lockdown period many have developed suicidal tendencies and seeking physicians' help. After the suicide of famous bollywood actor Sushant Singh Rajput many are talking about the mental health awareness. In this present paper we will analyze the problem of suicide, mental health care laws and suicide regulation and some strategies for suicide prevention.

**Keywords:** *Suicide, Mental Health, Suicide prevention.*

## Introduction

*"There are many pointless deaths but never a needless suicide. Every suicidal act is addressed to certain unfulfilled needs"* –Shneidman Edwin

Man is brought into the world free but wherever he is in chains. Suicide has been perceived as a noteworthy general medical issue. WHO recognizes that suicide is a worldwide issue influencing all countries. Suicide adversely affects the individuals who murder themselves as well as on families, networks and on society. WHO perceives that numerous deaths from suicide are incautious and require successful, exhaustive, multi pectoral reactions and national systems for avoidance.<sup>1</sup>

According to the recent report published in "*Crime in India 2018 Statistics* (National Crime Records Bureau, Ministry of Home Affairs) under the Chapter II (Suicide in India) recorded a total of 1,34,516 suicides were reported in the country during 2018 showing an increase of 3.6% in comparison to 2017 and the rate of suicides has increased by 0.3 during 2018 over 2017."<sup>2</sup> Each suicide is a personal tragedy that prematurely takes the life of an individual and has a continuing ripple effect, dramatically affecting the lives of families, friends and communities. Every year, more than 1,00,000 people commit suicide in our country. There are various causes of suicides like professional/career problems, sense of isolation, abuse, violence, family problems, mental disorders, addiction to alcohol, financial loss, chronic pain etc. NCRB collects data on suicides from police recorded suicide cases. From this it is clear that police recorded cases does not include the unreported cases and in India many suicide cases are not reported and mainly the attempted cases are reported minimal because attempt to commit suicide is still considered an offence. According to the WHO, around 8 lakhs people die of suicide every year and up to 25 times as many make a

---

### Corresponding Author:

**Dr. Madhubrata Mohanty**

Associate Professor, Faculty of Legal Studies, Siksha 'O' Anusandhan, Bhubaneswar, Odisha, India  
e-mail: madhubratamohanty@soa.ac.in

suicide attempt. And in 2018, National Crime Records Bureau provides that the average rate of suicide in India is 10.2.

Since the laws of mental health treatment have focused on mental illness/psychiatric rhetoric to describe suicide, it would be misleading to argue that suicide is medicalized in India with the passing of this Legislation. Efforts to discourage suicide in general mental health provide a more complicated definition of suicide prevention than the rules of mental health. While the national mental health policy approach to suicide prevention has been to conceptualize suicide as predominantly a health concern, it nevertheless deals with non-health, non-medical activities such as restricting pesticide exposure, or promoting 'high-risk' urban space monitoring as approaches for suicide prevention.<sup>3</sup> Transnational and national public policy programs in seeking such a strategy should not view suicide solely through the prism of mental disease. As public health programs also adopt a psychosocial approach which takes into account social, cultural and economic issues when developing interventions. Including suicide as a public health issue, prevention of suicide needed to be viewed not only as a human mental disorder but by certain systemic forms of prevention. Psychiatric policy and medicinal practice is a traditional capitalist system of control capable of ruling through the wellbeing of the communities.<sup>4</sup> The claim that in contemporary India such a change to the suicidal person's medical services is illustrative of attempts to manage the suicidal person by therapy may be made. Yet, as we have learned, the current dialogue on suicide and mental illness is just part of the picture.

**Objective:** The present article attempts to analyse the importance of the problem of suicide and the role of mental health in understanding and preventing suicide.

**The Problem of Suicide:** The importance of the problem can be measured in numbers, in value of the lives lost and in the suffering of the suicide victim and those who knew about him. Suicide is indeed a complex issue encompassing philosophical, ethical, legal and practical dilemmas. It needs open debate with due consideration to different aspects and points of view. Lack of precise measures to detect mental illness is not a sufficient reason to assume all suicides are due to abnormal mental states. It must be a drive towards developing measures that enable us to detect and exclude mental illnesses with more confidence and certainty. The subject of suicide

is painful and often an avoided area for consideration or discussion. Many feel it is a morbid issue and that talking about it may only stir up interest and perhaps increase the incidence. Attitudes towards studying, understanding and preventing suicide vary but there is an increasing concern about the problem and willingness to face it.<sup>5</sup>

In India, suicides are more of a medico-legal problem than a health or societal problem. Hence information on suicides is collected and compiled by police departments. In developing countries like India, a number of factors related to culture, family life, education, growing aspirations and inability to tolerate negative feelings contribute in a big way for suicides. Various research studies state that biological, genetic, and psychosocial risk factors for suicide may in many cases not confer risk directly, but indirectly, through lack of social support, stressful life events, depression, hopelessness and suicidal intention which ultimately increases risk for suicidal behaviour. The most promised risk factors are a prior suicide attempt and mental illness. Research indicated that 90 – 95% of people who die by suicide had at least one diagnostic mental disorder, particularly including depression, bipolar disorder, borderline personality disorder, and substance dependence or abuse.<sup>6</sup>

#### **Mental Health Care Laws and Suicide Regulation:**

Prevention of suicide within mental health care discussion is not a special thing in itself. As demonstrated, suicide avoidance and public health discourse encompasses psychiatric/biomedical, psychological, and psychosocial interventions. But, unlike the discourses that went into criminal law debates, where there were no limits on what conversation could affect a legal judgment, there are clear limitations in mental health care discussions. Initiatives for mental health care, not only psychiatric/pharmacological but also psychosocial programs, regularly concentrate clinical dialogue and specialists in their suicide prevention mandate. Discourse on mental health treatment has driven changes in suicide laws. Law reform attempts have been made to decriminalize attempted suicide, and portray all suicides as a question of mental health.<sup>7</sup>

Post-independence, there were two significant laws in India which had an effect on mental health treatment. The Mental Health Act -1987 (MHA) has given a legal protection for mentally ill people and the Persons with Disabilities (Equal Opportunities, Protection of Rights

and Full Participation) Act - 1995 (PWD) provided a basic standard of care for those with intellectual disorders, including mental illness with a disability classification. All of these legal provisions, however, faced criticism from mental health care providers, human rights activists, and disability scholars.

**Mental Health Care Bill-2013 and 2016:** The Mental Health Care Bill (MHC)-2013 is an attempt to reform Indian mental health care laws.

“With regard to the legal regulation of suicide, Section 124 of the MHC Bill-2013 states:

1. Notwithstanding anything contained in Section 309 of the IPC, any person who attempts suicide shall be presumed, unless proved otherwise, to be *suffering from ‘mental illness’ at the time of the bid and shall not be liable to punishment under the said sections.*
2. The appropriate Government shall have a duty to provide care, treatment and rehabilitation to a person, having mental illness and who attempted to commit suicide, to reduce the risk of recurrence of attempt to commit suicide”.

The bill does not amend Section 309 IPC in saying this but presumes that committing suicide is a symptom of mental illness. Under this Section 124 term, a person contemplating suicide would be spared from criminal prosecution but considered to be “mental disorder suffering.”

The 2013 MHC Bill was praised by numerous medical clinicians for portraying suicide as a mental disorder.

Firstly, they argued that this new conceptualization would benefit those people who attempt suicide because of stress; secondly, by not involving the police and instead putting them under the protection of mental health practitioners, the new bill was seen as more responsive to the needs of individuals who attempt suicide and thirdly, under the new medical framing of suicide, families where someone has attempted suicide would be more willing to report the incident since they no longer have to report to the police.<sup>8</sup>

“With regards to the implications of Section 309 IPC, Salelkar and Davar explain that, as per MHC Bill 2013, a person who attempts suicide is exempt from punishment but not prosecution. Thus, the police continue to have the authority to remand a person who

has attempted suicide into custody and produce them in front of the Magistrate. Since the law would assume that such a person is suffering from mental illness, s/he could be sent to a public mental establishment for assessment and treatment, or mandated to remain in a mental health establishment for up to ten days (Salelkar & Davar, 2013; Section 111, MHC Bill 2016).”<sup>9</sup>

**The Mental Health Care Act, 2017:** In India, the Mental Healthcare Act (MHCA) 2017 was passed on April 7, 2017 and enforced on May 29, 2018. This is “an Act to provide for mental healthcare and services for persons with mental illness (who have substantial disorder and whose functioning is grossly impaired) and to protect, promote and fulfil the rights of such mentally ill persons (who have substantial disorder and grossly impaired functioning), during delivery of mental healthcare services and for matters connected therewith or incidental thereto.”

Until now, an attempt to commit suicide was a criminal offence as per Section 309 of Indian Penal Code (IPC), 1860. It is worth remembering here that the words “mental illness,” which was used in a previous draft of the MHCA in 2013, was replaced by “severe stress,” in 2016, by the Indian Parliament in MHCA 2017 after a lot of deliberations after considering the stigma and abetment laws associated with attempted suicide.

**Section 115** of The Mental Health Care Act, 2017 specifically provides **Presumption of severe stress in case of attempt to commit suicide-**

“Notwithstanding anything contained in Section 309 of the Indian Penal Code any person who attempts to commit suicide shall be presumed, unless proved otherwise, to have severe stress and shall not be tried and punished under the said Code. The appropriate Government shall have a duty to provide care, treatment and rehabilitation to a person, having severe stress and who attempted to commit suicide, to reduce the risk of recurrence of attempt to commit suicide.”

This provision impliedly repealed Section 309, the Indian Penal Code of 1860 which penalises attempted suicide. It is submitted that the legislators have realized, though belatedly, that suicidal tendency is an aspect of mental illness, and that such a person needs treatment in mental asylum rather than prison sentence.

There is no single change from one mode of control to another in the story of suicide regulation in India.

Many life-management strategies exist in tandem. In India there coexists religion, legal (criminal and mental health laws), disability, political, cultural, caste violence among other suicide discourses. Therefore, the basis for suicide legislation does not lie exclusively within the rules of criminal justice, mental health care regulations or the debate of general mental health. However, though many discourses are at stake in debates on suicide, the debate on mental health is expanding rapidly. The campaign for mental health (from the global north as well as inside India) has described suicide as a result of mental illness, which should not then be criminalised.<sup>10</sup>

**Suicide Prevention:** With the evolving times, the issue of suicide was seen progressively like a worldwide issue and the World Health Organization has concerning attempted suicide empowers attempts for the prevention of suicide and communicated the view that rebuffing with detainment a conduct subsequent to either a psychological issue or a social trouble gives totally an off-base message to the populace. The International Association for Suicide Prevention has likewise communicated the view that attempted suicide ought to be decriminalized and that self-destructive people should be aided and detainment just aggravates their issues.<sup>11</sup> And in pursuit of their objective, the Association made September 10 as ‘World Suicide Prevention Day.’

Preventive programs should therefore be planned with a view to reducing factors which increase the probability of suicide attempts and which factors aimed at fostering resilience. Certain steps can be taken<sup>12</sup>-

- i. Effective diagnosis of psychiatric illnesses and successful treatment are highly significant.
- ii. Improved 24 x 7 Suicidehelp-lines will help people deal with difficult circumstances that cause severe distress.
- iii. Services for care and prevention should be adapted to the needs of specific age groups.
- iv. Spreading information among people about risk factors, warning signs and recovery and preventive approaches is imperative.
- v. Restricting exposure to common suicide strategies and preventing the use of extremely lethal method are without doubt necessary.
- vi. Educational and religious institutions will play a crucial role in the effective and efficient delivery of preventive programmes.

vii. To promote fair media reporting, much focus should be put on the idea that suicide is a pointless way to solve problems.

viii. High-risk people should be aimed at preventive programmes.

Individuals have no influence over the ups and downs of life, but keeping a good outlook will certainly improve the willingness to take them in action even in the face of adverse circumstances. There’s nothing more valuable than life and suicide will never fix the problem.

## Conclusion

Mental illnesses are considered to be closely linked to suicide. Diagnosed mental illnesses, particularly depression, are very common in persons attempting suicide. Similarly, drug dependence is closely related to suicide. Given ample clinical research associating treatable mental illness with suicide, the country’s access to medical services remains weak and this confuses the issue. The new Indian Mental Healthcare Act passed by the parliament suggested that attempt to commit suicide has been impliedly decriminalised. It has made the government duty bound to provide medication, diagnosis and recovery to a person who has attempted suicide because of extreme stresses. This is a welcome step and might strengthen the suicide prevention strategies which are almost nonexistent due to poor resources both in terms of trained workforce and budgetary allocations. Whereas even after the brave attempt by the Mental Health Care Act to partially decriminalize suicide in 2017, the sad statement on the nation is that decriminalization can only become absolute if Section 309 is complete deleted from Indian Penal Code, 1860. What’s needed is what Britain did in Suicide Act, 1961, the complete decriminalization of attempted suicide. Every police man today knows if you fail suicide attempt he will take you into custody under Section 309, IPC, but nobody in the police knows that there is a clause in the Mental Health Care Act 2017 that actually decriminalizes attempted suicide. Therefore, awareness of the Mental Health Care Act is the need of the hour. And there should be set up of a National Suicide Prevention Council with experts from a wide cross-section of society without much loss of further time. It is time the nation adopt a Zero Suicide India Plan.

**Ethical Clearance:** Not required, as the article is based on aspects which are doctrinally taken.

**Source of Funding:** Self

**Conflict of Interest:** Nil

### References

1. World Health Organization. Preventing Suicide: A Global Imperative. Geneva: World Health Organization. 2014.
2. National Crime Records Bureau. Accidental Deaths and Suicides in India: 2018. New Delhi, India: Ministry of Home Affairs, Government of India. 2018.
3. Bagcchi S, Chaudhuri P. Suicide and the law in India. *BMJ*. 2013; 347 (f6975). DOI:10.1136/bmj.f6975
4. Das A, Rao M. Universal mental health: Re-evaluating the call for global mental health. *CPH*. 2012; 22(4): 383-389.
5. Jacob KS. Suicide in India: Part perceptions, partial insights, and inadequate solutions. *NMJI*. 2017; 30(3): 155-158.
6. Vijayakumar L. Indian research on suicide. *IJP*. 2010; 52:S291-6.
7. Salelkar A, Davar B. Submission to the standing committee on Mental Health Care Bill of 2013 with reference to the treatment of persons who have attempted suicide. 2013, September 30. Retrieved From <http://inclusiveplanet.org.in/sites/default/files/MHC%20Bill%20Reccomendations%20to%20Standing%20Committee%20on%20Suicide.pdf>
8. Vadlamani LN, Gowda M. Practical implications of Mental Healthcare Act 2017: Suicide and suicide attempt. *IJP*. 2019; 61:S750-5.
9. All you Need to know about the New Mental Healthcare Bill. 2016. Available from: <https://www.livelaw.in/need-know-new-mental-healthcare-bill-2016>.
10. Ministry of Law and Justice. The Mental Healthcare Act; Gazette of India. 2017. Available from: <http://www.egazette.nic.in/WriteReadData/2017/175248.pdf>.
11. Gupta R, Jain N. Prevention of suicide. *IJSP*. 2017; 33:139-41.
12. Vijaykumar L. Suicide and its prevention: The urgent need in India. *IJP*. 2007; 49:81-84.

# Awareness of Adverse Effects of Lead-containing Cosmetics among the Adolescence and Young Adult Population in Chennai: A Survey

Sneha A.<sup>1</sup>, Balaji K.<sup>2</sup>, Yuvaraj Maria Francis<sup>3</sup>, Gunapriya Raghunath<sup>4</sup>

<sup>1</sup>Undergraduate Students, Saveetha Medical College and Hospital, Thandalam, Chennai, India, <sup>2</sup>Tutor, Department of Anatomy, Saveetha Medical College and Hospital, Thandalam, Chennai, India, <sup>3</sup>Assistant Professor, Department of Anatomy, Saveetha Medical College and Hospital, Thandalam, Chennai, India, <sup>4</sup>Professor & Head, Department of Anatomy, Saveetha Medical College and Hospital, Thandalam, Chennai, India

## Abstract

**Background:** Lead and its compound induced health problems are continue to be an important, preventable public health issue. The common source of lead exposure in modern days is cosmetic products.

**Aim and Objectives:** The study aims to evaluate the awareness about the adverse effects of lead-containing cosmetics in adolescence and the young adult population including factors influencing customers, knowledge about the product ingredients, and quality.

**Materials and Method:** In this study, a questionnaire was prepared using Google form and circulated among the adolescence and young adult subjects to assess the awareness about the adverse effect of lead in cosmetics. The study sample comprised of totally 203 participants of both males and females with the age group between 16 to 24 years.

**Results:** In this study, it is found that 87% of the participants were aware that cosmetic products harm their health. 78% of the participants know lead and its compounds present in the cosmetics. 86% of participants have the habit of checking the ingredients and quality of cosmetic products. About 96% of the participants were influenced by the advertisement of the product before buying it.

**Keywords:** Awareness, Adolescence, Cosmetics, Lead, and Participants.

## Introduction

Adverse effects of heavy metals are a major public health concern, particularly lead and its compounds may cause negative impacts on human health. Metals such as

lead, mercury, and cadmium in cosmetics are described as listed among the ten major chemicals of concern by the World Health Organization (WHO).<sup>1</sup> These metals are purposefully added to cosmetics, exist as impurities in cosmetics, or unknowingly added from manufacturing devices itself. Lead and its compounds occur naturally in the environment. However, most of the lead added throughout the environment by human activities such as car battery, ammunition and as a constituent of solder, alloys, and pewter. The lead in the environment had increased 1,000-fold in the past few centuries especially during the industrial revolution.<sup>2</sup> The lead has widespread industrial use, such as application in gasoline, fuel and solid waste combustion, paints, and most importantly in cosmetics. Lead compounds

---

### Corresponding Author:

**Mr. Balaji Karunakaran**

Tutor, Department of Anatomy, Saveetha Medical College & Hospital, Saveetha Institute of Medical & Technical Sciences, Thandalam, Chennai, Tamil Nadu, India 602 105

Mobile No.: 9894763124

e-mail: mevsig@gmail.com

such as lead dioxide, lead chromate, leadhydroxyl carbonate, and lead sulfide are used in colourcosmetics as pigments.<sup>3</sup> The risk of exposure to lead is high among children due to their hand to mouth activities which may cause cognitive and neurobehavioral deficits.<sup>4</sup> The lead toxicities may result in organ damage specifically bone, kidney and liver injuries, intellectual impairment, and other symptoms, such as irritability, headaches, and confusion.<sup>5</sup> The Food and Drug Administration (FDA) in the United Statesstated that 20 PPM is the maximum limit for lead in edible products. Nevertheless, leadis cumulative, and using lead-contaminated cosmetics regularly, canadd up to significant exposure levels and adversely affect humans. A significant amount of the lead body burden is confined tothe bone with a half-life of more than 20 years (WHO, 1995).<sup>6</sup> Blood lead level is increased during increased bone turnover especially during pregnancy, lactation, and menopause in women’s live.<sup>7,8</sup> Although several measures to control the lead exposure are already implemented by both government agencies and non-governmental organizations in many countries such as the use of unleaded gasoline, unleaded paint, ceramics used for storage and preparation of food and lead-free cosmetics. Lead contamination is still a major public health problem in underdeveloped and developing countries and targeted high-risk populations. Lead compounds and several other substances are prohibited ingredients in cosmetics in many countries.<sup>9</sup> Therefore, the aim of the study is to understand the level of awareness and knowledge about lead-containing cosmetics and its adverse effects among its users.

## Methodology

This cross sectional study was conducted in Saveetha Medical College during the period from November 2019 to April 2020. This cross-sectional study was to assess the awareness about the composition of cosmetics particularly about the potentially harmful substances such as lead. A survey method was adopted as a means of data collection because it provided the best possible way to assess the awareness of participants regarding the use of cosmetics. This study was conducted by using Google form to observe the cosmetic usage practices of participants through the medium of analyzing questionnaires. The survey was arranged in three sections in which the first section consisted of questions regarding the age and usage of makeup. The second section consisted of questions regarding the usage pattern of different personal care products. The third section of questions included questions regarding the

awareness and shopping patterns of the consumers. The data was collected from a sample size of 203 participants including both the gender within the age group of 16 to 24 years with proper informed consent. The data collected were compiled and analyzed using Microsoft excel 2010.

## Results

The mean age group of the study participants was 19.1 years with a standard deviation of 1.347. The majority of the participants were females 157 (77%) and males were 46 (23%).

The majority of the participants were aware of the fact that cosmetic products have harmful compounds (87%) (Fig: 1).

The eye-opener finding was that 78% of the participants have knowledge about the adverse effects of lead and its compounds present in the cosmetics (Fig: 2).

About 6% of participants did not state the frequency of cosmetic use. Of the remainder 67% reported having used cosmetics rarely, 21% used cosmetics frequently, and 6% very frequently in their life. Figure: 3 shows the frequency of the use of cosmetics by the participants. Respondents were asked if they had ever used cosmetics for the whole day, and if so how many cosmetics they used simultaneously. This question was not answered by the majority of the participants, and 56% stated that they had never been daily users. Above 27% of the participants who had been daily users at some time, the mean number of cosmetics used per day was 4 (range 1- 7).

The majority of participants 86% check the ingredients and quality of the cosmetic products, meanwhile, 11% and 3% of the participants just see the price and package respectively without seeing the quality and ingredients of the products (Fig: 4). And about 96% of the participants were influenced by the advertisement of the product before buying it.

## Discussion

The important reason for carrying out this cross-sectional study is to understand the awareness and knowledge about the adverse effects of lead-containing cosmetics. The purpose for selecting lead and its compound content in cosmetics for this study was to add weight age to the recent reports about the presence of lead in cosmetic products such as lipsticks and hair

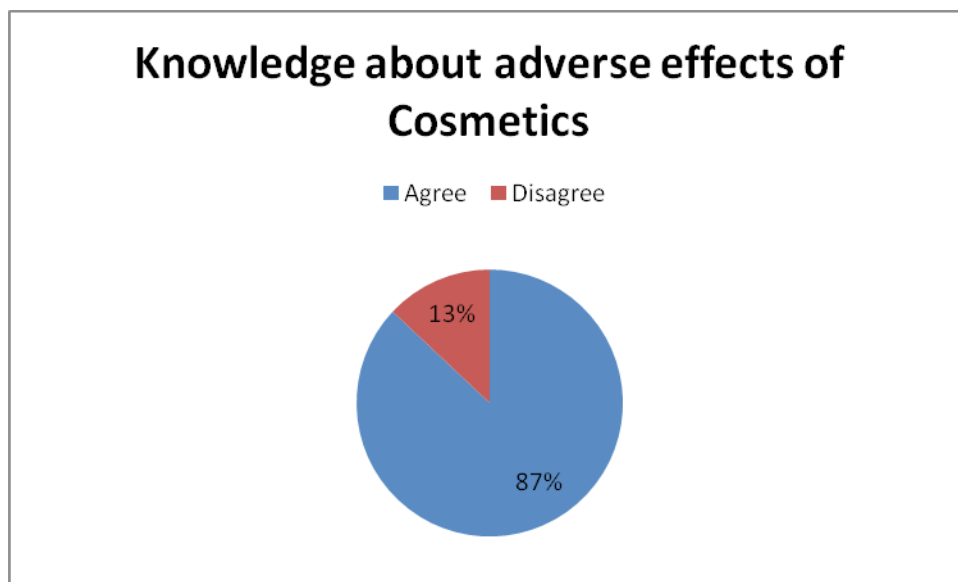
dyes and also since the potential exposure to lead may be harmful even with ordinary use. Moreover, lead proven to cause serious health problems, including poisoning, and pathological change in vital organs.<sup>10, 11</sup> The study done by Sharafi K et al stated that lead content in six tested lipstick samples was evaluated; the highest and lowest lead content was 455 mg/kg and 208 mg/kg respectively. This difference of lead content may be attributed to the difference in the quality of the raw materials used in the lipsticks.<sup>12</sup>

This survey has questions that are basic one to test the awareness of the participants about the lead-containing cosmetics including questions such as usage, knowledge of quality and ingredients, awareness about adverse health effects, and preventive measures. Similarly, study was conducted by Shiraz A, and Rahaman A reported that 88.33% of respondents used cosmetic products only once a day. 77.33% of respondents spent more than Rs.1000 per year on their expenditure on cosmetics, and the same percentage of respondents were found using multiple cosmetic items in a day.<sup>13</sup> In 2016, study done among medical students from Kerala stated that 83.75% males and 98.3% females use cosmetics, Among them, 80% preferred natural cosmetics and respondents were influenced by beauty experts (6.7%); by advertisement (12%); dermatologists (33.56%) and by the peer group (33.56%).<sup>14</sup>

A predominant number of women (84.2%) in Bolgatanga, Ghana were not aware of the adverse effects of cosmetic bleaching products. However, 60.8% do not bleach their skin and 39.2% used cosmetic bleaching products.<sup>15</sup>

The continuous use of cosmetic products contaminated with lead among the young population who already have adequate knowledge about the adverse effects of cosmetics is a major concern where extensive use of lead-containing cosmetics should be avoided until it is adequately addressed. Therefore, efforts must be made to inform the users and the general public especially the young population, pregnant and lactating women and children about the harmful consequences of cosmetic use.

In comparison with lead content from sources such as food, water, and air, continuous exposure to lead from cosmetics has been considered as a negligible source. Despite that, consistent and cumulative exposure of lead in the body for a long time, cosmetics can be considered as a substantial source of the lead.<sup>16,17</sup> Therefore, to cancel the adverse health effects of lead, cosmetics producers must use natural ingredients specifically colour additives that are lead-free.



**Figure 1: Showing knowledge about the adverse effects of Cosmetics**



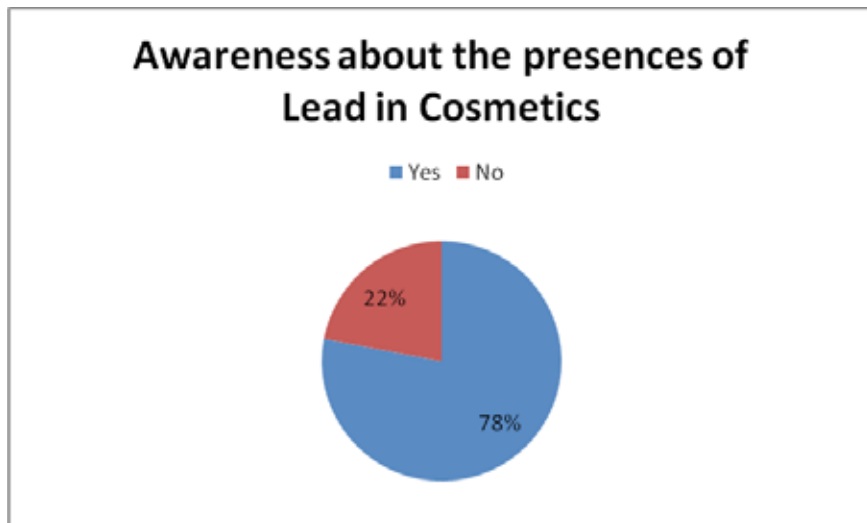


Figure 2: Showing knowledge presence of lead and its compounds in the cosmetics

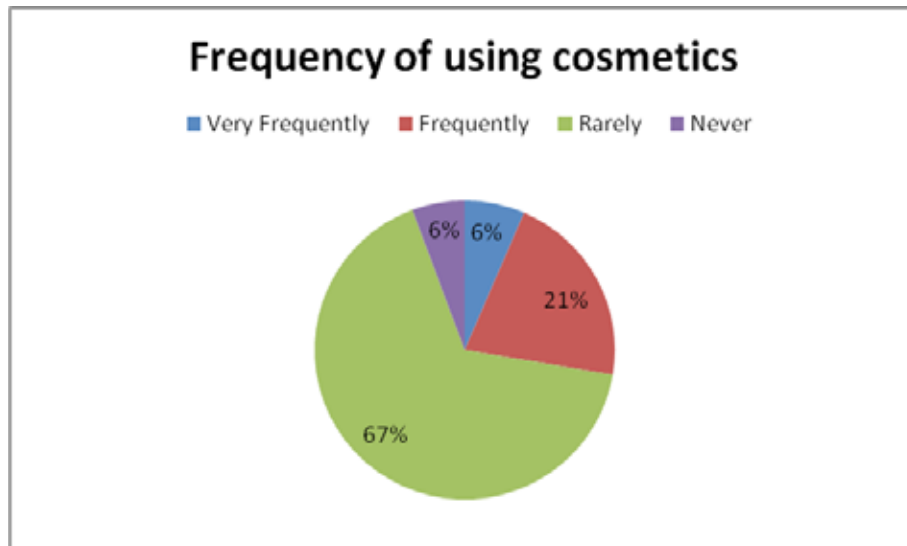


Figure 3: Showing the frequency of cosmetic use among the participants



Figure 4: Showing the factors influencing the cosmetic purchasing decision

## Conclusion

The data revealed useful information about knowledge of lead content in cosmetic products among the adolescences from Chennai. Overall, the study provided a basic understanding of the participant's attitude towards cosmetic products. Public health interventions should focus on prevention to ensure that lead containing cosmetics are not available for sale in the market or through e-commerce. The elimination of lead-containing cosmetics from stores, checking the ingredients to determine its lead level, and conducting the routine test for the safety products are the other preventive measures. Health professionals can play a major role in raising awareness through education to reduce risk.

**Acknowledgments:** The authors are thankful to all the faculties of the Department of Anatomy, Saveetha Medical College and Hospital, Saveetha Institute of Medical And Technical Sciences (SIMATS), Chennai, India, for the support and gratitude to carry out this work.

**Authors Contribution:** Sneha A made a major contribution to data collection, experimental work. Balaji Karunakaran has made involvement in experimental work and drafting the manuscript, Yuvaraj Maria Francis has made significant involvement in the interpretation of data. Gunapriya Raghunath participated in the design of the study and coordination to draft the manuscript.

**Funding:** Self-funding

**Conflicts of Interest:** The authors don't have any conflicting interests.

**Ethical Approval:** This study does not involve any human or animal testing.

## References

1. Preventing Disease through Healthy Environments, Action is needed on chemicals of major public health concern. World Health Organization, Geneva, Switzerland, 2010 [https://www.who.int/ipcs/features/10chemicals\\_en.pdf](https://www.who.int/ipcs/features/10chemicals_en.pdf)
2. Pinho S and Ladeiro B. Phytotoxicity by Lead as Heavy Metal Focus on Oxidative Stress. *Journal of Botany*, vol. 2012, Article ID 369572, 10 pages.
3. Borowska S, Brzoska MM. Metals in cosmetics: implications for human health. *J Appl Toxicol*. 2015;35:551–72.
4. Agency for Toxic Substances and Disease Registry. Toxicological profile for lead. Atlanta, GA: US Department of Health and Human Services, Agency for Toxic and Disease Registry; 2007.
5. Gidlow DA. Lead toxicity. *Occup Med*. 2015;65:348–56.
6. WHO, Environmental Health Criteria 165: Inorganic Lead, International Programme on Chemical Safety. World Health Organization, Geneva, Switzerland, 1995.
7. Gulson BL, Jameson CW, Mahaffey KR, Mizon KJ, Patison N, Law A. Relationship of lead in breast milk to lead in blood, urine, and diet of the infant and mother. *Environ Health Perspect*, 1998, 106:667–674.
8. Ettinger AS, Tellez-Rojo MM, Amarasiriwardena C, Peterson KE, Schwartz J, Aro A. Influence of maternal bone lead burden and calcium intake on levels of lead in breast milk over the course of lactation. *Am J Epidemiol* 2006, 163: 48 -56.
9. Bocca B, Pino A, Alimonti A, Forte G. Toxic metals contained in cosmetics: A status report. *Regul Toxicol Pharmacol* 2014;68:447-67
10. Shrivastava, K. and Patel, D.K. Separation and preconcentration of trace level of lead in one drop of the blood sample by using graphite furnace atomic absorption spectrometry. *J. Hazard. Mater.* 2010, 176, 414–417.
11. Koller, K., Brown, T., Spurgeon, A. and Levy, L. Recent developments in low-level lead exposure and intellectual impairment in children. *Environ. Health Perspect*. 2004, 112, 987–994.
12. Sharafi K, Fattahi N, Pirsaeed M, Yarmohamadi M and Fazlzadeh Davil M. Trace determination of lead in lipsticks and hair dyes using microwave-assisted dispersive liquid-liquid microextraction and graphite furnace atomic absorption spectrometry. *International Journal of Cosmetic Science*, 2015, 37, 489–495.
13. Shiraz A, Rahaman A. Study on Awareness about Adverse Health Effects of Cosmetics among Females of Different Age Groups. *JMSCR*, 2019;07; 11; 503-510.
14. Samson JF, Philip M, Arjun C, Varadan S. Trends in awareness and use of cosmetics among medical students – a study from a medical college in South Kerala, India. *International Journal of Contemporary Medical Research* 2017;4 (6):1415-

- 1417.
15. Richard A. Kuffour, Dartey E, Owusu W and Philip M. Dabuoh Level of Awareness of Effects of the Use of Cosmetic Bleaching Products among Women: A Case Study of Bolgatanga Municipality of Ghana. *Research on Humanities and Social Sciences*, 2014, 4; 11.
  16. Nnorom I C, Igwe J C, and Oji-Nnorom C G, Tracemetal contents of facial (make-up) cosmetics commonly used in Nigeria. *African Journal of Biotechnology*, 2005, 4; 10 1133–1138.
  17. Castro-González M I and 'endez-Armenta M M. Heavy metals: implications associated to fish consumption. *Environmental Toxicology and Pharmacology*, 2008, 26; 3; 263–271.

# Medical and Legal Constraints for Organizing 2020 Regional Head Election in the Covid-19 Pandemic in Indonesia

Sri Wahyu Ananingsih<sup>1</sup>, Ratna Dewi Pettalolo<sup>2</sup>

<sup>1</sup>Lecturer at Universitas Diponegoro, <sup>2</sup>Lecturer at Universitas Tadulako

## Abstract

In 2020, Indonesia will hold regional head elections simultaneously in 270 regions covering 9 provinces, 224 districts and 37 cities, voting on 9 December 2020. This study aims to analyse the potential for general elections in the midst of Covid-19 pandemic in Indonesia. Descriptive qualitative research method are used in which the data is obtained through interactive discussions, interviews and document searches. The results of our analysis conclude that there are 4 potential vulnerabilities in the 2020 elections, namely the availability of the budget, the readiness of election organizers, the number of alleged violations and the level of community participation. Recommendations for this study are the efforts to collaborate, coordinate and communicate well between the government and the election organizer and increase public participation.

**Keywords:** Covid-19, Election, Indonesia, medical and legal measures.

## Introduction

Covid-19 pandemic is now sweeping the world. This virus initially known in Wuhan, China. After that spread very quickly to various countries in the world, including Indonesia. The World Health Organization (WHO) establishes the Covid-19 as a world pandemic. As a result of this pandemic, Indonesia delayed regional head elections which were originally held on September 23, 2020 to December 9, 2020. Given that the pandemic has not ended yet, in the implementation of the elections a health protocol policy was implemented to break the chain of the spread of the covid-19 virus. These policies include the use of masks, hand sanitizer, the application of physical distancing, social distancing and the use of personal protective equipment.

Local elections that will be held in Indonesia are direct local elections. Inevitably the direct local election is an extension of the political participation

of the people in order to determine the figure of the regional head. Direct elections are also a form of people's sovereignty in order to be elected regional heads who have strong political legitimacy<sup>1</sup>. It is said to have strong legitimacy because candidates are elected directly by the constituents in their area. So thus the elected regional head is expected to be oriented to the welfare of the people in his area<sup>2</sup>. The decision of the Indonesian government to carry out the elections on December 9, 2020 is final, while the covid-19 pandemic is estimated not to end until the end of 2020. Given these conditions for the first time experienced by Indonesia, it is interesting to study the potential for vulnerability that occurred in the 2020 elections. With known potential vulnerability, prevention efforts can be made so that no alleged violations occur.

## Method

This study was designed as a descriptive qualitative research focusing on examining the potential for 2020 elections in the midst of the Covid-19 pandemic in Indonesia. Qualitative approach is an approach that provides an opportunity for researchers to describe and interpret research results in order to obtain a comprehensive understanding<sup>3</sup>. This research was conducted in Indonesia where as many as 270 regions consisting of 9 provinces, 224 districts, and 37 cities

---

### Corresponding Author:

**Sri Wahyu Ananingsih**

Lecturer at Faculty of Law, Diponegoro University, Jl. Prof. Soedarto, Tembalang, Semarang, Central Java 50275, Indonesia

e-mail: sriwahyuananingsih.undip@gmail.com

will carry out the elections on December 9, 2020. All qualitative data includes primary data and secondary data. Primary data obtained through interviews and interactive discussions. While other data in the form of secondary data obtained from literature studies, in the form of references from journals as well as research results and legislation related to regional head elections. All data were analyzed using descriptive method.

**Implementation of the 2020 Elections in Pandemic Covid-19:** Indonesia is not the only country to hold elections in the midst of the 19th pandemic. There are about 15 countries in the world that will also hold elections in the period June to November 2020. These countries include Mongolia, Iceland, Tanzania, Jordan, Australia, Malaysia and the United States (MDN News Magazines, Impact on elections International IDEA Stockholm, MDN News Magazine Special Edition 01/VI/2020)<sup>4</sup>. In Indonesia itself, it will simultaneously hold regional head elections (elections in 270 regions covering 9 provinces, 224 districts and 37 cities). Based on the graphic info data above, the 5 provinces that hold the most regional elections are North Sumatra Province (23 Regencies/Cities), Central Java Province (21 Regencies/Cities), East Java Province (19 Regencies/Cities), West Sumatra Province (14 Regency/City) and South Sulawesi Province (12 Regency/City).

The decision of the Indonesian government to hold elections in 2020 one of them is due to the consideration that around 200 incumbent regional heads participating in the 2020 elections (from 270 regions) will end their term of office on February 17, 2021. So if the regional head election is delayed until the year 2021, it is feared that it will disrupt the running of the regional government, especially in the 200 regions. Therefore, in 2021, the position of regional head has ended and was replaced by an tasks executor official. The official has limited authority and does not cover the authority to decide on strategic matters, aka the government decides on the implementation of the elections in 2020 despite the Covid-19 pandemic.

Considering that Indonesia has only once held a regional election in the midst of a Covid-19 pandemic, it is interesting to study the potential vulnerability that might occur in the 2020 elections. The first potential for vulnerability is the issue of budget availability. The budget for this year's elections is needed by organizers not only to finance the elections but also to meet the needs of procurement of medical devices. The problem

was that medical equipment had not been budgeted by the election organizers at that time because at the time of budgeting there was no Covid-19. An additional budget is needed for that. The fact is that most regions are no longer able to provide additional funding for the procurement of medical devices. This is due to the local government's budget allocation has been focused on financing the Covid-19 pandemic countermeasures. To overcome these conditions, efforts were made to partially provide the budget by the central government through the Indonesian State Budget and partly through restructuring the existing organizers' budgets, and some budgets have been returned to the government to support efforts to overcome the Covid-19 pandemic. As for the needs of medical devices such as masks, hand sanitizers, and soaps, specifically for areas that are prone to covid-19, face fields and personal protective equipment (PPE) are also needed.

The budget is also needed by the General Election Commission (KPU) for the costs of organizing regional head elections. An urgent budget beyond what already exists is a budget for the cost of adding to the number of polling stations. This is because the KPU reduced the capacity of the number of voters in each polling station so that the polling stations grew. Per polling stations, from a capacity of 800 people reduced to 500 people, reduction in the capacity of voters per stations in order to prevent the spread of covid-19. Due to the addition of polling stations, the number of polling station officers and supervisors has increased. In addition to the KPU, the Election Supervisory Body (Bawaslu) also requires a budget for the costs of adding supervisors.

Another budget needed by the organizer is the cost of strengthening the internet network to support smoothness at each stage of the regional head election. KPU Regulation No.5 of 2020 states that some stages can be carried out using internet information technology, although it is recognized that not all regions have easy access to the internet network, such as islands or mountainous regions such as Papua and Maluku. If it is not reached by the internet, the regional head election process must be carried out as in the regional head election in normal conditions with strict health protocols to prevent covid-19.

The readiness of the regional head election is the potential for a second vulnerability. The election of regional heads in the midst of the Covid-19 disaster is a new thing that has never happened before, even though

the organizer in carrying out its main tasks functions is required to hold on to 5 principles namely: independent, impartial, transparency, professional and sustainability (United Nation Development Program, Principles for Independent and Sustainable Electoral Management, International Standard for Electoral Management Bodies, Cairo, Egyp, 9-11 April 2012)<sup>5</sup>. Organizers are also said to be election law enforcement officers, so in the context of building an electoral law enforcement system, the effectiveness of the performance of election administrators as election law enforcement officers has an important role<sup>6</sup>.

In Covid-19 conditions, the organizer's readiness includes readiness to always maintain the health of oneself and the community. The health protocol from the government must be applied strictly. Apart from that, the provision of knowledge for the implementation of the performance of the organizers plays an important role. In this election the provision of knowledge can be done virtually through online media. Many online service provider applications can now be used such as Whats App, Zoom Meeting, Facetime, Microsoft Team and so on. This effort was made to save the budget and also to prevent the spread of covid-19.

Other organizers' readiness is in the form of providing regulations that are adjusted to the conditions of the Covid-19 pandemic. According to the International Institute for Democracy and Electoral Assistance (IDEA), free and fair elections require the availability of legal instruments governing each stage of the election<sup>7,8</sup>. In accordance with the covid-19 protocol, regulations must regulate restrictions on activities that are mass gathering/supporters. Instead, alternative method are given such as activities through online media/internet. For example, at the stage of updating voter data that began on July 6, 2020, the process of matching voter data, recapitulation and announcement of the voter list which in the previous election was carried out by face to face/physical meeting then in the 2020 elections can be done using online/online media.

Likewise, at the campaign stage carried out on September 26 to December 5, 2020. Participants in the regional head election can carry out campaign forms such as limited meetings, face-to-face/dialogue meetings, public debates, installation of campaign props, media advertisements and forms others that do not violate laws and regulations. The KPU also provides time for regional head election participants to carry out

campaigns through mass, print and electronic media from November 22 to December 5, 2020. The form of face-to-face meetings, dialogues and limited meetings has special arrangements such as place, number of campaign participants, campaign time, and compliance with government health protocol requirements.

At the stage of voting and counting, it is necessary to arrange for a representative polling place. In the provisions of Article 87 of Law No.10/2016, each polling station has a maximum voter capacity of 800 people, but because of Covid-19, the KPU rearranges the capacity of 500 voters in each polling station his. Likewise, it is also related to the facilities that need to be provided in polling stations including the provision of hand washing facilities, soap, hand sanitizers, and masks. The queuing system for voters who will use their voting rights must also be set at least 1 meter apart. In areas prone to Covid-19, organizers must be equipped with personal protective equipment in accordance with government protocol. In the recapitulation stage of vote counting, it can be done by the online media method.

With regard to the supervision of each stage of the election, it is the authority of the Bawaslu. In conducting surveillance, Bawaslu must apply health protocol standards from the government. Bawaslu's steps in preparation for the supervision of regional head elections 2020 based on Bawaslu Circular No.0298/K.Bawaslu/PM.00.00/5/2020 is to prepare for the supervision of the stages of regional head election (Election) to identify the obstacles in the implementation of elections and ensuring health protocols for election observers when conducting surveillance. Furthermore, the Bawaslu issued Bawaslu Circular Letter No.0351/K.Bawaslu/PM.00.00/6/2020 concerning the implementation of election supervision during the covid-19 pandemic. Regarding the handling of violations, Bawaslu must have a specific strategy in processing every alleged violation whether it is an administrative violation, a code of ethics or a criminal election as well as in exercising the authority to handle disputes over the election process.

The third potential vulnerability is the number of alleged violations that occurred during the regional head election. This potential vulnerability is likely to arise due to conditions affected covid-19, for example the stages that are usually carried out in physical meetings or face to face now turn to virtual. This can result in the stages not running optimally, the level of compliance of the organizers with the covid-19 protocol

and alleged violations committed by participants in the elections. Alleged violations that are expected to occur include alleged abuse of authority, vote buying, black campaigns, campaign violations on social media and also the neutrality of the civil servants. Furthermore, allegations of campaign violations on social media are expected to increase compared to the 2019 elections. This estimate arises because of restrictions on campaign activities that are mass gathering or physical gatherings. These restrictions are carried out in accordance with the recommendations of the Covid-19 health protocol from the government. Instead, campaign activities can be carried out using internet media/online. This will later encourage increased use of social media in the 2020 elections. Moreover, the cost of using social media campaigns is cheaper than campaigns using mass media<sup>9</sup>.

Regarding the alleged violation of the neutrality of the civil servants, this alleged violation has been rife since the start of the 2020 elections until now. This violation is prone to occur in areas where the incumbent regional head is running again. With his power, the incumbent head easily mobilized civil servants to support his candidacy. Meanwhile, Law No. 5 of 2014 concerning civil servants and also Gov. Reg No.42/2004 explicitly explained that civil servants must be neutral, impartial and impartial, but in practice many civil servants committed violations. Bawaslu recorded in the 2020 regional head elections there were 342 suspected cases of violation of civil servants neutrality as of June 19, 2020.

The fourth potential vulnerability is community participation. Participation in this case includes not only participation in exercising their voting rights but also actively participating in each stage of the election. For example, in the factual verification stage for individual candidate pairs, residents who support the candidate pairs are willing to be met by the verification team of the KPU, or at the voter data update stage, active citizens check and re-check whether they are registered on the voter list; residents are also expected to actively participate in conducting participatory supervision at each stage and report suspected violations.

Under normal conditions, several things that cause a low level of community participation in the elections are the distrust of the community towards the candidate pair, the disinterest with the candidate and the perceived lack of benefits from the elections<sup>10</sup>. In the covid-19 pandemic

situation there is a possible cause for the decline in the level of community participation due to the concern/fear of the danger of covid-19 transmission. For this reason, the government and election organizers must actively disseminate information to the public on the importance of community participation. Without the participation of the community, there will be no regional head election with integrity and fair. In addition to the criteria for public participation, elections with integrity and fairness must meet the criteria of equality between citizens, legal certainty, free and fair competition between election contestants, professional, impartial and independent organizing institutions, integrity of collection and vote counting and fair and timely resolution of election disputes<sup>11</sup>.

## Conclusion

Indonesia will hold a regional head election 2020 in the midst of Covid-19 pandemic. There are 270 regions holding regional elections this year, consisting of 9 provinces, 224 districts and 37 cities. The voting itself will be held on December 9, 2020. Potential vulnerability in the regional head election this time includes 4 potential namely availability of budget, readiness of election organizers, the emergence of many allegations of violations and public participation. Recommendations from this study are collaborative efforts, coordination, and communication between the government and election administrators. In addition to increasing public participation is also needed so that the election of regional heads 2020 in Indonesia is quality and fair.

**Ethical Clearance:** This research was ethically approved by Faculty of Law, Universitas Diponegoro, Semarang, Indonesia

**Funding:** The research was financially funded by Faculty of Law, Diponegoro University from the 2020 fiscal year.

**Conflict of Interests:** There are no conflict of interests

## References

1. Simamora J. Eksistensipemilukadadalamrangka-mewujudkanpemerintahandaerah yang demokratis. *Mimbar Hukum-Fakultas Hukum Universitas Gadjah Mada*. 2011;23(1):221-36..
2. Nuryanti S. Intervensipenyelenggaraanpemilukada:

- regulasi, sumberdaya dan eksekusi. *Jurnal Ilmu Sosial dan Ilmu Politik*. 2015;19(2):125-40.
3. Lincoln YS, Denzin NK, editors. *Handbook of qualitative research*. Sage; 1994.
  4. MDN News Magazines, Impact on elections International IDEA Stockholm, MDN News Magazine 1 June; 2020.
  5. United Nation Development Program, Principles for Independent and Sustainable Electoral Management, International Standard for Electoral Management Bodies, Cairo, Egypt, 9-11 April 2012.
  6. Santoso T. *Penegakan Hukum Pemilu; Praktik Pemilu 2004*. Tim Peneliti Perdalem; 2006.
  7. IDEA Internasional. *Standar-Standar Internasional Pemilihan Umum: Pedoman Peninjauan Kembali Kerangka Hukum Pemilu*. Jakarta: Internasional IDEA; 2004.
  8. Goodwin-Gill GS. *Free and Fair Election: International Standar and Practices*. The Asia Foundation; 1999.
  9. Saraswati MS. Social media and the political campaign industry in Indonesia. *Jurnal Komunikasi Ikatan Sarjana Komunikasi Indonesia*. 2018 Jun 12;3(1):51-65.
  10. Winengan W. Local Political Democratization Policy: Voter Participation in the Direct Regional Head Elections. *Jurnal Ilmu Sosial dan Ilmu Politik*. 2018 Sep 5;22(1):61-73.
  11. Surbakti R. *Pemilu Berintegritas dan Adil*. *Harian Kompas* 14; 2014.



# Correlation between Disability and Stigma on Leprosy Patient at General Public Hospital of Daha Husada Kediri

Srinalesti Mahanani<sup>1</sup>, Desi Natalia Trijayanti Idris<sup>1</sup>

<sup>1</sup>Lecturer at Kediri Baptist Hospital Health Science College, Indonesia

## Abstract

Leprosy is a disease that has a high burden in the community or called triple burden disease. Support from the family increase the confidence of individual to interact with others and building positive relationships. The purpose of this study was to explain the correlation between family social support and the prevention of disability in patients with leprosy at General Public Hospital of Daha Husada Kediri. The research design was Cross Sectional. Respondents in the study of Leprosy Patients who met the inclusion criteria at outpatient as many as 50 respondents used purposive sampling data collection techniques. The variables were disability and stigma on leprosy patients. The research instrument used a questionnaire filled out by respondents and more than 50% have moderate stigma and degree of disability in leprosy at most respondents have grade 1. Spearman Rho Test results  $\alpha < 0.005$ ,  $\rho = 0.035$ . The conclusion was that there is a relationship between disability and stigma on Leprosy Patient at General Public Hospital of Daha Husada Kediri.

**Keywords:** *Leprosy Patients, Disability, Stigma.*

## Introduction

Leprosy is called triple burden disease. Leprosy can be cured, but if not treated it can cause permanent disability<sup>1</sup>. Leprosy if not handled carefully can cause disabilities, and conditions become a barrier for leprosy patients in living a community life to meet their socioeconomic needs. It is hoped that a support system for people with leprosy will be able to provide full support in efforts to prevent disability with good family support for leprosy. Based on the pre-research at General Public Hospital of Daha Husada Kediri it was found that some respondents had level 1 and 2 disabilities.

According to Kunoli, leprosy is a chronic disease caused by bacteria that attack the skin and peripheral nerves. The cause of leprosy is the bacteria *Mycobacterium Leprae*. Leprosy can actually be prevented by early diagnosis and regular and accurate treatment with Multi-drug Therapy (MDT).<sup>2</sup> The principle of preventing defects and their aggravation is basically checking the eyes, hands and feet regularly; protect the eyes, hands and feet from physical trauma and take care of themselves.<sup>3</sup> Long leprosy sufferers will show leprosy reactions with nerve pain, weakness, some skin lesions, eye pain, or signs of systemic disease due to bacterial infiltration. attacking the respiratory mucosa,

bones, and testes. If leprosy is left untreated, it can cause skin tissue damage (skin, upper respiratory mucosal, finger bones and face) and nerve damage (causing loss of sedation/muscle weakness that is supplied by the affected nerve).

The factor related to disability in leprosy sufferers is the role of the family. This role is related to efforts to prevent disability where the patient with the support of good family members takes preventive measures. The role of the family is very important for aspects of care for family members, especially in curative efforts (treatment). Every form of family social support has four characteristics, including informative, emotional attention, instrumental assistance and assessment assistance.<sup>4</sup> The purpose of this study is to analyze the Relationship between Family Social Support and Disability Prevention for Leprosy Patients at General Public Hospital of Daha Husada Kediri.

## Method

The design of this study used a cross sectional design, a study that emphasizes the time measurement/ observation of the independent and dependent variables only once at a time. The population of leprosy patients at General Public Hospital of Daha Husada Kediri is

50 respondents. The sampling technique used in the study was purposive sampling. The dependent variable of this study is stigma, while the independent variable is disability. The research instrument used the ILEP

stigma kuesioner and the WHO measure of disability. The analysis used in conducting hypothesis testing to determine the relationship between disability and stigma in leprosy is the Spearman rho test.

## Result

**Table 1: Stigma on Leprosy Patient at General Public Hospital of Daha Husada Kediri (May-June, 2020)**

Stigma Category	f	%
Mild	0	0
Medium	4	11,43
Moderate	18	51,43
Heaviness	13	37,14
Jumlah	35	100

**Table 2: Degree of Disability on Leprosy Patient at General Public Hospital of Daha Husada Kediri (May-June, 2020)**

Degree of Disability	f	%
0	3	6,0
1	35	70,0
2	12	24,0
Jumlah	50	100

**Table 3: Correlation between Disability and Stigma on Leprosy Patient At General Public Hospital of Daha Husada Kediri (May-June, 2020)**

			Degree of Disability	Stigma
Spearman's rho	Degree of Disability	Correlation Coefficient	1.000	.299*
		Sig. (2-tailed)	.035	.035
	Stigma	Correlation Coefficient	.299*	1.000
		Sig. (2-tailed)	.035	.035
		N	50	50

The results of the Spearman's Rho statistical test using computer software, based on the level of significance set at  $\alpha < 0.005$ , the results obtained  $p = 0.035$ , it means that there is a relationship between disability and stigma in leprosy patients at General Public Hospital of Daha Husada Kediri.

## Discussion

### Prevention of Disabilities in Leprosy At General Public Hospital of Daha Husada Kediri.

Based on the results of a study of 50 respondents about the prevention of disability in leprosy at General Public Hospital of Daha Husada Kediri, the most respondents had sufficient disability prevention as many as 75% respondents

Disability is a term used to cover three aspects, namely damage to structure and function (impairment), activity limitations and problems of participation (participation problems). These three aspects are very much influenced by individual factors and environmental factors. Efforts

to prevent disability can be carried out at home, health centers or referral service units such as public hospitals or referral hospitals. Patients must understand that MDT treatment can kill leprosy germs. But defects in his eyes, hands or feet have already occurred and will remain throughout his life, so he must be able to carry out self-care regularly so that the disabilities do not get worse.<sup>5</sup>

Behavior in an effort to prevent disability and increasing disability at home is sufficient. Many things affect the prevention of patient disability, namely the patient understands the condition of his body by carrying out the 3M principle, namely, checking the eyes, hands and feet regularly, protecting the eyes, hands and feet regularly, caring for the eye, hands and feet of physical trauma, caring for oneself. It can be proven that leprosy patients in examining their eyes, hands and feet have sufficient preventive behavior. It is supported by the results of the research that most of the knowledge about leprosy in general, however, knowledge in efforts to prevent disability through regular treatment is sufficient. In addition, the current level of disability also affects the prevention of disability, the disability experienced by lepers causes leprosy patients to be careful when doing a job, therefore people with leprosy must always protect, examine and care for their eyes, hands and feet so that disability does not increase to severe.<sup>6</sup> This is evidenced by disability prevention obtained from 50 respondents, there are 5 respondents who have sufficient disability prevention behavior with a percentage (75.4%) in statement number 12, namely so that I do not get hurt while working I do not do parts that are dangerous to my hands.

Based on the results of a study of 50 respondents regarding the prevention of leprosy disabilities at General Public Hospital of Daha Husada Kediri, Kediri, more than 50% of respondents examined their eyes, hands and feet, only 69.2% respondents.

Based on the theory, how to keep your eyes in good condition when your eyes feel dry is to close your eyes as often as possible.<sup>7</sup> Often look in the mirror to see if there is a foreign object or redness in the eye. How to check the hands or feet when there are cuts or blisters can also affect the risk of deformity or increased defects. On the hands often stop and check the hands carefully for cuts or blisters, generally if the skin is Dry hands are accompanied by numbness causing muscle weakness or even paralysis. Therefore always check for possible dryness of the hands and fingers, check the hands

regularly for injuries that may occur due to using the hands with bent fingers. On the feet, routinely check the feet for any parts of the feet that have cracks and injuries. Therefore, often stop and check the feet for even minor cuts or bruises or abrasions.<sup>3</sup>

Based on the results of behavioral leprosy patient research, it is sufficient to examine the eyes, hands and feet. This is because the patient understands enough about how to regularly check his eyes, hands and feet. This is evidenced by the prevention of disability obtained from 50 respondents, there are 9 respondents who have the behavior of examining their eyes, hands and feet both with a percentage (84.1%) in statement number 8, namely when walking I avoid friction from shoes/sandals or sharp objects such as thorns, glass and wire to prevent injury to the leg. The age factor can also affect a person's health. The higher the age of a person, the bigger the person is also suffering from various diseases. The high age must be balanced with a healthy lifestyle such as routine checking of the eyes, hands and feet so that disabilities do not increase.

Based on the results of research from 50 respondents regarding the prevention of leprosy disabilities at General Public Hospital of Daha Husada Kediri, most of the respondents protect their eyes, hands and feet, only 78.8% respondents.

Protects the eyes, hands and feet from physical trauma. Provides protection to the eyes from dust and drying out the eyes. Protect your hands from objects or the environment that cause harm, for example: fire, knives, etc. Protects the skin of the hands from objects that are easy to cause injury such as: sharp objects, heat. Use tools for everyday activities that are modified for use by crooked fingers. To prevent the broken feet from getting more deformed, it is advisable to always wear shoes so that the fingers do not get tangled. Prevent dry skin by soaking feet for 20 minutes every day in plain water, rubbing the thickened area with direct rubbing stones, smearing (without drying) with coconut oil to moisture the skin. Protect your feet by wearing footwear, dividing household tasks so that other people do the dangerous parts if your feet are numb.<sup>8</sup>

Based on the results of research on leprosy patients in taking preventive measures by protecting body parts that can cause disability and increasing disability, this is because protecting the eyes and feet can reduce the risk of injury, so patients need to get education and attention

every time they exercise control in health services. This is evidenced by the prevention of disability, obtained from 50 respondents, there are 4 respondents who have good behavior in examining their eyes, hands and feet with a percentage (75.9%) in the statement about me not doing the part that is dangerous for numb feet. In addition, work also affects the prevention of protecting the eyes, hands and feet, the higher the workload, the higher the disability. This can be proven because most of the leprosy patients work as entrepreneurs, if the patient does not protect the eyes, hands and feet then the disability can occur and the disability will increase.

Based on the results of a study of 50 respondents regarding the prevention of leprosy disabilities at General Public Hospital of Daha Husada Kediri most of the respondents treated their eyes, hands and feet as many as 73.1% respondents.

Take care of the eyes, hands and feet. If they feel dry, give an eye patch at rest. If there is, no matter how small, take care and rest some of it until it heals. Soak for 20 minutes every day in water, clean thick skin (not drained) then smear with coconut oil or other oil to keep moisture. Caring often maybe every day using hands to straighten joints -Joint and prevent heavier stiffness. Take care of your semper legs so they don't get worse by sitting with your legs straight forward. Prevention of wounds if there are bruises or small abrasions, immediately treat and rest the feet until they heal, namely resting the feet. Give eye drops containing saline, if the eyes

Based on the results of the study of leprosy patients in the behavior of caring for the eyes and feet, it is sufficient to understand the things that cause disability. The consequences that occur are not done every day which can prevent disabilities and increasing disabilities in sufferers so it is very necessary to carry out preventive behavior, but patients tend not to pay attention in the act of caring for oneself. This is evidenced by the prevention of disability obtained from 50 respondents, there are 4 respondents who have good behavior in examining their eyes, hands and feet with a percentage (82.6%) in statement number 18, namely I treat numb hands by avoiding hot objects and sharp. Therefore, the treatment that leprosy patients should do is soak for 20 minutes every day in water, clean the thick skin (not dried) then smear it with coconut oil or other oil to keep moisture, straighten joints and prevent heavier stiffness.<sup>9</sup>

Correlation between Disability and Stigma in Leprosy Patients at General Public Hospital of Daha Husada Kediri

The results of statistical tests using Spearman's Rho at the level of significance set at  $\alpha \leq 0.05$  obtained results of  $\rho = 0.053$ , where  $\rho > \alpha$  which means there is a relationship between stigma and disability in leprosy patients at General Public Hospital of Daha Husada Kediri.

Based on the results of the data research, it was found that the majority of respondents experienced sufficient stigma, that is, most civil servants experienced severe stigma, namely 3 respondents or (75.0%). The results of this study are inversely proportional to research (Soedarjatmi et al., 2009) Most of the patients do not work, apart from finding it difficult to find work for leprosy patients, they are afraid if their leaders and friends know that the respondent has leprosy and the respondent is very aware that fatigue will result in a recurrence of the disease. By not working, the respondent stated that they had no income.

Leprosy has a wide impact on the lives of sufferers, from marriage, work, personal relationships, business activities to their attendance at events in the community. Most of the respondents have suffered from leprosy between 1 year and 5 years, in this long period of time the respondent must always seek medication and take medication as regularly as possible, if it is late for treatment, the respondent states that the disease will reappear. Stigma causes discrimination so that it is difficult to find accommodation and work because of the clinical manifestations that arise and the complications that occur. People also feel reluctant to live side by side with leprosy patients. Most of the leprosy patients are civil servants because civil servants can elevate a person's social status to the highest level, giving more respect from society, so if leprosy patients get stigma then their social status will decrease. One of the impacts caused by stigma is the occurrence of physical disability. Based on the results of the study, it was found that the level of disability 2 was more than 50.0% namely 60.5% respondents. Stigmatization because physical disabilities are part of the group with physical deformities so that there are visible deformities in leprosy patients.

## Conclusion

Leprosy patients at General Public Hospital of Daha Husada Kediri have moderate stigma and disability degree is grade 1. However, there is a relationship between stigma and disability on leprosy patient at General Public Hospital of Daha Husada Kediri.

For people with leprosy, they can take preventive measures for disability and increasing disability by implementing the 3M principle, checking, protecting and treating, so that disabilities do not increase and they can carry out activities so that they do not affect the fulfillment of daily needs. In addition, the need for health education to families and lepers about the importance of the role of the family in preventing disability to help the healing process for leprosy patients.<sup>10</sup>

**Acknowledgement:** We thank the Ministry of Science Research, Technology and Higher Education of Indonesia (RISTEKDIKTI RI) for Research Grants 2019 and providing 2020. We thank you to Director of Kediri Daha Husada General Public Hospital and all research respondents

**Conflict of Interest:** None to declare

**Source of Funding:** Ministry of Research and Technology/National Research and Innovation Agency Deputy for Research and Development Strengthening for Fiscal Year 2020.

**Ethical Clearance:** Ethical clearance from the Health Research Ethics Commission (KEPK) STIKES Kediri Baptis Hospital. This research has passed ethics with letter number 077/30/III/EC/KEPK-3/STIKES RSBK/2020.

## Reference

1. Nsagha, D.S., Bissek, A. C. Z., Njuanda AL. Social Stigma as an Epidemiological Determinant for Leprosy Elimination in Cameroon. *J Public Health Africa*. 2018;2.
2. Kunouli. *Asuhan Keperawatan Penyakit Tropis*. Jakarta: CV Trans Info Media; 2012.
3. Indonesia KR. *Pedoman Nasional Progam Pengendalian Penyakit Kusta*. Jakarta: Bakti Husada; 2012.
4. House. *Buku Ajar Keperawatan Keluarga: Aplikasi Teori Pada Praktik Asuhan Keperawatan Keluarga*. Jakarta: Trans Info Media; 2013.
5. Kesehatan K. *Penanggulangan Kusta*. Indonesia: Kementerian Kesehatan Republik Indonesia; 2019.
6. Wiwiek N. *Gambaran Konsep Diri Klien Kusta*. *J Ilm Kesehat*. 2013;5(2).
7. Susanto. *Perawatan Klien Kusta Di Komunitas*. Jakarta: Trans Info Media; 2013.
8. Dhelya W. *Penyakit Kusta Sebuah Prespektif Klinis*. Malang: UB Press; 2018.
9. Arianti PM. *Psycoeducative Family Therapy Mempengaruhi Pengetahuan, Dukungan Keluarga dan Stigma Kusta*. *J Ners [Internet]*. 2016;11(1). Available from: <https://www.e-journal.unair.ac.id/JNERS/article/view/1701>
10. Rahman. *Hubungan pengetahuan dan sikap masyarakat terkait kusta terhadap perlakuan diskriminasi pada pasien kusta*. *Med Respati*. 2013; 11(3).

# Recurrence Rate of Surgical Resection with Reconstruction of Plate Osteosynthesis in the Ameloblastoma Treatment

**Suha Mohammad Sami**

*Professor, Department of Maxillo Facial Surgeon, College of Dentistry, University of Kufa, Najaf, Iraq*

## Abstract

This study was conducted to treat patients with primary ameloblastoma and solid/multicystic ameloblastoma histopathologically. Twenty-seven patients with primary ameloblastoma were treated in the period between 2008 and 2019 in the Department of Oral and Maxillofacial Surgery, and these patients ranged from 16 y to 58 y old and the average age was 37 y. The number of males reached 16 individuals and the number of females 11 individuals. Twenty-two patients with solid/multicystic ameloblastoma histopathologically were treated for partial jaw excision along with the restoration of bone plate osteosynthesis and 2 cm was used to remove a surgical free margin with bone correction, and three patients with bone metastasis were treated with excision, and the marginal jaw was removed with a 1 cm free margin with a reconstructive bone structure. Patients with unicystic ameloblastoma were treated through partial removal of the lower jaw with bone structure with titanium, and 1.5 cm was used as a free margin useful for bone health. There are 3 patients out of twenty-two infected primary solid/multicystic ameloblastoma were present with cases of repeated visualization of radiation are sick after 7 y of surgery and during routine follow-up, one patient was offered during the 6 y after the operation.

**Keywords:** *Surgical resection, reconstructive plate, ameloblastoma, radioactive tumor.*

## Introduction

The odontogenic benign epithelium neoplasm behaves as a radioactive tumor that can expand but grow slowly. It is worth noting that there are several factors help in inflammation, tooth decay, nutritional deficiency, and indefinite irritation from extraction. Benign toxic epithelial neoplasms act as an expanding, but slow-growing, radioactive tumor. They occur largely in the posterior regions of the lower jaw and tend to recur again unless they are insufficiently removed. It should be made clear that ameloblastoma makes up 14% of odontogenic tumors of the mandible and maxilla<sup>[1]</sup>. Aggressive growth is nothing but a local invasion, with 70% of cases turning into malignant tumors and 2% of

them are considered tumors<sup>[2]</sup>. Many previous studies have proven that the age of these patients ranges from thirty to sixty years<sup>[3]</sup>. Also, it appears from 10% to 15% of ameloblastoma lesions that appear in childhood and form a high percentage of 25% in Asia and Africa<sup>[4]</sup>. So histology of ameloblastoma tissue is very similar to enamel organ, which forms teeth<sup>[5]</sup>. Many theories assume inflammation, shock, and tooth decay<sup>[6]</sup>. However, the reason for this stems from a lack of nutrition, unspecified irritation from extraction, or fever, which may lead to a disruption in the growth of dental bud; however, there is a great similarity between dental bud and ameloblastoma in cytokine expression<sup>[7]</sup>. Another theory centered on the morphological differentiation of ameloblasts from pre-ameloblasts, which originally came from the development of the bell stage<sup>[8]</sup>. However, the stratum intermedium will prevent the formation of ameloblasts at the bell stage<sup>[9]</sup>. However, the stellate reticulum will later dissolve to form a very fine sac of tumor nests, which later formed a larger area of cysts that would later be given ameloblastoma multicystic appearance<sup>[10]</sup>. The molecular pathogenesis of ameloblastoma occurs

---

### Corresponding Author:

**Suha Mohammad Sami**

Professor, Department of Maxillo Facial Surgeon,  
College of Dentistry, University of Kufa, Najaf, Iraq  
e-mail: suhsam202@gmail.com

due to a defect in the mitogen-activated protein kinase (MAPK) pathway<sup>[6]</sup>, BRAF, a serine- threonine protein kinase activating the MAPKERK signaling pathway has been implicated in 63% of ameloblastoma<sup>[11,12]</sup>. However, BRAF at codon 600 mutations<sup>[13]</sup> and BRAF protein mutations will later turn into neoplasm<sup>[14]</sup>. Non-MAPK signaling genes like G protein-coupled receptor, smoothed (SMO), and SHH signaling pathway in affected ameloblastoma<sup>[15]</sup>. Likewise, mutations in genetic factors and the consequent cases of differentiation and formation of teeth, which are extremely important for dental development, have been involved in the development of ameloblastoma<sup>[16]</sup>. According to the World Health Organization report centered on dental tumors, which were classified according to the biological behavior of benign and malignant ameloblastoma<sup>[7]</sup>. In each of these tumors, there is a difference in pathological anatomy and anatomical location. There is solid/multicystic ameloblastoma<sup>[17]</sup>, peripheral (or extraosseous) ameloblastoma, and unicystic ameloblastoma. As for malignant ameloblastomas, it will be divided according to the order of frequency, primary ameloblastic carcinoma<sup>[7]</sup>, metastasizing ameloblastoma (secondary peripheral ameloblastic carcinoma), and secondary intraosseous ameloblastic carcinoma. On the other hand, the traditional solid or polycystic form is approximately 91%, and this will display both follicular and plexiform types. In this context, the unicystic ameloblastoma is the second most common benign tumor, accounting for 5-15% of all types<sup>(18)</sup>. There are two types of parietal and glossy pathological tissues, which show that there are plexiform and follicular patterns<sup>[19]</sup>. It is worth noting that the diagnosis of malignant ameloblastoma is made by functional imaging that combines both PETCT, which is used to study the infiltration of soft tissues and metastasis and imperative for histopathological examination and subtype. The epithelium of ameloblastoma may arise from epithelial cell rest of Malassez, or epithelial lining of a dentigerous cyst or cells of a sheet of Hertwig's or may arise from heterotopic epithelial cells of other organs like the pituitary gland<sup>[20]</sup>. Ameloblastoma treatment may be through surgical or non-surgical type, and from the surgical point of view, this may be conservative or maybe radical surgery. But the approach to conservative surgery is enucleation and cauterization, curettage, cryotherapy, or marsupialization. This method is extremely important because it maintains tissue in its natural form and reduces facial deformation but is associated with a high recurrence rate, especially for the aggressive type<sup>[21]</sup>.

As for the frequent type of aggressive and biological treatment, it would be better if the block resection was performed with free safe margins and reconstruction of the defect by grafts<sup>[22]</sup>. Therefore, the rate of treatment and recurrence<sup>[23]</sup> in this is illustrated by clarifying what are the clinical features and aggressive histological pattern. But aggressive surgical treatment with peripheral ameloblastoma will reduce the frequency of irrespective of age<sup>[24]</sup>. The localized invasion of ameloblastoma leads to repeated treatment after recurrence, and the reason for this is due to the way the patient provides treatment early, which means that the approach to treatment is represented by the presence of different tissue variables or because of the presence of pituitary tumor cells at the site of surgery, especially in solid places, polycystic, and conventional and luminal unicystic type if treated by conservative surgery<sup>[25]</sup>. Whereas, solid/multicystic ameloblastoma and malignant ameloblastoma are much higher<sup>[26]</sup>. The main objective of this study was to study the results of repeated ameloblastoma treatment by surgical resection *en bloc* tumor with wide bone margin and the use of bone reconstructive plate osteosynthesis.

Data collected to serve the study goals includes sex, age, clinical findings, the progression of the tumor, abnormalities of the face and jaw, imaging findings to detect extension of lesion, management, histopathological pattern, clearance of surgical margins, length of follow-up, and time to recurrence. While the patients were diagnosed through a histopathological examination, this was based on what the World Health Organization attached to the tissue type. The treatment is the partial excision of the procedure with a free safety margin because of the high probability of regional invasion. It must be clarified and indicated that the bone margin represents the distance from the radiographic margin, which is expected to be free of diseases and tumors to conduct bone operations. Often, the healthy mucosa covering the cortical hole is removed as a margin. The bone margin is 10-15 mm for benign unicystic ameloblastoma and 15-20 mm for solid/multicystic type and resection with marginal amandiblactomy for peripheral ameloblastoma, with bony defect reconstructions through reconstructive bony plate osteosynthesis<sup>[27]</sup>.

## Results

The results of this study showed that the number of male patients was 16, and they constituted 59.3% of the total patients were in this study. The number of female

patients was 11, which constituted 40.7% of the total number of patients in this study. As for the age of the patients in this study, which ranged from 16 to 58 years, but the majority of the ages were between 30 and 39 years, which constituted 44.5% (Table 1). Twenty-two patients were histopathologically treated by partial resection of the lower jaw, along with the completion of the restorative bone-building process. This purpose of

about 2 cm was used to remove a surgical free margin with bone correction. Three patients had an extraosseous type of ameloblastoma and those were treated by soft tissue excision and marginal mandibular resection were treated with a portion of the free margin equivalent to 1 cm of muscle with the bone, with reconstructive bone plate osteosynthesis, besides that it applying a bone repair process (Figure 1a-f).



**Figure 1: (a) Extraoral swelling. (b) Intraoral tumor. (c) Axial CT. (d) Mandibular segmental resection. (e) Performed reconstructive plate. (f) Postoperatively**

The results showed that two patients had unicystic ameloblastoma and were treated by segmental resection of the mandible with titanium reconstructive bone plate

osteosynthesis; thus, 1.5 cm was used as a margin with some health of bone (Table 2).

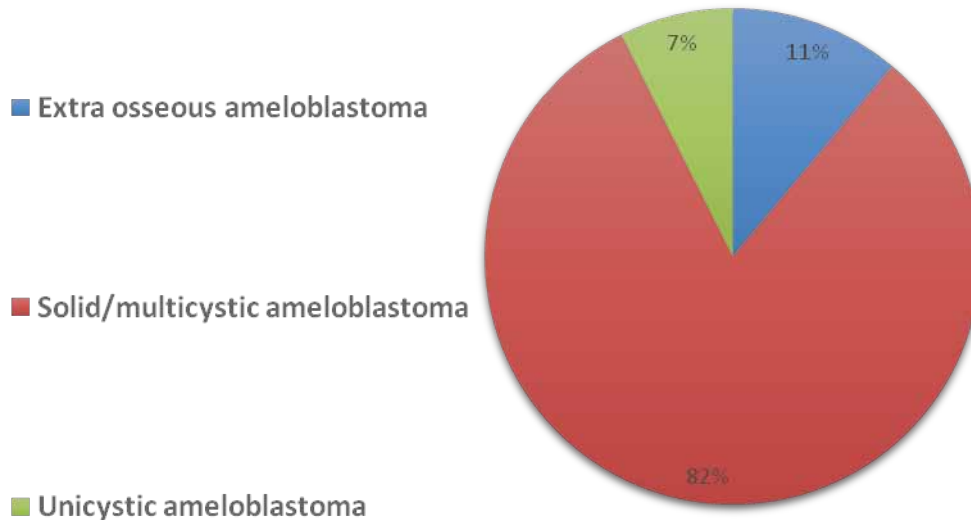
**Table 2: Distribution of ameloblastoma and type of surgery with a recurrence rate**

Type of ameloblastoma	No. of Patients	Type of Surgery	Free Margin (cm)	Recurrence Rate
Extra osseous ameloblastoma	3	Marginal mandibulectomy Resection of soft tissues.	1	1
Solid/multicystic ameloblastoma	22	Segmental resection+ titanium Reconstructive bone plate.	2	3
Unicystic ameloblastoma	2	Segmental resection+ titanium Reconstructive bone plate	1.5	0
<b>Total</b>	<b>27</b>			<b>4</b>



The patients were present in this study were monitored regularly by ten-eleven years clinically and radiographically to detect recurrence. The results of the study revealed that three of the patients complained of

the repetition of ameloblastoma type solid/multicystic radiographically, but there was one patient appeared in the frequency of radiography whose primary type was an extraosseous type of ameloblastoma (Figure 2).



**Figure 2: Ameloblastoma vs. number of patients**

Two patients received surgery during routine follow-up after seven years, and there is one patient came six years after the operation. Also, there was one patient suffered from primary peripheral ameloblastoma (extraosseous) after nine years of surgery, and that there were four patients were presented with twenty-seven were operated as primary ameloblastoma, the recurrence rate was (14.8%).

## Discussion

Admantinoma is considered a dental polyp, and this is what Ivory and Churchill called what is known as ameloblastoma<sup>[28]</sup>. As for the results that have to do with the age group, according to what was mentioned in this study, the average age ranged 30-39 years. This is in line with Fatemah Faras *et al.* (2017) study, which stated that the average age was 20-40 years, while the age group that was present in Andrew (2015)<sup>[27]</sup> study ranged 30-60 years, i.e. ameloblastoma It was introduced during the third and fourth decades of life<sup>[17]</sup>. In this study, radical surgery was addressed with appropriate margins, so that twenty-two patients with solid/multicystic ameloblastoma were treated through partial removal of the lower jaw with the completion of the restoration and bone-building process, as 2 cm was used as an important surgical free margin to maintain bone health. Three patients were suffering from an extraosseous type of

ameloblastoma, and those treated with resection of soft tissues and marginal mandibulectomy with a 1 cm free margin part of the muscle that communicated with the lesion was removed with the bone, with reconstructive bone plate osteosynthesis was applied. Likewise, the results of the study showed that there are two patients with unicystic ameloblastoma were treated by segmental resection of the mandible with titanium reconstructive bone plate osteosynthesis so that 1.5 cm was used as an important margin for dental health.

## Conclusions

The treatment depends on several factors, the most important of which is the aggressiveness of the tumor, duration, extent, size, histopathological type, and radiographically appearance, especially if the radiation is multi-site while maintaining an indefinite margin. As for the recurrence of occurrence, it depends on the age of the patient, anatomical site, molecular histopathology, genetic mutation, and/or density of bone, which is the main barrier to the repetition of the local area, so aggressive surgery is a good indicator of removing the tumor. Also, the frequency is affected by the type of molecular etiological cause, how early patients receive treatment, and type of surgery affected the recurrence rate of ameloblastoma.

**Ethical Clearance:** This study was approved by the Ethics Committee, University of Kufa. The study protocol was thoroughly explained for using samples of patients and written informed consents were obtained from them prior to participation in the study. This investigation was done according to the principals of the Declaration of Helsinki. All patients were informed about the aims and protocol of the study.

**Source of Funding:** By Self

**Conflict of Interest:** Nil

### References

- Oginni FO, Stoelinga PJ, Ajike SA, Obuekwe ON, Olokun BA, Adebola RA, et al. A prospective epidemiological study on odontogenic tumours in a black African population, with emphasis on the relative frequency of ameloblastoma. *Oral Maxillofac Surg* 2015;44(9):1099-105.
- DeVilliers P, Suggs C, Simmons D, Murrah V, Wright JT. Microgenomics of ameloblastoma. *Dent Resear* 2011;90(4):463-9.
- Oomens MA, Van der Waal I. Epidemiology of ameloblastomas of the jaws; a report from the Netherlands. *Medic Oral, Patol Oral Y Cirug Buca* 2014;19(6):e581.
- Bansal S, Desai RS, Shirsat P, Prasad P, Karjodkar F, Andrade N. The occurrence and pattern of ameloblastoma in children and adolescents: An Indian institutional study of 41 years and review of the literature. *Oral Maxillofac Surg.* 2015;44(6):725-31.
- Bassey GO, Osunde OD, Anyanechi CE. Maxillofacial tumors and tumor-like lesions in a Nigerian teaching hospital: an eleven-year retrospective analysis. *AfricHeal Scie.* 2014;14(1):56-63.
- Brown NA, Betz BL. Ameloblastoma: a review of recent molecular pathogenetic discoveries. *BiomarkCanc* 2015;7:BIC-S29329.
- Sciubba JJ, Eversole LR, Slootweg PJ. Odontogenic tumours. In: Barnes L, Eveson JW, Reichart P, Sidransky D, eds. *World Health Organization classification head and neck tumours.* 2005, IARC Press: Lyon: p. 283–328.
- Fan K, Andrews BT, Tabit CJ, Bradley JP. The Sarnat studies in craniofacial biology. *Craniofac Surg* 2012;23(1):37-43.
- Jussila M, Thesleff I. Signaling networks regulating tooth organogenesis and regeneration, and the specification of dental mesenchymal and epithelial cell lineages. *Cold Spring Harbor, Perspect Biol* 2012;4(4): a008425.
- Gupta N, Saxena S, Rathod VC, Aggarwal P. Unicystic ameloblastoma of the mandible. *Oral Maxillofac Pathol* 2011;15(2):228.
- Kurppa KJ, Catón J, Morgan PR, Ristimäki A, Ruhin B, Kellokoski J, Elenius K, Heikinheimo K. High frequency of BRAF V600E mutations in ameloblastoma. *Pathol* 2014;232(5):492-8.
- Sweeney RT, McClary AC, Myers BR, Biscocho J, Neahring L, Kwei KA, Qu K, Gong X, Ng T, Jones CD, Varma S. Identification of recurrent SMO and BRAF mutations in ameloblastomas. *Natu Genet* 2014;46(7):722-5.
- Fregnani ER, Perez DE, Paes de Almeida O, Fonseca FP, Soares FA, Castro-Junior G, Alves FA. BRAF-V600E expression correlates with ameloblastoma aggressiveness. *Histopath* 2017;70(3):473-84.
- Niault TS, Baccarini M. Targets of Raf in tumorigenesis. *Carcinog* 2010;31(7):1165-74.
- Mishra P, Panda A, Bandyopadhyay A, Kumar H, Mohiddin G. Sonic hedgehog signalling pathway and ameloblastoma—a review. *Clinic DiagnoResea* 2015;9(11): ZE10.
- Heikinheimo K, Jee KJ, Niini T, Aalto Y, Happonen RP, Leivo I, Knuutila S. Gene expression profiling of ameloblastoma and human tooth germ by means of a cDNA microarray. *Dent Resear.* 2002;81(8):525-30.
- Dias LF, de Araujo Vian RL, Nunes PM, Magalhaes HE, do Carmo CD, Passos EC, Neves LR. Major considerations on the clinical, epidemiological, histopathological and therapeutic aspects of ameloblastomas: a systematic review. *HealtScie* 2019;13(3).
- Dhanuthai K, Chantarangsu S, Rojanawatsirivej S, Phattararatip E, Darling M, Jackson-Boeters L, Said-Al-Naief N, Shin HI, An CH, Hong NT, An PH. Ameloblastoma: a multicentric study. *Oral Surg Oral Med Oral Path Oral Radio* 2012;113(6):782-8.
- Wright JM, Odell EW, Speight PM, Takata T. Odontogenic tumors, WHO 2005: where do we go from here? *Head and neck pathology* 2014;8(4):373-82.

20. Ritchie AC. Boyd's textbook of pathology. Lea and Febiger; 1990.
21. Dandriyal R, Gupta A, Pant S, Baweja HH. Surgical management of ameloblastoma: Conservative or radical approach. *Natiomaxillof surg* 2011;2(1):22.
22. Shen YF, Rodriguez ED, Wei FC, Tsai CY, Chang YM. Aesthetic and functional mandibular reconstruction with immediate dental implants in a free fibular flap and a low-profile reconstruction plate: five-year follow-up. *Annal Plast Surg* 2015;74(4):442-6.
23. Huang IY, Lai ST, Chen CH, Chen CM, Wu CW, Shen YH. Surgical management of ameloblastoma in children. *Oral Surgery, Oral MedOral Pathol Oral RadiolEndod* 2007;104(4):478-85.
24. Hertog D, Schulten EA, Leemans CR, Winters HA, Van der Waal I. Management of recurrent ameloblastoma of the jaws; a 40-year single institution experience. *Oral Oncol* 2011; 47(2):145-6.
25. Antonoglou GN, Sándor GK. Recurrence rates of intraosseous ameloblastomas of the jaws: a systematic review of conservative versus aggressive treatment approaches and meta-analysis of non-randomized studies. *Journal of Cranio-Maxillofacial Surgery*. 2015;43(1):149-57.
26. Zhang B, Zhang J, Huang HZ, Xu ZY, Xie HL. Expression and role of metalloproteinase-2 and endogenous tissue regulator in ameloblastoma. *Oral Pathol Medic* 2010;39(3):219-22.
27. McClary AC, West RB, McClary AC, Pollack JR, Fischbein NJ, Holsinger CF, Sunwoo J, Colevas AD, Sirjani D. Ameloblastoma: a clinical review and trends in management. *Europ Arch Oto-Rhino-Laryng* 2016;273(7):1649-61.
28. Hariram SM, Malkunje LR, Singh N, Das S, Mehta G. Ameloblastoma of the anterior mandible. *NatiMaxillof Surg* 2014;5(1):47.

# Older People with Urinary Incontinence: A Nurse Practitioner' Role in the Assessment and Management

**Supichaya Wangpitipanit**

*Lecturer, Ramathibodi School of Nursing, Faculty of Medicine Ramathibodi Hospital,  
Mahidol University, Bangkok, Thailand*

## Abstract

Urinary incontinence is a common problem symptom of urination, an inability to control the urinary excretion on its own, causing a loss of the ability to control urination. Most often, this happens in situations where urination is not ready and accidentally slips out. The symptoms will cause hygiene problems, such as a wound rash, or red marks on the wrong skin until the subsequent infection problem is also a problem for physical health, impacting the mind, economy, and society. It is a health problem that affects physical, mental, emotional, and social aspects lead to reduced quality of life. Older people with urinary incontinence problems, it is caused by several reasons and factors that can cause various issues. This article aims to describe urinary excretion mechanisms, meaning, types and effects, method for assessing urinary incontinence, and primary care guidelines for the older people and their families providing home and hospital care. Therefore, nurse practitioners' action plays a significant role in helping older people with urinary incontinence. It is a service through four dimensions: prevention, medical treatment, and nursing care, health promotion, and rehabilitation. Furthermore, medical history taking by interviews, physical examination, and self-assessment those are the service nurse roles: health care provider, health educator, counselor, coordinator, and advocator in the follow-up and contact for improving caring to receive quality care and reasonable to continue to bring an as good quality of life.

**Keywords:** *Assessment, management, nurse practitioner, older people, role, urinary incontinence.*

## Introduction

Urinary Incontinence (UI) is one of the symptoms of geriatrics syndrome, more common in older people. It is a symptom of urination and unable to control urination on their own. It is a loss of the ability to control urine flow. Often this happens in situations where urination is not ready, and it slips off.<sup>1,2,3</sup> The excretion system is a normal process to get rid of the parts that the body does not want, maintain the balance in the body, and prevent toxins from the residue of these waste. The mechanism of urinary excretion each time, it is caused by the

interaction of the central nervous system from the brain and spinal cord with the peripheral nervous system.<sup>4,5</sup> It consists of a sympathetic or hypogastric nerve (T11-L2) and parasympathetic or pelvic nerve (S2-4). It sends nerve impulses to regulate the bladder muscles to control the external urethral sphincter to be ready to urinate. When the bladder receives approximately 150-200ml of water in the urine, more pressure is generated in the bladder, the lower bladder nerve endings are stimulated and sent through the spinal cord, an afferent impulse directed to the micturition center to interpret the sensation of urinary pain. If in a place not ready to urinate, the brain sends signals from the basal ganglia and frontal lobe to restrain the bladder muscles from contracting, allowing them to continue urination. When living in the bathroom or the right place, the midbrain's urinary control center orders an efferent impulse to the bladder to compress along with the sphincter of the urethra. Each urination is approximately four to eight times a day without incontinence.<sup>4,5</sup>

---

### Corresponding Author:

**Supichaya Wangpitipanit**

Lecturer, Ramathibodi School of Nursing, Faculty of Medicine Ramathibodi Hospital, Mahidol University, Bangkok, Thailand

e-mail: supichaya.wan@mahidol.ac.th

Research reviews presents the situations older people with urinary incontinence. The prevalence was 15-30% in the nursing home but in home bound requiring long-term care of the older people found in as much as 60-70%. We met that older age would affect deterioration. The severity of urinary incontinence symptoms, mainly aged 80 and over were more likely to have signs and the severity of urinary incontinence problems.<sup>2,3,4</sup> Female was twice as common as males. Most will occur the amount of urine emit 200-500ml to up to 1,000ml per day.<sup>2,3,4</sup> Older people with urinary incontinence symptoms will cause hygiene problems, such as a wound rash, or red marks on the wrong skin until the subsequent infection problem is also a problem for physical health, impacting the mind, economy, and society, and are significant and affect to the self-care ability. The nurse practitioner should be aware of the importance of urinary incontinence problems and make appropriate nursing plans to deal with issues that occur and ultimately reduces the impact that will appear to have a better quality of life and other topics for both family and community.

### Material and Method

An integrative review is the most comprehensive approach of study have a wide range of purposes, such as the definition of urinary incontinence, type of urinary incontinence, risk factors for urinary incontinence, evaluation of urinary incontinence, and management and interventions. For that, the PICO strategy was considered the most appropriate model for developing the review question, confirming that the question's relevant components were well defined.<sup>6</sup> Thus, following the PICO strategy, was: (P) older people with urinary incontinence and their family caregivers; (I) intervention, management, and treatment; (C) non-exclusive operation and (O) nursing practitioners' role. The starting point that outlined the inclusion criteria: studies in which the reported outcome was nurse practitioners with healthcare roles. All articles published between January of 2006 and July of 2020, written in English that did not fall under these criteria, including only review articles. Therefore, this article is interested in reviewing related documents to the content of older people with urinary incontinence, guidelines for symptom assessment, management, and nursing in nursing practitioners' role for the caretaking of the older people.

### Findings:

**Urinary Incontinence:** Definition "urinary" refers to urine or to the parts of the body that produce and carry urine, and wording "incontinence" is the lack of ability to control or inability to control the excretion of urine or the contents of the bowels.<sup>7</sup> Older people with urinary incontinence had caused a loss of the ability to control the urination; urine leakage poured out came by accident, a malfunction of the bladder to the urethra in the urinary system. Therefore, urinary incontinence refers to symptoms and the inability to control urination on their own. The subsequent physical effects are skin infections, incontinence associated dermatitis, urinary tract infection, and sepsis. The fluid in the urine that frequently flows on the skin, resulting in redness and dermatitis for skin with moisture that cannot control excretion. The contact of human skin is weakly acidic. Still urine and feces are alkaline when the acidic skin is in contact with urine just 5-15 minutes. It rubbed on clothing or pads will irritate the skin, loss of moisture destroying the skin layer orphaned to the dermis, seen as a red rash around the perineal and groin and coccyx where the skin is peeling and bruises easily. As a result, microorganisms grow as a cause of odors. There is a chance of infection from bacteria and fungi.<sup>2,5,8</sup>

**Type of urinary incontinence:** It can be temporary as transient incontinence cured once the cause has resolved, or a permanent solution must be with urinary incontinence at all times. Must bring constant medical care; symptoms of urinary incontinence can be categorized in five categories<sup>2,3,4,8</sup> as follows:

1. Stress Incontinence is a cough and sneezes caused by increased intra-abdominal pressure will stimulate the control of urinary incontinence.
2. Urge Incontinence is an overactive compression of the bladder as detrusor overactivity. It is symptomatic when a rushed situation caused the urge to urinate too quickly, unable to hold it in time to go to the toilet.
3. Mixed Incontinence is a cough and sneeze that causes increased intra-abdominal pressure along with overactive bladder compression.
4. Overflow Incontinence is an excess flow of urine, causing the urine to flow and unable to hold the urine.

5. Functional Incontinence is as urinary incontinence coexists with pathological problems such as spinal cord injury, or diseases related to the spinal cord.

**Risk factors for urinary incontinence:** The primary cause factorsto risk factors areelements in the deterioration of the body. The genital area’s work decreased bladder contractions urine changes during the day, the active sphincter decreases, and reduced bladder capacity, or from an abnormality in the bladder area, have any underlying disease affecting urinary incontinence, a chronicillness,comorbidity, including diabetes mellitus, high blood pressure, dementia, confusion, or disease with brain disorders, the spinal cord nervous system, etc., heavier or constipation, or chronic constipation, having surgery on the pelvic floor organ, being older than 40 years, multiple vaginal births, eating caffeinated beverages, drinking more water, drink alcohol. changes at home environment, there is an obstacle makes going to the bathroom uncomfortableor other factors that increase urination, and getting drugs related urinary incontinence as diuretics reduce blood pressure, or drugs that may affect urinary incontinence in different groups, and focusing on their rational drug used as follows:  $\alpha$ -Adrenergic agonists (M),  $\alpha$ -Adrenergic blockers (W), ACE Inhibitors, Anticholinergics, Antipsychotics, Calcium channel blockers, Cholinesterase inhibitors, Estrogen (oral), GABAergic agents, Loop diuretics, Narcotic analgesic, NSAIDs, Sedative hypnotics, Thiazolidinediones, and Tricyclic antidepressants.<sup>3,5</sup>

**Evaluation of urinary incontinence:** The strategies assessing urinary incontinence are available at different levels, depending on the cause and severity of the symptoms. If symptoms are severe, they would like to evaluate and deliver hospitalized treatment from a urologist.<sup>3,5</sup>The critical evaluation principles areas follows:

1. Medical history taking: focused on the main symptoms, a current history of illness, past illness or lifestyle the ability to perform routine tasks based on history taking principles that enable the ability to memorize a history taking approach using the law of memorization “OLD CARTS”as mnemonicswith the eight dimensions of a medical problem recalled using (Onset, Location/radiation, Duration, Character, Aggravating factors, Reliving factors, Timing and Severity)as (1) Onset: The period onset of sudden onset or gradually. (2) Location/radiation: What part of the body does

the symptom occur? (3) Duration: How long do symptoms persist all the time, or how long does it take? (4) Character:Symptomsdescribe as feelings. (5) Aggravating factors: factors that trigger symptoms even more. (6) Reliving factors: Factors that cause symptoms to improve or disappear. (7) Timing/treatment: Primary behavioral treatment or management, and (8) Severity: The follow of feeling for older people with urinary incontinence.

2. Physical examination:the examination will focus on both visual and palpation by look for abnormalities, abdomen, pubic, bulging and palpation of the pubic area, look at full capacity urinary incontinence, and a neurological test for perineal and rectal sphincter called the “Bulbocavernosus reflex” by evaluation of spinal cord function responses, or to assess the stoppage of the spinal cord (spinal shock) at S2-S4 position. The examiner inserts a finger into the patient’s rectum, then squeezes the head of the penis or stimulates the female clitoris if found. The anusconstricted around the fingers. Show that the test gave a positive result, or have a reaction.<sup>3,5,10</sup>
3. Laboratory test: It is composed of urine tests; urine analysisis a physical examination,color, clarity, specific gravity, the potential of hydrogen ion, and the excretion is compounds such as urobilinogen protein, glucose, ketones, nitrite, or evaluated for infection, and etc. The collected urine for testing is recommends to collect by clean-voided midstream urine method before, the genital area should be washed with soap and water thoroughly, and collect urine in the middle with aseptic technique.<sup>3,5,10</sup>
4. Initial examinations to assess symptoms of urinary incontinence at the lower urinary system including: A bladder diary is to recordfrequency pad test use pads from sanitary napkins or diapers.
5. Specific examinations are to procedure-specific tests performed referred to a urologist<sup>3,5,10</sup> such as (1) Urodynamicstesting is a urodynamic examination to determine the function of the bladder and sphincter. Measuring the pressure in the bladder while water flows in and out of the bladder with urinary retention capacity. (2) Uroflowmetry is a urine flow measurement to demonstrate bladder outlet obstruction,measure the amount, time spent, and urine output rate to determine bladder function while urinating. (3) Pressure Flow Study examines the relationship between the voiding pressure study

of bladder pressure while urinating and the flow rate of urine. (4) Urethral Pressure Profilometry (UPP) is a test for pressure in the urethra. Using to measure the ability of the urethral sphincter, and measure the pressure in the urethra to view urethra activity using a catheter with a pressure sensor inside the urethra. (5) Imaging is an x-ray, ultrasound, special diagnostic examination using computer tomography, and magnetic resonance imaging (MRI). (6) Cystoscopy is a bladder endoscopy that looks at the appearance of the urethra and the lining inside the bladder for diagnosis, monitoring, and treatment. (7) Electromyography (EMG) is an electrode of the pelvic muscles and nerves. The EMG has a small sensor to place close to the anus to examine the muscle and sphincter activity while water is inserted and emptied from the bladder, and (8) Post Void Residual (PVR) is a urine count test to check the amount of residual urine from urination. The remaining urine should not exceed 50 ml. If the measurement exceeds 200 ml, it is abnormal. It is measured after the patient has emptied immediately or not more than 10 minutes; people should urinate at least 80% of the bladder capacity.

### Discussion

From the reviews, data present that the essential managements are a urine pad, adult diaper, behavior modifications, drinking water in amounts adequate, avoid caffeinated drinking beverages, weight control, prevention of constipation, and practice urinating by extending the time to urinate. The focus on pelvic floor muscle training will affect the practice of daily activities necessary to undergo diagnosis for treatment such as getting medicine, using a vaginal pessary, and vaginal surgery, until insertion of a temporary urinary catheter or urinary catheter. Livelihoods and affect the quality of life that deteriorates, nurses must use a nursing process as follows: assessment, nursing diagnostic, problem planning, activities, and evaluation along with providing nursing care according to problems and needs promote knowledge of self-care enhance and practice the skills necessary for rehabilitation to prevent more complications and affect the quality of life in the future.<sup>5,12</sup> The main problem of older people with urinary incontinence is to contact the urine that frequently flows on the skin, causing redness and inflammation of the skin as incontinence associated dermatitis. Therefore, we should focus on three key areas: cleanliness, hydration, and protect injury from skin touching the edges of pants,

always underwear that is dry and clean. There are no diaper folds or pads from prolonged sleep abrasions evaluation at the perineal skin, groin, and coccyx, abrasions, redness, flaky patches, or pain. we should consult a medical professional, clean the reproductive tract properly and regularly every time to a urination. It is best to use a drug or apply a wide range of non-alcoholic with skin coatings and injuries, and always consult a medical professional.

For the older people who have symptoms of urinary incontinence who have no cognitive problems, and remembering movements by symptoms to mild urinary incontinence, such as incontinence, coughing, sneezing, or failing to go to the toilet slips less often than 1-2 times a week. Behavioral therapy can help initially slow down the severity of symptoms, including bladder training, urge to urinate at scheduled times, such as every 2 hours, every 3 hours, or every 4 hours from prompt voiding, and have been accessible since the past until present, the pelvic floor muscle exercise, or kegel exercise. The beginning focuses on the location where we urinate, strain, and relax by tense, count 1-2-3-4-5 and release, start over, count 1-2-3-4-5, and freedom. If you can train longer, increase the number—1-2-3-4-5-6-7-8-9-10 and version, practice at least 100-200 times a day, 3-4 times a week. There is training that makes the ability to hold urine and control urination better. Also, exercises using biofeedback electrical stimulation from EMG-Biofeedback help us train the pelvic floor muscles more clearly.<sup>5,12,13</sup>

#### **Nurse practitioner with roles in healthcare:**

Nurses are a person who helps human beings, helping in usual get well, or when sick, improve care for health promotion, primary medical care and uncomplicated treatment, disease prevention, and rehabilitation of patients with problems and needs of care. They should caregiving cover both at home or community based, and in the hospital-based.<sup>5,12,13</sup> as follows:

1. The health care provider is to provide assistance or take any action to benefit the service recipient. To address health problems of the service organization focuses on applying nursing processes covering four dimensions; health promotion, disease prevention, primary medical care, and rehabilitation of individuals, families, and communities, especially older people in their homes, from the nursing homes as nursing patients with chronic disease to have pressure sores for paralyzed at home.<sup>14,15</sup>

2. A health educator is the role of teaching, giving advice, and knowledge in self-practice to achieve behavior change or take care of yourself with target groups in various interventions. There are including individual health education teaching, personal discussion, group discussion by providing knowledge from exhibitions such as giving advice, behavioral adjustment to promote excretion, and teaching patients with their caregivers to self-rehabilitation.<sup>14,15</sup>
3. A counselor is to provide information, give knowledge and understanding, and, most importantly, offer guidance or alternatives to self-care until service recipients can decide by themselves. To overcome obstacles throughout the health care crisis possible by the client or their family from nurse practitioners who have to perform the mentoring role, they must have the knowledge and skills to be trained to express listening intently by studying or inquiring about the background of the service recipient.<sup>14,15</sup>
4. The advocator is the person who has the immediate benefit of receiving the right of treatment that should be obtained, including interests and patient rights, which is a fundamental human right. The families of older people with urinary incontinence should receive healthcare services when needed. The nurse practitioners should provide information on health services related to the exercise of the said right with equality and fairness.<sup>14,15</sup>
5. The coordinator refers to the role of communicating with health personnel such as volunteers, physicians, physiotherapists, pharmacists, dentists, and other groups that enable effective community operations. The role of coordination of geriatric practice nurses in the community includes contacting a physical therapist to help rehabilitate paralyzed patients, coordinating the department of social development staff to take care of the disabled without relatives to promote better care of the elderly at the community level.<sup>14,15</sup>

### **Conclusion**

In conclusion, older people with urinary incontinence symptoms must have caring from an initial assessment of the problem and requirements. To prevent the occurrence of more severe issues of older people with symptoms of urinary incontinence will not be able to control the urination on their own. It is a loss of the ability to control urine flow. Often this happens in situations where

urination is not ready, and it slips off came by accident. An affects the occurrence of physical, mental, social and physical health problems resulting in a decrease in quality of life. In the role of nurse practitioner focus on health promotion, disease prevention, rather than treatment and recovery of the individual or family together with the freedom to make decisions for ongoing health care or care problems, and improve the quality of life for the as competent individual, family and community level.

**Conflict of Interest:** None

**Source of Funding:** By Self

**Ethical Clearance:** None

### **References**

1. Department of Ageing and life course. Integrated care for older people: guidelines on community-level interventions to manage declines in intrinsic capacity [Internet]: World Health Organization. 2017 [cited 2020 Aug 19]. Available at: <https://apps.who.int/iris/bitstream/handle/10665/258981/9789241550109-eng.pdf?sequence=1 & isAllowed=y>
2. Shaw C, Wagg A. Urinary incontinence in older adults. *Medicine* 2017; 45: 23- 27.
3. Harper GM, Lyons WL, Potter JF. The Geriatrics review syllabus: A core curriculum in geriatric medicine [Internet]: J Am Geriatr Soc 2019 [cited 2020 Aug 20]. Available form: [https://geriatricscareonline.org/ContentAbstract/urinary-incontinence/B041/B041\\_VOL001\\_PART001\\_SEC004\\_CH030/?param2=search](https://geriatricscareonline.org/ContentAbstract/urinary-incontinence/B041/B041_VOL001_PART001_SEC004_CH030/?param2=search)
4. DeMaagd GA, Timothy CD. Management of Urinary Incontinence. a peer-reviewed journal for formulary management. *P & T* 2012; 37(6): 345-361H.
5. Shaban A, Drake MJ, Hashim H. The medical management of urinary incontinence. *Autonomic neuroscience: basic and clinical* 2010; 152(1-2): 4-10.
6. Torraco RJ. Writing integrative literature reviews: Using the past and present to explore the future. *Hum Resour Dev Rev* 2016; 15(4): 404-28.
7. Oxford learner's dictionaries Oxford University Press 2020 [Internet]. [cited 2020 Aug 20]. Available form. <https://www.oxfordlearnersdictionaries.com/definition/english/incontinence?q=incontinence>



8. Emmons KR, Robinson JP. The impact of urinary incontinence on older adults and their caregiver 2014 [Internet]. [cited 2020 Aug 21]. Available at: <https://www.aginglifecarejournal.org/the-impact-of-urinary-incontinence-on-older-adults-and-their-caregivers/>
9. John G, Bardini C, Combescure C, Dällenbach, P. Urinary Incontinence as a predictor of death: A systematic review and meta-analysis. *PLOS ONE* 2016; 11(7): 1-19.
10. Goldberg C. Practical guide to clinical medicine: A comprehensive physical examination and clinical education site for medical students and other health care professionals 2018 [Internet]. [cited 2020 Aug 21]. Available at: <https://meded.ucsd.edu/clinicalmed/history.html>
11. Ayeleke RO, Hay-Smith EJC, Omar MI. Pelvic floor muscle training added to another active treatment versus the same active treatment alone for urinary incontinence in women. *Cochrane database of SystRev* 2017; Issue 11. Art. No.: CD010551.
12. Health Quality Ontario. Electronic monitoring systems to assess urinary incontinence: A health technology assessment. Queen's printer for Ontario 2018; 18(3):1-60.
13. Wangpitipanit S, Thrakul S, Prasongwattana S. The older women with urinary incontinence and chronic illness who living in urban community: A case study. *Acta Scientific Nutritional Health* 2019; 3(8), 31-37.
14. Hunter KF, Wagg AS. Improving nurse engagement in continence care. *Nursing: Research and Reviews* 2018; 8: 1-7.
15. Royal college of nursing. Improving continence care for patients: The role of the nurse. London 2016 [Internet]. [cited 2020 Aug 21]. Available at: [https://www.dignityincare.org.uk/\\_assets/Resources/Dignity/OtherOrganisation/RCN\\_Improving\\_Continence\\_Care\\_for\\_Patients.pdf](https://www.dignityincare.org.uk/_assets/Resources/Dignity/OtherOrganisation/RCN_Improving_Continence_Care_for_Patients.pdf)

# Infliximab-Associated Hepatic Injury in Crohn's Disease

Sura A. Abdulsattar<sup>1</sup>, Raghd A.Y. Alkhader<sup>2</sup>, Haider Ridha Mohammed Saeed<sup>3</sup>, Fatin F. AlKazazz<sup>4</sup>

<sup>1</sup>Professor, <sup>2</sup>Assistant Tutor, <sup>3</sup>Assistant Tutor, Department of Chemistry and Biochemistry, College of Medicine, Mustansiriyah University, Baghdad, Iraq, <sup>4</sup>Professor, Department of Chemistry, College of Science, Mustansiriyah University, Baghdad, Iraq

## Abstract

Hepatotoxicity disorders are relatively common in patients with inflammatory bowel disease that includes ulcerative colitis and Crohn's disease. Abnormal serum liver functions tests can develop during treatment with (TNF- $\alpha$ ) blocking agents, such as, Infliximab. The aim of this review is to clarify the role of infliximab in the development of liver enzyme abnormalities in patients with Crohn's disease. The most common presentation of infliximab -associated liver injury is a hepatocellular type with auto-immune features, marked by increased serum aminotransferases levels. Cholestatic injury is much less common, and marked by jaundice and increased serum ALP and bilirubin levels, with elevations of serum ALT and AST. Abnormalities of liver function tests in sera of patients with Crohn's disease typically resolve after discontinuation of infliximab, although severe liver injury leading to liver transplant cannot be ruled out.

**Keywords:** *Aminotransferase, autoimmune hepatitis, Cholestatic, Crohn's, hepatocellular, inflammatory bowel disease, Infliximab, liver.*

## Introduction

**Crohn's Disease:** Crohn's disease (CD) is a chronic inflammatory condition characterized by discontinuous skip lesions affecting any part of the gastrointestinal tract from the mouth to the anus. It is encompassed in the term "inflammatory bowel disease (IBD)", which includes ulcerative colitis (UC) and CD<sup>1</sup>. Crohn disease is a chronic disease with an annual incidence ranging from 3 to 20 cases per 100,000. The median onset of disease is age 30 years and it has 2 peaks, first between age 20 and 30 years and then a smaller peak around age 50 years<sup>2</sup>. The origin of the disease is not entirely clear however several involved mechanisms have been postulated such as genetic predisposition and disruption of homeostasis regulation in the gastrointestinal tract<sup>3</sup>. The diagnosis and management of Crohn's disease is based on clinical signs and symptoms in addition to laboratory tests, endoscopy and imaging techniques<sup>4</sup>. Medical treatment for IBD typically targets inflammatory mediators including aminosalicylates, corticosteroids, immunomodulators such as methotrexate, and the biological therapies including anti-tumor necrosis factor (TNF) therapies<sup>5</sup>. The aim of this review is to clarify the role of infliximab in the development of liver enzyme

abnormalities in patients with CD and its relationship to drug-induced liver injury (DILI).

**Anti-Tumor Necrosis Factor Alpha Therapy:** Biologic therapy with anti-TNF medication has been effective in treating inflammation and reducing complications in CD<sup>6</sup>. Infliximab, adalimumab, and certolizumab have been shown to be effective as both induction and maintenance therapy in moderate to severe CD<sup>7</sup>. In systematic review of Singh S et.al. It has been suggested through indirect comparisons that infliximab or adalimumab may be preferred as the first line agents, while ustekinumab preferred as the second line agent, for induction of remission in patients with moderate-severe CD<sup>8</sup>. In (Robbins L. et al.) study, anti-TNF alpha therapy successfully treated denovo CD in 28 out of 38 (74%) patients. Out of seventeen patients with CD who had failed to response to anti-TNF alpha agents before surgery and were treated with anti-TNF alpha therapy after surgery, twelve patients (71%) responded to the treatment<sup>9</sup>. A study of Buhl S et.al. reported that in total, 376 Crohn's disease patients had received infliximab. After 1 year of therapy 76 (20%) among them were classified as having response but non-remission. While it was found that there was no additional therapeutic

benefit after another year of treatment maintenance of infliximab for (n = 54; 71%), thus still having response but non-remission. Nineteen patients (25%) obtained remission during continued infliximab, whereas only 4% (n = 3) experienced treatment failure<sup>10</sup>. Loss of response (LOR) to biologics in Crohn's disease is a significant clinical problem<sup>11</sup>. The rates of LOR are reported to be 50–54% in CD patients during 1 year of continuous IFX treatment<sup>12</sup>. The rates of LOR are reported to be 50–54% in CD patients during 1 year of continuous IFX treatment<sup>13,14</sup>. While in other study indicated by meta-analysis that the incidence of LOR among adult CD patients undergoing IFX therapy is 34%<sup>15</sup>. Study by de Bruyn JR et.al reported that the failure to Infliximab therapy is associated with subclinical fibrosis in Crohn's disease<sup>16</sup>.

There are numerous complications which have been described with the use of infliximab such as instances of cholestasis or hepatitis<sup>45,47,50</sup>, induction of auto-immune/immuno-mediated hepatitis<sup>51-54</sup>, acute liver failure<sup>55,56</sup> and the need for liver transplantation<sup>57,58</sup>. In the earlier controlled trial of Infliximab in Crohn's disease minor elevation in levels of the liver enzymes were described, but extreme elevations were rare, and no cases of liver failure or jaundice were found<sup>21</sup>. Cholestatic liver injury was described in one case report of a patient treated with IFX. The patient developed jaundice after the infliximab infusion, with high alkaline phosphatase levels accompanied by elevations in bilirubin, ALT and AST. The patient underwent liver biopsy which revealed "bland cholestasis". Cholestatic injury resolved within 4 weeks with supportive therapy and cessation of IFX<sup>47</sup>. Cases of AIH have also been demonstrated in patients with IBD receiving treatment<sup>38</sup>. Several cases have been reported AIH in CD patients who received infliximab therapy<sup>51-54,59</sup>. In one of these cases, Cravo *et al.*<sup>51</sup> reported a 38-year-old female suffering from Crohn's disease who required IFX. At the beginning of therapy, LFTs were normal, furthermore ANA as well as Anti-ds-DNA were negative. Importantly, 2 years into treatment with IFX, the patient developed transaminases and hypergammaglobulinemia. Serology results for viral infections were negative, moreover ANA, Anti-ds-DNA, in addition to antihistone antibodies were positive. "Liver biopsy showed chronic hepatitis with inflammatory plasmocytic infiltrate in the portal tracts, interface hepatitis, and mild periportal fibrosis." So, the patient met the criteria for a definitive

autoimmune hepatitis. During three-months period, after discontinuing IFX therapy, ANA titers reduced with normalization of LFTs<sup>51</sup>. In most reported cases of IFX-induced autoimmune hepatitis, the hepatitis resolved with discontinuation of infliximab and steroid treatment. Interestingly, in two of these reported cases, AIH resolved when switched to another biologic agent for example adalimumab (ADA) implying an absence of cross-reactivity<sup>51,53</sup>. This phenomenon can be related to IFX being a chimeric (part mouse, part human) monoclonal antibody, while ADA is a fully human antibody<sup>22,51</sup>. In this regard, Rodrigues *et al.*,<sup>60</sup> described 8 cases of TNF- $\alpha$  blocking agents-induced hepatitis which was defined as ALT levels ( $>10 \times$  ULN) out of a cohort including 600 patients, with seven cases related to infliximab (3/7 patients with Crohn's disease). These 3 patients with Crohn's disease showed an autoimmune type of liver injury, with elevated levels of aminotransferases. Two patients responded favourably to steroids with normalization of LFTs after the suspension of IFX. In one female patient, IFX therapy was restarted within three months after discontinuation of this agent, with no recurrence of the liver injury<sup>60</sup>. In the case reports of van Casteren-Messidoro *et al.*<sup>59</sup> two female patients suffering from IBD developed AIH while receiving IFX. One case with Crohn's disease, developed AIH after the third infusion of IFX, with elevated serum transaminase levels up to ( $25 \times$  ULN). During five-months period, after discontinuing IFX, and receiving azathioprine along with steroids, her transaminases normalized<sup>59</sup>. Crohn's disease, chronic inflammatory granulomatous condition of gastrointestinal tract, can rarely have extra-intestinal complications. Involvement of the vulva in CD is very uncommon<sup>61</sup>. Caussé *et al.*,<sup>56</sup> reported a case of IFX-induced acute hepatitis in a patient suffering from severe vulvar Crohn's disease. Her LFTs showed ten times the normal value of ALT, twice the normal value of AST, 1.5 times the normal value of ALP and three times the normal value of GGT. Due to the hepatitis, the IFX therapy was withdrawn<sup>56</sup>. Importantly, the latest case reports have described two rare cases of IFX-induced autoimmune hepatitis in patients with Crohn's disease that led to liver failure necessitating liver transplantation. One well-documented case by Estes *et al.*,<sup>57</sup> described markedly elevated levels of aminotransferases and bilirubin, 5 months after starting IFX. Similarly, in another report by Wong *et al.*,<sup>58</sup> one such case developed 3 months after starting infliximab, with abnormal LFTs, low albumin level and jaundice.

## Conclusion

Infliximab-associated liver injury is still a potential concern in patients with Crohn's disease. The most common presentation is a hepatocellular pattern of injury with auto-immune features, involving histologic changes which are similar to autoimmune hepatitis. This pattern marked by increased serum and AST levels. Cholestatic injury due to Infliximab is much less common, and marked by increased serum ALP and bilirubin levels, with elevations of serum ALT and AST. Symptoms generally include jaundice. In most cases, these patterns of injury improve and abnormalities in liver function tests typically resolve after discontinuation of infliximab, although severe liver injury leading to liver transplant cannot be ruled out.

**Conflict of Interest:** We declare that we have no conflict of interest.

**Source of Funding:** Self

**Ethical Clearance:** Ethics committee approval obtained from Mustansiriyah University/College of medicine and college of science.

## References

- Mohammad F.A, Alkazazz F.F, Abdusattar S.A. Zinc Deficiency is Associated with Meprin in Iraqi Patients with Crohn's Disease. *Medico-legal Update, January-March 2020, Vol.20(1):1097-1102.*
- J. D. Feuerstein and A. S. Cheifetz, "Crohn disease: epidemiology, diagnosis, and management," *Mayo Clinic Proceedings*, vol. 92, no. 7, pp. 1088–1103, 2017.
- Kúsulaa-Delint D, González-Regueiro JA, Rodríguez-Aldama JC, García-Miranda FS, García-Santos RA, Lizardo AE, Gutiérrez-Grobo Y. Crohn's disease. Review and current concepts. *Rev Invest Med Sur Mex*, 2016; 23 (1): 10-20 11.
- Cosima Schiavone, Marcello Romano. Diagnosis and management of Crohn's disease. *J Ultrasound*. 2015 Mar; 18(1): 1–2.
- Mohammad F.A, Alkazazz F.F, Abdusattar S.A. Risk of Osteoporosis in Patients with Crohn's Disease Not Respond to Infliximab Therapy Undergoing Surgical Intervention. *Indian Journal of Forensic Medicine & Toxicology*.2020 Vol. 14 (1): 968-973.
- Razvi M, Lazarev M .Optimization of biologic therapy in Crohn's disease. *Expert Opin Biol Ther*. 2018 Mar; 8(3):263-272. doi: 10.1080/14712598.2018.1410131
- Adegbola SO, Pisani A, Sahnan K, Tozer P, Ellul P, Warusavitarne J. Medical and surgical management of perianal Crohn's disease. *Ann Gastroenterol*. 2018 Mar-Apr;31(2):129-139.
- Singh S, Fumery M, Sandborn WJ, Murad MH.Systematic review and network meta-analysis: first- and second-line biologic therapies for moderate-severe Crohn's disease. *Aliment Pharmacol Ther*. 2018 Aug;48(4):394-409.
- Robbins L, Zaghiyan K, Melmed G., et al. Outcomes with anti-tumour necrosis factor-alpha therapy and serology in patients with de novo Crohn's disease after ileal pouch anal anastomosis. *J Crohn's Colitis* 2017; 11 (01) 77-83.
- Buhl S, Kristina Borghede M, Brynskov J, Steenholdt C, Rasmussen M, Andrew Ainsworth M.Outcome of Continued Infliximab Therapy in Crohn's Disease Patients With Response but Without Remission After One Year of Infliximab - A Retrospective Cohort Study. *Scand J Gastroenterol*. 2018 Aug; 53(8):930-937.
- Boneh R, Sarbagili Shabat C, Yanai H, Chermesh I, Ben Avraham S, Boaz M, Levine A.J .Dietary Therapy With the Crohn's Disease Exclusion Diet Is a Successful Strategy for Induction of Remission in Children and Adults Failing Biological Therapy *Sigall Crohns Colitis*. 2017 Oct 1;11(10):1205-1212.
- Papamichael K, Gils A, Rutgeerts P, Levesque BG, Vermeire S, Sandborn WJ, VandeCastele N .Role for therapeutic drug monitoring during induction therapy with TNF antagonists in IBD: evolution in the definition and management of primary nonresponse *Inflamm Bowel Dis*. 2015 Jan; 21(1):182-97.
- Romero-Cara P, Torres-Moreno D, Pedregosa J, Vilchez JA, García-Simón MS, Ruiz-Merino G, et al. A FCGR3A polymorphism predicts anti-drug antibodies in chronic inflammatory bowel disease patients treated with anti-TNF. *Int J Med Sci*. 2018;15(1): 10–15.
- Hanauer SB, Wagner CL, Bala M, Mayer L, Travers S, Diamond RH, et al. Incidence and importance of antibody responses to infliximab after maintenance

- or episodic treatment in Crohn's disease. *Clin Gastroenterol Hepatol.* 2004;2: 542–553.
15. Zhang QW, Shen J, Zheng Q, Ran ZH Loss of Response to Scheduled Infliximab Therapy for Crohn's Disease in Adults: A Systematic Review and Meta-Analysis. *J Dig Dis.* 2019 Feb; 20(2):65-72.
  16. de Bruyn JR, Becker MA, Steenkamer J, Wildenberg ME, Meijer SL, Buskens CJ, Bemelman WA, Löwenberg M, Ponsioen CY, van den Brink GR, D'Haens GR. Intestinal Fibrosis Is Associated With Lack of Response to Infliximab Therapy in Crohn's Disease. *PLoS One.* 2018 Jan 24;13(1):e0190999.
  17. Billiet, T, Rutgeerts, P, Ferrante, M. Targeting TNF- $\alpha$  for the treatment of inflammatory bowel disease. *Expert Opin Biol Ther* 2014; 14: 75–101.
  18. Papamichael, K., Lin, S., Moore, M., Papaioannou, G., Sattler, L., & Cheifetz, A. S. (2019). Infliximab in inflammatory bowel disease. *Therapeutic Advances in Chronic Disease.*
  19. Atreya R, Zimmer M, Bartsch B, Waldner MJ, Atreya I, Neumann H, et al. Antibodies against tumor necrosis factor (TNF) induce T-cell apoptosis in patients with inflammatory bowel diseases via TNF receptor 2 and intestinal CD14(+) macrophages. *Gastroenterology.* 2011;141(6):2026–38.
  20. Matsuoka K, Hamada S, Shimizu M, Nanki K, Mizuno S, Kiyohara H, Arai M, Sugimoto S, Iwao Y, Ogata H, Hisamatsu T, Naganuma M, Kanai T, Mochizuki M, Hashiguchi M. Factors predicting the therapeutic response to infliximab during maintenance therapy in Japanese patients with Crohn's disease. *PLoS One.* 2018 Oct 4;13(10):e0204632.
  21. Hanauer SB, Feagan BG, Lichtenstein GR, Mayer LF, Schreiber S, Colombel JF, et al. Maintenance infliximab for Crohn's disease: the ACCENT I randomised trial. *Lancet (London, England).* 2002;359(9317):1541–9.
  22. Parekh R, and Kaur N. Liver Injury Secondary to Anti-TNF-Alpha Therapy in Inflammatory Bowel Disease: A Case Series and Review of the Literature. *Case Rep Gastrointest Med.* 2014; 2014: 956463.
  23. Jonas, M. M., and Lee, C. Review. *Gastroenterol Hepatol (N Y).* 2006 Feb;2(2):90.
  24. French JB, Bonacini M, Ghabril M, Foureau D, Bonkovsky HL. Hepatotoxicity associated with the use of anti-TNF- $\alpha$  agents. *Drug Saf.* 2016;39(3):199–208.
  25. Harding FA, Stickler MM, Razo J, DuBridge RB. The immunogenicity of humanized and fully human antibodies: residual immunogenicity resides in the CDR regions. *MonoclonAntib.* 2010;2(3):256–265.
  26. Eriksson, C.; Engstrand, S.; Sundqvist, K.G.; Rantapaa-Dahlqvist, S. Autoantibody formation in patients with rheumatoid arthritis treated with anti-TNF alpha. *Ann. Rheum. Dis.* 2005, 64, 403–407.
  27. Tobon, G.J.; Canas, C.; Jaller, J.J.; Restrepo, J.C.; Anaya, J.M. Serious liver disease induced by infliximab. *Clin. Rheumatol.* 2007, 26, 578–581.
  28. Diehl, A.M. Cytokine regulation of liver injury and repair. *Immunol. Rev.* 2000, 174, 160–171.
  29. Chen, X.; Oppenheim, J.J. Contrasting effects of TNF and anti-TNF on the activation of effector t cells and regulatory t cells in autoimmunity. *FEBS Lett.* 2011, 585, 3611–3618.
  30. Lopetuso LR, Mocci G, Marzo M, D'aversa F, Rapaccini GL, Guidi L, Armuzzi A, Gasbarrini A, Papa A. Harmful effects and potential benefits of anti-tumor necrosis factor (TNF)- $\alpha$  on the liver. *International journal of molecular sciences.* 2018 Aug;19(8):2199.
  31. Papamichael, K., Mantzaris, G. J., and Peyrin-Biroulet, L. A safety assessment of anti-tumor necrosis factor alpha therapy for treatment of Crohn's disease, *Expert Opinion on Drug Safety.* 2016, 15:4, 493-501.
  32. Lichtenstein, GR, Feagan, BG, Cohen, RD. Infliximab for Crohn's Disease: More Than 13 Years of Real-world Experience *Inflamm Bowel Dis.* 2018 Mar; 24(3): 490–501.
  33. United States Department of Health and Human Services F. Guidance for Industry Drug-Induced Liver Injury: Premarketing Clinical Evaluation. *Drug Saf* 2009; 28. Available from: <https://www.fda.gov/downloads/Drugs/.../Guidances/UCM174090>.
  34. Shelton E, Chaudrey K, Sauk J, Khalili H, Masia R, Nguyen DD, Yajnik V, Ananthakrishnan AN. New onset idiosyncratic liver enzyme elevations with biological therapy in inflammatory bowel disease. *Aliment Pharmacol Ther.* 2015 May;41(10):972-9. doi: 10.1111/apt.13159. Epub 2015 Mar 10
  35. Parisi I, O'Beirne J, Rossi RE, Tsochatzis E, Manousou P, Theocharidou E, Hamilton M,

- Murray C, Epstein O, Burroughs AK. Elevated liver enzymes in inflammatory bowel disease: the role and safety of infliximab. *Eur J Gastroenterol Hepatol*. 2016 Jul;28(7):786-91. doi:10.1097/MEG.0000000000000624.
36. Koller T, Galambosova M, Filakovska S, Kubincova M, Hlavaty T, Toth J, Krajcovicova A, Payer J. Drug-induced liver injury in inflammatory bowel disease: 1-year prospective observational study. *World J Gastroenterol*. 2017 Jun 14;23(22):4102-4111.
  37. US Department of Health and Human Services. (2010) Common terminology criteria for adverse events (CTCAE) version 4.03. USA: National Institutes of Health, National Cancer Institute.
  38. Rojas-Feria M1, Castro M, Suárez E, Ampuero J, Romero-Gómez M. Hepatobiliary manifestations in inflammatory bowel disease: the gut, the drugs and the liver. *World J Gastroenterol*. 2013 Nov 14;19(42):7327-40. 39.
  39. Björnsson ES, Gunnarsson BI, Gröndal G, et al. Risk of drug-induced liver injury from tumor necrosis factor antagonists. *Clin Gastroenterol Hepatol* 2015; 3: 602–8.
  40. Kok B, Lester ELW, Lee WM, Hanje AJ, Stravitz RT, Girgis S, Patel V, Peck JR, Esber C, Karvellas CJ; United States Acute Liver Failure Study Group. Acute Liver Failure from Tumor Necrosis Factor- $\alpha$  Antagonists: Report of Four Cases and Literature Review. *Dig Dis Sci*. 2018 Jun;63(6):1654-1666.
  41. Kim JM, Cheon JH. Pathogenesis and clinical perspectives of extraintestinal manifestations in inflammatory bowel diseases. *Intestinal Research*. 2020 Apr 18.
  42. Khan N, Abbas AM, Whang N, et al. Incidence of liver toxicity in inflammatory bowel disease patients treated with methotrexate: a meta-analysis of clinical trials. *Inflamm Bowel Dis* 2012;18:359–67.
  43. Colina F, Molero A, Casis B, et al. Infliximab-related hepatitis: a case study and literature review. *Dig Dis Sci* 2013;58:3362–7.
  44. Saubermann LJ, Deneau M, Falcone RA, Murray KF, Ali S, Kohli R, Ekong UD, Valentino PL, Grossman AB, Rand EB, Jonas MM. Hepatic issues and complications associated with inflammatory bowel disease: a clinical report from the NASPGHAN inflammatory bowel disease and hepatology committees. *Journal of pediatric gastroenterology and nutrition*. 2017 Apr 1;64(4):639-52.
  45. Ghabril M, Bonkovsky HL, Kum C, et al. Liver injury from tumor necrosis factor- $\alpha$  antagonists: analysis of thirty-four cases. *Clin Gastroenterol Hepatol* 2013;11:558.e3–64.e3.
  46. Mancini S, Amorotti E, Vecchio S, et al. Infliximab-related hepatitis: discussion of a case and review of the literature. *Intern Emerg Med* 2010;5:193–200.
  47. Menghini VV, Arora AS. Infliximab-associated reversible cholestatic liver disease. *Mayo Clin Proc* 2001;76:84-86.
  48. Soto-Fernández S, González-Carro P, De Pedro-Esteban A, Legaz-Huidobro ML, Pérez-Roldán F, Roncero García-Escribano O, et al. Infliximab-induced hepatitis in a patient with Crohn's disease [in Spanish]. *Gastroenterol Hepatol* 2006;29:321-322.
  49. Moum B, Konopski Z, Tufteland KF, Jahnsen J. Occurrence of hepatotoxicity and elevated liver enzymes in a Crohn's disease patient treated with infliximab. *Inflamm Bowel Dis* 2007;13: 1584-1586.
  50. Rossi RE, Parisi I, Despott EJ, Burroughs AK, O'Beirne J, Conte D, et al. Anti-tumour necrosis factor agent and liver injury: literature review, recommendations for management. *World J Gastroenterol* 2014;20:17352-17359.
  51. Cravo M, Silva R, Serrano M. Autoimmune hepatitis induced by infliximab in a patient with Crohn's disease with no relapse after switching to adalimumab. *Bio Drugs* 2010;24(Suppl. 1):25-27.
  52. Doyle A, Forbes G, Kontorinis N. Autoimmune hepatitis during infliximab therapy for Crohn's disease: a case report. *J Crohns Colitis* 2011;5:253-255.
  53. Goldfeld DA, Verna EC, Lefkowitz J, Swaminath A. Infliximab-induced autoimmune hepatitis with successful switch to adalimumab in a patient with Crohn's disease: the index case. *Dig Dis Sci* 2011;56:3386-3388.
  54. Subramaniam K, Chitturi S, Brown M, Pavli P. Infliximab-induced autoimmune hepatitis in Crohn's disease treated with budesonide and mycophenolate. *Inflamm Bowel Dis* 2011; 17:E149-E150.
  55. Haennig A, Bonnet D, Thebault S, Alric L.

- Infliximab-induced acute hepatitis during Crohn's disease therapy: absence of cross-toxicity with adalimumab. *Gastroenterol Clin Biol* 2010; 34:e7-e8.
56. Caussé S, Bouquin R, Wylomanski S, Flamant M, Joubert M, Dréno B, et al. Infliximab-induced hepatitis during treatment of vulvar Crohn's disease [in French]. *Ann Dermatol Venereol* 2013;140:46-51.
  57. Estes DJ, Szeto W, Kingsley M, Poveda JC, Beduschi T, Deshpande AR. Unique Immediate Postoperative Management of Crohn's Disease in a Patient with Autoimmune Hepatitis-Like Drug-Induced Liver Injury from Infliximab Requiring Liver Transplantation. *American Journal of Medical Case Reports*. 2020;8(1):11-3.
  58. Wong F, Al Ibrahim B, Walsh J, Qumosani K. Infliximab-induced autoimmune hepatitis requiring liver transplantation. *Clinical Case Reports*. 2019 Nov; 7(11):2135-9.
  59. Van Casteren-Messidoro C, Prins G, van Tilburg A, Zelinkova Z, Schouten J, de Man R. Autoimmune hepatitis following treatment with infliximab for inflammatory bowel disease. *J Crohns Colitis*. 2012;6:630-631.
  60. Rodrigues, S., Lopes, S., Magro, F., Cardoso, H., e Vale, A.M.H., Marques, M., Mariz, E., Bernardes, M., Lopes, J., Carneiro, F. and Macedo, G., 2015. Autoimmune hepatitis and anti-tumor necrosis factor alpha therapy: a single center report of 8 cases. *World journal of gastroenterology: WJG*, 21(24), p.7584.
  61. Batra J, Goraya SK, Grewal S, Singh A. Metastatic Crohn's disease of the vulva: A rare presentation. *Indian Dermatology Online Journal*. 2020 May 1;11(3):416.

# COVID 19: Evaluate of Liver and Renal Function Tests in Iraqi Patients

Sura A. Abdulsattar<sup>1</sup>, Mahmood Nazar Mustafa<sup>2</sup>, Abdullah Ali Mohammed<sup>3</sup>, Ahmed Salam Al-zaidi<sup>4</sup>

<sup>1</sup>Prof. Dr. (PHD) Department of Chemistry and Biochemistry, Mustansiriyah University, College of Medicine, Iraq, <sup>2</sup>Assistant Lecturer (MSc) Department of Pathology and Forensic Medicine, University of Fallujah, College of Medicine, Iraq, <sup>3</sup>Assistant Lecturer (MSc) Department of Chemistry and Biochemistry, University of Fallujah, College of Medicine, Iraq, <sup>4</sup>(MSc) Department of Medical Analysis, Al-Furat General Hospital, Iraq

## Abstract

The clinical features of COVID-19 are varied, ranging from asymptomatic state to acute respiratory distress syndrome and multi organ dysfunction. We aim to evaluate renal and liver functions of patients with COVID 19. Laboratory results were obtained from 107 patients with laboratory-confirmed COVID-19 who were admitted to the only Al-Furat General Hospital in Baghdad, Iraq from March 3 to June 9, 2020 and followed up until recovery. Normal levels of renal functions were presented. Meanwhile elevated levels of alanine aminotransferase (ALT) was observed in 10% and of aspartate aminotransferase (AST) was observed in 40% of patients with COVID 19, yet on comparison of the results at entering with at recovery it was observed significant differences ( $p < 0.01$ ) of all patients. From these findings we conclude that the virus might be responsible for systemic inflammation.

**Keyword:** COVID 19; liver enzyme; urea; creatinine; AST, ALT.

## Introduction

On 7 January 2020, a novel coronavirus was identified in the throat swab sample of one patient by the Chinese Center for Disease Control and Prevention (CDC), and was subsequently named as 2019nCoV by World Health Organization (WHO) <sup>1, 2</sup>. The virus was identified as a coronavirus that had >95% homology with the bat coronavirus and >70% similarity with the SARS-CoV. Environmental samples from the Huanan sea food market also tested positive, signifying that the virus originated from there <sup>3</sup>. The number of cases started increasing exponentially, some of which did not have exposure to the live animal market, suggestive of the fact that human-to-human transmission was

occurring (2020)<sup>4</sup>. All ages are susceptible. Infection is transmitted through large droplets generated during coughing and sneezing by symptomatic patients but can also occur from asymptomatic people and before onset of symptoms <sup>5</sup>. The clinical features of COVID-19 are varied, ranging from asymptomatic state to acute respiratory distress syndrome and multi organ dysfunction. The common clinical features include fever (not in all), cough, sore throat, headache, fatigue, headache, myalgia and breathlessness<sup>6</sup>. Some patients with COVID-19 pneumonia also present with kidney injury, and autopsy findings of patients who died from the illness sometimes show renal damage. However, little is known about the clinical characteristics of kidney-related complications, including hematuria, proteinuria, and AKI <sup>7</sup>. Recently, there has been some insight into the impact of COVID-19 on other organs, as a number of reports have indicated that more than half of patients with COVID-19 showed varying levels of liver disease <sup>8</sup>. The median time from onset of symptoms to dyspnea was five day, hospitalization seven day and acute respiratory distress syndrome (ARDS) eight day. The need for intensive care admission was in 25–30% of affected patients in published series. Complications

---

### Corresponding Author:

**Abdullah Ali Mohammed**

Assistant Lecturer (MSc) Department of Chemistry and Biochemistry, University of Fallujah, College of Medicine

abdullah@yaho.com  
e-mail: medical@yahoo.com



witnessed included acute lung injury, acute cardiac injury, shock and acute kidney injury. Recovery started in the 2nd or 3rd wk<sup>9</sup>. The various diagnosis method such as serological, molecular, and radiological can help the health centers in the detection of SARS-CoV-2; radiological and serological techniques are the best method among the others and the radiological method is the most preferred one, able to diagnose the infection quickly and accurately with fewer false-negatives<sup>10</sup>. Liver impairment has been reported as a common clinical manifestation in patients with SARS-CoV infection, even if not a prominent feature of the illness<sup>11, 12</sup>.

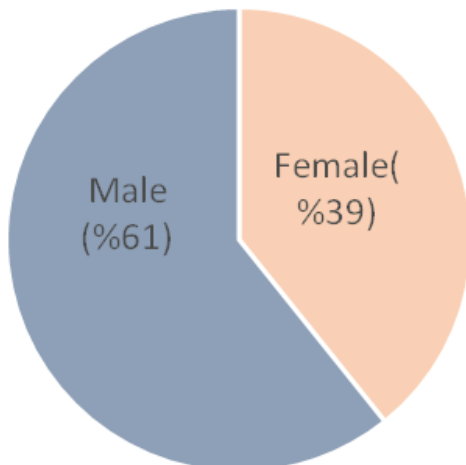
**Material and Method**

This was a cross-sectional study, we analyzed biochemical data from electronic medical records of 107 hospitalized patients of Al-Furat General Hospital from Baghdad with COVID-19 (65 male and 42 female) for period (march 3 to June 9,2020). The data analysis included urea, creatinine, ALT, AST, and ALP twice: first at entering the hospital (group A) and second at recovery (group B).

**Statistical Analysis:** Continuous data were expressed as mean and standard deviation (SD). For the variables, paired test was employed to analyse the difference. All statistical analyses were performed using the SPSS 20.0 (SPSS Inc) software package. A (P value of < 0.05) was considered statistically significant.

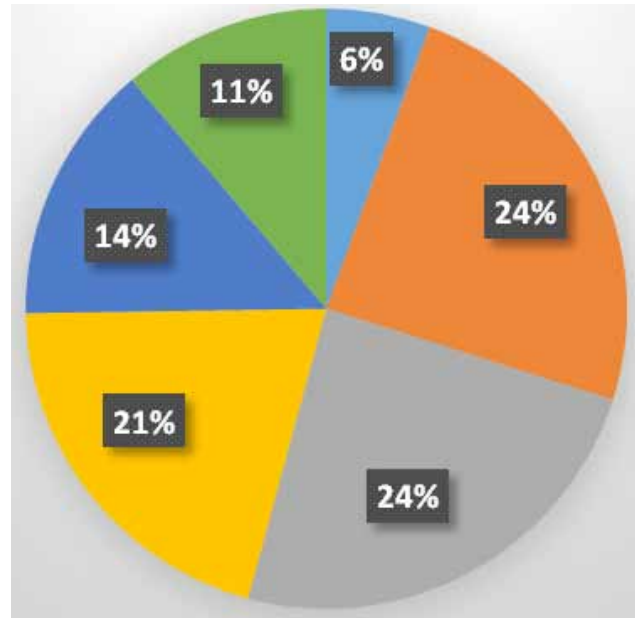
**Results and Discussion**

The current evidence indicates that infection rates of COVID 19 are higher in male than in female (Figure 1), where 61 % (65 among 107) was male and 39 % (42 among 107) was female.



**Figure 1: Covid 19 distribution among gender**

The current results of COVID 19 distribution among age as shown in Figure 2 indicated that the most affected ages are between (20-40 year). The lowest affected ages was less than 20 year.



**Figure 2: Covid 19 distribution among age where 6% : patients with age <20 year,24% : patients with age range (21-30 year) & (31-40 year)respectively, 21%:: patients with age range(41-50 year),14%:: patients with age range(51-60year),and 11% : patients with age (61-70 year).**

The results presented in Table 1 shows the levels of urea, creatinine, AST, ALT and ALP in sera of COVID 19 patients over two periods: the first when entering the hospital (group A) and the second when recovery (group B). Levels of urea, creatinine, AST, ALT and ALP were showed within normal level, however there were a highly significant differences (p<0.01) between groups in urea, creatinine, AST in both male and female patients .While the results of ALT indicated highly significant differences (p<0.01) only in male patients. For ALP the results of male indicated highly significant differences (p<0.01) and for female the result showed significant differences (p<0.05).In more detail the results indicted elevated levels of AST in 40% patients and of ALT in 10% patients, while no elevated levels of ALP was observed.

**Table 1: The levels of urea, creatinine, AST, ALT and ALP in sera of COVID 19 patients**

Parameter	Gender	Mean±SD Group A	Mean±SD Group B	P value
Urea (mmol/L)	Male	4.29	3.48	0.00
	Female	4.33	3.21	0.00
Creatinine (mmol/L)	Male	74.58	69.67	0.00
	Female	72.78	68.47	0.00
AST (U/L)	Male	45.96	36.26	0.00
	Female	45.7857	36.1429	0.00
ALT (U/L)	Male	36.41	28.83	0.00
	Female	26.2381	24.2143	0.106
ALP (μkat/L)	Male	81.63	76.10	0.00
	Female	84.6667	76.7143	0.015

Although available sex-disaggregated data for COVID-19 show equal numbers of cases between sexes, current study indicates that infectious rates are higher in male than in female, and that may be due to sex hormone that contribute to different immunologic responses in men and women: As a general rule, estrogens promote both innate and adaptive immune responses, which result in faster clearance of pathogens and greater vaccine efficacy<sup>13</sup>. Conversely, testosterone has largely suppressive effects on immune function, which may explain the greater susceptibility to infectious diseases observed in men<sup>14</sup>. Notably, changes in sex hormone may further shape the immune response to pathogens<sup>14</sup>. Sex-related biological data may also be critical to investigate the contribution of sex hormones in inflammatory response. In particular, reduction in testosterone levels in aging men has been associated with increased proinflammatory cytokine levels<sup>14</sup> which may contribute to worse COVID-19 progression in older men. Sex differences in disease progression may also be linked to estrogen-induced decreased expression of angiotensin-converting enzyme 2<sup>15</sup>. Pre-print studies are conflicting as to whether ACE2 expression in lung tissue is different between sexes<sup>16,17</sup>. Some patients with COVID-19 pneumonia also present with kidney injury, and autopsy findings of patients who died from the illness sometimes show renal damage<sup>7</sup>. In meta-analysis study of Zhu j et al indicated that some patients with COVID 19 (25.5%) presented elevated levels of renal functions<sup>18</sup>. The results of current study indicated that all patients presented normal levels of renal functions. However on comparison of the results at entering with at recovery it was observed significant differences ( $p < 0.01$ ). Patients with abnormal liver tests were at increased risk

of progressing to severe disease. The detrimental effects on liver injury mainly related to certain medications used during hospitalization, and should be monitored and evaluated frequently<sup>18</sup>.

### Conclusion

Elevated levels of alanine aminotransferase (ALT) was observed in 10% and of aspartate aminotransferase (AST) was observed in 40% of patients with COVID 19, yet on comparison of the results at entering with at recovery it was observed significant differences ( $p < 0.01$ ) of all patients. As AST is not specific for liver damage, which indicated that the systemic inflammation induced by the virus might be responsible for these findings not related to certain medication.

**Conflict of Interest Statement:** All authors declare that they have no conflict of interest.

**Source of Funding:** Self

**Ethical Clearance:** Taken from Al-Furat general hospital-Iraq.

### References

- Huang C, Wang Y, Li X, Ren L, Zhao J, Hu Y, Zhang L, Fan G, Xu J, Gu X, Cheng Z, Yu T, Xia J, Wei Y, Wu W, Xie X, Yin W, Li H, Liu M, Xiao Y, Gao H, Guo L, Xie J, Wang G, Jiang R, Gao Z, Jin Q, Wang J, Cao B. Clinical features of patients infected with 2019 novel coronavirus in Wuhan, China. *Lancet*. 2020; 395:497–506.
- Chen N, Zhou M, Dong X, Qu J, Gong F, Han Y, et al. (2019), *Epidemiological and clinical*

- characteristics of 99 cases of novel coronavirus pneumonia in Wuhan, China: a descriptive study. *Lancet*. 2020;395:507–513.
3. Xinhua. China's CDC detects a large number of new coronaviruses in the South China seafood market in Wuhan.2020; Available at: [https://www.xinhuanet.com/2020-01/27/c\\_1125504355.htm](https://www.xinhuanet.com/2020-01/27/c_1125504355.htm).
  4. Liu J, Shu YL, and Zhou XN. Transmission patterns and control of COVID-19 epidemic. *Indian Journal of plant physiology* .2020; 9:112.
  5. Rothe Camilla, Schunk Mirjam, Sothmann Peter, Bretzel Gisela, Froeschl Guenter, Wallrauch Claudia, Zimmer Thorbjörn, Thiel Verena, Janke Christian, Guggemos Wolfgang, Seilmaier Michael, Drosten Christian, Vollmar Patrick, Zwirgmaier Katrin, Zange Sabine, Wölfel Roman, Hoelscher Michael. Transmission of 2019-nCoV Infection from an Asymptomatic Contact in Germany. *New England Journal of Medicine*. 2020;(10):970–971.
  6. Singhal T..A Review of Coronavirus Disease-2019 (COVID-19). *Indian J Pediatr*.2020; 87(4): 281–286.
  7. Guangchang Pei Zhiguo Zhang Jing Peng Liu Liu Chunxiu Zhang Chong Yu Zufu Ma Yi Huang Wei Liu Ying Yao Rui Zeng Gang Xu . (2020 Apr 28),Renal Involvement and Early Prognosis in Patients with COVID-19 Pneumonia. *J Am Soc Nephrol*. 2020; 31(6):1157-1165.
  8. Cai Q, Huang D, Yu H, Zhu Z, Xia Z, Su Y, Li Z, Zhou G, Gou J, Qu J, Sun Y, Liu Y, He Q, Chen J, Liu L, Xu L, Characteristics of Liver Tests in COVID-19 Patients, *Journal of Hepatology* .2020;April.
  9. Chau TN, Lee KC, Yao H, Tsang TY, Chow TC, Yeung YC, et al. . SARS-associated viral hepatitis caused by a novel coronavirus: report of three cases. *Hepatology*.2004; 39:302–310.
  10. Ozma MA, Maroufi P, Khodadadi E, Köse Ş, Esposito I, Ganbarov K, Dao S, Esposito S, Dal T, Zeinalzadeh E, Kafil HS. Clinical manifestation, diagnosis, prevention and control of SARS-CoV-2 (COVID-19) during the outbreak period. *Infez Med*. 2020;28(2):153-165.
  11. Humar A, McGilvray I, Phillips MJ, Levy GA. Severe acute respiratory syndrome and the liver. *Hepatology*.2004; 39: 291- 294.
  12. Chan HLY, Leung W-K, To K-F, et al. Retrospective analysis of liver function derangement in severe acute respiratory syndrome. *Am J Med*.2004; 116: 566- 567.
  13. Bartz D, Chitnis T, Kaiser UB, et al. (2020), Clinical advances in sex- and gender-informed medicine to improve the health of all: a review. *JAMA Intern Med*. [PMID: 32040165] doi:10.1001/jamainternmed.2019.7194GOOGLE SCHOLAR.
  14. Bianchi VE. . The anti-inflammatory effects of testosterone. *J Endocr Soc*.2019;3:91-107.
  15. La Vignera S, Cannarella R, Condorelli RA, et al. Sex-specific SARS-CoV-2 mortality: among hormone-modulated ACE2 expression, risk of venous thromboembolism and hypovitaminosis d. *Int J Mol Sci*.2020;21.
  16. Cai G. Bulk and single-cell transcriptomics identify tobacco-use disparity in lung gene expression of ACE2, the receptor of 2019-nCov. *MedRxiv*, published online .2020; February 02.
  17. Zhao Y, Zhao Z, Wang Y, Zhou Y, Ma Y, Zuo W. Single-cell RNA expression profiling of ACE2, the putative receptor of Wuhan 2019-nCov. *BioRxiv*, 2020; 26
  18. Jieyun Zhu, Pan Ji, Jielong Pang, Zhimei Zhong, Hongyuan Li, Cuiying He, Jianfeng Zhang, Chunling Zhao. Clinical Characteristics of 3062 COVID-19 Patients: A Meta-Analysis. *J Med Virol*. 2020; Apr 15 : 10.1002/jmv.25884.

# Implementation of Cross-Sectoral Collaboration in the Leptospirosis Control in Jeneponto Regency: A Qualitative Approach

Syamsuar Manyullei<sup>1</sup>, Muh. Fajaruiddin Natsir<sup>2</sup>, Wirdayanti<sup>3</sup>

<sup>1</sup>Assitant Professor at the Environmental Health Department, Public Health Faculty, Hasanuddin University, <sup>2</sup>Instructor at the Environmental Health Department, Public Health Faculty, Hasanuddin University, <sup>3</sup>Research Scholar at the Environmental Health Department, Public Health Faculty, Hasanuddin University

## Abstract

**Background:** Leptospirosis is an infectious disease caused by leptospira sp. and many are found in populations of people who live in rural areas. Leptospirosis is also a zoonotic disease that can be endemic and has adverse economic, social and psychological impacts. Zoonotic disease is closely related to human health, animals, and also the environment so that in controlling and preventing it is necessary to have the involvement or cooperation of various parties absolutely.

**Objectives:** This study aims to determine cross-sectoral partnership through coordination, communication, and collaboration in the context of controlling leptospirosis in Jeneponto Regency.

**Method:** This study is a qualitative study with a phenomenological design. The number of informants in this study were 14 people. Determination of informants obtained by purposive sampling by determining the criteria of informants who are willing to be interviewed and play an important role in controlling infectious diseases.

**Results:** The findings of this study showed that communication and collaboration during the control of infectious diseases such as leptospirosis in Jeneponto Regency had been carried out well through a workshop conducted by the *puskesmas* by inviting other sectors. However, there are obstacles when coordinating that health workers sometimes forget to coordinate with the sectors involved to secure the community. So that the sector is too late to take action when cases occur in the community.

**Conclusion:** Implementation of cross-sectoral collaboration in controlling leptospirosis has been carried out with good communication and collaboration.

**Suggestions:** Health workers need to improve their coordination with all sectors in Jeneponto in order to get better leptospirosis control.

**Keywords:** *Leptospirosis, Control, Cross-Sectoral, Jeneponto Regency.*

## Introduction

Leptospirosis is a zoonotic disease that is potentially fatal causing endemic in various regions of tropical climates and causing epidemics after heavy rains and floods. This infection results from direct or indirect exposure to infected animals carrying pathogens in their kidney tubules and releasing pathogenic leptospire through urine.<sup>1</sup> Leptospirosis is an incidental event

because the most common host is mouse.<sup>14</sup> Although many other animals can be used as hosts reservoir, but *Rattus norvegicus* is the most common source of human infection infected by leptospira bacteria.<sup>1</sup>

Leptospirosis is also commonly called Weil disease.<sup>2</sup> This disease is spread through urine or blood of animals infected with leptospira bacteria or attack humans through direct contact with water or soil that

has been contaminated with urine of animals carrying leptospira bacteria.<sup>3</sup> Risk factors in transmission of diseases transmitted by mice to humans is a factor in environmental conditions as rat habitat.<sup>4</sup>

The International Report of the Leptospirosis Society (ILS) states that Indonesia as one of the tropical countries with relatively high cases of leptospirosis deaths, ranging from 2.5% - 16.45% or 7.1% on average and including the third highest ranking in the world for mortality.<sup>2</sup> This can be seen in cases of deaths due to leptospirosis in 2015 - 2018 continues to increase. The highest mortality rate is in 2018 which is 148 deaths.<sup>5,6</sup>

Data on leptospirosis cases in South Sulawesi Province in 2016 - 2018 were not found.<sup>6</sup> However, if we look at the risk factors for leptospirosis transmission, namely the high rat population that has the potential to infect humans through leptospira bacteria, an intervention is needed to prevent the emergence of leptospirosis cases in the region. Based on the Minister of Health's Regulation Number 50 Year 2017 concerning Environmental Health Standard Quality Standards and Health Requirements for Vectors and Animal Disease Carriers and Control states that when the number of rats in the environment exceeds the quality standard value, it is necessary to control. The standard quality value for mice is <1.<sup>7</sup>

South Sulawesi Province has found two mice that were positive for leptospira bacteria from seven rat samples that had been examined. The results were obtained from study on the identification of the presence of leptospira serovar bacteria in rat blood serum at Sultan Hasanuddin International Airport.<sup>8</sup> Whereas areas in South Sulawesi that are at high risk of being contaminated by leptospira bacteria are caused by environmental aspects. The intended environmental aspects are the use of surface water sources and the physical quality of river water that does not meet health requirements.<sup>9</sup>

Based on information from Buludoang Community Health Center surveillance officers in Tuju Village, Bangkala Barat District, Jeneponto Regency in 2019, stated that from the tens of rats that had been examined, two rats were found positive for leptospira bacteria. One of the causes of the discovery of these bacteria is the condition of environmental sanitation that still does not meet health requirements. This can be seen from the achievement of the percentage of healthy

homes in 2016 of only 48.57%, and the percentage is categorized as the lowest percentage.<sup>10</sup> For this reason, an intervention is needed to overcome this problem in the form of health risk interventions. Health risk based interventions can be carried out through integration and synergy of activities across programs and across sectors. Cross-sectoral or other stakeholder cooperation is useful for overcoming the types of disease problems that involve complex interactions between humans, animals and the environment.<sup>11</sup> Cross-sectoral cooperation or other stakeholders are recommended to be useful for overcoming the types of disease problems that involve interactions complex between humans, animals and the environment.

Health risk-based interventions can be carried out through integration and synergy between cross-program and cross-sector activities. One health is a concept that involves three main elements, namely humans, animals and the environment. So that in the process of applying this concept, it needs to include multidisciplinary collaborations in science related to health, social, economics, human ecology, animal health and biology and environmental sciences.

The application of the concept of one health really requires a good communication, coordination and collaboration in controlling a disease. The importance of coordinated communication in the dissemination of information is the key to successful implementation of one health. In conveying information including standards and objectives of the policy requires the delivery of accurate information to the implementers and must be consistent from various sources of information. Communication within and between organizations is a complex and complicated process.<sup>18</sup>

Cross-sectoral cooperation in overcoming the problem of leptospirosis is very important to see the case of leptospirosis which is still a problem in Indonesia. That is because environmental sanitation that still does not meet health requirements is one of the risk factors for the presence of mice. The study objective of researchers is to find out how the implementation of cross-sectoral cooperation in the context of controlling leptospirosis in Jeneponto Regency. This study can also be used as a reference for stakeholders to collaborate more in controlling leptospirosis. For this reason, researchers are interested in studying the implementation of cross-sectoral cooperation in the context of controlling leptospirosis. The results of the study are expected

to provide useful information for cooperation in the prevention and control of leptospirosis, especially in Jeneponto Regency

### Method

This study was conducted on January 23 - 31, 2020 at Buludoang Health Center, Tuju Village, West Bangkala District, Jeneponto Regency. This study is a qualitative study with a phenomenological design. The number of informants in this study were 14 people consisting of stakeholders from the health sector and other sectors who played an important role in controlling leptospirosis. Determination of the informants obtained using purposive sampling method, where the informants obtained by determining certain criteria in accordance with the objectives of the study.

Data were collected by extracting data from various techniques and sources to clarify information in the field. This primary data was obtained by observation and in-depth interviews (indepth interview) and Focus Group Discussion (FGD). Data obtained from in-depth interviews and Focus Group Discussions (FGD) were carried out manually in accordance with the instructions for qualitative data processing, as well as in accordance with the objectives of this study. Furthermore, the data were analyzed by the thematic analysis method, and interpreted and presented in narrative form.

### Results

Based on information obtained from the results of in-depth interviews and Focus Group Discussion (FGD) on several informants regarding the implementation of cross-sectoral cooperation that has been carried out in Jeneponto District, it was found that the implementation of cross-sectoral cooperation by looking at coordination, communication, and collaboration in controlling infectious diseases (leptospirosis) is indispensable. Cross-sector implementation is needed when new events occur in the community. Based on study that has been done, the results obtained are that most informants said communication was important in cross-sectoral cooperation. This can be seen from the following in-depth interview from non-health sector informants:

*“Yes, important. Information is obtained from the bottom up or from the level of puskesmas to district. For example, the case of infectious disease that occurred yesterday we made communication so that cross-sector collaboration was effective like yesterday” (Mr1, 49)*

This answer was supported by the answers of other informants from the following health worker:

*“Yes ... very important. Because we cannot work individually. In cross-sectoral cooperation, each has a role and they move to influence society because we cannot do it alone. We work together so that communication is very important to be carried out in order to be successful in controlling disease” (HW1, 35)*

Whereas study that has been carried out regarding information feedback submitted by health workers in controlling infectious diseases was obtained that cross-sectoral responds well when cases occur. This is evidenced by the following in-depth interview interview from informants:

*“When I got the information that a case like this had happened, we immediately went down to help. For example, yesterday we were directly contacted by health workers to provide security to the public against cases that were happening” (Mr2, 44)*

This answer was reinforced by one of the following in-depth interview information from the health officer:

*“Yes they immediately respond ji and they immediately go down. We go down the field and they help” (HW3, 27)*

Based on study that has been done regarding communication barriers in cross-sectoral collaboration in Jeneponto District, it was found that there were no barriers to each informant interviewed. This is evidenced from the following in-depth interview with the health worker informant:

*“There are no obstacles during cross-sector collaboration” (HW5, 34)*

*“Obstacle is almost said to be non-existent, because my superiors immediately carry out instructions to all relevant sectors for handling. So all communication depends on the highest leadership. The highest leadership determines what to do” (HW4, 51)*

This answer was strengthened by the answer of one of the cross-sectoral informants during an in-depth interview. The following excerpts are related to communication barriers in cross-sectoral cooperation in Jeneponto Regency:

*“there are no obstacles and it has been running from a few years ago” (Mr5, 56)*

Based on study that has been done related to the importance of cross-sector collaboration it was found that the majority of informants considered collaboration important in cross-sectoral collaboration in Jeneponto Regency. This can be seen from the following Focus Group Discussion (FGD) informants from health workers:

*“Yes, important. It was related to cross-sector anyway. That all must come along. For example, from health alone, it can’t be. There must be cross-sectoral, such as from the sub-district office, the village head to move the community”* (HW5, 34)

This answer was supported by the answers of other health workers at the Focus Group Discussion (FGD) which said that cooperation could facilitate disease control. The following is an excerpt from the health worker informant’s answer:

*“They all work together in accordance with their respective main tasks. Cross-sectoral collaboration starting from villages, sub-district heads, and districts continues to collaborate so that controlling an illness is easy to do”* (HW4, 51)

*“We work together to control a disease. Especially cadres must always be diligent in monitoring the conditions that are happening in the community. All are responsible both the village head and the village head towards the community environment”*(HW9, 38)

The findings were obtained that there were no obstacles in coordination in cross-sectoral cooperation in Jeneponto Regency. The results are proven from the following excerpts from the answers of the health workers during an in-depth interview:

*“There are no obstacles in coordinating across these sectors because our communication has also been smooth so far”* (W6, 40)

The informants’ answers were strengthened by the answers from other sector’s informants during the FGD. The following is an excerpt from the informant’s answer:

*“No obstacle so far”* (Mr1, 49)

But rather than that, for this point one of the informants answered that there were obstacles in cross-sectoral coordination in Jeneponto Regency. This is evidenced from the excerpts from the informants’ answers during FGD as follow:

*“When there was a case yesterday, there was a problem in handling the community because of delays from the village security. We are also overwhelmed by social tasks”* (Mr5, 56)

These answers were reinforced by the following misinformation answers during in-depth interviews:

*“One obstacle that sometimes occurs is when he (health worker) does not coordinate with us who should contribute to protecting the community. Sometimes if something has happened and I just found out, then I will still be there to help to give direction to the community”* (Mr4, 37)

But rather than that, for this point one of the informants provided input during an in-depth interview that could be used as advice in the future, the informant said that

*“if you want to coordinate the road, one of them is to improve communication between fellow health workers and other sectors involved in control”* (HW5, 34)

The findings of study related to the implementation of cross-sector collaboration in Jeneponto can be seen from the quotation of the answer from one of the following health informants during an in-depth interview:

*“Maintaining the existing ones and if there is anything that needs to be improved, improve it, because it is very important to do it”* (HW4, 51)

The informant’s answer was strengthened by the answer of one of the informants during the FGD. The informant said that

*“Hopefully in the future every month cross-sector will be implemented. Because this cross-sector is only done every quarter. So hopefully it can be implemented every month”* (Mr1, 49)

Then for this point, the informant hopes to always confirm if a case occurs. This can be seen from the excerpts from the cross-sectoral informants’ answers during in-depth interviews. The informant said that:

*“I hope that in the future if something happens like this, please confirm with us”* (Mr4, 37)

## Discussion

Analysis of the data in this study can illustrate the implementation of cross-sectoral cooperation in

the context of controlling leptospirosis in Jeneponto Regency by observing communication, collaboration, and coordination between health workers and related sectors. Leptospirosis control in Jeneponto Regency does not have a special program in handling the disease, but it is associated with controlling infectious diseases. Leptospirosis control in Jeneponto Regency is only done when the results are found during an outbreak.

The direct effect between communication on the implementation of cross-sector collaboration was proven in the study of Hasibuan et al (2016) when analyzing the implementation of the Dengue Fever Disease Control (P2DBD) program in the Medan region. Even his study concluded that communication directly affected the implementation of the P2DBD program. So in line with that, several things make it clear that communication in cross-sectoral collaboration in Jeneponto Regency is the holding of a workshop every three months conducted by the puskesmas by inviting other sectors. With the frequent implementation of the community service program related to problems that are occurring in the community environment, all program implementers understand the purpose, instructions, and series of activities in controlling leptospirosis. Based on the results of in-depth interviews and FGDs from several informants it was found that collaboration in controlling infectious diseases has been established. This is indicated by the statements of several informants about the importance of cross-sector collaboration. The informant considers that when collaboration does not work well, problems that are happening in the community will be difficult to solve. This is in line with the main principles of collaboration, namely the transparency of the process and the involvement of all stakeholders in making a policy. The aspect of collaboration is dialogue, building commitment, goals, and mutual agreement.

Cross-sector involvement in controlling leptospirosis is one of the ways that must be properly maintained and improved. Sectors involved in controlling leptospirosis are the Ministry of Health who plays a role in interventions related to public health and the Ministry of Agriculture that is needed in efforts to control animals or reservoirs carrying disease. In this case, rats are the main reservoir for leptospirosis transmission. However, in this study the researchers did not include the Agriculture Service as an informant because it did not meet the criteria determined by the researcher, namely the presence in the FGD.

Early diagnosis of leptospirosis is needed to reduce the number of patients dying. Health workers in each

region need to have a good ability to recognize the epidemiology of leptospirosis in order to be able to make early detection, management and appropriate prevention method to deal with the incidence of leptospirosis around them. Control of leptospirosis also cannot be completed by the health sector but collaboration and coordination between sectors is needed.<sup>19</sup>

Good coordination must be based on cooperation (between the central government, between the central and regional governments, and between regional governments) and mutual understanding by promoting the spirit of equality. So that in carrying out the tasks to deal with Extraordinary Events (EE) or zoonotic diseases are encouraged to optimize the utilization of resources in their respective institutions and encourage integration. Coordination will run continuously if there is mutual trust between institutions and always maintain the trust that has grown. Trust will grow if the commitment to the agreed duties and responsibilities. With the commitment, consistency, and professional in carrying out the tasks, the integrity of the 'group' coordination will go well.<sup>12</sup> Based on the results of study conducted at the Buludoang Health Center, Tuju Village, West Bangkala District, Jeneponto Regency, it was found that coordination of health informants and other sectors has been carried out. Cross-sectoral and cross-program coordination such as village heads and community leaders who play an active role in mobilizing the community and its members in controlling leptospirosis. For example, each puskesmas activity must have permission from the regional stakeholders, because the regional stakeholders act as the owner of the area for licensing in every activity that will be carried out by the Puskesmas or the Health Office. The puskesmas cooperates with cadres who function as a channel of information between the puskesmas and the general public.<sup>13</sup>

Based on the results of this study, the informant began to understand the importance of coordination in controlling infectious diseases in the community. Cross sector involvement in controlling leptospirosis is carried out through monitoring by the District Health Office as the highest holder in decision making related to efforts to implement leptospirosis control in the region. In this study, the informant also explained that coordination is indeed needed by humans or organizations to achieve the goals together.

The results of the study explained that in carrying out cross-sectoral collaboration, stakeholders have



been given their respective responsibilities to carry out their respective tasks and functions. Some informants explained that in coordinating with other sectors in handling a case a whatsapp group was made to facilitate communication so that coordination was carried out well. So that in controlling leptospirosis or other diseases that are endemic in the community environment can be resolved quickly and accurately.

### Conclusions

Based on the results of study that has been carried out on the implementation of cross-sectoral cooperation in the context of controlling leptospirosis in Jeneponto Regency, the researcher draws the conclusion that cross-sectoral collaboration that has been carried out so far still needs to be improved. Considering the results of in-depth interviews that have been conducted, the informant said that coordination in cross-sectoral cooperation still needs to be well coordinated with the sectors that should be involved in disease control. However, this information is different from the answers of the informants in the FGD which said that the coordination that had been carried out so far needed to be maintained, bearing in mind that the handling of cases that had occurred in Jeneponto Regency had been well coordinated by the sectors involved in the control. It is suggested for stakeholders to improve coordination by always conducting cross-sector workshops every month to evaluate the results of work that has been carried out and the things that need to be improved through coordination.

**Ethical Clearance:** The study obtained ethics approval from the Health Research Ethics Committee of Public Health Faculty, Hasanuddin University.

**Source of Funding:** Self-funded.

**Conflict of Interest:** All authors have no conflict of interest in this study.

### References

- Adler, B. *Leptospira and Leptospirosis*, in: Springer, p. 2014.
- Situmorang, P. R. Gambaran pengetahuan masyarakat tentang leptospirosis di lingkungan II kelurahan pekan labuhan kecamatan medan labuhan, *Jurnal Ilmiah Keperawatan IMELDA*. 2017: 3(2), pp. 315 - 323.
- Maiyulis, Syahrizal, M. and Munthe, P. G. *Sistem Pakar Mendiagnosa Penyakit Leptospirosis Menerapkan Metode Rule Base Reasoning*, Informasi dan Teknologi Ilmiah (INTI). 2018: 13(1), pp. 34 – 39.
- Ikawati, B., Sulistiyani and Nurjazuli. Analisis Karakteristik Lingkungan Pada Kejadian Leptospirosis di Kabupaten Demak Jawa Tengah Tahun 2009, *Media Kesehatan Masyarakat Indonesia*. 2009: 8(2), pp. 39–45. doi: 10.14710/mkmi.9.1.33 - 40.
- Kementerian Kesehatan Republik Indonesia. *Petunjuk Teknik Pengendalian Leptospirosis*. DirektoratJendral Pengendalian Penyakit dan Penyehatan Lingkungan Kementerian Kesehatan Republik Indonesia. Jakarta. 2017.
- Kementerian Kesehatan Republik Indonesia. *Profil Kesehatan Indonesia 2017*. Direktorat Jendral Pengendalian Penyakit dan Penyehatan Lingkungan Kementerian Kesehatan Republik Indonesia. Jakarta. 2018.
- Kemenkes, RI. *Peraturan Menteri Kesehatan Republik Indonesia Nomor 50 Tahun 2017 Tentang Standar Baku Mutu Kesehatan Lingkungan dan Persyaratan Kesehatan Untuk Vektor dan Binatang Pembawa Penyakit Serta Pengendaliannya*, Menteri Kesehatan Republik Indonesia Peraturan Menteri Kesehatan Republik Indonesia. 2017.
- Andis, A.M. Identifikasi Keberadaan Serovar Bakteri *Leptospira* pada Serum Darah Tikus di Bandar Udara Internasional Sultan Hasanuddin Menggunakan Metode Microscopic Agglutination Test (MAT). Skripsi. Departemen Kesehatan Lingkungan Fakultas Kesehatan Masyarakat Universitas Hasanuddin. 2018.
- Syamsuar. et al. Environmental Health Risk Assessment in Flood Prone Area; Case Study in Wajo District, *International Journal of Science and Healthcare Research*. 2018: 3(4),pp. 9 - 16.
- Depkes. *Profil Kesehatan Provinsi Sulawesi Selatan Tahun 2016*. Makassar. 2017.
- Cleaveland, S. et al. One Health contributions towards more effective and equitable approaches to health in low- and middle-income countries, *Jurnal The Royal Society*. 2017: 372(1), pp. 1 - 11.
- Kementerian Koordinator Bidang Pembangunan Manusia dan Kebudayaan. *Pedoman Koordinasi Lintas Sektor (Menghadapi Kejadian Luar Biasa (KLB)/Wabah Zoonosis dan Penyakit Infeksi Emerging (PIE)*. Jakarta. 2018.

13. Wati, M. S., Mateus, S. A., & Lintang, D. S. Jenis Upaya, Sarana Prasarana, dan Keterlibatan Instansidalam Pengendalian Faktor Risiko Leptospirosis di Kota Semarang, *Jurnal Kesehatan Masyarakat (e-Journal)*. 2017: 5(2), 2356 – 3346.
14. Pasaribu, A. O., Mesran and Hasan, Y. Sistem Pakar Mendiagnosa Penyakit Kaki Gajah Menggunakan Metode Certainty Factor, *Jurasik (Jurnal Riset Sistem Informasi dan Teknik Informatika)*. 2018: 17(4), pp. 375 - 381.
15. Cleaveland, S. et al. One Health contributions towards more effective and equitable approaches to health in low- and middle-income countries, *Jurnal The Royal Society*. 2017: 372(1), pp. 1 –
16. Direktur Jenderal Pengendalian Penyakit dan Penyehatan Lingkungan. 2015. Rencana Aksi Program Pengendalian Penyakit dan Penyehatan Lingkungan Tahun 2015 – 2019.
17. Agungpriyono, S., Purnawarman, T. and Suprayogi, A. Pengembangan Kompetensi Utama One Health (One Health Core Competency, OHCC) Dalam Kurikulum Pendidikan Kedokteran Hewan, *Jurnal Palembang*, 2014: 1(1), pp. 169 - 171.
18. Munggaran, G.A., Gambaran Implementasi Kebijakan Pengendalian Demam Berdarah Dengue (DBD) Melalui Program Gerakan 1 Rumah 1 Jumantik di Puskesmas Kelurahan Benda Baru Kota Tangerang Selatan Tahun 2017. Skripsi. Universitas Islam Negeri Syarif Hidayatullah Jakarta. 2018.
19. Pujyanti, A. dkk., 2019. Pengetahuan Petugas Kesehatan dan Lintas Sektor Tentang Leptospirosis di Kabupaten Pati, *Vektora*, 11(1), pp. 39 - 46.

# Impact of Quality of Healthcare Services on Consumer's Satisfaction at Primary Healthcare Centers

Tariq Yassen Taha<sup>1</sup>, Wissam Jabbar Qassim<sup>2</sup>

<sup>1</sup>PhD(c), Research Scholar, University of Baghdad, College of Nursing, <sup>2</sup>Assistant Professor (PhD), University of Baghdad, College of Nursing, Community Health Nursing Department

## Abstract

**Background:** Current trend in quality healthcare services is to work toward providing 'people-centered', healthcare that puts the consumers at the center in the health delivery system. This study aims to determine the level of quality of healthcare services in primary healthcare centers.

**Method:** The study included a simple random sample of (180) health and medical care providers in primary healthcare centers in Baghdad City by (5-8) healthcare providers for each center.

The study results showed that the general evaluation of the quality of primary healthcare services is highly efficient and that the result has a significant impact on the beneficiaries' satisfaction.

**Conclusion:** The researchers concluded that the primary healthcare centers are not commensurate with the increasing population density, and the lack of an ambulance in most of the primary healthcare centers. Furthermore, the level of confidence in our health institutions regarding service efficiency indicates a high level.

**Keywords:** *Quality of Healthcare Services; Consumer's Satisfaction; Primary Healthcare Centers.*

## Introduction

Current trend in quality healthcare services is to work toward providing 'people-centered', healthcare that puts the consumers at the center in the health delivery system. This means that consumers' views and evaluation of services provided are critical in providing feedback for improving the quality of care provided<sup>(1)</sup>. Quality is directly connected with meeting requirements, expectations, and needs of customers. Whether a service will be reused also depends on adequate quality, especially nowadays, when production processes are of approximate and high quality. In such conditions, proper and perfect execution of logistics services can have

a crucial impact on its reuse. It is important to strive constantly for higher goals and their achievements. It requires also an adequate methodology that can help improve the quality measurement of logistics services<sup>(2)</sup>.

Service quality is generally finding of services given to consumers. It depends on the customer judgment. The comparison of expectations next and previous used services is the result of service quality and identifies procedure of the service transfer is known service quality perception<sup>(1)</sup>.

It is also service quality dimension until SERVQUAL (service quality) model; measures do not contemplate it as. Extensive perspective, human perspectives and its origination also service quality measures as these restrictions<sup>(3)</sup>.

---

## Corresponding Author:

**Tariq Yassen Taha**

PhD(c), Research Scholar, University of Baghdad,  
College of Nursing  
e-mail: tareq\_alrubeiy@yahoo.com

## Method

A descriptive study was conducted at Primary Healthcare in Baghdad City from January 13<sup>th</sup>, to March

5<sup>th</sup>, 2019. The study included a simple random sample of (180) healthcare providers in primary healthcare centers in Baghdad City (5-8) healthcare providers for each center using a questionnaire for the quality of services and using the method of distributing questionnaires to the various specialties working in the health center, these centers are distributed into (2) sides and divided into (8) health sectors according to ministry of health directorate of primary healthcare. A total of (28) primary healthcare centers are selected for the purpose of the study.

The data collection starts with providers primary healthcare services in primary healthcare centers in Baghdad City using a questionnaire and the interview technique as means of data collection.

The reliability of the questionnaire was determined through a pilot study and the validity are achieved through a panel of (17) experts. A pilot study included a convenient sample of (17) provider were selected among persons concerned with primary healthcare centers.

## Results and Discussion

**Table 1. Overall evaluation of healthcare system and structure (N=28)**

Evaluation	f	%	M.S	SD
Inefficient	0	0	2.79	0.418
Efficient	6	21.4		
Highly efficient	22	78.6		
<b>Total</b>	<b>28</b>	<b>100</b>		

f: Frequency, %: Percentage, M.S: Mean of score, SD: Standard Deviation  
Inefficient= 0-8, Efficient= 9-17, Highly efficient= 18-26

More of centers are highly efficient (78.6%) and (21.4%) are showing efficient system and structure.

**Table 2. Caregivers personal characteristics (N=180)**

No.		f	%	$\chi^2$	df	p-value (Sig)
1	<b>Age</b>			5.213	8	.735 (N.S)
	20 – 29 years	16	8.9			
	30 – 39 years	43	23.9			
	40 – 49 years	49	27.2			
	50 – 59 years	63	35			
	60 ≤ years	9	5			
	<b>Total</b>	<b>180</b>	<b>100</b>			
2	<b>Gender</b>			2.159	2	.340 (N.S)
	Male	83	46.1			
	Female	97	53.9			
	<b>Total</b>	<b>180</b>	<b>100</b>			
3	<b>Level of education</b>			4.132	8	.845 (N.S)
	Secondary school	15	8.3			
	Diploma	61	33.9			
	Bachelor	87	48.3			
	Master	6	3.3			
	Doctorate	11	6.1			
	<b>Total</b>	<b>180</b>	<b>100</b>			

No.		f	%	$\chi^2$	df	p-value (Sig)		
4	<b>Speciality</b>							
	Physician	71	39.4	20.151	14	.125 (N.S)		
	Nurse	41	22.9					
	Radial photographer	15	8.3					
	Biologist	15	8.3					
	Chemist	3	1.7					
	Pharmacist	11	6.1					
	Medical technician	22	12.2					
	Vital statistician	2	1.1					
	<b>Total</b>	<b>180</b>	<b>100</b>					
5	<b>Years of service</b>						2.960	8
	≤ 5 years	13	7.2					
	6 – 10 years	26	14.4					
	11 – 15 years	30	16.7					
	16 – 20 years	29	16.1					
	21 ≤ years	82	45.6					
	<b>Total</b>	<b>180</b>	<b>100</b>					

No: Number, f: Frequency, %: Percentage,  $\chi^2$ = Chi-square, df: degree of freedom, p-Value: probability value, Sig: Significance, N.S: Not significant

More than a third of healthcaregivers age 50-59-years (35%), more than a half are females (53.9%), less than a half hold a bachelor's degree (48.3%) and diploma (33.9%). It has known of specialty variable that (39.4%) were physicians, (22.9%) nurses, and the remaining percentage was distributed on other specialties such

as: radial photographer, biologist, chemist, pharmacist, medical technician, and vital statistician. Those healthcaregivers are reported that they are working for more than 21-years at the primary healthcare (45.6%) as years of experience.

**Table 3. Evaluation the tangibility of primary healthcare services at primary healthcare centers (N=180)**

List	Tangibility items	M.S	Evaluation
1	The health center needs to appliances, medical equipment and supplies used currently occur.	2.53	High
2	You believe that the nature of galleries and places waiting of the consumers', the doctors' offices and the current employees fit with what you expect in your mind.	1.92	Moderate
3	There is interest by the health center management and employees in a manner and body work clothes commensurate with the level of service provided.	2.60	High
4	You believe that the management of the health center provided the material requirements within the available capabilities and commensurate with your mental expectations for it.	2.51	High
<b>Total</b>		<b>2.39</b>	<b>High</b>

M.S: Mean of score, Low= 1 -1.66, Moderate= 1.67-2.33, High= 2.34-3

Primary healthcare centers having high tangibility (M.S= 2.39) as seen in scores of mean that associated with all items except the item (2) that refer to moderate.

That mean most of healthcare centers are having enough equipment and supplies in addition to the appropriate staff that fit to mission of these centers.

**Table 4. Evaluation the reliability of primary healthcare services at primary healthcare centers (N=180)**

List	Reliability items	M.S	Evaluation
1	The Health Center's management is 9 committed to ensuring that patients and consumers' provide health and therapeutic services and provide the appropriate environment as you would expect in your mind.	2.65	High
2	The health center management sympathizes with patients and consumers' when submitting complaints as you expect them	2.82	High
3	The health center management is seen to provide services on time, in a fast and accurate manner.	2.77	High
4	Patients and consumer's place their trust in the medical and health professional skills with confidence and safety.	2.66	High
5	The health center's management is seen to record information about patients and consumer's and their health status in records and computers.	2.76	High
<b>Total</b>		<b>2.73</b>	<b>High</b>

M.S: Mean of score, Low= 1 -1.66, Moderate= 1.67-2.33, High= 2.34-3

Primary healthcare centers are high reliable (M.S= 2.73), the mean of scores is showing high in all items that indicate a good quality of services related to reliability that represented by: primary healthcare centers are providing a therapeutic and appropriate environment

for their consumers, responding to any complaints that committed to centers, providing a services in accurate time and manner, keep that trust between the consumers and staff, and working with documentation of information regarding the consumers.

**Table 5. Evaluation the responsiveness of primary healthcare services at primary healthcare centers (N=180)**

List	Responsiveness items	M.S	Evaluation
1	It is telling patients and consumer's for times the provision of health, medical and therapeutic service to them according to your perception.	2.74	High
2	It is not expected to get patient's and consumer's on the online service by the staff at the health center.	1.98	Moderate
3	The health center staff wants to help patients and visitors permanently.	2.82	High
4	Despite the busy staff to provide services, but they respond with patients and consumer's requests immediately.	2.82	High
<b>Total</b>		<b>2.59</b>	<b>High</b>

M.S: Mean of score, Low= 1 -1.66, Moderate= 1.67-2.33, High= 2.34-3

Primary healthcare centers are showing high responsiveness (M.S= 2.59) as seen in scores of mean that associated with all items except the item (2) that refer to moderate. That mean most of healthcare centers

are working on telling the consumers the time of service availability, providing the expected services that meet for consumers' perception, and responding to consumers' requests immediately.

**Table 6. Evaluation the assurance of primary healthcare services at primary healthcare centers (N=180)**

List	Assurance items	M.S	Evaluation
1	In your opinion, patients and consumer's should have full confidence in the health center staff.	2.85	High
2	In your opinion, you should reassure the patient and the consumer's that he is in good hands with the staff at the health center when dealing.	2.94	High
3	Do you feel that the medical and health staff and staff interact with patients and consumer's and treat them gently and tactfully.	2.74	High
4	The staff of the health center have the competence, the Courteous and the credibility to perform their work, which necessitates the management of the health center to provide support to these workers.	2.74	High
<b>Total</b>		<b>2.82</b>	<b>High</b>

M.S: Mean of score, Low= 1 -1.66, Moderate= 1.67-2.33, High= 2.34-3

Primary healthcare centers are providing high assurance (M.S= 2.82), the mean of scores is showing high in all items that indicate a good quality of services related to assurance that represented by the opinion of healthcare providers about the mission and vision of the primary healthcare that working in, it has known of findings that high confidence and opinion are expressed about the work of primary healthcare services.

### Discussion

The evaluation of the structure of elements and systems in primary healthcare centers, with an average of more than 75% of the total item as good average scores in more elements. It reflects the availability of standard criteria for the system and the structure represented and device availability, complaints boxes, and wheelchair availability.

These results are consistent with the findings of<sup>(4)</sup> who indicated that all of the above are available in 85% of primary Healthcare centers.

The Environmental Protection Agency(EPA) requirement for medical waste disposal are for waste to be segregated into categories of, sharps, toxic, hazardous, regulated or infectious fluids of greater than 20 ml. and other materials. Although incineration has long been recognized as an efficient method for disposing safely of sharps and other contaminated medical waste<sup>(5)</sup>.

While, the coverage area of the population through the services of the healthcare center, two primary healthcare centers provide healthcare services to less than (20,000) consumers. While, 26 primary healthcare centers of these coverage are equal to or more than (20,000). These results show that all primary healthcare

centers have violated international standards (2-3 per 10,000) (Ministry of Health) regarding their coverage. This may be due to the difference in population size between the health sectors in Baghdad. Community health can be affected by the size of the population, so knowing the size of the community provides community health workers with important planning information<sup>(5)</sup>.

Concerning the presence of an ambulance in the primary healthcare centers, the results indicate that more than (89%) of the primary healthcare centers do not have an ambulance, and these results are consistent with that of<sup>(6)</sup> who stated that the availability of an ambulance in primary healthcare centers at (17%), and these results do not comply with international standards in the quality of primary healthcare services.

Regarding the evaluation of tangibility in the field of quality of healthcare services, the results indicate that primary healthcare centers with high tangibility as seen in mean of scores that associated with all items except the item (2) that refer to moderate. That mean most of healthcare centers are having enough equipment and supplies in addition to the appropriate staff that fit to mission of these centers.

The results are consistent with a study conducted by (7) (2012) in Iran who concluded that the tangibility dimension in the quality of primary healthcare centers services was high, and that is consistent with the good reputation and excellence that the care system craves Primary health in Iran, where reached.

The tangibility dimension indicates the appearance of the facilities, physical and human equipment at the health service delivery site with respect to (22) regarding the tangibility of the services in terms of availability of

equipment and materials Means of education and the outward appearance of workers <sup>(8)</sup>.

Regarding the reliability evaluation in the quality of healthcare services, the results revealed that primary healthcare centers are highly reliability, the average score appears in all elements indicating good quality of the services related to the reliability it represents: primary healthcare centers are providing a therapeutic and appropriate environment for their consumers, responding to any complaints that committed to centers, providing a services in accurate time and manner, keep that trust between the consumers and staff, and working with documentation of information regarding the consumers. This corresponds to the good reputation of our health institutions for their services to make the level of high trust and applies to international standards to service quality.

This result is consistent with that of <sup>(9)</sup>who indicated the positive effect of the application of reliability dimension in the evaluation of primary healthcare providers in healthcare centers.

Whereas, reliability means the ability to provide services on time and with the required accuracy, the extent of fulfillment of obligations, and the performance of health services promised by beneficiaries. It also includes adherence to the deadlines set for beneficiaries (patients) as well as seeking to preserve their files and documents from damage and loss <sup>(10)</sup>.

For the responsiveness and the quality of healthcare services, the results indicate that the primary healthcare centers show a high response as they appear in the average scores associated with all elements except for item (2) that indicates moderate. This means that most healthcare centers inform consumers when the service is available, and provide expected services that meet consumers' perceptions, and respond to consumer demands immediately, and this is felt in the tangibility analysis table, With this result, can say that the primary healthcare centers implement international standards of quality of services at a high level with regard to the responsiveness dimension. These results are consistent with the study of <sup>(11)</sup> whostated that the response was high.

Concerning the responsiveness that is the ability and desire of the health center provider services to the beneficiaries at the time and meet <sup>(12)</sup> to provide them appropriate to the current, future and urgent needs of

patients through flexibility in procedures and means of providing services <sup>(13)</sup>. and willingness and permanent desire to provide services to patients when they need them <sup>(14)</sup>.

Regarding the assurance evaluation and the quality of healthcare services; the results showed that primary healthcare centers offer a high assurance, the average score appears in all elements indicating good quality of services related to assertion represented in the opinion of healthcare providers in Mission and vision for primary healthcare that you work in.

These results are consistent with a study conducted in United Kingdom by (20). The levels of awareness of both patients and staff on the levels of application of the dimensions of the quality of services provided in outpatient clinics and healthcare centers. The study concluded that the evaluation of workers and patients' quality dimension application levels were high for the assurance dimension.

Regarding the meaning of assurance, it means the quality of information and the policy of those responsible for providing services and their policy, and their ability to inspire confidence and respond to patient and customer inquiries. It also indicates the confidence of patients in the health center staff, and the ability of those responsible for managing the health center to provide safety and security at the place of service <sup>(15)</sup>.

Primary healthcare centers showed a high degree of empathy and mean the average scores in all items that indicate a good quality of services related to empathy, which is: giving health services with appropriate attention to consumers, and providing health according to the needs of consumers, The evaluation of empathy to this high degree It does not come out of the void, but thanks to the concerted efforts of primary healthcare providers, it gave an important impression to auditors and reached international standards for quality of services.

The results of this dimension are consistent with that of <sup>(16)</sup>in Sao Paulo, and the features that have reached the highest levels of satisfaction are compatible with the education and commitment of the medical and nursing staff, interpretations and instructions on the user's health problem, respect for privacy and guidance for continuing care after discharge from the hospital. Empathy were the dimension that affected satisfaction, as they demonstrated a high degree of empathy.



Referring to the sympathy dimension as it includes many variables that include the interest and care of workers who benefit from the services personally, and understanding and realizing their needs and the appropriateness of working hours and providing services in a way that suits the desires patients<sup>(17)</sup>.

**Conflict of Interest:** The researchers confirm that there is no any conflict of interest.

**Source of Funding:** This study is self-funded.

**Ethical Clearance:** The researchers obtained the ethical approval from the University of Baghdad, College of Nursing.

### Conclusion

1. Primary healthcare centers whose numbers are not commensurate with the increasing population density, as the number of people included in the geographical area exceeds 20,000 for the main health center, and this violates the international standards for the quality of services, which stipulates that no more than 10,000 people.
2. The level of confidence in our health institutions regarding service efficiency indicates a high level, and this is high consistent with international standards for service quality.
3. An indication the evaluation of the healthcare system and structure in the primary healthcare centers, that the Criteria of the existence of a lecture hall at the health center, the evaluation (fair).

### Recommendations:

#### There is a need to:

1. Increase the number of primary healthcare centers to fit the increasing population so that it does not exceed 10,000 people until it conforms to international standards for the quality of services.
2. Provide all primary healthcare centers with an ambulance to transport patients and critical cases to the nearest hospital.
3. Maintain the high level of confidence in our health institutions by developing the health sector with all new scientific and material capabilities to enhance the level of workers in primary healthcare centers to ensure the continued quality of healthcare services.

### References

1. Walsh M, Walsh A. Measuring patient satisfaction

- with nursing care: experience of using the Newcastle Satisfaction with Nursing Scale. *Journal of Advanced Nursing (Wiley-Blackwell)* [Internet]. 1999 Feb [cited 2020 Aug 31];29(2):307–15. Available from: <https://search-ebSCOhost-com.ezproxy.okcu.edu/login.aspx?direct=true & db=ccm & AN=5866779 & site=ehost-live>
2. Nowotarski P, Pasławski J, Kadler A. Quality management systems as a key element for company strategy selection—Case study. *MATEC Web Conf.* 2018, 222, 01012.
3. Kaura, Vinita Pasławski J, and Kadler A. Service quality, service convenience, price and fairness, customer loyalty, and the mediating role of customer satisfaction. *International Journal of Bank Marketing* 33 (2015): 404-422.
4. Al-Miahi, N. Determination of quality assurance for maternal and child- health services in Baghdad City. Master Thesis, University of Baghdad, College of Nursing, 2010, 90.
5. Alwan Q. Total quality management and ISO 2000,9001 requirements, Amman, Dar Al Thaqafa Publishing, 2005.
6. Allender A. & Spradley W. Community health nursing promoting and protecting the public's health, 6th ed. Philadelphia: Lippincott Williams and Wilkins, 2005, 596, 599, 602, 608, 611, 614-617.
7. Al-Khudairi J. Evaluation of primary healthcare system as a prerequisite for Iraqi health system reform. PHD Dissertation, Al-Mustaniriya University, College of Medicine, Community Medicine, 2005, 123, 141.
8. Zarei A, Arab M, Froushani AR, Rashidian A, Ghazi Tabatabaei SM. Service quality of private hospitals: the Iranian patients' perspective. *BMC Health Services Research* [Internet]. 2012 Jan [cited 2020 Aug 29];12(1):31. Available from: <https://search-ebSCOhost-com.ezproxy.okcu.edu/login.aspx?direct=true & db=ccm & AN=104492433 & site=ehost-live>
9. Kossman M. Delivering excellent service quality in aviation: A practical guide for internal and external service providers. England: Ashgate Publishing Limited, 2006.
10. Yaacob M, Zakaria Z, Salamat A, Yaacob, Z, Salmi, N, Hasan N, Razak R, and Rahim S. Patients satisfaction towards service quality in public

- hospital: Malaysia perspective. *Interdisciplinary Journal of Contemporary Research in Business*, 2(12): 2011, 635-640.
11. Kuhn, K.; Warren, J. and Leong, T. *Building sustainable health systems*, 2nd ed. United Kingdom: Gazella Books Services, 2007.
  12. Anbori A. Client's satisfaction of healthcare services in Iraq: The study and analysis of the views of clients in Baghdad City, quality management and client's satisfaction, *Iraqi Institute for Economic Reform Journal*, 2(10),2011, 13-17.
  13. Creveling C, Slutsky J. and Antis D. *Design for six sigma in technology and product development*. New Jersey: Prentice Hall, 2003.
  14. Verma H. *Services Marketing: Text and Cases*, 2/e. New Delhi: Person Education in South Asia, 2012.
  15. Murray C. & Evans D. *Health Systems performance assessment: Debates, method and empiricism*. Geneva: World Health Organization, 2003.
  16. Alwan, Q. *Total quality management and ISO 2000,9001 requirements*. Amman, Dar Al Thaqafa Publishing, 2005.
  17. Cruz WBS, & Melleiro MM. Assessment levels of the user's satisfaction in a private hospital. *Rev Esc Enferm USP*, 44(1):2010, 147-53.
  18. Parasuraman A, Zeithaml VA. and Berry LL. SERVQUAL: A multi-item scale for measuring consumer perceptions of the service quality, *Journal of Retailing*, 64(1), 1988, 12- 40.

# The Relationship between Adolescent Risk Behavior in Drug Abuse: *A Literature Review*

Ahmad Yani<sup>1</sup>, Sukri Palutturi<sup>2</sup>, Ridwan Amiruddin<sup>3</sup>, Sudirman Nasir<sup>4</sup>,  
Aminuddin Syam<sup>5</sup>, Rajindra<sup>6</sup>, Anto J. Hadi<sup>7</sup>

<sup>1</sup>Doctoral Student, Faculty of Public Health, Hasanuddin University, Indonesia, <sup>1</sup>Lecturer, Faculty of Public Health, Universitas Muhammadiyah Palu, Indonesia, <sup>2</sup>Professor, Department of Health Policy and Administration, Faculty of Public Health, Universitas Hasanuddin, Indonesia, <sup>3</sup>Professor, Department of Epidemiology, Faculty of Public Health, Hasanuddin University, Indonesia, <sup>4</sup>Senior Lecturer, Department of Health Promotion, Faculty of Public Health, Hasanuddin University, Indonesia, <sup>5</sup>Senior Lecturer, Department of Nutrition Science, Faculty of Public Health, Hasanuddin University, Makassar, <sup>6</sup>Senior Lecturer, Departemen of Management, Faculty of Economics, Universitas Muhammadiyah Palu, <sup>7</sup>Senior Lecturer, Departemen of Nutrition Science, Faculty of Public Health, Universitas Aupa Royhan, Padangsidempuan, Indonesia

## Abstract

This review aimed to explore the relationship between risk behaviors and drug abuse in adolescents. This review was reported according to PRISMA guidelines (Selected Reporting Items for Systematic Review). A review protocol was developed to identify all articles published investigating the relationship between Adolescent Risk Behavior and Drug Abuse. Relationship between risk behavior and drug abuse among adolescents; some studies measured the risk behaviors of adolescent drug users. Other studies intervened to prevent risk behaviors in adolescents related to drug abuse. At the same time, some studies found no significant relationship between drug-related behavior and drug abuse. Limitations on methodology are significant in organizing the literature to see connections. This review concludes that all deviant behavior is highly risky for adolescent health. Attitudes toward risk behavior refer to adolescents' perception of vulnerability to the possible negative consequences of unsafe behavior.

**Keywords:** Risk Behavior; Drug Abuse; systematic literature review; Adolescents.

## Introduction

Given the high prevalence of drug abuse among adolescents<sup>(1,2)</sup>, many studies support to prevent risky behavior of adolescents in preventing risky behavior in drug abuse<sup>(3-7)</sup>. Depression and school environment factors most influence drug users among adolescents. In contrast, psychological and peer environment factors become pivotal domains to be targeted in programs to prevent drug use in adolescents.<sup>(8-12)</sup> Targeting

adolescents is crucial because early on, they can build their intention not to behave riskily about drug abuse<sup>(13,14)</sup>. The role of family, peers, school, and community is very supportive in preventing risky behavior in adolescents. Risk behavior prevention programs that target early teens in social contexts can also equip their knowledge and skills to avoid risky behavior. In this way, adolescents may need a more integrated approach to prevention that targets various adolescent life settings from multiple forms of risk behavior.<sup>(15)</sup>

Risk behavior is controlled intentionally or unintentionally to the perceived uncertainty about how the results will be in the future. Risk-taking behavior can be said to be voluntary behavior that is not socially acceptable with potentially harmful effects because precautions are not taken, such as drug abuse<sup>(16)</sup>. In Theory of Planned Behavior that a positive attitude

---

### Corresponding Author:

**Ahmad Yani**

Doctoral Student, Faculty of Public Health, Hasanuddin University, Indonesia

e-mail: ahmadyani.publichealth@gmail.com

that needs to be fostered through the perspective of perception of behavioral control to produce intentions in positive behavior, in this case, prevents him from using drugs (Ajzen, 1991).

This study focuses on adolescents aged less than 20 years as subjects in this study. Various damage caused to adolescents who consume drugs, not only physical but mental, social, their future is at stake. For this reason, this review aimed to explore the relationship between risk behaviors towards drug abuse in adolescents.

## Method

This review was reported according to PRISMA guidelines (<http://www.prisma-statement.org>) Selected Reporting Items for Systematic Review). A review protocol was developed to identify all articles published that investigate the relationship between Adolescent Risk Behavior and Drug Use. The following search terms were used: (*“adolescent”[MeSH Terms] OR “adolescent”[All Fields]*) AND (*“risk behaviour”[All Fields] OR “risk-taking”[MeSH Terms] OR “risk-taking”[All Fields] OR (“risk”[All Fields] AND “behavior”[All Fields]) OR “risk behavior”[All Fields]*) AND (*“substance-related disorders”[MeSH Terms] OR (“substance-related”[All Fields] AND “disorders”[All Fields]) OR “substance-related disorders”[All Fields] OR (“drug”[All Fields] AND “abuse”[All Fields]) OR “drug abuse”[All Fields]*) AND (*Journal Article[ptyp] AND “loattrfree full text”[sb] AND “2009/12/15”[PDat] : “2019/12/12”[PDat]*) AND (*Journal Article[ptyp] OR Observational Study[ptyp]*) AND (*loattrfree full text”[sb] AND “2009/12/15”[PDat] : “2019/12/12”[PDat]*).

**Search strategy and data sources:** There were three steps to find articles in this study. The first step was with the help of research librarians. A search was then done through the Web of Science, Pubmed, and the Scopus database to analyze text words in titles, abstracts, and keywords in the last ten years (2009-2019). After this analysis, the final keywords related to Adolescent Risk Behavior and Drug Abuse were chosen, and a search strategy was developed through the relevant database.

The second step was an electronic search carried out with a search strategy through 8 electronic bibliographic databases, namely: PubMed, ScienceDirect, Scopus, ProQuest Central, SAGE journal, Emerald Fulltext, EBSCOhost, Web of Science. The search conducted for 1 Month (November 2019). And Third, all relevant references cited in the article were to look for additional related studies manually. All items that had been downloaded were stored in Mendeley’s Software. Duplicate reports were excluded, titles and abstracts of all reviews go through a peer-review process. The author checked whether the article included full text or not. After carrying out these steps, the authors examined using the inclusion criteria for the relevance of the item.

**Inclusion Criteria:** The article was chosen when analyzing the relationship between adolescent risk behavior and drug abuse; use quantitative methodology; adolescents less than 20 years old, available (full text) in English. The age category was chosen based on the adolescent’s definition of psychosocial development<sup>(18)</sup>.

**Data Extraction:** First, a summary table was developed and tested by the author. Then, a summary table, as well as the full text of the selected article, and data extracted manually. Data obtained were article title, year, author, research arrangement, research design, research participant characteristics, measurement of risk behavior in drug abuse in adolescents.

**Data Analysis:** Data extracted and analyzed were performed narratively. Meta-analysis was not done in this study.

## Results

Articles found in the initial search contained 109 items based on keywords that have been described in the method section. Thirty-three articles were excluded because of the duplication; 76 materials were included in the screening stage. Items that were complete and deemed worthy were 25. Then 12 articles were excluded, with the reason the results are not relevant. Then 13 reports that met the requirements for review.

**Table 1. Summary of the included studies' findings and authors' conclusions.**

No	Reference	Results	Authors' conclusions
1	(Heger et al., 2014) <sup>(19)</sup>	Most risk behaviors tend to be associated with increased depressive symptoms in adolescent-related drug abuse and found no significant impact on depressive symptoms of adolescents.	Future studies are recommended to explore the relationship between depression and risk behavior in adolescents.
2	(Wojtyla-Buciora et al., 2017) <sup>(20)</sup>	Increased drug use among adolescents in 2009-2011, more specifically those in secondary school.	Teenagers do not have enough knowledge about the dangers of drugs. In facing the growing threat of drug trafficking, prevention efforts in health education are needed.
3	(Ammerman, Steinberg and McCloskey, 2018) <sup>(21)</sup>	Risky behavior is significantly relevant to their suicide ideas.	This finding has implications for prevention and intervention programs for adolescents
4	(Browning, Soller and Jackson, 2015) <sup>(22)</sup>	Strengthening with the environment shows a strong negative relationship with drug use in adolescents	The importance of eliminating routines that are often done in adolescent health and behavior.
5	(Keyes et al., 2015) <sup>(23)</sup>	The results of this study found that the magnitude of the relationship between risk behavior and drug use.	The importance of putting risk behavior in a framework to prevent drug users.
6	(Kellam et al., 2014) <sup>(24)</sup>	Reduced high-risk behavior and drug abuse in men who are in first grade and junior high school are more influential.	Interventions through classroom-based prevention can reduce risky behavior in drug abuse.
7	(Dougherty et al., 2015) <sup>(25)</sup>	All adolescents have relatively stable delays over time in increased risk-taking.	Adolescents in risk-taking can contribute to increasing their motivation for drug prevention in adolescents.
8	(Zebrak and Green, 2017) <sup>(26)</sup>	Drug users among adolescents have increased risk behaviors.	For further research to explore more on the social aspects by linking drug use and risk behavior.
9	(Yu et al., 2017) <sup>(27)</sup>	Some adolescents retain their personalities from time to time, but they are more likely to change risky behaviors.	The need for prevention programs through interventions that are integrated and specifically designed to prevent risky behavior towards drug abuse in adolescents.
10	(Cordova et al., 2018) <sup>(28)</sup>	Teenagers mostly accept storytelling Empowerment interventions.	It is hoped that further research will be able to link interventions carried out with risk behaviors.
11	(Gart and Kelly, 2015) <sup>(29)</sup>	The results of this study show a statistically significant effect between adolescent risk factors for suicide resulting from drug use in adolescents.	Illegal drug use can lead to suicide.
12	(Thombs et al., 2009) <sup>(30)</sup>	Their intention (adolescents) when driving a vehicle with 60 minutes after leaving work, 70% of those who use drugs.	A large number of high-risk behaviors among adolescents must be a priority focus for prevention efforts.
13	(Hops et al., 2011a) <sup>(31)</sup>	Specific interventions can reduce risky behavior in drug abuse for 18 months of follow-up in high-risk teens.	Drug abuse prevention interventions can have preventive effects for teens who are at risk.

## Discussion

The purpose of this review was to explore the relationship between risk behaviors towards drug abuse in adolescents. The 13 articles that have been identified in table 1 show that risk behaviors towards health are

a variety of activities carried out by people with a frequency or intensity that increases the risk of disease or injury. The term health behavior must be distinguished from risk behavior, which means an action associated with increased susceptibility to certain diseases<sup>(32)</sup>.

Health risk behaviors are various behavioral engagements carried out by people with an intensity that increases their susceptibility to the risk of disease or injury or may have dangerous consequences.<sup>(33)</sup> Risk behavior arises from risk factors originating from within adolescents, from family and from outside the family. Factors originating from adolescents are low achievement motivation and low self-esteem. Elements from the family are rigorous parents and little support. From outside the family are relationships with deviant peers and orientation towards excessive peers.<sup>(31,34-37)</sup> no studies have examined the similarity in risk content (e.g., substance use, sexual behaviors).

All teenagers have the risk to abuse drugs. However, several risk factors of drug abuse among adolescents, such as genetic risk factors are supported by the results of research that adolescents from alcoholic biological parents have 3-4 times the risk of drinking alcohol compared to adolescents from alcoholic adoptive parents, parenting in a vast family its influence on drug abuse in adolescents. The power of close friends to abuse drugs is more significant than in strangers.<sup>(38)</sup>

In risky behavior, for example, teens feel that they will not be at risk if they do not follow traffic signs. Second, the perception of severity, namely the level of one's belief that the consequences of health problems will become increasingly severe, for example, in risky behavior, adolescents who experience overweight problems will not add to health problems. Protection is needed to protect adolescents from risky behavior and the impact of risk behavior on health. The forms of protection include coping, commitment to achievement, control, and fulfilling developmental tasks. One way of security is the presence of power. With this control, it will prevent students from conducting risky behaviors to health and protect adolescents from the adverse effects of risky behavior on health. A person who has weak self-control will have a higher risk behavior, and if he has high self-control, the lower the risk behavior.

### Conclusion

This review concludes that all deviant behavior is hazardous for adolescent health. Attitudes toward risk behavior referred to as adolescent's perception of vulnerability to the possible negative consequences of risky behavior. Numerous studies show that prototype perceptions are connected with teenagers' decisions about whether they will engage in risky behavior or not.

Attitudes towards health risk behaviors are associated with health risk behaviors, including drug abuse. Therefore, control of behavior is pivotal as individual beliefs in his ability to manage any impulse that arises to behave negatively from within the individual towards channeling a more healthy and positive inspiration.

**Ethical Clearance:** Taken from University ethical committee

**Source of Funding:** Self

**Conflict of Interest:** Nil

### Reference

1. Wills TA, Knight R, Williams RJ, Pagano I, Sargent JD. Risk factors for exclusive e-cigarette use and dual e-cigarette use and tobacco use in adolescents. *Pediatrics*. 2015;135(1):e43-51.
2. Merikangas KR, He J, Burstein M, Swanson SA, Avenevoli S, Cui L, et al. Lifetime prevalence of mental disorders in US adolescents: results from the National Comorbidity Survey Replication-Adolescent Supplement (NCS-A). *J Am Acad Child Adolesc Psychiatry*. 2010;49(10):980-9.
3. Caldwell CH, Rafferty J, Reischl TM, De Loney EH, Brooks CL. Enhancing parenting skills among nonresident African American fathers as a strategy for preventing youth risky behaviors. *Am J Community Psychol*. 2010;45(1-2):17-35.
4. Wilson EC, Garofalo R, Harris RD, Herrick A, Martinez M, Martinez J, et al. Transgender female youth and sex work: HIV risk and a comparison of life factors related to engagement in sex work. *AIDS Behav*. 2009;13(5):902-13.
5. Jackson CA, Henderson M, Frank JW, Haw SJ. An overview of prevention of multiple risk behaviour in adolescence and young adulthood. *J Public Health (Bangkok)*. 2012;34(suppl\_1):i31-40.
6. Shead NW, Derevensky JL, Gupta R. Risk and protective factors associated with youth problem gambling. *Int J Adolesc Med Health*. 2010;22(1):39.
7. Griffin KW, Botvin GJ. Evidence-Based Interventions for Preventing Substance Use Disorders in Adolescents. *Child and Adolescent Psychiatric Clinics of North America*. 2010.
8. Jongenelis M, Pettigrew S, Lawrence D, Rikkers W. Factors associated with poly drug use in adolescents. *Prev Sci*. 2019;20(5):695-704.

9. Ljubotina D, Galic J, Jukic V. Prevalence and risk factors of substance use among urban adolescents: questionnaire study. *Croat Med J*. 2004 Feb;45(1):88–98.
10. Fuller CM, Vlahov D, Arria AM, Ompad DC, Garfein R, Strathdee SA. Factors associated with adolescent initiation of injection drug use. *Public Health Rep*. 2016;
11. Nosratabadi M, Halvaiepour Z. Psychological determinants of drug abuse among male adolescents in Isfahan: A structural model. *Int J Prev Med*. 2019;10.
12. Karatay G, Baş NG. Factors affecting substance use and self-efficacy status of students in eastern Turkey. *Cien Saude Colet*. 2019;24:1317–26.
13. Palallo UD, Syafar M, Amiruddin R, Indar, Yani A. Effects of adolescent attitudes on forming intention to stop smoking. *Int J Innov Technol Explor Eng*. 2019;9(1).
14. Palallo UD, Syafar M, Amiruddin R, Indar, Yani A. The effect of life skill education on cigarette control in adolescents. *Indian J Public Heal Res Dev*. 2019;10(9).
15. Terzian MA, Andrews KM, Moore KA. Preventing Multiple Risky Behaviors among Adolescents: Seven Strategies. Washington; 2011.
16. Killianova T. Risky Behavior BT - Encyclopedia of Behavioral Medicine. In: Gellman MD, Turner JR, editors. (eds) *Encyclopedia of Behavioral Medicine*. New York, NY: Springer New York; 2013. p. 1692–3.
17. Ajzen. The theory of planned behavior. *Organ Behav Hum Decis Process*. 1991;50(2):179–211.
18. Foshee VA, Benefield T, Suchindran C, Ennett ST, Bauman KE, Karriker-Jaffe KJ, et al. The development of four types of adolescent dating abuse and selected demographic correlates. *J Res Adolesc*. 2009;19(3):380–400.
19. Heger JP, Brunner R, Parzer P, Fischer G, Resch F, Kaess M. [Depression and risk behavior in adolescence]. *Prax Kinderpsychol Kinderpsychiatr*. 2014;63(3):177–99.
20. Wojtyła-Buciora P, Klimberg A, Kapka-Skrzypczak L, Diatczyk J, Urbaniak M, Ulatowska-Szostak E, et al. Monitoring risk behaviour in adolescent pupils regarding consumption of psychoactive substances. *Ann Agric Environ Med*. 2017 Jun;24(2):350–5.
21. Ammerman BA, Steinberg L, McCloskey MS. Risk-Taking Behavior and Suicidality: The Unique Role of Adolescent Drug Use. *J Clin Child Adolesc Psychol*. 2018;
22. Browning CR, Soller B, Jackson AL. Neighborhoods and adolescent health-risk behavior: an ecological network approach. *Soc Sci Med*. 2015 Jan;125:163–72.
23. Keyes KM, Jager J, Hamilton A, O'Malley PM, Miech R, Schulenberg JE. National multi-cohort time trends in adolescent risk preference and the relation with substance use and problem behavior from 1976 to 2011. *Drug Alcohol Depend*. 2015 Oct;155:267–74.
24. Kellam SG, Wang W, Mackenzie ACL, Brown CH, Ompad DC, Or F, et al. The impact of the Good Behavior Game, a universal classroom-based preventive intervention in first and second grades, on high-risk sexual behaviors and drug abuse and dependence disorders into young adulthood. *Prev Sci*. 2014 Feb;15 Suppl 1:S6-18.
25. Dougherty DM, Lake SL, Mathias CW, Ryan SR, Bray BC, Charles NE, et al. Behavioral Impulsivity and Risk-Taking Trajectories Across Early Adolescence in Youths With and Without Family Histories of Alcohol and Other Drug Use Disorders. *Alcohol Clin Exp Res*. 2015 Aug;39(8):1501–9.
26. Zebrak KA, Green KM. The role of young adult social bonds, substance problems, and sexual risk in pathways between adolescent substance use and midlife risky sexual behavior among urban African Americans. *Psychol Addict Behav*. 2017 Nov;31(7):828–38.
27. Yu J, Putnick DL, Hendricks C, Bornstein MH. Health-Risk Behavior Profiles and Reciprocal Relations With Depressive Symptoms From Adolescence to Young Adulthood. *J Adolesc Health*. 2017 Dec;61(6):773–8.
28. Cordova D, Alers-Rojas F, Lua FM, Bauermeister J, Nurenberg R, Ovadje L, et al. The Usability and Acceptability of an Adolescent mHealth HIV/STI and Drug Abuse Preventive Intervention in Primary Care. *Behav Med*. 2018;44(1):36–47.
29. Gart R, Kelly S. How Illegal Drug Use, Alcohol Use, Tobacco Use, and Depressive Symptoms Affect Adolescent Suicidal Ideation: A Secondary Analysis of the 2011 Youth Risk Behavior Survey. *Issues Ment Health Nurs*. 2015 Aug;36(8):614–20.

30. Thombs DL, O'Mara R, Dodd VJ, Merves ML, Weiler RM, Goldberger BA, et al. Event-specific analyses of poly-drug abuse and concomitant risk behavior in a college bar district in Florida. *J Am Coll Health*. 2009;57(6):575–85.
31. Hops H, Ozechowski TJ, Waldron HB, Davis B, Turner CW, Brody JL, et al. Adolescent health-risk sexual behaviors: Effects of a drug abuse intervention. *AIDS Behav*. 2011;15(8):1664–76.
32. Kann L, McManus T, Harris WA, Shanklin SL, Flint KH, Queen B, et al. Youth risk behavior surveillance - United States, 2017. *MMWR Surveill Summ*. 2018;
33. Campbell JA, Walker RJ, Egede LE. Associations between adverse childhood experiences, high-risk behaviors, and morbidity in adulthood. *Am J Prev Med*. 2016;50(3):344–52.
34. Negriff S. A pilot study examining risk behavior in facebook posts for maltreated versus comparison youth using content analysis. *Child Abuse Negl*. 2019;96(April):104091.
35. Brook DW, Brook JS, Rubenstone E, Zhang C, Finch SJ. A Longitudinal Study of Sexual Risk Behavior Among the Adolescent Children of HIV-Positive and HIV-Negative Drug-Abusing Fathers. *J Adolesc Heal*. 2010;46(3):224–31.
36. Leung H, Ph D, Lin L, Ph D. Adolescent Sexual Risk Behavior in Hong Kong : Prevalence, Protective Factors, and Sex Education Programs. *J Adolesc Heal*. 2019;64(6):S52--S58.
37. Lee Y, Lee KS. Relationship between unhealthy weight control behaviors and substance use patterns among Korean adolescents: results from the 2017 national youth risk behavior survey. *Public Health*. 2019;174:56–64.
38. Whitesell M, Bachand A, Peel J, Brown M. Familial, social, and individual factors contributing to risk for adolescent substance use. *J Addict*. 2013/03/20. 2013;2013:579310.



# The Effect of Environmental Factors on the Enzyme Production of *Aeromonas Hydrophila* Isolates

Hawraa Natiq Kabroot AL-Fatlawy

Ph.D. Dr. Academic (Molecular Genetics) in Dep. of Medical Laboratory Techniques,  
Al-Toosi University College, Najaf, IRAQ.

## Abstract

The current study demonstrates that the effect of some the environmental factors on enzymes production that included (heamolysin, protease, lipase and phospholipase enzymes) of *A. hydrophila*. The present study included the detection of *A. hydrophila* in some clinical cases and environmental sources in the governorate of AL-Najaf, (159) Clinical samples were taken from patients suffering from various infection at Al-Sadder Medical City and Al-Zahraa Educational Hospital during the period from October 2011 to March 2012. Also, (92) Environmental samples were involve three different of environmental regions (Kufa river, Bahar Najaf and tap water) *A. hydrophila* isolates which were diagnosed by four method as (Culture method, biochemical tests, Api20E system and Polymerase chain reaction (PCR)). The results show that the optimal production of enzymes at temperature (37°C) and pH (7) for clinical. While (22 and 37°C) and pH (7 and 9), for environmental isolates. Some clinical and environmental isolates containing heamolysingene were tested Ligated Ileal intestinal of rabbit. The results indicate that the gene (*hyl*) was responsible for the pathogenicity of *A. hydrophila*, whereas causes accumulation of fluids in comparison with control positive (*V. cholera*) which caused accumulation of fluids and control negative (Normal saline).

**Keyword:** *A. hydrophila*, ph, Temperature, the Environmental factors, Enzymes production.

## Introduction

*Aeromonas hydrophila* bacteria is one species of the genus *Aeromonas* that received increasing attention as opportunistic pathogens because of its association with human diseases and aquatic and terrestrial animal's infections<sup>1</sup>. *A. hydrophila* is associated with both diarrheal and extraintestinal infection in human disease especially dangerous for children and persons with impaired immune system. The symptoms of the pathological features associated with infection caused by *A. hydrophila* refer to local enema, tissue necrosis, sepsis and mortality. The pathogenicity of *A. hydrophila* infection is complex and multifactorial and it's attributed to a multiple virulence

factors, including cell structural : lipopolysaccharide (LPS), outer membrane proteins (OMPs), pili and flagella, type III secretion system (T3SS) acts as adhesion structures and extracellular factors such as exotoxin, aerolysins, heamolysins,  $\beta$ -lactamase, enterotoxin and siderophore that seem to play an important role in pathogenesis<sup>2</sup>. The present study is carried out to achieve the following objectives: 1- **Isolation** of *A. hydrophila* among the clinical cases and environmental regions in Najaf and identification by API20E system and the PCR technique, with used specific primer (16S r RNA) diagnostic gene. 2- Detection the virulence factors of *A. hydrophila* such as heamolysin, lipase, protease, gelatinase hydrolyze, phospholipase, siderophore, capsule formation and adherence to uroepithelial cells of human among clinical and environmental isolates. 3- Determining the effect of some the environmental factors on enzymes production including (heamolysin, lipase, protease and phospholipase) of *A. hydrophila*. 4- Determination the pathogenicity of *A. hydrophila* in Rabbits.

---

### Corresponding Author:

Hawraa Natiq Kabroot AL-Fatlawy

Ph.D. Dr. Academic (Molecular Genetics) in Dep. of Medical Laboratory Techniques, Al-Toosi University College, Najaf, IRAQ.

e-mail: dr.hawraank9@altoosi.edu.iq

## Materials and Method

### 1. Samples Collection:

**A. Clinical Samples:** A total of 159 samples were involved 110 diarrhea, 11 sputum, 6 cerebral spinal fluid (C.S.F), 7 wounds, 6 burns, 9 Blood, and 10 Urine samples were obtained from patients who attended to AL-Sadder Medical City and AL-Zahraa Educational Hospital in Najaf governorate during the period from October 2011 to the March 2012.

**B. Environmental Samples:** A total of 92 water samples from surface water were collected from three different loci (Kufa river, Bahar Al-Najaf, Tap water) during the period from October 2011 to the March 2012. *A. hydrophila* isolated from water by :

Each water sample was mixed 1 ml water with 9 ml of alkaline peptone water (APW) pH 8.6 to have 10 ml for each tube. Then it is incubated at 37 °C for 24hr. Loopful of incubated samples is streaked at the surface of thiosulphate citrate bile salt sucrose agar medium (TCBS) followed by overnight incubation at 37°C. The yellow/green rounded 2-3 mm colonies were picked and streaked over blood agar, MacConkey agar for further testing<sup>3</sup>.

### 2. Identification of *A. hydrophila*:

**1. Microscopic Properties:** Gram's stain was used to examine the isolated bacteria for studying the microscopic properties as initial identification of *A. hydrophila*<sup>4</sup>

#### 2) Cultural Characteristics:

Morphological colonies characteristics were recorded on the specific media for primary identification of *A. hydrophila*

#### 3) Biochemical Tests :

Biochemical tests of *A. hydrophila* 1-2 colony were tested for oxidase, catalase, Simmone Citrate, Kligler Iron agar and Indole tests and these entire tests positive<sup>5</sup>.

### 3- Effect of the Temperature and pH on Enzymes Production of *A. hydrophila* .

*A. hydrophila* isolates was selected with high production for heamolysin, lipase, Phospholipase, protease enzymes for the purpose of studying the effect of temperature and pH in production of enzymes .

### A-Temperature

The effect of temperature on virulence enzymes was detected according to method of<sup>6</sup> as the following :-

1- Inoculate 10ml of nutrient broth with a single colonies of *A. hydrophila* which have high ability to produce enzymes.

2- Incubate the test tube of different temperature (4, 22, 28, 37, 41, 50) for 24 hr to (heamolysin, protease) and for 48-72 hr for (Phospholipase and lipase) .

3- Centrifuge the growth culture at 6,000 ×g for 30 min.

4- Collects the supernatant containing the enzyme in sterilized test tubes.

5- Transfer 50µl of the supernatant containing enzyme to wells (6 mm diameter) in specific media plates to each enzyme .

6- Incubate the plates at temperature 37°C for 24hr for (heamolysin, protease) and at 48-72 hr for (Phospholipase, lipase) .

7- Measure the decomposition diameters for each enzyme and compare it at different temperature .

### B- pH :

The effect of pH on the activity of enzymes was carried out at the same method of temperature except the following modification :-

1- Inoculate 10ml of nutrient broth with high activity isolates to produce enzymes, each tube have different pH ranging (3, 5, 7, 8, 9, 10). Incubate the tubes at 37°C for 24hr for (heamolysin, protease) and at 48-72 hr for (Phospholipase, lipase) .

2- Measure the decomposition diameters for each enzyme and compare it at different temperature .

### 4-Pathogenicity of *A. hydrophila*

Pathogenicity of *A. hydrophila* was detected by accumulation of fluids test is used in Rabbit Ligated Ileal Loop Model<sup>7</sup>. The method involved rabbit anesthesia by using 0.2 ml of kitamen (drug) and 0.3 ml of xylazine, and four regions are selected of rabbit intestinal loops (10cm) of length to more than one loop by separation with sterilized sutures. The two loops are injected with (1)ml of the bacterial suspension

of *A. hydrophila* isolates that give a positive result to hemolysin (*hyl*) gene in molecular study (PCR assay) of *A. hydrophila* both isolates (clinical, environmental) and two concentrations ( $10^4$  and  $10^6$ ) cell/ml are used, also other two loops of intestine are injected with suspension of *V. cholera* bacteria as positive control and normal saline that consider as negative control in this study. After that intestine is returned to animal body, and disappearance of anesthesia effect of rabbit. After (18-24hr) they are taken out of the intestine to observe accumulation of fluids inside each loop of ligated loops. The isolate that have pathogen effect, which is observed is the cause of accumulation of fluids in the loops of intestine<sup>8</sup>.

### Results and Discussion

A total 251 samples were collected from clinical (159 (63.34%)) sample from patients suffering from different cases and 92 (36.66%) from water. The samples are activated in APW media at 37°C for 18-24h, then, they incubated on selective media such as Blood agar, MacConkey agar and TCBS agar at 37°C for 18-24h. Whereas various isolation methods including positive isolates.

Our result the identification of *A. hydrophila* is depended on the colonial morphology, microscopical and biochemical tests as initial identification. The colonies of *A. hydrophila* are grown on culture media once revealed the typical characteristics being described by referential studies, that the colonies are yellow shiny color on TCBS agar, with diameter ranged from (2-3)mm. In addition to those colonies appeared as pale like shaped on the MacConkey agar indicated that *A. hydrophila* is unable to ferment lactose sugar. Microscopical examination has revealed that *A. hydrophila* a gram negative bacillus, straight shape, singly or pairs and rarely as short chains, and not spore forming. In general, the genus *Aeromonas* are facultative anaerobic, oxidase positive, Gram negative bacteria whose natural habitat is in the aquatic environment. Some species are pathogenic for animals and humans<sup>9</sup>. The taxonomy of the genus *Aeromonas* has been confusing because of lack of matching between phenotypic and genotypic characteristics of species and multiple methods that are required for accurate classification<sup>10</sup>.

Identification of *A. hydrophila* depends on the colonial morphology, biochemical tests, Api20E system

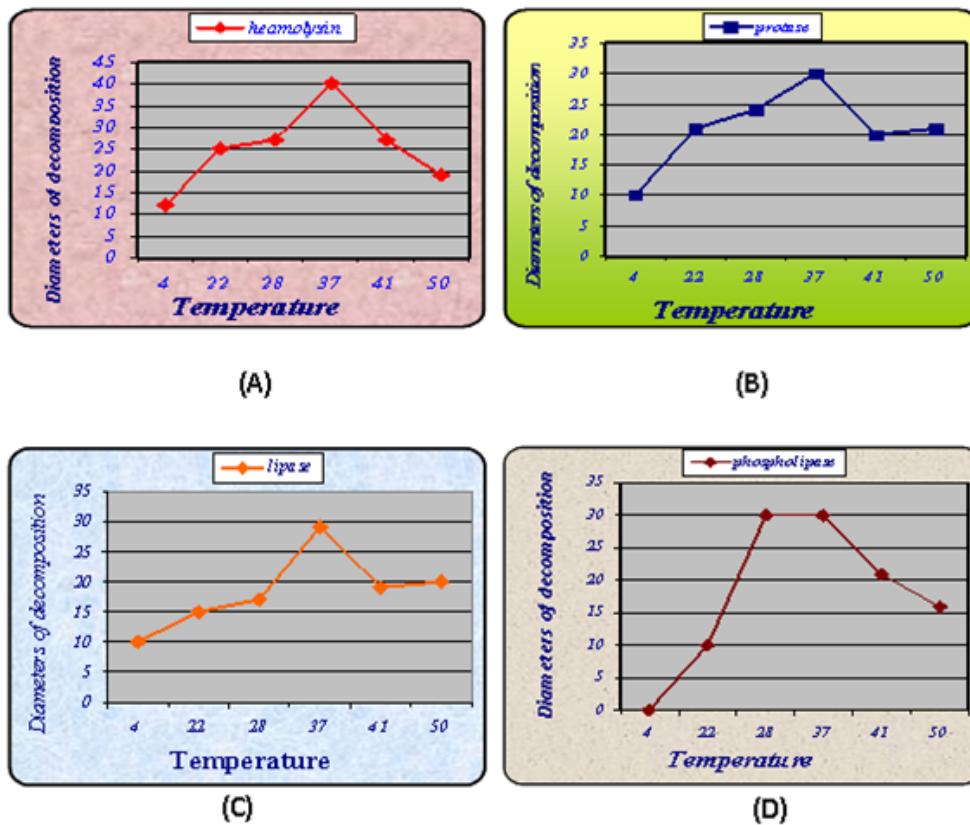
and molecular identification. These results are agree with<sup>11,12</sup>. The biochemical tests are accordance with the standard characteristics<sup>4,5, 13,14</sup>. API20E system is characterized by fast detection of bacteria without the need for many of culture media as well as reduce cultural contamination, and it is used to confirm identification of *A. hydrophila*<sup>1</sup>. These results agree with<sup>15,16,17</sup>.

### - The Effect of Temperature and pH on the Enzyme Production of *A. hydrophila*

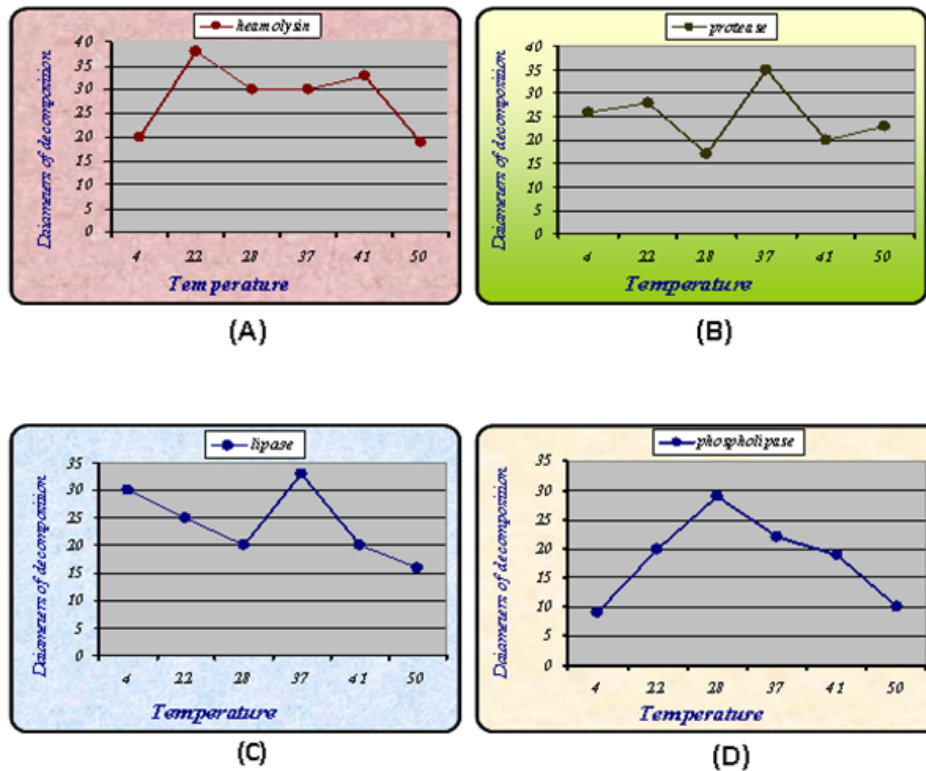
The present study deals with the effect of the different incubation temperatures and pH values on the enzyme production such as, hemolysin, lipase, protease and Phospholipase of *A. hydrophila*, which are selected for the most efficient isolate of the other isolates was studied.

#### 1 : Temperature

Our results demonstrate that *A. hydrophila* isolates growth at temperature range (4-50 °C) and pH (3-10). The resulting in [fig,1] demonstrate the effect temperature effect on enzymes production for clinical *A. hydrophila* isolates was produces these enzymes at temperature range (4-50°C). The optimum production of hemolysin, protease and lipase was at 37°C while lower activity of enzymes production was at 4°C. Either, Phospholipase enzyme was produced by clinical *A. hydrophila* isolates at temperatures 28 and 37°C (optimum production), and the less productivity at temperature (22°C), while phospholipase does not produce at temperature (4°C). The study of influence of environmental factors helps to clarify the relationship between temperature, pH values on enzymes production of *A. hydrophila* isolates. *A. hydrophila* produces many extracellular factors such as enzymes and toxins<sup>18, 19</sup> proposes a model for describing the effects of temperature, PH on the growth of *A. hydrophila* and shows that temperature and pH are the main influence on the bacterium growth. In other hand, The effect of temperature on enzymes production among Environmental *A. hydrophila* isolates were shown in [fig, 2]. The optimum temperature for hemolysin production was at temperature 22°C while it was 37°C for protease and lipase enzymes. The lower production for hemolysin and lipase enzymes was at 50°C, but it was 28°C for protease enzyme. The optimum production for phospholipase enzyme was at 28°C and lower activity was at 4°C and 50°C.



[ Fig. 1]: The Effect of the different Temperature on Production of Enzymes of *A. hydrophila* from Clinical Isolates: (A) - Hemolysin Production (B)- Protease Production (C)- Lipase Production (D) - Phospholipase Production.

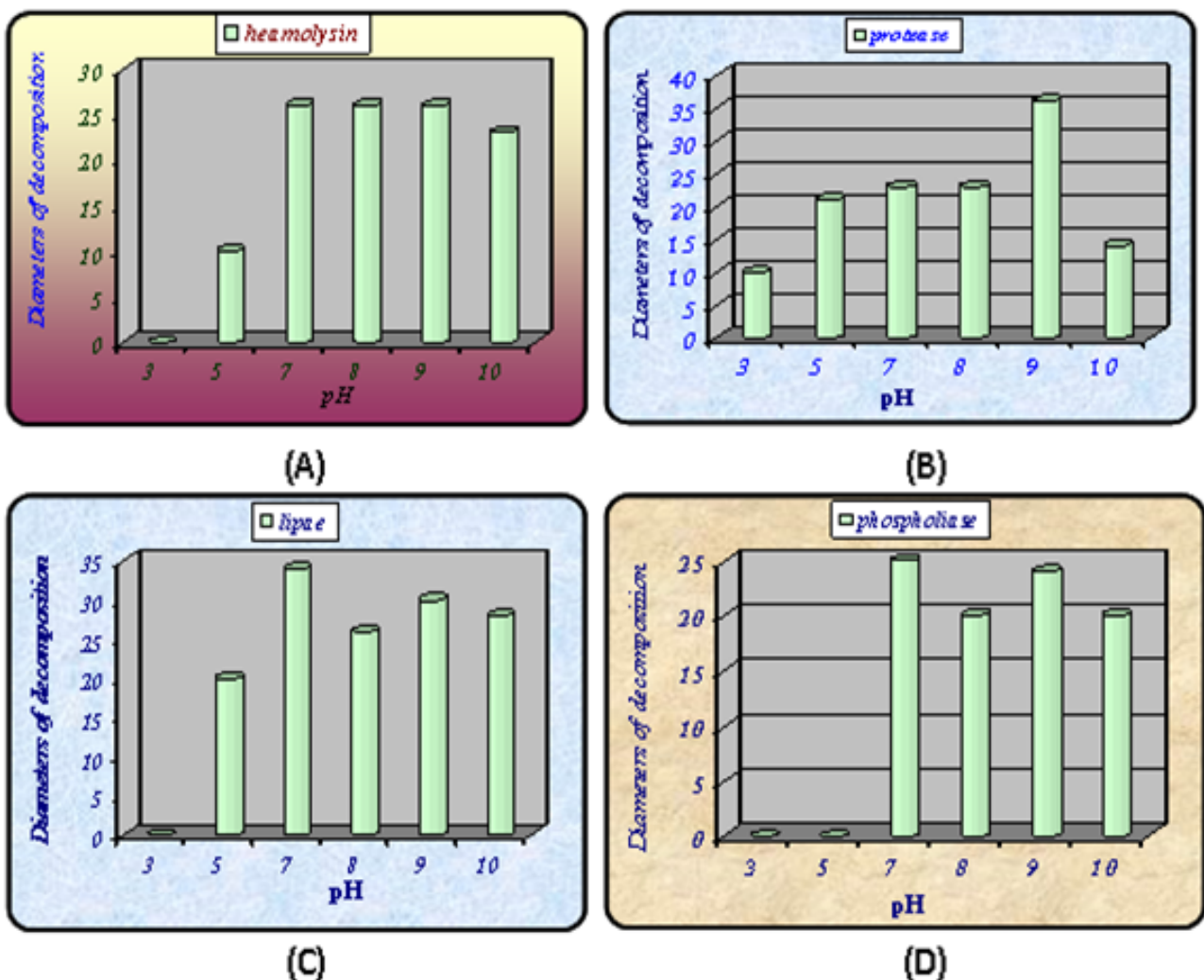


[Fig. 2] : The Effect of The different Temperature on Enzymes Production of *A. hydrophila* of Environmental Isolate:(A)Hemolysin Production (B)- Protease Production (C)- Lipase Production (D) - Phospholipase Production.

## 2 : pH

The results of pH in this study, the effect of different pH values on the production of heamolysin, lipase, protease and phospholipase enzymes among clinical *A. hydrophila* isolates as shows [Fig, 3]. The best production of heamolysin was showed at pH (7-9) and lower production at pH (5). The higher production of protease and lipase enzyme were at pH (7 and 9) and the lower production at pH (3 and 5) of both enzyme respectively. Lipase enzyme is not produced at pH(3). According to the results, *A. hydrophila* was high producer to Phospholipase enzyme at pH(7 and 9) whereas, no production was detected at pH(3 and 5).

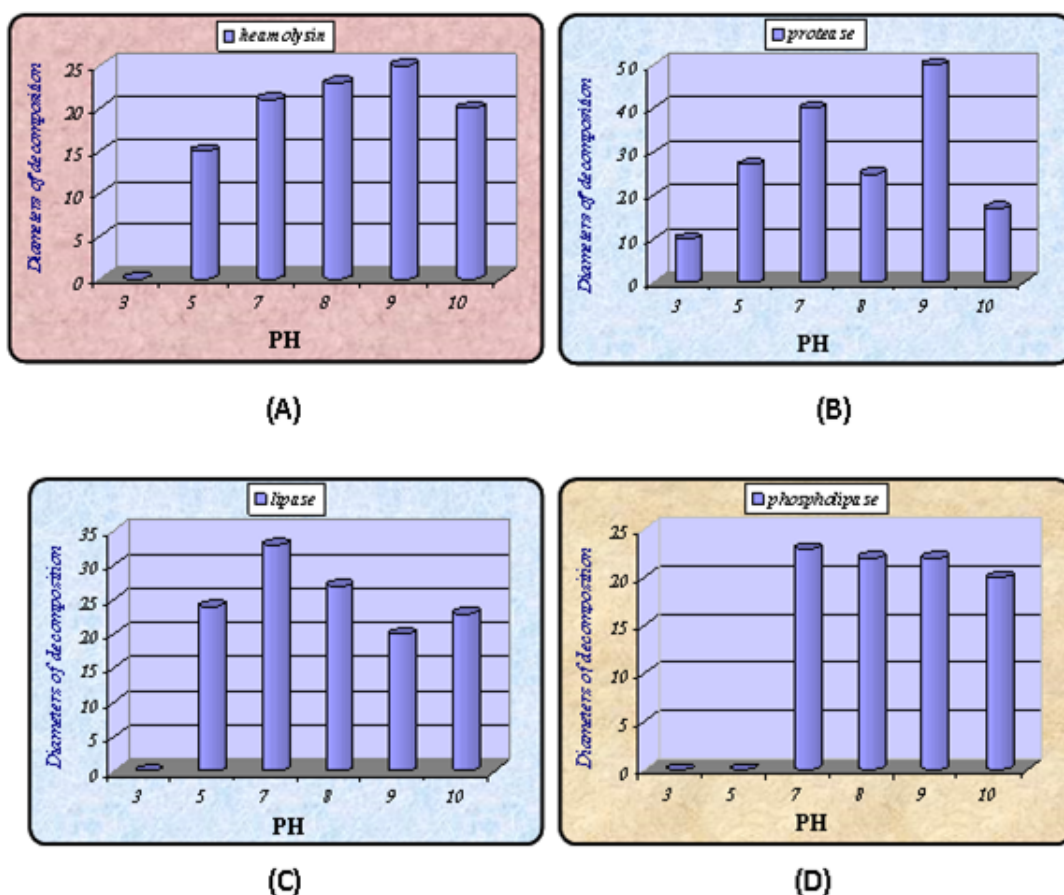
Whereas the influence of pH on enzymes production (environmental) high production rate is at pH(9), but lipase and phospholipase enzyme at pH(7) and the lower is at pH(5) but it does not produce at pH (3). These results were similar to<sup>20</sup>who demonstrated that heamolysin, lipase and elastase enzymes were effected with temperature and the optimum production for these enzymes was at (37°C) and lipase was more effect in higher temperature dose not grow decomposition zone at 48°C and 59°C where the optimum pH for enzymes production was at (7) and *A. hydrophila* was not produced for these enzymes at pH (3, 4.5, 5).



[Fig.3] : The Influence of Different PH Values on Enzymes Production of *A. hydrophila* from Clinical isolates : (A)-Heamolysin production (B)-Protease production (C)-Lipase production (D)-Phospholipase production .

The influence of pH values on enzyme production among environmental isolates was shown in [fig, 4]. The heamolysin is highest production rate is at pH (9), and the lower production rate is at pH (5). Heamolysin does not produce at pH(3). Protease and lipase enzyme are best produced at pH (9,7), whereas the least production rate is at pH (3) for protease, and pH (9) for lipase, but does not produce at pH(3). Likewise, phospholipase enzyme

production from *A. hydrophila* is higher productivity is at pH (7), lower productivity at pH (10) and do not produce at pH (3,5). However, they exhibit an acid stress response in that when they are acclimated at pH 5, the kill time at pH (3) is extended. Treatment with protein-inhibiting antibiotics prior to exposure to low pH eliminated the acid stress response, suggesting that protein synthesis is an important part of the acid stress response<sup>19</sup>.



**[Fig.4]** : The Influence of Different pH Values on Enzymes Production of *A. hydrophila* from Environmental isolates.(A)-Heamolysin production (B)-Protease production(C)-Lipase production (D)-Phospholipase production .

**Pathogenicity for *A. hydrophila*:** The results of the presence study demonstrate the existence of the fluid accumulation in Rabbit Ligated Ileal intestinal loops injected with bacterial suspensions to *A. hydrophila* bacteria (isolated from clinical and environmental) which give a positive result to heamolysin gene in PCR technique .

The first loop that is injected with bacterial suspension with (10<sup>4</sup>) cell/ml concentration of *A. hydrophila*, may have caused accumulation of fluids with clearly changes

in this loop compared to the control loop. Likewise, the second loop which is injected a suspension of *A. hydrophila* from the same isolate but with (10<sup>6</sup> cell/ml) concentration, also causes accumulation of fluids with largest extend from other loops of the intestinal. The isolates of *A. hydrophila* that is isolated from Kufa river water also have caused accumulation of fluids but less than that of diarrhea isolates . The test is compared with loop for *V. cholera* bacteria that is considered as a positive control to these strain that has caused accumulation of fluid in constant loop to normal saline

and considered as negative control.<sup>21</sup>who indicates to the infection of suckling mice and the determination of fluid accumulation (FA) the gut is studied according to the method of<sup>22,26</sup>. The results agree with<sup>8,23,24,25</sup> who found that experimental infected mice died between 18-24 hours with signs of septicemia, blindness and liver necrosis.

### Conclusions

The following conclusions are extracted from the present study: The frequency of *A. hydrophilaisolates* in Najaf was higher among clinical and environmental isolates. Most clinical and environmental isolates produce many virulence factors involve heamolysin, lipase, protease, phospholipase. The best productivity of heamolysin, lipase, protease and phospholipase at temperature (37°C), pH (7) in clinical isolates and (22 and 37°C), pH (7-9) in environmental isolates. The bacteria *A. hydrophilahave* exotoxin like heamolysin which is responsible for the pathogenesis of bacteria in lab animals (Rabbits).

**Funding:** None

**Conflict of Interest:** The author is no conflict of interest.

**Contribution:** The author in this work has approved it for publication in your journal.

**Data:** All data were analyzed during this work are included in the manuscript.

**Ethics Statement:** The work does not contain any study with human participant by the author.

### References

- Naharro G., Riano J.; de Castro L.; Alvarez S.; Luengo J.M. *Aeromonas: Molecular Detection of Foodborne Patho-gens*, CRC Press. North Ryde, 2009; 273-289.
- Janda, J.M. & Abbott, S.L. The genus *Aeromonas*, taxonomy, pathogenicity, and infection. *Clinical Microbiology Reviews*, 2010; 23, pp. 35-73.
- WHO. *Microbiological agents in drinking water. Vibrio cholera*, 2000; (2<sup>nd</sup> ed.).
- Jawetz E.; Melnick J.I. and Adelberg E.A. *Medical Microbiology*, 2007 24<sup>th</sup> ed., Appleton and Lange, USA.
- MaccFadin, J.K. *Biochemical test for identification of medical bacteria*. 2000; (3<sup>rd</sup> ed.). Lippincott Williams and Winkins .Awolter Klumer Company . Philadelphia Baltmor, New York.
- Varadarai, M.C.; Keshara, N.; Devi, Dwarkanath, C.T., and Manjerkary, S.P. Occurrence of *Bacillus cereus* and other *Bacillus* species in Indian snack and lunch foods and their ability to grow in a rice preparation . *J. Food . Sci . Technol.* 1992; 29(6) : 344-347.
- Chakraborty, S.; Deokule, J.S.; Garg, P.; Bhattacharya, S.K.; Nandy, R.K.; Nair, G.B.; Yamasaki, S.; Takeda, Y. and Ramamurthy, T. Concomitant infection of enterotoxigenic *Escherichia coli* in an outbreak of cholera caused by *Vibrio cholerae* O1 and O139 in Ahmedabad, India. *J. Clin. Microbiol.* 2001; (9): 3241-3246.
- Bhattachaiya, M.; Choudhury, P. and kumar, R. Antibiotic and metal resistance strains of *Vibrioparahaemolyticus* isolated from shrimps. *Microb. Drug Resist*, 2006; 6(2): 171-172 .
- Martin-Carnahan, A. and Joseph. S. W. *Genus I. Aeromonas Stanier 1943, 213AL*, p. 557-578. In D. J. Brenner, N. R. Krieg, J. T. Staley, and G. M. Garrity (ed.), *Bergey's manual of systematic bacteriology*, 2<sup>nd</sup> ed., 2005; 2, part B. Springer, New York, NY.
- Figueras, M.J.; Beaz-Hidalgo, R.; Collado, L. & Martínez-Murcia, A.J. Point of view on the recommendations for new bacterial species description and their impact on the genus *Aeromonas* and *Arcobacter*. *The Bulletin of Bergey's International Society for Microbial Systematics*, 2011b; 2, part 1, pp. 1-16.
- Jayavignesh, V.; Sendesh Kannan K. and Bhat .A.D. Biochemical characterization and cytotoxicity of the *Aeromonas Hydrophilaisolated* from Catfish. *Arch. Appl. Sci. Res.* 2011; 3 (3): 85-93
- Awaad, M.H.H.; Hatem, M.H.; Abd El-Ghany, W.A.; El-Sawy, A. Certain Epidemiological Aspects of *Aeromonas hydrophila* Infection in Chickens. *Journal of American Science*, 2011; 2(3).
- Collee, J.G.; Fraser, A.G.; Marmino, B.P.; and Simons, A. Mackin and McCartney *Practical Medical Microbiology*. 14<sup>th</sup> ed The Churchill Livingstone, Inc. 1996. U.S.A.
- Jawetz, E.; Melnick, J.I. and Adelberg, E.A. *Medical Microbiology*. (27<sup>nd</sup> ed.). Appleton and Lange U.S.A., 2016.

15. Bijay, K.; Khajanchi- Amin, A. Fadl, Mark A. Borchardt, Richard L. Berg, Amy J. Horneman, Mary E. Stemper, Sam W. Joseph, Nelson P. Moyer, Jian Sha, and Chopra, A.K. Distribution of Virulence Factors and Molecular Fingerprinting of *Aeromonas* Species Isolates from Water and Clinical Samples: Suggestive Evidence of Water-to-Human Transmission. *Applied and Environmental Microbiology*, 2010; 76(7), 2313–2325. doi:10.1128/aem.02535-09.
16. AL-Fatlawy, H.N.K; Aldahhan,H.A and Alsaadi,A.H. Phylogenetic of ERIC-DNA Fingerprinting and New Sequencing of *Aeromonas* Species and *V. Cholerae* DNA. *American Journal of Applied Sciences* 2017, 14 (10): 955.964. DOI:10.3844/ajassp.2017.955.964.
17. AL-Hadrawi1, H.A.N, AL-Harmoosh, R.A and AL-Fatlawy, H.N.K. Detection of Some Virulence Factors of Clinical *V.cholerae*isolates in Najaf/ Iraq. *J. Pharm. Sci. & Res.* 2019; 11(2). 375-379.
18. Wai, S.N.; Mizunoe, Y.; Takade,A. & Yoshida, S. A comparison of solid and liquid media for resuscitation of starvation and low temperature induced non-culturable cells of *Aeromonas hydrophila* . *Arch Microbiol*, 2000; 173, 307-310.
19. Sautour, M.; Mary, P.;Chihib,N.E.; Hornez,J.P. The effects of temperature, water activity and pH on the growth of *Aeromonashydrophila* and subsequent survival in microcosm water. *J. Appl. Microbiol.*2003; 95: 807-813.
20. Al-Tae, R. K.I. Study of some virulence factors of the *Aeromonas hydrophilabacteria* isolated from clinical source. M.Sc . Thesis, College of science,University of Baghdad. 2002,In Arabic.
21. Aslani,M.M., and Alikhani,M.Y. The role of *Aeromonas hydrophila* in diarrhea .Irani .*J.Publi .Health.* 2004; 33(3):54-59.
22. Wong, C.Y.F.; Heuzenroeder, M.W, and Flower, R.L.P. Inactivation of two haemolytic toxin genes in *Aeromonas hydrophila* attenuates virulence in a suckling mouse model. *Microbiology*, 1998; 144: 291-298.
23. Al-Hadrawy, H.A.N. A Comparative study of Bacteriological and Molecular *Vibrio Cholera* Isolated from the Tigris and Euphrates. Ph. D. Thesis, College of the science, University of Kufa. 2012.In Arabic .
24. Al-Fatlawy, H.N.K and AL-Hadrawy, H.A. Isolation and Characterization of *A. hydrophila* from the Al-Jadryia River in Baghdad (Iraq). *American Journal of Educational Research*, 2014, Vol. 2, No. 8, 658-662. DOI:10.12691/education-2-8-14.
25. Al-Hadrawi, H.; Al-Harmoosh R.; Al-Fatlawy, H.N.K. Isolation and Identification of *Streptococcus pneumonia* Causing Respiratory and Thoracic Diseases in Najaf Province. *J Pure Appl Microbiol*, 2019; 13(4). doi 10.22207/JPAM.13.4.
26. Ali, A.andKarunasagar, I. Effect of oxytetracycline on the immune response of *Labaeorohita* to *Aeromonashydrophila* vaccine. In: Flegel T, MacRae IH (eds) *Diseases in Asian aquaculture6* Vol. III. Fish Health Section, Asian Fisheries Society, Manila, Philippines,1997; 6(3) pp 187–191.



# Sleep Patterns in Overweight/Obese Adults in Baghdad City

Maha Sabah Ahmed Al-Jumaili

*M.B.Ch.B., F.I.C.M.S (Family Medicine); Lecturer at College of Medicine-Baghdad University-Baghdad*

## Abstract

**Background:** Abnormal sleep patterns are health challenge facing the Iraqi community and related to modernized behavioral changes.

**Aim of Study:** To identify the prevalence of abnormal sleep patterns among overweight/obese adults in Baghdad city.

**Patients and Method:** A descriptive cross sectional survey carried out in two Nutrition Clinics in Baghdad. During six months including 250 overweight/obese adults. The short sleep duration was defined as <7 hours/day and late sleep onset was defined as sleeping at 11 o'clock pm and later.

**Results:** Mean sleep duration was (7.23 hours). Sleep onset was in 66.8% of participants. Mean body mass index (BMI) was significantly higher in participants with short sleep duration ( $p < 0.001$ ). Short sleep duration was associated with younger age, male gender and negative medical history, while significant risk factors for late sleep onset are younger age, students and smoking.

**Conclusions:** The prevalence of abnormal sleep patterns among overweight/obese was high. There is a strong link between short sleep duration and higher BMI.

**Keywords:** *Overweight, Obesity, Sleep duration, Sleep onset.*

## Introduction

Obesity is a global public health problem<sup>1,2</sup>. In Iraq, about one third of population are obese<sup>3, 4</sup>. Obesity in Iraq is commonly related to older age, female gender, illiteracy, unemployment and physical inactivity<sup>5</sup>. Sleep is main health need and required for many body functions. Many authors referred to adverse effects of sleep deprivation on health (physically and mentally) and affect the cognitive processes<sup>6</sup>. Lack of sleep exist when the human being biological need of sleep is not enough. Many definitions of sleep deprivation are found, but mainly the sleep deprivation is defined as sleep of less than 7 hours.<sup>3</sup> It was shown that short duration or poor

quality of sleep lead to abnormal metabolism of glucose and abnormal secretion of anabolic hormones such as growth hormone<sup>6</sup>, testosterone<sup>7</sup> and the prolactin<sup>8</sup>, with changing of amount and time of secretion for other hormones such as glucocorticoids<sup>9</sup>, catecholamines<sup>10</sup> with altering of diet balance<sup>11,12</sup>.

Sleep deprivation and obesity are great health problems that are associated with many individual, social and health economic burden<sup>13, 14,15</sup>. Epidemiological studies held in USA revealed a direct linear association between duration of sleep and body mass index showing that abnormal sleep (long or short duration) was accompanied by adulthood obesity<sup>16,17</sup>. Other literatures found abnormal sleep patterns significantly associated with increased BMI<sup>18, 19,20</sup>. Inversely, many authors documented no relationship observed between sleep duration and overweight or obesity<sup>15, 21, 22</sup>.

Endogenous circadian system is regulating sleeping-awakening rhythms and other metabolism processes<sup>23</sup>. It was shown that timing of sleep early or late had

---

### Corresponding Author:

Maha Sabah Ahmed Al-Jumaili

M.B.Ch.B., F.I.C.M.S (Family Medicine); Lecturer at College of Medicine-Baghdad University-Baghdad  
e-mail: maha4sj@gmail.com

a profound effect on cardiometabolic disorders<sup>24-27</sup>. Abnormal sleep patterns and inadequate sleep duration is commonly related to abnormal dietary habits and lifestyle changes like physical inactivity, heavy diet and sedentary lifestyle<sup>28, 29</sup>.

In Iraq, the sleep problems are frequent among adults especially elderly age population<sup>30-32</sup>.

## Patients and Method

A cross sectional survey carried out in two Nutrition Clinics; Baghdad Teaching Hospital and Surgical Specialties Hospital in Baghdad. during six months; 1<sup>st</sup> of August, 2019 to 31<sup>st</sup> of January, 2020. Including 250 overweight or obese adults aged  $\geq 18$  years of both genders presented to Nutrition Clinics for management of overweight or obesity. Patients currently receiving sleep medications or sedatives, with mental health problems, depressive mood, pregnancy, lactation, night shifts occupation were excluded.

The data were collected by the researcher using a pre designed questionnaire prepared by the researcher depending on previous literatures. Data included general characteristics (age, gender, weight, height, occupation, marital status, smoking and medical history) and sleep patterns. Overweight or obesity defined according to World Health Organization standard values; obesity (BMI: 30 Kg/m<sup>2</sup> and more) and overweight (BMI: 25-29.9 Kg/m<sup>2</sup>)<sup>33</sup>.

The sleep patterns were assessed as the average for the last 7 days. Short sleep duration defined as sleep for <7 hours/day. Latesleep onset defined as sleeping at 11 o'clock pm or later<sup>35</sup>.

The data were analyzed using the Statistical Package of Social Sciences software version 22. Appropriate statistical tests were applied accordingly at level of significance of 0.05 or less.

## Results

This study included 250 overweight/obese adults with mean age of (40.8 years). General characteristics of the study participants are shown in (Table 1).

Mean BMI of adults with short sleep duration was significantly higher than that of adults with normal sleep duration (P. value <0.001). No significant difference in mean BMI across sleep onset (P. value >0.05), (Table 2).

A significant association was found between short sleep duration and each of younger age, male gender, negative medical history and late sleep onset, in all comparison (P. value < 0.05). No significant association was found between sleep duration and other general characteristics variables, (P. value > 0.05), (Table 3).

Regarding the association between sleep onset and general characteristics variables of the study participants, a significant association was found between late sleep onset and each of younger age, being a student and smoking, in all comparison (P. value < 0.05). The association of sleep onset was neither significant with gender, marital status, nor medical history, (P. value > 0.05). (Table 4).

**Table 1. General characteristics of overweight/obese adults (N = 250).**

Variable	No.	%	
Age (year)	<30 years	48	19.2
	30-39 years	80	32.0
	40-49 years	51	20.4
	50-59 years	34	13.6
	$\geq 60$ years	37	14.8
	Mean $\pm$ SD	40.8 $\pm$ 13.4 year	-
Gender	Male	154	61.6
	Female	96	38.4
BMI (Kg/m <sup>2</sup> )	Overweight	62	24.8
	Obese	188	75.2
	Mean $\pm$ SD	32.3 $\pm$ 2.5	-
Occupation	Housewife	42	16.8
	Student	23	9.2
	Public servant	58	23.2
	Self employed	100	40.0
	Retired	27	10.8
Marital status	Married	182	72.8
	Not married	68	27.2
Smoking	Yes	83	33.2
	No	167	66.8
Medical history	Positive	107	42.8
	Negative	143	57.2
Sleep duration	Normal	141	56.4
	Short	109	43.6
	Mean $\pm$ SD	7.23 $\pm$ 1.6 hours	-
Sleep onset	Early	83	33.2
	Late	167	66.8

**Table 2. Distribution of BMI of adults according to sleep duration and onset.**

Variable		BMI (Kg/m <sup>2</sup> ) Mean±SD*	P. value
Sleep duration	Normal	31.6 ± 2.7	<0.001 <sup>S</sup>
	Short	33.2 ± 1.9	
Sleep onset	Early	32.34±2.6	0.900 <sup>NS</sup>
	Late	32.38±2.3	

SD: standard deviation S=Significant.

**Table 3. Distribution of overweight/obese adults' general characteristics according to sleep duration.**

Variable		Sleep Duration				P. value
		Normal		Short		
		No.	%	No.	%	
Age (year)	<30	18	12.8	30	27.5	0.008 <sup>S</sup>
	30-39	50	35.5	30	27.5	
	40-49	25	17.7	26	23.9	
	50-59	21	14.9	13	11.9	
	≥60	27	19.1	10	9.2	
Gender	Male	68	48.2	86	78.9	<0.001 <sup>S</sup>
	Female	73	51.8	23	21.1	
Occupation	Housewife	29	20.6	13	11.9	0.060 <sup>NS</sup>
	Student	11	7.8	12	11	
	Public servant	31	22	27	24.8	
	Self employed	50	35.5	50	45.9	
	Retired	20	14.2	7	6.4	
Marital status	Married	98	69.5	84	77.1	0.100 <sup>NS</sup>
	Not married	43	30.5	25	22.9	
Smoking	Yes	50	35.5	33	30.3	0.300 <sup>NS</sup>
	No	91	64.5	76	69.7	
Medical history	Positive	77	54.6	30	27.5	0.040 <sup>S</sup>
	Negative	64	45.4	79	72.5	
Sleep onset	Early	64	45.4	19	17.4	< 0.001 <sup>S</sup>
	Late	77	54.6	90	82.6	

S: Significant, NS; Not significant

**Table 4. Distribution of overweight/obese adults' general characteristics according to sleep onset.**

Variable		Sleep onset				P. value
		Early		Late		
		No.	%	No.	%	
Age (year)	<30	10	12	38	22.8	0.004 <sup>S</sup>
	30-39	33	39.8	47	28.1	
	40-49	22	26.5	29	17.4	
	50-59	4	4.8	30	18	
	≥60	14	16.9	23	13.8	

Variable		Sleep onset				P. value
		Early		Late		
		No.	%	No.	%	
Gender	Male	48	57.8	106	63.5	0.380 <sup>NS</sup>
	Female	35	42.2	61	36.5	
Occupation	Housewife	8	9.6	34	20.4	<0.001 <sup>S</sup>
	Student	0	0.00	23	13.8	
	Public servant	11	13.3	47	28.1	
	Self employed	51	61.4	49	29.3	
	Retired	13	15.7	14	8.4	
Marital status	Married	61	73.5	121	72.5	0.800 <sup>NS</sup>
	Not married	22	26.5	46	27.5	
Smoking	Yes	17	20.5	66	39.5	0.003 <sup>S</sup>
	No	66	79.5	101	60.5	
Medical history	Positive	37	44.6	70	41.9	0.680 <sup>NS</sup>
	Negative	46	55.4	97	58.1	

S: Significant, NS; Not significant

## Discussion

Sleep is a vital process of our life<sup>36</sup>. Overweight and obesity steadily increased in Iraq during last year's<sup>37</sup>. The present study found that 43.6% of overweight/obese adults had short sleep duration. This findings close to results of Althakafi et al<sup>38</sup> in Saudi Arabia. Our study showed 66.8% had late sleep onset among which is higher than results of Baron et al<sup>39</sup> study in USA. Higher prevalence of late sleeping in current study might be attributed to advanced mobile phone technologies and publicity of social network programs in our society during last ten years. BMI of the study participants in our study was significantly higher with short sleep duration. This finding is consistent with results of previous literatures<sup>40,41</sup>. Our study found no significant relationship between sleep onset and BMI. This is might be due to that all included adults were overweight or obese and higher proportion of them had late sleep onset.

Current study showed a significant association between younger age overweight/obese adults and short sleep duration ( $p=0.008$ ). Similarly, Grandner et al<sup>42</sup> study in USA revealed that relationship between sleep duration and body mass index is dependable on age and reported a significant relationship between short sleep duration and higher BMI among young adults, U- shaped relation between sleep duration and BMI

among middle age adults and less relationship among elderly. These findings are due sociocultural changes in community and widespread technologies that affect young age population leading to shorter sleep duration. Our study found also a highly significant association between males overweight/obese adults and short sleep duration ( $p<0.001$ ). This finding is consistent with results of Watanabe et al<sup>43</sup> study in Japan which stated that increased weight is associated with short sleep duration among men but not among women. In present study, there was a significant association between positive medical history of overweight/obese adults and normal sleep duration ( $p=0.04$ ). This finding might be attributed to fact that elderly age adults accompanying with positive medical history in present study are associated with normal sleep duration than younger age.

In current study, there was a significant association between younger age overweight/obese adults and late sleep onset ( $p=0.004$ ). This finding coincides with results of Ferranti et al<sup>44</sup> which reported a significantly increased body mass index of young age adults with late sleep onset. Our study found a highly significant association was observed between students overweight/obese adults and late sleep onset ( $p<0.001$ ). This finding is similar to results of Gradisar et al<sup>45</sup> study in Australia which reported higher prevalence of delayed sleep onset among younger age students that are related to

obesity and sedentary lifestyle. The habitual changes for young adults is related to advanced technology recently attributed to poor sleep quality<sup>45</sup>. In present study, there was a significant association between smoking of overweight/obese adults and late sleep onset ( $p=0.003$ ). This finding is in agreement with results of Tan et al<sup>46</sup> study in Sweden.

Present study found a highly significant association between late sleep onset of overweight/obese adults and short sleep duration ( $p<0.001$ ). Consistently, Cooper et al<sup>47</sup> study in USA found that sleep duration less than 7 hours is related to obesity of adults and this short sleep duration is strongly linked to late sleep onset. Poor outcomes of abnormal circadian rhythm are aggravated by short sleep duration leading to abnormal metabolic processes and reduction of insulin sensitivity causing overweight and obesity<sup>35</sup>. The main limitations in present study were the inability to assess the direction of relationship as the design is cross sectional, selection bias and absence of adults with normal BMI to compare the sleep patterns with them.

In conclusion, the prevalence of abnormal sleep patterns (short sleep duration or late sleep onset) among overweight/obese adults is high. There is a strong link between short sleep duration and increased body mass index of adults. The common risk factors for short sleep duration are younger age, male gender and negative medical history, while common risk factors for late sleep onset are younger age, students with smoking history. This study recommended more efforts from health authorities and community based institutes to encourage normal patterns and prevent the behaviors that are accompanied by shorter sleep duration or late sleep onset especially for young age population. Further multicenter national surveys on effect of abnormal sleep patterns on health of adults must be supported.

**Ethical Clearance:** Informed consent was obtained from all participants, Data were collected in accordance with declaration of Helsinki of the World Medical Association, 2013

**Conflict of Interest:** Declared none.

**Funding:** None, self-funded

## References

1. Jaacks LM, Vandevijvere S, Pan A, McGowan CJ, Wallace C, Imamura F, et al. The obesity transition: stages of the global epidemic. *Lancet Diabetes Endocrinol* 2019; 7(3):231-240.
2. Flegal KM, Carroll MD, Kit BK, Ogden CL. Prevalence of obesity and trends in the distribution of body mass index among US adults, 1999-2010. *JAMA* 2012; 307:491-497.
3. Mansour AA, Al-Maliky AA, Salih M. Population Overweight and Obesity Trends of Eight Years in Basrah, Iraq. *Epidemiol* 2012; 2:110.
4. World Health Organization-Eastern Mediterranean Region. Framework for health information systems and core indicators for monitoring health situation and health system performance. WHO 2018.
5. Shabu SA. Prevalence of overweight/obesity and associated factors in adults in Erbil, Iraq: A household survey. *Zanco J Med Sci* 2019; 23 (1): 128-134.
6. Spiegel K, Leproult R, Colecchia EF. Adaptation of the 24-h growth hormone profile to a state of sleep debt. *Am J Physiol Regul Integr Comp Physiol* 2000; 279:874-883.
7. Penev P, Spiegel K, L'Hermite-Balériaux M. Relationship between REM sleep and testosterone secretion in older men. *Ann Endocrinol (Paris)* 2003; 64:157.
8. Spiegel K, Leproult R, Van Cauter E. Impact of sleep debt on physiological rhythms. *Rev Neurol (Paris)* 2003; 159(11 Suppl):S11-20.
9. Leproult R, Copinschi G, Buxton O. Sleep loss results in an elevation of cortisol levels the next evening. *Sleep* 1997; 20:865-870.
10. Penev P, Spiegel K, Marcinkowski T. Impact of carbohydrate-rich meals on plasma epinephrine levels: dysregulation with aging. *J Clin Endocrinol Metab* 2005; 90:6198-6206.
11. Spiegel K, Tasali E, Penev P. Brief communication: sleep curtailment in healthy young men is associated with decreased leptin levels, elevated ghrelin levels, and increased hunger and appetite. *Ann Intern Med* 2004; 141:846-850.
12. Nedeltcheva AV, Kilkus JM, Imperial J. Sleep curtailment is accompanied by increased intake of calories from snacks. *Am J Clin Nutr* 2009; 89:126-133.
13. Youngstedt SD, Jean-Louis G. Long sleep a greater mortality risk than short sleep in older adults. *J Am Geriatr Soc* 2011; 59:957-958.

14. Ogden CL, Lamb MM, Carroll MD, Flegal KM. Obesity and socioeconomic status in adults: United States 2005–2008. *NCHS Data Brief* 2010; 50:1–8.
15. Kurina LM, McClintock MK, Chen JH, Waite LJ, Thisted RA, Lauderdale DS. Sleep duration and all-cause mortality: a critical review of measurement and associations. *Ann Epidemiol* 2013; 23:361–370.
16. Patel SR, Zhu X, Storfer-Isser A, Mehra R, Jenny NS, Tracy R, Redline S. Sleep duration and biomarkers of inflammation. *Sleep* 2009; 32:200–204.
17. Buxton OM, Marcelli E. Short and long sleep are positively associated with obesity, diabetes, hypertension, and cardiovascular disease among adults in the United States. *Soc Sci Med* 2010; 71:1027–1036.
18. Hasler G, Buysse DJ, Klaghofer R, Gamma A, Ajdacic V, Eich D, et al. The association between short sleep duration and obesity in young adults: a 13-year prospective study. *Sleep* 2004; 27:661–666.
19. Gangwisch JE, Malaspina D, Boden-Albala B, Heymsfield SB. Inadequate sleep as a risk factor for obesity: analyses of the NHANES I. *Sleep* 2005; 28:1289–1296.
20. Watanabe M, Kikuchi H, Tanaka K, Takahashi M. Association of short sleep duration with weight gain and obesity at 1-year follow-up: a large-scale prospective study. *Sleep* 2010; 33:161–167.
21. Stranges S, Dorn JM, Shipley MJ, Kandala NB, Trevisan M, Miller MA, et al. Correlates of short and long sleep duration: a cross-cultural comparison between the United Kingdom and the United States: the Whitehall II Study and the Western New York Health Study. *Am J Epidemiol* 2008; 168:1353–1364.
22. Bin YS, Marshall NS, Glozier N. Sleeping at the limits: the changing prevalence of short and long sleep durations in 10 countries. *Am J Epidemiol* 2013; 177:826–833.
23. Arble DM, Ramsey KM, Bass J, Turek FW. Circadian disruption and metabolic disease: findings from animal models. *Best Pract Res Clin Endocrinol Metab* 2010; 24(5):785–800.
24. Wong PM, Hasler BP, Kamarck TW, Muldoon MF, Manuck SB. Social Jetlag, Chronotype, and Cardiometabolic Risk. *J Clin Endocrinol Metab* 2015; 100(12):4612–4620.
25. Merikanto I, Lahti T, Puolijoki H, Vanhala M, Peltonen M, Laatikainen T, et al. Associations of chronotype and sleep with cardiovascular diseases and type 2 diabetes. *Chronobiol Int* 2013; 30(4):470–477.
26. Lucassen EA, Zhao X, Rother KI, Mattingly MS, Courville AB, de Jonge L, et al. Evening chronotype is associated with changes in eating behavior, more sleep apnea, and increased stress hormones in short sleeping obese individuals. *PLoS ONE* 2013; 8(3):e56519.
27. Arora T, Taheri S. Associations among late chronotype, body mass index and dietary behaviors in young adolescents. *Int J Obes* 2015; 39(1):39–44.
28. Al-Hazzaa HM, Musaiger AO, Abahussain NA, Al-Sobayel HI, Qahwaji DM. Lifestyle correlates of self-reported sleep duration among Saudi adolescents: a multicentre school-based cross-sectional study. *Child Care Health Dev* 2014; 40:533–542.
29. Westerlund L, Ray C, Roos E. Associations between sleeping habits and food consumption patterns among 10–11-year-old children in Finland. *Br J Nutr* 2009; 102:1531–1537.
30. Al-Akkam EJM, Ismaeel ZH, Mohammed EJ. Common Geriatric Syndromes in Elderly Patients Attending Geriatric Clinic in Medical City. *The Iraqi Postgraduate Medical Journal* 2020; 19 (1): 24-30.
31. Younis MS, Aswad AM. The impact of war and economic sanctions on the mental health system in Iraq from 1990 to 2003: a preliminary report. *Intervention* 2018; 16(1): 54-58.
32. Yasir AA, Al-Mahdi Al-Ameen ZK. Obese and overweight women and public health issues in Hillah city, Iraq. *International Journal of Medical, Health, Biomedical, Bioengineering and Pharmaceutical Engineering* 2016; 10 (3): 164-169.
33. World Health Organization. Obesity and overweight. Key facts. WHO 2020. Available at: <https://www.who.int/news-room/fact-sheets/detail/obesity-and-overweight>
34. Chaput JP, Dutil C, Sampasa-Kanyinga H. Sleeping hours: what is the ideal number and how does age impact this? *Nat Sci Sleep* 2018; 10:421-430.
35. Ogilvie RP, Patel SR. The epidemiology of sleep

- and obesity. *Sleep Health* 2017; 3(5):383-388.
36. Rathod SS, Nagose VB, Kanagala A, Bhuvangiri H, Kanneganti J, Annepaka E. Sleep duration and its association with obesity and overweight in medical students: A cross-sectional study. *Natl J Physiol Pharm Pharmacol* 2018; 8(1):113-117.
  37. Al-Tawil N. G, Abdulla M.M, Abdul Ameer A.J. Prevalence of and factors associated with overweight and obesity among a group of Iraqi women. *East Mediterr J* 2007; 13(2):420-429.
  38. Althakafi KA, Alrashed AA, Aljammaz KI, Abdulwahab IJ, Hamza R, Hamad AF, et al. Prevalence of short sleep duration and effect of co-morbid medical conditions – A cross-sectional study in Saudi Arabia. *J Family Med Prim Care* 2019; 8:3334-3339.
  39. Baron KG, Reid KJ, Kern AS, Zee PC. Role of sleep timing in caloric intake and BMI. *Obesity (Silver Spring)* 2011; 19(7):1374-1381.
  40. Krističević T, Štefan L, Sporiš G. The Associations between Sleep Duration and Sleep Quality with Body-Mass Index in a Large Sample of Young Adults. *Int J Environ Res Public Health* 2018; 15(4):758.
  41. Kohatsu ND, Tsai R, Young T. Sleep Duration and Body Mass Index in a Rural Population. *Arch Intern Med* 2006; 166(16):1701–1705.
  42. Grandner MA, Schopfer EA, Sands-Lincoln M, Jackson N, Malhotra A. Relationship between sleep duration and body mass index depends on age. *Obesity (Silver Spring)* 2015; 23(12):2491-2498.
  43. Watanabe M, Kikuchi H, Tanaka T, Takahashi M. Association of short sleep duration with weight gain and obesity at 1-year follow-up: a large-scale prospective study. *SLEEP* 2010; 33(2):161-167.
  44. Ferranti R, Marventano S, Castellano S, Giogianni G, Nolfo F, Rametta S, et al. Sleep quality and duration is related with diet and obesity in young adolescent living in Sicily, Southern Italy. *Sleep Sci* 2016; 9(2):117-122.
  45. Gradisar M, Crowley SJ. Delayed sleep phase disorder in youth. *Curr Opin Psychiatry* 2013; 26(6):580-585.
  46. Tan X, Chapman CD, Cedernaes J, Benedict C. Association between long sleep duration and increased risk of obesity and type 2 diabetes: A review of possible mechanisms. *Sleep Med Rev* 2018; 40:127-134.
  47. Cooper CB, Neufeld EV, Dolezal BA, Martin JL. Sleep deprivation and obesity in adults: a brief narrative review. *BMJ Open Sport & Exercise Medicine* 2018; 4:e000392.

# Analysis of Prothrombin Time (PT) and Activated Partial Thromboplastin Time (aPTT) in Patients with Acute Myocardial Infarction on Anticoagulation Therapy to Assess the Thrombogenic Potential

Shubhi Saxena<sup>1</sup>, Nishant Saxena<sup>2</sup>, Richa Jain<sup>3</sup>, Jasmin Jasani<sup>4</sup>

<sup>1</sup>Assistant Professor, Department of Pathology, <sup>2</sup>Senior Resident, Department of Cardiology, <sup>3</sup>Assistant Professor, Department of Pathology, <sup>4</sup>Professor, Department of Pathology, Smt. B K Shah Medical Institute and Research Centre, Sumandeep Vidyapeeth Deemed University, Pipariya, Waghodia Road, Vadodara, Gujarat, 391760

## Abstract

**Background:** Activated partial thromboplastin time and prothrombin time measures the action of the intrinsic and extrinsic pathways of coagulation needed to maintain homeostasis in the body. We studied aPTT and PT levels in acute myocardial infarction (AMI) patients on anticoagulation therapies and normal subjects. The aim of the study is to assess aPTT and PT in patients of acute MI on anticoagulation.

**Materials And Method:** This study was conducted on 42 patients with chest pain and 84 AMI patients, admitted to Dhiraj hospital, Vadodara. The AMI patients were classified into STEMI (n=28) and NSTEMI (n=56). PT and aPTT were assayed on a fully automatic Stago-coagulometer instrument (STA Compact Max).

**Conclusion:** Patients with STEMI had mean aPTT of  $40.79 \pm 1.83$  s, NSTEMI had  $41.33 \pm 2.06$  s, aPTT in control subjects was  $31.35 \pm 0.48$  s. Patients with acute coronary syndrome had significantly higher levels of aPTT. Patients with STEMI has PT of  $17.42 \pm 5$  s, NSTEMI had  $18.56 \pm 5$  s. Patients on anticoagulation therapy had higher aPTT and PT values. Both PT and aPTT are high in acute MI patients on anticoagulants. The elevations in PT values were more than 3 fold greater than aPTT suggesting that PT has a higher sensitivity for predicting blood clotting capacity in patients already on anticoagulations.

**Keywords:** AMI, STEMI, PT, aPTT, thrombogenic potential.

## Introduction

For maintenance of hemostasis, there is a balanced equilibrium needed between thrombus destruction and thrombus formation. This fine balance is maintained by an interactive foreplay between platelets, coagulation

factors, the vascular endothelium and the fibrinolytic system. The coagulation cascade involves an interaction between the contact activation pathway or the intrinsic system and the tissue factor pathway or the extrinsic system. These two independent pathways lead to the conversion of factor X to Xa, which is the beginning of the common pathway. This common pathway converts prothrombin to thrombin, which subsequently catalyzes the formation of fibrin and ultimately leads to the stabilization of aggregated platelets to form a stable clot<sup>1,2</sup>

PT measures the number of seconds it takes to form a clot in our sample of blood after reagents are added. The PT is often performed along with a partial thromboplastin time (PTT) and together they assess

---

### Corresponding Author:

**Dr. Nishant Saxena**

Senior Resident, Department of Cardiology, E6 Staff Quarters, Sumandeep Vidyapeeth Deemed University, Vadodara, Gujarat, 391760

e-mail: nsaxena014@gmail.com

Contact Number: 9929460540



the amount and function of coagulation factors that are needed for blood clot formation.

- The PT test evaluates coagulation factors in the extrinsic and common pathways of the coagulation cascade work together: factors I (Fibrinogen), II (Prothrombin), V, VII and X.
- The aPTT, which evaluates the clotting factors that are part of the intrinsic and common pathways: XII, XI, IX, VIII, X, V, II (prothrombin) and I (fibrinogen) as well as prekallikrein (PK) and high molecular weight kininogen (HK)<sup>3</sup>

During a laboratory test, there are two “pathways” that can initiate clotting, the extrinsic and intrinsic pathways. Both of these then merge into a common pathway to complete the clotting process<sup>4</sup>. Increase fibrinopeptide A in MI predisposes patients to increased risk for sudden cardiac death<sup>5</sup>. Increase in fibrin turn over can be estimated by plasma concentrations of crosslinked FDP’s (fibrin degradation products), proves to be a marker for risk of myocardial infarction<sup>6</sup>. Soluble fibrin was found significantly higher in acute coronary syndrome patients than in controls especially in young myocardial infarction<sup>7</sup>. The PT and PTT evaluate the overall ability to produce a clot in a reasonable amount of time and, if any of these factors are deficient in quantity or not functioning properly, the test results will be prolonged.

## Materials and Method

This study was conducted on 84 AMI patients and 42 patients with chest pain, admitted to Dhiraj Hospital coronary care unit, Sumandeep Vidyapeeth deemed university, Vadodara, Gujarat for a period of 1 year from January 2019 to January 2020. The AMI patients were classified into STEMI (n=28) and NSTEMI (n=56). Mean age group of STEMI, NSTEMI patients were 60-70 years and 50-60 years respectively. All the AMI patients received standard IHD treatment according to recent ACC/AHA guidelines.

### The diagnosis of myocardial infarction done by any two:

- Troponins levels above the 99<sup>th</sup> percentile of upper limit of normal
- History of prolonged dull aching radiating chest pain or discomfort with perspiration

- Presence of new bundle branch blocks, Q waves or new abnormal ST-T depressions or elevations<sup>8</sup>.

### Patients with STEMI were classified on the basis of:

- ST-segment elevation of  $\geq 0.1-0.2$  mV in  $\geq 2$  contiguous precordial leads or  $\geq 0.2$  mV in  $\geq 2$  contiguous limb leads or development of new left bundle branch block.
- Presentation within the first 24 hours from first episode of chest pain.
- Continuous chest pain not relieved by nitrates or rest and lasting  $\geq 30$  min<sup>9</sup>.

### Patients with NSTEMI were required to have:

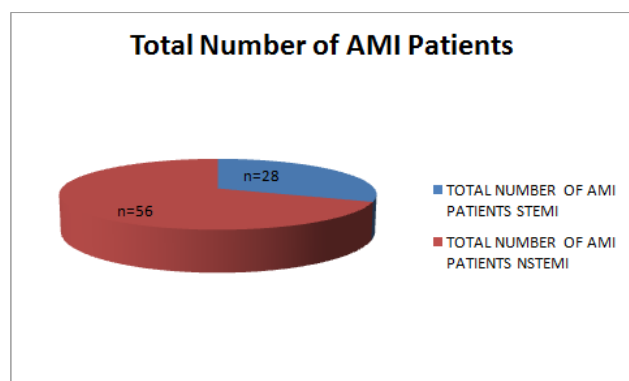
- ST segment downloping sagging of  $\geq 0.1-0.2$  mV in  $\geq 3$  contiguous ECG leads.
- Typical radiating chest pain even at rest lasting  $\geq 15$  min<sup>9</sup>.

The patient exclusion criteria included chronic inflammatory diseases, active infection, recent surgery, significant renal or hepatic dysfunction and malignancy.

Blood samples for aPTT and PT were collected in 3.2% trisodiumcitrate anticoagulant vacutainers in the proportion of 1 volume of citrate to 9 volumes of blood is processed by centrifugation at room temperature for 15 minutes at 2000 rpm. Prothrombin time (PT), activated partial thromboplastin time (aPTT) assayed on a fully automatic Stago coagulometer instrument (STA Compact Max) which is based on clotting time or clot-based tests (i.e. chronometric) measurements and photometric assays (at specific wave lengths) on plasma samples.

## Results and Discussion

This study was conducted on 84 acute MI patients and 42 patients with chest pain. The AMI patients were classified into STEMI (n=28) and NSTEMI (n=56) (Graph 1). Mean age group of STEMI, NSTEMI and chest pain patients were 65-75 years, 55-65 years and 45-55 years respectively (Table 1). Their were significant increase in PT level in NSTEMI from 13 s to 23 s as compared to control group which ranges from 11 s to 14 s. PT levels in patients with STEMI ranging from 12 s to 22 s. The level of aPTT in control subjects was 30 s to 40 s. Patients with NSTEMI shows 37 s to 47 s and STEMI shows 35 s to 45 s which has significantly higher levels of aPTT. (Table 2).



**Graph 1: Total number of AMI patients.**

**Table 1: Mean Age group of AMI patients**

Mean Age Group of AMI Patients	
AMI Patients	Age Group in years
Stemi	55-65
Nstemi	45-55

**Table 2: Alterations in PT & aPTT**

Alterations in PT & aPTT of AMI Patients			
S.No.	Patients	PT	aPTT
1	Stemi	12-22 sec	35-45 sec
2	Nstemi	13-23 sec	37-47 sec
3	Control	11-14 sec	30-40 sec

Patients of acute myocardial infarction are on dual antiplatelets and anticoagulants like unfractionated heparin, low-molecular weight heparin or warfarin, for which PT and aPTT are used.

PT/INR detects disorders of the extrinsic and common coagulation pathways. Abnormal result is usually seen when factor I, II, V, VII, X are deficient [10] while the aPTT looks for abnormalities of the intrinsic and common coagulation pathways. It monitors the activities of FI, II, V, VIII, IX, X, XI, XII<sup>11</sup>. Schwartz et al<sup>12</sup> studied 220 subjects with acute coronary syndrome and found out that 30 (13.6%) and 28 (12.7%) had INR and aPTT values not within the reference range. Salomonson studied that patients reaching the therapeutic aPTT threshold after heparin treatment within 1 day were less than those who did not reach threshold suggesting that a non-weight based heparin regimen is ineffective in the achievement of therapeutic aPTT<sup>9</sup>. Pearson showed positive correlations for myocardial infarction and death in ACS patients treated with unfractionated heparin but negative correlations between aPTT and the day of onset

of recurrent angina. aPTT tended to be prolonged in the group with physical training, while it was shortened in the control group<sup>13</sup>. Granger et al<sup>14</sup> showed a positive correlation between the aPTT and the risk of subsequent reinfarction. PT and aPTT may also be used to monitor therapy in acute myocardial infarction with or without venous thromboembolism, atrial fibrillation or LV clot.

### Conclusion

Both PT and aPTT are useful to measure the thinning potential of the blood and can be used to guide medical therapy and post PTCA patients also to prevent stentthrombosis. The values of aPTT are higher in acute coronary syndromes due to associated usage of anticoagulation to stop further thrombosis in coronaries. The elevations in PT values were more than 3 times higher than aPTT suggesting a greater responsive potential of PT for predicting blood clotting tendency in patients receiving anticoagulation therapy.

**Ethical Clearance:** Taken from sumandeep vidyapeeth deemed university ethical committee.

**Source of Funding:** Self funded

**Conflict of Interest:** Nil

### References

1. Kostis JB, Baughman DJ and Kuo PT. Association of recurrent myocardial infarction with hemostatic factors: a prospective study. *Chest* 1982;81:571-75.
2. Li YH, Teng JK, Tsai WC, Tsai LM, Lin LJ, Guo HR and Chen JH. Prognostic significance of elevated hemostatic markers in patients with acute myocardial infarction. *Journal of American College of Cardiology* 1999;33:1543-48.
3. Galvani M, Ferrini D, Ottani F and Eisenberg PR. Early risk stratification of unstable angina/non-Q myocardial infarction: biochemical markers of coronary thrombosis. *International Journal of Cardiology* 1999;68 Suppl 1: S55-S61.
4. Derhaschnig U, Laggner AN, Röggl M, Hirschl MM, Kapiotis S, Marsik C and Jilma B. Evaluation of coagulation markers for early diagnosis of acute coronary syndromes in the emergency room. *Clinical Chemistry* 2002;48:1924-30.
5. Saigo M, Waters DD, Abe S, Biro S, Minagoe S, Maruyama I and Tei C. Soluble fibrin, C-reactive protein, fibrinogen, factor VII, antithrombin,

- proteins C and S, tissue factor, D-dimer, and prothrombin fragment 1+ 2 in men with acute myocardial infarction  $\leq$  45 years of age. *American Journal of Cardiology* 2004;94:1410-13.
6. Alpert JS, Thygesen K, Antman E and Bassand JP. Myocardial infarction redefined—a consensus document of The Joint European Society of Cardiology/American College of Cardiology Committee for the redefinition of myocardial infarction. *Journal of American College of Cardiology* 2000;36:959-69.
  7. Braunwald E. Unstable angina: a classification. *Circulation* 1989;80:410-14.
  8. Ng VL. Prothrombin time and partial thromboplastin time assay considerations. *Clinical Laboratory of Medicine* 2009;29:253–63.
  9. Korte W, Clarke S, Lefkowitz JB. Short activated partial thromboplastin times are related to increased thrombin generation and an increased risk for thromboembolism. *American Journal of Clinical Pathology* 2000;113:123–27.
  10. Schwartz D. Utility of routine coagulation studies in emergency department patients with suspected acute coronary syndromes. *Israel Medical Association Journal* 2005;7:502-06.
  11. Salamonson Y. The ineffectiveness of a nonweight based heparin regimen in achieving therapeutic activated partial thromboplastin time (aPTT) in acute coronary syndrome. *AustCrit Care* 2000;13:128-33.
  12. Mitrovska S and Jovanova S. Correlation between the aPTT and clinical events in acute coronary syndromes treated with unfractionated heparin. *BratislLekListy* 2006;107:422-25.
  13. Suzuki T, Yamauchi K, Yamada Y, Furumichi T, Furui H, Tsuzuki J, Hayashi H, Sotobata I and Saito H. Blood coagulability and fibrinolytic activity before and after physical training during the recovery phase of acute myocardial infarction. *Clinical Cardiology* 1992;15:358-64.
  14. Granger CB, Hirsch J, Califf RM, Col J, White HD, Betriu A, Woodlief LH, Lee KL, Bovill EG, Simes RJ and Topol EJ. Activated partial thromboplastin time and outcome after thrombolytic therapy for acute myocardial infarction: results from the GUSTO-I trial. *Circulation* 1996;93:870-78.

# Correlation of the Stature to Forearm Length in the Young Adults of Western Indian Population

Suryabhan S. Dongre<sup>1</sup>, Ravindra B. Deokar<sup>2</sup>, Sachin S. Patil<sup>3</sup>

<sup>1</sup>Associate Professor & Head, Department of Agadtantra, APM's AyurvedMahavidyalaya, Sion, Mumbai, 400 022, Maharashtra, India, <sup>2</sup>Professor (Additional), Department of Forensic Medicine and Toxicology, Seth G.S. Medical College & KEM Hospital, Mumbai, 400 012, Maharashtra, India, <sup>3</sup>Associate Professor, Department of Forensic Medicine and Toxicology, Seth G.S. Medical College & KEM Hospital, Mumbai, 400 012, Maharashtra, India

## Abstract

**Introduction:** Forensic anthropometry dealing with the application of anthropometric measurements of human individual for the purposes of the identification of human remains. Inter and intra population variations can be observed in relation to anthropometric measurements due to factors such as genetic makeup, age, gender and ethnicity and help in the identification of individual in criminal investigations.

**Method:** This is cross sectional study using young adult students of age group 17 to 24 years. Participants enrolled after due consent and stature(S) and forearm length (FAL) were measured using standard anthropometric techniques. SPSS statistical package used to calculate Pearson's coefficients of correlation and regression equations between stature and the anthropometric variables.

**Results:** There were total 255 participants including 54 (21.18%) males and 201 (78.82%) females. Regression equation for estimation of stature from right forearm length is  $S = 1.4111 \text{ Rt FAL} + 126.72$ , and from left forearm length is  $S = 1.3774 \text{ Lt FAL} + 128.39$ . There were strong positive correlations between height and forearm lengths in all regressions ( $r > 0.9$ ;  $p < 0.0001$ ).

**Conclusions:** The proposed regression equations based on forearm length presented here will simplify the task of stature estimation for adults in clinical forensic medicine or as aids to the identification in criminal investigation in endogenous population. The left forearm length is more accurate in estimating the stature of young adults of western Indian population.

**Keywords:** Clinical Forensic Medicine, Identification, anthropometry, regression, Height.

## Introduction

Anthropometry refers to the systematic measurement of the physical properties of the human

body, mainly dimensional descriptors of body size and shape. The science dealing with the study of systemic measurements of the human individual is called as Anthropometry.<sup>1</sup> Forensic anthropometry dealing with the application of anthropometric measurements of human individual for the purposes of the identification of human remains. Other medicolegal facts can be determined such as establishing the age at the time of death, sex, stature, body type (somatotype) and any other distinguishing characteristics based on physical and skeletal measurements helping in identification of the deceased individual.<sup>2,3</sup>

---

### Corresponding Author:

**Dr. Ravindra Baliram Deokar**

MD[FM], LLB, LLM (Human Rights), Professor (Additional), Department of Forensic Medicine & Toxicology, Seth G.S. Medical College & KEM Hospital, Mumbai, 400 012, Maharashtra, India  
e-mail: ravideo80@gmail.com

Contact Number: +919869741117/9423016325

In the field of scientific research in Clinical Forensic Medicine, various anthropometric parameters like arm

span, biacromial shoulder width, hand length, forearm length, foot length and breadth, etc. may be used to predict the stature i.e. individual's height.<sup>4,5</sup> Various studies conducted to predict stature using various parts of human body and skeleton.<sup>6</sup> Forearm length can be helpful in predicting the individual's stature in mutilated bodies with remains involving upper limbs.<sup>7</sup> The stature can be predicted on the basis of forearm length and can be estimated using various regression equations.<sup>8,9</sup>

Several researchers studied relation between stature and upper limb segments measurements such as arm span, Biacromial width, arm length, forearm length, hand length in different populations.<sup>5-15</sup> Many authors had been demonstrated strong relationship between stature and forearm length.<sup>8, 9, 14-16</sup> Due to racial and ethnic variations in Indian population, the region-wise, population-based anthropometric studies are necessary in India. This study was undertaken to compare the stature (S) to forearm length (FAL) in western Indian population involving young adults to formulate a regression equation and to determine correlation between Stature and Forearm length.

## Materials and Method

**Study design and Procedure:** This was a cross sectional study conducted in the Department of Agadtantra, APM's Ayurved Mavidyalaya, Sion, Mumbai, Maharashtra, India after institutional ethical committee approval. The study was conducted over a period of 2 years, from June 2015 to June 2017. Most of the students of this institution in this period, those fulfilling the inclusion criteria and giving voluntary consent to involve in the study were considered as the subjects for this study.

**Study Participants:** By simple random sampling, two hundred fifty-five students (54 males & 201 females) of this institution with ages between 17 to 24 years were included in this study. The written informed consent was taken from all subjects. The students of this specific region of ancestral origin were the target population. All subjects were measured approximately at the same time in the morning hours. Subjects with limb or vertebral column deformities, injury, fracture or those who

underwent an operative procedure on spine/extremities, or abnormal gait were excluded from the study. All the measurements were tabulated and subjected to statistical analysis.

**Measurements:** Stature, forearm lengths of right (Rt) and left (Lt) forearms of the subjects were measured. The unit used throughout the study is centimeters. All observations were recorded in a predesigned proforma. Measurements were taken by the first author to avoid inter-observer bias

**Stature (S):** Stature (S) was measured with a stadiometer with movable headboard. It was taken from the vertex to the floor with the person standing barefoot in the anatomical position and with the head in Frankfurt horizontal plane (i.e. the line joining the inferior margin of the orbit and upper margin of external auditory meatus). The subjects were asked to stand on a horizontal even surface against a vertical plane in an erect posture, with feet in close approximation, hands by their side. The shoulders and buttocks were touching the vertical plane.

**Forearm Length (FAL):** The subject asked to stand erect with back to the wall, both arms abducted to 90°. For taking measurements, the forearm on each side is flexed at 90° at elbow joint with extended wrist and the palms facing upwards. The forearm & hand is supported on a flat adjustable top of a table for measurement purposes. Forearm length was measured with a flexible steel tape from the tip of the olecranon process to the point between radius & ulnar tuberosity. Readings were taken to the nearest 0.1 cm.

**Statistical Analysis:** The data obtained were analyzed statistically using SPSS (Statistical Package for Social Sciences) version 16.0 computer software (SPSS, Inc., Chicago, IL).

## Results

There were total 255 participants including 54 (21.18%) males and 201 (78.82%) females. The descriptive statistics for stature and forearm length are shown in **Table 1**.

**Table No. 1: Descriptive Statistics of stature (S) and Forearm length (FAL) of whole sample.**

Parameter	Minimum	Maximum	Mean	Std. Deviation	N	SEM
Stature(S)	145.0	179.0	161.172	6.7755	255	0.4239
Right Forearm Length (Rt FAL)	12.5	35.7	24.4	4.704	255	0.29
Left Forearm Length (Lt FAL)	11.9	35.8	23.8	4.858	255	0.30
Average Forearm Length (Av FAL)	12.2	35.75	24.1	4.774	255	0.30

The differences between male and female group were compared using unpaired t-test (S, Rt FAL, Lt FAL, Av FAL). Stature (S) of the participants ranged from 152.0 to 179.0 cm in males and 145.0 to 175.0 cm in females. Mean stature in males (167.8 cm) was significantly larger ( $p < 0.001$ ) than that in females (159.4 cm). Right Forearm (Rt FAL) of the participants ranged from 17.6 to 35.7 cm in males and 12.5 to 34.4 cm in females. Mean Right forearm in males (28.9cm) was significantly larger ( $p < 0.001$ ) than that in females

(23.2 cm). Left Forearm (Lt FAL) of the participants ranged from 16.9 to 35.8 cm in males and 11.9 to 34.2 cm in females. Mean left forearm in males (28.5 cm) was significantly larger ( $p < 0.001$ ) than that in females (22.5 cm). Average Forearm (Av FAL) of the participants ranged from 17.25 to 35.75 cm in males and 12.2 to 34.3 cm in females. Mean average forearm in males (28.7 cm) was significantly larger ( $p < 0.001$ ) than that in females (22.9 cm). Sex-wise descriptive statistics for stature and forearms length are shown in **Table 2**.

**Table 2: Sex-wise descriptive statistics for Stature (S), Right Forearm length (Rt FAL), Left Forearm length (Lt FAL), Average Forearm length (Av FAL).**

Indicator	Stature (S).		Right Forearm Length (Rt FAL)		Left Forearm Length (Lt FAL)		Average Forearm Length (Av FAL)	
	Sex		Sex		Sex		Sex	
	F	M	F	M	F	M	F	M
Count	201	54	201	201	201	54	201	54
Minimum	145.0	152.0	12.5	17.6	11.9	16.9	12.2	17.25
Maximum	175.0	179.0	34.4	35.7	34.2	35.8	34.3	35.75
Mean	159.4	167.8	23.2	28.9	22.5	28.5	22.9	28.7
Median	159.0	168.0	22.9	29.5	22.3	29.1	22.6	29.1
Mode	157.0	171.0	25.1	29.5	22.3	31.3	21.15	29.1
Standard Deviation	5.9	5.9	4.12	3.99	4.20	4.17	4.15	4.07
Standard Error of Mean	0.41	0.80	0.29	0.54	0.30	0.57	0.29	0.55
Percentile 05	150.0	156.0	16.50	20.50	16.10	19.90	16.25	20.30
Percentile 25	156.0	165.0	20.70	27.30	19.80	26.70	20.20	27.00
Percentile 75	164.0	171.4	26.20	31.60	25.40	31.30	25.65	31.40
Percentile 95	168.9	177.0	30.10	35.30	29.50	34.90	29.70	35.10
Percentile 99	172.0	179.0	32.40	35.70	31.60	35.80	32.00	35.75

Scatter diagram and regression line plotted to show relationship for whole sample for estimation of stature from Right forearm, left forearm shown in **fig. 01 to 02**.

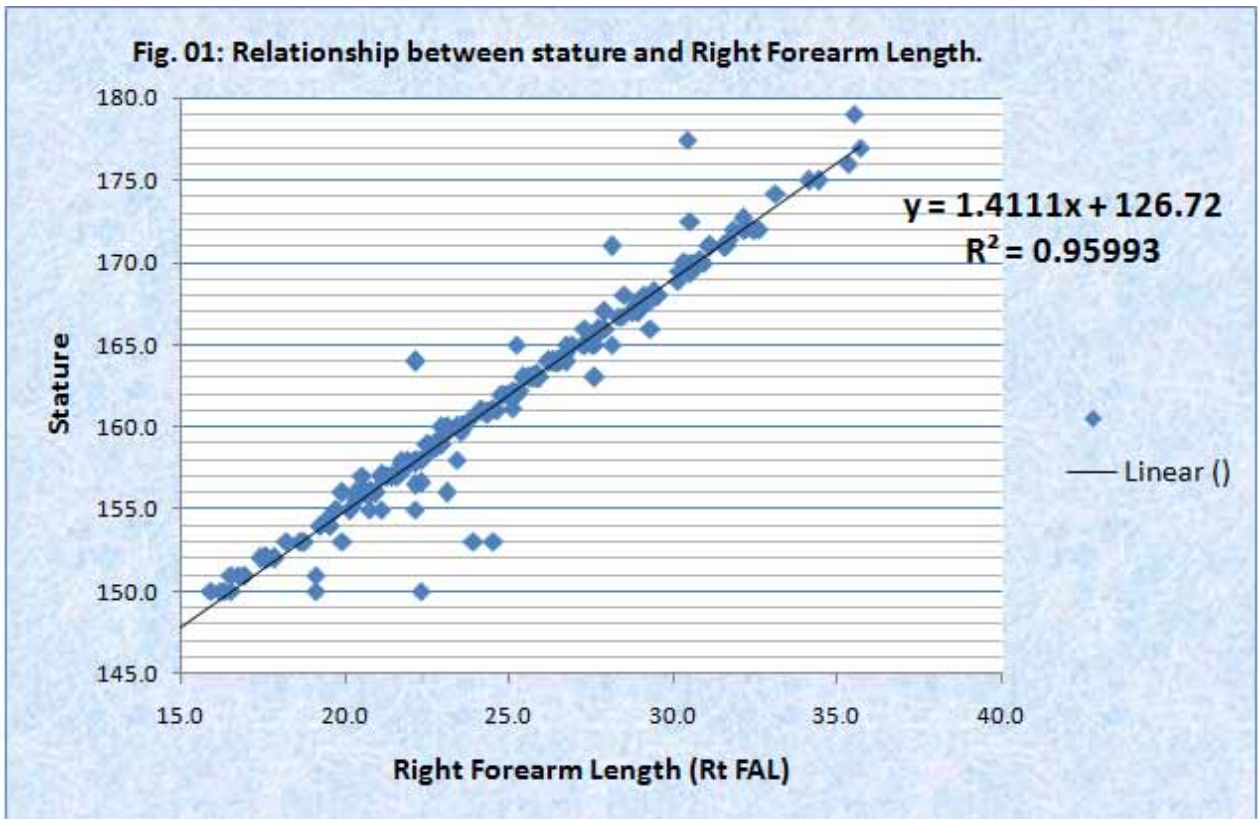


Figure 1: Scatter diagram and regression line showing relationship between stature and Right Forearm length. (All dimensions in Centimeters).

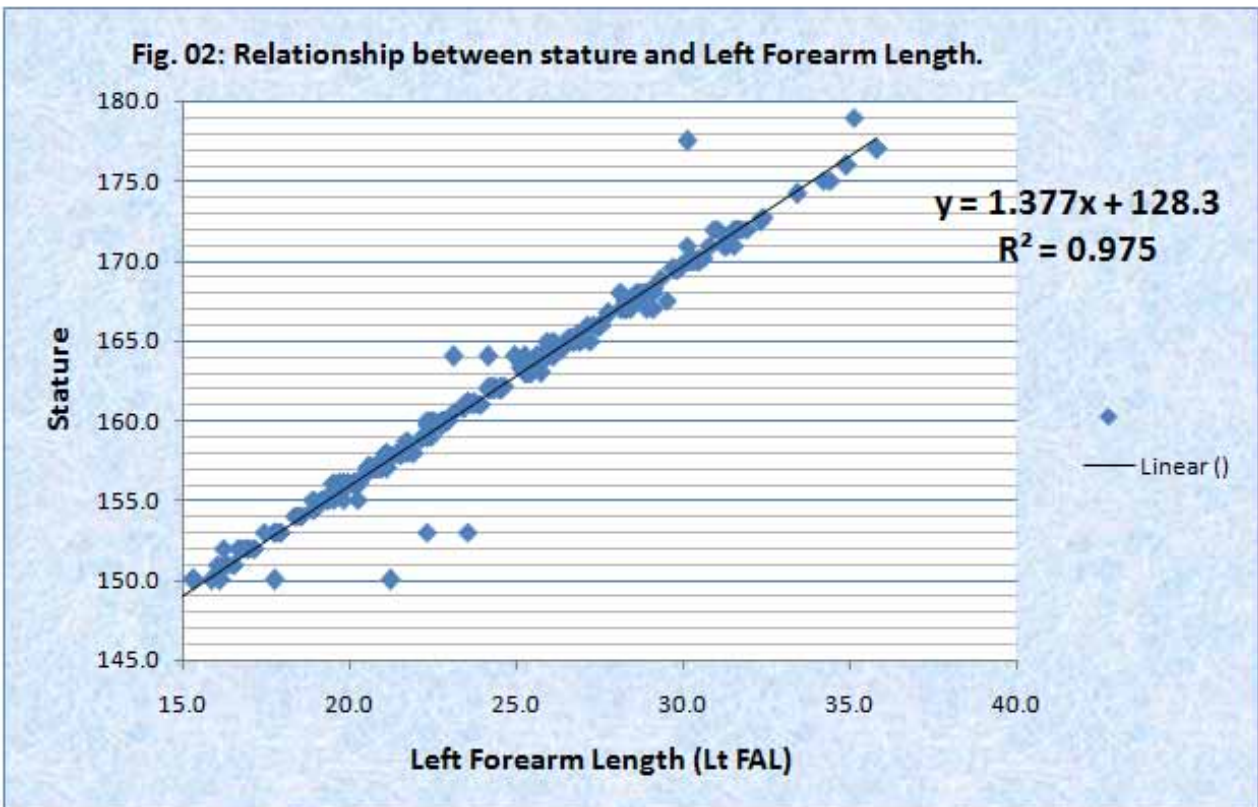


Figure 2: Scatter diagram and regression line showing relationship between stature and Left Forearm length. (All dimensions in Centimeters).

Linear regression equations were derived for whole sample, for total males & females separately for estimation of stature from right forearm length, left forearm length and average forearm length. The right arm length and left forearm length were used as the dependent variable to calculate the estimated stature.

The resulting linear regression equation in the form of  $y = ax + b$  (where, 'y' is stature in centimeters; 'x' is actual forearm length in centimeters; 'a' is the slope of regression line and 'b' is the intercept of the regression line) were tabulated in **table no. 03**.

**Table No. 03: Various Linear regression equations for stature with forearm lengths (Right, Left average in whole sample, male & females.**

Regression Group	Linear Regressions	Linear Regressions	R <sup>2</sup>	R
Stature with Right Forearm length (whole Sample)	$y = 1.4111x + 126.72$	$S = 1.4111x + 126.72$	0.95993	0.979760
Stature with Left Forearm length (whole Sample)	$y = 1.3774x + 128.39$	$S = 1.3774x + 128.39$	0.97523	0.987537
Stature with Average Forearm length (whole Sample)	$y = 1.3982x + 127.46$	$S = 1.3982 AV FAL + 127.46$	0.97056	0.985170
Stature with Right Forearm length (Female)	$y = 1.3852x + 127.26$	$S (F) = 1.3852 RT FAL (F) + 127.26$	0.94867	0.973997
Stature with Left Forearm length (Female)	$y = 1.3711x + 128.52$	$S(F) = 1.3711 LT FAL (F) + 128.52$	0.96888	0.984317
Stature with Right Forearm length (Male)	$y = 1.4296x + 126.42$	$S (M) = 1.4296 RT FAL (M) + 126.42$	0.94067	0.969881
Stature with Left Forearm length (Male)	$y = 1.3817x + 128.32$	$S (M) = 1.3817 LT FAL (M) + 128.32$	0.95908	0.979326
Stature with Average Forearm length (Female)	$y = 1.3828x + 127.78$	$S (F) = 1.3828 AV FAL (F) + 127.78$	0.96207	0.980852
Stature with Average Forearm length (Male)	$y = 1.4138x + 127.14$	$S (M) = 1.4138 AV FAL (M) + 127.14$	0.95583	0.977666

Right Forearm length (Rt FAL) showed high positive value of correlation coefficient (>0.9) which suggest a strong positive correlation between stature and Rt FAL [Figure 1]. Standard error for the total sample is ± 0.29. The equation derived for total sample can be used within the predictive range (R<sup>2</sup>) of ± 0.9599 for right forearm length. Left forearm showed high positive value of correlation coefficient (>0.9) which suggest a strong positive correlation between stature and left forearm length [Figure 2]. Standard error for the total sample

is ± 0.30. The equation derived for total sample can be used within the predictive range (R<sup>2</sup>) of ± 0.9752 for Left Forearm length. Regression equation for estimation of stature from right forearm length is  $S = 1.4111 Rt FAL + 126.72$ , and from left forearm length is  $S = 1.3774 Lt FAL + 128.39$ .

The observed linear correlation of the various parameters tabulated with Pearson's correlation coefficient value tabulated in **table no. 04**.

**Table 04: Correlations for whole sample size (Whole sample)**

		Stature	Right FAL	Left FAL	Average FAL
Stature (S)	Pearson Correlation	1	.980**	.988**	.985**
	Sig. (2-tailed)	-	.000	.000	.000
	N	255	255	255	255
Right FAL	Pearson Correlation	.980**	1	.994**	.998**
	Sig. (2-tailed)	.000	-	.000	.000
	N	255	255	255	255



		Stature	Right FAL	Left FAL	Average FAL
Left FAL	Pearson Correlation	.988**	.994**	1	.999**
	Sig. (2-tailed)	.000	.000	-	.000
	N	255	255	255	255
Average FAL	Pearson Correlation	.985**	.998**	.999**	1
	Sig. (2-tailed)	.000	.000	.000	-
	N	255	255	255	255

\*\*Correlation is significant at the 0.01 level (2-tailed).

Regressions are given in Tables indicates highly significant results for all regressions ( $r > 0.9$ ;  $p < 0.0001$ ); t-statistics for intercepts and slopes likewise display high significance in all cases. Correlations between stature to Right forearm length/left forearm length are very high for all and highly predictive with the left forearm measurements.

### Discussion

In absence of whole body of individual, where the accurate, direct measurement for stature is not possible, other parameters are used to predict individual's stature as it is the most important and useful anthropometric parameter to establish the physical identity of an individual.<sup>2,4</sup> Forearm length can be used to predict stature in mutilated remains involving part of upper limb of deceased person or in living subjects, if stature measurement not possible due to vertebral column deformity, bedridden, old or frail patients.<sup>5-7</sup>

In the present study, a total of 255 students between the age of 17 and 24 years were considered. As maximum height of an individual is attained between 17 and 24 years, these individuals were selected for the study. Many recent studies<sup>8,9,11,14-16</sup> also enrolled subjects of same age group.

In present study, we observed that the males have higher anthropometric measurement than that of females.<sup>8-11</sup> These differences can be due to gender associated hormonal factors, genetic factors and lifestyle factors. Age of puberty being later in males and even the bony epiphyseal fusions are around two year later in males as compared to females leads to additional growth and increase in height. Inter and intra population variations were observed in relation to anthropometry due to factors such as genetic makeup, age, gender and ethnicity.<sup>9-14</sup>

In our study, mean right forearm length in male (28.9) was more than female (23.2), and mean left forearm length in male (28.5) was more than female (22.5). The differences were statistically significant ( $P < 0.001$ ). So, the same regression equation can't be used in both sexes to estimate stature. We found strong correlation between stature and forearm length and it was similar to the previous studies.<sup>9,15,16</sup> Chikhalkar et al<sup>9</sup> showed that the highest degree of correlation ( $r = 0.6558$ ) with forearm length followed by foot-length ( $r = 0.6102$ ) of stature. Our study showed the comparable results with more strong correlation.

Ilayperumaet al<sup>14</sup> conducted a study on 258 medical students (140 males and 118 females) of faculty of medicine, university of Ruhana, Galle, Srilanka in age range of 20-23 years with a mean value of stature in males and females was  $170.14 \pm 5.22$  cm. The mean forearm length in Srilankan male and females was  $27.56 \pm 1.30$  and  $25.11 \pm 1.24$  cm compared with Western Indian males and females was  $28.5 \pm 4.17$  cm and  $22.5 \pm 4.2$  cm respectively. The r vale values for Shrilankan males & females were 0.66 and 0.76 respectively and 0.9843 and 0.9793 for Western Indians, respectively.

Nath et al<sup>15</sup> conducted a research for reconstruction of stature using percutaneous length of forearm bones among the 199 Munda (110 males and 89 females) of Midnapur district, West Bengal in age group of 18-30 years. The mean value of stature in males was 156.19 cm whereas in Western Indian males it was 167.8 cm. Similarly, the mean value of stature in Munda females was 148.64 cm whereas in Western Indian females were 159.4 cm. The mean values of forearm length in Munda males and females was 24.60 cm and 22.85 cm respectively and in Western Indian males & females were 28.5 cm and 22.5 cm for left forearm and 28.9 cm and 23.2 cm for right forearm, respectively.

2.2cm and  $26.56 \pm 15.01$ cm respectively. The 'r' value was 0.66 and 0.76 in Srilankan and 0.601 and 0.53 respectively for North Indians

The stature found by different authors<sup>5,8,9,14-16</sup> in India in different region or state is different than the present study. Author from Chandigarh (North India)<sup>16</sup> found mean (SD) stature of male was 168.2 (6.5) and offemale was 155 (5.2). These variations could be due to different genetic constitution, environmental factors and nutrition in different population groups.<sup>15,16</sup> In this study, students were enrolled which are from middle to higher socioeconomic class. So, the anthropometric measurements may be on higher side in comparison to the general population. A community based study to formulate regression equation for all population needed.

### Conclusion:

Average Stature of male was 167.8 ( $\pm 5.9$ ) cm, and it was more than female [159.4( $\pm 5.9$ ) cm] with statistical significance. Similarly, right and left forearm lengths of male was more than that of female. We found correlation coefficient (*R*) of 0.9699 in male and 0.9739 in female for stature using simple regression with right forearm and 0.9698 in male and 0.9843 in female for stature using simple regression with left forearm, which shows strong correlation between stature and forearm length. Stature can be accurately estimated from forearm length more precisely with left forearm length using simple regression equation.

We proposed that these regression equations presented by this study will help the task of stature estimation for adults in forensics to aid in identification in criminal investigation. Especially in endogamous populations, correlation coefficients for forearm lengths and stature are high, and thus applicable for identification in the forensic field. These population specific results may be applied in endogenous populations only.

**Conflict of Interests:** None.

**Source of Funding:** None.

**Ethical Clearance:** Yes.

**Contributor-ship of authors:** Data collection done by first author. All the authors contributed equally in conception, analysis and interpretation of the study as well drafting, revising the manuscript and approval of final version.

### References

1. "Anthropometry". *biologydictionary.net*. Cited on 2020 May 21. Available from: <https://biologydictionary.net/anthropometry/>
2. Mukherjee JB, editor. *Forensic Medicine and Toxicology*. 2nd ed. New Delhi: Arnold Associates; 1994. Personal identification; pp. 128–9.
3. Krishan K. Determination of stature from foot and its segments in a North Indian Population. *Am J Forensic Med Pathol* 2008;29:297-303.
4. Akhlaghi M, Hajibeygi M, Zamani N, Moradi B. Estimation of stature from upper limb anthropometry in Iranian population. *Journal of Forensic and Legal Medicine*. 2012; 19(5):280-4.
5. Dongare SS, Deokar RB, Patil SS, Jadhav PL. Correlation of Stature to Arm Span and Biacromial Shoulder Width in Young Adults of Western Indian Population. *Int J Educ Res Health Sci* 2017;3(2):64-70.
6. Lundy JK. The mathematical versus anatomical method of stature estimation from the long bones. *Am J Forensic Med Pathol* 1985;(6) No.1: 73- 76.
7. Madden AMT, Tsikoura T, Stott DJ. The estimation of body height from ulnar length in adults from different ethnic groups. *J. Hum. Nutr. Diet.* 2008; 21(4):394.
8. Potdar AB, Rathod P, Potdar PA, Desai MM. *Indian Journal of Forensic Medicine & Toxicology*, 2019;13(2):219-21.
9. Chikhalkar BG, Mangaonkar AA, Nanandkar SD, Peddawad RG. Use measurement of long bones, hand and foot dimensions of local population of Mumbai. *J Indian Acad Forensic Med* 2009;32:329-31.
10. Akhlaghi M, Sheikhzadi A, Ebrahimnia A, Hedayati M, Nazparvar B, Anary SHS. The value of radius bone in prediction of sex and height in the Iranian population. *Journal of Forensic and Legal Medicine*. 2012; 19(4):219-22.
11. Ahmed AA. Estimation of stature from the upper limb measurements of Sudanese adults. *Forensic Science International*. 2013; 228(1):178. e1- e7.
12. Varun R, Jayasinghearachchi TM, Priyalini R, Gunasena MD. Arm span and knee height as predictors of stature among Peradeniya medical students. *Sri Lankan J Anaesthesiol*. 2011;19:76–80.

13. Ebite LE, Ozoko TC, Eweka AO, Otuaga PO, Oni AO, Om'Iniabohs FAE. Height: Ulna ratio: A method of stature estimation in a rural community in Edo state, Nigeria. *The Internet Journal of Forensic Science* 2008; 3(1).
14. Ilayperumal, Nanayakkara G and Palahepitiya N. A model for the estimation of personal stature from the length of forearm. *International Journal of Morphology* 2010;28(4) 1081-1086.
15. Nath S, Duggal N and Chandra NS. Reconstruction of stature on the basis of percutaneous length of forearm bones among the Munda of Midnapur district. *West Bengal Human Science* 1998;37 170-175.
16. Singh B, Kaur M, Kaur J, Singh M, Batra A. Estimation of stature from forearm length in north Indians: an anthropometric study. *International Journal of Basic and Applied Medical Sciences*. 2013; 3(1):201- 4.

# Assessment of Nursing Students' Knowledge toward Preventive Measures of Urinary Tract Infections in Mosul Teaching Hospitals

Tahsein Muhsin Hussein<sup>1</sup>, Munther Nather Al-Fattah<sup>2</sup>, Tameem Thamir<sup>3</sup>, Radhwan Hussein Ibrahim<sup>4</sup>

<sup>1</sup>PhD. Adult Nursing, Lecturer, Clinical Nursing Department, College of Nursing, University of Mosul, Iraq, <sup>2</sup>M.Sc. Adult Nursing, Assistant Lecturer, Clinical Nursing Department, College of Nursing, University of Mosul, Iraq, <sup>3</sup>M.Sc. Adult Nursing, Lecturer, Clinical Nursing Department, College of Nursing, University of Mosul, Iraq, <sup>4</sup>PhD. CHN, Professor, Clinical Nursing Department, College of Nursing, University of Mosul, Iraq

## Abstract

**Background and Objectives:** UTI is a common bacterial infection known to affect the different parts of the urinary tract and the occurrence is found in both males and females. It's the most common site of nosocomial infection, accounting for greater than (40%) of the total number reported by hospital and affecting about (600,000) patients each year. The objective of this study is to assess the knowledge of regarded preventive measures among nursing college students and to determine the association between their knowledge and selected demographical data.

**Materials and Method:** A cross-sectional study was conducted among (120) students enrolled in the nursing college at Mosul university during the period of 25<sup>st</sup> January, 2019 to 25<sup>th</sup> of May, 2019. A self-administered structured questionnaire which consists of (16) items was obtain to assess the knowledge regarding preventive measures of UTI and other demographic details. The SPSS (version 18) was used for the data analysis. The demographic characteristics of the study samples were reported by using descriptive statistics (frequencies, percentages, and mean). The mean of scores were compared by one-way ANOVA were done to find the association between variables.

**Results:** The results of the present study showed that (40.8%) of respondents were belonged to the age group (20-22) years old, more than half of them (55%) were females, and the majority of them (86.7%) were single.

**Conclusions:** The study concluded that the general level of the knowledge among the participants was overall (52.5%) of the (120) participants had moderate level of knowledge, while (36.7%) of them had poor knowledge regarding preventive measures of urinary tract infection.

**Recommendations:** Based on the results of the study, the researchers recommended the necessary to preparation of educational programs for students of the university of Mosul to develop their knowledge and knowledge about the seriousness of UTI diseases, as well as the establishment of units for counseling and health guidance.

**Keywords:** Knowledge, preventive measures, urinary tract infection, nursing college students.

## Introduction

Urinary tract infections (UTIs) are characterized by colonization, invasion and multiplication of microorganisms in the urinary system<sup>(1)(2)</sup>. UTI is an infection of the urinary system that may involve the lower urinary tract or both the lower and upper urinary tract<sup>(3)</sup>. UTIs are considered as the most frequent

---

### Corresponding Author:

#### Radhwan Hussein Ibrahim

PhD.CHN, Professor, Clinical Nursing Department,  
College of Nursing, University of Mosul, Iraq  
e-mail: prof.dr.radhwan@uomosul.edu.iq  
Tel:+964-770-1620-882

bacterial infections worldwide<sup>(4)(5)</sup>. UTI is a common bacterial infection known to affect the different parts of the urinary tract and the occurrence is found in both males and females. Urinary tract infections (UTIs) are caused by pathogenic microorganisms in urinary tract (the normal urinary tract is sterile above the urethra). UTIs are generally classified as infections involving the upper or lower urinary tract and further classified as uncomplicated or complicated depending on other patient related conditions<sup>(6-8)</sup>. The urinary tract is the most common site of nosocomial infection, accounting for greater than 40% of the total number reported by hospital and affecting about 600,000 patients each year<sup>(9-10)</sup>. Manifestations of (UTI) account for more than 7 million health care visits and 1 million hospital admission annually in United States and The incidence of UTI is second only that of upper respiratory infection in primary care<sup>(11-13)</sup>. In this study, we aimed to assess the students' knowledge of regarded preventive measures of UTIs, and to determine the association between socio- demographical data and their knowledge regarding prevention of UTI.

**Methodology**

Quantitative research, a “cross- sectional” study was carried out to achieve the objectives of study among the nursing college students. The present study was conducted in Mosul University at the College of Nursing. Aaccidental sample of (120) students (males and females) from the nursing college students, were included in the study. To assess students' knowledge the researchers construct questionnaire format which consisted of (16) questions: The researchers interviewed all students, and each student was given a time period between (10- 15) minutes to answer the questions. In order to a chive the study aim and objectives, the structured knowledge questionnaire toward the preventive measures of UTIs were given and filled questionnaires were obtained from the subjects, which is composed of two parts:- Part One: Demographic Characteristics Sheet that include information related

to the students' demographical characteristics sheet which include (age, gender, marital status). While Part Two is a questionnaire concerned with data to assess the their knowledge which was consists of list of (16) items. Each item has three option yes, no, and uncertain. The researchers were used three points to measure each items of the knowledge sheet. (3) for the right answer (yes), (2) for uncertain answer, and (1) for the wrong answer (no). The general level of students' knowledge were divided into three levels according to the mean of score; poor level of knowledge were (less than 2), moderate level of knowledge ranges from (2 - 2.5), and good level of knowledge ranges from (more than 2.5 - 3). The SPSS (version 18) was used for the data analysis. The demographic characteristics of the study samples were reported by using descriptive statistics (frequencies, percentages, and mean). The mean of scores were compared by one sample independent t-test, and one-way ANOVA. The content validity of the knowledge test tool was established in consultation with a panel of (10) experts in different specializations. All of them agreed that the questionnaires were clear, relevant, and adequate. Minor changes were employed based on their recommendations and suggestions. Data were collected through direct interviews of the samples, by using a constructed questionnaire to the period from 25st January, 2019 to 25th of May, 2019.

**Results**

According to table (1), out of (120) participants (40.8%) of respondents their age were range from (20- 22) years old. In relation to gender, more than half of them (55%) were females. Regarding to the marital status that (86.7%) of the samples were single. Table (2) presented that the overall (52.5%) of the (120) participants had moderate knowledge, while (10.8%) of them had poor knowledge regarding preventive measures of UTIs. Table (4) indicated that there are no significant differences between students' knowledge in regard to their age and marital status respectively.

**Table (1): Distribution of the studied students' level of Knowledge regarding preventive measures of UTIs.**

Level of knowledge	Mean of score	Frequency	Percentage
Poor	>2	44	36.70%
Moderate	2 - 2.5	63	52.50%
Good	More than 2.5 – 3	13	10.80%

**Table (2): Distribution of the samples according to their knowledge regarding preventive measures of UTIs.**

No.	Preventive measures items	Mean of Score	(SD)
1	Bathing in the swimming pool increase UTI.	1.97	0.90249
2	Bathing by shower reduce the incidence of UTI.	1.98	0.90733
3	Cleaning the perineum from front to back after defecation reduce UTI.	2.58	0.78412
4	Use deodorant as a preventive measure to prevent UTI.	1.95	0.8638
5	Urination 4-5 times reduces UTI.	2.38	0.87143
6	Drinking liquids other than water decreases UTI.	1.9	0.83006
7	Use berry juice as a preventive measure to lessen the injury of UTI.	1.65	0.87591
8	Vitamin C reduce the risk of UTI.	1.98	0.90733
9	Avoid tight underwear lessens injury of UTI.	2.35	0.87731
10	Cotton underwear diminishes UTI.	2.36	0.85929
11	Emptying the bladder completely by repeating urination.	2.52	0.72137
12	Urinate immediately when feeling bladder full.	2.45	0.75426
13	Pee before going to bed.	2.35	0.82656
14	Reduce the intake of hot, spicy foods.	1.88	0.63753
15	Emptying the bladder completely by repeating standing upright in the bathroom.	1.7	0.72876
16	Drinking enough water regularly daily reduce the incidence of infection.	2.51	0.67343

**Table (3): Association between student' knowledge with selected demographic variable.**

Variable	Sum of Square	DF	Mean Square	F cal.	F tab.	Sig.
<b>Age</b>						
Between Group	0.256	2	0.128			
Within Group	8.679	117	0.074	1.723	3.07	0.183
<b>Total</b>	<b>8.935</b>	<b>119</b>				
<b>Marital Status</b>						
Between Group	0.051	2	0.025			
Within Group	8.884	117	0.076	0.333	3.07	0.718
<b>Total</b>	<b>8.935</b>	<b>119</b>				

**Table (4): Differences in students' Knowledge regarding gender.**

Gender	No.	Mean	SD	T cal.	T tab.	Sig.
Male	54	2.1551	0.27891	-0.211	1.98	0.907
Female	66	2.1657	0.27199	-0.21		

DF = (118),  $\alpha$  = (0.05)

## Discussion

There is no doubt the urinary tract infection it is consider the common problem which are affected in male and female<sup>(14,15)</sup>. We as a health care provider we must be educated the community to how deal with that disorder

to preventing complication. In general, about 50% of clinical training should take place in the nursing school curriculum.<sup>(16)</sup> In recent study objectives the researchers assess the effectiveness of knowledge and examined it they focus on engagement and motivation as necessary factors for knowledge gain and learning transfer, relation

between learning outcomes and behavior.<sup>(17)</sup> According to study findings the participants distributed depending on demographic characteristics of respondents their age, In relation to samples gender and regarding to the marital status. All these variables putting to election to know what are the factors which are influencing into their knowledge. In table (1) we divided the level of knowledge in three categories good, moderate and poor, the majority of participants had moderate knowledge toward preventive urinary tract infection because a good relationship for sample with their friends. Peer support and good relationships with peers are considered as factors contributing to a positive learning attitude<sup>(18,19)</sup>.

The students in the present study were also willing to learn, which will support academic self-efficacy in their learning environment. Since healthcare professions are based on both theoretical knowledge and practice, candidates of healthcare professionals have to receive education in the clinical environment integrated with theoretical courses. It is important for students to actively participate in healthcare services. When we discuss the table (2) the analyses revile in details the method of preventive urinary infection, however the researcher show the variations between it, some of them was poor and another was moderate The studies demonstrated that time management training programs generally increased students time management skills and the copying time pressure<sup>(20)</sup>. The curriculum for the undergraduate nursing students education is appropriate to the age, social, culture and environment of students<sup>(21)</sup>. In table (3 and 4) the researchers thought the marital status and gender of sample play the important role to enhancing the background of the precaution and preventive of infection, There are several important areas of UTI management that are beyond the scope of our study . The management of UTI in pregnancy is not covered here in great detail, as this is an area that is typically managed during prenatal care. Other areas beyond the scope of this document include long-term prophylaxis of UTI as well as acute or chronic prostatitis and UTI in pediatric patients many article demonstrate the a highly percentage of urinary infection was in female while there is no significant between male and female knowledge<sup>(22)</sup>. This study was concluded that (40.8%) of respondents their age was between (20 - 22) years old, most of them (66%) were females, and (86.7%) of the samples were single. More than half (52.5%) of the (120) participants had moderate knowledge, while (36.7%) of them had poor knowledge regarding

preventive measures of UTI. There are no significant differences between students' knowledge regarding their age and marital status respectively. There is no significant differences in students' knowledge scores in regard to gender. Based on the results of the study, the researchers recommended the necessary to preparation of educational programs for students of the university of Mosul to develop their knowledge about the seriousness of UTI diseases, as well as the establishment of units for counseling and health guidance.

**Conflicts of Interest:** None declared.

**Funding:** There is no funding relevant to this study.

**Ethical Clearance:** Taken from Review Board of Ethical Research Committee, Mosul City for granting us the ethical approval for the study.

**Acknowledgment:** The authors wish to thank and acknowledge the members of the Review Board of Ethical Research Committee, Mosul City for granting us the ethical approval for the study. Finally, the study participants are highly appreciated for their valuable time and support.

## References

1. Almkhtar SH. Urinary Tract Infection Among Women Aged (18-40) Years Old in Kirkuk City, Iraq. *The Open Nursing Journal*. 2018 Dec 31;12(1).
2. Rajaratnam A, Baby NM, Kuruvilla TS, Machado S. Diagnosis of asymptomatic bacteriuria and associated risk factors among pregnant women in Mangalore, Karnataka, India. *Journal of clinical and diagnostic research: JCDR*. 2014 Sep;8(9):OC23.
3. Bennett JE, Dolin R, Blaser MJ. Mandell, Douglas, and Bennett's principles and practice of infectious diseases: 2-volume set. Elsevier Health Sciences; 2014 Aug 28.
4. Galatti L, Sessa A, Mazzaglia G, Pecchioli S, Rossi A, Cricelli C, Schito GC, Nicoletti G, Caputi AP. Antibiotic prescribing for acute and recurrent cystitis in primary care: a 4 year descriptive study. *Journal of Antimicrobial Chemotherapy*. 2006 Mar 1;57(3):551-6.
5. Litwin MS, Saigal CS, Yano EM, Avila C, Geschwind SA, Hanley JM, Joyce GF, Madison R, Pace J, Polich SM, Wang M. Urologic diseases in America Project: analytical method and principal findings. *The Journal of urology*. 2005

- Mar;173(3):933-7.
6. Nienhouse V, Gao X, Dong Q, Nelson DE, Toh E, McKinley K, Schreckenberger P, Shibata N, Fok CS, Mueller ER, Brubaker L. Interplay between bladder microbiota and urinary antimicrobial peptides: mechanisms for human urinary tract infection risk and symptom severity. *PloS one*. 2014 Dec 8;9(12):e114185.
  7. Wolfe AJ, Brubaker L. "Sterile urine" and the presence of bacteria. *European urology*. 2015 Aug;68(2):173.
  8. Brunner LS, Smeltzer SC, Suddarth DS. *Brunner & Suddarth's textbook of medical-surgical nursing*; Vol. 1. Language. 2010;27:1114-2240p.
  9. Vasudevan R. Urinary tract infection: an overview of the infection and the associated risk factors. *J Microbiol Exp*. 2014 May;1(2):00008.
  10. Chung MK, Chung RP, Gordon D. Interstitial cystitis and endometriosis in patients with chronic pelvic pain: the "evil twins" syndrome. *JLS: Journal of the Society of Laparoendoscopic Surgeons*. 2005 Jan;9(1):25.
  11. Clark HD. Evaluation of a pilot diabetes educational intervention using the American Diabetes Association's Risk Assessment form with the patrons of The Health Museum, Houston Texas (Doctoral dissertation, The University of Texas School of Public Health).
  12. Indhumol TD, Pavithran S, George LK. Effectiveness of Structured Teaching Program On Knowledge Regarding Prevention of Urinary Tract Infection Among Adolescent Girls. *International Journal of Pharma Medicine and Biological Sciences*. 2014 Jul 1;3(3):121.
  13. Jahanbin I, Heydari N, Ghodsbin F, Sayadi M. The Effect of Peer-Education on UTI-Related Preventive Behavior According to HBM among First-Grade High School Female Students in Shiraz, 2014.
  14. Gupta K, Hooton TM, Naber KG, Wullt B, Colgan R, Miller LG, Moran GJ, Nicolle LE, Raz R, Schaeffer AJ, Soper DE. International clinical practice guidelines for the treatment of acute uncomplicated cystitis and pyelonephritis in women: a 2010 update by the Infectious Diseases Society of America and the European Society for Microbiology and Infectious Diseases. *Clinical infectious diseases*. 2011 Mar 1;52(5):e103-20.
  15. Hooton TM. Uncomplicated urinary tract infection. *New England Journal of Medicine*. 2012 Mar 15;366(11):1028-37.
  16. Andrews M, Roberts D. Supporting student nurses learning in and through clinical practice: the role of the clinical guide. *Nurse Education Today*. 2003 Oct 1;23(7):474-81.
  17. Nworie J, Haughton N. The unintended consequences of the application of technology in teaching and learning environments. *TechTrends*. 2008 Sep;52(5):52-8.
  18. Mokadem NM, Shima EL, Ibraheem S. Nursing Students' Satisfaction with Their Clinical Learning Environments. *American Journal of Nursing Research*. 2017 Jun 29;5(4):104-8.
  19. Chan DS, Ip WY. Perception of hospital learning environment: a survey of Hong Kong nursing students. *Nurse education today*. 2007 Oct 1;27(7):677-84.
  20. Claessens BJ, Van Eerde W, Rutte CG, Roe RA. A review of the time management literature. *Personnel review*. 2007 Feb 13.
  21. Mirzaei T, Oskouie F, Rafii F. Nursing students' time management, reducing stress and gaining satisfaction: a grounded theory study. *Nursing & health sciences*. 2012 Mar;14(1):46-51.
  22. Beahm NP, Nicolle LE, Bursey A, Smyth DJ, Tsuyuki RT. The assessment and management of urinary tract infections in adults: guidelines for pharmacists. *Canadian Pharmacists Journal/Revue des Pharmaciens du Canada*. 2017 Sep;150(5):298-305.



# Impact of Educational Program on Nurses' Knowledge toward Coronary Artery Bypass Graft Surgery in Mosul Teaching Hospitals

Tahsein Muhsin Hussein<sup>1</sup>, Myasar Mohsin Azeez<sup>2</sup>, Radhwan Hussein Ibrahim<sup>3</sup>

<sup>1</sup>Lecturer, Adult Nursing, College of Nursing, University of Mosul, <sup>2</sup>Assistant Lecturer, Nursing Department, Technical Institute, Mosul, <sup>3</sup>Professor, Community Health Nursing, College of Nursing, University of Mosul

## Abstract

**Background:** Coronary artery bypass grafting (CABG) is a common surgery to treat coronary artery disease which is the leading reason of death in advanced countries. It involves a section of a vein or an artery to produce a connection (or bypass) between the aorta and the coronary artery beyond the obstruction.

**Objectives:** The objectives of the study were to assess the nurses' knowledge toward CABG, to identify the impact of the educational program, and to determine the relation between nurses' knowledge and their demographical characteristic.

**Method:** A quasi-experimental study was conducted to assess the effectiveness of educational program on nurses' knowledge regarding to CABG. A non-probability purposive sample consisting of (40) nurses. The samples were divided into two equal groups (study and control). An educational program was focus to administer for the study group. All participants completed a self-administered instruments at pre and post-tests. The assessment was carried out during the period from 17<sup>th</sup> of January, 2018 to 4<sup>th</sup> of May, 2018. The Instrument validity was determined through content validity, by a panel of experts. Reliability of the instrument was determined through the use of test- retest approach.

**Results:** The results revealed that the mean post- test knowledge scores in the study group were significantly higher than mean pre- test knowledge score.

**Conclusion:** The study concluded that the educational program had great effective on emerging and enhancing nurses' knowledge regarding CABG.

**Keywords:** Coronary artery bypass graft, educational program, nurses knowledge.

## Introduction

Cardiovascular disease is the prominent cause of death worldwide, accounting for 31% of all recorded deaths, and is expected to continue in this point until 2030<sup>(1,2)</sup>. The most common of these is the coronary artery disease which represents the leading cause of

death in developed countries<sup>(3,4,5)</sup>. Today, coronary artery bypass surgery (CABG) remains one of the most generally done main surgical treatment worldwide and the most common procedure performed by cardiac surgeons<sup>(6,7,8)</sup>. This surgery has supported to be one of the most effective and lasting therapies for ischemic heart disease<sup>(9,10)</sup>. Coronary artery bypass surgery is a surgical method which may be uses arteries or veins as a graft to convey blood to an area of the coronary artery distal to the blockage<sup>(11,12)</sup>. A coronary artery bypass surgery (marked "cabbage")<sup>(13)</sup>. Coronary artery bypass graft surgery has a positive effect on mortality in several cases<sup>(14)</sup>. American Heart association position statement specified that CABG is indicated if medical

---

### Corresponding Author:

**Radhwan Hussein Ibrahim**

Professor, Community Health Nursing, College of Nursing, University of Mosul

e-mail: prof.dr.radhwan@uomosul.edu.iq

management does not satisfactorily control angina in patients with coronary artery disease or if the patient has >50% obstruction of the left main coronary artery or three vessel disease with moderate or severe left ventricular dysfunction regardless of symptoms<sup>(15)</sup>. Extra of 400,000 American (greatest of them male) undergo CABG every year, making it one of the most common cardiac surgeries. Successful CABG can relieve angina chest pain, progress cardiac function, progress the patient’s quality of life, also they experience more active, exercise performance increases and support them to return to the normal lives, but the early recovery period presents a numeral of challenges for patients care and nurses<sup>(16,17,18)</sup>. In the US and an average incidence rate of (62) per 100,000 inhabitants in western European countries<sup>(19,20)</sup>. Early and adequate discharge planning based on in-depth knowledge of the post discharge experience will help to ensure optimal recovery<sup>(21)</sup>.

### Method and Subjects

Quantitative research, a quasi- experimental study was carried out to assess nurses’ knowledge in Al-Jamhuree and al- Salam Teaching Hospitals in Mosul City from 17<sup>th</sup> of January, 2018 to 4<sup>th</sup> of April, 2018. It was carried throughout the application of pre and post-tests approach for the study group and control groups. A non – probability purposive sample of (40) nurses (male and female) who were working in cardiac care wards, who met the sample criteria were included in the study, which was divided into two groups; the first group consists of (20) nurses for study group were exposed to the health educational program, while the second group (20) nurses for control group. Each group

had proximately the same demographic characteristics as possible. To fulfill the objectives of the study a closed-ended questions structured knowledge questionnaire was prepared based on a comprehensive review of relevant literatures to evaluate the nurses knowledge before and after the administration of educational program. It consists of two parts:-Part One: Related to the nurses demographical characteristics sheet which include (age, gender, level of education, years of experience in cardiac wards, and number of attending educational programs regarding CABG).Part Two: Questionnaire to Assess Nurses’ Knowledge Regarding CABG, this part involves of (20) items. All items were measured by nominal scale of normal which was given a score of two for the correct answer and one for the wrong answer. The knowledge mean of scores was rated into (3) knowledge levels, according to the two-point likert scale = (Maximum – Minimum)/groups= (2-1)/3 = (0.33) this is the interval value which was the added value to the three levels as in the following: 1– 1.339 (Poor), 1.34–1.669 (Moderate), and 1.67 – 2 (High). The tools validity was done by a panel of experts in different specializations, Reliability was tested by test-retest the correlation coefficient was (r=0.88%) at the level (p≤0.05) for nurses’ knowledge. This indicated that the instrument was adequately reliable. All the results were analyzed using the statistical package SPSS 18.0. A statistical and inferential analysis was applied for data analysis concentration on the calculation of the frequency, percentage, paired t-test, Pearson coefficient correlation, mean of score (MS), and one- way analysis of variance. A p value ≤ 0.05 was regarded statistically significant.

### Results

**Table 1: Comparative differences between the study and control groups of the nurses’ knowledge relative to pre and post- tests.**

Knowledge	Mean of Score	Std. Deviation	Std. Error Mean	t- Observe	Sig.
Pair 1 pre-test for study G.	1.3225	.06382	.01427	0.665	.514
Pre-test for control G.	1.3100	.05758	.01288		N.S
Pair 2 pre-test for study G.	1.3225	.06382	.01427	-17.979	.000
Post-test for study G.	1.8100	.08974	.02007		S.
Pair3 pre-test for control G.	1.3100	.05758	.01288	0.370	.716
Post-test for control G.	1.3050	.03940	.00881		N.S
Pair4 Post-test for study G.	1.8100	.08974	.02007	21.508	.000
Post-test for control G.	1.3050	.03940	.00881		S.

T- critical = 2.093 DF = 19

**Table 2: Association between nurse' knowledge scores with gender.**

Gender	No.	Mean of score	Std. Deviation	t – observe	t. critical	Sig.
Male	15	1.8133	0.08958	0.281	2.101	0.781
Female	5	1.8000	0.10000	0.265		0.265

**Table 3: Analysis of variance of participants knowledge according to their demographical characteristics.**

Variable	Source of variance	Sum of Squares	DF	Mean Square	F	Sig.
Age	Between Groups	1.550	4	.388	.930	.473
	Within Groups	6.250	15	.417		
	Total	7.800	19			
Educational level	Between Groups	3.478	4	.869	.950	.462
	Within Groups	13.722	15	.915		
	Total	17.200	19			
Years of Experience	Between Groups	3.028	4	.757	1.901	.163
	Within Groups	5.972	15	.398		
	Total	9.000	19			
No. of attended Educational program	Between Groups	2.050	4	.513	1.139	.376
	Within Groups	6.750	15	.450		
	Total	8.800	19			

F. Critical = 3.24 P ≤ 0.05

**Table (4): Comparison between nurses' knowledge scores regarding (pre and post) tests for the study and control groups.**

Knowledge levels	Study group n=20						Control group n=20					
	Pre test			Post test			Pre test			Post test		
	No (%)	M.S	G.	No (%)	M.S	G.	No (%)	M.S	G.	No (%)	M.S	G.
Poor (1-1.339)	15(75%)	1.32	L.S	0	1.81	H.S	16(80%)	1.31	L.S	17(85%)	1.30	L.S
Moderate (1.34-1.669)	5(25%)			4(20%)			4(20%)					
High (1.67-2)	0			16(80%)			0					

M.S= Mean of score, G= Grads, L.S= Low significant, H.S= High significant.

### Discussion

Throughout of the data analysis, In relation to the age, the results of the present study showed; that more than half of the nurses in both study and control groups belonged to the same age group of (30-39) years old. This finding is in concordance with that of<sup>(22)</sup> who found that their age ranged between 20 and 40 years. The high percentage of male nurses in the present study. The researcher refer to this finding which is due to the dominance of male in the nursing profession in Iraq. On the other hand, this results may be imitate a social conditions keeping women away in this job and due

to the fact that most of female nurses are selected to care for maternal and child health care. This finding is disagree with a study done by<sup>(23,24)</sup>, who definite that the majority of nurses were female. Moreover, the current study revealed that the institute nursing graduate were the high proportion, more than half of them their years of experience in cardiac wards less than (5) years and more than three quarters of them have no attendance in any education programs related to coronary artery bypass grafting. The above findings were consistent with another study done by<sup>(25)</sup>, shown that nursing school diploma was the high proportion. Also, more than half

of them their experiences less than (10) years and the majority of them have no in service training course related to coronary artery bypass graft surgery. As well, Supporting to this findings<sup>(26)</sup> stated that the majority of nurses in both units had secondary diploma degree and most of nurses in both units had not trained.

In order to assess the effect of educational program upon nurses' knowledge through scoring analysis for mean of score. The findings of the current study had presented that, the mean of the nurses' knowledge score was (1.32, 1.31) for both study and control groups respectively during pre-test, which was reflects the poor of their knowledge before the administration of the educational program. After program implementation for the study group subjects, the nurses' knowledge mean of score was (1.81) had shown highly significant improvement in post-test when they are compared with control group (1.30). The above results indicated that the educational program was very efficient in enhancing the knowledge level of the respondents. This finding goes in with the previous study done by<sup>(27,28)</sup> whomentioned that nurses must be able to expand their knowledge of this area through ongoing education, Journal, and seminars. Consequently, teaching programs for nursing staff constitute an important part. These programs are urgently designed to assess nursing staff in developing and enhancing the skills needed to provide high standards of care to their patients. In this respect,<sup>(29)</sup> reported that many continuing education program evaluations use a comparison of the participant's pretest and post test scores as an indicator of that program's effectiveness. The results of the recent study indicated that the selected demographic variable had shown no statistical significant association with the nurses knowledge scores. This findings agree with another study done by<sup>(30)</sup> who revealed that the all demographic variables i.e. age, sex, educational qualification, experience in post-operative management of CABG and availability of any additional information on post- operative management of patient with CABG are not significant association between the pre- test knowledge scores and these selected demographic variables.

**Conflicts of Interest:** None declared.

**Funding:** There is no funding relevant to this study.

**Ethical Clearance:** Taken from Review Board of Ethical Research Committee, Mosul City for granting us the ethical approval for the study.

**Acknowledgment:** The authors wish to thank and acknowledge the members of the Review Board of Ethical Research Committee, Mosul City for granting us the ethical approval for the study. Finally, the study participants are highly appreciated for their valuable time and support.

## References

1. Mathers CD, Loncar DJPm. Projections of global mortality and burden of disease from 2002 to 2030. 2006;3(11):e442.
2. Elizondo-Omaña R, García-Rodríguez M, Morales-Gómez J, Guzmán-López S, Tijerina de la Garza O, Fernandez-Rodarte B, et al. Conductos vasculares utilizados en la operación de revascularización miocárdica. 2005;7(29).
3. ElBardissi AW, Aranki SF, Sheng S, O'Brien SM, Greenberg CC, Gammie JSJTJot, et al. Trends in isolated coronary artery bypass grafting: an analysis of the Society of Thoracic Surgeons adult cardiac surgery database. 2012;143(2):273-81.
4. Fredericks S, Sidani S, Vahabi M, Micevski VJCJoNRA. An examination of current patient education interventions delivered to culturally diverse patients following CABG surgery. 2012;44(1).
5. Jha AK, Fisher ES, Li Z, Orav EJ, Epstein AMJNEJoM. Racial trends in the use of major procedures among the elderly. 2005;353(7):683-91.
6. Hobbs RD, Paone G, D'Agostino RS, Jacobs JP, McDonald DE, Prager RL, et al. Myocardial revascularization: the evolution of the STS database and quality measurement for improvement. 2018;34(3):222-9.
7. Harskamp RE, Alexander JH, Ferguson Jr TB, Hager R, Mack MJ, Englum B, et al. Frequency and predictors of internal mammary artery graft failure and subsequent clinical outcomes: insights from the Project of Ex-vivo Vein Graft Engineering via Transfection (PREVENT) IV trial. 2016;133(2):131-8.
8. Møller CH, Perko MJ, Lund JT, Andersen LW, Kelbæk H, Madsen JK, et al. Three-year follow-up in a subset of high-risk patients randomly assigned to off-pump versus on-pump coronary artery bypass surgery: the Best Bypass Surgery trial. 2011;97(11):907-13.

9. Mohr FW, Morice M-C, Kappetein AP, Feldman TE, Ståhle E, Colombo A, et al. Coronary artery bypass graft surgery versus percutaneous coronary intervention in patients with three-vessel disease and left main coronary disease: 5-year follow-up of the randomised, clinical SYNTAX trial. 2013;381(9867):629-38.
10. Puskas J, Cheng D, Knight J, Angelini G, DeCannier D, Diegeler A, et al. Off-pump versus conventional coronary artery bypass grafting: a meta-analysis and consensus statement from the 2004 ISMICS consensus conference. 2005;1(1):3-27.
11. Diodato M, Chedrawy EGJSr, practice. Coronary artery bypass graft surgery: the past, present, and future of myocardial revascularisation. 2014;2014.
12. Partridge RA, Proano L, Marcozzi D, Garza AG, Nemeth I, Brinsfield K, et al. Oxford American handbook of disaster medicine: Oxford University Press; 2011.
13. Perrin KO, MacLeod CE. Understanding the essentials of critical care nursing: Pearson Higher Ed; 2012.
14. Bonaros N, Schachner T, Wiedemann D, Oehlinger A, Ruetzler E, Feuchtner G, et al. Quality of life improvement after robotically assisted coronary artery bypass grafting. 2009;114(1):59-66.
15. Weiss AJ, Elixhauser AJHC, Briefs UPS. Trends in operating room procedures in US hospitals, 2001-2011: statistical brief# 171. 2006.
16. Ozcan H, Yildiz Findik U, Sut NJJonp. Information level of patients in discharge training given by nurses following open heart surgery. 2010;16(3):289-94.
17. Eckman M, Comerford KJPLW, May WR. Medical-surgical nursing made incredibly easy. 2012;1:2016.
18. Carinci F, Van Gool K, Mainz J, Veillard J, Pichora E, Januel J, et al. Towards actionable international comparisons of health system performance: expert revision of the OECD framework and quality indicators. 2015;27(2):137-46.
19. Head SJ, Milojevic M, Taggart DP, Puskas JDJC. Current practice of state-of-the-art surgical coronary revascularization. 2017;136(14):1331-45.
20. Theobald K, McMurray AJJoan. Coronary artery bypass graft surgery: discharge planning for successful recovery. 2004;47(5):483-91.
21. Sakr MD, Metwaly EA, Taha NMJENJ. Effect of intervention guidelines on nursing performance regarding patients with angina. 2019;16(2):70.
22. Ahmed AJUMTiMSN, Faculty of Nursing. Developing nursing care standards for patient with disectomy at Assuit University Hospital. 2013:74.
23. Ahmed G, Mohammed Z, Ghanem HJJAS. Coronary artery bypass grafting effect of developing and implementing nursing care standards on patient's outcomes. 2015;11(7):181-8.
24. Taha AJJJoN, Science H. Impact of a Designed Teaching Protocol about Nursing Management of Coronary Artery Bypass Grafting on Nurse's Knowledge, Practices and Patient's Outcome. 2017;6:13-28.
25. Hamed SJUMT, Faculty of Nursing, Benha University. Nurses performance during cardiopulmonary resuscitation in Intensive Care Unit and Cardiac Care Unit at benha University hospital. 2009.
26. Fuster V, Rydén LE, Asinger RW, Cannom DS, Crijns HJ, Frye RL, et al. ACC/AHA/ESC guidelines for the management of patients with atrial fibrillation: executive summary: a report of the American College of Cardiology/American Heart Association Task Force on Practice Guidelines and the European Society of Cardiology Committee for Practice Guidelines and Policy Conferences (Committee to Develop Guidelines for the Management of Patients With Atrial Fibrillation) Developed in collaboration with the North American Society of Pacing and Electrophysiology. 2001;38(4):1231-65.
27. Sosin M, Yin C, Poysophon P, Patel KMJJorm. Understanding the concepts and physiologic principles of lymphatic microsurgery. 2016;32(08):571-9.
28. Mark KA, Franks Jr AGJJotAAoD. Colchicine and indomethacin for the treatment of relapsing polychondritis. 2002;46(2):S22-S4.
29. THOMAS J. EFFECTIVENESS OF PLANNED TEACHING PROGRAMME ON KNOWLEDGE REGARDING POST OPERATIVE MANAGEMENT OF PATIENTS WITH CABG AMONG STAFF NURSES WORKING IN POST OPERATIVE CARDIAC UNITS OF SELECTED HOSPITALS AT MANGALORE 2013.

30. Soares JJ, Jablonska BJEJoP. Psychosocial experiences among primary care patients with and without musculoskeletal pain. 2004;8(1):79-89.
31. Koller A, Stein DJ. Pharmacotherapy of posttraumatic stress disorder. *Anxiety Disorders*. 29: Karger Publishers; 2013. p. 154-63.
32. Kumaraswamy M. Clinical Study of Epigastric swellings: RGUHS; 2006.

# Quality of Health Care System and Structure at Primary Health Care in Baghdad City

Tariq Yassen Taha<sup>1</sup>, Wissam Jabbar Qassim<sup>2</sup>

<sup>1</sup>Ph.D.(c), Research Scholar, University of Baghdad, College of Nursing,

<sup>2</sup>Assistant Professor (PhD), University of Baghdad, College of Nursing, Community Health Nursing Department

## Abstract

**Background:** Consumers satisfaction is the level of satisfaction that clients experience having used a service. This study aims to determine the level of quality of healthcare services in primary healthcare centers.

**Method:** The study included a simple random sample of beneficiaries of healthcare services in primary healthcare centers in the city of Baghdad by (5-8) beneficiaries for each center using a questionnaire to measure the satisfaction of beneficiaries with the quality of services and the use of the direct interview method, which took from (6-10) minutes.

The study results showed that customer satisfaction scale is very important to assess the quality of health services and can predict compliance and use of international standards for quality of services. The study also found that most primary healthcare centers are located in densely populated areas. Therefore, primary health care services are adequately provided.

**Conclusion:** The researchers concluded that most primary health care centers are located in densely populated areas. Therefore, primary health care services are adequately provided.

**Keywords:** *Quality of Health Care System; Structure; Primary Health Care.*

## Introduction

Consumers satisfaction is the level of satisfaction that clients experience having used a service. It reflects the gap between the expected service and the experience of the service, from the client's point of view. Measuring consumer's or patient satisfaction has become an integral part of hospital/clinic management strategies across the globe. Moreover, the quality assurance and accreditation process in most countries require that the satisfaction of clients be measured on a regular basis<sup>(1)</sup>.

Consumer's satisfaction with health services, therefore, has become one of the important components

of providing accepted quality of care. Satisfaction has been said to be a major predictor of use of services, as it is essential if consumers were to utilize services, comply with treatments and maintain a continuing relationship with practitioners<sup>(2)</sup>.

Satisfaction is the awareness of each person separately. These feelings plagiaristic by comparing expected service with perceived service<sup>(3)</sup>.

Customer satisfaction is individual person reaction toward particular product when compare the performance of the product with any person expectation<sup>(4)</sup>.

Customer satisfaction considered psychosomatic state reaction of customer when its emotion about expectations not positive in near future<sup>(5)</sup>.

Consumer's satisfaction is the level of satisfaction that consumers experience after using the service. Thus, it reflects the gap between the expected service and service experience, according to the consumer's

---

### Corresponding Author:

**Tariq Yassen Taha**

Ph.D.(c), Research Scholar, University of Baghdad,  
College of Nursing

e-mail: tareq\_alrubeiy@yahoo.com

opinion. Measuring consumer's satisfaction has become an integral part of strategies management of primary health care centers all over the world. Moreover, quality assurance and accreditation process in most countries to be measured consumers satisfaction on a regular basis<sup>(1)</sup>.

Following this thinking, there has been growing interest in measuring consumer's satisfaction, mostly through collecting the views of service users. These views have become important in the evaluation of healthcare delivery and have become a tool for health service performance evaluation. Client satisfaction is now viewed as an important measure of protection against potential problems in healthcare delivery and is linked to changes in service delivery policies<sup>(6)</sup>.

Essential healthcare is based on practical, scientifically sound and socially acceptable method and technology, made universally accessible to individuals and families in the community. It is through their full participation and at a cost that the community and the country can afford to maintain at every stage of their development in the spirit of self-reliance and self-determination<sup>(7)</sup>.

The Approach to providing health care resources focuses on provision of essential health care using socially acceptable and affordable method and technology, accessibility, public participation in policy development, and intersects oral collaboration. The declaration of Alma Alta proposes a set of core activity to be included in primary health care and tailors to the needs of a particular population. These activities include:

1. Education to prevent and control major health problem in the area
2. Promotion of nutrition and a safe and sufficient food supply
3. Provision of safe water and basic sanitation
4. Provision of maternal and child health care, including family planning services

5. Immunization
6. Prevention and control of endemic diseases
7. Adequate treatment of common illnesses and injuries
8. Provision of essential medication<sup>(8)</sup>.

### **Method**

A descriptive "Evaluation Correlation" study was conducted to determine the Impact of Quality of Health Care Services on consumer's satisfaction at Primary Health Care Centers in Baghdad City. From (13<sup>th</sup> January to 5<sup>th</sup> March 2019).

A simple random sample consisting of (176) beneficiaries of health care services in primary health care centers in the city of Baghdad by (5-8) consumer's for each center using a questionnaire to measure the satisfaction of consumers with the quality of services and the use of the direct interview method, which took from (6-10) Accurate. These centers are distributed into (2) sides and divided into (8) health sectors according to ministry of health directorate of primary health care. A total of (28) primary health care centers are selected for the purpose of the study.

The data collection starts with providers primary health care services in primary health care centers in Baghdad City. Utilizing of the developing questionnaires and the interview technique as means of data collection and keeping records of all available contacts that facilitate the access to study sample.

The reliability of the questionnaire which is determined through a pilot study and the validity are achieved through a panel of (17) experts. A pilot study was conducted among a convenient sample of (17) providers who were selected among persons concerning with primary health care centers. This preliminary Study was conducted from 15<sup>th</sup> December to 28<sup>th</sup> December 2018.



**Results**

**Table 1. Consumers' socio-demographic characteristics (N=176)**

Information	f	%	$\chi^2$	df	Sig
<b>Age (Years)</b>					
≤ 19	7	4	4.860	10	.900 (N.S)
20 – 29	52	29.5			
30 – 39	54	30.7			
40 – 49	36	20.5			
50 – 59	15	8.5			
≥ 60	12	6.8			
<b>Total</b>	<b>176</b>	<b>100</b>			
<b>Gender</b>					
Male	71	40.3	2.707	2	.258 (N.S)
Female	105	59.7			
<b>Total</b>	<b>176</b>	<b>100</b>			
<b>Level of education</b>					
Doesn't read & write	18	10.2	10.946	12	.543 (N.S)
Read & write	24	13.6			
Primary school	40	22.7			
Intermediate school	23	13.1			
Secondary school	17	9.7			
Institution (Diploma)	10	5.7			
College & above	44	25			
<b>Total</b>	<b>176</b>	<b>100</b>			
<b>Socio-economic status (Iraqi Dinar)</b>					
≤ 300000	40	22.7	7.046	6	.317 (N.S)
301000-600000	85	48.3			
601000-900000	24	13.6			
≥ 901000	27	15.4			
<b>Total</b>	<b>176</b>	<b>100</b>			
<b>Occupation</b>					

Information	f	%	$\chi^2$	df	Sig
Employee	34	19.3	19.295	12	.082 (N.S)
Free work	21	11.9			
Retired	7	4			
Neglect the work	3	1.7			
Unemployed	100	56.8			
Disabled	2	1.1			
Student	9	5.1			
<b>Total</b>	<b>176</b>	<b>100</b>			
<b>Type of service provided for the consumer</b>					
Maternal & childcare	18	10.2	57.303	16	.001 (H.S)
Childcare	24	13.6			
Health promotion	1	0.6			
Critical care/accident	0	0			
Immunization	55	31.3			
Family planning	1	0.6			
Assessment & treatment	44	25			
Dental care	30	17			
School health	1	0.6			
Others	2	1.1			
<b>Total</b>	<b>176</b>	<b>100</b>			

No: Number, f: Frequency, %: Percentage, Iq D: Iraqi Dinar,  $\chi^2$ = Chi-square, df: degree of freedom, p-Value: probability value, Sig: Significance, N.S: Not significant

A high percentage among age groups was associated with (30-39) years which is (30.7%), more of consumers are females (59.7%). The analysis of educational level for those consumers indicates that high percentage refers to primary school education (22.7%). The socioeconomic variable indicates that those consumers are associated moderate socio-economic status of (301000-600000

ID) (48.3%). Regarding occupational status, more than half of consumers are unemployed (56.8%). The types of services that are utilized by consumers were immunization (31.3) that presents the highest percentage followed by the services of assessment and treatment (25%), dental care (17%), childcare (13.6%) and maternal and child health (10.2%).

**Table 2. Evaluation the consumers' satisfaction for healthcare services (N=176)**

Satisfaction items	M.S	Evaluation
In general, I am satisfied with the quality of service provided at the center	2.53	High
Feeling safer if treated at this center	2.61	High
Satisfied with the communication and coordination between medical and health staff at the center	2.64	High
Satisfied with the attention of the medical and health personnel and health to your problem	2.68	High
Satisfied with the relationship with the service provider (medical and health staff)	2.68	High
Generally satisfied the time you spent at the health center to receive services	2.44	High
Satisfied with the health center near the place you live	2.64	High
Feel good about diagnostics and treatment costs in the health center	2.67	High

Satisfaction items	M.S	Evaluation
Satisfied with the efficiency of the medical and health staff in the health center	2.59	High
Feel good about respecting medical and health staffs	2.70	High
Feel good about medical and health personnel to clarify the problem understandable manner	2.38	High

Mean of score, Low= 1 -1.66, Moderate= 1.67-2.33, High= 2.34-3

Consumers' are highly satisfied with the type and quality of services that are provided by primary health care centers evidenced by high mean of scores among all items of the scale.

**Table 3. Overall evaluation consumers' satisfaction level for primary healthcare services (176)**

Levels	f	%	M.S	SD
Low	4	2.3	2.69	0.510
Moderate	46	26.1		
High	126	71.6		
Total	176	100		

f: Frequency, %: Percentage, M.S: Mean of score, SD: Standard Deviation, Low= 11-18, Moderate= 19-26, High= 27-33

Consumers show a high level of satisfaction for the services provided at the primary health care centers (71.6%).

### Discussion

Regard to discussing the Socio-demographic characteristics of consumers attending the primary health care centers as the number of consumers who have been taken into account in the quality of health services provided in primary health care centers in Baghdad City (176) table(4-6); the results showed that a high percentage of age groups was associated (30-39) years, average (30.7%), followed by the age group of (20-29) years, at a rate of (29.5%), and the lowest category ( $\leq$  19) years, at a rate of (4%).

These results are consistent with a study conducted by (9). The study included people from four groups in Baihsud District in Jalal Abad City, Afghanistan. The age was between (25-34) years at a rate of (33.4%).

Analysis of the educational level of these consumers indicates that a high percentage indicates education in primary schools (22.7%) Table (4-6). The reason high is because most of the views taken are women, and because most of the women are in the elementary or middle stage

and leave the school, as the lower the educational level, the lower the health culture, and this will increase the health problems in the country, as well as increase the material and human burdens.

Whereas in Afghanistan there is a study similar to ours, but it was recorded that the educational level in which the highest level of illiteracy occurred, not read or write, was found that about two thirds of the participants were illiterate, at a rate of (61.6%). The overall literacy rate (38.5%) (10).

The socio-economic variable indicates that these consumers are linked to the moderate social and economic situation (301000-600000 Iraqi dinars) (48.3%) table (4-6). The Central organization for Statistics in the ministry of Iraqi planning, a whole survey the poverty level and the income rate for individual to the period of (2018-2020) showed the results of the poverty rate (10%), and the income rate less than (50%) is moderate in Baghdad City (11), these results give stability for study. we would like to point out that the level of individual income to helps in resolving many health problems and prevents the ignorance spread.

Regarding the occupational situation, more than half of the consumers are unemployed (56.8%) table (4-6), and these results are consistent with the evaluation of the Central organization for Statistics and the executive management of the poverty alleviation strategy in the Ministry of Planning (11).

The percentage of the unemployed reached (57.3%), For the whole society according to the above, the average economic activity of individuals aged 15-years and over (42.7%) with a difference in the ratio between men (29.7%) and women (13%). the unemployment rate for adults to the age group (15-24) years, when it reached (27.5%), and from 25 or more (29.8%).

The types of services that are utilized by consumers were immunization (31.3%) that presents the highest percentage followed by the services of assessment and

treatment (25%), dental care (17%), childcare (13.6%) and maternal and child health (10.2%).

All of the above explanation it is shown in table (4-6) has been the division of services based on a global scale in the quality of service provided to the consumer's in primary health care centers in the Baghdad City.

These results are consistent with thoughtful study by<sup>(12)</sup> in the Iraqi Institute for Economic Reform.

Providing services in the health care according to the felt needs of patients and clients is the most important to improving service provision to the primary health care system, there is no use to add values to the service so that it is not according to the requirements of the patient or the consumer.

This study was conducted in primary health care centers in Baghdad city, and the results showed that the degree of satisfaction of patients and consumer's about the services provided in primary health care centers that they are very satisfied with the type and quality of services provided by primary health care centers, which is evident from the high mean of scores among all (11) items of the scale, table (4-7-a).the highest item is number (4) (satisfied with the attention of the medical and health personnel and health to your problem) and number(5) (satisfied with the relationship with the service provider (medical and health staff) mean of score(2.68), and the lowest item of the high level is (11) (feel good about medical and health personnel to clarify the problem understandable manner), and total of mean of score.

The results of this study apply with a study conducted by (13) in India on the satisfaction of consumer's and patient's in primary health care centers and the results indicate (98%) are very satisfied. Also, a study in Thailand (77%) revealed a very satisfied<sup>(14)</sup>.

According to the overall evaluation of consumer satisfaction with primary health care services, the results indicate that consumers are very satisfied with the services provided in primary health care centers (71.6%), and the results (26.1%) Moderate are satisfied.

Customer satisfaction has always been an important component when measuring health outcomes and quality of care in both developed and developing countries and is an important indicator of quality of health care. The literature has shown that satisfied customers are more likely to develop a good relationship with the health

system, which leads to better compliance, continuity of care and ultimately better health outcomes. Identifying customer needs and assessing the health services provided is a starting point for a customer-focused approach to health care provision. Therefore, customer satisfaction is an important measure for assessing the quality of health services and can predict compliance and use. The function of health care services is to improve the health status of the population<sup>(15)</sup>.

## Conclusion

1. The Customer Satisfaction Scale is very important to assess the quality of health services and can predict compliance and use with international standards for quality of services.
2. The study found that most primary health care centers are located in densely populated areas. Therefore, primary health care services are adequately provided.

**Recommendations:** The researchers recommend (1) encouraging the continuous use of the customer satisfaction scale to maintain the achievements by assessing the quality of the primary health care services to reach the highest level of the international standards for the quality of services, (2) work to encourage the health care sectors to maintain plans to complete these projects in order to benefit from the largest possible number of the population from the services provided in the primary health care centers.

**Conflict of Interest:** The researchers confirm that there is no any conflict of interest.

**Source of Funding:** This study is self-funded.

**Ethical Clearance:** The researchers obtained the ethical approval from the University of Baghdad, College of Nursing.

## References

1. Turriss SA. Unpacking the concept of patient satisfaction: A feminist analysis. *Journal of Advanced Nursing* [Internet]. 2005 May [cited 2020 Aug 29];50(3):293–8. Available from: <https://search-ebscobhost-com.ezproxy.okcu.edu/login.aspx?direct=true & db=psyh & AN=2005-13842-008 & site=ehost-live>
2. Abdal Kareem A, Aday LA, Walker GM Jr. Patient satisfaction in government health facilities

- in the state of Qatar. *Journal of community health* [Internet]. 1996 Oct [cited 2020 Aug 29];21(5):349–58. Available from: <https://search-ebsohost-com.ezproxy.okcu.edu/login.aspx?direct=true & db=mnh & AN=8894961 & site=ehost-live>
3. Ratanavaraha V, Jomnonkwao S, Khampirat B, Watthanaklang D, Iamtrakul P. The complex relationship between school policy, service quality, satisfaction, and loyalty for educational tour bus services: A multilevel modeling approach. *Transport Policy* [Internet]. 2016 Jan [cited 2020 Aug 29];45:116–26. Available from: <https://search-ebsohost-com.ezproxy.okcu.edu/login.aspx?direct=true & db=a9h & AN=111144301 & site=ehost-live>
  4. Leong L-Y, Hew T-S, Lee V-H, Ooi K-B. An SEM–artificial-neural-network analysis of the relationships between SERVPERF, customer satisfaction and loyalty among low-cost and full-service airline. *Expert Systems with Applications* [Internet]. 2015 Nov [cited 2020 Aug 29];42(19):6620–34. Available from: <https://search-ebsohost-com.ezproxy.okcu.edu/login.aspx?direct=true & db=a9h & AN=102880128 & site=ehost-live>
  5. Chang C-C. Exploring mobile application customer loyalty: The moderating effect of use contexts. *Telecommunications Policy* [Internet]. 2015 Sep [cited 2020 Aug 29];39(8):678–90. Available from: <https://search-ebsohost-com.ezproxy.okcu.edu/login.aspx?direct=true & db=a9h & AN=109956207 & site=ehost-live>
  6. Hill, N. & Netteret, O. *Mesure of client satisfaction (MCS): Client satisfaction is now viewed as an important measure of protection against potential problems in healthcare delivery*, 6th ed. 2005, 1121-1125.
  7. Bell L. Developing service quality in mental health services. *International Journal of Health Care Quality Assurance*, 17(7), 2004, 401-6.
  8. World Health Organization (WHO). *Primary Health care: A framework future strategic directions*. Geneva, Switzerland: Author, 2003.
  9. United Nations, Department of Economic and Social Affairs, Population Division. *World Population Prospects: The 2012 Revision, Highlights and Advance Tables Working*, 2013.
  10. Central Statistics Organization. *National risk and vulnerability assessment 2011-12. Afghanistan Living Condition Survey*. Kabul, CSO.2014.
  11. Ministry of Planning, Central Statistical Organization and Executive Management of the Poverty Reduction Strategy 2018-2020, and in cooperation with the Statistics Authority of the Kurdistan Region and the World Bank, *Survey and Calendar of Poverty in Iraq for 2018*.
  12. Anbori A. Client’s satisfaction of healthcare services in Iraq: The study and analysis of the views of client’s in Baghdad City, quality management and client’s satisfaction, *Iraqi Institute for Economic Reform Journal*, 2(10), 2011, 13-17.
  13. Rasheed N, Arya S, Acharya A, Khandekar J. Client satisfaction and perceptions about quality of health care at a primary health centre of Delhi, India. *Indian Journal of Community Health* [Internet]. 2012 Jul [cited 2020 Aug 29];24(3):237–42. Available from: <https://search-ebsohost-com.ezproxy.okcu.edu/login.aspx?direct=true & db=ccm & AN=103773907 & site=ehost-live>
  14. Upreti, S. *Consumer satisfaction towards health centers in Suphanburi province, Thailand*. MPHM Thesis in Primary Health Care Management, Bangkok, Faculty of Graduate studies, Mahidol University, (1994).
  15. Laschinger HS, Hall LM, Pedersen C, Almost J. A psychometric analysis of the Patient Satisfaction with Nursing Care Quality Questionnaire: an actionable approach to measuring patient satisfaction. *Journal of Nursing Care Quality* [Internet]. 2005 Jul [cited 2020 Aug 29];20(3):220–30. Available from: <https://search-ebsohost-com.ezproxy.okcu.edu/login.aspx?direct=true & db=ccm & AN=106499020 & site=ehost-live>

# Relationship of IL-6 Level and Lipid Profile as Predictor Ventilator-Associated Pneumonia

Taufiq Gemawan<sup>1</sup>, Arie Utariani<sup>2</sup>, Kuntaman<sup>3</sup>

<sup>1</sup>Resident of Department of Anesthesiology and Intensive Care, Faculty of Medicine, Airlangga University-Dr Soetomo General Hospital, Mayjend Moestopo Street No. 6-8, Gubeng, Surabaya, East Java 60285, Indonesia,

<sup>2</sup>Staff of Department of Anesthesiology and Intensive Care, Faculty of Medicine, Airlangga University-Dr Soetomo General Hospital, Mayjend Moestopo Street No. 6-8, Gubeng, Surabaya, East Java 60285, Indonesia, <sup>3</sup>Staff of Department of Clinical Microbiology, Faculty of Medicine, Airlangga University-Dr Soetomo General Hospital, Mayjend Moestopo Street No. 6-8, Gubeng, Surabaya, East Java 60285, Indonesia

## Abstract

**Background:** Respiration support by mechanical ventilation is an important aspect in intensive care. However, it could induce complication as infection. Ventilator Associated Pneumonia (VAP) is the most common infection in patient with ventilator support. This infection have an impact to patient's length of stay and prognosis. VAP will be followed with inflamatory responses consist of elevation IL-6 level and lipid profile abnormality. Therefore objective evaluation for acute inflammation could be a tool to diagnose VAP early.

**Method:** This study is analitic observational with prospektif design, to know the relationship of IL-6 dan lipid profile (HDL and LDL) toward VAP incidence in 38 patient under Intensive Care treatment. Subject observed for 7 days and IL-6, HDL,LDL levels were examined in the day with ventilator and 48 hours after it.

**Result:** VAP occur in 23 subject (65,53%) from all population. IL-6 (1), IL-6(2) and  $\Delta$  IL-6 levels have significant effect to VAP incidence. HDL (1), HDL (2), LDL (1), and LDL (2) levels have significant effect to VAP group. And  $\Delta$  HDL and  $\Delta$  LDL levels have significant effect to both group, VAP and non-VAP subjects.

**Conclusion:** IL-6, HDL and LDL level change have relation as predictor VAP incidence.

**Keywords:** Ventilator, IL-6, HDL, LDL, VAP.

## Introduction

Ventilator Associated Pneumonia (VAP) is an infection that often occurs in patients using mechanical ventilators. VAP could lengthening of the patient's stay in the ICU as well as worsen the prognosis<sup>1</sup>. VAP is the second most common nosocomial infection and

the first cause of death from nosocomial infections in critically ill patients. It incidence ranges from 5% to 67% of cases, and most of are immuno compromised patients, postoperatively and geriatric patients. In USA, the incidence of VAP ranges from 2 to 16 episodes every 1000 days on the ventilator<sup>2</sup>.

VAP is a lung infection, which will trigger inflammatory responses. Although VAP occurs without complications, smaller inflammatory reactions are triggered. Inflammatory responses due to infection are associated with increased levels of cytokines, including Interleukin-6 (IL-6) and Interleukin-8 (IL-8). IL-6 is a synthetic protein that induces acute phase hormones by the liver<sup>3,4</sup>.

---

### Corresponding Author:

**Arie Utariani**

Staff of Department of Anesthesiology and Intensive Care, Faculty of Medicine, Airlangga University-Dr Soetomo General Hospital, Mayjend Moestopo Street No. 6-8, Gubeng, Surabaya, East Java 60285, Indonesia

Changes in the lipid profile are influenced by changes in lipid metabolism in patients with acute inflammation that are related to the severity of the underlying disease in the patient<sup>5</sup>. In infections, lipopolysaccharides (LPS) and pathogenic fats are covered by HDL-C (High Density Lipoprotein), LDL (Low Density Lipoprotein) and Very Low Density Lipoprotein. And, HDL-C in particular has the highest affinity for LPS<sup>6</sup>. Interleukin 6, along with several other cytokines also influence HDL levels through modification of triglycerides lipase. It shows that pro-inflammatory cytokines play a role in inhibiting the activity of lipoprotein lipase (LPL) and increasing the activity of Endothelial Lipase (EL), both of which are associated with low HDL levels during acute or chronic inflammatory inflammation<sup>7</sup>. Endothelial lipase (EL) is known as a member of the lipoprotein lipase gene family which is hydrolyzes HDL phospholipids and reduce HDL cholesterol level. Therefore, inhibition of EL can increase HDL. And EL is one of the important enzymes in the regulation of HDL metabolic physiology<sup>8</sup>.

This study is aimed to find an association between IL-6 and lipid profile as predictors of VAP events.

### Material and Method

This study was an observational analytic with a prospective design, to determine the relationship of IL-6 levels and lipid profiles (HDL and LDL) as predictors of VAP incidence. It conducted at Regional Hospital in Indonesia from January to April 2020. All patient met inclusion criteria were observed daily for signs and symptoms of VAP according CDC diagnose criteria 2010. There are two point of profile lipid and IL-6 examination. The first is after intubation and ventilator support and the second is after 2 days of ventilator support. All patient observed for day-1 to day-8.

### Results and Discussion

This study was approved by the Research Ethics Committee of the RSUD Dr. Soetomo Surabaya. There are 37 patients met the study inclusion and exclusion criteria. All subject characteristics and diagnose are described in table 1.

This study shows there are 23 patient diagnosed for VAP (60,53%) from study population. It consist of 18 male and 5 female. These VAP patient are treated in ICU (5 patients), Resuscitation Room (RES) (3 patients) and Intermediet Observation Room (ROI) (15 patients).

**Table 1. Subject Characteristics**

	VAP		Total	P value	RR (CI95%)
	Yes (n=22)	No (n=15)			
<b>Gender</b>					
Male	18(69,2%)	8(30,8%)	26	0,157	1,66(0,81-3,4)
Female	5(41,7%)	7(58,3%)	12		
<b>Unit</b>					
ICU	5(71,4%)	2(28,6%)	7		
RES	3(33,3%)	6(66,7%)	9		
ROI	15(68,2%)	7(31,8%)	22		
<b>Age</b>					
Mean ± SD	49,8±11,2	43,5±11,9	47,3±11,76	0,114	1,05(0,49-1,12)
<b>Diagnose</b>					
Perforated Appendicitis			1		
Hematothorax			1		
Metabolic Acidosis+ CKD			3		
Pulmonary Edema+ CKD			4		
Severe Brain Injury			4		
Coronary Artery Disease			2		

	VAP		Total	P value	RR (CI95%)
	Yes (n=22)	No (n=15)			
Pulmonary edema+ Eclampsia			4		
Intra Cerebral Hematoma			7		
Severe Pre-eclampsia			3		
Myastenia Gravis			4		
Guillen-Barre Syndrome			2		
Phlegmon			2		
Peritonitis			2		

The difference value ( $\Delta$ ) of IL-6 obtained 18.9 ng/L (1.8 - 188.5 ng/L) in the VAP case and  $\Delta$  IL-6 value was -1.6 ng/L (-22.9 - 1 ng/L) in non-VAP cases (p value <0,0001) with a correlation coefficient of 1,000. The  $\Delta$  HDL values obtained -19 mg/dL (-32 - (-5) mg/dL) in VAP cases and  $\Delta$  HDL values of -1 mg/dL (-2-2 mg/

dL)(p values <0, 0001) with a correlation coefficient of 1,000. The  $\Delta$  LDL value is -27 mg/dL (-61 - (-11) mg/dL) in the VAP case and the  $\Delta$  LDL value is -1 mg/dL (-3-3 mg/dL) (p value <0,0001) with a correlation coefficient of 1,000. All of these value described in table 2.

**Table 2. Relationship of different value ( $\Delta$ ) IL-6, HDL, LDL with VAP incidence**

Nilai $\Delta$	Kejadian VAP		Nilai p	Koefisien Korelasi	RR (CI 95%)
	Ya	Tidak			
IL-6	18,9(1,8-188,5)	-1,6(-22,9-1)	<0,0001	1,000	NA
HDL	-19(-32-(-5))	-1(-2-2)	<0,0001	1,000	NA
LDL	-27(-61-(-11))	-1(-3-3)	<0,0001	1,000	NA

As described earlier, in this study we examine two times, first we do at the first time patient supported with ventilator(value 1) and the the second is when patients

already supported by ventilaor for two days (value 2). The value of of these examination described in table 3.

**Table 3. Relationship between IL-6, HDL, and LDL value with VAP incidence**

	Nilai 1 <sup>a</sup>	Nilai 2 <sup>b</sup>	Nilai p
<b>VAP (+)</b>			
IL-6	14,25 (2,3 -35)	42,4 (6,1-202,7)	<0,0001*
HDL	35 (16-52)	12 (7-31)	<0,0001*
LDL	80 (43-98)	47 (14-79)	<0,0001*
<b>VAP (-)</b>			
IL-6	51,8 (11,1-92,30)	41,20 (10,7-92,0)	0,003*
HDL	51 (13-54)	52 (12-54)	0,08
LDL	93 (42-98)	93 (42-96)	0,273

<sup>a</sup>: examintaion at the first time supported by ventilator, <sup>b</sup>: examination after 2 days of ventilator support



VAP in patients, especially critically ill patients, is a disadvantage. This will worsen patient's prognosis and increase his morbidity and mortality. Early recognition and detection in critically ill patients can reduce the risk to VAP incidence. In Intensive Care Unit (ICU), The observations of VAP signs and symptoms are carried out routinely especially when the ventilator is used for more than 48 hours or 2 days. Therefore, VAP condition can be recognized early to prevent further complications which will worsen patient's critical condition. However, its implementations become difficult due to the severity of patient's condition in the ICU. Therefore, we need an objective sign that helps in establishing the diagnosis of VAP in patients at risk. In this research, HDL and LDL and IL-6 levels were used as markers for the VAP incidence.

In prospective study of 44 ventilated patient, it is concluded that IL-6 values are significantly different cytokines in patients with confirmed VAP compared to other types of cytokines. In addition IL-6 was found as a fairly high risk predictor of VAP with a high sensitivity and specificity value<sup>4</sup>. In a retrospective study, it was found that IL-6 values of more than 100 pg/mL on the first day of patients on ventilator were predictive for infectious complications in patients with ventilators, mainly lung infections and associated with increased mortality. This is related to the inflammatory response to the course of infection that begins to arise which in this case is a complication of infection due to ventilator or VAP<sup>9</sup>.

Interleukin 6, along with several other cytokines also influence HDL levels through modification of triglycerides lipase. It shows that pro-inflammatory cytokines play a role in inhibiting the activity of lipoprotein lipase (LPL) and increasing the activity of endothelial lipase (EL), both of these are associated with low HDL levels during acute or chronic inflammation<sup>7</sup>. Endothelial lipase (EL) is known as a member of the lipoprotein lipase gene family which hydrolyzes HDL phospholipids and lowers HDL cholesterol level. So that inhibition of EL could increase HDL and EL is one of the important enzymes in the regulation of HDL metabolic physiology<sup>8</sup>. In serum, LPS which is an endotoxin in gram-negative bacteria is predominantly bound to VLDL and LDL, via LDL receptors. This results in inactivation of LPS. Then LPS is quickly taken by hepatocytes to be delivered into peripheral cells<sup>10</sup>.

## Conclusion

This study found that the examination of IL-6, HDL and HDL have potential as predictor of VAP incidence, so serial examination of these biomarker could detect VAP earlier to minimize its complication and improve patient prognosis.

**Acknowledgements:** We sincerely thanks to all patients of ICU unit for the participation in this research and all co-author, lecturers and staff for all advice and guidance for this paper.

**Conflict of Interest:** The authors declare that there is no conflict of interest for this research.

**Source of Funding:** The authors received no financial support for the research, authorship, and/or publication of this article.

**Ethical Clearance:** This research is approved by Health Research Ethical Committee Soetomo Teaching Hospital Surabaya.

## References

1. Karatas M, Saylan S, Kostakoglu U, Yilmaz G. An assessment of ventilator-associated pneumonias and risk factors identified in the Intensive Care Unit. *Pak J Med Sci.* 2016 Jul-Aug;32(4):817-22. doi: 10.12669/pjms.324.10381.
2. Timsit JF, Esaied W, Neuville M, Bouadma L, Mourvillier B. Update on ventilator-associated pneumonia. *F1000Res.* 2017 Nov 29;6:2061. doi: 10.12688/f1000research.12222.1
3. Bonten MJ, Froom AH, Gaillard CA, Greve JW, de Leeuw PW, Drent M, Stobberingh EE, Buurman WA. The systemic inflammatory response in the development of ventilator-associated pneumonia. *Am J Respir Crit Care Med.* 1997 Oct;156(4 Pt 1):1105-13. doi: 10.1164/ajrccm.156.4.9610002.
4. Ramírez P, Ferrer M, Gimeno R, Tormo S, Valencia M, Piñer R, Menendez R, Torres A. Systemic inflammatory response and increased risk for ventilator-associated pneumonia: a preliminary study. *Crit Care Med.* 2009 May;37(5):1691-5. doi: 10.1097/CCM.0b013e31819fec5f.
5. Khovidhunkit, W, Memon R, Feingold K, Grunfeld C. Infection and Inflammation-Induced Proatherogenic Changes of Lipoproteins. *The Journal of Infectious Diseases.* 2000;181(s3):S462-S472.

6. Cirstea M, Walley KR, Russell JA, Brunham LR, Genga KR, Boyd JH. Decreased high-density lipoprotein cholesterol level is an early prognostic marker for organ dysfunction and death in patients with suspected sepsis. *J Crit Care.* 2017 Apr;38:289-294. doi: 10.1016/j.jcrc.2016.11.041..
7. Zuliani G, Volpato S, Blè A, Bandinelli S, Corsi AM, Lauretani F, Paolisso G, Fellin R, Ferrucci L. High interleukin-6 plasma levels are associated with low HDL-C levels in community-dwelling older adults: the InChianti study. *Atherosclerosis.* 2007 Jun;192(2):384-90. doi: 10.1016/j.atherosclerosis.2006.05.024.
8. Jin W, Millar JS, Broedl U, Glick JM, Rader DJ. Inhibition of endothelial lipase causes increased HDL cholesterol levels in vivo. *J Clin Invest.* 2003 Feb;111(3):357-62. doi: 10.1172/JCI16146.
9. Woiciechowsky C, Schöning B, Cobanov J, Lanksch WR, Volk HD, Döcke WD. Early IL-6 plasma concentrations correlate with severity of brain injury and pneumonia in brain-injured patients. *J Trauma.* 2002 Feb;52(2):339-45. doi: 10.1097/00005373-200202000-00021.
10. Topchiy E, Cirstea M, Kong HJ, Boyd JH, Wang Y, Russell JA, Walley KR. Lipopolysaccharide Is Cleared from the Circulation by Hepatocytes via the Low Density Lipoprotein Receptor. *PLoS One.* 2016 May 12;11(5):e0155030. doi: 10.1371/journal.pone.0155030.

# Saliva of Tobacco Smokers a Profile of C3, IgA, Amylase and Total Protein

Zahraa Hussein M. Kadri<sup>1</sup>, Hazima Mossa Alabassi<sup>2</sup>, Ahlam Jassim Taher<sup>2</sup>

<sup>1</sup>Ass. Lecturer, <sup>2</sup>Ass. Prof., Department of Biology, College of Education for Pure Science (Ibn Al-Haitham), University of Baghdad, Iraq

## Abstract

**Objective:** The present study aimed to shed light on the role of narghileh and cigarette smoking on immunity status of oral cavity by assess (C3 complement component, Immunoglobulin A, Total protein,  $\alpha$ -Amylase and EBV IgG antibody).

**Method:** Saliva levels in two smokers groups the first include 28 narghileh smokers and the second include 32 narghileh and cigarette smokers as well as 30 non-smokers consider as control.

**Results:** As compared control, the levels of C3, IgA and total protein were significantly decreased, and the highest decreased was observed in saliva of narghileh and cigarette smokers, the result was (C3=  $0.400 \pm 0.194\mu\text{g}$  vs.  $9.728 \pm 3.561\mu\text{g}$ ; IgA=  $2.460 \pm 0.492\text{mg/dl}$  vs.  $5.048 \pm 0.937\text{mg/dl}$ ; Total protein=  $170.20 \pm 45.93\text{mg}\%$  vs.  $452.20 \pm 136.57\text{mg}\%$ , respectively) while the level of  $\alpha$ -amylase was slightly dropped but with a non-significant, the result was ( $246.37 \pm 122.47, 243.56 \pm 178.69$  vs,  $213.51 \pm 101.88$ ) respectively.

**Conclusion:** The narghileh and cigarette can alter the microenvironment of oral cavity and influence the immunity of mucosa tissue, then increase the risky for many diseases such as blood hypertension, heart diseases, and lung diseases and may contribute to a variety of cancer.

**Keywords:** Smoking, complement component, total protein, amylase, EBV.

## Introduction

Narghileh, argileh, hookah, shisha, hubble-bubble, water-pipe and goza all of these nomenclatures refer to the same way of smoking. Narghileh is an old habit that has been use for 400 years, created in Asia and India. Narghileh smokers are exposed to many carcinogenic compounds toxic materials like nicotine, carbon monoxide, heavy metals and many toxic materials depend on puffing time, number of puffs and smoke inhalation<sup>(1)</sup>.

Smoke inhalation has also been associated with elevation in the total white blood cells count, platelet activation and increased expression of proinflammatory cytokines (IL-6 and TNF-alpha) in the bronchoalveolar lavage fluid. A study performed by researchers Al-sawalha and his coworkers in 2017 on a mouse model showed an association between narghile and airway inflammation and it raises blood pressure and heart rate so this may increase the risk of heart attack and stroke

and may contribute to a variety of cancer, heart disease and lung diseases<sup>(2)</sup>.

Saliva as obtained from the oral cavity is a mixture containing the contribution of the various salivary glands, the oral tissues microorganism, and ingested substance, optimum PH is 8.57. It has many important roles; the most important one is the protection of oral environment from the numerous microbes that constantly exposed to through our mouth. Plasma B cells reside in the salivary gland and produce IgA antibody which is the common saliva Immunoglobulin, proline-rich protein, cystatins lysozyme, salivary amylase, peroxidase, and cationic peptides (i.e defensine, lactoferrin, and cathelcidine). IgA is the major class of salivary antibodies which constitute about (80-90%) of the salivary antibodies<sup>(3)</sup>.

Salivary lysozyme can influence human granulocyte and lymphocyte function it seem to be active against bacteria, fungi and exerts antiviral properties as well as may induce lysis of tumor cells<sup>(4)</sup>,  $\alpha$ -amylase is a

highly abundant protein in saliva that perform a direct inhibitory effect on the growth of certain bacteria<sup>(5)</sup>, and may also exert virus inhibitory properties.  $\alpha$ -amylase initiate the digestion process in oral cavity and modulate the bacterial growth and adhesion on intraoral surfaces and it is consider as a physiological marker<sup>(6)</sup>. As well as complement function can be enhanced when meet saliva at the gingival margin, the potential of the complement system by saliva may play a role in neutralizing certain viral infections on mucosal surface. In addition increase or decrease saliva biomarkers contribute directly to describing the oral health also for diagnosis and monitoring oral diseases or prognosis for many systemic diseases in the future<sup>(7)</sup>.

EBV is an orally transmitted human herpesvirus that infect epithelial cells and establishes latency in memory B lymphocyte .EBV exhibit a biphasic life cycle it's dual tropism for B lymphocyte and epithelial cells, which allow the virus to be transmitted within oral lymphoid tissues. The ability of EBV to immortalize B cells and its prevalence in a subset of cancer has implicated EBV as a carcinogenic cofactor in cellular context where the viral life cycle is altered .Conferring malignant phenotype observed in EBV –positive cancer. Given that oral cavity serve as the main site of EBV residence and transmission<sup>(8)</sup>.

The topic of this study is to evaluate the important saliva component that may contribute to maintain oral immunity in narghile smokers.

## Materials and Method

**Subjects and saliva samples:** A total of 90 Iraqi (healthy males) aged (18-25) years. They were distributed in to two groups the first include 28 Narghileh smokers, the second include 32 Narghileh and cigarette smokers

as well as 30 non-smokers (control). Individuals in the study were fasting and asked to drink water. After ten minutes saliva samples were collected by spitting into a sterile universal tube. The samples centrifuged for 10 minutes at 4000 RPM and collected saliva were frozen at  $-80^{\circ}\text{C}$  until assessment<sup>(9)</sup>.

C3, IgA and total protein were determined by means of Automated Biosystem A15 while  $\alpha$ -amylase were determined in saliva using (Human  $\alpha$ -amylase; K LAB) kit. EBV IgG antibody was determined by means of ELISA using commercially available kits (Human EBV VCA IgG; IMMUNOLAB GmbH).

**Data Analysis:** The statistical analysis was performed using SPSS version 13. Their data were given as mean  $\pm$  standard deviation (SD.), and differences between means were assessed by ANOVA, and then followed by LSD or Duncan test A p-value of  $\leq 0.05$  was considered a significant.

## Results and Discussion

Numerous studies related to oral health among narghile smokers have been done to evaluate the effect of cigarette and narghile smoking on oral health among the practice people particularly youth, our study is one of these studies which aimed to the same target.

In this study different salivary constituent were assessed in saliva of narghile and cigarette smokers these factor included (C3, IgA Ab, total protein,  $\alpha$ -amylase and specific IgG EBV Ab). As shown in table 1, which reveal the saliva level of C3 complement component in the three understudying groups (Non-smokers; NS, Narghile smokers; NAS and Cigarette smokers; CS) respectively the result of mean  $\pm$  SD. was  $(9.728 \pm 3.561, 3.60 \pm 3.082$  and  $0.400 \pm 0.194\mu/\text{ml})$  respectively.

**Table 1: C3 level in saliva of smokers and non-smoker**

Groups	C3 (micrograms/ml)		
	Mean $\pm$ SD	Minimum	Miximum
Non-smokers (No.= 30)	9.728 $\pm$ 3.561 <sup>C</sup>	4.80	15.00
Narghileh smokers (No.= 28)	3.608 $\pm$ 3.082 <sup>B</sup>	0.80	9.00
Narghileh and Cigarette smokers (Mo.=32)	0.400 $\pm$ 0.194 <sup>A</sup>	0.12	0.64

\*Different letters represent significant difference between means in columns ( $P \leq 0.05$ ).

The result revealed a highly significant decreasing among the three groups particularly between Non-smokers vs. (Narghileh smokers & Cigarette smokers)  $p < 0.05$ . our finding is disagree with study performed by Frial G. at 2008 which recorded an increasing level for both (C3 & C4) complement component in smoker groups compared with control <sup>(10)</sup>.

A study carried out by Kew (Kew et al. 1985) <sup>(11)</sup> which also recorded an increasing level for C3 complement component, this finding explained by Kew who said that the increasing of complement serum level may related to the incorporation between smoke and C3 so the thioester bond may be intact, then he suggested that aqueous whole cigarette smoke solution can modify C3 and activate the alternative pathway of complement system. Furthermore a study which performed by (Alabassi and Al Nadawi 2020) <sup>(12)</sup>, revealed an elevation in complement component C9 serum level in asthmatic patients exposed to smoking the result was  $(118.08 \pm 5.45 \text{ pg/ml})$  as compared to control  $(94.47 \pm 6.29 \text{ pg/ml})$  while patient not exposed to smoking recorded a significant ( $p < 0.05$ ) complement C9 serum level  $(104.61 \pm 2.64 \text{ pg/ml})$  as compared to smoke exposed control which recorded  $(80.07 \pm 2.25 \text{ pg/ml})$ .

The conflict between the finding of the present study with previous studies may related to type of specimen used in our study, Frial <sup>(10)</sup>, Kew <sup>(11)</sup> (carried out their study on serum sample while the present study was carried out by using saliva samples. And the explanation of decreasing C3 saliva level may contribute to the depletion of C3 in plasma and tissue as a consequence of the activation of alternative complement pathway of the narghile smokers. In regard to IgA saliva level, the present study recording a significant decreasing of IgA saliva level among the three understudying groups and the highest lowering in the third group (narghile and cigarette smokers). Table 2 -demonstrate the IgA saliva level in three groups (NS, NAS and CS). The mean  $\pm$  SD. was  $(5.048 \pm 0.937, 3.560 \pm 0.038 \text{ \& } 2.460 \pm 0.492 \text{ mg/dl})$  respectively. There was a significant decreasing among the three understudying groups  $P \leq 0.05$ . This finding is agree with previous studies (Sahib and Radhi 2018) <sup>(13)</sup> which observed a decreasing IgA saliva level, this decreasing may related to the effect of tobacco that may lead to impairment of body immune function. In addition to the impairment of Ag mediating signaling of T cell leading to immunosuppression.

**Table 2: IgA level in saliva of smokers and non-smoker**

Groups	IgA (mg/dl)		
	Mean $\pm$ SD.	Minimum	Miximum
Non-smokers (No.=30)	$5.048 \pm 0.937^C$	4.00	6.11
Narghileh smokers (No.=28)	$3.560 \pm 0.0381^B$	2.90	4.00
Narghileh and Cigarette smokers (Mo.=32)	$2.460 \pm 0.492^A$	1.80	3.00

\*Different letters represent significant difference between means in columns ( $P \leq 0.05$ ).

**Table 3: Total protein level in saliva of smokers and non-smoker**

Groups	Total protein (mg%)		
	Mean $\pm$ SD	Minimum	Miximum
Non-smokers (No.=30)	$452.20 \pm 136.57^C$	212.00	600.00
Narghileh smokers (No.=28)	$306.20 \pm 70.872^B$	194.00	411.00
Narghileh and Cigarette smokers (Mo.=32)	$170.20 \pm 45.93^A$	117.00	221.00

\*Different letters represent significant difference between means in columns ( $P \leq 0.05$ ).

In respect to the total protein saliva level, and as shown in table 3, this research finding record a significant decreasing of saliva total protein among the three understudying groups the result was  $(306.20 \pm 70.872$

and  $170.20 \pm 45.93 \text{ mg\%})$  respectively as compare to non-smokers  $(452.20 \pm 136.57 \text{ mg\%})$ . This finding was disagree with study carried out by (Zainulabdeen and Alak 2014) <sup>(14)</sup>, which recorded a high elevating total

serum protein in smokers vs. non-smokers. The conflict between our results may relate to the type of specimen. Also the decreasing of saliva total protein is parallel to the decreasing of saliva constituent which recorded decreasing in this investigation.

As shown in Table 4 the saliva level of  $\alpha$ -amylase enzyme recorded a non-significantly increasing among the three groups  $P \leq 0.05$  and result was  $(213.51 \pm 101.88, 246.73 \pm 122.47$  and  $243.56 \pm 178.69$  U/L) respectively. This finding is agree with the previous

research in which the reduction of amylase activity of serum narghileh smokers is most probably due to the interaction between smoke aldehyde and SH-groups of the amylase molecule (Singh et al. 2018) <sup>(15)</sup>. Another study recorded a non-statistically significant difference in salivary  $\alpha$ -amylase level between smokers and non-smokers this study is agree with the present study. While Greabu and colleagues (Greabu et al. 2007) <sup>(16)</sup> indicated that exposure to cigarette smoke decreased salivary amylase activities.

**Table 4: Alpha-amylase level in saliva of smokers and non-smoker**

Groups	$\alpha$ -amylase (U/L)		
	Mean $\pm$ SD	Minimum	Miximum
Non-smokers (No.=30)	213.51 $\pm$ 101.88 <sup>A</sup>	67.22	343.99
Narghileh smokers (No.=28)	246.73 $\pm$ 122.47 <sup>A</sup>	130.48	470.52
Narghileh and Cigarette smokers (Mo.=32)	243.56 $\pm$ 178.69 <sup>A</sup>	126.52	581.23

\* Similar letters represent no significant difference between these means ( $P > 0.05$ ).

The last finding of our investigation is the level of saliva IgG EBV antibody in narghile smokers. Table-5- revealed the +ve and -ve IgG EBV antibody in just two groups which were (NS & NAS) the result was obtained by using ELISA technique which revealed a slight distribution percent among the NAS. The result was (3+ve out of 27 -ve with distribution percent 11.11% for NS and 5+ve out of 23 -ve with distribution percent 21.73% for NS. A study performed by Chen and his coworkers (Chen et al. 2018) <sup>(17)</sup> who investigate the association between cigarette smokers infect with EBV and has nasopharyngeal carcinoma such pointed that cigarette smoking appear to be as risk factor of nasopharyngeal carcinoma (NPC) in people with+ve EBV IgA antibody but the association remain unclear. Furthermore Hodstrom and his coworkers (Hodstrom et al. 2020)<sup>(18)</sup> reported that smoking increases EBNA-1 antibody levels and acts synergistically with EBV infection to increase Multiple sclerosis risk.

**Table 5: Positive and negative for EBV IgG in narghile smokers and non-smokers**

Groups	EBV IgG	
	Saliva	Distribution of EBV(%)
Non-smokers (No.=30)	(3)+ve, (27)-ve	11.11
Narghileh smokers (No.=28)	(5)+ve, (23)-ve	21.73

### Conclusions

- Based on our finding the percentage of EBV IgG Ab (21.73%) and despite the slight elevation compared to the non-smokers but still consider a risk factor of initiation the nasopharyngeal carcinoma.
- The lowering of immune constituent of saliva in oral cavity may enhance the reactivation of EBV infection that may induce the abnormal growth in nasopharyngeal tissue.
- Narghile smoking affect oral health, narghile and cigarette smoking can changing the microenvironment of oral cavity which may influence the mucosa tissue of oral cavity also may become a risk factor for many type of diseases

**Acknowledgment:** The author would like to introduce his thanks and gratefulness to College of Education for Pure Science (Ibn Al-Haitham), University of Baghdad, Iraq

**Conflicts of Interest:** The author declares that there are no conflicts of interest.

**Funding:** There is no source of any funding

**Ethic Statement:** The researchers already have ethical clearance from all required institution and laboratories.

## References

1. Qasim H, Alarabi AB, Alzoubi KH, Karim ZA, Alshbool FZ, Khasawneh FT. The effects of hookah/waterpipe smoking on general health and the cardiovascular system. *Environmental Health and Preventive Medicine*. 2019; 58: 1-17.
2. Al-Sawalha NA, Migdadi AM, Alzoubi KH, Khabour OF, Nidal AQ. Effect of waterpipe tobacco smoking on airway inflammation in murine model of asthma. *Inhalation Toxicology*. 2017; 29: 46-52.
3. Fabian TK, Hermann P, Beck A, Fejerdy P, Fabian G. Salivary Defense Proteins: Their Network and Role in Innate and Acquired Oral Immunity. *International Journal of Molecular Sciences*. 2012; 13: 4295-4320.
4. Ibrahim HR, Thomas U, Pellegrini A. A helix-loop-helix peptide at the upper lip of the active site cleft of lysozyme confers potent antimicrobial activity with membrane permabilization action. *Journal of Biological Chemistry*. 2001; 276: 43767-43774.
5. Shugars DC, Wahl SM. The role of the oral environment in HIV-1 transmission. *Journal of American Dental Association*. 1998; 129: 851-858.
6. Rohleder N, Nater UM. Determinants of salivary alpha-amylase in humans and methodological considerations. *Psychoneuroendocrinology*, 2009; 34: 469-485.
7. Ridha HSh, Kadri ZHM. Assessment of some immunological biomarkers in saliva and serum of Iraqi patients with chronic periodontitis disease. *Journal of Pharmaceutical Sciences and Research*, 2018; 10(11): 2998-3000.
8. Jiang R, Scott RS, Hutt-Fletcher LM. Epstein-Barr Virus Shed in Saliva Is High in B-Cell-Tropic Glycoprotein gp42. *Journal of Virology*. 2006; 80:7281-7283
9. Almerich-Silla JM, Pastor S, Serrano F, Puig-Silla M, Dasí, F., (2015). Oxidative stress parameters in saliva and its association with periodontal disease and types of bacteria. *Disease markers*, 2015: 653537. doi: 10.1155/2015/653537
10. Frial G. Studing of immunoglobulins, C3, C4 and IL-8 concentrations in serum smokers and non-smokers. *Journal of Kerbala University*. 2008; 6: 16-19.
11. Kew RR, Ghebrehiwet B, Janoff A Cigarette smoke can activate the alternative pathway of complement in vitro by modifying the third component of complement. *Journal of Clinical Investigation*, 1985; 75(3): 1000-1007. doi: 10.1172/JCI111760
12. Alabassi HM, Al Nadawi W. (2020). The complement component C9 and nitric oxide serum level in Iraqi patients with asthma. *Annals of Tropical Medicine and Public Health*, 23(10). DOI: 10.36295/ASRO.2020.231023
13. Sahib AM, Radhi NJMH. Salivary constituent in relation to dental caries among coffee-shop workers in Najaf city/Iraq. *International Journal of Medical Research & Health Sciences*. 2018; 7: 86-92.
14. Zainulabdeen JA, Alak SA. Effects of Smoking on Proteins Level and Alpha Amylase Activity in Sera of Iraqi Narghile Smokers. *Al-mustansiriyah Journal of Science*. 2014; 25: 33-40.
15. Singh S, Sharma M, Rohilla N, Salgotra V, Kumar V, Sharma RK. Assessment of Salivary Catalase, a-Amylase, and Cotinine Levels in Chronic Smokers: A Comparative Study. *Journal of Contemporary Dental Practice*. 2018; 19: 253-256.
16. Greabu M, Battino M, Totan A, Mohora M, Mitrea N, Totan C, Spinu T, Didilescu A. Effect of gas phase and particulate phase of cigarette smoke on salivary antioxidants. What can be the role of vitamin C and pyridoxine? *Pharmacology Reports*. 2007; 59: 613-318.
17. Chen Y, Xu Y, Zhao W, Xiao X, Zhou X, Lin L, et al. Lack of association between cigarette smoking and Epstein Barr virus reactivation in the nasopharynx in people with elevated EBV IgA antibody titres. *BMC Cancer*. 2018; 18(1): 190. doi: 10.1186/s12885-018-4110-6.
18. Hodstrom AK, Huang J, Brenner N, Butt J, Hillert J, et al. Smoking and Epstein-Barr virus infection in multiple sclerosis development. *Science Reports*. 2020; 10: 10960. doi: 10.1038/s41598-020-67883-w.

# Anti-Islet Cell Antibody and Anti-ovarian Antibody Levels in Iraqi Women with Polycystic Ovary Syndrome

Zainab Ali Hlail<sup>1</sup>, Ahmed Sahib Abd-ulamir<sup>2</sup>, Khalil Ismail Abd-Mohammed<sup>3</sup>, Mohammed Odah Salman<sup>3</sup>

<sup>1</sup>Lecturer, College of Medicine/University of Baghdad, Baghdad, Iraq, <sup>2</sup>Prof., College of Medicine/Al-Nahrain University, Baghdad, Iraq, <sup>3</sup>Prof. High Institute of Infertility Diagnosis and Assisted Reproductive Technology (ART)/Al-Nahrain University, Baghdad, Iraq

## Abstract

**Objective:** The objective of this analysis was to assess serum islet cell anti-bodies concentrations and anti-ovarian anti-bodies in the relationship between the PCOS patient and the stable control group.

**Material and Method:** In this study, 250 Iraqi women aged between 20-50 years were studied. The patients were divided into two groups: study group (n=125, PCOS women) and age-matched controls group (n=125 normal women). The blood sample was obtained on the 2nd day of menstruation cycle. Islet cells Ab and anti ovarian Ab concentrations were determined in both groups.

**Results:** Women with PCOS had higher serum islet cell concentrations higher than control levels ( $p < 0.05$ ). The levels of islet cells Ab and Anti-ovarian Ab were substantially positively associated with BMI, high levels of anti-mullerian hormone (AMH) and insulin resistance.

**Conclusion:** The evidence from this study indicated that serum Islet cells Ab and anti-ovarian Ab levels in women with PCOS were observed to be higher compared with controls. Elevated serum Islet cells Ab and anti-ovarian Ab levels can be associated with high AMH and insulin resistance.

**Keywords:** *Islet cells, anti-ovarian Ab, anti-mullerian hormone, body mass index, polycystic ovary syndrome.*

**Keywords:** *Anti-Islet, Antibody, Anti-ovarian, Iraqi women.*

## Introduction

Islet cell autoantibodies are produced when beta cells of pancreas are damaged and they can bind to glutamic acid decarboxylase (GAD), protein tyrosine phosphatase, islet antigen-2 (IA-2), insulin, and zinc transporter (ZNT8) and lead to further destruction of islet cells of pancreas. The destruction of beta cells of pancreas causes hyperglycemia, which can be treated by insulin therapy to control hyperglycemia, but it leads to increase in weight gain as well as ovarian hyperandrogenism<sup>(1,2)</sup>.

Islet cell autoantibodies react with islet cell antigens in particular sequence reacting with insulin or GAD first, followed by IA-2 and ZNT8. The sequence of autoimmunity to different islet cell proteins indicates

that destruction of insulin producing cells is progressing in a particular sequence. These autoantibodies can be used to estimate an individual's risk of developing type I diabetes. Anti-islet cell antibodies reported in 83% of PCOS patients<sup>(1)</sup>. The first sign of a possible autoimmune endocrine condition is typically the regulatory hormone or an androgen secretory product. A large proportion of prematurity is associated with ovarian autoimmunity. Like normal menopause, premature menopause is associated with elevated FSH and decreased estrogen and inhibin B development<sup>(3)</sup>.

The study aimed to study and evaluate the serum islet cell anti-bodies concentrations and anti-ovarian anti-bodies in the relationship between the PCOS patient and the stable control group



## Materials and Method

The study was conducted from February 2019 to January 2020. A total of 250 women with and without polycystic ovarian syndrome (PCOS) who were collected from the high Institute of infertility diagnosis Assisted reproductive technology (ART)/Al-Nahrain University. The history and all data were taken for each PCOS patients. The study was approved by the Institutional Review Board (IRB) of Baghdad University. Control: The control group was collected from healthy normal women.

**Samples Collection:** The first step was the collection of information from the patients, and then the second step was blood samples collection. Blood samples were collected from all the patients and controls, two milliliters of venous blood were collected in sterile screw cap plastic gel tubes.

**Serum Separation:** Serum was obtained from the blood samples were left for 30 minutes at room temperature, then centrifuge at 3000 rpm. For ten minute, then serum for each sample was collected in appendrof tubes and stored in deep freeze at  $-20^{\circ}\text{C}$  until the time for using in ELISA technique for detection of islet cells Ab level and anti-ovarian Ab. The ELISA were collected according to DRG-United state of America manufacturing.

## Results

The level of serum islet cell antibodies (ICA) showed significant differences in PCOS patients in comparison with healthy control. The level was  $1.92\text{E}2 \pm 147.96$  (Pg/ml),  $84.04 \pm 99.63$  (Pg/ml) in PCOS and healthy control respectively. The serum level was ranging between 0 and 520 Pg/ml, table 1.

**Table 1: Islet cell antibodies (ICA) level in PCOS patients and healthy control groups.**

Serum ICA (Pg/ml)	Number	Mean	Std. Deviation	P-value
Patients	125	1.92E2	147.96	<0.0001
Controls	125	84.04	99.63	

\*E2:  $\times 100$

The level of serum anti-ovarian Ab (AOAB) showed significant differences in PCOS patients in comparison with healthy control. The level was  $2.12\text{E}2 \pm 130.44$

(Pg/ml),  $92.37 \pm 112.81$  (Pg/ml) in PCOS patients and healthy control group respectively. The serum level was ranging between 0 and 520 Pg/ml, table 2.

**Table 2: Anti-ovarian Ab (AOAB) level in PCOS patients and healthy control groups**

Serum AOAB (Pg/ml)	Number	Mean	Std. Deviation	P-value
Patients	125	2.12E2	130.44	<0.0001
Controls	125	92.37	112.81	

\*E:  $\times 100$

## Discussion

This study showed high level of serum ICA in PCOS patients when compared with healthy control group. Islet cell auto-antibodies are produced when beta cells of pancreas are damaged<sup>(4)</sup>. The destruction of beta cells of pancreas causes hyperglycemia, which can be treated by insulin therapy to control hyperglycemia, but it leads to increase in weight gain as well as ovarian hyperandrogenism<sup>(5)</sup>.

Auto-antibodies of islet cells respond with islet cell antigens in a complex sequence that first interacts with insulin or GAD. This pattern of autoimmunity to various proteins of islet cells suggests that in a specific series, degradation of insulin-producing cells is progressing. These auto-antibodies can be used to estimate the risk of an person developing type I diabetes<sup>(6)</sup>.

Anti-ovarian antibodies (AOAB) have been detected in highly level in serum samples of women

undergoing of PCOS than healthy control women. Many past studies have shown that the presence of serum AOAB does not correlate with the clinical manifestation of PCOS. Despite these antibodies being present, their pathogenic role is highly questionable<sup>(7, 8)</sup>. AOAB may occur several years before the occurrence of clinical symptoms, as detected in 33-61% of women with unexplained infertility; a situation that may indicate early stages of autoimmune ovarian insufficiency<sup>(9)</sup>. For most autoimmune diseases, screening for specific antibodies is probably the best way of evaluating immunological involvement<sup>(10)</sup>. According to results of current research the syndrome could be possibly associated with some autoimmune diseases.

Gonadotropins can stimulate IL-1 $\beta$  and then it inhibits both LH and Human chorionic gonadotropin (LH/hCG) and FSH-stimulated progesterone and estradiol secretion by the follicular theca and granulosa cells, affecting cAMP production that suggests a follicle-stage dependent regulatory role of IL-1 on ovarian follicles<sup>(11)</sup>. A previous study demonstrated that the human granulosa-luteal cells express IL-1 $\beta$  transcript, and LH can stimulate this transcription in a dose-dependent manner, on the contrary, IL-1 $\beta$  significantly decreased LH-dependent estradiol production in these cells. Previous past results suggest that LH may exert its action on the steroidogenesis of granulosa cell, at least in part, the activation of the IL-1 $\beta$  gene<sup>(12)</sup>. In the brain, interleukin-1 $\beta$  can reduce the release of monoamines: serotonin (5-HT), dopamine and noradrenaline. The role of IL-1 $\beta$  in the monoamine metabolism in the basal ganglia can help for plasticity of anxiety and depression in the brain<sup>(13)</sup>.

**Acknowledgment:** The author would like to introduce his thanks and gratefulness to College of Medicine, University of Baghdad, Iraq for their helps and support to achieve this article.

**Conflicts of Interest:** The author declares that there are no conflicts of interest.

**Funding:** There is no source of any funding

**Ethic Statement:** The researchers already have ethical clearance from all required institution and laboratories.

## References

- Pickup JC. Insulin-pump therapy for type 1 diabetes mellitus. *New England Journal of Medicine*. 2012; 366(17): 1616-1624. doi: 10.1056/NEJMct1113948.
- Stipančić G, Šepec MP, Sabolić LLG. Effect of Growth Hormone Therapy in Children with Pader-Willi Syndrome-Our First Experiences. *Acta Clinica Croatica*. 2018; 57(4): 744-755. doi: 10.20471/acc.2018.57.04.17
- Luborsky J. (2000) 'Ovarian antibodies, FSH and inhibin B: independent markers associated with unexplained infertility', *Human Reproduction*. 2000; 15(5): 1046-1051. doi: 10.1093/humrep/15.5.1046.
- Lebovitz HE. Adjunct therapy for type 1 diabetes mellitus', *Nature Reviews Endocrinology*. 2010; 6: 326-334. doi: 10.1038/nrendo.2010.49.
- McCrimmon RJ, Henry RR. SGLT inhibitor adjunct therapy in type 1 diabetes', *Diabetologia*. 2018; 61: 2126-2133. doi: 10.1007/s00125-018-4671-6.
- Mobeen H, Afzal N, Kashif M. Polycystic Ovary Syndrome May Be an Autoimmune Disorder. *Scientifica*. 2016; Article ID: 4071735. doi: 10.1155/2016/4071735.
- Gleicher N., Weghofer A, Barad D. Female infertility due to abnormal autoimmunity: Frequently overlooked and greatly underappreciated. Part I', *Expert Review of Obstetrics and Gynecology*. 2014; 2(4): 453-464. doi: 10.1586/17474108.2.4.453.
- May-Panloup P, Boucret L, de la Barca JM-C, Desquret-Dumas V. Ovarian ageing: The role of mitochondria in oocytes and follicles. *Human Reproduction Update*. 2016; 22(6): 725-743. doi: 10.1093/humupd/dmw028.
- Zhou Z, Ni C, Wu L, Chen B, Xu Y, Zhang Z, et al. Novel mutations in ZP1, ZP2, and ZP3 cause female infertility due to abnormal zona pellucida formation. *Human Genetics* 2019; 138: 327-337. doi: 10.1007/s00439-019-01990-1.
- Zhu R, Lee BH, Huang Z, Indran IR, Li J, Shen L, et al. Antimüllerian hormone, antral follicle count and ovarian volume predict menstrual cycle length in healthy women. *Clinical Endocrinology*. 2016. 84(6): 870-877. doi: 10.1111/cen.12984.
- González F, Considine RV, Pardue SL, Acton AJ. Cream ingestion promotes the expression of toll-like receptor-2 (TLR-2) and matrix metalloproteinase-2 (MMP-2) in polycystic ovary syndrome', *Fertility and Sterility*. 2014; 102(3, Suppl): e250. doi: 10.1016/j.fertnstert.2014.07.851.

12. Moghaddam SM, Amini A, Morris DL, Pourgholami MH. Significance of vascular endothelial growth factor in growth and peritoneal dissemination of ovarian cancer', *Cancer and Metastasis Reviews*. 2012; 31: 143-162. doi: 10.1007/s10555-011-9337-5.
13. Kishi H, Kitahara Y, Imai F, Nakao K, Suwa H. Expression of the gonadotropin receptors during follicular development. *Reproductive Medicine and Biology*. 2018; 17: 11-19. doi: 10.1002/rmb2.12075.

# The Effect of Serum Estradiol Level at the Time of HCG Injection on the ICSE Outcome

Zainab Abd Alkathem Fatnan<sup>1</sup>, Zainab Alkhafajy<sup>2</sup>, Aseel Abdulameer Mohammed<sup>3</sup>

*<sup>1</sup>Specialist OBG at Al Zahraa Teaching Hospital, Teacher at Kufa, Medical School, <sup>2</sup>Consultant OBG at Al Zahraa Teaching Hospital, Assistant Professor at Kufa Medical School, <sup>3</sup>Specialist OBG at Al Zahraa Teaching Hospital, Teacher at Kufa Medical School*

## Abstract

**Background:** In addition to multi-follicular development, controlled stimulation of ovaries is associated with a high serum level of estradiol (E<sub>2</sub>). The increased serum E<sub>2</sub> level during COS may therefore be associated either with an increased chance of pregnancy or an impaired reproductive outcome secondary to changed endometrial receptivity.

**Objective:** To assess the effect of serum estradiol level at the day of hCG administration on the success of intracytoplasmic sperm injection (ICSI) cycles

**Patients and Method:** A retrospective study, in which a total of 235 women who were undergo a single ICSI cycle were introduced in this retrospective study, All patients were received gonadotrophin agonist either short or long protocol. The patients were classified at the day of hCG administration into three groups according to serum E<sub>2</sub> level group A <1000pg/ml, group B 1000-3000pg/ml and group C >3000pg/ml.

**Results:** The mean number of retrieved oocytes and embryos obtained in group C were more than in group A and B but clinical pregnancy rate was higher in group B than in group A and group C which is statistically significant.

**Conclusion:** Although there is no high quality evidence to support a positive correlation between serum E<sub>2</sub> levels and IVF-ICSI products, the E<sub>2</sub> level in the serum may has a level –dependent effect on the success of pregnancy. The optimal range of serum E<sub>2</sub> is 1000-3000pg/ml is associated with higher rate of clinical pregnancy.

**Keyword:** IVF-ICSI, Ovarian hyperstimulation syndrome, E<sub>2</sub>.

## Introduction

In contemporary IVF procedure, there is a positive correlation between retrieved oocytes and rate of live birth. Therefore, the live birth rate which based on obtaining enough mature follicles which contains critically well oocytes, may reflect the success rate<sup>(1,2)</sup>.

There are many method can be used to obtain a large numbers of follicles. In the past decade, many centers

use the ovulation induction regimens, mainly those using gonadotropins and GnRH analogues. COH lead to achieve multiple oocytes, that result in supraphysiologic E<sub>2</sub> levels and this has a direct effect on endometrial implantation. Increased E<sub>2</sub> concentration on the day of hCG injection have a positive effects on IVF-ICSI results or a low outcome, caused by endometrial receptivity disruption<sup>(3-6)</sup>.

Many studies have reported that supraphysiological E<sub>2</sub> concentrations may affect the chance of pregnancy. On the other hand, an other studies suggest that high serum E<sub>2</sub> level have no effect on endometrial receptivity<sup>(5,7,8)</sup>. In the bases of these results, the effectiveness of high

---

### Corresponding Author:

**Dr. Zainab Abd Alkathem Fatnan**

e-mail: zainaba.alshebly@uokufa.ed.iq

Phone Number :+9647800789894

E<sub>2</sub> levels on the day of hCG administration have controversial association, which in turn affect IVF-ICSI outcome. So we need to assess the association between E<sub>2</sub> levels on the day of hCG administration and IVF-ICSI outcome, in which GnRH analogues were used for down regulation

**The aim of the study:** This retrospective study was performed to assess the effect of serum estradiol level at the day of hCG administration on ICSI patients who were undergone controlled ovarian stimulation (COS).

### Patients and Method

This study was performed in the fertility center of Al-Sader teaching hospital in Al-Najaf city.

From February 2018 to February 2019, (235) couples underwent ICSI cycles because of tubal, ovarian, male and unexplained infertility. Exclusion criteria for the study included the presence of known intrauterine anomalies and ovarian stimulation other than GnRH agonist protocol (short & long).

In cycle day 2-3 hormonal assay in form of (FSH, LH, Prolactin, and E<sub>2</sub>) done along with vaginal ultrasound was carried to identify the antral follicle amount and to eliminate the existence of ovarian cysts or other pelvic pathology and seminal fluid analysis for the partner reviewed then according to above results, stimulation protocol was selected. Patients were screened and were negative for infection with HIV, hepatitis B and C.

**Stimulation Protocol:** Gonadotropin releasing hormone (GnRH) agonist used for all women. In the current study we used two main protocols;

- 1. Long Protocol:** GnRh agonist (3.7 mg) was administered to suppress the pituitary gland on day 21 of the menstrual cycle (middle luteal phase). Vaginal ultrasound performed on day 2 or 3 of the next menstrual cycle to confirm the absence of any functional ovarian cyst larger than 10 mm. Gonadotropin stimulation consisted of 1-2 ampoules per day of recombinant FSH (Gonal-F<sup>R</sup>, 75 IU). The initial dose was individualized according to the patient's age, the reserve ovarian test was adjusted according to its response after the first 4-5 days of stimulation.
- 2. Short Protocol or Flare-up protocol:** Involves agonist treatment (decapetyl 0.1mg S.C daily) for 10-14 days started one day before or concurrently

with ovarian gonadotropines stimulation and the dose of gonadotropines adjusted as the long protocol (as described above).

For both protocols, follicular development was examined by vaginal ultrasonography and serum E<sub>2</sub> level starting from cycle day 8 or 9 and then every other day. At the day of human chorionic gonadotrophine (hCG) administration, serum levels of E<sub>2</sub> were measured.

Serum concentration of estradiol (E<sub>2</sub>) was measured by (VIDAS measurement – ELFA technique (Enzyme Linked Fluorescent Assay) bio Merieux sa/France).

Serum E<sub>2</sub> level at the day of hCG administration were classified into three groups:-

- A. (<1000pg/ml),
- B. (1000-3000pg/ml),
- C. (>3000pg/ml).

thirty- four to 36 hours following 10,000 IU of hCG administration, oocyte retrieval was performed under general anesthesia and by guided of transvaginal ultrasound. After aspiration, oocytes were screened and injected (ICSI). The fertilization rate calculated as (number of embryos obtained per number of injected oocytes). After embryo transfer, all patients were given luteal phase support using progesterone vaginal pessaries 400mg twice a day (Cyclogest<sup>R</sup>) Started at day of ovum pick up for 16 days and was continued if pregnancy occurred up to 10-12 weeks. After 2 weeks the serum level of βhCG was checked after embryo transfer, and clinical pregnancy was confirmed two weeks later by sonographic

Detection of the gestational sac and positive heart beat. Clinical pregnancy rate calculated as the number of women with clinical pregnancy per number of women that did embryo transfer.

Embryos were classified according to the number of blastomeres, percentage of fragmentation & blastomere appearance as type 1, 2, 3 or 4.

Regarding the equality of embryos, good quality embryos are those of grade 1 and 2, while bad quality embryos are those of grade 3 and 4.

**Statistical Analysis:** This study was analyzed statistically by using SPSS (statistical package for social science) version 20. In which we use chi square (x<sup>2</sup>)

For categorical data and independent sample T-test for measurement data. We set P value <0.005 as significant.

### Results

Table (1) shows demographic characteristic of the women according to E2 level in three groups were no significant difference in their age, BMI, endometrial thickness and hormonal assay (FSH,LH, E2 and Prolactin) hormone.

**Table(1): Demographic characteristics according to E2 at HCG level in the studied group.**

Characteristic	E2 at HCG			P value
	<1000 Mean±SD	1000-3000 Mean±SD	>3000 Mean±SD	
Age/years	30.45±6.4	30.5±5.7	28.6±5.6	0.104
BMI(kg/m <sup>2</sup> )	27.7±3.1	27.3±3	27.1±3.4	0.576
FSH(IU/L)	4.2±2.3	4.1±2.7	4.2±1.7	0.716
LH(IU/L)	2±1.4	2.7±1.8	2.3±4	0.319
E2(pg/ml)	27.8±14.3	35.6±16.4	45.6±22.5	<0.001
Prolactin(ng/ml)	23.5±8.6	26.7±23.7	24.3±8.2	0.514

Table (2) shows the mean number of retrieved oocytes (p=0.001), no. metaphase II oocytes (p=0.001) and number of embryos obtained (p=0.001) were significantly higher in group C than in groups A & B.

Percentage of metaphase were not statistically different among three groups (p=0.284).

Fertilization rate (number of embryos obtained per number of injected oocytes) was higher in group A (0.6067± 0.2469) than in group B (0.5170±0.2615) and group C(0.4330±0.2865) but it was not statistically significant (p=0.088).

**Table (2): Demonstrates the comparison of the outcome according to E2 at HCG level.**

Characteristic	E2 at HCG			P value
	<1000 Mean±SD	1000-3000 Mean±SD	>3000 Mean±SD	
No. of oocyte	6.1±3.6	9.4±4.8	13.1±6.2	<0.001
No. of M2	2.9±2	4.4±2.1	5.8±2.6	<0.001
No. of embryo	2±0.9	2.5±0.7	2.7±0.5	<0.001
Percentage of M2	52.7±23.4	50.1±17	47.3±14.1	0.284
Fertilization rate	0.606±0.246	0.517±0.261	0.433±0.286	0.088

Table (3) shows the types of protocols and type of infertility were not significantly different among the studied group. There is significant difference between

<1000 and 1000-3000 and <1000 and >3000 while there is no significant difference between 1000-3000 and >3000

**Table (3) The type of protocol and indication of ICSI according to level of E2 at HCG**

Variable		E2HCGG			P value
		<1000	1000-3000	>3000	
Protocol	Long	924.3%	2156.8%	718.9%	0.385
	Short	3517.7%	10653.5%	5728.8%	
Indication	Female	1719.3%	4955.7%	2225.0%	0.980
	Male	2418.3%	7053.4%	3728.2%	
	Unexplained	318.8%	850.0%	531.2%	

Table (4) shows clinical pregnancy rate (calculated per embryo transferred) was higher in group B 49/127(37.8%) than in groups A 5/44(9.1%) and C 20/64 (29.7%). It was statistically significant (p=0.002).

**Table (4): Relation between E2 HCG level and clinical pregnancy rate.**

		Fertilization		P value
		Negative	Positive	
E2HCGG	<1000	39	5	0.002
		90.9%	9.1%	
	1000-3000	78	49	
		62.2%	37.8%	
	>3000	44	20	
		70.3%	29.7%	
<b>Total</b>		<b>161</b>	<b>74</b>	
		<b>69.8%</b>	<b>30.2%</b>	

Table (5) regarding the quality of embryos, good quality embryos were more frequent in group B (113) than group C (57) and group A (38) this difference was not statistically significant.

**Table (5): shows the comparison of the quality of embryos among three groups.**

		Grading		P value
		Good quality	Bad quality	
E2HCGG	<1000	38	6	0.833
		86.4%	13.6%	
	1000-3000	113	13	
		89.7%	10.3%	
	>3000	57	7	
		89.1%	10.9%	

**Discussion**

IVF-ICSI is tried in the world very widely and controlled stimulation of the ovaries is very beneficial to achieve these outcomes. COH may improve the success of fertilization and lead to large number of embryos that can be transferred to mother to be happy with a nice and acceptable success rates (9,10).

In the present study the number of retrieved oocytes and number of mature follicles (M II) is higher in group C (E2>3000pg/ml) than group A (E2<1000pg/ml) and B (E21000-3000pg/ml), this mainly depends on appropriate follicular development in patients with high E2 level. (11)

The embryos, number that obtained was higher in B and C than in group A which is statistically significant, this result agree with Jones et al.,1983; and Dor et al., 1986.<sup>(12, 13)</sup>

Regarding the rate of fertilization there is no statistical significant difference were found in between group A, B and C although it is decrease with higher peak E2 level this also shown by previous study <sup>(6,13)</sup>. This result disagree with Chenentte et al., study in 1990 who found that the fertilization rate to be unrelated to the serum E2 concentration or the number of oocytes retrieved.<sup>(14)</sup>

Regarding pregnancy rate this study demonstrate that the pregnancy rate increase as serum E2 level increase up to 3000pg/ml and start to decrease when concentration rise >3000pg/ml, this outcomes are also obtained by Blazar et al., 2004<sup>(15)</sup> who conducted that the rate of pregnancy is become higher with increment in the peak of serum E2 and continue until plateau level is reached at nearly 2500pg/ml. this also showed by Mitwally et al., 2006.<sup>(16)</sup>

The is a study performed by Simon et al., 1995 and is found that there is impairment of implantation occur with a high serum estradiol concentration in spite of the presence of large number of oocytes.<sup>(17)</sup> This may caused by direct negative effect of increased estradiol concentration on endometrial receptivity by tissue and cellular damage because of alteration in the ratio of estrogen to progesterone as shown in recent study were serum E2level significantly correlated with the number of oocytes obtained (p=0.001).

There is evidence that optimizing serum E2 level on hCG administration may improve the treatment outcome after ICSI but that low or high E2level have negative impact. So, a good estrogenization of the uterus is important for preparing the uterus to implant the embryo.

It also caught our attention that, in case with decreased E2 level on the day of hCG administration (<1000pg/ml) had pregnancy rate significantly lower than in group B and C respectively, this agree with study made by Ng et al.<sup>(12)</sup>, this attributed to lower number of retrieval oocytes, number of metaphase II and ultimately embryos transferred as shown in table (2) is a possible cause for lower pregnancy rate.

The effects of E2 level on endometrial receptivity should be further evaluated in future studies.

## Conclusion

We can conclude that the success of ICSI cycle is affected by serum E2 level. However, the extreme of serum E2 level associated with poor ICSI outcome.

**Recommendation:** Since the concentration of estradiol are at the ends of extreme level can affect pregnancy outcome, so we advocate the possibility of canceling such cycle and frozen embryo for transfer in subsequent fresh cycle. Nevertheless, larger randomized studies were recommended with large sample size and for longer duration of follow up to define appropriate protocols in clinical practice of ICSI cycle.

**Conflicts of Interest:** No

**Source of Funding:** Self

**Ethical Clearance:** From the Ministry of health and Environment/scientific committee.

## References

1. De Cherney AH, Lauren N. Sarcoma of the uterus In: Current obstetric and gynaecologic diagnosis and treatment 9th edition. Appleton and Lange. 2003:946-51.
2. Steptoe PC, Edwards RG, Purdy JM. Clinical aspect of pregnancies established with cleaving embryos grown in-vitro. Br J Obstet Gyneacol 1980;87:757-68.
3. Templeton AA, Morris JK, Parslow W. Factors that affect the outcome of in-vitro fertilization treatment. Lancet 1996;348:1402-6.
4. Van Steirteghem A, Liebaers I, Devroey P. Assisted reproduction . In: Hillier SG, Kitchener HC, Neilson JP, eds. Scientific Essentials of Reproductive Medicine. London: WB Saunders, 1996: 230–41.
5. Fishel S, Aslam I, Lisi F, Rinaldi L, Timson J, Jacobson M, et al. Should ICSI be the treatment of choice for all cases of in-vitro conception?. Human Reproduction. 2000 Jun 1;15(6):1278-83.
- 6- Denker HW. Implantation: a cell biological paradox. Journal of Experimental Zoology. 1993 Sep 1;266(6):541-58.



7. Wilcox AJ, Baird DD, Weinberg CR. Time of implantation of the Concept and loss of pregnancy. *N Engl J Med.* 1999; 340:1796-9.
8. Navot D, BERGH PA, WILLIAMS M, GARRLSI GJ, GUZMAN I, SANDLER B, et al. An insight into early reproductive processes through the in vivo model of ovum donation. *The Journal of Clinical Endocrinology & Metabolism.* 1991 Feb 1;72(2):408-14.
9. Braunstein G, Gordin J, Vaitukaitis J, Ross G. Secretary rates of human chorionic gonaditrophin by normal trophoblast. *Am J Obstet Gynecol* 1973;115:447-50.
10. Rosen MP, Zamah AM, Shen S, Dobson AT, McCulloch CE, Rinaudo PF, et al. The effect of follicular fluid hormones on oocyte recovery after ovarian stimulation: FSH level predicts oocyte recovery. *Reproductive Biology and Endocrinology.* 2009 Dec 1;7(1):35.
11. Thomas K, Thomson AJ, Sephton V, Cowan C, Wood S, Vince G, Kingsland CR, Lewis-Jones DI. The effect of gonadotrophic stimulation on integrin expression in the endometrium. *Human Reproduction.* 2002 Jan 1; 17(1):63-8.
12. Jones Jr HW, Acosta A, Andrews MC, Garcia JE, Jones GS, Mantzavinos T, et al. The importance of the follicular phase to success and failure in in vitro fertilization. *Fertility and Sterility.* 1983 Sep 1;40(3):317-21
13. Dor J, Rudak E, Mashiach S, Nebel L, Serr DM, Goldman B. Peri-ovulatory 17 $\beta$ -estradiol changes and embryo morphologic features in conception and non-conceptional cycles after human in vitro fertilization. *Fertility and sterility.* 1986 Jan 1;45(1):63-8.
14. Chenette PE, Sauer MV, Paulson RJ. Very high serum estradiol levels are not detrimental to clinical outcome of in vitro fertilization. *Fertility and Sterility.* 1990 Nov 1;54(5):858-63.
15. Blazar AS. Serum estradiol positively predicts outcomes in patients undergoing in vitro fertilization. *Fertil Steril.* 2004;81:1707–1709
16. Mitwally MF, Bhakoo HS, Crickard K, Sullivan MW, Batt RE, Yeh J. Estradiol production during controlled ovarian hyperstimulation correlates with treatment outcome in women undergoing in vitro fertilization–embryo transfer. *Fertility and sterility.* 2006 Sep 1;86(3):588-96.
17. Simon C, Cano F, Valbuena D, Remohi J, Pellicer A. Clinical evidence for a detrimental effect on uterine receptivity of high serum oestradiol concentrations in high and normal responder patients. *Human Reproduction.* 1995 Sep 1;10(9):2432-7.
18. Yu Ng EH, Yeung WS, Yee Lan Lau E, So WW, Ho PC. High serum oestradiol concentrations in fresh IVF cycles do not impair implantation and pregnancy rates in subsequent frozen–thawed embryo transfer cycles. *Human Reproduction.* 2000 Feb 1;15(2):250-5.

# The Satisfaction of Patient with Respect to the Aesthetic and Phonetic of Removable Partial Denture Therapy for Iraqi Patient

Zainab Mahmood Al-Jammali<sup>1</sup>, Anas Al-Yasiry<sup>2</sup>, Zahra S. Abed Karkosh<sup>3</sup>, Azad Almuthaffer<sup>1</sup>

<sup>1</sup>MD Lecturer Prosthodontics/College of Dentistry, University of Babylon/Iraq, <sup>2</sup>MD Lecturer Department of Basic Science College of Dentistry, University of Babylon, Iraq, <sup>3</sup>MD Assistant Lecturer Prosthodontics/College of Dentistry, University of Babylon/Iraq.

## Abstract

**Background:** The purpose of the dental treatment is getting the satisfaction of patient, in addition to reestablish and improve oral health and functions. Negative effect on aesthetic and speech can produced from losing of teeth, so; substituting of losing teeth with suitable prostheses was mandatory for maintenance of oral health.

**Method:** The patients participated in this study were (160) with aRPD, sixty males and one hundred females, age range (30-60) years. After construction of the prosthesis, then ask the patients questions about aesthetic and phonetic after placement of RPD, and the satisfaction of patient was evaluated.

**Conclusion:** From the point of phonetic and esthetic of the denture, largest percentage of the female were very satisfy compared with the male. Non-significant differences between the age groups in respect of esthetic, while about the phonetic, the largest percentage of the younger patient was very satisfy compared with the older patient. The employed patient have largest percentage of satisfaction to the esthetic of the denture, while the non-employed patient have largest percentage of satisfaction to the phonetic of the denture .

**Keywords:** *Satisfaction of patient, esthetic, phonetic, removable partial denture, therapy, employment.*

## Introduction

What is the purpose from the dental treatment? The purpose of the dental treatment is getting the satisfaction of patient, in addition to reestablish and improve oral health and functions.<sup>1</sup> Negative effect on aesthetic and speech can produced from losing of teeth, so; substituting of losing teeth with suitable prostheses was mandatory for maintenance of oral health.<sup>2</sup> Loss of teeth, which may be due to trauma, dental diseases, pathology, or otherwise not only alters the psychological

thought of the patients but also disturbs the esthetics, phonetics, and functional occlusion<sup>3</sup>, Knezović *et al* (2001,2003,2008) was found that the satisfaction of patient affected by various factors such as: losing teeth numbers, aesthetics, retention, phonetic and oral hygiene habits.<sup>4-6</sup> The satisfaction of patient was correlated to aesthetic and phonetic of dentures in some patient, while mastication is more important in the other patients.<sup>7-10</sup> Phonetic and aesthetics value are extremely important factors which affect the satisfaction of patient level with their RPD, in certain patients, comfort and the ability to masticate were primarily related to the satisfaction of patients, while in the other retention and aesthetics are more important.<sup>11</sup> Also the satisfaction of removable prosthesis can be effected by mental attitude, patients personality, past partial denture experience.<sup>12-14</sup> Whereas the dissatisfaction of removable prosthesis can be effected by deposit of plaque, teeth caries, denture stomatitis and periodontal infection of teeth.<sup>15-18</sup> Furthermore, facial

---

### Corresponding Author:

**Zainab Mahmood Al-Jammali**

MD Lecturer Prosthodontics/College of Dentistry,  
University of Babylon/Iraq

e-mail: dent.zainab.mahmood@uobabylon.edu.iq

appearance and personal communication for many people with others can be affected by aesthetic problem of the RPD.<sup>19,20</sup> The RPD has many advantages such as it was reversible treatment, the oral hygiene can be maintained easily, inexpensive, and it is consider non-invasive treatment line, on the other hand; several speech and aesthetic issues problems was associated with it.<sup>21,22</sup> So, the aim of this paperis to examine the relation between the level of satisfaction of RPD associated to phonetic and aesthetic of patients who looking for treatment at the Prosthodontics Department in the Collage of Dentistry in University of Babylon in Iraq and attempt to find its correlations with employment and because there are no available studies (to our knowledge) that have investigated the satisfaction of patient among subjects in Babylon region, this would be of valuable information to oral health planners for proposing strategies helping in the development of dental health care management in Iraq, as well as with gender and age.

## Materials and Method

**Study Sample:** The sample included the patients who seeking for construct a new definite RPD treatment at the Prosthodontics Department in the Collage of Dentistry in University of Babylon in Iraq. Inclusion criteria the patients who have good oral and general health, without temporomandibular dysfunction syndrome, and physically handicapped patients should excluded and those who were incapable to take their own decisions about asked question that is related to the denture. After explaining the procedure steps and the aim of the study to all participant patients and allowing them to make their decision about participation and answer all the questions, we obtain the written consent with signature from them, the general information were taken from patient about name, age and gender. After construction of the prosthesis, we ask the patients questions about aesthetic and phonetic, and the satisfaction of patient was evaluated by using scale range from 1 to 5, (scale 1 mean unsatisfied, 2 satisfy, 3 good, 4 very good, 5 excellent).

**Sample Size:** The sample size at about (160) patients with a RPD, sixty male and one hunderd female, age range (30-60) years. The study period (October 2017 to March 2018). Subjects who took part in this study were divided into two age groups. The first age group include the patients who younger than 40 years, the second age group include the patients who are aged from 41 to 60 years.

**Statistical Analysis:** The data of this study is collected and analyze by Statistical Package for Social Science: Software, v. 21.0 (IBM Corp., Armonk, USA) Analysis of Interval Pearson's R Ordinal by Ordinal Spearman Correlation N of valid Cases, esthetic and phonetic for both sex and compared between them with the criterion level for statistical significance was set at ( $p < 0.05$ ).

## Result

About the esthetic, table (1) showsthe relation between gender and esthetic, the largest percentage of the female were very satisfy (55%) with the esthetic of her denture compared with the male patients who have (16.7%), and the differences between the gender was significant ( $p < 0.05$ ). Among age groups, the largest percentage was for the first group (younger than 40 years) about (54.5%) was very satisfy compared with the second group (older than 40 years) about (33.3%) and the least percentage was recorded3 for the second group about (4.8%) was unsatisfied (tab2), also the differences between the age groups was non-significant ( $p > 0.05$ ).

The correlation between employment and esthetic, in table (3) it obvious that the largest percentage recorded in the employed patient (52.6% and 47.4%) were satisfied and very satisfied respectively compared with the non-employed patient who have (15.4% and 30.8%) were satisfied and very satisfied respectively.

About the phonetic, table (4) shows the relation between gender and phonetic, we see that the largest percentage recorded for the female patient (75%) was very satisfied compared with the male patients who have (41.7%) were very satisfied, there is no unaccepted patient about phonetic, and the differences between the gender was significant ( $p < 0.05$ ). Among age groups, the largest percentage was for the first group (younger than 40 years) about (81.8%) was very satisfy compared with the second group (older than 40 years) about (52.4%) (tab5).

Table(6) shows the relation between employment and phonetic, it obvious that the largest percentage recorded in the non-employed patient (69.2%) were very satisfied compared with the employed patient who have (57.9%).

**Table 1. The relation between gender and esthetic**

Gender	Severely dissatisfied (%)	Dissatisfied (%)	Neutral (%)	Satisfied (%)	Severely satisfied (%)
Male(60)	0	8.3	25	50	16.7
Female(100)	0	5	10	30	55
Mean= 4.13, SE =0.97, P-Value Less than0.05					

**Table 2. Relation between age and esthetic**

Ages	Severely dissatisfied(%)	Dissatisfied (%)	Neutral (%)	Satisfied (%)	Severely satisfied (%)
Less than40(66)	0	9.1	18.2	18.2	54.5
More than40(94)	0	4.8	14.3	47.6	33.3
Note: Mean= 4.53, SE =0.671, P-Value more than0.05					

**Table 3. Relation between employment and esthetic**

Employment	Severely dissatisfied(%)	Dissatisfied (%)	Neutral (%)	Satisfied (%)	Severely satisfied (%)
Employee	0	0	0	52.6	47.4
Non-employee	0	15.4	38.5	15.4	30.8
Note: p-value Less than0.05					

**Table 4. Relation between gender and phonetic:**

Gender	Severely dissatisfied(%)	Dissatisfied (%)	Neutral (%)	Satisfied (%)	Severely satisfied (%)
Male(60)	0	0	25	33.3	41.7
Female(100)	0	0	0	25	75
Note: p-value less than0.05					

**Table 5. Relation between age and phonetic**

Ages	Severely dissatisfied(%)	Dissatisfied (%)	Neutral (%)	Satisfied (%)	Severely satisfied (%)
Less than 40(66)	0	0	0	18.2	81.8
More than 40(94)	0	0	14.3	33.3	52.4
Note: P-value more than 0.05					

**Table 6. Relation between employment and phonetic**

Employment	Severely dissatisfied(%)	Dissatisfied (%)	Neutral (%)	Satisfied(%)	Severely satisfied(%)
Employee (71)	0	0	5.3	36.8	57.9
Non-employee(89)	0	0	15.4	15.4	69.2
Note: p-value more than0.05					

## Discussion

The patients should be mentally and physically get ready to accept a treatment with RPDs (RPD) because the rehabilitation of patients with denture was considered a continuous procedure and requires awareness to the specific requirements of the patients.<sup>23,24</sup>

In this study the largest percentage of the female in Iraq were very satisfy with the respect of phonetic and esthetic of their denture compared with the male patients and the differences between the gender was significant ( $p < 0.05$ ), and this may be due to the number of female in this study was larger than male, and this was agree with Baran *et al.*<sup>25</sup> and Zlataric *et al.*<sup>26</sup> who reported that the satisfaction of patient with RPDs among females was more than males. On the other hand, Singh *et al.*<sup>27</sup> evaluated RPDs wearers in India and established that male were more satisfied than females with regard to chewing, esthetics, and phonetic, also Kruskal-Wallis test exposed that the difference between sex was not significant ( $p > 0.05$ ), also Zlataric *et al.*<sup>[28]</sup> established that generally, the difference between gender was not significant ( $p > 0.05$ ) with regard to the patient satisfaction level with their RPD, aesthetics, phonetic, etc.

Among age groups, the largest percentage was for the first group (younger than 40 years) was very satisfy, and the differences between the age groups was non-significant ( $p > 0.05$ ) and this may be due to a common supposition that old age patients need longer time to adapt to RPD and so the satisfaction of patient will be affected, and this was agree with de Siqueira *et al.*<sup>29</sup> and Zlataric *et al.*<sup>30</sup> who established that the differences between the age groups was non-significant ( $p > 0.05$ ), while Frank *et al.*<sup>12</sup> established that young patients are less satisfied with their RPD, and Singh *et al.* established that there was a positive relationship between the satisfaction of patient from their RPDs and the age<sup>27</sup>, in addition, the study of Wakabayashi *et al.*<sup>31</sup> exposed that the satisfaction of patient with RPDs was influenced by the age, because younger patients were more dissatisfied with the denture aesthetics.

The relation between employment and esthetic, the largest percentage recorded in the employed patient were satisfied and very satisfied compared with the non-employed patients, the explanation may be due to the fact that most of employee patient was educated and so can judge and give their opinion about esthetic of the CD, and there is no study correlate the satisfaction rate with employment to compare with it.

The relation between the phonetic and age, the largest percentage of the younger patient was very satisfy with phonetic compared with the older patient and this may be related to the fact that older patients need longer to adapt to dentures. This result was agree with Knezovic-Zlataric<sup>32</sup> who found that the patients below 60 years are more satisfied with their RPD generally, and disagree with Akeel<sup>33</sup> who noted that there was no significant relation between the satisfaction of patient with RPDs and age, Weinstein *et al.*<sup>34</sup> who believe that the age was not a significant predictor of the RPD success, and also Al-Jammali ZM *et al.*<sup>35</sup> who found that there was no significant relation of age with satisfaction of patient.

The relation between employment and phonetic, the largest percentage of non-employed patient were very satisfied compared with the employed patient, and the explanation to that was that most of employee patient was educated as we say and the educated patient gave high grade to the phonetic specially people who work in the teaching profession, and this result was disagree with a Turkish study<sup>36</sup> and two Brazilian study<sup>37,38</sup> studies which did not discover any differences between educational level groups concerning the satisfaction of patient with RPDs.

## Conclusion

In summary, this paper argued that from the point of phonetic and esthetic of the denture, largest percentage of the female were very satisfy compared with the male. About the age, non-significant differences between the age groups in respect of esthetic, while about the phonetic, the largest percentage of the younger patient was very satisfy compared with the older patient. The employed patient have largest percentage of satisfaction to the esthetic of the denture, while the non-employed patient have largest percentage of satisfaction to the phonetic of the denture.

**Conflict of Interest:** There are "No Conflict of Interest".

**Source of Funding:** Self.

**Ethical Clearance:** The Scientific Committee of the Department of Prosthodontics, Faculty of Dentistry, University of Babylon, Iraq are approved to perform this study.

## References

- Petricević N, Celebić A, Rener-Sitar K. Improvement of patient's satisfaction and oral health-related quality of life by the implant and prosthodontic treatment. *Oral Health Care. Prosthodontics, Periodontology, Biology, Research and Systemic Conditions*. 2012 Feb 29;25:52.
- K. Tyson, R. Yemm, B. Scott. *Understanding partial denture design* (1st ed.), Oxford University Press, Oxford. 2007; pp. 3-6Section.
- Al-Jammali ZM. Comparison of the maximum bite force in patient with heat cure acrylic and flexible partial dentures (Free end extension). *Asian J. Pharm. Tech*. 2013 Sep 28;3(3):93-7.
- Zlatarić DK, Čelebić A, Valentić-Peruzović M, Jerolimov V, Pandurić J. A survey of treatment outcomes with removable partial dentures. *Journal of oral rehabilitation*. 2003 Aug;30(8):847-54.
- Knezovid-Zlatarid D, et al. Influence of Kennedy classification of partial edentulousness, material and construction on patient satisfaction with partial dentures. *Acta Stomat Croat*. 2001; 69-76.
- Zlataric DK, Celebic A. Factors related to patients' general satisfaction with removable partial dentures: a stepwise multiple regression analysis. *International Journal of Prosthodontics*. 2008 Jan 1;21(1):86.
- KnezovicZlataric D, Celebic A. Treatment outcomes with removable partial dentures: a comparison between patient and prosthodontic assessments. *Int J Prosthodont*. 2001;14:423-6.
- Graham R, Mihaylov S, Jepson N, Allen PF, Bond S. Determining 'need' for a Removable Partial Denture: a qualitative study of factors that influence dentist provision and patient use. *British dental journal*. 2006 Feb;200(3):155-8.
- Strassburger C, Heydecke G, Kerschbaum T. Influence of Prosthetic and Implant Therapy on Satisfaction and Quality of Life: A Systematic Literature Review. Part 1--Characteristics of the Studies. *International Journal of Prosthodontics*. 2004 Jan 1;17(1).
- Özdemir AK, Özdemir HD, Polat NT, Turgut M, Sezer H. The effect of personality type on denture satisfaction. *International Journal of Prosthodontics*. 2006 Jul 1;19(4).
- DubravkaKnezoviE-ZlatariE et al. Patients' Satisfaction with Partial Denture Therap. *Acta Stomatol Croat*, Vol. 34, br. 4, 2000;373-378.
- Frank RP, Brudvik JS, Leroux B, Milgrom P, Hawkins N. Relationship between the standards of removable partial denture construction, clinical acceptability, and patient satisfaction. *The Journal of Prosthetic Dentistry*. 2000 May 1;83(5):521-7.
- Al. Sharafat F. Assessment of the relation between patient attitude and patient satisfaction with complete dentures. *Pak. Oral & Den. J*. 2008; 28(2): 305-08.
- Chen J, Ahmad R, Suenaga H, et al. Shape optimization for additive manufacturing of RPDsA new paradigm for prosthetic CAD/CAM. *PLoS One* 2015; 10(7): e0132552. [<http://dx.doi.org/10.1371/journal.pone.0132552>] [PMID: 26161878]
- Kern M, Wagner B. Periodontal findings in patients 10 years after insertion of removable partial dentures. *Journal of oral rehabilitation*. 2001 Nov;28(11):991-7.
- Yeung AL, Lo EC, Chow TW, Clark RK. Oral health status of patients 5–6 years after placement of cobalt–chromium removable partial dentures. *Journal of oral rehabilitation*. 2000 Mar;27(3):183-9.
- Lalla RV, Patton LL, Dongari-Bagtzoglou A. Oral candidiasis: pathogenesis, clinical presentation, diagnosis and treatment strategies. *Journal of the California Dental Association*. 2013 Apr 1;41(4):263-8.
- Milton Rocha Gusmão J, Pereira RP. Treatment protocol for denture stomatitis, prior to anatomical molding. *Gerodontology*. 2013 Sep;30(3):232-5.
- Al-Huraisi H, Moran J, Jagger R, MacDonald E. Evaluation of stain removal and inhibition properties of eight denture cleansers: an in vitro study. *Gerodontology*. 2013 Mar;30(1):10-7.
- Alam M, Jagger R, Vowles R, Moran J. Comparative stain removal properties of four commercially available denture cleaning products: an in vitro study. *International journal of dental hygiene*. 2011 Feb;9(1):37-42.
- Khan M, Khan A. ORAL COMPLAINTS AND LEVEL OF SATISFACTION AMONG THE REMOVABLE DENTURE WEARERS A STUDY. *Pakistan Oral & Dental Journal*. 2015 Mar 1;35(1).
- Shams A, Tavanafar S, Dastjerdi MR, Chaijan KA.

- Patient satisfaction and complication rates after delivery of removable partial dentures: A 4-year retrospective study. *SRM Journal of Research in Dental Sciences*. 2015 Oct 1;6(4):225.
23. Dula LJ, Shala KS, Pustina-Krasniqi T, Bicaj T, Ahmedi EF. The influence of removable partial dentures on the periodontal health of abutment and non-abutment teeth. *European journal of dentistry*. 2015 Jul;9(3):382.
  24. PizaPellizzer E, Ferração R, PiccolottoTonella B, de Cazaes Oliveira BJ, Lopes Souza F, Falcón-Antenucci RM. Influence of ridge type on mandibular distal extension removable partial denture. *Acta OdontológicaLatinoamericana*. 2010 Apr;23(1):68-73.
  25. Baran İ, Ergün G, Semiz M. Socio-demographic and economic factors affecting the acceptance of removable dentures. *European journal of dentistry*. 2007 Apr;1(2):104.
  26. Zlataric DK, Celebic A, Valentic-Peruzovic M, Celic R, Filipovic-Zore I, Baucic M. The satisfaction with the RPD therapy in the Croatian adult population. *Coll Antropol* 2000;24:485-94.
  27. Singh BP, Pradhan KN, Tripathi A, Tua R, Tripathi S. Effect of sociodemographic variables on complete denture satisfaction. *The journal of advanced prosthodontics*. 2012 Feb 1;4(1):43-51.
  28. Abouelkomsan AM, Butt AM, Dall AQ. Removable partial dentures: patient satisfaction with associated demographic and biomechanical factors. *Pakistan Oral & Dental Journal*. 2012 Dec 1;32(3).
  29. Siqueira GP, Dos Santos MB, Santos JF, Marchini L. Patients' expectation and satisfaction with removable dental prosthesis therapy and correlation with patients' evaluation of the dentists. *Acta Odontologica Scandinavica*. 2013 Jan 1;71(1):210-4.
  30. D. KnezovicZlataric et al.: Partial Denture Therapy, *Coll. Antropol*. 24 (2000) 2: 485–494.
  31. Wakabayashi N, Yatabe M, Ai M, Sato M, Nakamura K. The influence of some demographic and clinical variables on psychosomatic traits of patients requesting replacement removable partial dentures. *Journal of oral rehabilitation*. 1998 Jul;25(7):507-12.
  32. Knezović-Zlatarić D, Čelebić A, Valentić-Peruzović M, Jerolimov V, Čelić R, Filipović-Zore I, Alajbeg I. Patients' satisfaction with partial denture therapy. *Acta stomatologicaCroatica*. 2000 Dec 15;34(4):373-8.
  33. Akeel RF. Effect of the quality of removable prostheses on patient satisfaction. *J Contemp Dent Pract*. 2009 Nov 1;10(6):E057-64.
  34. Weinstein M, Schuchman J, Lieberman J, Rosen P. Age and denture experience as determinants in patient denture satisfaction. *The Journal of Prosthetic Dentistry*. 1988 Mar 1;59(3):327-9.
  35. Al-Jammali ZM, Al-Muthaffer A, Al-Yasiry A, Saad Z. The satisfaction of patient with removable partial denture therapy from point of the comfort and chewing efficiency. *Annals of Tropical Medicine and Health*. 2019 Dec;22:31-8.
  36. Turker SB, Sener ID, Özkan YK. Satisfaction of the complete denture wearers related to various factors. *Archives of gerontology and geriatrics*. 2009 Sep 1;49(2):e126-9.
  37. Miranda BB, dos Santos MB, Marchini L. Patients' perceptions of benefits and risks of complete denture therapy. *Journal of Prosthodontics*. 2014 Oct;23(7):515-20.
  38. Gaspar MG, Dos Santos MB, Dos Santos JF, Marchini L. Correlation of previous experience, patient expectation and the number of post-delivery adjustments of complete dentures with patient satisfaction in a Brazilian population. *Journal of oral rehabilitation*. 2013 Aug;40(8):590-4.

# The Accumulative Effect of Heavy Metals on Liver and Kidney Functions

Zeyad Gattea Koshan Al-Rikabi<sup>1</sup>, Montaha Abulkareem Al-Saffar<sup>3</sup>, Adnan H. Abbas<sup>3</sup>

<sup>1</sup>Lecturer, <sup>2</sup>Prof., Ministry of Science and Technology/Environment and Water Directorate/Baghdad, Iraq,

<sup>3</sup>Lecture, Department of community health, Medical technical Institute, Middle Technical University, Baghdad, Iraq

## Abstract

Some of the heavy metals exist in the outer layer of the earth, which is utilized for different economic and manufacturing objectives. As some of these minerals impact humans in several ways, which are direct and indirect, others like Cadmium and Zinc are needed for several body activities, such as organ functions and biological chemical processes. Within these tests, we employed analysis of liver enzyme, urea, and creatinine, to discover the damaged tissue causing after exposure to heavy metals. Results of liver function enzymes, Aspartate aminotransferase (AST), Alanine transaminase (ALT), and Alkaline phosphatase (ALP), were registered a significantly increasing ( $P \leq 0.05$ ) for control, Cadmium treatment and zinc treatment groups, with (32.1, 39.3, and 30.5) IU/ml, (9.6, 16.0, and 8.4) IU/ml, and (1.6, 2.5 and 2.12) IU/ml, respectively. Cadmium administration was significantly reduced ( $P \leq 0.05$ ) in serum creatinine concentration (1.26) IU/ml, compared to the control group (2.02) IU/ml. While the average serum creatinine concentration increased to (4.99) IU/ml after giving rat group Zinc solution. Moreover, the urea concentration was significantly decreased to (18.85) IU/ml in the Cadmium treatment group than values of control and Zinc group (30.61, and 35.97) IU/ml, respectively.

**Keywords:** Liver enzymes, creatinine, urea, heavy metals.

## Introduction

The effect of heavy metals on biochemical enzymes in living systems has been studied. The changes refer to the action of enzymes and/or embryonic tissues to determine the developmental processes, which are distinguished by the growth and formation of new tissues in viviparous animals, as embryonic nutrition.

Heavy metals stimulate enzyme activity via the transformation process of maternal or embryonic tissues and display in the form of natural growth variations. The metabolic levels of the embryo foreseeable to be various

from the maternal, which is reflected in the enzymatic activity. Dosing of Cadmium chloride with concentration from (50 to 200) ppm to the male of Sprague Dawley rats increased aspartate aminotransferase (AST or AAT) and alanine aminotransferase (ALT or ALAT) enzymes in the kidney, liver, and brain tissues [26]. Exposure *katelaysia opima* to the Mercuric chloride (0.07 and 0.14) mg/l has raised the activity of AST and reducing the activity of Na<sup>+</sup>-K<sup>+</sup> ATPase<sup>[17]</sup>.

Rainbow trout *Oncorhynchus mykiss* were significantly influenced by a sub-lethal concentration of Cadmium (Cd) and responses on growth and biochemical parameters, while chronic exposure was developing early elevation or depression, this pattern is showing adaptation to the toxicant over time. So, exposing of *Oreochromis mossambicus* to the concentration of Cadmium chloride, caused necrosis, rising the activity of AST and ALT in tissues, and increasing cell membrane permeability, resulting in damage of tissues after 1 and 2 weeks.

---

### Corresponding Author:

**Zeyad Gattea Koshan Al-Rikabi**

Lecturer, Ministry of Science and Technology/  
Environment and Water Directorate/Baghdad, Iraq,  
e-mail: zgkoshan@yahoo.com



Heavy metals cause damage and malfunction in tissues of organisms [33]. Persistent exposure to Cd concentrations raised the enzyme's activity of AST and ALT in *Oreochromis niloticus*, which are accomplish an important role in the metabolisms of amino acid and protein and maybe releasing into plasma, then destruction and dysfunction tissue. It has become clear that a decrease in the activity of ALP enzymes is an outcome of disruption in the membrane of the transport system, while the increase in the activity probably associated with damaged tissue, which is affected by various factors, such as water quality, lifetime history, Cd concentration and exposure period [10].

One of the major health in the recent world was prolonged exposure to environmental pollution with heavy metals, which diffusion by industrial operation, volcanic explosion, bacterial activity, spring waters, anthropogenic activities including fossil fuel combustion, erosion, agricultural activities like feeding, and bioaccumulation. Environmental health hazards of these metals are easily distinguishable from the top 10 in the list of Dangerous Materials of the Agency for Toxic Substances and Disease Registry [8] [2]. Heavy metals have a cumulative toxic affection causes chronic degradation, particularly in the neural system, renal, and liver, besides some cases affect teratogen and carcinogenic [12] [13].

The high toxicity of Cd is due to its long biological half-life (10-30) years in person tissues, which makes him attack numerous organs and systems, mainly the liver, kidney, and neural system, also. Acute and chronic Cd exposure causes hepatocyte swelling and massive necrosis as a result of elevation in enzymatic biomarkers [4] [23]. Human tissue is exposed to Cd by smoking cigarettes, agricultural uses, electroplating Cd-Nickel batteries as industrial sources, and paint pigment manufacturing units [39].

Although numerous researches on Cd toxicity performed, the molecular technique dependent on Cd toxicity has not been defining so far. The presence of Reactive Oxygen Species (ROS) resulting from the destruction of macromolecules indicates to pathogenicity caused by Cd-toxicity [22]. Anyway, it is not recognized if Cd was producing ROS directly by interacting with molecular oxygen or after represses the antioxidant protection system.

Cellular regulatory proteins are the target of free

radicals generated from carcinogenic heavy metals, although they are involved in apoptosis, DNA repair, cell cycle regulation, cell growth, DNA methylation, and differentiation [15].

Cd was utilized in the production of paint, pigment alloys, coating, electrode components in producing alkaline batteries, and plastic. Cd is discharged from smelters and released into sewage sludge, fertilizers, and groundwater than is used up by plants, and reached to humans by ingestion contaminated food like cereals, vegetable, grains, and fruits [7] [34] [16].

This research aimed to study the influences of chronic oxidative tension in the liver, kidney, and liver function parameters in mice, as an outcome of exposure to environmental doses of heavy metals.

## Materials and Method

This research was achieved at the Ministry of Science and Technology laboratories, three groups of mice (male and female), (C57BL), (50) mice for each group were subjected them to the same conditions of experience, such as accommodation, nutrition, and attention. The experiments were started at the beginning of April and ended after 90 days later. The first group of mice was given drinking water with a concentration of Cd salts (0.685) mg/l.

Whereas, the second group was given concentration of Zinc salts (0.572) mg/l with drinking water, while the third group was considered as a control group, which was given only distilled water throughout this period. Finally, blood was collected after drawn directly from the heart to obtain the blood serum, and then biochemical examinations of liver and kidney functions were performed. The diagnostic examination kit was of AFCO type.

## Results

The difference in liver function enzyme concentrations is an indirect indication in diagnosing liver damage, as high concentrations of these enzymes in the blood cause an imbalance in liver cells. Table (1) shows that the level of AST in the Cd treatment group significantly increasing ( $P \leq 0.05$ ) was (39.3) IU/ml compared to a control group (32.1) IU/ml. Whereas, the average significantly decreased to (30.5) IU/ml in the Zinc treatment group compared to a Cd treatment group and control group. While, ALT was significantly

increasing to (16) IU/ml in the Cd treatment group compared to the control group and Zinc treatment group with (9.6, and 8.4) IU/ml, respectively. At low concentrations of liver function enzymes, we note the presence of mathematical differences compared to the control group and significant differences when using

the Cd treatment group. However, ALP concentration significantly increased ( $P \leq 0.05$ ) in the Cd treatment group reaching to (2.57) IU/ml compared to the control, and Zinc treatment groups with (1.61, and 2.12) IU/ml, respectively.

**Table (1): Effect of cadmium and zinc administration on liver enzymes**

ALP	ALT	AST	Treatment
Control group	32.10±5.60 <sup>b</sup>	9.60±1.50 <sup>b</sup>	1.61±0.18 <sup>b</sup>
Cadmium group	39.30±9.26 <sup>a</sup>	16.00±3.65 <sup>a</sup>	2.57±0.29 <sup>a</sup>
Zinc group	30.50±5.64 <sup>b</sup>	8.40±2.31 <sup>b</sup>	2.12±0.29 <sup>ab</sup>
LSD	7.2	6.2	0.96

Besides, table (2) showed that the concentration of serum creatinine was significantly decreased ( $P \leq 0.05$ ) in the Cd treatment group with (1.26) IU/ml compared to the control group (2.02) IU/ml. While the average serum creatinine concentration significantly increased to (4.99) IU/ml when gave Zinc treatment group. Moreover, the concentration of urea was significantly decreasing to (18.85) IU/ml in the Cd treatment group compared to control, and Zinc treatment groups with (30.61, and 35.97) IU/ml, respectively.

**Table (2): Effect of cadmium and zinc administration on kidney functions**

Urea	Creatinine	Treatment
Control group	2.02±0.41 <sup>c</sup>	30.61±9.40 <sup>a</sup>
Cadmium group	1.26±0.65 <sup>b</sup>	18.85±8.18 <sup>b</sup>
Zinc group	4.99±0.79 <sup>a</sup>	35.97±6.93 <sup>a</sup>
LSD	0.76	11.76

**Statistical Analysis:** Statistical analysis achieving by extracting the mean ± standard error and significant differences were tested between the mathematical rate using the Duncan test [6]. Analysis by using a T-test accomplish to study differences between rates of various samples [30].

## Discussion

In this research, determined the toxic influences of Cd and Zinc on liver and kidney tissues. Oxidative stress was the harmful effect of heavy metals on human health. Cd metal can generate several ROS, increase

lipid peroxidation, and decrease the antioxidant supply. Increasing oxidative stress markers may refer to elevate the generation of ROS, which causes damage to large molecules through an occurrence of diseases related to aging, like heart disease, Parkinson's disease, diabetes, and mitochondrial diseases<sup>[19] [4] [37]</sup>.

Existence high concentration of heavy metals in the environment like Zinc and/or Cd causing food fracturing to molecules, and throw away free radicals which killing some friendly bacteria, as well as, damage to vitamins, enzymes, and yields chemicals like pesticides can form new chemicals called unique radiolysis products-URLs or toxins<sup>[5]</sup>. Some of these chemicals the long-term effect on our food was unknown, so we cannot be safe, while the immune system was affected and inhibited its functions by forming the oxidizers<sup>[38]</sup>.

On the contrary, Zinc exhibit increases the efficacy of liver enzymes due to its antioxidant activity, which gives rise to a decrease in oxidative pressures, oxidation and damages the cell as a result of the interaction between hydroxyl root (unstable free root) and some life molecules. Researchers, Stohs and Bagchi <sup>[31]</sup> and Sies <sup>[28]</sup> indicated that hydroxyl produced from hydrogen peroxide by lipid peroxidation or oxidizing the DNA or protein gave an improvement to the texture of liver tissue.

DNA damage causes mutations and maybe cancer if the repair mechanisms for DNA do not work, whereas protein damage causes inhibition of enzymes and teratogen proteins <sup>[29] [35] [21]</sup>. A system of antioxidant

metabolites and enzymes prevents damage of nucleic acids, proteins, and lipids, from occurring or removed before they cause damage, and the amount of protection depends on the concentration of antioxidant and reaction conditions [28][36].

Oxidative stress is an essential causative of several chronic diseases, such as cardiac disorders, immunologic disorder, cancer, atherosclerosis, and neurodegeneration[25]. In eukaryotic cells, the sources of ROS such as O<sub>2</sub>, H<sub>2</sub>O<sub>2</sub>, and OH, were a mitochondrial respiratory chain, microsomal cytochrome P450 enzymes, flavoprotein oxidases, and peroxisomal fatty acid metabolism [3]. Zinc is an inhibitor of nicotinamide adenine dinucleotide phosphate (NADPH) oxidase, decreased production a cofactor of superoxide dismutase (SOD) (enzyme catalyzes the transfer of H<sub>2</sub>O<sub>2</sub> to O<sub>2</sub>), like ROS, and stimulate the generation of metallothionein, which is very rich in cysteine (an excellent scavenger of OH). Supplementation of Zinc to healthy human (20-50) years decreasing the concentration of malondialdehyde (MDA), 4hydroxy alkenes (HAE), and 8-hydroxy deoxyguanine in the plasma[24].

The period of exposure was the main cause of Cd accumulation in all tissues, for example, the concentration of Cd in mice was much higher in the blood, liver, and kidneys exposing for only one-day per/week for 5 weeks than exposed through 5 weeks [18]. Several tests in mice were done and discovered that the concentration of Cd in blood plasma was more than red cells after injection, and the first symptom of Cd toxicity remarked in the epithelium of blood vessels, and damage of hepatocytes due to oxygen deficiency [9][11][14].

The accumulation of Cd in kidneys has several reasons, transmitted from other tissues, and release from hemoglobin during hemolysis, or liberating metallothionein from red cells [9]. The molecular analysis of Cd toxicity in kidneys is still unknown, and propose that Cd encourage the lipid peroxidation and inhibits enzymes implicated in removing of activated oxygen species from various tissues [27].

Large numbers of macromolecules and more than 300 enzymatic reactions in which Zinc performs as a necessary element responsible for its structure and functions [32]. Whereas, Cd is a toxicity element causes structural distortions to proteins due to its association with sulfhydryl groups [35].

Liver destruction is determined by estimating the

concentration of liver transaminase enzymes. After liver parenchymal cells damage or membrane permeability, enzymes like glutamate pyruvate transaminase (GPT), glutamate oxaloacetate transaminase (GOT), lactate dehydrogenase, arginase, and gamma-glutamyl transaminase, discharged out of the cell, and the result is an increase in the level of enzymes in the blood than normal [1][20].

## Conclusion

The research determined a new path to the study of biological impacts associated with environmental susceptibility to heavy metals. The aim is to distinguish antioxidant defense disorders and the oxidative processes in organs, like the kidney and liver, as a result of continuous exposure to lower doses of Cd and Zinc, and establish the effects of these metals on oxidation processes in the liver and kidney function indicator.

**Source of Funding:** This study is self-funded

**Conflict of Interest:** Disclosure the authors declare no conflict of interest.

**Ethical Clearance:** Ethical clearance from the institutional ethical committee obtained for the study.

## References

1. Aminah N. Perbandingan Kadar Pb, Hb, fungsi hati, fungsi ginjal pada karyawan BBKTL and PPM Surabaya bagian sampling dan non sampling. *J kseshatan Lingkungan*. 2006; 2(2): 111-120.
2. ATSDR (Agency for Toxic Substances and Disease Registry), CERCLA Priority List of Hazardous Substances. 2005.
3. Bao B, Prasad AS, Beck FWJ, Fitzgerald JT, Snell D and Bao GW. Zinc decreases C Reactive protein, lipid peroxidation, and implication of zinc as another protective agent. *Am J Clin Nutr*. 2010; 91: 1634-41.
4. Chen Q, Zhang R, Li WM, Niu YJ, Guo HC and Liu XH. The protective effect of grape seed procyanidin extract against cadmium-induced renal oxidative damage in mice. *Env Toxic Pharma*. 2013; 36: 759-68.
5. Duarte RC, Araujo MM, Salum DC, Marchioni E and Villavicencio ALCH. Effects of the ionizing radiations, freezing and thawing duration on chicken liver cells. *Rad Phys and Chem*. 2009;

- 78(7-8): 631-634.
6. Duncan DB. Multiple range and multiple F- test biometrics. 1955; 11: 1-42.
  7. Engwa AG, Ihekwoaba CJ, ILO US, Unaegbu M, Ayuk LE and Osuji AG. Determination of some soft drink constituents and contamination by some heavy metals in Nigeria. *Toxic Rep.* 2015; 3: 384-390.
  8. Florea AM, Dopp E, Obe G and Rettenmeier AW. Genotoxicity of organometallic species. In: Hirner AV, Emons H, editors. *Organic Metal and Metalloid Species in the Environment: Analysis, Distribution, Processes and Toxicological Evaluation.* Heidelberg: Springer-Verlag. 2004; 205-219.
  9. Friberg L, Piscator M, Nordberg GF and Kjellstrom T. *Cadmium in the environment*, 2<sup>nd</sup> ed. Cleveland: CRC Press Inc. 1974.
  10. Gagnon A, Jumarie C and Hontela A. Effects of Cu on plasma cortisol and cortisol secretion by adrenocortical cells of rainbow trout (*Oncorhynchus mykiss*). *Toxicol.* 2006; 78: 59-65.
  11. Godowicz B. Cadmium-induced liver and spleen damage in inbred mouse strains. *Folia. Biol.* 1988; 36(1-2): 47-52.
  12. IARC (International Agency for Research on Cancer). *Monographs on the Evaluation of the Carcinogenic Risk of Chemicals to Humans: Arsenic and Arsenic Compounds (Group 1)*, World Health Organization, Lyon, France. 1987; 7: 100-106.
  13. Ibrahim D, Froberg B, Wolf A and Rusyniak DE. Heavy metal poisoning: clinical presentations and Pathophysiology. *Clinics in Laboratory Medicine.* 2006; 26: 67-97.
  14. Kaji T, Mishima A, Yamamoto C, Sakamoto M and Koizumi F. Effect of cadmium on the monolayer maintenance of vascular endothelial cells in culture. *Toxicol.* 1992; 71: 267-276.
  15. Kim HS, Kim YJ and Seo YR. An overview of carcinogenic heavy metal: Molecular toxicity mechanism and prevention. *J of Canc Prevent.* 2015; 20: 232-240.
  16. Krishna AK and Mohan KR. Distribution, correlation, ecological and health risk assessment of heavy metal contamination in surface soils around an industrial area, Hyderabad, India. *Env and Earth Sci.* 2016; 75: 411.
  17. Kulkarni BG and Kulakarni RG. Effect of Mercury exposure on enzymes in the Clam *Katelysia opima*. *J Mar Sci.* 1987; 16 (4): 265-266.
  18. Lind Y, Engman J, Jorhem L and Glynn AW. Cadmium accumulation in liver and kidney of mice exposed to the same weekly cadmium dose continuously or once a week. *Food Chemo Toxicol.* 1997; 35: 891-895.
  19. McMurray J, McLay J, Chopra M, Bridges A and Belch JFF. Evidence for enhanced free radical activity in chronic congestive heart failure, secondary to coronary artery disease. *Am J Cardio.* 1990; 65: 1261-1262.
  20. Muchtaromah BK and Adi TK. Transaminase enzyme and liverhistological profile of mice administered extract of Pegagan (*Centella asiatica* (L.) Urban). *Media Peternakan.* 2010; 34(2): 88.
  21. Nakabeppu YI, Sakumi K, Sakamoto K, Tsuchimoto D, Tsuzuki T and Nakatsu Y. Mutagenesis and carcinogenesis caused by the oxidation of nucleic acids. *Bio Chem.* 2006; 387(4): 373-9.
  22. Ognjanovic BI, Markovic SD, Pavlovic SZ, Zikic RV, Stajn AS and Saicic ZS. Effect of chronic cadmium exposure on antioxidant defense system in some tissues of rats: protective effect of selenium. *Phys Res.* 2008; 57: 403-411.
  23. Paul A, Das J, Das S, Samadder A and Khuda-Bukhsh AR. Poly (lactide-co-glycolide) nano-encapsulation of chelidonine, an active bioingredient of greater celandine (*Chelidonium majus*), enhances its ameliorative potential against cadmium induced oxidative stress and hepatic injury in mice. *Env Toxic Pharma.* 2013; 36: 937-47.
  24. Prasad AS, Bao B, Beck FWJ, Kucuk O and Sarkar FH. Antioxidant effect of zinc in humans. *Free Rad Biol Med.* 2004; 37: 1182-90.
  25. Prasad AS, Beck FWJ, Bao B, Fitzgerald JT, Snell DC and Steinberg JD. Zinc supplementation decreases incidence of infections in the elderly: effect of zinc on generation of cytokines and oxidative estress. *Am J Clin Nut.* 2007; 85: 837-44.
  26. Rajanna B and Chapatwala KD. Changes in ATPase activities in tissues of rats fed on Cadmium. *J Env Biol.* 1981; 2(1): 1-9.
  27. Shiraishi N, Uno H and Waalkes MP. Effects of L-ascorbic acid pretreatment on cadmium toxicity in the male Fisher (F344/NCr) rat. *Toxic.* 1993; 85:

- 85-100.
28. Sies H. Oxidative stress: Oxidants and antioxidants. *Expr Phys.* 1997; 82: 291-295.
  29. Stadtman ER. Metal-ion catalyzed oxidation of proteins: biochemical mechanism and consequences. *Free Rad Biol Med.* 1990; 9: 315-325.
  30. Steel RGD and Torrie JH. *Principle and Procedure of Statistics.* 2<sup>nd</sup> Ed. McGraw Hill: New York. 1980.
  31. Stohs SJ and Bagchi D. Oxidative mechanisms in the toxicity of metal ions. *Free Rad Biol and Med.* 1995; 18: 321-336.
  32. Tapiero H, Townsend DM and Tew KD. The antioxidant role of selenium and seleno-compounds. *Biomed Pharm.* 2003; 57: 134-44.
  33. Thirumavalavan R. Effect of cadmium on biochemical parameters in fresh water fish, *Oreochromis mossambicus*. *Asia J Sci Tech.* 2010; 4: 100-104.
  34. Unaegbu M, Engwa GA, Abaa QD, Aliozo SO, Ayuk EL and Osuji GA. Heavy metal, nutrient and antioxidant status of selected fruit samples sold in Enugu, Nigeria. *Inter J of Food Cont.* 2016; 3(7): 1-8.
  35. Valko M, Morris H and MTD C. Metals, toxicity and oxidative stress. *Curr Med Chem.* 2005; 12(10): 1161-1208.
  36. Vertuani S, Angusti A and Manfredini S. The antioxidants and pro-antioxidants network: an overview. *Curr Pharm Des.* 2004; 10: 1677-1694.
  37. Wang K, Zhang H, Chen S, Yang G, Zhang J, Tian W, Su Z and Wang Y. Organic Polymorphs: One-Compound-Based Crystals with Molecular-Conformation-and Packing-Dependent Luminescent Properties. *Adv Mater.* 2014; 26: 6168-6173.
  38. Watson AD. Ssn6-Tup1 interacts with class I histone deacetylases required for repression. *Genes Dev.* 2000; 14(21): 2737-44.
  39. Yuan Y, Jiang CY, Xu H, Sun Y, Hu FF and Bian JC. Cadmium-induced apoptosis in primary rat cerebral cortical neurons culture is mediated by a calcium signaling pathway. *PLoS One.* 2013; 31: 8(5): e64330.

# Assess the Knowledge of Married Women in Reproductive Age Group Regarding the Contraceptive Method

Timsy<sup>1</sup>, Amanpreet Kaur<sup>1</sup>, Nirlep Kaur<sup>2</sup>, Sandeep Kaur<sup>2</sup>, Shiwan<sup>2</sup>, Nikhil<sup>2</sup>

<sup>1</sup>Assistant Professor, Chitkara School of Health Sciences, Chitkara University, Punjab, India,

<sup>2</sup>B.Sc Nursing 4<sup>th</sup> Year Students

## Abstract

**Background:** Population is not a static entity and tends to change over time. Worldwide population increases every year by more than 81 million people. Such an explosion affects public health in every country but like India face higher detrimental effects on the health infrastructure thereby making it prone severe consequences. In Indian culture Women have the highest source pedestal of respect among all far more than a man that is why she is called the Goddess of Life. We conducted this study to assess knowledge of married women in reproductive age group regarding contraceptive method.

**Material and Method:** A quantitative Non experimental research design was adopted and the study was conducted at an apex level tertiary care maternity hospital using non probability convenient sampling technique was adopted and 100 married women were selected as sample for the study. A self-structured questionnaire was developed and data was collected to be analyzed.

**Results:** The results revealed that majority 56 (56%) of married women belong to age group 26- 35 years. Most 63 (63%) of the women had average knowledge scorereast all of them 37 (37 %) had poor knowledge. On application of chi square test to determine association with selected socio demographic variables, age of the women was found to be significantly associated with level of knowledge.

**Keywords:** Knowledge, women, contraceptives, Contraceptive method.

## Introduction

India's population is only second to that of China. It has only 2.4% surface area of total world and yet has 17.5 % of the world's population (Lakshmi Manjeera & Neetha, 2013). One of the major factors which contributes to increase population size is the considerable decline in the death rates and incline in birth rate has due to advancement of health care system (Khan & Jerifa, 2014). Therefore, strategies related to family planning have immense importance. WHO defined the Family planning as "A way of thinking and living that is adopted voluntarily, upon the basis of knowledge,

attitudes and responsible decisions by individuals and couples, in order to promote the health and welfare of the family group and thus contribute effectively to the social development of the country" (Balgir, Singh, Kaur, Verma, & Kaur, 2013). India was the first country in the world which in 1952, formulated the National Family Planning Program. The objectives of the plan was to reduce the birth rate up to the level necessary to stabilize the population at carrying capacity of nation economy (Nanda, Adak, & Bharati, 2011). Contraceptive method are effective, safe and low-cost strategies to avoid the undesired pregnancy. Contraceptive method are available for both males and females but most of them are female reproductive system oriented, therefore it is necessary for women to have proper knowledge started the various reproductive and child health program at local as well as national level (Girdhar, Chaudhary, Gill, Soni, & Sachar, 2010) but in spite of all efforts awareness and acceptance level of contraception is still low in many parts of the country. Purpose of the study was to

---

### Corresponding Author:

**Ms. Amanpreet Kaur**

Assistant Professor, Chitkara School of Health Sciences, Chitkara University, Rajpura,  
e-mail: preetaman45644@gmail.com

assess the knowledge of married women in reproductive age group regarding contraceptive method in selected hospital of district Patiala, Punjab and To determine the association between level of knowledge of married women and selected socio demographic variables with a view to develop pamphlet on information about

**Literature Review:** We searched for articles on contraceptive method and association of the knowledge of contraceptive method and demographic variables. A cross sectional study was conducted by Tejaswini et al in 2018 among married women about the knowledge, attitude and practices of contraception in Bowring and Lady Curzon Hospital, Bangalore. 72% of the participants had awareness of contraception. Most common method known is female sterilization followed by IUCD. Awareness of emergency contraception was found only in 5.33%. 48% of the participants did not follow any method of contraception (D, JC, & Bai,2018). Kruthika and Metgud 2017: Conducted a community based cross sectional study among married women about the prevalence of contraceptive use residing in the urban areas of Belagavi. Study revealed that prevalence of contraceptive use was 58.8%, among these 16.0% were condom user, 18.9% were using IUCD, 4.3% using rhythm method, 3.3% using OCPs and 16.3% were practicing sterilization method (Kruthika & Metgud,2017). Benjamin et al 2017: Conducted a cross sectional study to assess the knowledge about the contraceptive measures among rural women of childbearing age in Rivers State, Nigeria. Almost all of the rural women had awareness of contraceptives but only 63% had good knowledge of it. The most commonly known method were the male condom and injectable (Osaro, Tobin-West, & Mezie-Okoye,2017). Sukla et al 2017: Conducted a cross sectional study on contraceptive knowledge, attitudes and practices among women in the reproductive age group attending a tertiary care hospital in Mumbai, the result revealed that 62.5% women were using contraception. Only 17% women used oral contraceptive pills as a contraceptive method though 66% women knew about them. Though 59.4% of the women knew about IUCDs only 3.5% were actually using IUCD (Shukla, Fonseca, & Deshmukh, 2017). Katama and Hibstu 2016: conducted a cross sectional study-about the knowledge, attitude, practice of contraceptive use among 288 female students in secondary and preparatory school, south Ethiopia. Result revealed that Total of 263 female students were involved in this study, of which 249(94.7%) had good knowledge

about contraception. The three most frequently identified method were injectable form (83.9%), oral contraceptive pills (72.7%) and condom (48.6%). A total of 15.7% respondents ever used contraceptive. Among the users, 56.4% used oral contraceptive pills, and 23.1 and 10.2% used injectable form and condom, respectively (Katama & Hibstu, 2016). Alege et al. 2016: Conducted a secondary analysis of data from a larger cross-sectional study to measure changes in perceptions towards long-term and reversible contraceptive among 2,033 women of reproductive age (15-49 years) resident in 34 districts of Uganda. Result. Revealed that sixtytwo per cent of women reported current use of any family planning method. Among non-users of family planning, injectables (50.4%), implants (22.8%) and pills (20.2%) were the most preferred family planning method (Alege, Matovu, Ssensalire, & Nabiwemba,2016).

**Sample:** A non-probability convenient sampling Technique was adopted and 100 married women were selected as sample for the study at an apex level tertiary care maternity hospital. Inclusion Criteria of the study was Married women between the age group of 15-49 years and who are willing to participate in the study and available at the time of data collection and exclusion Criteria was Women who had attained menopause was excluded. After getting the ethical approval, the final study was conducted in the selected hospital. 100 women were selected by convenient sampling technique and the data was collected by using structured knowledge questionnaire. Written informed consent was obtained before collecting data from the subjects.

## Materials and Method

The study was adopted for the quantitative research approach and design was Non experimental research design. The study was conducted in selected hospital and 100 married women between the age group of 15-49 years were selected by using convenient sampling technique. The tool used for the data collection consisted of selected variables and structured knowledge questionnaire regarding knowledge on contraception. Ethical Consideration was taken by the approval of research and ethical committee was taken before starting the study. Anonymity of subject and confidentiality of information was maintained. It was ensured that the study would not have any bad affect to the participant in any way and Selected variables consists of items regarding the selected variables which include, age, religion, educational status, occupation, monthly income, family

status, locality, age at marriage, duration of marriage in year, no of children, source of information and also a structured knowledge questionnaire was used to assess the knowledge regarding questionnaire. The collected data was analyzed in accordance with the objective of the study by using descriptive statistics mean, median, standard deviation, frequency, percentage and inferential statistic was used Chi square.

### Results

The present study revealed that married women had average knowledge score which was 63 (63%) whereas 37(37%) had poor but none of them had good knowledge regarding contraceptive method among married women in reproductive age group in selected hospital. According to first section majority of the married women of reproductive age group 56 (56%) belong to Age group 26- 35 years, 48(48%) belong to Sikh religion, 31(31%) each were Educated up to Elementary & Secondary respectively, 73 (73%) were Housewife as per Occupation, 38 (38%)had Family income between 5,001-10,000, 47 (47%) belong to Nuclear family status, 68 (68%) were from Rural locality, 51 (51%) was 1-5

years as per duration of Married life, 32 (32%) each were one and two respectively as per number of Children and 32 (32%) used Health Personal as Source of Information. According to second section depicts that the knowledge of married women in reproductive age group regarding the contraceptive method, where majority of married women of reproductive age knowledge score 63 (63%) was average and 37 (37%) was poor but none of them had good knowledge score and according to the third section the study was association between knowledge of married women in reproductive age group regarding the contraceptive method and the selected socio demographic variable showed that in married women of reproductive age, Age of married women knowledge in reproductive age group regarding the contraceptive method in selected Hospital has association the calculated value of chi-square is (3.879) which is more than the tabled value (3.841) at 0.05% level of significance, with (1df). Hence, we can conclude that age of married women and knowledge of married women in reproductive age group regarding the contraceptive method in selected Hospital were significantly associated with eachother.

**Table No. 1: Frequency and percentage of the knowledge of married women of reproductive age group regarding the contraceptive method in selected Hospital of District Patiala, Punjab. N=100**

Criteria Measure of Knowledge Score		
Level of Scores	Frequency	Percentage
Good Knowledge (21-30)	0	0
Average Knowledge (11-20)	63	63
Poor Knowledge (0-10)	37	37

Maximum Score=30 Minimum Score=0

**Table No. 2: Descriptive statistics of the knowledge of married women in reproductive age group regarding the contraceptive method in selected Hospital of District Patiala, Punjab. N=100**

Descriptive Statistics	Mean	Median	SD	Maximum	Minimum	Range	Mean %
Knowledge Score	11.40	11	3.54	20	4	16	38

Maximum Score=30, Minimum Score=0

### Discussion

According to the objectives of the study researchers presented their findings through analysis along with the comparison with other similar research findings. In the First Section the analysis of socio demographic profile

was calculated on the basis of percentage and frequency of married women in reproductive age group 15-49 years. In the second section analysis of the knowledge of married women in reproductive age group regarding the contraceptive method in selected Hospital and in the third section to find out the association between



knowledge of married women in reproductive age group regarding the contraceptive method and the selected socio demographic variable showed that in married women of reproductive age, Age of married women knowledge in reproductive age group regarding the contraceptive method in selected Hospital. Clinical Implication of the study was to finding of the study has various implication which were discussed in areas on Nursing education, Nursing services, Nursing research and Nursing practice. In Nursing Education there is a lack of knowledge regarding temporary contraceptive measure among married women of reproductive age in India it is important that married women should increase their knowledge regarding temporary contraceptive measure so this topic should be included in curriculum. In the Nursing educator should strongly emphasize on this topic and create awareness among married women of reproductive age group who in turn can provide to other married women regarding the temporary contact measures. In the Nursing profession should render services according to the changing needs of the society. There is high need for health personnel to take part in providing health education to people regarding contraceptive measure. So There is need to prepare the community volunteers who will act as link between the community married women of reproductive age group and hospital and in the last In Nursing Research In our country lack of knowledge regarding contraceptive method is major problem so, it is essential to identify the present level of knowledge and practice of women regarding contraceptive method to know the extent of information necessary to taught and there is need for extended nursing research on contraceptive method since present study supported by many other studies reveal poor knowledge, practice and attitude of women toward contraceptive method, practices as well as attitude can be improved/enhanced . through many multiple researches are conducted by various nursing personnel at various level, yet there is serious lack in dissemination of the finding.

**Ethical Approval:** Approval of research and ethical committee of Department of Nursing, Chitkara School of Health Sciences was taken before starting the study. Permission was obtained from the Principal of the college and Senior Medical Officer of Hospital District Patiala, Punjab. Anonymity of subject and confidentiality of information was maintained. It was ensured that the study would not have any bad affect to the participant in any way.

## References

1. Alemayehu M, Belachew T, Tilahun T. Factors associated with utilization of long acting and permanent contraceptive method among married women of reproductive age in Mekelle town, Tigray region, north Ethiopia. *BMC pregnancy and childbirth*. 2012 Dec 1;12(1):6.
2. Prachi R, Das GS, Ankur B, Shipra J, Binita K. A study of knowledge, attitude and practice of family planning among the women of reproductive age group in Sikkim. *Religion*. 2008;35(44years):34.
3. Pegu B, Gaur BP, Sharma N, Singh AS. Knowledge, attitude and practices of contraception among married women. *Int J Reprod Contracept Obstet Gynecol*. 2014;3(2):385-8.
4. Ghosh S, Samanta A, Mukherjee S. Knowledge and practice of family planning in married women of reproductive age group in a slum of Kolkata. *Al Ameen J Med Sci*. 2013;6(1):34-9.
5. Sarella LK, Prasanna NS. A study on contraceptive knowledge, attitude and practice among reproductive age group women in a tertiary institute. *Int J Heal Sci Res*. 2014 Apr;10(2):577-80.
6. Anjum S, Durgawale PM, Shinde M. Knowledge of contraceptives method and appraisal of health education among married woman. *International Journal of Science and Research (IJSR)*. 2014; 3(3):584-90.

# An Analytical Prospective Study of Plasma Pseudo-Cholinesterase Level & its Co-Relation to Mortality in Acute Organo Phosphate Poisoning

Tejas J.<sup>1</sup>, Siva Kumar V.<sup>1</sup>, Shruthi K.<sup>2</sup>, Vishwanathan K.G.<sup>3</sup>

<sup>1</sup>Associate Professor, Dept. of Forensic Medicine & Toxicology, Kmchihsr, Coimbatore, Tn, <sup>2</sup>Assistant Professor, Dept. of Physiology, Rvsims, Chittoor, Ap, <sup>3</sup>Professor and Head, Dept. of Forensic Medicine, Basaveshwara Medical College & Hospital, Ka

## Abstract

**Background:** The Incidence of Poisoning Is Constantly On The Rise In The Modern World With A Gradual Shift Towards The Use of Agricultural Poisons In Suicides With Majority of Cases Using Organophosphate Compounds And In India The Incidence of Ingested Suicidal Poisoning Is High Especially In The Southern States. This Study Is Undertaken With A View To Asses If There Is Any Correlation Between Plasma Levels of Pseudocholinesterase and mortality in cases of acute organophosphate poisoning. Method: The study was conducted on patients of organophosphate poisoning admitted to Bapuji Hospital (J.J.M. Medical College), Davangere during a period of October 2011 to March 2013. Total number of cases studied were 150. Detailed history was obtained regarding the amount of poison, type of poison, quantity of poison, etc from the patient and his/her relatives as well from the police.

Clinical examination of each patient was carried out and according to signs and symptoms, the patients were grouped into 3 grades, mild, moderate and severe according to Dreisbach's criteria. At the time of admission pseudocholinesterase was measured. All patients were followed-up for 3 days to know the outcome and results were compared and analysed.

**Conclusion:** Our study concludes that there is a very good correlation between the levels of plasma pseudocholinesterase and mortality as well as morbidity

**Keywords:** *Pseudocholinesterase, organo-phosphate, butyrylcholinesterase, agricultural poisons.*

## Introduction

Paracelsus in 16<sup>th</sup> century expressed the classic toxicology maxim "All things are poison, and nothing is without poison; the dosage alone makes it so a thing is not a poison.". The world health organization defines poisoning as that which occurs when people drink, eat, breathe, inject, or touch enough of a hazardous substance

(poison) to cause illness or death<sup>1</sup>. The incidence of poisoning is constantly on the rise in the modern world with a gradual shift towards the use of agricultural poisons in suicides with majority of cases using organophosphate compounds. In India the incidence of ingested suicidal poisoning is high especially in the southern states. This study is undertaken with a view to asses if there is any correlation between plasma levels of pseudocholinesterase and mortality in cases of acute organophosphate poisoning with an aim to develop good prognostic index and mortality predictor in such cases.

---

## Corresponding Author:

**Dr. Sivakumar**

Assistant Professor, Dept. of Forensic Medicine & Toxicology, Kmchihsr, Coimbatore-641014

Ph: +919739279018

e-mail: sivakumarvarattoor89@gmail.com

## Methodology

**Study Sample:** The study was conducted on patients of organophosphate poisoning admitted to Bapuji Hospital (J. J. M. Medical College), Davangere

during a period of October 2011 to March 2013. Total number of cases studied were 150

**Materials Used:** 18-gauge needle, 10cc syringe, Colour coded vacutainer tubes, Cobas Integra 400 cholinesterase assay system.

**Inclusion Criteria:** All patients with Organophosphate poisoning with age more than 14 years belonging to either sex was included in the study.

**Exclusion Criteria:** All patients with age less than 14 years, poisoning other than organophosphate

**Data Collection:** Data was collected from hospital admission records, hospital MLC registers, patient case history & examination and history from eye witness, relatives, friends of deceased & investigating officer. Detailed history was obtained regarding the amount of poison, type of poison, quantity of poison, etc from the patient and his/her relatives as well from the police. Examination of the poison container was also done whenever available. Clinical examination of each patient was carried out and according to signs and symptoms, the patients were grouped into 3 grades, mild, moderate and severe according to Dreisbach’s criteria<sup>2</sup>.

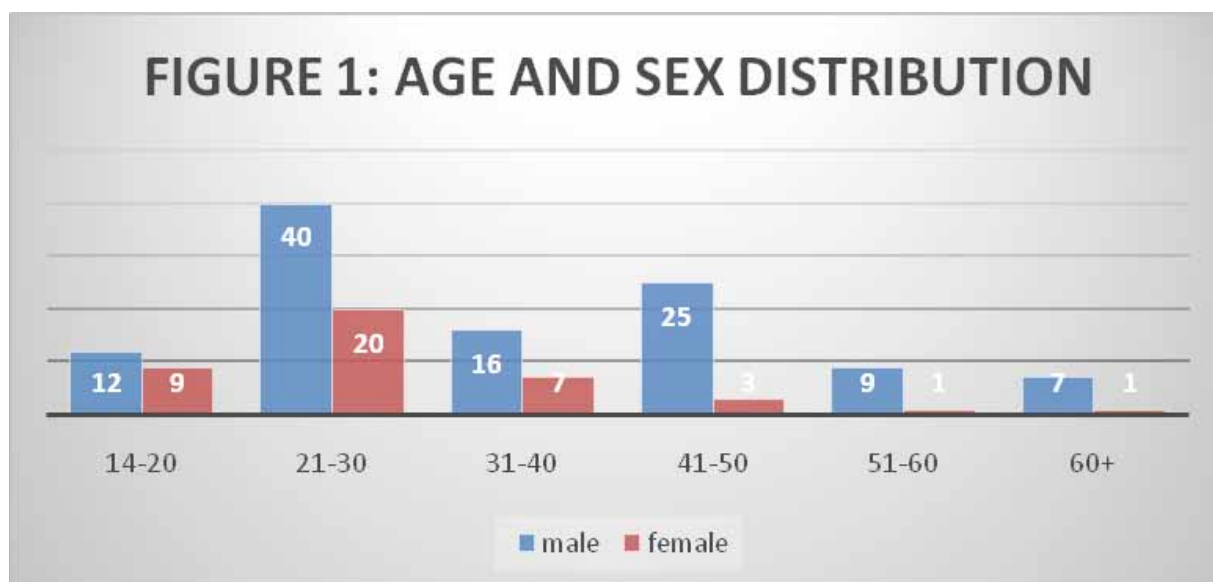
Grade (Dreisbachs)	Symptom
Moderate	1. Lacrimation 2. Salivation 3. Miosis 4. Fasciculation
Severe	1. Coma 2. Seizures 3. Incontinence 4. ARDS 5. Areflexia

At the time of admission pseudocholinesterase was measured by drawing blood from the patient, collected and forwarded in vacutainer tube with EDTA as preservative and subjected it to analysis by COBAS INTEGRA 400 CHOLINESTERASE ASSAY SYSTEM. The range of values in 3 control patients was found to be 13,400 U/L to 15,600 U/L at room temperature (37°C). All patients were followed-up for 3 days to know the outcome. Also, in fatal cases the Forensic Science Laboratory was also used for conformation of organophosphorus poisoning. Results were analysed using Microsoft excel 2013 and IBM SPSS statistics 22 software.

### Results

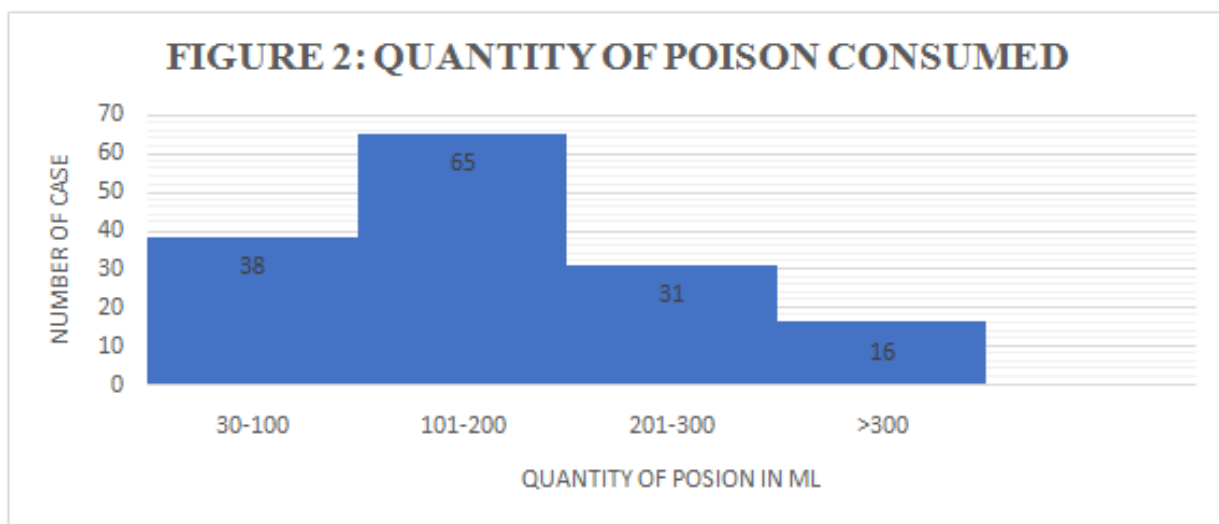
**Patient Characteristics: Age and Sex:** The age and sex distribution of the study group is shown in figure 1. The maximum number of cases was seen in the 21 to 30 years age group. Youngest patients were 2 females of age 14 years each and oldest patient was a male of age 76 years. Sex distribution of the cases studied had a male predominance in each age group with 109 (73%) male patients to 41 (27%) female patients.

Grade (Dreisbachs)	Symptom
Mild	1. Nausea 2. Vomiting 3. Diarrhoea 4. Sweating



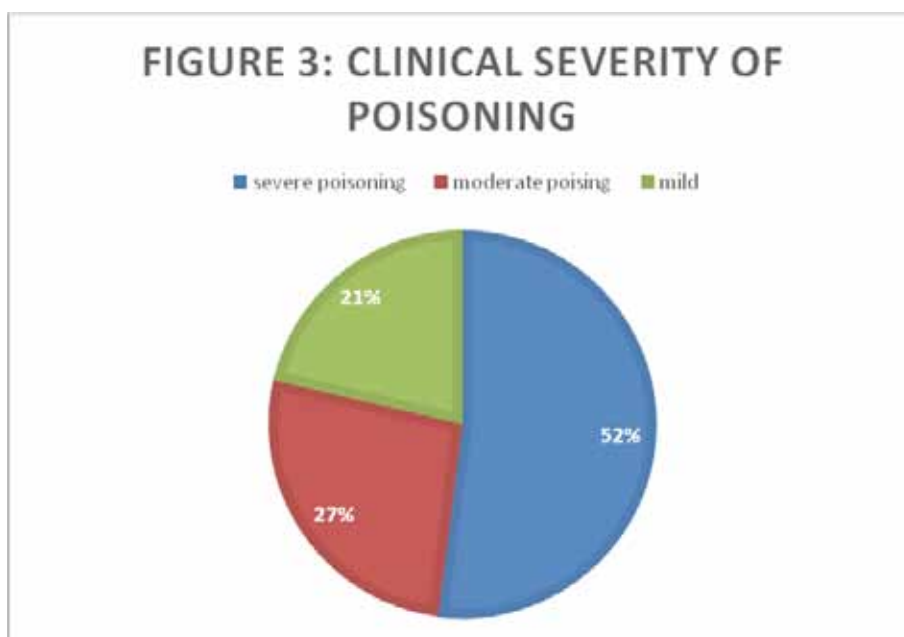
**Type of Poison Consumed:** The distribution of patients according to type of poison consumed is shown in figure. 2. The commonest poison consumed in the study was Malathion (28 patients, 18.67%). Second commonest was Dimethoate (26 patients, 17.33%), followed by dichlorvos and parathion. All poisons belonged to organophosphorus class.

**Approximate Quantity of Insecticide Ingested:** 65 patients (43.33%) had consumed 101ml to 200ml of organophosphorus compound. 38 patients (25.33%) had consumed 30ml to 100ml of organophosphorus compound. 31 patients (20.67%) had consumed 201ml to 300ml of organophosphorus compound. Very high doses of consumption i.e. > 300ml were seen in 16 patients (10.67%).



**Clinical Severity of Poisoning Based on Clinical Features:** The patients were clinically examined and divided into groups using the Dreisbach's criteria <sup>2</sup>. 78 patients (52%) had severe poisoning, 40 patients (26.67%) had moderate poisoning and 32 patients (21.33%) had

mild poisoning. Emesis and gastric irritation were seen in >90% of cases followed by defecation, urination, lacrimation and salivation which were seen in >80% cases.



**Final Outcome:** In the 3-day follow-up 60 patients (40%) had fatal outcome (including coma) and 90 patients (60%) survived with treatment. Of the 60 fatalities, 26 cases (17.33%) died within 24 hours.

All the fatalities were associated with severe poisoning. Among those who survived 18 patients (12%) had severe poisoning.

**Plasma Pseudo-Cholinesterase Levels:** In the group with severe poisoning the plasma pseudo-cholinesterase levels were found to be range from 912 U/L to 2,490 U/L. (mean value = 1,696.62 U/L and S.D = +/- 438.99 U/L). This group contained all the 60 fatalities (40%) observed in this study. The Plasma Pseudocholinesterase levels of all the 60 fatal cases were compared and found to be statistically highly significant ( $p < 0.001$ ). This amounts to suppression of plasma pseudo-cholinesterase by 84.04% to 93.19%. 18 patients (12%) survived with severe poisoning but no statistically significant difference was found between those who survived and fatalities ( $p > 0.5$ )

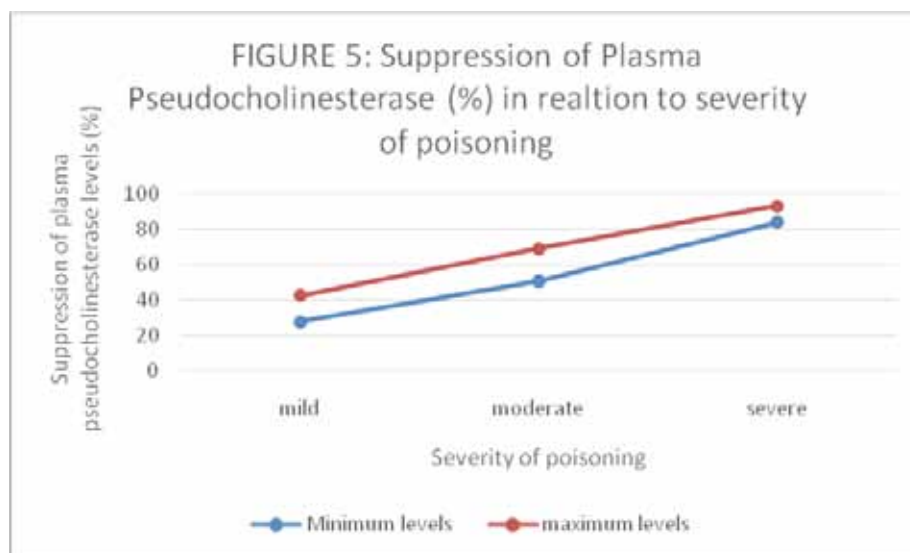
In the 26 patients (17.33%) who died within 24 hours of admission to hospital, the plasma-pseudocholinesterase levels were found to be statistically highly significant ( $p < 0.001$ ) and ranged from 912 U/L to 1,678 U/L (mean value = 1,390.35 U/L and S.D = +/- 200.68 U/L) which amounts to suppression of plasma pseudo-cholinesterase by 89.24% to 93.19%

In the group with moderate poisoning the plasma pseudo-cholinesterase levels were compared and found to be statistically highly significant ( $p < 0.001$ ) ranging from 4,128 U/L to 7,642 U/L (mean value = 5,339.40 U/L and S.D = +/- 1121.33 U/L). This amounts to suppression of plasma pseudo-cholinesterase by 51.01% to 69.19%

In the group with mild poisoning the plasma pseudo-cholinesterase levels were compared and found to be statistically highly significant ( $p < 0.001$ ) ranging from 7,654 U/L to 11,230 U/L (mean value = 9,110.38 U/L and S.D = +/- 927.29). This amounts to suppression of plasma pseudo-cholinesterase by 28.01% to 42.88%

**Table 1. Correlation between Severity of Posioning and Plasma Pseudocholinesterase Levels**

Clinical grade of poisoning		Plasma Pseudo-Cholinesterase Levels			Percentage suppression of Plasma Pseudocholinesterase level
		Range (U/L)	Mean (U/L)	Standard deviation (U/L)	
Severe	Death within 24 hours (17.33% mortality rate)	912 to 1,678	1,380	200.68	89.24% to 93.19%
	Death over a period of 3 days following admission (40% mortality rate)	912 to 2,490	2,158.15	774.15	84.04% to 93.19%
Moderate		4,128 to 7,642	5,339.40	1121.33	51.01% to 69.19%
Mild		7,654 to 11,230	9,110.38	927.29	28.01% to 42.88%



## Discussion

- 1. Patient Characteristics: Age and Sex:** In the present study, the sex incidence shows males are more affected (73%) than the females (27%). Similar observations were made by Singh et al.<sup>30</sup>, consisting of 67.95% males and majority of the cases were adults belonging to the age group of 21 to 30 years. Our study shows that all of the patients admitted were agricultural laborers. This could be due to easy availability and accessibility of poisons, particularly insecticides which are responsible for high incidence of poisoning among the agricultural workers. Similar incidence was reported by Sozmen et al.<sup>4</sup> and Naravaneni & Jamil<sup>5</sup> where in all the patients chosen for the study with exposure to organophosphate insecticide were farmers. In all cases the poisons were consumed via the oral route. Malathion is one of the most commonly used organophosphate insecticide and is commonly available for agricultural use. Even though it has a disagreeable taste, it is most often taken orally because of its easy availability to farmers and also lethality of its action. Other studies also reflect similar findings<sup>3-6</sup>.
- 2. Type of Poison Consumed:** The commonest poison consumed in the study was Malathion, 28 patients (18.67%). Second common was Dimethoate, 26 patients (17.33%). In all cases the poisons were consumed via the oral route. This finding is in agreement with other studies<sup>6-9</sup>
- 3. Approximate Quantity Of Insecticide Ingested:** Majority of the patients in our study had consumed 101ml to 200ml of organophosphorus compound (43.33%). This dose is in excess of the lethal dose for the two most common poisons found to be used in our study i.e Malathion and Dimethoate.
- 4. Clinical Severity of Poisoning Based on Clinical Features:** Patients with severe poisoning constituted the major group. This could be attributed partially to the manner of death as most of the cases in this study consumed poison with suicidal intent in which case the amount of poison consumed will be significantly more than accidental or very rarely homicidal consumption.
- 5. Final Outcome:** The patients were followed up for 3 days during which 40% had fatal outcome (including coma) and 60% survived with treatment. of the total number of fatalities 17.33% died within 24 hours of admission to the hospital. All the fatalities were associated with sever poisoning and only 12% survived with severe poisoning. A study by Kar<sup>10</sup> found a mortality of 26% patients with suicidal organ phosphorus poisoning which is higher than that found in our study as our study also includes other manners of death. A study by Singh et al.<sup>3</sup> reports a mortality of 17.30% which is in agreement with our 24 hour mortality rate.
- 6. Plasma Pseudo-Cholinesterase Levels:** In this study severe poisoning accounted for all the 60 fatalities (40%) observed and only 18 patients (12%) survived. The Plasma Pseudocholinesterase levels of all the 60 fatal cases were compared and found to be statistically highly significant ( $p < 0.001$ ). No statistically significant difference was found between those who survived and those who died with severe poisoning ( $p > 0.5$ ). Therefore, the pseudocholinesterase levels estimated at the time of admission to the hospital serves as a very good prognostic indicator and also helps in dose adjustment of various drugs for treatment. Severe poisoning was associated with suppression of plasma pseudocholinesterase by 84.04% to 93.19% where death occurred over a 3 day duration following admission to hospital. If plasma pseudocholinesterase was suppressed by 89.24% to 93.19% (as seen in those who died within 24 hours of admission) then it is associated with 100% mortality. This shows that there is a direct correlation between plasma pseudocholinesterase and severity of poisoning. And suppression of this enzyme by more than 89.24% (i.e. plasma pseudocholinesterase levels  $< 1,678$  U/L) is associated with fatal outcome. This is in agreement with a study by Xu, Zhang, yang and He<sup>11</sup> which states that when the plasma pseudocholinesterase levels reach 10% then severe acute organophosphorus poisoning occurs. A cohort study done by Eddleston and colleagues<sup>12</sup> found plasma pseudocholinesterase activity of  $< 600$  U/L on admission was highly sensitive in chlorpyrifos and specific for dimethoate poisoning which is also in agreement with this study. Sunder Ram et al.<sup>13</sup> also states that plasma pseudocholinesterase level below 10% of normal were associated with poor prognosis which is in agreement with this study. Studies reported in Reddy<sup>14</sup>, Pillay<sup>15</sup> and by Sozmen and colleagues<sup>16</sup> are all in acceptance with this study. Kukde and colleagues<sup>17</sup> have found no significant difference of pseudocholinesterase levels

between post-mortem samples of brought dead cases and partially treated cases.

### Limitations of the Study

1. Patients with age less than 14 years were not included in this study
2. Poisoning other than organophosphate whether taken independently or along with organophosphates (E.g. Alcohol) were not included in this study.
3. Serial monitoring of cases could not be done due to poor patient compliance and also due to economic limitations and only follow-up to know the outcome was performed.

### Conclusion

Our study concludes that there is a very good correlation between the levels of plasma pseudocholinesterase and mortality as well as morbidity. This study helps not only in predicting the outcome of the patient with organophosphate poisoning based on plasma pseudocholinesterase levels but also can be retrospectively used to plan the treatment of such patients and dosage calibration of antidotes such as pralidoxime.

**Ethical Clearance:** Taken from institutional ethics committee, JJMMC, Davangere

**Source of Funding:** Self

**Conflict of Interest:** Nil

### References

1. WHO | Poisoning [Internet]. [cited 2020 Jul 3]. Available from: [https://www.who.int/environmental\\_health\\_emergencies/poisoning/en/](https://www.who.int/environmental_health_emergencies/poisoning/en/)
2. Ram JS, Kumar SS, Jayarajan A, Kuppuswamy G. Continuous infusion of high doses of atropine in the management of organophosphorus compound poisoning. *J Assoc Physicians India*. 1991;39(2):190–3.
3. Singh S, Sharma BK, Wahi PL, Anand BS, Chugh KS. Spectrum of acute poisoning in adults (10 year experience). *J Assoc Physicians India*. 1984;32(7):561–3.
4. Sozmen B, Peker S, Kaya U, Erkan M, Sozmen EY. Markers of long-term exposure to organophosphorus pesticides in farmers who work in viniculture and tobacco production in Turkey. *Toxicol Mech Method*. 2007;17(7):379–84.
5. Naravani R, Jamil K. Determination of AChE levels and genotoxic effects in farmers occupationally exposed to pesticides. *Hum Exp Toxicol*. 2007;26(9):723–31.
6. Namba T, Greenfield M, Grob D. Malathion poisoning. A fatal case with cardiac manifestations. *Arch Environ Health*. 1970;21(4):533–41.
7. Dagli AJ, Shaikh WA. Pancreatic involvement in malathion--anticholinesterase insecticide intoxication. A study of 75 cases. *Br J Clin Pract*. 37(7–8):270–2.
8. Wadia RS, Bhirud RH, Gulavani AV, Amin RB. Neurological manifestations of three organophosphate poisons. *Indian J Med Res*. 1977;66(3):460–8.
9. Wille T, Thiermann H, Worek F. In vitro kinetic interactions of DEET, pyridostigmine and organophosphorus pesticides with human cholinesterases. *Chem Biol Interact*. 2011;190(2–3):79–83.
10. Kar N. Lethality of suicidal organophosphorus poisoning in an Indian population: exploring preventability. *Ann Gen Psychiatry*. 2006;5:17–17.
11. Xu C, Zhang XG, Yang X, He YZ. [The diagnostic value of butyrylcholinesterase in acute organophosphorus pesticide poisoning]. *Zhongguo Wei Zhong Bing Ji Jiu Yi Xue*. 2010/04/20 ed. 2010;22(4):193–6.
12. Eddleston M, Eyer P, Worek F, Sheriff MH, Buckley NA. Predicting outcome using butyrylcholinesterase activity in organophosphorus pesticide self-poisoning. *QJM*. 2008/04/01 ed. 2008;101(6):467–74.
13. Ram JS, Kumar SS, Jayarajan A, Kuppuswamy G. Continuous infusion of high doses of atropine in the management of organophosphorus compound poisoning. *J Assoc Physicians India*. 1991 Mar;39(2):190–3.
14. Reddy KSN. *The Essentials of Forensic Medicine and Toxicology*. 30th ed. K. Suguna Devi; 2013.
15. Pillay V V. *Modern Medical Toxicology*. 4th ed. Jaypee Brothers, Medical Publishers; 2013.
16. Sozmen B, Peker S, Kaya U, Erkan M, Sozmen EY. Markers of long-term exposure to organophosphorus pesticides in farmers who work in viniculture and tobacco production in Turkey. *Toxicol Mech Method*. 2007/01/01 ed. 2007;17(7):379–84.
17. Kukede HG, Ambade VN, Batra AK, Keoliaya AN. Significance of Serum Cholinesterase Level in Organophosphate Poisoning. *Medico-Leg Update*. 2012;12(2):70–4.

# Perception of Nursing Care among Patients at SRM General Hospital, Kattankulathur, Kancheepuram District

Keerthana S.<sup>1</sup>, Deepika M.<sup>1</sup>, C. Kanniammal<sup>2</sup>, Ushapriya Mathiazhakan<sup>3</sup>

<sup>1</sup>B.Sc. IV Year Student, SRM College of Nursing, SRMIST, <sup>2</sup>Dean, SRM College of Nursing, SRMIST,

<sup>3</sup>Assistant professor, SRM College of Nursing, SRMIST

## Abstract

**Background:** An significant point that reflects on the understanding of the standard of treatment rendered by the patient is healthcare service. Measuring the experience of nursing care patients can be helpful in improving the quality of nursing services by encouraging the setting of treatment standards and measuring both patient outcomes and quality perceptions.

**Objectives:** The primary aim of this study was to define the understanding of quality nursing care by the patient.

**Method:** To assess patients' understanding of the quality of nursing care in medical wards and surgical wards of a selected hospital, a cross-sectional descriptive research design was used. A total of 100 patients participated in the study using a purpose-based sampling methodology based on inclusion criteria, such as adult medical and surgical patients 18 years of age or older who spent at least 3 days or more in the hospital. The satisfaction of patients with the quality of nursing care (PSNCQQ) questionnaire, a standardised instrument, was used to assess the perception of the quality of nursing care by patients.

**Result:** The report showed 89 percent of high-quality care, 11 percent of decent quality nursing care and 0 percent of low-quality nursing care. The great benefit for members of the health care team is enhancing the standard of nursing care according to the understanding of the patient. The primary source of the health care scheme is providing high quality nursing care.

**Conclusion:** The results showed that nurses should inform patients about the application and protocol and provide sufficient condition, diagnosis and treatment descriptions to ensure patient satisfaction and high-quality nursing care.

**Keywords:** *Assess, patients, perception, and nursing care.*

## Introduction

A growing trial in any sector would impact the healthcare industry today as well<sup>1</sup>. Healthcare delivery is a central factor that reflects on the patient's understanding of the quality of the care they receive<sup>2</sup>. Assessing the

quality of nurses' services is vital and so nurses are forced to sustain and enhance the standard of their nursing care<sup>3</sup>. Patients' perception of nursing has been known as the most important indicator of overall patient satisfaction and an essential target of any healthcare organization<sup>4</sup>. Measuring the perception of patients about nursing care may be successful in improving the quality of nursing services by promoting the development of standards for treatment by tracking both outcomes and patients' perceptions of quality<sup>5</sup>.

Patients communicate their needs with respect to what they need, like, want, expect and demand about the nursing care they receive. The understanding of patients

---

### Corresponding Author:

**Ms. Ushapriya Mathiazhakan**

Assistant Professor, SRM College of Nursing, SRM Institute of Science and Technology, SRM Nagar, Kattankulathur, Chennai, 603203, Tamil Nadu, India  
e-mail: ushapriyansg@gmail.com



with the quality of nursing aid is that the required component within the hospital and it is helpful to improve the regular patient-supported reading<sup>6</sup>. Patients may expect more detail on their condition, choices for treatment, procedure, and nursing care. The key objective of health care providers is to achieve excellence in nursing care through the desires and perceptions of the quality of nursing care patients<sup>7</sup>. Hence the purpose of this study was to establish the understanding of quality nursing care by the patient.

**Method and Materials**

A descriptive cross-sectional research design was used to test the impression of patients about the quality of nursing care in a selected hospital’s medical wards and surgical wards. Complete 100 patients recruited for the study based on inclusion criteria such as adult medical patients aged 18 years or older, who have spent at least 3 days or more in the ward, able to understand Tamil or English and agreed to participate in this study and signed informed consent, and selected patients were interviewed. Before starting the study, the SRMIST had obtained ethical approval. The researcher met each participant and explained the study intent and the instrument. -- participant who decided to complete the instrument was also given written and orally informed consent to take part in the research. Those who were unable to read nor write were aided in completing the questionnaire.

The PSNCQQ was designed to quantify the degree of anticipated need, evaluate patient satisfaction following short-stay hospitalisation, and determine at a minimum level the impact of socio-demographic, personal and other factors<sup>8</sup> The scale was developed using the Hospital Quality Questionnaire Patient Judgements, developed by a multidisciplinary research team at the Hospital Corporation.of America. The scale was developed for managers to apply in areas needing change, to provide patient-oriented outcomes, and to recognise positive and poor aspects of the nursing care process. Things were focused on variables that were established as essential elements of nursing patient satisfaction. The PSNCQQ can be integrated into current quality control systems in hospitals. Besides, given its relevance to the patient care process as a consequence measure, the PSNCQQ can be used as an evidence-based predictor to detect improvements in departmental and institutional processes. This input gives the nursing administrators valuable knowledge. Replies to the

participants are given using a Likert-type 5-point scale. The scoring level was defined as low-quality nursing care (< 50%), acceptable or good-quality nursing care (50-75%), and high-quality nursing care (> 75%). The original English instrument was translated into Tamil and the reliability was obtained using 0.92-value Spearman-Brown formula. The data were analysed using statistics of descriptive and inferential type.

**Results and Discussion**

Result indicates that 24% belong to 21-30 years of age, 17% belong to 31-40 years of age, 13% belong to 41-50 years of age, 34% belong to 51-60 years of age, 12% belong to > 60 years of age. As far as sex is concerned, 40% belong to males and 60% belong to females. 78% belong to the Hindu faith, 9% belong to the Muslims, 13% belong to the Christians. 75% of monthly income belongs to 12000-17000, 11% belongs to 17000-22000, 13% belongs to 22000-37000, 1% belongs to 37000-50000000, 1% belongs to 37000-5000000. As for marital status, 70% belong to married people, 18% belong to unmarried people, 2% belong to divorced people. 58 percent of schooling belongs to primary education, 14 percent to secondary education, 5 percent to diplomas, 17 percent to undergraduates, 6 percent to postgraduates. In terms of occupation, 20 percent belong to specialists, 11 percent belong to technicians, 25 percent belong to skilled employees and business sales workers, 21 percent belong to skilled agricultural and fishery workers, 17 percent belong to elementary workers, 6 percent belong to unemployed workers. As for the area of living, 50% belongs to urban areas, 50% to rural areas. 58 percent belongs to only once, 22 percent belongs to twice, 11 percent belongs to three times, 9 percent belongs to > 3 times, with respect to the number of times hospitalised. 69 percent belong to one week with regard to none of the days hospitalised, 20 percent belong to two weeks, 7 percent belong to 3 weeks, 4 percent belong to > 3 weeks.

**Table 1 : Level of Quality Nursing Care N=100**

S.No.	Quality of Nursing	No. of Respondents	Percentage
1	Low	0	0%
2	Good	11	11%
3	High	89	89%

Table 1 reveals that 89% of patients receive high-quality nursing care, 11% receive good-quality nursing care, and 0% receive low-quality nursing care.

**Table 2: Association between the knowledge level on Nursing Quality and demographic variable N=100**

S.No.	Demographic Variable	Class	Quality of Nursing		Chi-Square value	DF	P-value
			Good	High			
1	Ages in years	21-30 Years	3	21	1.069	4	0.899
		31-40 Years	1	16			
		41-50 Years	1	12			
		51-60 Years	4	30			
		> 60 years	2	10			
2	Sex	Male	3	37	0.834	1	0.361
		Female	8	52			
3	Religion	Hindu	9	69	0.168	2	0.919
		Muslim	1	8			
		Christian	1	12			
4	Monthly Income	Rs.12000-17000	9	66	1.815	3	0.612
		Rs.17000-22000	0	11			
		Rs.22000-37000	2	11			
		Rs.37000-50,000	0	1			
5	Marital Status	Married	8	62	0.271	3	0.965
		Unmarried	2	16			
		Divorced	0	2			
		Widowed	1	9			
6	Education	Primary education	5	53	4.175	4	0.383
		Secondary education	2	12			
		Diploma	0	5			
		Undergraduate	2	15			
		Postgraduate	2	4			
7	Occupation	Professionals	3	17	6.341	5	0.274
		Technicians	2	9			
		Skilled workers and Market sales worker	2	23			
		Skilled agricultural and Fishery worker	2	19			
		Elementary occupation	0	17			
		Unemployed	2	4			
8	Area of living	Urban	4	46	0.919	1	0.338
		Rural	7	43			
9	No.of times hospitalized	Only once	7	51	6.949	3	0.074
		Twice	1	21			
		3 times	0	11			
		> 3 times	3	6			
10	No.of days hospitalized	1 week	9	60	1.601	3	0.659
		2 week	1	19			
		3 week	1	6			
		> 3 week	0	4			

\*Significant at 5% level \*\*-Significant at 1% level

Communication skills of health professionals play a pivotal role in ensuring patients feel valued and taken care of. Allocating sufficient time to speak and listen to patients and providing information is a prerequisite for patient satisfaction, as it ensures patients are less stressed and more engaged and well-adjusted. The study's first aim of evaluating the perception of nursing care among patients at SRM General Hospital. The result revealed that 89 percent of patients receive high-quality nursing care, 11 percent of patients receive good quality nursing care and 0 percent receive low-quality care. Khan et al., 2007 conducted a study on patient satisfaction with Henderson's basic model of nursing aid regarding medical aid. The study did not hide the fact that forty-fifth patients were happy about the quality of nursing aid and fifty-five were partially unhappy about the quality of medical aid and ninth patients didn't feel like talking to a worker nurse<sup>9</sup>.

The study's second aim to link the perception of nursing care among patients with their selected demographic variables. No significant association exists between the opinion regarding nursing quality and patient demographic variables ( $p < 0.055$ ). Lumby (2005) conducted a study with a valid form, four hundredth of the population, on patient satisfaction with medical aid. According to the current study, eighty-four patients were happy with nursing aid and fifty-four patients did not feel comfortable talking to nurses. Patients' full age, sex, and educational levels had no significant influence on patient satisfaction in this study. Lots of sample size required to validate<sup>10</sup>.

### Conclusion

The results showed that 89% of high-quality care, 11% good quality nursing care and 0% low-quality nursing care. Nurses should inform patients about each application and procedure, and provide the necessary explanations about disease, diagnosis, and treatment to ensure patient satisfaction and quality nursing care.

**Acknowledgements:** We would like to thank the management, principal, superintendent of nursing and staff at the hospital concerned for their cooperation and support.

**Authors' Contributions:** I wish to express my heartfelt gratitude to the participants who have given willingness to take part in the study.

**Conflicts of Interest:** No conflicts of interest exist.

**Authors' Funding:** Self.

### References

1. Alsaqri, S. Patient satisfaction with the quality of nursing care at governmental hospitals, Ha'il City, Saudi Arabia. *Journal of Biology, Agriculture and Healthcare*, 2016;6(10), 128– 142. Google Scholar.
2. Törnvall E, Wilhelmsson S. Quality of nursing care from the perspective of patients with leg ulcers. *J Wound Care*. 2010;19: 388-395. [Crossref]
3. Zhao SH, Akkadechanunt T, Xue XL. Quality nursing care as perceived by nurses and patients in a Chinese hospital. *J Clin Nurs*. 2009;18: 1722-1728. [Crossref]
4. Goh, M. I., Ang, E. N. K., Chan, Y. H., He, H. G., & Vehviläinen-Julkunen, K. A descriptive quantitative study on multi-ethnic patient satisfaction with nursing care measured by the revised humane caring scale. *Applied Nursing Research*, 2016;31, 126–131. <https://doi.org/10.1016/j.apnr.2016.02.002> Crossref PubMed Web of Science@Google Scholar
5. Akın, S., & Erdoğan, S. The Turkish version of the Newcastle satisfaction with nursing care scale used on medical and surgical patients. *Journal of Clinical Nursing*, 2007; 16, 646– 653. <https://doi.org/10.1111/j.1365-2702.2006.01583.x>Wiley Online Library CAS PubMed Web of Science@Google Scholar
6. Suhonen R, Papastavrou E, Efstathiou G, Tsangari H, Jarosova D, Leino-Kilpi H, Patiraki E, Karlo C, Balogh Z, Merkouris A. Patient satisfaction as an outcome of individualized nursing care. *Scand J Caring Sci*. 2012;26(2):372–380. DOI: 10.1111/j.1471-6712.2011.00943.x. [PubMed] [CrossRef] [Google Scholar]
7. Varkey P, Reller MK, Resar RK. Basics of quality improvement in health care. *Mayo Clin Proc*. 2007;82:7359. DOI: 10.1016/S0025-6196(11)61194-4. [PubMed] [CrossRef] [Google Scholar].
8. Laschinger. Psychometric Analysis of Patient Satisfaction With Nursing Care Quality Questionnaire: An Actionable Approach to Measuring Patient Satisfaction, *Journal of Nursing Care Quality*. 2005; 20 (3), 220-230.
9. Khan et al. Patient Satisfaction with Nursing Care. *Rawal Medical Journal*: 2007; Vol.32, No.1, Jan.-June.
10. Lumby, J. Patient satisfaction with nursing care in a colorectal surgical population, *International Journal of Nursing Practice*, 2005; 6(3), 140-145, 2005.

# Spectrum of Clinical and Hematological Changes in Patients of Malaria: A Tertiary Care Hospital Experience in Gujarat

Trupti R. Jansari<sup>1</sup>, Jigna P. Patel<sup>1</sup>, Amit Chauhan<sup>2</sup>, Jasmin Jasani<sup>3</sup>

<sup>1</sup>Assistant Professor, Department of Pathology, Smt BK Shah Medical Institute & Research Centre, Sumandeep Vidyapeeth an institution deemed to be University Piparia 391760 Vadodara Gujarat, <sup>2</sup>Associate Professor, Department of Anesthesia, Smt BK Shah Medical Institute & Research Centre, Sumandeep Vidyapeeth an institution deemed to be University Piparia 391760 Vadodara Gujarat, <sup>3</sup>Professor, Department of Pathology, Smt BK Shah Medical Institute & Research Centre, Sumandeep Vidyapeeth an institution deemed to be University Piparia 391760 Vadodara Gujarat.

## Abstract

**Background:** One of the most common infections caused by protozoa in India is malaria. Malaria cases have different geographic distribution in different areas. So it is important that hospitals in different areas draw their own set of data regarding clinical and hematological characteristics of malaria. The present study was conducted to evaluate the spectrum of clinical and hematological changes in patients of malaria.

**Material and method:** We conducted retrospective study at Pathology department, Sumandeepvidyapeeth, with 55 patients aged between 5 to 75 years.

**Results:** Out of 55, 40 were males and 15 were females. PV constituted majority of the cases, followed by PF. We reported anemia in 34 of malaria cases. Maximum cases of anemia was seen in PF. Thrombocytopenia was seen in 42 of malaria cases. Maximum cases was seen in PV. Leucocyte count was within reference range in majority of our cases 42.

**Conclusion:** Fever with rigors and chills, headache and splenomegaly are the most common clinical alteration and anemia and thrombocytopenia are most common hematological alteration in cases of malaria. Presence of these classic picture in a patient ever, helps diagnosing malaria at the earlier stages. In that way, early treatment can be introduced.

**Keywords:** Anemia, Fever, Malaria, Plasmodium falciparum, Thrombocytopenia.

## Introduction

One of the most common infections caused by protozoa in India is malaria. There are five different species of plasmodium (P.) that are responsible for malaria

infection in humans. These are Plasmodium falciparum (PF), Plasmodium vivax (PV), Plasmodium ovale, Plasmodium malariae and Plasmodium knowlesi. A bite from infected female Anopheles type of mosquito is the main route of transmission. Other routes are via blood transfusion, marrow transplants and across the placenta. Causative agent of severe and complicated malaria is usually PF. Other species causes usually mild disease. [1] Although there is continuous ongoing work to decrease the number of cases by various means, malaria still remains the most common protozoan infection in developing countries. [2] World health organization report states that 6% of the cases all over the world are detected in India. [3]

---

### Corresponding Author:

**Dr. Jigna P Patel**

Assistant Professor, Department of Pathology, Smt BK Shah Medical Institute & Research Centre, Sumandeep Vidyapeeth an Institution Deemed to be University Piparia 391760 Vadodara Gujarat  
e-mail: creativity.art.j@gmail.com  
Mobile No.: +91-9727079195

Most common clinical features of malaria are fever which is intermittent and high grade in nature, rigors and chills, headache, nausea and vomiting.<sup>[4]</sup> There are certain characteristic hematological changes that are attributed to malaria and commonly seen among malaria patients. Some of the common findings are anemia, thrombocytopenia, leucopenia and splenomegaly. <sup>[5-7]</sup> The present study was carried out to have insight into the clinical and hematological spectrum of changes in patients of malaria in Gujarat.

### Material and Method

We conducted this retrospective study at Hematologylaboratory, Pathology department, Sumandeepvidyapeeth, Vadodara. We included total 55 patients aged between 5 to 75 years with either gender. Details regarding demographic, clinical and laboratory investigations of each patients were noted. Patients below 5 years and more than 75 years were excluded from the study. Two mililitres blood was collected in EDTA vaccuttee and processed oncell counter SYSMEX KX-21. All hematological report details were noted. We prepared blood films for both thick and thin smears as per the standard protocols and were processed further with giemsa stain and leishman cytochrome stain. A positive diagnosis of malaria was confirmed by pathologist after examination of thick and thin smear. Malaria species identification was done for different species. We called the patient has an anemia when the hemoglobin (Hb) was less than 13g/dl in a male patient and less than 12 g/dl in a female patient. Thrombocytopenia was diagnosed when the platelet count was less than 1.5 lacs/cumm. Leucopenia and leucocytosis when total leucocyte count(TLC) was less than 4000 cells/cumm and more than 11000 cells/cumm respectively. We used Epi info software for calculating various statistics.

### Results

We conducted this retrospective study at Hematologylaboratory, Pathology department, Sumandeepvidyapeeth, Vadodara. We included total 55 patients aged between 5 to 75 years with either gender. Details regarding demographic, clinical and laboratory investigations of each patients were noted.

There were total 55 cases of malaria, 40(72.7%) were males and 15(27.3%) were females. We found male preponderance of the disease. (Table – 1) Male to female ratio in our study was found to be 2.6:1.

**Table 1. Gender wise distribution of the cases**

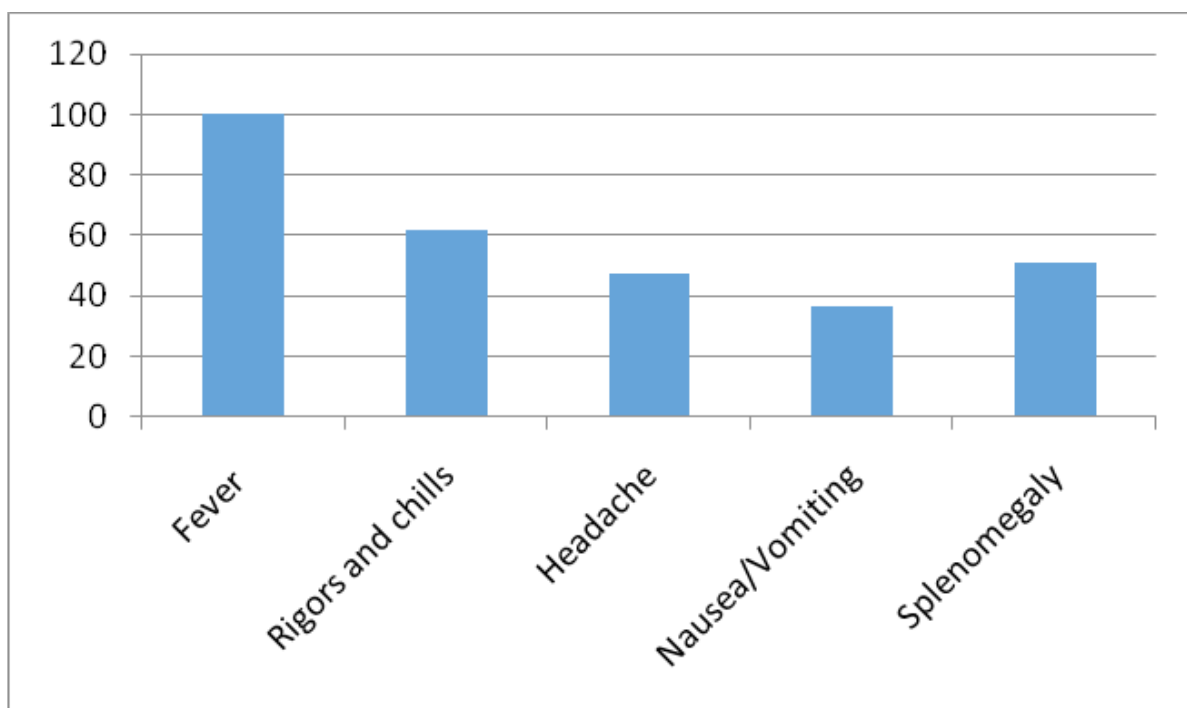
Gender	Cases	Percentage (%)
Male	40	72.7
Female	15	27.3
<b>Total</b>	<b>55</b>	<b>100</b>

We divided the cases into 3 groups as per species identification. (Table – 2) Highest numbers were of PV 41(74.5%), followed by PF 12(21.8%) and mixed infection 2 (3.6%) type.

**Table 2. Distribution of cases as per the malaria species identification**

Malaria Species	No of Cases	Percentage
P. Falciparum	12	21.8%
P. Vivax	41	74.5%
Mixed Infection	02	3.6%
<b>Total</b>	<b>55</b>	<b>100%</b>

We evaluated clinical data of all the cases of malaria. Fever was seen in all the cases 55(100%). Apart from fever, the most common clinical features were rigors and chills 34(61.8%) followed by headache 26(47.2%), nausea and vomiting 20(36.3%) and splenomegaly 28(50.9%) (Figure 1).



**Figure 1. Distribution of cases as per the clinical features**

We found anemia in 34(61.8%) of malaria cases. Other 21(38.2%) cases had normal hemoglobin levels. Out of these 34 cases maximum cases of anemia was seen in PF 11(91.6%), followed by PV 22(53.6%) and mixed infection 01(50%). (Table 3).

**Table 3. Distribution of anemia cases in different types of malaria**

Type of Malaria	Cases with Anemia	Cases With Normal Hemoglobin	Total
P. Falciparum	11(91.6%)	01(8.3%)	12(21.8%)
P. Vivax	22(53.6%)	19(46.3%)	41(74.5%)
Mixed Infction	01(50%)	01(50%)	2 (3.6%)
<b>Total</b>	<b>34(61.8%)</b>	<b>21(38.2%)</b>	<b>55(100%)</b>

We found thrombocytopenia in 42(76.4%) of malaria cases. Other 13(23.6%) cases had normal platelet counts. Out of these 42 cases maximum cases of thrombocytopenia was seen in PV 31(75.6%), followed by PF 9(75%) and mixed infection 0(0%). (Table 4).

**Table 4. Distribution of thrombocytopenia cases in different types of malaria**

Type of Malaria	Cases with Thrombocytopenia	Cases With Normal Platelet Count	Total
P. Falciparum	9(75%)	03(25%)	12(21.8%)
P. Vivax	31(75.6%)	10(24.3%)	41(74.5%)
Mixed Infction	0(0%)	02(100%)	2 (3.6%)
<b>Total</b>	<b>42(76.4%)</b>	<b>13(23.6%)</b>	<b>55(100%)</b>

In our study, maximum cases had leucocyte count within normal reference range e.g 42(76.4%). Leucocytosis was present in 8(14.5%) and leucopenia in 5(9.1%) cases. Out of these, PF showed higher number of leucocytosi (8.3%), while PV showed higher cases of leucopenia, while both the cases of mixed infection showed normal TLC. (Table 5).

**Table 5. Distribution of leucocytosis and leucopenia cases in different types of malaria**

Type of Malaria	Cases with Leucocytosis	Cases With Leucopenia	Cases With Normal Tlc	Total
P. Falciparum	1(8.3%)	1(8.3%)	10(83.3%)	12(21.8%)
P. Vivax	1(2.4%)	4(9.8%)	36(87.8%)	41(74.5%)
Mixed Infction	0(0%)	0(0%)	02(100%)	2 (3.6%)
Total	8(14.5%)	5(9.1%)	42(76.4%).	55(100%)

## Discussion

The present retrospective study included total 55 patients with age ranging from 5 years to 75 years. There was male preponderance in our study with male to female ratio of 2.6:1. This finding was comparable with many other studies carried out previously [4, 8-9] This can be due to increased exposure to males attributed to their more outdoor work as compared to females in some areas. In this study, there was maximum number of cases of PV type of malaria. Many other studies also showed the similar findings. [8-10]

In our study, fever was seen in all cases 55(100%). Apart from fever, the most common clinical features were rigors and chills 34(61.8%) followed by headache 26(47.2%), nausea and vomiting 20(36.3%) and splenomegaly 28(50.9%). These findings were comparable to the study done by Chaudry et al. [8]

The most frequent finding in malaria is anemia. It can result from combination of many etiological factors. Eg. Lysis of infected red blood cells, bone marrow inefficiency, splenomegaly etc. Total 34(61.8%) patients out of 55(100%) patients presented with anemia in our study. Whis is comparable to the previous literatures. [4] Study done by Chaudry et al., Awoke N et al. and Abro AH et al. showed maximum cases of anemia in PF cases as compared to other types of malaria. We found the similar results in our study. [8, 11-12]

Thrombocytopenia is very common hematological change that is seen in malaria. These can be due to various reasons. Eg. immunological mechanism, splenomegaly, or bone marrow inefficiency. We found thrombocytopenia in 42(76.4%) of total malaria cases. These results are comparable to that of the studies done by Abro AH et al., Jojera et al and Haroon et al. [12-14] Our study showed maximum cases of thrombocytopenia in PV 31(75.6%) as compared to PF 9(75%) and mixed infection 0(0%). These findings were comparable to that of the study done by Chaudry et al. [8]

Majority of the cases in our study showed leucocyte count within normal reference range e.g 42(76.4%). Leucocytosis was present in 8(14.5%) and leucopenia in 5(9.1%) cases. These findings are similar to previous published literature. [4, 8-9] Leucopenia in malaria can be attributed to various theories e.g. immune mediated, low cell life, cell migration, increased inflammation, sequestration, bone marrow inefficiency etc. Study done by Abro AH et al. showed leucopenia to be more associated with PV than PF cases. We found the similar results in our study. [12]

## Conclusion

High prevalence of malaria indicates importance of its timely diagnosis and treatment. Presence of classic clinical and hematological picture in a patient with fever, helps diagnosing malaria at the earlier stages. In that way, early treatment can be introduced and mortality occurring as a consequence of complicated cases on long run can be prevented.

**Ethical Clearance:** Ethical clearance was taken from SBKS & MIRC

**Source of Funding:** Self

**Conflict of Interest:** Nil

## References

1. Bates I, Ekem I. Haematological aspects of tropical diseases. In: Hoffbrand AV, Catovsky D, Tuddenham EGD, editors. Postgraduate Haematology. Massachusetts: Blackwell Publishing; 2005. p. 979-85.
2. WHO. World Health Director General's Report. Fighting disease, fostering development. Geneva: WHO, 1996.
3. World malaria report 2017. Geneva: World Health Organization; 2017.
4. Bashawri LAM, Mandil AA, Bahnassy AA, Ahmed

- MA. Malaria: hematological aspects. *Ann Saudi Med* 2002; 22:372-7.
5. Facer CA. Hematological aspects of malaria. In: *Infection and Hematology*. Oxford: Butterworth Heinmann Ltd., 1994:259-94.
  6. Perrin LH, Mackey LJ, Miescher PA. The hematology of malaria in man. *Sem Hematol* 1982; 19:70-81.
  7. McKenzie FE, Prudhomme W, Magill A, et al. White blood cell counts and malaria. *J Infect Dis*. 2005; 192:323-30.
  8. Chaudry JZ, Mahmood K, Hussain MA, Tahirkheli MUI. Spectrum of Clinical and Haematological Findings in Malaria. *Gomal J Med Sci* 2015; 13:100-3.
  9. Shah N, Sinha R. A descriptive study of hematological characteristics of malaria patients attending a tertiary care hospital in the region of kutch. *APALM*; Vol – 6, Issue 10, Oct 2019, pg 531-536.
  10. Gupta NK, Bansal SB, Jain UC, Sahare K. Study of thrombocytopenia in patients of malaria. *Tropical Parasitology*. 2013; 3:58-61.
  11. Awoke N, Arota A. Profiles of hematological parameters in Plasmodium falciparum and Plasmodium vivax malaria patients attending Tercha General Hospital, Dawuro Zone, South Ethiopia.
  12. Abro AH, Ustadi AM, Younis NJ, Abdou AS, Hamed DA. Malaria and hematological changes. *Pak J Med Sci*. 2008; 24:287-91.
  13. Jojera AS, Hathila RN, Patel PR, Tailor HJ. Changes in WBC and platelet count in patients with malaria: a hospital based comparative study. *Int J Res Med Sci* 2013; 1(4):401-3.
  14. Haroon H, Fazel PA, Naeem M, Mobin A, Naqvi AH, Makki K. Hide and seek: hematological aspects of malaria – a developing country perspective. *J Infect Dev Ctries* 2013; 7:273-9.



# Relationship of Knowledge and Attitudes with Male Participation in Vasectomy in Indonesia

Tjahja Bintoro<sup>1</sup>, Bhisma Murti<sup>2</sup>, Endang Sutisna<sup>2</sup>, Suwarto<sup>3</sup>

<sup>1</sup>Doctoral Student, Universitas Sebelas Maret, Solo, Indonesia, <sup>2</sup>Professor Public Health Department, Universitas Sebelas Maret, Solo, Indonesia, <sup>3</sup>Professor Agriculture Department, Universitas Sebelas Maret, Solo, Indonesia

## Abstract

Family planning is an effort to control the birth of children, the ideal space and age for childbirth, pregnancy control, through promotion, protection, and assistance in accordance with reproductive rights to form a quality family. Vasectomy, or vas occlusion, is considered to be the most effective and very popular form of contraception. This study aims to analyze the relationship between knowledge and attitudes with vasectomy participation in men. This study used a cross-sectional approach. The research location is in Madiun City, East Java, Indonesia. The total sample in this study was 323 respondents. The variables in the study were knowledge, attitudes, and participation in vasectomy family planning. There is a relationship between knowledge and attitudes about vasectomy with male participation in vasectomy.

**Keywords:** Attitude, family planning, knowledge, vasectomy.

## Introduction

In 2020-2030 Indonesia has the opportunity to experience a demographic bonus. The country of Indonesia will have around 180 million people of productive age, while those who are not productive will reduce to 60 million people. This means that 10 people of productive age will bear 3-4 people of non-productive age<sup>(1)</sup>. One of the efforts to control the population growth rate is by using a family planning program. Family planning is a government program to improve the quality of life in Indonesia. KB is an effort to control the birth of a child, the ideal space and age for childbirth, control of pregnancy, through promotion, protection, and assistance in accordance with reproductive rights to form a quality family<sup>(2)</sup>.

The male participation rate in using contraceptives in Indonesia is still very low, namely, only 2.1% of male family planning participants, and they generally use condoms. This percentage is lower when compared to other countries, such as Iran (12%), Tunisia (16%), Malaysia (9-11%), even in the United States it reached 32%. Very few men want to use contraceptives, either condoms or vasectomy. Of the total number of family planning acceptors in Indonesia, around 97% are women. Therefore, the socialization of family planning programs among men must be increased<sup>(3)</sup>.

Vasectomy, or vas occlusion, is considered to be the most effective form of contraception and is very popular in many developed and developing countries. For men who don't want more children, a vasectomy offers several benefits: effectiveness, quick and simple procedure, permanent protection, convenience, low risk of complications, no long-term effects on his health or sexual performance, and no health risks to his wife<sup>(4)</sup>. One of the important evaluations in the application of the family planning method is the knowledge, attitudes, motivation, and behavior of the community. This study aims to analyze the relationship between knowledge and attitudes with vasectomy participation in men.

---

### Corresponding Address:

**TjahjaBintoro**

P.O. Box: 57126. Doctoral student, Universitas Sebelas Maret, Ir. Sutami Street No. 36, Solo, Central Java, Indonesia

e-mail: btjahja34@student.uns.ac.id

Phone Number: +6281239870268

## Method

This study used a cross-sectional approach. The research location is in Madiun City, East Java, Indonesia. The sampling method used for the case group and the control group was fixed disease sampling, which is a sampling scheme based on the subject's disease status, that is, diseased or not having the disease under study, while the subject's exposure status varies according to the subject's disease status. The number of estimates for the case group and the control group used a ratio of 1: 3 in each case. The case group in this study were

husbands who were willing to accept vasectomy as many as 85 respondents, while for the control group were taken from husbands who did not use vasectomy as many as 238 respondents. The total sample in this study was 323 respondents. The variables in the study were knowledge, attitudes, and participation in vasectomy family planning. The data was tabulated in terms of the frequency distribution of different variables. A Chi-square test of significance was employed for testing associations.  $P < 0.005$  was considered for statistical significance. The study was approved by the Institutional Ethics Committee.

## Results

**Table 1: Respondent characteristics**

Respondent characteristics	Vasectomy (n=85)	Non-Vasectomy (n=238)
<b>Religion</b>		
Islam	83 (98%)	229 (96%)
Christian	2 (2%)	9 (4%)
Age (mean)	49 Tahun	42 Tahun
Age of married husband (mean)	26 Tahun	27 Tahun
Wife's age (mean)	42 Tahun	39 Tahun
<b>Education Level</b>		
No school	0 (0%)	2 (1%)
Primary school	7 (8%)	12 (5%)
Junior high school	25 (29%)	32 (13%)
High school	46 (55%)	166 (70%)
Higher education	7 (8%)	26 (11%)
<b>Employment</b>		
Civil servants	5 (6%)	16 (7%)
Private employees	32 (38%)	64 (27%)
Labor	27 (32%)	50 (21%)
Farmer	3 (4%)	5 (2%)
Driver	2 (2%)	11 (5%)
Etc	16 (19%)	92 (39%)
<b>Source of information related to family planning</b>		
Family planning volunteer	49 (58%)	105 (44%)
Health workers	35 (41%)	126 (53%)
Family member	1 (1%)	5 (2%)
Print media	0 (0%)	2 (1%)

Table 1 describes the characteristics of the research respondents divided into 2 (two) groups, namely respondents who used vasectomy and did not use vasectomy. The mean age of vasectomy respondents was 49 years and 42 years of non-vasectomy. The mean age of the respondents at marriage was 26 years (vasectomy) and 27 years (non-vasectomy). The mean age of the respondents' wives was 42 years (vasectomy) and 39 years (non-vasectomy). Half of the vasectomy

(55%) and non-vasectomy (70%) respondents had a high school education level. Nearly half of vasectomy (38%) and non-vasectomy (39%) respondents have jobs as private employees and others such as: having their own business. Most of the vasectomy (58%) and non-vasectomy (53%) respondents received information related to family planning from family planning cadres and health workers.

**Table 2 Relationship of knowledge and attitude with vasectomy participation**

Variable Characteristics	Vasectomy (n=85)	Non- Vasectomy (n=238)	P
<b>Knowledge about vasectomy</b>			
Less	53 (62%)	127 (53%)	0.01
Enough	26 (31%)	58 (24%)	
Well	6 (7%)	53 (22%)	
<b>Attitudes towards vasectomy family planning</b>			
Positive	0 (0%)	5 (2%)	0.00
Negative	85 (100%)	233 (98%)	

Table 2 shows 62% of men with vasectomy have insufficient knowledge of vasectomy, only 7% of men with vasectomy have good knowledge. The same thing was also found in non-vasectomy men, 53% had less knowledge about vasectomy and 22% had good knowledge. 100% of men with vasectomy and 98% of men without vasectomy have a negative attitude towards vasectomy. Knowledge about vasectomy and attitudes towards vasectomy have a relationship with male participation in vasectomy.

**Discussion**

The study found that respondents' level of knowledge about vasectomy is at a low level. This may be due to a large number of respondents with junior and senior high school education. The vasectomy method is usually used by men who have a good level of education (5). The results of a study in Taiwan showed that men who chose vasectomy had higher education (68.5% had a bachelor's degree)(6).

A person with higher education means that information is easier to transfer and receive, and ultimately more knowledge is acquired. Conversely, if the level of education is low, it will hinder the

development of one's attitude in receiving information and the newly introduced values. However, the number of non-vasectomy respondents was more than the respondents who actively participated using vasectomy and there were still some respondents who had good knowledge but did not participate in vasectomy. This means that the level of knowledge does not guarantee that someone will take an action or show any kind of healthy behavior.

A person with higher education means that information is easier to transfer and receive, and ultimately more knowledge is acquired. Conversely, if the level of education is low, it will hinder the development of one's attitude in receiving information and the newly introduced values. However, the number of non-vasectomy respondents was more than the respondents who actively participated using vasectomy and there were still some respondents who had good knowledge but did not participate in vasectomy. This means that the level of knowledge does not guarantee that someone will take an action or show any kind of healthy behavior(7).

The results of the research on the frequency distribution of attitudes towards the choice of vasectomy

show that more respondents are negative than positive. Attitude towards vasectomy is determined by the respondent's voice for the vasectomy itself. Negative attitudes arise from negative beliefs. Respondents who have negative attitudes use non-vasectomy more than a vasectomy. Attitude is a reaction or response that is still closed from a stimulus or object. The components that are built into attitudes are 1) beliefs (beliefs), ideas and concepts, towards an object; 2) emotional life or evaluation of an object; 3) propensity to act. Thus, a person's belief or belief about an object affects the action to be performed<sup>(7)</sup>.

The attitude analysis related to the choice of vasectomy shows that there are respondents who have a positive attitude but do not use vasectomy, and there are respondents who have a negative attitude but participate actively in vasectomy. There are two kinds of community participation method, namely participation in a coercive way to force the community to contribute to the program (through laws and regulations, regulations, or oral orders), then second, participation through persuasion and education. Positive beliefs will form a positive attitude. Furthermore, a positive attitude develops a person's tendency to act positively as well. If someone has negative beliefs or negative concepts, it will form a negative attitude which then makes it difficult to act positively<sup>(7)</sup>.

### Conclusion

There is a relationship between knowledge and attitudes about vasectomy with male participation in vasectomy.

**Acknowledgment:** I would like to thank the respondents who participated.

**Conflict on Interest:** There is no conflict of interest to be declared

**Source of Funding:** None

**Ethical Clearance:** The study was approved by the Institute of Health Sciences Surya Mitra Husada

### References

1. Rizkitama AA, Indrawati F. Hubungan Pengetahuan, Persepsi, Sosial Budaya Dengan Peran Aktif Pria Dalam Vasektomi Di Kecamatan Paguyangan Kabupaten Brebes Tahun 2011-2012. *Unnes J Public Heal*. 2015;4(1):48–54.
2. Rahmawati D. Path Analysis on Factors Affecting the Willingness to Accept Vasectomy among Men in Sanden Community Health Center, Bantul, Yogyakarta, Indonesia. *J Heal Promot Behav*. 2016;01(01):26–31.
3. Sutinah S. Partisipasi laki-laki dalam program Keluarga Berencana di era masyarakat postmodern. *Masyarakat, Kebud dan Polit* [Internet]. 2017 Sep 20 [cited 2020 Aug 5];30(3):290. Available from: <https://e-journal.unair.ac.id/MKP/article/view/4116>
4. Ezegwui HU, Enwereji JO. Attitude of men in Nigeria to vasectomy. *Int Health* [Internet]. 2009 Dec [cited 2020 Oct 2];1(2):169–72. Available from: <https://pubmed.ncbi.nlm.nih.gov/24036562/>
5. Wespes E. Vasectomy in male contraception and its reversal [Internet]. Vol. 13, *European Urology, Supplements*. Elsevier B.V.; 2014 [cited 2020 Oct 2]. p. 68–72. Available from: <http://www.eu-openscience.europeanurology.com/article/S1569905614000190/fulltext>
6. Chang YH, Hsiao PJ, Chen GH, Chang CH, Chen WC, Yeh CC, et al. Economic fluctuation affects vasectomy utilization: A single-institution study. *Urol Sci*. 2015 Sep 1;26(3):214–7.
7. Yunitasari E, Pradanie R, Hardiansyah H. DETERMINANTS FACTORS OF VASECTOMY METHOD SELECTION. *J Ners* [Internet]. 2017 Jun 5 [cited 2020 Oct 2];12(1):33. Available from: <https://e-journal.unair.ac.id/JNERS/article/view/3785>

# Premarital Sex Behaviour of Adolescents in Makassar, Indonesia

Theresia Limbong<sup>1</sup>, Made Sukarta<sup>2</sup>

<sup>1</sup>Associate Professor, <sup>2</sup>Assistant Professor, Department of Midwifery, Health Polytechnic of Ministry of Health in Makassar, Indonesia

## Abstract

Based on projections of the National Development Planning Agency (Bappenas) the number of population Indonesia in 2018 reached 265 million people. The number consists of 133,17 million men and 131,88 million women and 44,10 million are teenagers. The population data in South Sulawesi in 2018 was 8,771,970 people and in 2015 the population of South Sulawesi was 8,520 million people and 1,56 million people were teenagers. Adolescent sexual behavior, especially premarital sexual behavior, still dominates the debate in terms of moral, psychological, and physical. Premarital sex in adolescents is a serious problem because it relates to the low use of contraception and adolescents tend to have more sexual partners if they start having premarital sex at an earlier age. This article aims to find out knowledge, attitudes, actions of premarital sexual behavior and its relationship with the environment promiscuity in adolescents in Makassar, Indonesia. This research is an observational analytic study with cross-sectional study design. The time used in this study is 8 months. The location of the study will be conducted in high school students 17 & 19 in Makassar, one of the Metropolitan cities in Indonesia. The population in this study is high school students 17 & 19 in Makassar City as many as 200 students. In this study, researchers used the proportionate random sampling method, a sample consists of 134 students. The analysis used in the study was the Chi-Square test. This study results that there was a significant relationship between premarital sex knowledge with a social circle of friends with p-value = 0.029 and also a significant relationship between knowledge with a place to hang out with p-value = 0.009. There was a significant relationship between premarital sex attitudes with the social environment of friends with p-value = 0.034 and there was also a significant relationship between attitudes with the place to hang out with p-value = 0.020. There is a significant relationship between premarital sex behavior with the community's social environment with p-value = 0.003.

**Keywords:** *Premarital sex, Social environment, Adolescents.*

## Introduction

The population number of Indonesia in 2018 reached 265 million people. The number consists of 133,17 million men and 131,88 million women and 44,10 million are teenagers. The population data in South

Sulawesi in 2018 was 8,771,970 people and in 2015 the population of South Sulawesi was 8,520 million people and 1,56 million people were teenagers.<sup>1</sup>

Adolescence is a rapid period of growth and development both physically, psychologically, and intellectually. This is influenced by the maturation of the hormonal system in adolescents, changes in height, weight, and body development of adolescents who show signs of puberty developing rapidly. The age limit for unmarried adolescent boys or girls aged 15 to 24 years. The need for improved health and social services for adolescents is increasingly becoming a worldwide concern since the International Conference on Population and Development (ICPD) in Cairo Egypt

---

### Corresponding Author:

**M. Askar**

Researcher in the Center of Excellent on Urban Health of Health Polytechnic of Makassar, Jl. Banta-Bantaeng No. 46, Makassar, South Sulawesi, Indonesia. 90222  
e-mail: askar@poltekkes-mks.ac.id  
Mobile No.: 085299947722

in 1994. The conference agreed on a paradigm shift in the management of population and development issues from an approach to population control and fertility reduction to an approach focused on reproductive health and efforts to fulfill reproductive rights.<sup>2</sup>

Adolescent sexual behavior, especially premarital sexual behavior, still dominates the debate in terms of moral, psychological, and physical. Premarital sex in adolescents is a serious problem because it relates to the low use of contraception and adolescents tend to have more sexual partners if they start having premarital sex at an earlier age.<sup>3</sup> Unsafe sex is the second most important risk factor for the emergence of disability and death in poor countries, as well as the 9th most important risk factor in developed countries.<sup>4</sup> Premarital sex in adolescents experienced an increase during the 20th century. The age of adolescents starting to have premarital sex varies from country to country, ranging from 12-17.5 years and on average starting at the age of 15 years.<sup>5</sup>

Previous studies in Indonesia on adolescent premarital sexual behavior obtained results about 25-51% of adolescents had premarital sex.<sup>6</sup> The results of the Indonesian Adolescent Reproductive Health Survey (SKRRI) in 2007 showed 6.4% of adolescent boys and 1.3% of adolescent girls have had premarital sex. Studies in Bali obtained the results of adolescent boys in high school and in junior high school more who had premarital sex (40.3% and 29.4%) compared to adolescent girls (3.6% and 12.5%). Male adolescents in Bali are more permissive towards premarital sexual behavior compared to adolescent girls and about 5% of adolescents have had premarital sex.<sup>7</sup>

Issues that are still being debated to date include the primary motivation of adolescents to initiate premarital sex at an earlier age in addition to the link between limited sources of sexual information and adolescent sexual behavior.<sup>8</sup> The previous research showed premarital sex behavior caused by continuous stimulation through sexual material in print media, the internet, and through peers.<sup>6</sup> Based on the Theory of Planned Behavior, Social Learning Theory, Diffusion of Innovation Theory, and Ideation Model, peers play an important role as the main determinant of behavior.

Adolescents who communicate with friends about sex tend to increase the incidence of premarital sex initiation among adolescents aged 14-16 years in

Philadelphia.<sup>9</sup> Therefore it is essential to understand the influence of knowledge, attitude, and premarital sexual behavior and their relationship with social associating of adolescents in Makassar, Indonesia.

## Materials and Method

This study was an observational analytic study with a cross-sectional study design to develop a model for controlling psychosocial development problems in adolescents in Makassar City. The time used in this study was 8 months. The location of the study conducted in high school students 17 & 19 in Makassar City. The population in this study was high school students 17 & 19 in Makassar City as many as 200 students. In this study, researchers used the proportionate random sampling method, with the Slovin sampling formula, which was sampling in the population by taking into account the strata or levels that exist and the number of samples as many as 134 people. The instrument used was a questionnaire to measure students' knowledge, attitudes, and actions toward premarital sexual behavior. Univariate analysis was conducted to get a general description of the research problem by describing each variable used in this study, namely by looking at the frequency distribution and percentage of each independent variable (Knowledge, Attitudes and Actions of premarital sex behavior) and the dependent variable (social environment) desired from the distribution table. Bivariate analysis was performed to see the relationship or correlation between the independent variable and the dependent variable. Data analysis was performed to determine the relationship of knowledge, attitudes, and actions towards the social environment by performing the Chi-Square test.

## Results

**Table 1: Results of Univariate Analysis for each Variable**

Variables	Respondents	
	Frequency	Percent (%)
<b>Knowledge</b>		
Good	85	63.4
Poor	49	36.6
<b>Attitude</b>		
Positive	73	54.5
Negative	61	45.5
<b>Action</b>		
Risky	87	64.9
No risk	47	35.1

The results of the study in Table 1 showed that the knowledge group of premarital sex behavior found in the good knowledge group of 85 people or 63.4%, while the group with the poor knowledge is was 49 people or 36.6%. Most attitudes toward premarital sex behavior were in the positive attitude group with 73 people or 54.5%, while the negative attitude group was the smallest in the amount of 61 people or 45.5%. the Action toward premarital sex behavior in the risky category as many as 87 people or 64.9%, while the group action with no risk was 47 people or 35.1%.

**Table 2: Results of Bivariate Analysis of Variables with Adolescents Association Environment in Makassar, Indonesia**

Variables	Social environment	p-value
Knowledge	Towards friends	0.029*
	Towards family	0.210
	On personality	0.720
	Towards sociable places	0.009*
	Against Social Media	0.723
	Against hobbies	0.723
	Towards the community	0.113
Attitude	Towards friends	0.034*
	Towards family	0.864
	On personality	0.092
	Towards sociable places	0.020*
	Against Social Media	0.605
	Against hobbies	0.603
	Towards the community	0.241
Action	Towards friends	0.203
	Towards family	0.206
	On personality	0.559
	Towards sociable places	0.197
	Against Social Media	0.473
	Against hobbies	0.468
	Towards the community	0.003*

\*Significantly at  $\alpha = 0.05$

Table 2 shows that the results of the analysis of knowledge of premarital sexual behavior with the social environment of friends using Chi-square obtained p-value= 0.029 ( $p < 0.05$ ), this means that  $H_0$  was rejected

and  $H_a$  was accepted. Then it could be interpreted that there was a relationship between knowledge of premarital sex behavior with the social environment of friends in High School students Makassar in 2019. The results of the analysis of knowledge of premarital sex behavior with the social environment of the place of association using Chi-square obtained  $p = 0.009$  ( $p < 0, 05$ ), this means that  $H_0$  was rejected and  $H_a$  was accepted. Then it could be interpreted that there was a relationship between knowledge of premarital sexual behavior with the social environment of the place to hang out in High School students Makassar in 2019. While the results of the analysis of knowledge of premarital sexual behavior with the social environment of the family, personality, social media, hobbies, and communities have p-value  $> 0.005$ . this means that  $H_0$  was accepted and  $H_a$  was rejected. So it could be interpreted that there was no relationship between knowledge of premarital sex behavior with the social environment of family, personality, social media, hobbies, and communities in High School students Makassar in 2019.

The results of the analysis of premarital sex attitudes with the social environment towards friends using Chi-square obtained  $p = 0.034$  ( $p < 0.05$ ), this means that  $H_0$  was rejected and  $H_a$  was accepted. Then it could be interpreted that there was a relationship between premarital sexual behavior attitudes with the social environment of friends in High School students Makassar in 2019. The results of the analysis of premarital sexual behavior attitudes with the social environment towards the place of association using Chi-square obtained  $p = 0.020$  ( $p < 0.05$ ), this means that  $H_0$  was rejected and  $H_a$  was accepted. Then it could be interpreted that there was a relationship between premarital sexual behavior with the social environment of the place to hang out in Makassar City High School students in 2019. While the results of the analysis of premarital sexual behavior attitudes with the family environment, personality, social media, hobbies, and communities had p-value  $> 0.05$ . this means that  $H_0$  was accepted and  $H_a$  was rejected. Then it could be interpreted that there was no relationship between premarital sexual behavior attitudes with the social environment of family, personality, social media, hobbies, and communities in High School students Makassar in 2019.

The results of the analysis of premarital sexual behavior with the social environment of the community by using Chi-square obtained  $p = 0.003$  ( $p < 0.05$ ), this means that  $H_0$  was rejected and  $H_a$  was accepted. Then

it could be interpreted that there was a relationship between acts of premarital sexual behavior with the social environment of the community in High School students Makassar in 2019. While the results of the analysis of premarital sexual behavior with the social environment of friends, family, personality, hangout, social media, and hobbies had  $p\text{-value} > 0.05$ . This means that  $H_0$  was accepted and  $H_a$  was rejected. Then it could be interpreted that there was no relationship between premarital sexual behavior with the social environment of friends, family, personality, social, social media, and hobbies among students in High school Makassar in 2019.

## Discussion

### **Relationship of Knowledge of Premarital Sex Behavior with Friends and Social Relationships:**

Behavior is a mental state or thinking and so on from someone to respond to situations outside the subject. These responses are two kinds that are active (with action) and passive (without action). Sex in Latin is *sexus*, which refers to the genitals. Sex only has an understanding of gender, anatomy, and physiology, whereas Sexual is something that related to sex and reproduction also associated with the pleasure associated with reproductive actions.<sup>10</sup>

Sexual behavior can be defined as a form of behavior that is driven by sexual desire with the opposite sex or the same sex. According to Simkin, sexual behavior is any behavior that is driven by sexual desire with the opposite sex and with the same sex. This form of behavior varies from feelings of attraction to dating behavior, making out and having sex.<sup>11</sup>

Statistical test results using the Chi-Square test showed a relationship of knowledge about Premarital Sex Behavior with a social environment towards friends with a  $p\text{-value} = 0.029$  ( $< 0.005$ ) and the relationship of knowledge with the social environment to a social setting that was 0.009 means that there was a significant relationship between knowledge with the social environment towards friends and traveling environment to the place to hang out.

Knowledge is the result of knowing, and this happens after people sensing a certain object.<sup>12</sup> Good knowledge is supported by a good level of parental knowledge in providing information about premarital sex.<sup>13</sup> Half-knowledge is more dangerous than not knowing at all. The formation of knowledge itself is influenced by

internal factors, namely the way individuals respond to that knowledge and externally which is a stimulus to change that knowledge for the better. Good knowledge is that respondents understand and understand about premarital sex.<sup>14</sup>

**Relationship between Attitudes toward Premarital Sex Behavior with Friends and Social Relationships:** Pre-marital sexual attitudes of adolescents are influenced by many things, apart from knowledge factors are also influenced by cultural factors, other people considered important, mass media, personal experiences, educational institutions, religious institutions, and emotions from within individuals. Adolescent premarital sexual attitudes can be positive or negative, the positive attitude of the action tendency is to support premarital sex while the negative attitude of the action tendency is to avoid adolescent premarital sex.<sup>15</sup>

Teenagers begin to prepare themselves for adult life, including in their sexual aspects. Thus it is necessary to have a wise attitude from parents, educators, and the community in general and of course the adolescents themselves, so that they can pass the transition period safely towards the hang out with  $p\text{-value} = 0.020$  ( $< 0.005$ ).

In adolescents, the influence of the environment in determining behavior is recognized as strong enough. Although adolescents have reached an adequate stage of cognitive development to determine their actions, adolescent self-determination in behavior is much influenced by pressure from peer groups.<sup>16</sup> It is not wrong if teenagers hang out with their peers, as long as their friends can make a positive contribution to the development of adolescents. It's just that there tends to be a problem if a teenager interacts with peers who have a free lifestyle and lack of parental supervision.

### **Relationship of Premarital Sex Acts with the Community Relationship Environment:**

Actions are rules that are carried out or hold rules to deal with something or an action. There is a close relationship between knowledge and attitude which is a tendency to act. Actions appear to be more consistent, harmonious, following the attitude when the individual's attitude is the same as the group's attitude, which he is part of or the group. This is following the theory of action that human actions arise from their consciousness as subjects and from external situations in positions as objects. As human subjects act or behave to achieve certain goals. Humans choose and evaluate the actions that will, are,



and have been done. Teenagers do actions based on purpose.

If it is associated with adolescent actions in premarital sex, it certainly will not be separated from what knowledge they have and how they are responding. It has been said before, that adolescents who have more knowledge about sex as a whole will be better able to control what will be done, the more teenagers get the knowledge about sexuality, the more careful they will be in their behavior and will have the ability to make decisions regarding their sexuality. Conversely, adolescents who lack understanding about sex will have sex before marriage without thinking. This knowledge is the beginning of someone in addressing and acting in premarital sex.

Based on these results because the actions of adolescents who engage in premarital sex, generally do negative things or things that lead to sexual deviations. According to Sarwono, this happened because of a shift in norms about sexual behavior among adolescents. Things that were considered taboo among adolescents in the 1950s such as kissing and joking are now even justified by today's teens. There is even a small percentage who agree on free sex. Not only that, but even many of them have also had sex. Teenagers who do this, are no longer lowering the views or opinions of society anymore.<sup>17</sup>

Based on the results of research that has been done, the relationship of adolescent actions has a significant relationship to the community's social environment. The social environment in this case the community is very influential on the actions of adolescents engaging in premarital sexual behavior because the strong influence of people around the community allows teens to commit deviant acts such as premarital sexual behavior. The impact of premarital sex on adolescent social life can be seen from the interaction of sex offenders premarital against others, as well as their educational conditions. This is consistent with statements regarding deviant behavior originating from subcultures or among deviant peers. Teenagers deviate because the social environment also deviates. Adolescents behave astray because they are more open with friends than with more mature people. The confirmation they received was wrong because they were looking for confirmation of the wrong person.<sup>18</sup>

### Conclusion

This study concludes that there was a significant relationship between premarital sex knowledge with

friends' social environment with p-value = 0.029 and also a significant relationship between knowledge and socializing with p-value = 0.009. There was a significant relationship between premarital sex attitudes with the social environment of friends with p-value = 0.034 and there was also a significant relationship between attitudes with the place to hang out with p-value = 0.020. There was a significant relationship between premarital sex action with the community's social environment with p-value = 0.003.

The advice given based on the results of this study is expected to provide socialization to adolescents to increase knowledge of psychosocial problems in adolescents specifically regarding premarital sexual behavior, as well as an intervention model that can control premarital sex in adolescents in the city of Makassar.

**Conflict of Interest:** Nil

**Source of Funding:** Self

**Ethical Clearance:** Taken from National Health Research and Development Ethical Committee Ministry of the Health Republic of Indonesia.

### References

1. Statistic Center Board. Indonesian Population Projection 2015-2045; Result of SUPAS 2015. BPS-Statistics Indonesia, Rev. Ed. Jakarta; Gandewa Pramatya Arta. 2018. p 68
2. National Family Planning Demography Board. Indonesian Demography and Health Survey 2017; Teenagers Book. Jakarta; Statistic Center Agency Ministry of Health. 2018. p 120-127
3. Felice ME, Feinstein RA, Fisher M, et al. American Academy of Pediatrics. Committee on Adolescence. Contraception in adolescents. *Pediatrics*. 1999;104(5 Pt 1):1161-1166.
4. Glasier A, Gülmezoglu AM, Schmid GP, Moreno CG, Van Look PF. Sexual and reproductive health: a matter of life and death. *Lancet*. 2006;368(9547):1595-1607. DOI:10.1016/S0140-6736(06)69478-6
5. Kinsman SB, Romer D, Furstenberg FF, Schwarz DF. Early sexual initiation: the role of peer norms. *Pediatrics*. 1998;102(5):1185-1192. DOI:10.1542/peds.102.5.1185
6. Utomo ID, McDonald P. Adolescent reproductive

- health in Indonesia: contested values and policy inaction. *Studies in Family Planning Journal*. 2009; 40 (2): 133-146
7. Faturachman. Adolescent sexual attitudes and behavior in Bali. *Journal of Psychology*. 1992; 1: p 12-17.
  8. Buhi E, Goodson P. Predictors of adolescent sexual behavior and intention: a theory-guided systematic review. *Journal of Adolescent Health*. 2007; 40 (1): 4-21.
  9. Busse P, Fishbein M, Bleakley A, Hennessy M. 2010. The role of communication with friends in sexual initiation. *Communication Research*. 2010; 37 (2): 239-55
  10. Luthfie RE. The phenomenon of Sexual Behavior in Teens. 2002. <http://www.bkkbn.go.id> (accessed)
  11. Amrillah. Sexual Behavior Reviewed From the Quality of Parent-Child Communication About Sexuality. Thesis, UMS, Surakarta; 2006.
  12. Notoatmodjo S. *Health Education and Behavior*, Jakarta: Rineka Cipta. 2003.
  13. Hurlock EB. *Developmental Psychology*. Jakarta: Erlangga. 2004.
  14. Prayitno, Erman A. *Basics of Guiding dan Counseling*. Ed. Rev, Jakarta: Rhineka Cipta. 2008.
  15. Azwar S. *Human Attitude Theory and Measurement*. Yogyakarta: Student Library. 2010.
  16. Conger JJ. *Adolescence and youth: Psychological development in a changing*, New York: Harper Collins Publishers Inc. 1991.
  17. Sarwono WS. *Adolescent Psychology*. Jakarta: Grafindo Persada. 2003.
  18. Septi, Susi Harningrum, and Purnomo, Daru. *Premarital Sex Behavior in Dating (Case Study of Premarital Sex Behavior in Teenagers in Salatiga City)*; 2014.

# Health Literacy Associated with Raw Cyprinoid Fish Consumption in Northeastern Thailand

Tiwakron Prachaiboon<sup>1</sup>, Pannee Banchonhattakit<sup>2</sup>,  
Nathkapach Kaewpitoon Rattanapitoon<sup>3,4</sup>, Surachai Phimha<sup>5</sup>

<sup>1</sup>Doctoral student in Public Health, Faculty of Public Health, Khon Kaen University, Thailand, <sup>2</sup>Associate Professor, Department of Public Health Administration Health Promotion Nutrition, Faculty of Public Health, Khon Kaen University, Thailand, <sup>3</sup>Assistant professor, School of Translational Medicine, Institute of Medicine, Suranaree University of Technology, Nakhon Ratchasima 30000, Thailand, <sup>4</sup>Assistant professor, Parasitic Disease Research Center, Suranaree University of Technology, Nakhon Ratchasima 30000, Thailand, <sup>5</sup>Lecturer, Department of Public Health Administration, Health Promotion, and Nutrition, Faculty of Public Health, Khon Kaen University, Thailand

## Abstract

**Background:** Currently, more than 10 million people are at risk of liver fluke infection caused by *Opisthorchis (O.) viverrini* in Southeast Asia, particularly Thailand. The cause is the fish-borne diseases which result from the frequent consumption of undercooked fish.

**Method:** A cross-sectional analytical study was designed for one-year period. A total of 1,163 respondents at the age of 15-59 was chosen through the cluster random sampling.

**Results:** Health literacy including inadequate access health information ( $OR_{adj} = 2.05$ ; 95%CI: 1.16 - 3.60,  $p < 0.05$ ), inadequate understand health information ( $OR_{adj} = 2.81$ ; 95%CI: 1.46 - 5.43,  $< 0.001$ ) inadequate appraise health information ( $OR_{adj} = 2.35$ ; 95%CI: 1.38 - 3.99,  $< 0.001$ ) and inadequate apply health information ( $OR_{adj} = 4.32$ ; 95%CI: 2.24 - 8.35,  $p < 0.001$ ), had statistical significance associated with raw cyprinoid fish consumption. In addition, feeding dogs and cats with raw cyprinoid fish ( $OR_{adj} = 4.94$ ; 95%CI: 3.48 - 7.00,  $p < 0.001$ ) associated with raw cyprinoid fish consumption with statistical significance.

**Conclusions:** This study indicates that health literacy was associated with the raw cyprinoid fish consumption. Therefore, *O. viverrini* prevention and control should focus on their health literacy and change their eating behaviors, tradition, context, including feeding dogs and cats.

**Keywords:** Health literacy, Raw cyprinoid fish consumption, *Opisthorchis viverrini*, Carcinogenic human liver fluke.

## Introduction

Neglected tropical diseases are caused by the most parasitic infections affecting health and poverty

---

### Corresponding Authors:

#### Dr. Pannee Banchonhattakit

Associate Professor, Department of Public Health Administration Health Promotion Nutrition, Faculty of Public Health, Khon Kaen University, KhonKaen, 40002, Thailand

Telephone: +66-953519542

e-mail: panban@kku.ac.th

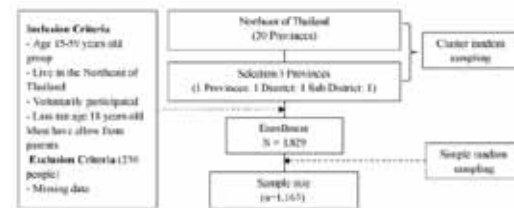
particularly in Southeast Asian countries, mainly including Thailand, Laos People's Democracy Republic (PDR), Cambodia, and central part of Vietnam in which there have been reported of liver fluke infection, *O. viverrini*.<sup>1</sup> There has been a population prone to liver fluke infection and their close relatives, constituting approximately 40.7 million people in worldwide. Common human liver fluke infection can be found among certain groups of individuals, divided into 9 million people suffering *O. viverrini* infection, 1.2 million people with *O. felineus* infection and 35 million people with *Clonorchis sinensis* infection.<sup>2</sup> *O. viverrini* infection is the main risk factor for cholangiocarcinoma

and is often found in Northeastern Thailand and Laos since people continue to have the habit of extensive consumption of raw or half-cooked fish.<sup>3,4</sup> In Thailand, more than 6 million people are at risk of the liver fluke infection<sup>5</sup>, which has been found to have the highest prevalence in the northeast (16.6%) and the north (10.0).<sup>6</sup> The *O. viverrini* infection was frequently found in male, agricultural occupations and in the age group over 35 years.<sup>7</sup> The infection results from the raw or under-cooked consumption of freshwater cyprinoid fish. Albeit well aware among many people that dosing with praziquantel is a treatment for an episode of the infection, it still poses a high risk for them to suffer long-term consequences, so eventually they will probably engage in a cycle of infection, dosing and reinfection.<sup>5,8</sup> However, prevention and control campaigns were launched nearly hundred years ago, so it resulted in a nationwide decrease of *O. viverrini* infection (8.7%).<sup>5,6</sup> Irrespective of such a substantial decrease, novel key success or new focus to eradicate *O. viverrini* or to decrease this infection in correspondence with the underlining requirement of Ministry of Public Health (less than 5.0%) is still in need.

Health literacy (HL) represents the cognitive skills and social skills which determine the motivation and ability of individuals to gain access to, understand and use information in ways which promote and maintain good health.<sup>9</sup> HL is a concept of healthcare, disease prevention, and health promotion settings. The ability includes: Access, Understand, Appraise and Apply. It refers to the ability to communicate and use the information to make a decision to maintain and improve health.<sup>10</sup> HL refers to people's competencies to access, understand, judge and apply health information in healthcare, disease prevention, and health promotion by describing the level of HL and the factors associated with its population.<sup>11</sup> As a result, the risk of *O. viverrini* infection is posed by a habit of raw fish consumption. Despite its significance, it has been neglected; simply speaking, there is a dearth of studies of HL regarding liver fluke among *O. viverrini* infection risk groups in Northeastern Thailand. Therefore, this study aimed to investigate the HL associated with raw cyprinoid fish consumption in Northeastern Thailand. A large sample group was selected from the population among the 15-59 age group as representatives of the population-based cross-sectional study conducted in Northeast of Thailand. This study confirmed that HL and factors associated with liver fluke that will be useful for further disease prevention and health promotion.

## Materials and Method

**Study Design:** This cross-sectional analytical study was conducted in Northeastern region, Thailand for one-year in 2019. A total population of 17,851 individuals who are living in three Province, Northeastern, Thailand, was included through cluster random sampling and completed self-administered questionnaires. Specifically, among that population, a total number of 1,829 respondents were selected through simple random sampling (Figure 1).



**Figure 1. The inclusion flow chart of study design and sampling.**

**Questionnaires:** The questionnaire was applied from the HLS-EU-Q Measurement of HL in Europe: HLS-EU-Q47. The questionnaire consisted of 4 parts, namely: 1) demographic characteristics, 2) knowledge about *O. viverrini*, 3) HL's 4 skills: access information, understand information, appraise information, apply information, and 4) Practice of *O. viverrini* infection. The questionnaire was validated by 7 experts and tested for its reliability. The Kuder-Richardson-20 coefficients of knowledge about *O. viverrini* question were 0.74. The Cronbach's alpha coefficients of HL and practice of *O. viverrini* infection were 0.87 and 0.76 respectively.

**Statistical analysis:** The primary outcome of this research was raw cyprinoid fish consumption in Northeastern Thailand. Multiple logistic regressions were used for analyzing the raw cyprinoid fish consumption and HL scores by crude, adjusted relative ratios (ORadj) and 95 % confidence intervals (CI). All analyses were performed using Stata version 10.0 (Stata Corp, College Station, TX). All test statistics were two-sided, and a p-value of less than 0.05 was deemed statistical significant.

## Result

**Demographic Characteristics:** Among a total of 1,163 persons, a majority of them 54.34% were female, with a mean age of  $42.68 \pm 12.30$  years old (ranged: 15-59), occupation as unemployed, a farmer and a laborer (85.47 %);, most of the family/monthly incomes were

below 5,000 baht (44.63%), alcohol consumption (47.21%), experience of using praziquantel (39.81%), and feeding dogs and cats with raw cyprinoid fish (30.01%).

Adjusted Odds ratios (OR) of raw cyprinoid fish consumption

The strongest factor that associated with raw cyprinoid fish consumption was access health information at the inadequate, followed by the

understand health information at the inadequate, appraise health information at the inadequate, apply health information at the inadequate, gender in the male, occupation as unemployed, a farmer and laborer, family/ monthly incomes below 5,000 baht and those from 5,001 to 10,000 baht, alcohol consumption, experience of using praziquantel, and feeding dogs and cats with raw cyprinoid fish; all factors listed above were found to be significantly associated with raw cyprinoid fish consumption (Table 1).

**Table 1. Odds ratios (ORadj) of raw cyprinoid fish consumption and their 95% confidence intervals for each factor adjusted for all other factors presented in the table using multiple logistic regressions**

Factors	Number	% Consumption	Crude OR	ORadj	95% CI	P-value
<b>Access health information</b>						< 0.05
Excellent	174	27.01	1	1	1	
Sufficient	217	32.26	1.28	1.21	0.70 - 2.10	
Problematic	493	49.29	2.62	1.60	0.96 - 2.65	
Inadequate	279	69.18	6.06	2.05	1.16 - 3.60	
<b>Understand health information</b>						<0.001
Excellent	202	29.70	1	1	1	
Sufficient	348	33.33	1.18	0.99	0.61 - 1.62	
Problematic	395	51.14	2.47	1.67	0.97 - 2.85	
Inadequate	218	80.28	9.63	2.81	1.46 - 5.43	
<b>Appraise health information</b>						<0.001
Excellent	164	31.10	1	1	1	
Sufficient	191	32.46	1.06	1.00	0.60 - 1.66	
Problematic	410	38.54	1.38	1.11	0.69 - 1.80	
Inadequate	398	70.85	5.38	2.35	1.38 - 3.99	
<b>Apply health information</b>						<0.001
Excellent	318	30.82	1	1	1	
Sufficient	278	35.97	1.26	0.77	0.49 - 1.19	
Problematic	400	53.25	2.55	1.45	0.90 - 2.34	
Inadequate	167	85.03	12.75	4.32	2.24 - 8.35	
<b>Gender</b>						<0.05
Female	632	38.29	1	1	1	
Male	531	58.57	2.27	1.50	1.11 - 2.03	
<b>Occupation</b>						<0.05
Own business & State ent.	169	28.40	1	1	1	
Unemployed & Farmer & Labor	994	50.80	2.60	2.03	1.31-3.12	
<b>Income of family/Month (Thai Bath)</b>						<0.05
> 10,000	272	40.81	1	1	1	
5,001-10,000	372	49.46	1.41	1.62	1.09-2.41	
≤ 5,000	519	49.71	1.43	1.57	1.09-2.28	

Factors	Number	% Consumption	Crude OR	ORadj	95% CI	P-value
<b>Drinking Alcohol/Year</b>						< 0.001
No	614	34.85	1	1	1	
Yes	549	61.75	3.01	1.92	1.42 - 2.61	
<b>Using Praziquantel</b>						< 0.001
No	700	37.14	1	1	1	
Yes	463	63.28	2.91	2.21	1.64 - 2.98	
<b>Feeding dog and cat with raw fish</b>						< 0.001
No	814	37.35	1	1	1	
Yes	349	71.35	4.17	4.94	3.48 - 7.00	

## Discussions

HL represents the cognitive skills and social skills, a concept of healthcare, disease prevention, and health promotion settings, serving as an approach to promote and maintain good health.<sup>9</sup> This HL is in need of more understanding, particularly regarding *O. viverrini* infection among the population living in the endemic areas especially in the Northeastern region of Thailand which has reported with the highest prevalence of cholangiocarcinoma incident.<sup>12</sup> This new finding demonstrated that HL was associated with raw cyprinoid fish consumption. Previously studies indicated that raw cyprinoid fish consumption serves as an essential factor in reinfection and chronic infection of *O. viverrini* which would develop further to be cholangiocarcinoma, the cause of morbidity and mortality in the Northeast, Thailand and Laos PDR.<sup>3,4,7</sup> These findings showed that HL, namely the inadequate of access health information, understand health information, appraise health information, and apply health information, was significantly associated with raw cyprinoid fish consumption. That population group is prone to *O. viverrini* infection. Consistent with the health literacy, The low level of HL induced the poor self-management abilities in a wide range of older adults.<sup>13</sup> Meanwhile, people with the high level of HL can prevent liver fluke infection owing to have low prevalence in the endemic areas.<sup>14</sup> Cultivating and instilling high levels of literacy among a population not only is a vital development goal but will also produce substantial public health benefits.<sup>15</sup>

In addition, the present study found that feeding dogs and cats with raw cyprinoid fish was significantly associated with raw fish consumption. This result is in line with the prior study in that there was the association between *O. viverrini* infection in dogs, cats and their

owners.<sup>16</sup> The cats that consumed raw fish were significantly more likely to be infected than those that consumed other foods.<sup>17</sup> These findings indicated that dogs and cats are the main reservoir host of *O. viverrini* that closely habituate with human and assumed that humans and their pets are also infection. Moreover, raw cyprinoid fish consumption was associated with used praziquantel among this population. This finding was consistent with previous studies that the factor as in previous use of praziquantel was related to *O. viverrini* infection.<sup>3,8</sup> Prevention and control of *O. viverrini* in the population at risk in endemic areas should also focus on the previous use of praziquantel. Furthermore, in respect of association between raw fish consumption and alcohol consumption, alcohol drinking serves as the risk factor of an increasing chance of suffering or acquiring *O. viverrini* infection.<sup>18</sup> Unfortunately, many people in the Northeastern region of Thailand misunderstand and assume that alcohol consumption can help eradicate *O. viverrini* during their raw cyprinoid fish consumption.<sup>19</sup> Health education for improving this risk group's HL is needed.

Demographic data including gender, occupations, family/monthly incomes and raw fish consumption were analyzed and found that males, occupation (unemployed, farmer and a laborer), family/monthly incomes (less than 5,000 baht) and (5,001 to 10,000 baht) were statistically significant. This result is in sync with other studies in that common infection was found in males, occupation (agricultural workers)<sup>7,20</sup> and income (<5,000 baht/month).<sup>3,21</sup> This study indicates that family/monthly incomes were less than 10,000 baht.

## Conclusions

This study showed HL was associated with raw

fish consumption, access health information about *O. viverrini* infection, understand health information about *O. viverrini* infection, appraise health information about *O. viverrini* infection and apply health information about *O. viverrini* infection. Furthermore, HL may serve as a desirable strategy for informing and modifying health behavior regarding *O. viverrini* infection in community health prevention, disease prevention, and health promotion among the risk group in Northeastern Thailand.

**Acknowledgements:** We would like to express our gratitude to the following organization: Research Fund for Supporting Lecturer to Admit High Potential Student to Study and Research on His Expert Program 2017, Graduate School, Khon Kaen University, Thailand.

**Ethical Clearance:** This study was approved by the Ethics Committee in Human Research of Khon Kaen University, Khon Kaen, Thailand (Reference no. HE622072).

**Conflict of Interest:** The authors declare that there is no conflict of interest.

## Reference

- Hotez PJ, Bottazzi ME, Strych U, Chang LY, Lim YA, Goodenow MM, AbuBakar S. Neglected tropical diseases among the Association of Southeast Asian Nations (ASEAN): overview and update. *PLoS Negl Trop Dis* 2015; 9(4): p. e0003575.
- Sithithaworn P, Andrews R, Shekhovtsov SV, Mordvinov VA, Furman DP. *Opisthorchis viverrini* and *Opisthorchis felinus*. *Encyclopedia of Food Safety* 2014; 2: 170–178. doi:10.1016/B978-0-12-378612-8.00158-X
- Chudthaisong N, Promthet S, Bradshaw P. Risk factors for *Opisthorchis viverrini* Infection in Nong Khai Province, Thailand. *Asian Pac J Cancer Prev* 2015; 16(11):4593-4596.
- Saiyachak K, Tongsothang S, Saenrueang T, Moore MA, Promthet S. Prevalence and Factors Associated with *Opisthorchis viverrini* Infection in Khammouane Province, Lao PDR. *Asian Pac J Cancer Prev* 2016; 17(3): 1589-1593.
- Sithithaworn P, Andrews RH, Nguyen VD, Wongsaroj T, Sinuon M, Odermatt P, et al. The current status of opisthorchiasis and clonorchiasis in the Mekong Basin. *Parasitology international* 2012; 61(1): 10-16.
- Wongsaroj T, Nithikathkul C, Rojkitikul W, et al. National survey of helminthiasis in Thailand. *Asian Biomed* 2014; 8(6): 779-783.
- Kaewpitoon N, Kootanavanichpong N, Komporn P, Chavenkun W, Kujapun J, Norkaew J, et al. Review and Current Status of *Opisthorchis viverrini* Infection at the Community Level in Thailand. *Asian Pac J Cancer Prev* 2015; 16(16): p. 6825-30.
- Saengsawang P, Promthet S, Bradshaw P. Infection with *Opisthorchis viverrini* and use of praziquantel among a working-age population in northeast Thailand. *Asian Pac J Cancer Prev* 2013; 14(5): 2963-2966.
- World Health Organization [WHO] (1998). *Health promotion Glossar*. Geneva: WHO Publications.
- Sorensen K, Van den Broucke S, Fullam J, Doyle G, Pelikan J, Slonska Z, et al. Health literacy and public health: a systematic review and integration of definitions and models. *BMC public health* 2012; 12: 80. doi: 10.1186/1471-2458-12-80.
- Denuwara H, Gunawardena NS. Level of health literacy and factors associated with it among school teachers in an education zone in Colombo, Sri Lanka. *BMC Public Health* 2017; 17(1): 631.
- Sripa B, Kaewkes S, Intapan PM, Maleewong W, Brindley PJ. Food-borne trematodiasis in Southeast Asia epidemiology, pathology, clinical manifestation and control. *Adv Parasitol* 2010; 72: 305-50. doi: 10.1016/S0065-308X(10)72011-X.
- Geboers B, de Winter AF, Spoorenberg SL, Wynia K, Reijneveld SA. The association between health literacy and self-management abilities in adults aged 75 and older, and its moderators. *Qual Life Res* 2016; 25(11): 2869-2877.
- Padchasuwan N, Banchonhattakit P, Kaewpitoon N. Health literacy Associated with liver fluke Prevention and Control Among Secondary School Students in Northeast Thailand. *Suranaree J. Sci. Technol* 2018; 25(3): 307-318.
- Nutbeam D. Defining and measuring health literacy: what can we learn from literacy studies?. *International journal of public health* 2009; 54(5): 303-305.
- Prakobwong S, Suwannatrai A, Sancomerang A, Chaipibool S, Siriwechtumrong N. A Large Scale Study of the Epidemiology and Risk Factors for the Carcinogenic Liver Fluke *Opisthorchis viverrini*

- in Udon Thani Province. Thailand. *Asian Pac J Cancer Prev* 2017; 18(10): p. 2853-2860.
17. Aunpromma S, Kanjampa P, Papirom P, Tangkawattana S, Tangkawattana P, Tesana S, et al. Prevalence and Risk Factors for *Opisthorchis viverrini* Infection Among Cats and Dogs in Six Districts Surrounding Ubolratana Dam, An Endemic Area for Human *Opisthorchis* in Northeastern Thailand. *Southeast Asian J Trop Med Public Health* 2016; 47(6): 1153-1159.
  18. Yeoh KW, Promthet S, Sithithaworn P, Kamsa-Ard S, Parkin DM. Re-examination of *Opisthorchis viverrini* Infection in Northeast Thailand. *Asian Pac J Cancer Prev* 2015; 16(8): 3413-3418
  19. Sriraj P, Aukkanimart R, Boonmars T, Wonkchalee N, Juasook A, Sudsarn P, Pairojkul C, Warasawapati S, Pinlaor S. Alcohol and alkalosis enhance excystation of *Opisthorchis viverrini* metacercariae. *Parasitol Res* 2013; 112(6): 2397-2402.
  20. Kaewpitoon SJ, Rujirakul R, Wakkuwattapong R, Matrakool L, Tongtawee T, Panpimanmas S, Pengsaa P, Jomkoa D, Joosiri A, Kaewpitoon N. *Opisthorchis viverrini* Infection Among People in the Border Areas of Three Provinces, Northeast of Thailand. *Asian Pac J Cancer Prev* 2016; 17(6): 2973-2977.
  21. Chavengkun W, Komporn P, Norkaew J, Kujapun J, Pothipim M, Ponphimai S, Kaewpitoon SJ, Padchasuwan N, Kaewpitoon N. Raw Fish Consuming Behavior Related to Liver Fluke Infection among Populations at Risk of Cholangiocarcinoma in Nakhon Ratchasima Province, Thailand. *Asian Pac J Cancer Prev* 2016; 17(6): 2761-2765.



# Nutrient and Cost Optimization in Menu Planning at an Apex Tertiary Care Hospital Using Operational Research Techniques

Vijay Kumar Tadia<sup>1</sup>, Mahesh R.<sup>2</sup>, Sidhartha Satpathy<sup>3</sup>

<sup>1</sup>Senior Resident Administrator, Department of Hospital Administration, AIIMS, New Delhi, India, <sup>2</sup>Additional Professor, Department of Hospital Administration, AIIMS, New Delhi, <sup>3</sup>Professor & Head, Department of Hospital Administration, AIIMS, New Delhi

## Abstract

**Introduction:** Menu planning involves meticulous customised designing of nutrients to fulfill the dietetic needs of patients with various clinical profiles admitted in the Hospital. The goal of the diet problem is to select a set of foods that will satisfy a set of daily nutritional requirement of patients at minimum cost. Various tools and techniques of applied simulation models in Operational Research are available to optimize the cost as well as quality of food.

**Methodology:** The study based on exploratory research design was conducted at Dietetics Department of an apex tertiary care hospital in India. It was based on an exploratory research design. The LPSolve programming language was used to analyse the data and generate the output. Integer Programming determined the most nutritious meals while considering the constraints of the RDA by ICMR. The Nutritive Value of Ingredients per 100 grams was obtained from the Nutritive Value of Indian Foods (2012) published by NIN, ICMR.

A model was formulated using the notations, N for the total number of dishes available,  $c_i$  for the Cost of  $i$ th dish, where  $i = 1, 2, 3, \dots, N$ ,  $x_i$  for the decision variable, LB for the Lower Bound of nutrition intake, UB for Upper Bound of nutrition intake, n for the Number of dishes required per day and T for the Total types of food, the following equations were used.

**Objective Function:** Minimize the total cost  $F, F = \sum_{i=1}^N c_i x_i$

**Constraint 1:** Daily constraints  $LB \leq \sum_{i=1}^N \text{Nutrients}(x_i) \leq UB$ ; where  $i=1, 2, \dots, N$

**Constraint 2:**  $\sum_{i=1}^T \text{Type of foods}(x_i) = n$ ; where  $i=1, 2, 3, \dots, T$

**Results:** It was found that the Indian recipes fail to provide the minimum RDA of Vitamin A and Vitamin B6 and therefore, the lower bound had to be reduced significantly for these Vitamins.

**Conclusion:** The application based on operational research techniques can be further developed to be deployed across different hospitals. This would help to not only to provide the RDA but also ensure that it is done at a lower cost.

**Keywords:** Nutrient optimization, Cost Optimization, Menu Planning.

## Introduction

Menu planning involves meticulous customised designing of nutrients to fulfil the dietetic needs of patients with various clinical profiles admitted in the Hospital. The goal of the diet problem is to select a set of foods that will satisfy a set of daily nutritional requirement of patients at minimum cost<sup>1</sup>. Various

---

### Corresponding Author:

**Mahesh R.**

Additional Professor, Department of Hospital Administration, AIIMS, New Delhi  
e-mail: maheshbelagere@gmail.com

tools and techniques of applied simulation models in Operational Research are available to optimize the cost as well as quality of food.

In this study, the diet problem has been formulated as a linear program of Operations Research where the objective was to minimize cost and the constraints were to satisfy the specified nutritional requirements in the diet. The diet problem constraint typically regulate the number of calories and the amount of vitamins, minerals, fats, sodium, and cholesterol in the diet<sup>1</sup>.

The process of decision making in the Menu Planning is complex. It involves multitude of factors that have to be taken into account while doing the menu planning exercise<sup>2</sup>.

The diet problem was one of the first optimization problems studied in the 1930s and 1940s. Early researchers to study the problem was George Stigler, who made an educated guess of an optimal solution using a heuristic method<sup>3</sup>.

Operations research is a discipline that deals with the application of advanced analytical method to help make better decisions<sup>4</sup>. It involves techniques from other mathematical sciences, such as mathematical modeling, statistical analysis, and mathematical optimization, operations research arrives at optimal or near-optimal solutions to complex decision-making problems<sup>4</sup>.

Linear programming (LP) (also called linear optimization) is a method to achieve the best outcome (such as maximum profit or lowest cost) in a mathematical model whose requirements are represented by linear relationships. Linear programming is a special case of mathematical programming (mathematical optimization)<sup>5</sup>.

**Need for the Study:** Advancement in the field of medicine has increased the chances of survival of patients with a variety of diseases that were considered incurable earlier. The prevalence of malnutrition has been estimated to be as high as 50% among acutely hospitalized adults, depending on the definition employed and the population assessed<sup>6,7,8</sup>. Malnutrition is consistently associated with adverse clinical outcomes, including increased morbidity, mortality, and length of hospital stay as well as reduced quality of life<sup>9,10,11,12</sup>. Various diseases commonly found in patients cause

stress on the body and bring about changes in substrate metabolism, thus leading to the deficiency of various nutrients. The incidence of malnutrition is significant in critical, particularly in high-risk patients<sup>13</sup>. It is essential to identify malnourished patients and also patients at increased risk of malnutrition in order to devise a comprehensive nutrition care program. Nutrition societies across the world recommend nutrition screening tools to assess malnutrition in hospitalized patients, such as the Mini Nutritional Assessment (MNS) tool<sup>14</sup>. Chakravarty et al concluded that almost two-fifth of admitted patients were malnourished in tertiary care hospital and there was an urgent need to develop a comprehensive nutritional care program. A study by Kowanko et al, concluded that although nurses considered nutritional care to be important, many had difficulty in raising its priority above other nursing activities, as a result of time constraints and multitasking issues<sup>15</sup>. So, there should be a system for nutritional assessment of all admitted patients and special individualized plan should be set. Reid and Allard-Gould reported that adequate nutritional screening and interventions have been demonstrated to be cost-effective resulting in fewer complications, faster recovery, shorter hospital stays and reduced hospital expenditures<sup>16</sup>. The value of nutrition therapy for the adult hospitalized patient is derived from the outcome benefits and the nutritional assessment should identify those patients at high nutritional risk, determined by both disease severity and nutritional status<sup>17</sup>. A NABH standard on Care of Patients (COP.19) talks about the nutritional therapy to be provided to patients consistently and collaboratively<sup>18</sup>. Taking into consideration the factors mentioned above this study was conceived

## Methodology

The study based on exploratory research design was conducted at dietetics department of an apex tertiary care hospital in India. The LPSolve programming language was used to analyse the data and generate the output. Integer Programming determined the most nutritious meals while considering the constraints of the RDA by ICMR. The Nutritive Value of Ingredients per 100 grams was obtained from the Nutritive Value of Indian Foods (2012) published by NIN, ICMR.

The RDA for Indians as provided by ICMR<sup>19</sup> is given in Table 1 and Table 2 below.

**Table 1: Recommended Dietary Allowances for Indians (Macronutrients and Minerals). Source: Dietary Guidelines for Indians– A Manual (2011), National Institute of Nutrition, ICMR**

Group	Particulars	Body weight (kg)	Net Energy (kCal/d)	Protein (g/d)	Visible Fat (g/day)	Calcium (mg/d)	Iron (mg/d)
Man	Sedentary work	60	2320	60	25	600	17
	Moderate work		2730		30		
	Heavy work		3490		40		
Woman	Sedentary work	55	1900	55	20	600	21
	Moderate work		2230		25		
	Heavy work		2850		30		
	Pregnant woman		+350	+23	30	1200	35
	Lactation 0-6 months		+600	+19	30	1200	21
	Lactation 6-12 months		+520	+13	30		
Infants	0-6 months	5.4	92 Kcal/kg/d	1.16 g/kg/d	–	500	46 ig/kg/day
	6-12 months	8.4	80 Kcal/kg/d	1.69 g/kg/d	19		5
Children	1-3 years	12.9	1060	16.7	27	600	9
	4-6 years	18	1350	20.1	25		13
	7-9 years	25.1	1690	29.5	30		16
Boys	10-12 years	34.3	2190	39.9	35	800	21
Girls	10-12 years	35	2010	40.4	35	800	27
Boys	13-15 years	47.6	2750	54.3	45	800	32
Girls	13-15 years	46.6	2330	51.9	40	800	27
Boys	16-17 years	55.4	3020	61.5	50	800	28
Girls	16-17 years	52.1	2440	55.5	35	800	26

**Table 2: Recommended Dietary Allowances for Indians (Vitamins). Source: Dietary Guidelines for Indians – A Manual (2011), National Institute of Nutrition, ICMR<sup>19</sup>**

Group	Particulars	Vit. A mg/d		Thiamin	Riboflavin	Niacin equivalent	Pyridoxin	Ascorbic acid	Dietary folate	Vit. B12	Magnesium	Zinc
		Retinol	b-carotene	mg/d	mg/d	mg/d	mg/d	mg/d	mg/d	mg/d	mg/d	mg/d
Man	Sedentary work	600	4800	1.2	1.4	16	2	40	200	1	340	12
	Moderate work			1.4	1.6	18						
	Heavy work			1.7	2.1	21						
Woman	Sedentary work	600	4800	1	1.1	12	2	40	200	1	310	10
	Moderate work			1.1	1.3	14						
	Heavy work			1.4	1.7	16						
	Pregnant woman	800	6400	0.2	0.3	2	2.5	60	500	1.2	12	
	Lactation 0-6 months	950	7600	0.3	0.4	4	2.5	80	300	1.5		
	Lactation 6-12 months			0.2	0.3	3	2.5					
Infants	0-6 months	--	--	0.2	0.3	710 mg/kg	0.1	25	25	0.2	30	–
	6-12 months	350	2800	0.3	0.4	650 mg/kg	0.4				45	–
Children	1-3 years	400	3200	0.5	0.6	8	0.9	40	80		50	5
	4-6 years			0.7	0.8	11	0.9		100		70	7
	7-9 years			600	4800	0.8	1		13		1.6	120

Group	Particulars	Vit. A mg/d		Thiamin	Riboflavin	Niacin equivalent	Pyridoxin	Ascorbic acid	Dietary folate	Vit. B12	Magnesium	Zinc
		Retinol	b-carotene	mg/d	mg/d	mg/d	mg/d	mg/d	mg/d	mg/d	mg/d	mg/d
Boys	10-12 years	600	4800	1.1	1.3	15	1.6	40	140	0.2-1.0	120	9
Girls	10-12 years			1	1.2	13	1.6				160	9
Boys	13-15 years			1.4	1.6	16	2	40	150		165	11
Girls	13-15 years			1.2	1.4	14	2				210	11
Boys	16-17 years			1.5	1.8	17	2	40	200		195	12
Girls	16-17 years			1	1.2	14	2				235	12

**Model Formulation:** The objective of this study was to formulate a menu planning model that minimizes the cost and tries to achieve the maximum nutritional requirement based on the Indian RDA requirements.

Integer Programming was used to determine the most nutritious and palatable meals, while considering the constraints of the RDA, the cost of the menu items, the budget at hand as well as requirement of variety of food items. Various permutations and combinations to optimise the menu in terms of Calories required by patients as well as the efficiency in terms of Cost were put to test.

**Notations Used:**

N = Total number of dishes available

$C_i$  = Cost of ith dish, where  $i = 1,2,3,\dots,N$

$x_i$  = decision variable

LB = Lower Bound of nutrition intake

UB = Upper Bound of nutrition intake

n = Number of dishes required per day

T = Total types of food

**Objective Function:**

Minimize the total cost F,

$$F = \sum_{i=1}^N c_i x_i$$

**Constraint 1:**

Daily constraints

$$LB \leq \sum_{i=1}^N \text{Nutrients}(x_i) \leq UB; \text{ where } i = 1, 2, \dots, N$$

LB and UB are the vectors, give different value for each nutrient. This is to ensure that we meet the nutrients requirements. The details are shown in Table 3.

**Constraint 2:**

$$\sum_{i=1}^T \text{Type of foods}(x_i) = n; \text{ where } i = 1, 2, 3, \dots, T$$

This constraint makes sure that daily number of dishes/servings required must be fulfilled. The details are given in Table 4.

**Data required:**

- For Objective function:** Cost of each dish/serving in Rupees ( $C_i$ ): Set to a random number as cost of the ingredients vary fortnightly as per rate list sourced at AIIMS
- For Constraint 1:**

**Table 3: Data required for constraint 1**

Nutrients	Lower Bound (LB)	Upper Bound (UB)	RDA
Energy (Kcal)	2050	2600	2320
Protein (g)	50	100	60
Fat (g)	20	100	25
Calcium (mg)	550	2000	600

Nutrients	Lower Bound (LB)	Upper Bound (UB)	RDA
Iron (mg)	14	30	17
b-carotene (mcg)	600	6000	4800
Thiamine (mg)	1	3	1.2
Riboflavin (mg)	0.5	2	1.4
Niacin (mg)	10	20	16
Pyridoxin (mg)	0	4	2
Ascorbic acid (mg)	30	200	40
Dietary folate (mcg)	150	250	200

### 3. For Constraint 2:

**Table 4: Data required for Constraint 2**

Type of food (T)	No. of requirement per day (n)
Breakfast	1
Dal-Vegetables	2
Roti	4
Rice	1
Dessert	1
Beverage	2

### Results and Discussion

**Outputs:** After input of the required parameters, the output in form of an excel sheet was created based on different permutations and combinations. The output had a menu for the entire week and the nutrient information and cost per day (Table 5).

**Table 5: Nutrient and cost information for the planned diet**

	Monday	Tuesday	Wednesday	Thursday	Friday	Saturday	Sunday
Energy (Kcal)	2407.44	2285.36	2448.44	2298.46	2192.43	2054.65	2158.00
Protein (g)	71.96	67.88	50.08	71.59	57.70	69.55	50.69
Fat (g)	70.05	84.59	32.13	96.55	46.03	58.25	97.37
Calcium (mg)	1093.50	1858.90	583.25	822.44	613.16	1318.66	594.55
Iron (mg)	18.79	23.25	18.94	23.54	20.02	19.13	19.62
Carotene (mcg)	640.31	5781.88	641.03	1018.39	741.59	642.04	640.51
Thiamine (mg)	1.49	1.14	1.18	1.59	1.25	1.09	1.36
Riboflavin (mg)	1.16	0.50	0.67	0.61	0.79	0.62	0.76
Niacin (mg)	14.00	10.64	10.99	11.66	13.03	10.24	10.77
Total B6 (mg)	0.14	0	0	0	0.06	0.017	0
Vitamin C (mg)	67.08	90.59	78.57	68.8	56.49	35.82	31.61
Folic Acid (Total) (mcg)	176.12	188.73	152.20	150.04	153.86	157.01	196.05
Price (Rs.)	59.77	94.69	121.86	110.17	126.58	133.60	151.61

The table above shows the nutrient and cost information for the planned diet for a week. The energy requirements are being met on all the days of the week

i.e., it falls between the acceptable range of 2050 Kcal to 2600 Kcal. There is a variation in provision of other nutrients over the period of week especially Carotene

availability varies widely from 640.30 mcg to 5781.88 mcg. The result must be read in the context of week as a unit for which the menu is planned. If we consider the week as a unit, then the nutrient requirements are generally met as required. In the instances of average length of stay  $\leq 6/7$  days, there is scope to counsel the patient to avail the nutrients in home diet. There were certain limitations, though, to meet all the nutritional needs as discussed later in this article.

Traditionally, in resource constrained healthcare institutions, the Dieticians plan the menu manually. The process of manual planning has no or less scope to involve all consumables vis-à-vis its nutrient values and the amount to be used in the end product to be served to the patient keeping the cost in mind.

A better alternative solution is the concept of Constraint Programming that can be applied to the diet planning system effectively.<sup>20</sup> Mathematical modeling using linear programming may be applied to problems related to optimized resource allocation in healthcare and could be a useful tool to support decision-making processes in healthcare.<sup>21</sup>

Comparative research studies of such experimentation on optimizing the Nutrient & Cost of the diet in such a bigger healthcare institution are not found.

The prototype suggested in this study could be further improved. The optimization based on cost and budget can be done and the menu based on the daily budget defined by the user could generate output within the RDA limits. The Machine Learning can be used to provide relaxation to the limits of RDA to make generation of result much easier and faster. Further, Cloud Based Server can keep on updating the data based on the prevalent market price of commodity based on the geographical region and thus tailor-made solutions can be derived.

#### Limitations of the Study:

1. It was found that the Indian recipes fail to provide the minimum RDA of Vitamin A and Vitamin B6 and therefore, the lower bound had to be reduced significantly (Table 3).
2. While ICMR RDA mentions requirements for Retinol, Vitamin B12, Magnesium and Zinc, the data for the ingredients was not available. On the other hand, Crude fiber and Phosphorous related data for the ingredients is there but the RDA requirement is

not mentioned. Therefore, these nutrients were kept out of the ambit of the present study.

**Conflict of Interest:** Nil

**Source (s) of Support:** Nil

**Ethical Clearance:** The study was conducted as a dissertation for Master in Hospital Administration.

**Acknowledgement:** Authors acknowledge the contributions made by Mr. Kumar Biplab and Mr. Nitesh Swaroop.

#### References

1. The Diet Problem [Internet]. [cited 2020 Jan 1]. Available from: [http://www.eeb.cornell.edu/biogeo/nanc/Food\\_Feed/table1\\_gopalan\\_et\\_al\\_1989.pdf](http://www.eeb.cornell.edu/biogeo/nanc/Food_Feed/table1_gopalan_et_al_1989.pdf)
2. Menu Planning: The Control Point [Internet]. [cited 2020 Jan 1]. Available from: <http://jan.ucc.nau.edu/~wlr2/ha442/class/control/menu/>
3. The Diet Problem | NEOS [Internet]. [cited 2020 Jan 1]. Available from: <https://neos-guide.org/content/diet-problem>
4. What is O.R.? - INFORMS [Internet]. [cited 2020 Jan 1]. Available from: <https://www.informs.org/Explore/What-is-O.R.-Analytics/What-is-O.R.>
5. Nagpure A. Linear Programming [Internet]. [cited 2020 Jan 1]. Available from: [https://rstudio-pubs-static.s3.amazonaws.com/364322\\_46c84f88ab7e4665bc48a41478a3b284.html](https://rstudio-pubs-static.s3.amazonaws.com/364322_46c84f88ab7e4665bc48a41478a3b284.html)
6. Correia MITD, Campos ACL, ELAN Cooperative Study. Prevalence of hospital malnutrition in Latin America: the multicenter ELAN study. Nutrition [Internet]. 2003 Oct [cited 2016 Oct 15];19(10):823–5. Available from: <http://www.ncbi.nlm.nih.gov/pubmed/14559314>
7. Edington J, Boorman J, Durrant ER, Perkins A, Giffin C V, James R, et al. Prevalence of malnutrition on admission to four hospitals in England. The Malnutrition Prevalence Group. Clin Nutr [Internet]. 2000 Jun [cited 2016 Oct 15];19(3):191–5. Available from: <http://www.ncbi.nlm.nih.gov/pubmed/10895110>
8. Beghetto MG, Luft VC, Mello ED, Polanczyk CA. Accuracy of nutritional assessment tools for predicting adverse hospital outcomes. Nutr Hosp. 2009;24(1):56–62.
9. Poggiano MR, Ciarla S, Gnerre P, Roberts A, Magni

- L, Morbidoni L, et al. The management of the patient with malnutrition: From evidence to clinical practice. Vol. 11, Italian Journal of Medicine. Page Press Publications; 2017. p. 134–50.
10. Chakravarty C, Hazarika B, Goswami L, Ramasubban S. Prevalence of malnutrition in a tertiary care hospital in India. *Indian J Crit Care Med.* 2013 May;17(3):170–3.
  11. Goiburu ME, Jure Goiburu MM, Bianco H, Ruiz Díaz J, Alderete F, Palacios MC, et al. The impact of malnutrition on morbidity, mortality and length of hospital stay in trauma patients. *Nutr Hosp.* 2006 Sep;21(5):604–10.
  12. Rufenacht U, Rühlin M, Wegmann M, Imoberdorf R, Ballmer PE. Nutritional counseling improves quality of life and nutrient intake in hospitalized undernourished patients. *Nutrition.* 2010 Jan;26(1):53–60.
  13. Mehanna H, Nankivell PC, Moledina J, Travis J. Refeeding syndrome--awareness, prevention and management. Vol. 1, Head & neck oncology. 2009. p. 4.
  14. Kondrup J, Allison SP, Elia M, Vellas B, Plauth M. ESPEN guidelines for nutrition screening 2002. *Clin Nutr.* 2003;22(4):415–21.
  15. Kowanko I. Nutritional care of the patient: Nurses' knowledge and attitudes in an acute care setting. *J Clin Nurs.* 1999;8(2):217–24.
  16. Reid MB, Allard-Gould P. Malnutrition and the critically ill elderly patient. *Crit Care Nurs Clin North Am.* 2004 Dec;16(4):531–6.
  17. McClave SA, Dibaise JK, Mullin GE, Martindale RG. Nutrition therapy in the adult hospitalized patient. *Am J Gastroenterol* [Internet]. 2016;111(3):315–34. Available from: <http://dx.doi.org/10.1038/ajg.2016.28>
  18. NABH Accreditation Standards for Hospitals. 5th ed. Delhi: NABH; 2020. 25–26 p.
  19. Dietary guidelines for Indians-a Manual [Internet]. Hyderabad: National Institute of Nutrition; 2011 [cited 2020 Jan 1]. Available from: <http://ninindia.org/DietaryGuidelinesforNINwebsite.pdf>
  20. Choosri N. Hospital Dietary Planning System Using Constraint Programming. 2016;(August).
  21. Patil AN. Optimal diet decision using linear programming. 2018;(December):1–4.

# Picture Archiving and Communication Systems (PACS): A Pre-Post Comparative Analysis

Vijay Kumar Tadia

*Senior Resident Administrator, Department of Hospital Administration, AIIMS, New Delhi*

## Abstract

**Background:** A picture archiving and communication systems (PACS) is a computerised means of acquiring, storing, transmitting and displaying images digitally. PACS is a standard component for radiology information systems.

**Method:** A comprehensive descriptive and observational study was undertaken at two tertiary care hospitals from April 2012 to December 2012, the main hospital and an associated hospital. The main hospital had the functional RIS and PACS while PACS was being installed in the associated hospital. So, the main hospital represented Post-PACS scenario and the associated hospital represented Pre-PACS era. The data was collected from the Radiology Information Systems and the PACS Servers. The historical data was obtained from secondary sources. Simple random sampling was used to select cases for the calculation of average waiting time and report TAT for examinations on different modalities.

**Results:** The findings showed improvement in the TAT following PACS implementation at Main Hospital. A noteworthy improvement had been in the case of X-ray unit which had declined considerably from the peak value of 6.8 days in the year 2006 to 2.2 days in the year 2011. In the case of USG, the TAT had reduced and the reports were available on the same day with an average TAT of 0.5 days. In the case of CT, the TAT reduced by more than 50% to 1 day on an average. In the case of MRI, the TAT reduced from 3 days in the year 2004 to 2.4 days in the year 2011. On the other hand, the TAT in case of Associated Hospital was higher in almost all the modalities.

**Discussion and Conclusion:** It may be concluded that the introduction of PACS in Main Hospital had paid the dividends and the decision to install and implement the PACS in Associated Hospital was pragmatic one.

**Keywords:** *Picture Archiving and Communication Systems (PACS), Operational efficiency, RIS.*

## Introduction

A picture archiving and communication systems (PACS) is a computerised means of acquiring, storing, transmitting and displaying images digitally.<sup>1</sup> PACS is a standard component for radiology information systems.<sup>2</sup> It has facilitated the management of images easier

for healthcare organizations<sup>3</sup>. New technologies are sometimes easily accepted in healthcare organizations to improve service quality and efficiency<sup>4</sup>. Though PACS has fundamentally changed healthcare landscape, it proves to be a real challenge for many healthcare organisations<sup>5,6</sup>. The procurement of PACS is a major financial investment and its implementation has a long-term effect on the daily operations of organisation.<sup>7</sup> The evaluation of PACS implementation has been conducted from various perspectives.<sup>8</sup> The impact of PACS on the overall efficiency of imaging services has been calculated to reduce the cost per image.<sup>9</sup> Many studies point out that the user acceptance is an essential tool before implementing PACS as it determines the success rate to a large extent.<sup>2</sup>

---

### Corresponding Author:

**Dr. Vijay Kumar Tadia**

Senior Resident Administrator, Department of Hospital Administration, AIIMS, New Delhi

e-mail: vijaytadia@gmail.com



### Method

A comprehensive descriptive and observational study was undertaken at two tertiary care hospitals from April 2012 to December 2012. These tertiary care hospitals (main hospital and an associated hospital) were located at different locations in the same city and were managed by single administrative set up. The main hospital had the functional RIS and PACS while PACS was being installed in the associated hospital. So, the main hospital represented Post-PACS scenario and the associated hospital represented Pre-PACS era. The data was collected from the Radiology Information Systems and the PACS Servers. The historical data was obtained from secondary sources. Simple random sampling was used to select cases for the calculation of average waiting time and report TAT for examinations on different modalities. Data was analysed by using Microsoft Office Suite.

### Results

The radiology departments at both the hospitals were well equipped to provide the full range of diagnostic imaging services including Computerized Radiography, Ultrasonography (USG) & Colour Doppler, Multi slice Computed Tomography (CT), Magnetic Resonance Imaging (MRI), Mammography and Interventional

radiology. Images from these modalities were stored on PACS (Picture Archival and Communication System) in the main hospital.

Though the PACS was installed in the main hospital in the year 1999 but the integration of various modalities with PACS could be achieved by the year 2005. So, the data was perused after the year 2006 onwards for analysis. The PACS was still under the process of installation and implementation in associated hospital. The main hospital represented Post-PACS phase and associated hospital represented Pre-PACS phase.

Before the implementation of PACS in main hospital, the examination was followed by approximately an hour long process of film development which was further followed by the sorting of the previous images before the patient folder could reach the radiologist. Post PACS, this had been replaced by a five minute activity of processing a plate, containing a cassette with patient details, and the screen containing image, in the CR processor and transmitting the image to PACS by a technician.

The operational efficiency of HMIS/RIS and PACS was gauged from the workload handled, the average examination waiting time and the average report turnaround time.

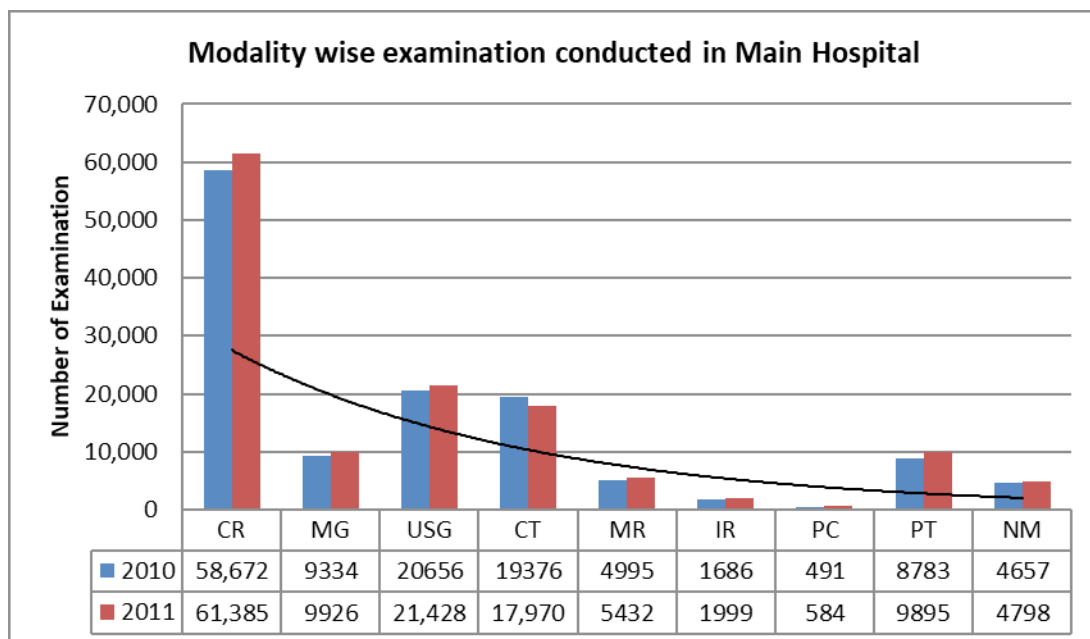
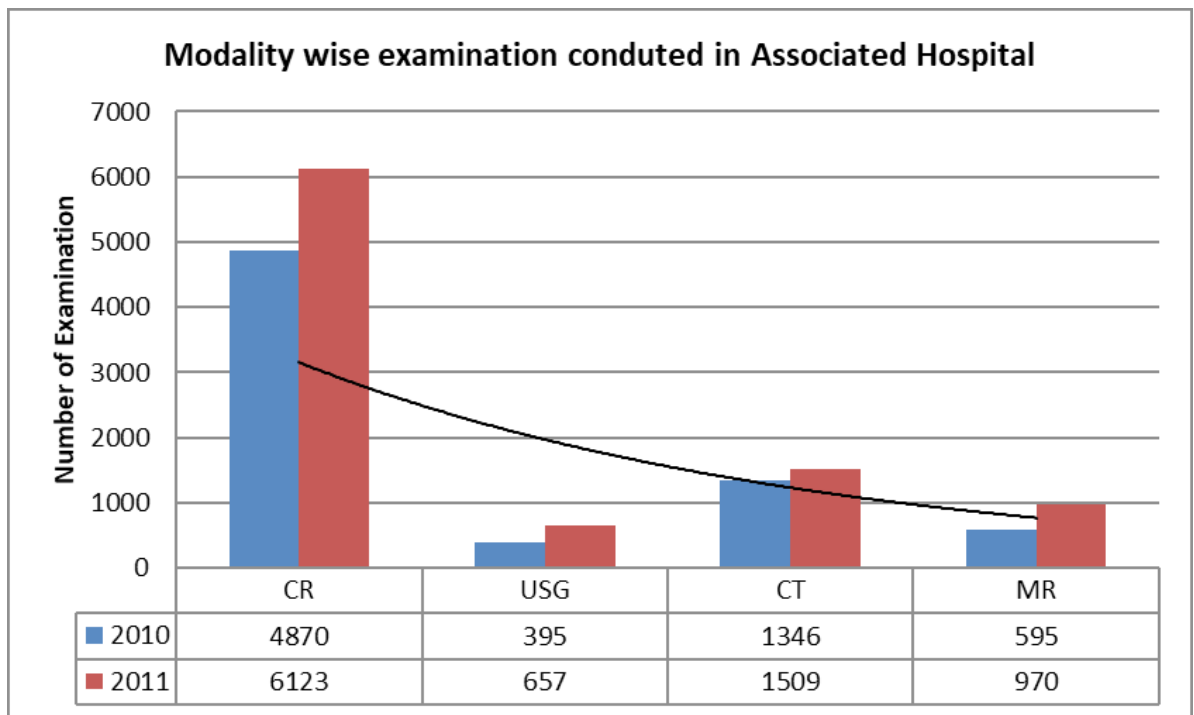
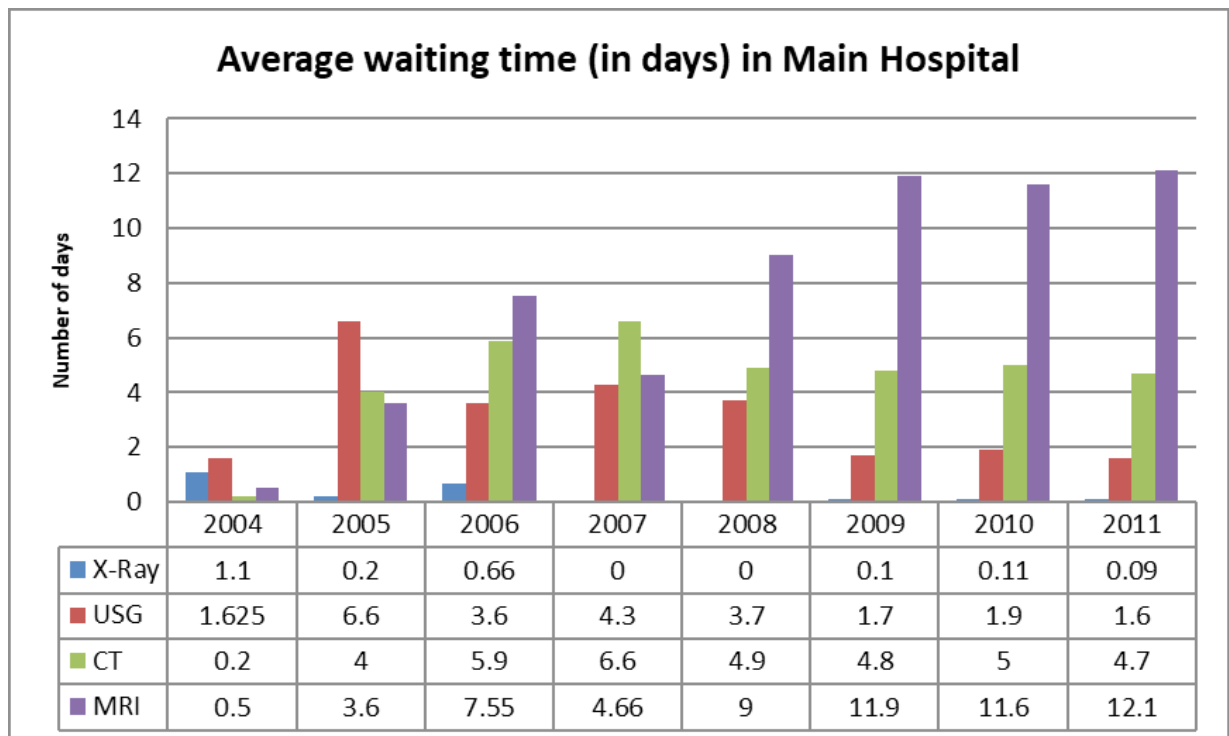


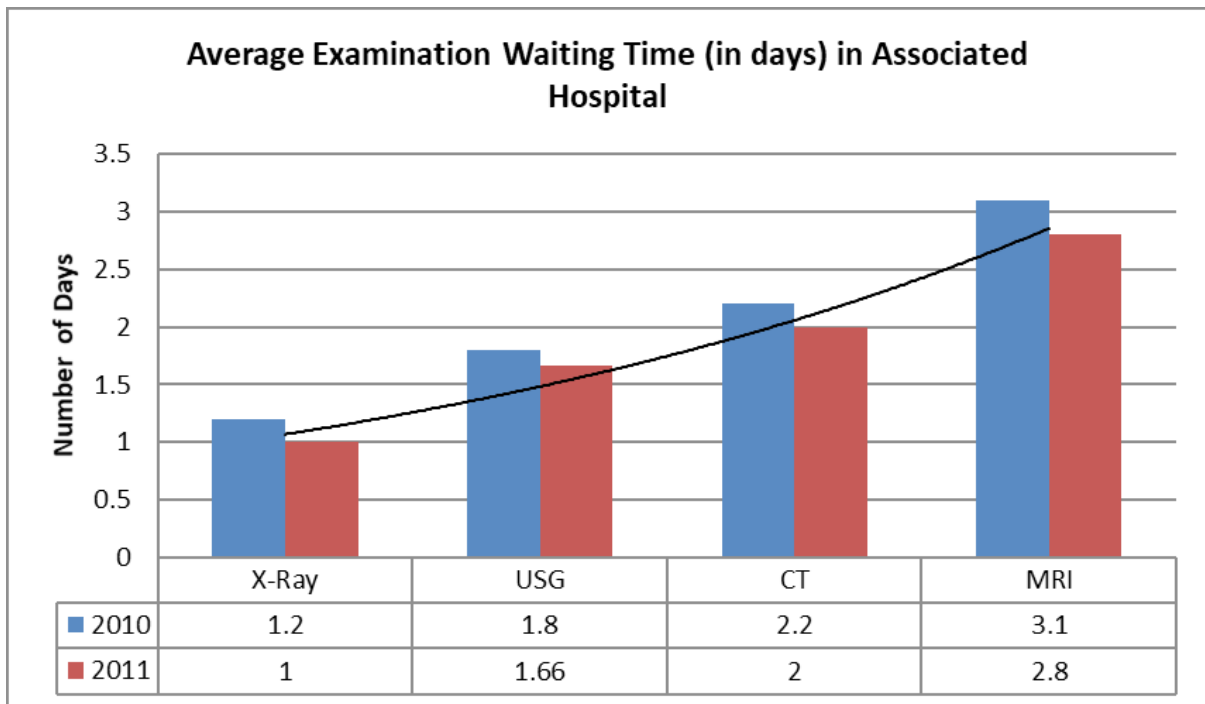
Figure 1. Modality wise Examinations conducted for the Years 2010 & 2011 in Main Hospital



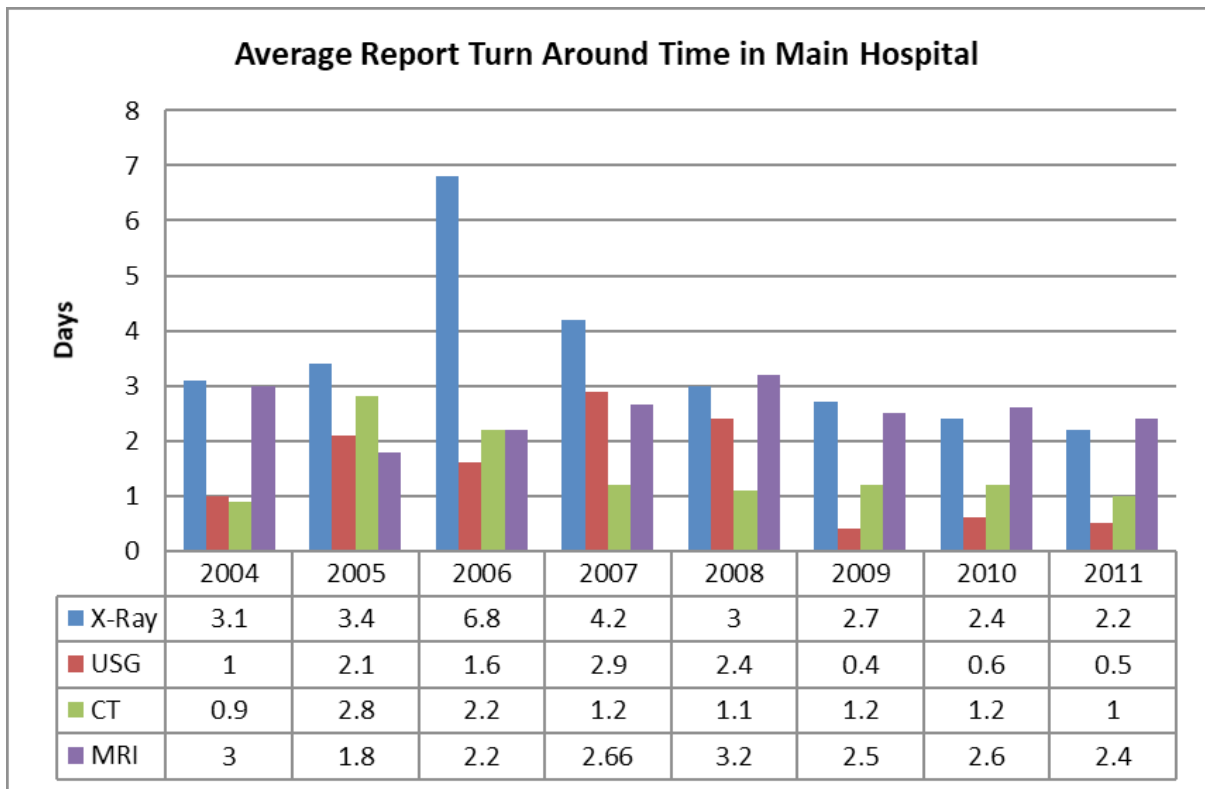
**Figure 2. Modality wise Examinations conducted for the Years 2010 to 2011 in Associated Hospital**



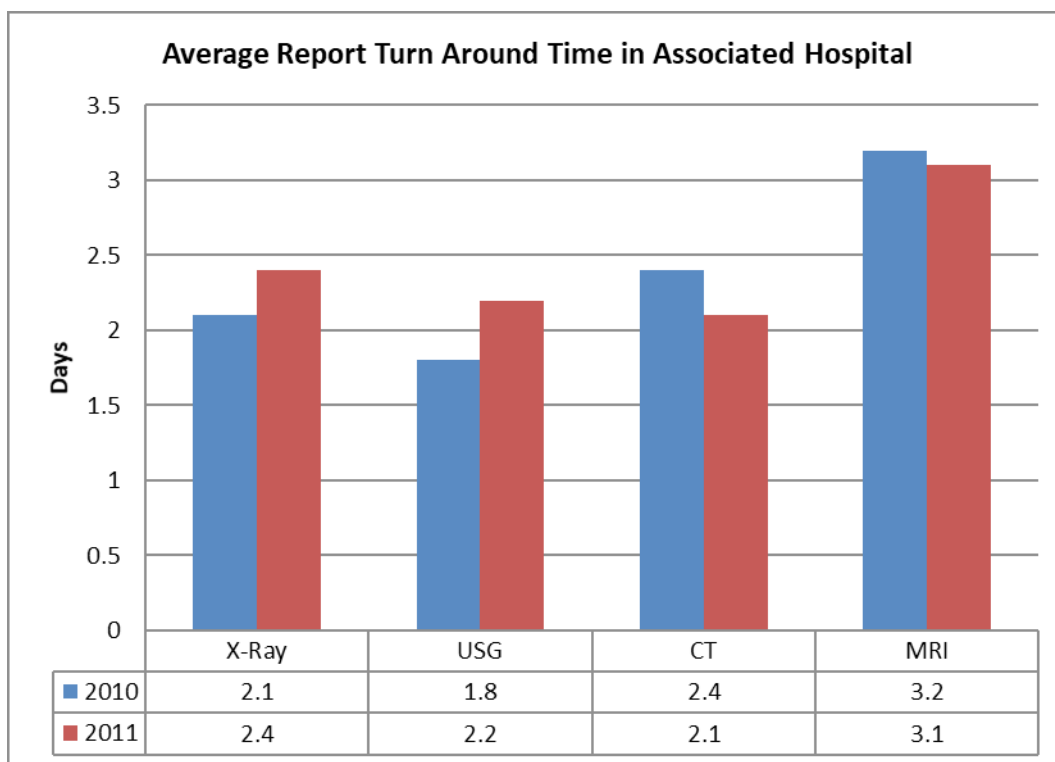
**Figure 3. Average Examination Waiting Time (in Days) in Main Hospital**



**Figure 4. Average Examination Waiting Time (in Days) in Associated Hospital**



**Figure 5. Average Report Turnaround Time (in Days) in Main Hospital**



**Figure 6. Average Report Turnaround Time (in Days) in Associated Hospital**

The findings showed improvement in the TAT following PACS implementation at Main Hospital. A noteworthy improvement had been in the case of X-ray unit which had declined considerably from the peak value of 6.8 days in the year 2006 to 2.2 days in the year 2011. In the case of USG, the TAT had reduced similarly and the reports were available on the same day with an average TAT of 0.5 days. In the case of CT too, the TAT had reduced by more than 50% to 1 day on an average. In the case of MRI, the TAT had reduced from 3 days in the year 2004 to 2.4 days in the year 2011. On the other hand, the TAT in case of Associated Hospital was higher in almost all the modalities. It may be concluded that introduction of PACS in Main Hospital had paid the dividends and the decision to install and implement the PACS in Associated Hospital was a pragmatic one.

**Discussion and Conclusion**

PACS is an integral part of the radiology department of a hospital.<sup>10</sup> Many studies have revealed the reduction in the turnaround time post PACS installation.<sup>11</sup> PACS leads to reduction in waiting time, average length of stay as it speeds up the phases of diagnostic process and reduces the time needed to obtain radiological results.<sup>12</sup> The impact of PACS on the overall efficiency

of delivering imaging services revealed a reduction in the cost per image produced in the face of increasing demand for the service.<sup>9</sup>

PACS will play an important role in the total digital conversion in healthcare, and will improve the quality of patient care delivered to a large extent and lead to the faster decision making.<sup>13</sup> It leads to the reduction in repetitive data entry at different levels. There are significant changes in physician diagnostic behavior after PACS implementation.<sup>14</sup>

The addition of PACS improved availability of alphanumeric preliminary reports of abdominal and pelvic CTs on the HIS, by 85.0%. There was no gross perceived impact with a PACS on the time to final sign reports by a radiologist as signing patterns remained relatively constant over the two interpretation formats. This improvement in turnaround times can be used in justifying PACS.<sup>15</sup>

The study revealed that there was an improvement in the TAT following PACS implementation at Main Hospital. A noteworthy improvement had been seen in the case of X-ray USG, CT and MRI. The TAT in case of Associated Hospital was higher for almost all the

modalities. This was, in fact, the reflection of Pre-PACS era in case of Main Hospital. It may be concluded that the introduction of PACS in Main Hospital had paid the dividends and the decision to install and implement the PACS in Associated Hospital was pragmatic one.

**Conflict of Interest:** Nil

**Source (s) of Support:** Nil

**Ethical Clearance:** The study was conducted as a dissertation for Master in Hospital Administration after administrative approval.

### References

1. Strickland NH. PACS (picture archiving and communication systems): filmless radiology. [cited 2020 Jan 11]; Available from: <http://adc.bmj.com/>
2. Aldosari B. User acceptance of a picture archiving and communication system (PACS) in a Saudi Arabian hospital radiology department. *BMC Med Inform Decis Mak* [Internet]. 2012 Dec 28 [cited 2020 Jan 9];12(1):44. Available from: <https://bmcmedinformdecismak.biomedcentral.com/articles/10.1186/1472-6947-12-44>
3. Ahmadi M, Mehrabi N, Sheikhtaheri A, Sadeghi M. Acceptability of picture archiving and communication system (PACS) among hospital healthcare personnel based on a unified theory of acceptance and use of technology. *Electron Physician* [Internet]. 2017 [cited 2020 Jan 11];2008–5842. Available from: <http://www.ephysician.ir/http://dx.doi.org/10.19082/5325>
4. OECD: Improving Health Sector Efficiency: The Role of Information and Communication Technologies. Paris [Internet]. [cited 2020 Jan 11]. Available from: [www.oecd.org/publishingwww.sourceoecd.org/scienceIT/9789264084605www.sourceoecd.org/socialissues/9789264084605](http://www.oecd.org/publishingwww.sourceoecd.org/scienceIT/9789264084605www.sourceoecd.org/socialissues/9789264084605)
5. Paré G, Trudel M-C. Knowledge barriers to PACS adoption and implementation in hospitals. *Int J Med Inform* [Internet]. 2007 Jan [cited 2020 Jan 11];76(1):22–33. Available from: <http://www.ncbi.nlm.nih.gov/pubmed/16478675>
6. Honeyman-Buck J. PACS adoption. *Semin Roentgenol* [Internet]. 2003 Jul [cited 2020 Jan 11];38(3):256–69. Available from: <https://linkinghub.elsevier.com/retrieve/pii/S0037198X03000452>
7. Mancino PB, Russo TA. What You Need to Know Before Purchasing a PACS. 2007;
8. Buccoliero L, Calciolari S, Marsilio M, Mattavelli E. Picture, archiving and communication system in the Italian NHS: A primer on diffusion and evaluation analysis. *J Digit Imaging*. 2009;22(1):34–47.
9. Sutton L. How PACS Reinvented Radiology. *Health Manage* [Internet]. 2007;7(2). Available from: <https://healthmanagement.org/c/it/issuearticle/key-elements-of-a-successful-pacs-implementation-the-experience-in-england>
10. Berkowitz SJ, Wei JL, Halabi S. Migrating to the Modern PACS: Challenges and Opportunities. *RadioGraphics* [Internet]. 2018 Oct [cited 2020 Jan 10];38(6):1761–72. Available from: <http://pubs.rsna.org/doi/10.1148/rg.2018180161>
11. Marquez LO. Improving medical imaging report turnaround times. *Radiol Manage* [Internet]. [cited 2020 Jan 9];27(1):34–7. Available from: <http://www.ncbi.nlm.nih.gov/pubmed/15794377>
12. van de Wetering R, Batenburg R. A PACS maturity model: A systematic meta-analytic review on maturation and evolvability of PACS in the hospital enterprise. *Int J Med Inform*. 2009 Feb;78(2):127–40.
13. Hood MN, Scott H. Introduction to Picture Archive and Communication Systems. *J Radiol Nurs*. 2006;25(3):69–74.
14. Srinivasan M, Liederman E, Baluyot N, Jacoby R. Saving time, improving satisfaction: the impact of a digital radiology system on physician workflow and system efficiency. *J Healthc Inf Manag* [Internet]. 2006 [cited 2020 Jan 9];20(2):123–31. Available from: <http://www.ncbi.nlm.nih.gov/pubmed/16669596>
15. Mehta A, Dreyer K, Boland G, Frank M. Do picture archiving and communication systems improve Report turnaround times? *J Digit Imaging* [Internet]. 2000;13(1):105–7. Available from: <https://doi.org/10.1007/BF03167637>

# Medico Legal Documentation in a Public Hospital in India: An Analysis of 100 Cases

Vijay Kumar Tadia<sup>1</sup>, Paresh Shekhar Jangale<sup>2</sup>

<sup>1</sup>Senior Resident Administrator, AIIMS, New Delhi, <sup>2</sup>MHA, TISS, Mumbai

## Abstract

**Introduction:** Medico-legal audits are an integral part of hospital/clinical audits and involve examination of the hospital records. The clinical audits aim towards improvement of quality of care and hence are limited to the scrutiny of patient's clinical records. On the other hand, a medico-legal audit aims at the prevention of foreseeable litigations on the hospital and includes the perusal of all the hospital records.

**Aim & Objective:** To carry out the audit of medico legal documentation in a public hospital.

**Methodology:** A retrospective record-based study was conducted in a 2000 bedded public hospital in the month of May-June 2012. 100 documented medico legal cases were considered using simple random sampling. The quantitative data was collected by using a checklist for the audit of medico legal case files. SPSS was used for the analysis of the data.

**Results:** Most of the MLC cases were found to fall in the middle age group of 21-35 years of age (32%) and within that the maximum people contributing to the MLC cases was the sub- group of age between 21-25 years (16.66%). Out of the total recorded sex of the MLC cases, 65.96% were males and 34.04% were females. The highest number of cases recorded were of the RTA (20%) followed by the accidental injury (17%).

**Discussion & Conclusion:** A large number of the cases were of the road traffic accidents (20%) followed by accidental injury (17%), so the emergency department should be kept well equipped to treat such cases. The proportion of the male patients (65.96%) was double as compared to the female patients (34.04%), so the human resource planning of the emergency department can be done accordingly.

**Keywords:** *Medico legal cases, Medical Records, Medico legal record audit, Good Record Keeping*

## Introduction

A high standard of medical record keeping is important for safe patient care and provides information for research, audit and medicolegal purposes.<sup>1</sup>

An MLC is a case of injury/illness where the attending doctor, after eliciting history and examining

the patient, thinks that some investigation by law enforcement agencies is essential to establish and fix responsibility for the case in accordance with the law of the land.<sup>2,3</sup>

Documentation is regarded as an essential element in the legal system of country.<sup>4</sup>

Medico-legal audits are an integral part of hospital/clinical audits and involve examination of the hospital records. The clinical audits aim towards improvement of quality of care and hence are limited to the scrutiny of patient's clinical records. On the other hand, a medico-legal audit aims at the prevention of foreseeable litigations on the hospital and includes the perusal of all the hospital records.<sup>5</sup>

---

### Corresponding Author:

**Vijay Kumar Tadia**

Senior Resident Administrator, AIIMS, New Delhi

e-mail : vijaytadia@gmail.com

**Aim & Objective:** To carry out the audit of medico legal documentation in a public hospital.

### Methodology

A retrospective record-based study was conducted in a 2000 bedded public hospital in the month of May-June, 2012. 100 documented medico legal cases were considered using simple random sampling. The quantitative data was collected by using a checklist for the audit of medico legal case files. SPSS was used for the analysis of the data.

### Results

1. **Recording of the age of the patient:** It was been found that the age of the patient was recorded in 98% of the cases.
2. **The proportion of the Medico-Legal Cases (MLCs) according to age:** Most of the MLC cases were found to fall in the middle age group of 21-35 years of age (32%) and within that the maximum people contributing to the MLC cases was the sub-group of age between 21-25 years (16.66%).
3. **The recording of the sex of the patient:** The sex of the patient was found to be recorded in the 94% of the MLC cases. Out of the total recorded sex of the MLC cases, 65.96% were males and 34.04% were females.
4. **Cause of the medico-legal cases:** It was observed that diagnosis was written on all the case files (100%). The highest number of cases recorded were of the RTA (20%) followed by the accidental injury (17%), a considerable amount of MLCs were recorded when a patient was shifted from a private hospital to the public hospitals (12%).
5. **The Length of stay of a MLC patient:** Most of the MLC patients stayed for 1 to 5 days in the hospital (48%) followed by stay between 6 to 10 days (23%). The Average Length of Stay (ALOS) of the MLC patient in the hospital was 11 days.
6. **Recording of the time of the injury:** The time at which injury happened was recorded in 48% of the cases, it was not recorded in 38% of the cases. The question was not applicable for 14% cases.
7. **Recording of the time at which patient reported to the hospital:** The time at which the patient reported to the hospital was recorded in 99% of the cases and the record was found to be missing in 1 case.
8. **Record of the person accompanying the patient to the casualty:** In majority of the cases, the details of how the patient was brought to the casualty and who was accompanying him/her were not recorded (55%). In the cases where such information was recorded (45), the 93 % of the cases were accompanied by relatives and the rest 7 % were accompanied by the police.
9. **Record of the mental status:** The mental status of the MLC patient was recorded in 46% of the cases and was found missing in rest of the cases (54%).  
  
The majority of the patients who presented to the casualty were conscious (74%), who were in a condition to give the statement at the time of admission while there is were also considerable number of the patients who were not in the condition to give the statement (Semi-Conscious 6.5% & Unconscious 19.5%).
10. **Record of physical injury:** In 70 % of the cases, some form of physical injury was present. In considerable number of the cases there was absence of description of injury with respect to its Type (18.57%), Dimensions (68.58%) and Diagrammatic Representation (44.29%).
11. **The proportion of the MLC cases discharged against medical advice (DAMA):** It was found that 11% of MLC patients were discharged against medical advice (DAMA) but the reasons for the same were not recorded even in one case.
12. **Record of the Occupation of the MLC:** The occupation of the MLC patients were recorded in only 3% of the cases.
13. **Record of the Complaints, History, Pulse and Blood Pressure**  
  
In large number of MLCs, the documents were lacking the recording of the pulse (49%) and the Blood pressure (64%) of the patient. The presenting complaints were not recorded in 2% cases and history was not written in 3% of the cases.

### Discussion & Conclusion

It was found that in many cases the relevant information was found missing or was not recorded while documenting the medico legal case. The court of justice can ask for any data at any point and can even punish the hospital for not maintaining the records of the patient properly. Medical records are acceptable as per

Section 3 of the Indian Evidence Act, 1872 amended in 1961 in a court of law. These are considered as useful evidence by the courts of law as it is accepted that documentation of facts during the course of treatment of a patient is genuine and unbiased.<sup>6</sup>

A large number of the cases were of the road traffic accidents (20%) followed by accidental injury (17%), so the emergency department should be kept well equipped to treat such cases. The proportion of the male patients (65.96%) was double as compared to the female patients (34.04%), so the human resource planning of the emergency department can be done accordingly.

The time at which injury happened was recorded in 48% of the cases. As time at which an injury or an event happens is of great medico legal importance, the recording should be made mandatory for the medical officers.

A considerable number of the patients were not in the condition to give the statement at time of admission (26%), the CMOs should visit them again to elicit history.

A study by Bart S Selden et al considered the history, physical examination, vital signs, mental status, mental impairment and patient refusing care by paramedics in out hospitals.<sup>7</sup>

**Sangeeta Regge** et al in a study concluded that due to ambiguity in the understanding the MLC, more and more health care professionals are looking at MLC as a burden and hence leading to practice of defensive medicine. Their study suggested that there was a need of standard operating procedures in the context of doctors, nurses and police and their respective medicolegal roles.<sup>8</sup>

An audit of operative notes revealed that several operative notes were found incomplete (51.57%) missing important information as CMB code (13.68%), patient details (6.8%) preoperative diagnosis (6.31%), operation title (6.31%) and postoperative instruction (14.73%). Overall, only 92 notes were complete.<sup>9</sup>

A study on good medical record keeping revealed that the Standards measured increased over the 3 audit cycles with 3 of the indicators (writing a date, patient name and hospital number) reached 100%. These results indicate medical note keeping has scope for improvement and auditing can improve standards.<sup>10</sup>

It maybe easy to state that medico-legal audit has

its genesis in 'defensive medicine', but in the era of patient's awareness and judicial litigations, it must be integrated to the functioning of the health care systems.<sup>5</sup>

**Ethical Clearance:** Taken from institute committee

**Source of Funding:** Nil

**Conflict of Interest:** Nil

### References:

1. Chamisa I, Zulu BM. Setting the records straight-a prospective audit of the quality of case notes in a surgical department - PubMed [Internet]. [cited 2020 Sep 6]. Available from: <https://pubmed.ncbi.nlm.nih.gov/17892187/>
2. Meera T. Medicolegal cases: What every doctor should know. *JMS - J Med Soc.* 2016;30(3):133-4.
3. Medicolegal issues : Guidelines to Medical Officers [Internet]. [cited 2020 Sep 5]. Available from: [http://qi.nhsrindia.org/sites/default/files/medico\\_legal.pdf](http://qi.nhsrindia.org/sites/default/files/medico_legal.pdf)
4. Gutheil TG. Fundamentals of medical record documentation. *Psychiatry (Edmont)* [Internet]. 2004;1(3):26-8. Available from: <http://www.ncbi.nlm.nih.gov/pubmed/21191523> <http://www.pubmedcentral.nih.gov/articlerender.fcgi?artid=PMC3010959>
5. Ateriya N, Saraf A, Meshram V, Setia P, Kanchan T, Shekhawat RS. Medico-legal Audit: An essential yet ignored aspect of healthcare in India. *J Indian Acad Forensic Med.* 2019;41(1):53-6.
6. Thomas J. Medical records and issues in negligence. In: *Indian Journal of Urology* [Internet]. Wolters Kluwer -- Medknow Publications; 2009 [cited 2020 Sep 6]. p. 384-8. Available from: <https://pubmed.ncbi.nlm.nih.gov/191523/> <https://pubmedcentral.nih.gov/articlerender.fcgi?artid=PMC2779965>?report=abstract
7. Selden BS, Schnitzer PG, Nolan FX. Medicolegal documentation of prehospital triage. *Ann Emerg Med.* 1990;19(5):547-51.
8. Rege S. Medico-legal cases across various hospitals - A review & understanding of procedures. *Medico-Legal Updat.* 2011;11(2):71-3.
9. Lefter LP, Walker SR, Dewhurst F, Turner RWL. An audit of operative notes: Facts and ways to improve. *ANZ J Surg.* 2008;78(9):800-2.
10. Maiedha R. Good Medical Record Keeping. *Int J Collab Res Intern Med Public Heal.* 2012;4(5):535-43.



# Evaluation of Radiology Information Systems including PACS at Two Tertiary Hospitals in India from User's Perspective

Vijay Kumar Tadia

Senior Resident Administrator, Department of Hospital Administration, AIIMS, New Delhi

## Abstract

Today there has been growing global emphasis on the need for Hospital Management Information Systems (HMIS). Plethora of studies have shown the benefits of implementing HMIS. The RIS is a subset of HIS which is smaller in scale.

**Method:** A comprehensive descriptive qualitative study was undertaken from April 2012 to December 2012. The study setting involved two tertiary care public hospitals (main hospital and an associated hospital) located at different and distant locations in the same city. All the consultants in the department of radiology (11) were interviewed except one who was not available during the period of study and Convenience sampling was used to select other Key Informants. A Structured questionnaire was used to evaluate various aspects of RIS & PACS from the end user's perspective.

**Results:** Overall performance of RIS at main hospital was rated as Satisfactory by 55 percent, neutral by 35 percent and very satisfactory by another 10 percent of the respondents.

Overall performance of RIS at associated hospital was rated as Dissatisfactory by 25 percent, neutral by 70 percent and satisfactory by rest i.e., 5 percent.

**Discussion and Conclusion:** The user feedback is very important for the success of Hospital Management Information Systems, Radiology Information and PACS. The end user should be involved in the decision to introduce technology at the hospital

**Keywords:** Hospital Information Systems, Radiology Information Systems, PACS.

## Introduction

Today there has been growing global emphasis on the need for Hospital Management Information Systems (HMIS)<sup>1</sup>. Plethora of studies have shown the benefits of implementing HMIS<sup>2,3,4,5,6</sup>. The RIS is a subset of HIS which is smaller in scale. RIS equipment consists of a computer system with peripheral devices such as RIS workstations.<sup>7</sup> A picture archiving and communication

system (PACS) is a computerised means of replacing the roles of conventional radiological film: images are acquired, stored, transmitted, and displayed digitally.<sup>8</sup> PACS is becoming a standard component for radiology or hospital information system<sup>9</sup>. The evaluation of RIS and PACS implementation has been done from various perspectives.<sup>10</sup> Various studies also stated that user acceptance is an essential tool before implementing PACS as it greatly determines the success rate.

## Methodology

A comprehensive descriptive qualitative study was undertaken from April 2012 to December 2012. The study setting involved two tertiary care public hospitals (main hospital and an associated hospital) located at different and distant locations in the same

---

### Corresponding Author:

**Dr. Vijay Kumar Tadia**

Senior Resident Administrator, Department of Hospital Administration, AIIMS, New Delhi

e-mail: vijaytadia@gmail.com

city with same radiologists working on rotation basis but different technicians. Both the hospitals were under the same top management control. All the consultants in the department of radiology (11) were interviewed except one who was not available during the period of study and Convenience sampling was used to select other Key Informants: Clinicians (10), Technicians (6), IT Support Team (4), PACS Engineer (1). A Structured questionnaire based on Likert Scale was used to evaluate various aspects of RIS & PACS from the end user's perspective.

## Results

Following were the results of the responses received regarding the Radiology Information System (RIS):

**User Satisfaction:** Overall 75 percent of the end users were satisfied with the performance RIS/HMIS.

**Availability:** About 90 percent of respondents were satisfied with the availability of RIS/HMIS online and said that the downtime of the RIS/HMIS was very less.

**IT failure and Emergency Management:** 45 percent of the respondents were happy with the response to IT failure and the management of contingencies via IT Department.

**Data Protection and Authorization:** 40 percent of the respondents were happy with the safety of the data as well as the authorisation procedures to access the data.

**Clinical Document Availability:** 60 percent of the respondents were satisfied with the kind of availability of the patient related clinical documents on RIS.

**Legal Guidelines:** 60% of the respondents were not satisfied with the kind of legal guidelines available regarding the use of RIS/HMIS. The matter of the fact was that the legal protocol was not made available to the staff and they were not oriented to these aspects as well.

**Response Time:** Around 65 percent of the respondents were satisfied with the response time of the workstations as well as the software programme used in RIS.

**Completeness and Correctness:** Around 85 percent of the respondents were satisfied with the completeness and correctness of the information made available through the RIS.

**Functional Range:** Majority of the users (around

60 percent) were happy with the functional range of the modalities made available through the RIS.

**Redundancy:** 45 percent of the respondents were not aware of the kind of redundancy available with RIS in the hospitals. The respondents (40 percent) who were aware of this fact were dissatisfied with the redundancy of the database.

**Support of Interface Standards:** 55 percent of the respondents were not aware of the support of the Interface Standards. Those aware of this fact (30 percent) were not satisfied with them.

**Ergonomy and Uniformity:** Around 45 percent of the respondents were satisfied with the kind of human-factor engineering (ergonomics) used in the Department.

**Sustainability of Vendor:** 50 percent of the respondents were not satisfied with the type of vendor support provided. This was true for the PACS only as rest of the RIS/HMIS was developed in-situ.

**Continuity of Workflow Support:** 25 percent of the respondents were happy with the kind of workflow support provided by the RIS/HMIS and PACS.

The workstation is an important component of RIS. Following responses were obtained regarding the workstations:

**Overall Performance:** 50 percent of the end users were satisfied with the performance of the Workstations in the Department at both the hospitals

**Speed:** 40 percent of the end users were satisfied with the speed of workstations in both the hospitals.

**Image Quality:** 65 percent of the end users were satisfied with the quality of the images made available via the PACS and 20 percent were very satisfied.

**User Interface ease of use:** 60 percent of the end users were very happy with the user interface provided via HMIS/RIS at both the hospitals.

**Login procedure:** 60 percent of the end users were satisfied with the login procedures for HMIS/RIS workstations. It is important to remember that the end users got individual passwords and the electronic trail was easy to decipher in both the hospitals.

**Worklist Performance:** Around 40 percent of the end users were satisfied with the kind of worklist support

and the scheduling support provided by the RIS with 25 percent being highly satisfied.

**Navigation, Patient & Study Search:** Around 35 percent of the end users were happy with the navigation and search support provided by the RIS/HMIS at both the hospitals.

**Retrieval of previous studies:** Around 45 percent of the end users were happy with the availability of the previous studies through HMIS/RIS.

**Image viewing facilities:** Around 65 percent of the end users were happy with the image viewing facilities made available via the RIS/HMIS and the PACS server.

**Image zoom functions:** Zooming of image is necessary to arrive at the findings sometimes. Around 60 percent of the end users were satisfied with such facilities.

**Length and angle measurements:** 60 percent of the end users were satisfied with the length and angle measurement facilities provided by the RIS/PACS.

**Mirror/Rotate:** 65 percent of the end users were happy with the mirror/rotate functionality made available by RIS/PACS.

**Image annotation:** 65 percent of the end users were satisfied with the Image annotation facility available with RIS/PACS.

**Cine-mode, scroll through a series of images:** 30 percent of the end users were satisfied with such functionality of the RIS/PACS.

**Synchronisation of two images:** Only 25 percent of the end users were satisfied with the available facilities.

**Synchronisaion of a current and previous examination:** 30 percent of the end users were dissatisfied with the synchronisation facility available through RIS/PACS.

**Report Generation:** 70 percent of the end users were happy with the report generation facility available with the RIS/HMIS.

**Dictaphone:** 35 percent of the end users were dissatisfied with the Dictaphone facility available with RIS/PACS. Only one consultant was using the Dictaphone services in the department.

**Computer Aided Diagnosis:** 60 percent of the end

users were very dissatisfied with the Computer Aided Diagnosis (CAD) services available with the RIS/PACS.

The following responses were obtained regarding the reading room:

**Location:** 30 percent of the end users were satisfied with the location of the reading room in radiology department.

**Space:** 45 percent of the end users were satisfied with the space available with the reading room.

**Layout:** 45 percent of the end users were satisfied with the layout of the reading room.

**Lighting:** 40 percent of the end users were happy with the facilities for lighting up the reading room. 10 percent of the respondents were very satisfied.

**Noise Level:** 45 percent of the end users were satisfied with the level of noise control in the reading room.

**Temperature:** 50 percent of the end users were satisfied with the room temperature maintenance.

The following responses related to the Ergonomics:

**General Comfort:** 35 percent of the end users were dissatisfied with the general comfort levels in the reading room.

**Table layout & Space:** 40 percent of the end users were satisfied with the table layout and the space available.

Keyboard, mouse and other device placement

50 percent of the end users were dissatisfied with the way Keyboard, Mouse and other devices were placed on the table tops. Only 15 percent of the end users were satisfied with this arrangement.

**The user's faced the following problems:**

**Irritation/Itching/Strain of Eyes:** 20 percent of the end users did not experience any irritation, itching or strain of eyes. 10 percent of the respondents experienced irritation, itching and strain of eyes after prolonged sitting hours on workstations.

**Pain in Fingers:** 25 percent of the end users did not experience pain in the fingers as typing related work was very limited in the HMIS/RIS and PACS. 10 percent

of the respondents experienced pain in fingers after prolonged workstation usage.

**Backache:** 30 percent of the end users did not experience any backache. 10 percent of the respondents complained of the backache after working on the RIS/HMIS and PACS workstations.

**Pain in Neck:** 10 percent of the end users experienced pain in the neck after prolonged use of the workstations. 30 percent of the users did not experience any such symptoms.

**Other postural problems:** 10 percent of the end users experienced other postural problems. 20 percent of the respondents did not experience any posture related problems. The posture related problems were correlated with the number of hours spent on the workstations as well as the age of the respondents.

The responses for workflow support were as follows:

**Image reading & writing::** 40 percent of the end users were satisfied with the kind of workflow support provided by HMIS/RIS and PACS for image reading and writing.

**Clinical Conference:** 45 percent of the end users were unhappy with the kind of support provided for the clinical conferences. Infact, 25 percent of the respondents were very dissatisfied and remarked that HMIS/RIS and PACS seldom comes handy during clinical conferences.

**Image presentation at Clinical Conference:** 50 percent of the end users were disappointed with the kind of support provided for Image presentation at clinical conferences by the HMIS/RIS and PACS.

**Emergency:** 30 percent of the end users were dissatisfied with the workflow support for the emergency. Another 30 percent of the respondents were very dissatisfied with the available workflow support in case of casualty. Only 15 percent of the end users were satisfied with the available facilities.

**Wards:** 30 percent of the end users were dissatisfied with the kind of workflow support available for the wards. 35 percent of the respondents were very dissatisfied. Only 20 percent of the end users were satisfied with the workflow support available for the wards.

**Outpatient Clinics:** 30 percent of the end users were dissatisfied with the workflow support available for the

Outpatient Clinics. 40 percent of the respondents were very dissatisfied. Only 15 percent of the respondents were satisfied with the workflow support provided by HMIS/RIS and PACS for the Out patient Clinics.

The responses to the system integration between both hospitals:

**Radiology Systems of two hospitals:** Only 5 percent of the respondents were satisfied with the issue of integration of HMIS/RIS at both the hospitals.

**RIS with HIS of same hospital:** 15 percent of the end users were dissatisfied with the integration of HMIS and RIS in main hospital as well as in associated. Another 10 percent were very dissatisfied.

**RIS of one with HIS of another hospital:** 45 percent of the end users were very dissatisfied with the end result of the integration of RIS of one hospital with the HMIS of another hospital.

**RIS with PACS of the same hospital:** 20 percent of the end users were dissatisfied with the integration of RIS with the Patient Administration System (PAS) in the same hospital be it main hospital or associated hospital .

**RIS of one hospital with another hospital:** 40 percent of the end users were dissatisfied with the outcome of the integration of RIS of main hospital with the associated hospital and vice-versa. Another 35 percent of the respondents were very dissatisfied with the end result of such an integration.

**RIS with DIS of the same hospital:** 20 percent of the end users were dissatisfied with the way in which the integration between RIS and the Diagnosis Information System (DIS) worked. Another 10 percent were very dissatisfied with the outcome of such an integration.

**RIS of one hospital with DIS of another hospital:** 40 percent of the end users were very dissatisfied with the outcome of the integration of RIS of one hospital with DIS of another hospital. Another 25 percent of the respondents were dissatisfied with the end result of integration of RIS of main hospital with DIS of associated and vice-versa.

**RIS with EMR of same hospital:** 35 percent of the end users were dissatisfied with the outcome of integration of the RIS with Electronic Medical Records (EMR) of the same hospital be it main hospital or associated

hospital. Another 10 percent of the respondents were very dissatisfied with such an integration of RIS/HMIS and EMR.

**RIS with EMR of another hospital:** 45 percent of the end users were very dissatisfied with the outcome of the integration of RIS with EMR of main hospital with associated hospital and vice-versa. Another 25 percent of the respondents were dissatisfied with the outcome of such an integration.

**Smart Card – Synchronization with RIS data:** 75 percent of the end users were very much dissatisfied with the lack of synchronisation of smart card with the RIS.

**Data Transmission – Rate of transmission between two hospitals:** 15 percent of the end users were satisfied with the data transmission rates between main hospital and associated hospital. Another 5 percent were dissatisfied with the rate of data transmission between the two hospitals.

The following were the responses to data transmission aspect:

**Availability of Data transmission:** 15 percent of the end users were satisfied with uptime of the data availability between both the hospitals.

**IT support in case of failure of data transmission:** 55 percent of the end users were dissatisfied with the support provided by Department of Information Technology in the case of failure of the data transmission. Another 10 percent of the respondents were very dissatisfied with the IT support in case of failure of the data transmission.

Following were the responses to Web Interface aspect:

**Availability:** 60 percent of the end users were very dissatisfied with the lack of availability of Web Interface in both the hospitals. Another 20 percent of the respondents were dissatisfied with the lack of availability of web interface for online data exchange.

**Delivery of Results:** 65 percent of the end users were very dissatisfied with the web interface for providing delivery of the results of various investigations undertaken.

The advantages felt by the user's:

**Saves time:** Most of the end users (60 percent) replied in affirmative that the RIS/HMIS and PACS saves lot of time. Another 35 percent were very satisfied with the advantage of saving time.

**Saves Cost:** 65 percent of the end users agreed that RIS/HMIS and PACS brings cost cutting via decreasing the need of films and paper etc.

**Increases Productivity:** 65 percent of the end users agreed that RIS/HMIS and PACS increases productivity. Another 35 percent of the respondents were very bullish about this fact.

**Storage:** 60 percent of the end users replied in affirmative that storage of the data becomes easy and requires lesser space. Another 40 percent of the respondents were very satisfied with the fact that storage becomes easy as lesser number of films and paper records had to be maintained.

**Decrease HR:** 35 percent of the end users responded that requirement for human resources had reduced after the implementation of HMIS/RIS and PACS. Another 25 percent very strongly agreed to this fact.

**Scheduling:** Most of the end users agreed to the fact that HMIS/RIS help in scheduling.

**Analysis:** 45 percent of the end users agreed that RIS/HMIS helped in analysis of the data. Another 25 percent strongly agreed to this fact.

**Resource allocation & budgeting:** 50 percent of the end users agreed that RIS/HMIS helped in resource allocation and budgeting exercise. Another 15 percent of the respondents strongly agreed to this fact.

**Billing/Account Receivable:** 35 percent of the end users agreed that RIS/HMIS helped in billing and managing accounts receivables with 15 percent vouching strongly in its favour.

**Patient Tracking:** 55 percent of the end users agreed that RIS/HMIS helps in tracking the patients with additional 15 percent agreeing very strongly.

**Modality & Material Management:** 50 percent of the end users agreed that RIS/HMIS and PACS helps in modality and material management. Another 10 percent of the respondents agreed strongly to this fact.

**Alerts:** 45 percent of the end users agreed that RIS/HMIS and PACS alerts help in better patient

management. In addition, 10 percent of the respondents agreed very strongly to this advantage of HMIS/RIS and PACS.

### **Comparison of overall performance of RIS:**

#### **Overall performance of RIS at main hospital:**

Overall performance of RIS at main hospital was rated as Satisfactory by 55 percent, neutral by 35 percent and very satisfactory by another 10 percent of the respondents.

#### **Overall performance of RIS at associated hospital:**

Overall performance of RIS at associated hospital was rated as Dissatisfactory by 25 percent, neutral by 70 percent and satisfactory by rest i.e., 5 percent.

### **Responses to miscellaneous aspects:**

#### **Patients' Compliance:**

As far as the patients compliance to paperless and filmless milieu via HMIS/RIS and PACS is concerned, 35 percent of the end users were strongly dissatisfied, another 35 percent were dissatisfied and only 10 percent were satisfied with the patient compliance to filmless and paperless milieu.

**Amendments:** As far as amendments to the existing software programs were concerned, 50 percent of the end users were very dissatisfied with the existing scheme of things to update anything as it required a lengthy procedure and lot many permissions from higher authorities.

**Cross-Referrals:** 45 percent of the end users were very dissatisfied, another 20 percent of them were dissatisfied with the existing cross-referral functionality built within the RIS/HMIS and PACS.

**Training:** 60 percent of the end users were very dissatisfied with the training facilities for the staff in both the hospitals.

## **Discussion**

It is essential to integrate HIS/RIS to PACS so that it combines patient's data with the respective image and the entire set of data with image makes considerable sense to the end user collectively.<sup>10</sup> There have been cases in the hospitals where the PACS server was down and the clinicians were not able to review any images until the server was retrieved. It led to enormous trouble to the patients and the doctors themselves.<sup>11</sup> Few studies

report the downtime issues which were not substantiated by a very authentic and satisfactory recovery solutions.<sup>12</sup>

Many of the respondents were not satisfied (60%) with the kind of legal guidelines available regarding the use of RIS/HMIS. The matter of the fact was that the legal protocol was not made available to the staff and they were not oriented to these aspects as well.

Redundancy refers to the backing up or copying data on additional servers or by other electronic means as a security measure. Most of the respondents (45 percent) were not aware of the kind of redundancy available with RIS in the hospitals.

Image quality is very important aspect of the PACS. 65 percent of the end users were satisfied with the quality of the images made available via the PACS and 20 percent were very satisfied. Thus, the overall quality of images was good. Ease of use of any HMIS/RIS is very important. Around 60 percent of the end users were very happy with the user interface provided via HMIS/RIS at both the hospitals.

Cine-mode and scroll through a series of images helps a lot in appreciation of images and arriving at the correct findings. 30 percent of the end users were satisfied with such functionality of the RIS/PACS.

Synchronisation of two images aids in radiology diagnosis. Only 25 percent of the end users were satisfied with the available facilities. Synchronisation of different examinations is also important. 30 percent of the end users were dissatisfied with the synchronisation facility available through RIS/PACS.

30 percent of the end users were satisfied with the location of the reading room in radiology department. Overall performance of RIS at main hospital was rated as Satisfactory by 55 percent, neutral by 35 percent and very satisfactory by another 10 percent of the respondents.

Overall performance of RIS at associated hospital was rated as Dissatisfactory by 25 percent, neutral by 70 percent and satisfactory by rest i.e., 5 percent.

Training of the staff is very essential component to make use of any Information Technology product. As far as training in HMIS/RIS and PACS is concerned, both the hospitals were found lacking in this crucial aspect. Around 60 percent of the end users were very dissatisfied with the training facilities for the staff.

Various studies also stated that user acceptance is an essential tool before implementing PACS as it greatly determines the success rate and also stated the importance of training or familiarization programs should be given utmost importance in order to motivate the employees ultimately increasing the productivity of the system.<sup>9</sup>

**Conflict of Interest:** Nil

**Source (s) of Support:** Nil

**Ethical Clearance:** The study was conducted as a dissertation for Master in Hospital Administration after administrative approval.

### References

1. Mukherjee K, Babu PA. Economic evaluation of hospital management information systems in Tamil Nadu, India. *Int J Med Public Heal*. 2014;4(3):269.
2. Hillestad R, Bigelow J, Bower A, Girosi F, Meili R, Scoville R, et al. Can electronic medical record systems transform health care? Potential health benefits, savings, and costs. The adoption of interoperable EMR systems could produce efficiency and safety savings of \$142-\$371 billion. *Heal Aff*. 2005;24(5):1103–17.
3. Wang SJ, Middleton B, Prosser LA, Bardon CG, Spurr CD, Carchidi PJ, et al. A cost-benefit analysis of electronic medical records in primary care. *Am J Med*. 2003 Apr 1;114(5):397–403.
4. Frisse ME, Holmes RL. Estimated financial savings associated with health information exchange and ambulatory care referral. *J Biomed Inform*. 2007 Dec;40(6 SUPPL.).
5. Shekelle PG, Morton SC, Keeler EB. Costs and benefits of health information technology. Evidence report/technology assessment. 2006. p. 1–71.
6. Kian LA, Stewart MW, Bagby C, Robertson J. Justifying the cost of a computer-based patient record. *Healthc Financ Manage* [Internet]. 1995 Jul [cited 2020 Jan 26];49(7):58–60, 62, 64–7. Available from: <http://www.ncbi.nlm.nih.gov/pubmed/10143674>
7. Huang HK. Integration of HIS, RIS, PACS, and ePR. *PACS Imaging Informatics*. 2010;387–407.
8. Strickland NH. PACS (picture archiving and communication systems): filmless radiology. [cited 2020 Jan 11]; Available from: <http://adc.bmj.com/>
9. Aldosari B. User acceptance of a picture archiving and communication system (PACS) in a Saudi Arabian hospital radiology department. *BMC Med Inform Decis Mak* [Internet]. 2012 Dec 28 [cited 2020 Jan 9];12(1):44. Available from: <https://bmcmedinformdecismak.biomedcentral.com/articles/10.1186/1472-6947-12-44>
10. Buccoliero L, Calciolari S, Marsilio M, Mattavelli E. Picture, archiving and communication system in the Italian NHS: A primer on diffusion and evaluation analysis. *J Digit Imaging*. 2009;22(1):34–47.
11. Mcbiles M, Chacko AK. Coping With PACS Downtime in Digital Radiology. 2000;
12. van de Wetering R, Batenburg R. A PACS maturity model: A systematic meta-analytic review on maturation and evolvability of PACS in the hospital enterprise. *Int J Med Inform*. 2009 Feb;78(2):127–40.

# Spinal Region Segmentation for Intervertebral Distance of X-Ray Images Using Spectral Analysis

Virendra Singh<sup>1</sup>, Vineeta Saxena Nigam<sup>2</sup>

<sup>1</sup>Research Scholar, Dept. of Electronics and Communication Engg., UIT RGPV, Bhopal, India,

<sup>2</sup>Professor & Head, Dept. of Electronics and Communication Engg., UIT RGPV, Bhopal, INDIA<sup>2</sup>

## Abstract

Physics plays a vital role in cultivating the knowledge of natural sciences and establishing the foundation of logistic and scientific method. The application of physics to medical sciences has been developed in practice for centuries. X-Ray, CT scan and MRI images of the spine provide a practical approach for detecting and assessing vertebral abnormalities. For accurate vertebra detection number of features of an image can be extracted and meaningful information can be obtain from low level information in the image using segmentation. In this paper a method is proposed for making treatment of spinal traction efficient and feasible by using image processing algorithm based on the data obtained from the survey and images of the patients.

**Keywords:** *Spinal Traction, Hough transform, segmentation, spectral transformation and Survey report.*

## Introduction

With the time, as there is advancement in medical technology, there is also a huge increment in number of physical disabilities and diseases. Among them some are curable and some aren't. Now a day's researchers are more concerned in finding the cure of major diseases like Cancer, HIV AIDs, and Diabetes etc. But still there are some common problems which needs attention like Low back pain, disk herniation, sub-acute pain etc. As work load is increasing, problem of low back pain & sub-acute pain and issues related to spinal cord are also growing simultaneously. Ignorance of such pain becomes chronic disease which not only affect our spine, but also affect our work, afterwards it become major symptoms of disabilities. Low back pain is further classified as acute or sub-acute lower backpain and chronic lower back pain. Acute back pain generally last for 2-3 weeks because of which people don't give it much attention but chronic treatment of chronic lower back pain is too difficult, that even surgery can't provide permanent relief.<sup>[1][2]</sup>

The diagnosis and treatment of lower back pain, disk herniation, and muscular spasm, etc. thus become a major problem. Lumbar and cervical disk herniation is one of the most common causes of lower back pain and it is often caused in the weakest part of the disk i.e. posterolateral side.

Lumbar and cervical traction is most preferred treatment of lumbar and cervical disk herniation but its effectiveness as a part of physical therapy is a matter of discussion.

**Literature Review:** Research done in clinics indicates that disc is responsible for majority of lumber and cervical pains. Compression decreases intradisc space and increases pressure between intervertebral disc leading to annular compromise and possible extrusion of nuclear material<sup>[5]</sup>.

Now a day's Traction using Decompression Therapy becomes an effective method of treatment in spinal traction. In the spinal decompression therapy, spinal disc can be isolated and negative pressure is applied by cycling through distraction and relaxation phases, this causes a vacuum effect within it.

Disc disorders are often connected to spinal trauma. Trauma arises in neck due to head injuries caused during accidents and falls. As the brain stem regulates the postural muscles of the spine, any injury in the upper portion of the neck can affect brain's normal control over the postural muscles, which leads to muscular weakness, atrophy and spasm throughout the neck and back.<sup>[6]</sup> Author gives a new approach in which two diagnostic tools are used for analysis of injuries in upper cervical



region –Para spinal Digital Infrared Imaging and Upper Cervical Radiography . Magnetic Resonance Imaging is effective technique for detecting fractures, pseudoarthrosis, and infections [7]. Three-dimensional imaging tests like MRI and CT scan, is ideal for analyzing & visualizing pathology of the IVD (intervertebral disc), neural structures such as the spinal cord. Imaging method provide superior structural information and a better resolution[8]. Schmitz et al. [9] proposed a new method in which semiautomatic image analysis routine is used to analyze dendrite and synapse characteristics in immune-fluorescence images. Another method effective in reducing pain or improving intervertebral motions is HVLA-SM(High velocity low amplitude spinal manipulation)[10].

**Objective:** As X-ray image of spine are very noisy and of low contrast, the extraction of geometric features from images is very common problem. Over the years, several different approaches have been devised to extract these features. In present scenario the treatment(traction) given for spine problems is based on the experiences of physiotherapist and the ranges predefined in literature. Sometimes the treatment becomes inefficient and also cause several other adverse effect. In present scenario none of the method used for treatment combined images

and physics together. The key objective of this research is to develop an algorithm for efficient traction treatment using image processing algorithm. With the help of this algorithm we will be able to calculate the exact amount of force which is required, after considering the age, weight and other factors, to fulfill the treatment of spinal traction. This will provide accuracy and efficiency in the methodology of traction treatment applied.

- The traction therapy will be more accurate & efficient.
- It will be economical as the number of therapies to be provided would be less thus reducing the charges to be paid multiple times.

**Survey Report:** To find the accuracy of traction treatment a small survey is conducted under which data of 84C-spine vertebrae were collected and studied. Following observations are mentioned below:

For cervical traction the force to be applied is 1/7th part of body weight and for lumbar traction the force applied i.e. 1/3rd of body weight as per defined in various literature. The following data were taken from Narmada Trauma Centre(Bhopal) and Rajiv Gandhi Hospital (Trilanga, Bhopal).

**Table 1 Survey Report of Some Patients Who were Going Under The Treatment of Traction.**

Patient Number (Male/Female)	Age of patient (in years)	Body Weight (in kg)	Type of traction	Applied Weight (in kg)
Patient 1 (Male)	42	65	Cervical	7
Patient 2 (Female)	40	55	Lumbar	20
Patient 3 (Male)	35	55	Cervical	6
Patient 4 (Male)	57	68	Cervical	8
Patient 5 (Female)	24	58	Cervical	6
Patient 6 (Female)	23	62	Cervical	6
Patient 7 (Male)	40	52	Cervical	6
Patient 8 (Female)	55	70	Cervical	8
Patient 9 (Female)	51	75	Lumbar	25
Patient 10 (Male)	51	90	Cervical	10
Patient 11 (Female)	56	70	Cervical	5
Patient 12 (Male)	50	75	Cervical	8
Patient 13 (Male)	23	59	Cervical + Shoulder pain	8
Patient 14 (Male)	42	60	Cervical	2
Patient 15 (Male)	55	60	Lumbar	20
Patient 16 (Male)	55	75	Lumbar	25

This data leads to us to do work for the improvement of traction treatment.

### Methodology

Detection of accurate vertebra is most important for efficient spinal column diagnosis. In this paper we focus on one section of the spine i.e cervical spine. Primary objective of this research is to find intervertebral posterior height using image processing algorithms. The proposed approach is the hybrid approach in which the results obtained from image processing algorithm is combined with the physics behind the traction therapy,

inorder to develop an generalized approach to calculate exact amount of force which is to be given to patient in case of cervical traction.

The intervertebral disc(IVD) is comprised of three distinct components: (a)the annulus fibrosus, (b) the nucleus pulposus, and (c)the cartilaginous endplates. The annulus fibrosus is the tissue of the intervertebral disc that surrounds the nucleus pulposus and forms the outer portion of the disc. Due to compressive load the posterior section of the intervertebral disc will undergo tension loading that causes the annulus to contract toward the center of the disc (White and Panjabi, 1990).

**Table 2: Shows the intervertebral height for cervical spine**

Study\	IVD Height	C23	C34	C45	C56	C67	C7T1
Gitad and Nissan, 1986	Anterior	4.8 mm	5.3 mm	5.5 mm	5.4 mm	5.2 mm	4.7 mm
	Posterior	3.4 mm	3.3 mm	3.0 mm	3.0 mm	3.3 mm	3.5 mm
Przybylski et al, 1998	Anterior	5.2 mm	5.3 mm	5.2 mm	4.6 mm	4.9 mm	
	Posterior	3.4 mm	3.4 mm	3.7 mm	3.9 mm	4.3 mm	

Due to load, the intervertebral posterior height reduces. In this research, image processing algorithm are used to detect the intervertebral posterior height. If the intervertebral space is less then 3mm, mathematical algorithm runs to calculate the amount of traction force that is to be applied on the patient under medical supervision.

The proposed method consists of the following steps that will be applied to spinal images .a. Pre-processing stage includes- image acquisition, region localization (RL) and region localization enhancement.b. Shape boundary representation and segmentation stage-include GHT(Generalized Hough transform)

**Performance Measures:** Statistical parameters to calculate the performance of a binary classification are Sensitivity and specificity.

Standard formulas were used to measure accuracy, sensitivity and specificity.

$$ACC = \frac{(TP + TN)}{(FP + TN) + (TP + FN)}$$

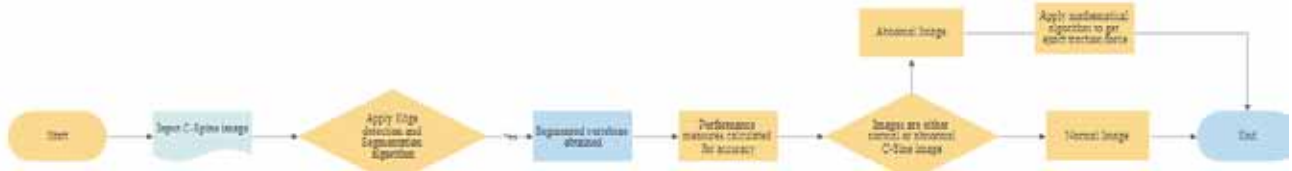
$$Sensitivity = \frac{TP}{(TP + FN)}$$

$$Specificity = \frac{TN}{(FP + TN)}$$

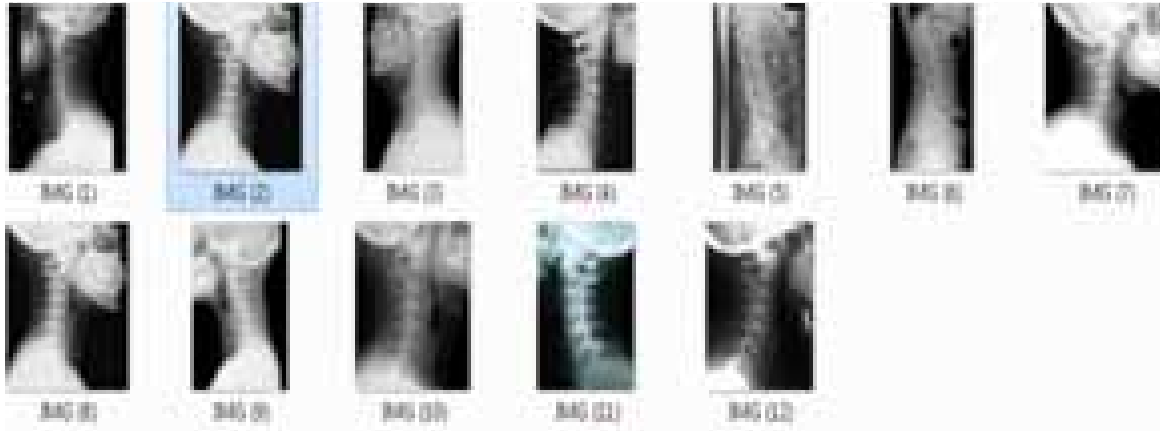
**Jaccard Coefficient:** The Jaccard coefficient measures similarity between finite sample sets, and is defined as the size of the intersection divided by the size of the union of the sample sets

**Dice Coefficient:** The Sorensen–Dice index, is a statistic used for comparing the similarity of two samples.

Flow chart for developing an algorithm for Spinal Tracton

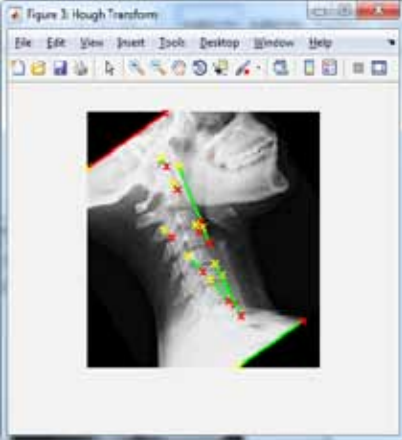
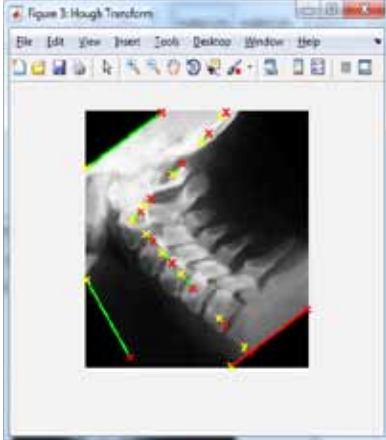
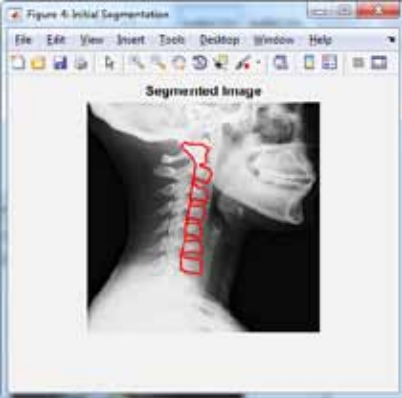
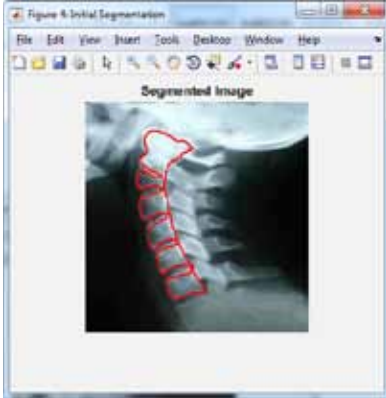
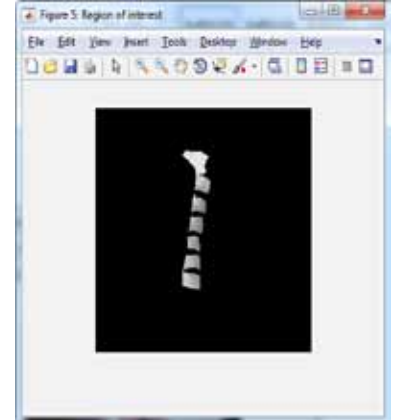
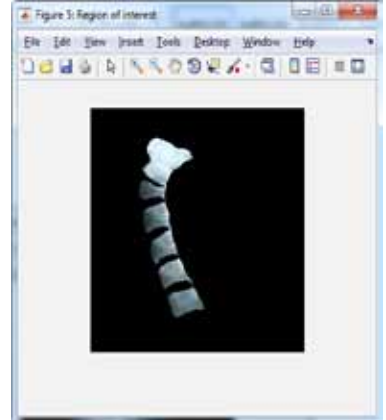

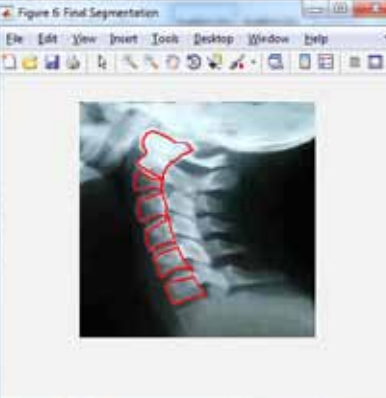


**RESULTS**



**Fig. 3: Image database in Matlab**

Normal image	Abnormal Image

Normal image	Abnormal Image
	
	
	
	

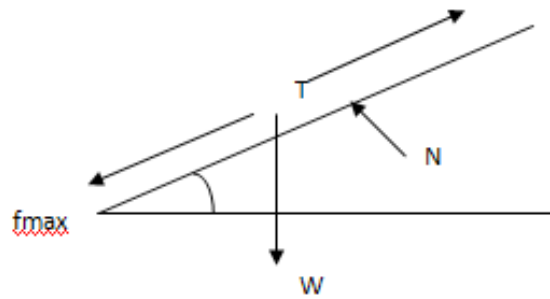
Normal image	Abnormal Image
<pre> Sensitivity : 97.410021% Specificity : 100.000000%  Correct Classification : 97.434999%  ===== Jaccard coefficient : 97.434999 %  Dice coefficient : 98.700837 %  ===== &gt;&gt; &gt;&gt; C1 &amp; C3 = 1.3188 C3 &amp; C4 = 2.3357 C4 &amp; C5 = 3.4211 C5 &amp; C6 = 3.5403                     </pre>	<pre> Sensitivity : 95.165947% Specificity : 100.000000%  Correct Classification : 95.350647%  ===== Jaccard coefficient : 95.350647 %  Dice coefficient : 97.619996 %  ===== &gt;&gt; &gt;&gt; C2 &amp; C3 = 0.87963 C3 &amp; C4 = 0.82671 C4 &amp; C5 = 0.98039 C5 &amp; C6 = 1.1337                     </pre>

Fig. 4: Results of image analysis

### Result Analysis

Fig 4 shows that in abnormal cervical image the intervertebral posterior height calculated is less than 3mm. In such condition an algorithm is applied in order to calculate traction force which may be applied to the patient under medical supervision.

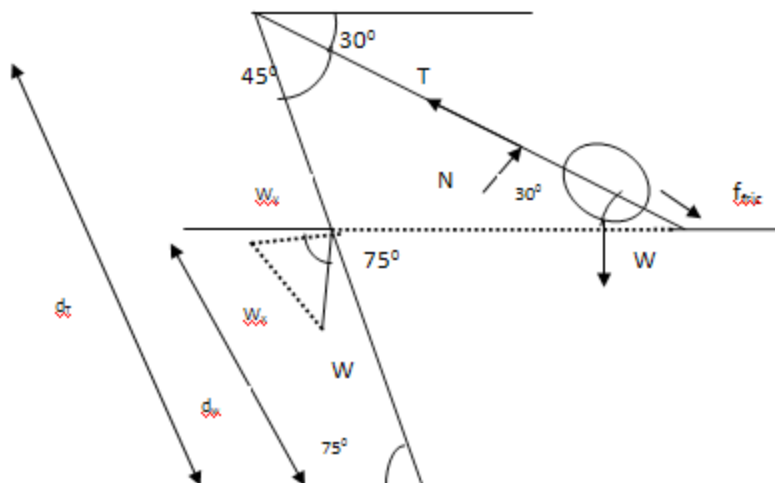
#### Mathematical calculation



$$N = w \cos 30^\circ$$

$$T = f_{max} + W \sin 30^\circ$$

$$f_{max} = \mu N$$



Free body diagram of traction machine setup

Below calculations are based on the traction machine setup, i.e distance from ground, machine weight and total height.

The cervical traction is applied to a patient; traction force is developed in backward while maintaining the system in equilibrium.

Machine weight =15 kg

Center of mass height from ground= 102cm (max)

If the distance from bottom to the center of mass is 102cm, then the total height from where force is applied is 173cm as distance from bottom to the center of mass 59% of total height.

From the free body diagram establishing momentum equation about the bottom

$$T_y \cdot d_T = W_y \cdot d_w$$

Where:the distance from the bottom to the center of mass is

$$d_w = 59\% \text{ of } 1.73\text{m} = 1.02\text{m and}$$

$$d_T = 85\% \text{ of } 1.73\text{m} = 1.46\text{m therefore}$$

$$T_y \cdot d_T = W_y \cdot d_w$$

$$T \sin 45^\circ \cdot d_T = W_y \cdot d_w$$

$$(f_{max} + w \sin 30^\circ) \sin 45^\circ \cdot 1.46 = W \cos 75^\circ \cdot 1.02$$

$$\text{As } f_{max} = \mu \cdot N$$

In this paper for two body weight of a patient calculations are done

Body weight is 70kg and 75kg, so head weight i.e 8% of the total body weight are 5.6kg and 6kgs respectively.

$$(\mu \cdot N + w \sin 30^\circ) \sin 45^\circ \cdot 1.46 = W \cos 75^\circ \cdot 1.02$$

Where  $N = W \cos 30^\circ$ , here  $w$  is weight of the head of a patient

$$\text{And the value of } \mu = 0.2$$

Now equating the values in the equation

$$(\mu \cdot W \cos 30^\circ + w \sin 30^\circ) \sin 45^\circ \cdot 1.46 = W \cos 75^\circ \cdot 1.02$$

$$(0.2 \cdot 5.6 \cos 30^\circ + 5.6 \sin 30^\circ) \sin 45^\circ \cdot 1.46 = W \cos 75^\circ \cdot 1.02$$

The exact  $W$  i.e traction weight can be calculated as

$$W = \frac{[(0.2 \cdot 5.6 \cos 30^\circ + 5.6 \sin 30^\circ) \sin 45^\circ \cdot 1.46]}{\cos 75^\circ \cdot 1.02}$$

$$W = 14.7\text{kgs}$$

Accuracy recognition comparison between the study of Gilad & Nissan, 1986, Przybylski et al,1998 and Present Research.

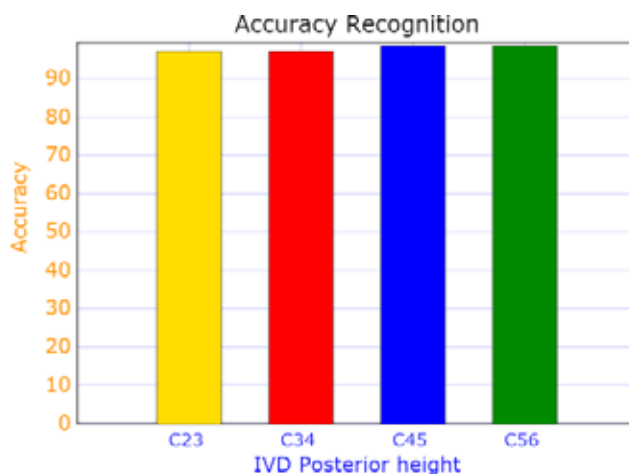


Fig 5: Accuracy Recognition Chart

Discussion

As discussed earlier, the current methodology of applying traction is not the accurate method as not all the parameters are considered while applying force on the body. This method at present is just based on hit and trial which can be done by the experienced physiotherapists only, as there is a huge probability of error if practiced by any inexperienced doctor. The machines that are used to apply weight during the therapy simply apply force, fed to them as an input by the therapist, which is calculated on the basis of body weight, age and sex of the patient. Hence this therapy need some changes for improvement, in medical practice to improve decision-making by matching a treatment to a specific sub-group of patients Clinical prediction rules (CPR) are commonly used [11]. To make it more efficient and accurate method for experienced as well as inexperienced physiotherapists to study. The force applying machines should work automatically on the basis of the patient's physical status and not much interference, in calculation, of the therapists should be involved. A user-friendly

interface will be also built for usability improvement and enhancement<sup>[12]</sup>.

## Conclusion

On the basis of this algorithm machines can also be designed which can apply calculated force automatically. Thus reducing manual work and reduction in manual interference will lead to lesser error in the traction process.

**Future Scope:** A Clinical prediction has been developed which will improve decision-making and reduce time & cost<sup>[11]</sup>. Considering the advantages (feasible, accurate and economic) of the goal, if achieved, this may be used to develop traction machines in future which will be algorithm based and would work automatically on the basis of the factors to be considered while applying the therapy. This will also reduce the duration and frequency of treatment to be applied to a patient.

**Ethical Clearance:** Dataset have been collected from hospital, no involvement of human subject is done in research. LOR is received from Rajiv Gandhi Physiotherapy College, Bhopal

**Source of funding:** self

**Conflict of Interest:** nil

### References

- [1]. Ehrlich GE, Khaltayev NG. Low back pain initiative Geneva: World Health Organization; 1999.
2. George E. Ehrlich, "Low Back Pain," Bulletin of the World Health Organization 2003, 81 (9)
3. Heaven Stubblefield, Published on January 14, 2014 Available at: <http://www.healthline.com/health/spinal-traction#Overview1>
4. Wong, L.K.F., "Cervical Spine Simulation model for Traction Therapy Analysis," System Integration (SII), 2013 IEEE/SICE International Symposium, pg. no.516 – 520
5. Hopkins clinic report on spinal decompression therapy, Available at: <http://www.hopkinsclinic.com/decompression-therapy-dts.html> Adams MA, Freeman BJ, Morrison HP. Mechanical initiation of intervertebral disc degeneration. Spine 2000 Jul 1; 25(13): 1625-36.
6. Adams MA, Freeman BJ, Morrison HP. Mechanical initiation of intervertebral disc degeneration. Spine 2000 Jul 1; 25(13): 1625-36.
7. Bagchi K, Mohaideen A, Thomson JD, Foley LC. Hardware complications in scoliosis surgery. *Pediatr Radiol.* 2002;32:465-475.
8. Runshengwang & Michael M ward, Arthritis of the Spine Chapter Spinal Imaging and Image Analysis Volume 18 of the series Lecture Notes in Computational Vision and Biomechanics pp 31-66, 2014
9. S. K. Schmitz, J. J. J. Hjorth, R.M. S. Joemai et al., "Automated analysis of neuronal morphology, synapse number and synaptic recruitment," *Journal of Neuroscience Method*, vol. 195, no. 2, pp. 185–193, 2011.
10. Reed WR, Pickar JG. Paraspinal Muscle Spindle Response to Intervertebral Fixation and Segmental Thrust Level During Spinal Manipulation in an Animal Model. *Spine.* 2015/07/01 00:00; 40(13) E752-E759.
11. Raney NH, Petersen EJ, Smith TA, et al. Development of a clinical prediction rule to identify patients with neck pain likely to benefit from cervical traction and exercise. *European Spine Journal.* 2009;18:382-391.
12. J.L. Martiel, A. Leal, L. Kurzawa et al., "Measurement of cell traction forces with ImageJ," in *Method in Cell Biology*, E. K. Paluch, Ed., vol. 125, chapter 15, pp. 269–287, Academic Press, 2015.

# Assessment of the Knowledge and Attitude Regarding Plastic Use and its Health Effects among Nursing Students of Selected Nursing Colleges of Ambala, Haryana

Vijyeta Bhasin<sup>1</sup>, Shalini<sup>1</sup>, Kirandeep Kaur Dhaliwal<sup>2</sup>, Anamika Gautam<sup>3</sup>

<sup>1</sup>Nursing Tutor, Department of Mental Health Nursing, Maharishi Markandeshwar Institute of Nursing, Mullana (Ambala), Haryana, India, <sup>2</sup>Principal, Maharishi Markandeshwar Institute of Nursing, Mullana (Ambala), Haryana, India, <sup>3</sup>Nursing Tutor, Department of Mental Health Nursing, Shree Guru Gobind Singh Tricentenary University, Gurugram, Haryana, India

## Abstract

**Background:** India has witnessed a substantial growth in the consumption of plastics and an increased production of plastic waste. Polyolefin account for the major share of 60% in the total plastics consumption in India. Plastic causes major health problems.

### Aims and Objectives:

1. To assess the knowledge regarding plastic use and its health effects among nursing students.
2. To assess the attitude regarding plastic use and its health effects among nursing students.
3. To determine the relationship between knowledge and attitude regarding plastic use and its health effects among nursing students.
4. To find out the association of knowledge and attitude regarding plastic use and its health effects among nursing students with selected variables.

**Material and Method:** The research approach adopted for the study was quantitative research approach and design was descriptive research design. The study was conducted at selected colleges of Ambala, Haryana. A total of 300 students were selected by using convenience sampling technique. The tool used for the data collection consisted of selected variables, structured knowledge questionnaire and structured attitude scale to measure knowledge of students.

**Results:** Study results revealed that mean score of knowledge was i.e. 59% than mean score of attitude was i.e. 80.3% in the study. A mild positive correlation ( $r=0.07$ ) was found between knowledge and attitude. There was a significant association of knowledge with gender ( $p=0.03$ ), academic qualification ( $p=0.01$ ) and types of school ( $p=0.03$ ). There was a significant association of attitude with religion ( $p=0.00$ ), year ( $0.00$ ), residence ( $0.00$ ) and previous knowledge ( $0.01$ ).

**Conclusion:** Study concluded that the students have average knowledge and moderately favorable attitude regarding plastic use and its health effects.

**Keywords:** Knowledge, Attitude, Plastic, Health Effects, Nursing, Students.

---

### Corresponding Author:

**Ms. Vijyeta Bhasin**

Nursing Tutor, Department of Mental Health Nursing,  
Maharishi Markandeshwar Institute of Nursing,  
Mullana-133 207, Ambala District, Haryana, India  
e-mail: vvvijyeta@gmail.com

### Introduction

“If you are kind so show your kindness towards reducing plastic” –*Smarthemione Grang*

Plastic industry is one among the quickly developing enterprises in the India. In India, 70 percent of absolute



plastic utilization is disposed of as waste. Around 5.6 million tons for each annum (TPA) of plastic waste is produced in nation, which is around 15,342 tons for every day. The development rate is relied upon to be 10% throughout the following five years.<sup>1</sup>

In Haryana the assessed plastic waste age in the State is around 23369.09 tons/annum.<sup>2</sup>

The utilization of plastic convey packs has been mostly prohibited in some pioneer age focuses, visitor and recorded spots situated in Andhra Pradesh, Arunachal Pradesh, Goa, Gujarat, Karnataka, Odessa, Tamil Nadu, West Bengal, Uttar Pradesh and Uttarakhand.<sup>3</sup>

The purposes behind fame for utilizing the plastic sacks are that these are light weight, protection from corruption (synthetic concoctions, daylight and microscopic organisms), sturdiness or more all ease. After their entrance to condition, plastics take somewhere in the range of 15 to 1000 years to biodegrade. It stances hazard to human wellbeing, creatures and marine life.<sup>4</sup>

Utilization of Plastic is influencing human wellbeing. Harmful synthetic concoctions filter out of plastic and are found in blood and tissue of us all. Presentation to them is connected to the malignant growths, birth defects, impeded insusceptibility, endocrine interruption and different issues. Because of the utilization of compound added substances during plastic creation, plastics have possibly hurtful consequences for human's life that could demonstrate to be cancer-causing or can prompt endocrine interruption.<sup>5</sup>

If a ban is placed on the employment of plastics on emotional grounds, the \$64000 value would be abundant higher, the inconvenience far more, possibilities of injury or contamination abundant bigger. The risk to the family health and safety would be increase and particularly of the environmental burden would be manifold.<sup>6</sup>

Plastic has several dangerous effects on health and students are pillars of a demographic nation. Nurses can play a main role in educating the community they ought to have correct data concerning health effects of plastic.<sup>7</sup>

### Objectives:

1. To assess the knowledge regarding plastic use and its health effects among nursing students.
2. To assess the attitude regarding plastic use and its health effects among nursing students.

3. To determine the relationship between knowledge and attitude regarding plastic use and its health effects among nursing students.
4. To find out the association of knowledge and attitude regarding plastic use and its health effects among nursing students with selected variables.

## Methodology

The study was conducted during the month of February-march 2019 at selected nursing colleges of Ambala, Haryana India. A sample of 300 nursing students participated in this study with the prior permission. The *ethical clearance* was obtained from the Principles of the respective colleges. A written consent was obtained from the participants who were enrolled in the study. Quantitative research approach with Non Experimental Descriptive survey design was used in this study. The study includes the regular B.Sc Nursing students who were willing to take part in the study, A total of 300 participants were enrolled for the study by using convenience sampling technique. Data was collected by using selected variables, Structured Knowledge questionnaire and Structured Attitude Scale. The technique used was Self report (paper and pencil)

### Description of data collection tools

**Section I: Development and description of selected variables:** It consist of 11 items such as age in year, gender, religion, year of study, academic qualification, type of school, area of living, residence, total family income, monthly pocket money, previous knowledge and if yes, then specify

**Section II: Development of Structured knowledge questionnaire to assess knowledge of nursing students:** A structured questionnaire was developed to assess the knowledge of Nursing Student regarding plastic use and its health effects. It consist of 30 multiple choice questions related to concept, types, use, hazards and management of plastic

**Section III: Development of Structured attitude scale to assess attitude of primary school teachers:** Structured attitude scale (5- point Likert scale) consisted of 30 items on attitude. It was prepared to assess the attitude of nursing students. Interpretation of attitude scores was strongly agree, agree, undecided, disagree and strongly disagree

**Procedure:** The permission was taken to conduct the study from the Respective Principles of selected nursing colleges of Ambala, Haryana. The Consent was taken from the participants prior to the study. The selected variables, Structured Knowledge Questionnaire and Structured Attitude Scale Questionnaire were administered to students. The participants were assured about their confidentiality of their response. Purpose of the study was explained to sample subjects before

data collection. It was found that it took 20 minutes to complete the questionnaire. The items were found clear and understandable.

### Results

**Section-I:** Frequency and percentage distribution in terms of level of knowledge and attitude of mothers regarding oral hygiene of under five children as given in table 1 and table 2.

**Table 1: Frequency and percentage Distribution in terms of level of knowledge regarding plastic use and its health effects among nursing students. N=300**

Level of Knowledge	Scores	Frequency	Percentage
Very Good	26-30	3	1
Good	20-25	47	15.67
Average	14-19	177	59
Poor	7-13	64	21.33
Very Poor	<6	9	3

The data presented on table 1 shows that majority of students (59%) had average knowledge regarding plastic use and its health effects and only 1% students had very good knowledge.

**Table 2: Frequency and percentage Distribution in terms of levels of attitude regarding plastic use and its health effects among nursing students. N=300**

Level of attitude	Scores	Frequency	Percentage
Highly favorable	121-150	13	4.4
Moderately favorable	91-120	241	80.3
Unfavorable	30-90	46	15.3

Maximum Score- 150 Minimum Score-30

The data presented in table 2 shows that majority of students (80.3%) have moderately favorable attitude. The data further shows that only 4.4% of students had highly favorable attitude regarding plastic use and its health effects.

**Section-II:** Range, Mean, median and standard deviation of knowledge and attitude scores regarding plastic use and its health effects among nursing students.

**Table 3: Mean Median, Range and Standard Deviation of knowledge scores regarding plastic use and its health effects among nursing students N=300**

Variable	Range	Mean ±SD	Median
Knowledge	26	15.93 ±4.24	16
Attitude	78	101.27±11.39	102

The data presented in table 3 shows that the mean± standard deviation of knowledge score regarding plastic use and its health effects among nursing students is 15.93±4.24 and median is 16 and the mean± standard

deviation of attitude scores regarding plastic use and its health effects among nursing students is 101.27±11.39 and median is 102.

**Section III:** Coefficient of correlation between the knowledge and attitude scores regarding plastic use and its health effects.

**Table-4: Correlation between knowledge scores and attitude scores regarding plastic use and its health effects among nursing students.**

Group	Mean±SD	r (p value)
Knowledge	15.93±4.2456	0.07 (0.02)*
Attitude	101.27±11.39	0.07 (0.02)*

The table 4 shows that there is a mild positive correlation (0.07) between knowledge and attitude with p value 0.02 which shows that there is a significant relationship between knowledge and attitude scores regarding plastic use and its health effects among nursing students.

**Section-IV** Association between the level of knowledge and attitude regarding plastic use and its health effects among nursing students with the selected variables shows that there is significant association of knowledge with gender (0.03), academic qualification (0.01) and type of school (0.03) at 0.05 level of significance. Further it shows that there is significant association of attitude with religion (0.00), year of study (0.002), residence (0.004) and monthly pocket money (0.03) at 0.05 level of significance.

### Discussion

The present study was conducted to assess the knowledge and attitude regarding plastic use and its health effects among nursing students.

The present study finding indicate that more than half students (59%) have average knowledge which is contradicted to the findings of the study done by N. Srinivasam and et al.<sup>40</sup> which indicated that less than half students (48%) have average knowledge.

The present study findings indicated that majority of students (80.3%) had moderately favourable which is similar to the findings of the study done by Ali haider and et al<sup>49</sup> which indicate that majority of the students (85%) had moderately favourable attitude.

The present study findings indicated that maximum number of students (37%) belongs from age group of 18 year which is similar to the findings of the study done by Mr. Parahad V Iddalagi<sup>43</sup> which indicated that

maximum number of students (47%) belongs to age group of 18 year.

The present study indicated that majority of students (86.7%) were having academic qualification of senior secondary which is not contradicted to the findings of the study done by Nitin Joseph<sup>46</sup> and et al. which indicated that majority of the students (89%) were having academic qualification is graduation

### Conclusion

Majority of nursing students had average knowledge regarding plastic use and its health effects. i.e., 59%. Majority of nursing students had moderately favorable attitude regarding plastic use and its health effects. i.e., 80.3%. A mild positive correlation was found between knowledge and attitude i.e.,  $r=0.07$ . There was significant association between the knowledge and attitude score with selected variables

**Conflict of Interest:** Nil

**Financing Sources:** Nil

**Ethical Clearance:** The permission was obtained from the principles of the respective colleges and written consent from the nursing students.

### Reference

- 1 India to galvanise greater action against plastic waste on World Environment Day [Internet]. Mongabay-India. 2019 [cited 8 May 2019]. Available from: <https://india.mongabay.com/2018/04/india-to-galvanise-greater-action-against-plastic-waste-on-world-environment-day/>
- 2 [Internet]. Cpcb.nic.in. 2019 [cited 16 June 2019]. Available from: [http://cpcb.nic.in/uploads/plasticwaste/Annual\\_Report\\_2016-17\\_PWM.pdf](http://cpcb.nic.in/uploads/plasticwaste/Annual_Report_2016-17_PWM.pdf)
- 3 “Seventeen States/UTS Have Imposed Complete Ban on Use of Polythene Bags”: Environment Minister [Internet]. Pib.nic.in. 2019 [cited 16 June 2019]. Available from: <http://pib.nic.in/newsite/PrintRelease.aspx?relid=169756>
- 4 Plastics Applications [Internet]. Bpf.co.uk. 2019 [cited 8 May 2019]. Available from: <https://www.bpf.co.uk/plastipedia/applications/Default.aspx>
- 5 Smartindia.net.in. 2019 [cited 5 June 2019]. Available from: <https://smartindia.net.in/ask-a-teacher/question/21517/#.XPgCqBYzbIU>

- 6 Plastic pollution [Internet]. En.wikipedia.org. 2019 [cited 16 June 2019]. Available from: [https://en.wikipedia.org/wiki/Plastic\\_pollution](https://en.wikipedia.org/wiki/Plastic_pollution)
- 7 [Internet]. Wedocs.unep.org. 2019 [cited 17 June 2019]. Available from: [https://wedocs.unep.org/bitstream/handle/20.500.11822/25496/singleUsePlastic\\_sustainability.pdf?isAllowed=y&sequence=1](https://wedocs.unep.org/bitstream/handle/20.500.11822/25496/singleUsePlastic_sustainability.pdf?isAllowed=y&sequence=1)

# Socio-Demographic Profile of Suicidal Cases Autopsied at Tertiary Care Centre in Uttarakhand: A Retrospective Study

Vikas Vaibhav<sup>1</sup>, Pawan Kumar Shukla<sup>2</sup>, Sanchit Jain<sup>1</sup>, Raviprakash Meshram<sup>4</sup>

<sup>1</sup>Junior Resident, Department of Forensic Medicine and Toxicology, All India Institute of Medical Sciences, Rishikesh, Uttarakhand, <sup>2</sup>Senior Resident, Department of Forensic Medicine and Toxicology, All India Institute of Medical Sciences, Raipur, Chhattisgarh, <sup>4</sup>Associate Professor, Department of Forensic Medicine and Toxicology, All India Institute of Medical Sciences, Rishikesh, Uttarakhand

## Abstract

Suicide is an imperative public health problem that needs social as well as medical attention. In India, 134516 people committed suicide in 2018 and also there is an increase in the number of suicide cases in Uttarakhand as well. The aim was to analyse the trend of suicidal deaths autopsied at our center concerning different parameters like age, gender, method of suicide, reason for suicide, to know the demographic pattern and its cause. The autopsy reports and inquest papers of suicidal cases autopsied at AIIMS Rishikesh were included for evaluation. Out of total 19.49% of total autopsies were of suicidal deaths. Majority of the victims were males (76.42%) compared to females (22.76%). The average age of victims was 35 years and 76.4% belonged to the age group 14 to 43 years. The risk of suicide was more prevalent in urban population. Among the total victims, 39.83% were in jobs. Regarding the reason behind suicide, family dispute was most common. The most common mode of suicide was hanging followed by poisoning and drowning. Organophosphates was the most repeated poison consumed in suicides by poisoning. About 75% cases were complete suicides and couldn't receive medical care. Majority of the cases belonged to Rishikesh police station. The important aspects of suicides among young generation is peer pressure which can be from family, institutional, or work etc. An effective strategy needs to be devised to combat the issue.

**Keywords:** *Suicides; Autopsy; Hanging; Poisoning; Family disputes; Depression.*

## Introduction

Suicide is an imperative public health problem that needs social as well as medical attention. Suicide not only causes loss of an individual's life but also mental trauma to the family of deceased. It is estimated that suicide is among the top twenty leading causes of death worldwide.<sup>(1)</sup> Around 8,00,000 people die every year from suicide, which is one person every 40 seconds.<sup>(1)</sup> In our society, mental health issues are often stigmatized, people hesitate to accept their mental health problems.

There are also legal issues associated with suicide many cases go unreported which is one of the major causes for under-reporting of number of suicides. An increase in suicides in third world countries as compared to developed world is due to prevalence of higher degree of socioeconomic and behavioral risk factors for suicide.<sup>(2)</sup> Many demographic parameters like age, sex, occupation, and method of suicide may vary between different regions, societies, etc.<sup>(3)</sup>

In India, 134516 people committed suicide in 2018. <sup>(4)</sup> The rate of suicide has increased from 9.9 of 2017 to 10.2 in 2018.<sup>(4)</sup> In 2018, the majority of suicide cases were reported from Maharashtra (17972), Tamil Nadu (13896), West Bengal (13255), Madhya Pradesh (11775), and Karnataka (11561). These five states accounted for 50.5% of total suicide cases in the country.<sup>(4)</sup> The total number of cases reported from Uttarakhand was 421 in 2018 which is 27.2% higher than the previous year.<sup>(4)</sup>

---

### Corresponding Author:

**Vikas Vaibhav**

Junior Resident, Department of Forensic Medicine and Toxicology, All India Institute of Medical Sciences, Rishikesh, Uttarakhand  
e-mail: vikasvaibhav007@gmail.com

After the mortuary of All India Institute of Medical Sciences (AIIMS) Rishikesh became functional, we noticed an appreciable frequency of suicidal cases being brought for autopsy. The profiles of victims and method of suicides adopted by them were varying. There was an increasing number of cases from a particular area. The following observations were the reasons behind this study. The aim was to analyse the trend of suicidal deaths autopsied at our center concerning different parameters like age, gender, method of suicide, reason for suicide, to know the demographic pattern and its cause.

### Methodology

A retrospective study was conducted from October 2018 to June 2020 in the department of Forensic Medicine & Toxicology at AIIMS Rishikesh. The autopsy reports and inquest papers of suicidal cases were included for evaluation. AIIMS Rishikesh covers autopsy cases from seven police stations distributed in 3 districts of Uttarakhand. The following parameters were included for evaluation age, gender, occupation, area of residence, place of death, method of suicide, type of poison ingested in poisoning deaths, and police station to which the case belonged.

### Results

A total of 631 cases were autopsied during the study period, out of which 123 cases (19.49%) were of suicidal deaths. Males were predominant 76.42% (n = 94) than females 22.76% (n = 28) with male: female ratio of 3.3:1. The average age of victims was 35 years and 29.2%

belonged to the age group 24 to 33 years (Figure 1). The risk of suicide was more prevalent in urban population (n=81, 65.85%) compared to rural population (n=42, 34.14%). Among the victims, 39.83% (n = 49) were in jobs, 37.39% (n=46) were jobless including housewives, 19.51% (n = 24) were students, 3.25% (n = 4) were retired persons (Figure 2). Regarding reason for suicide, family dispute was most common (n=48, 39.02%) followed by depression (n=33, 26.82), love affair (n=11, 8.94%), and mentally challenged (n=4, 3.25%). The reason was unknown in 21.13% (n=26) cases (Figure 3). The most common mode of suicide was hanging (n=61, 49.59%), followed by poisoning (n=46, 37.39%) and drowning (n=9, 7.31%). In suicides by poisoning, the most common poison ingested was organophosphates (n=20, 43.47%) followed by phosphorous compounds (n=6, 13.04%), toilet cleaner (n=2, 4.34%), THC + Opioid + Morphine + Benzodiazepine (n=1, 2.17%) and the nature of poison was unknown in 34.78% (n=16) cases. Most cases (74.79%, n=92) did not receive any medical facility before death whereas only 25.20% (n=31) cases were brought to hospital but did not survived. AIIMS Rishikesh has jurisdiction of 7 police stations for medico-legal autopsy. These police stations are Rishikesh, Raiwala, Muni kireti, Laxman jhula, Narendra nagar, Ranipokhri and GRP Dehradun. Most autopsies were done under Rishikesh jurisdiction (n=85, 69.10%) including hospital admitted deaths, followed by raiwala (n=13, 10.56), muni kireti (n=11, 8.94%), laxmanjhula (n=7, 5.69%), narendranagar (n=2, 1.62%), ranipokhri (n=4, 3.25%), and GRP Dehradun (n=1, 0.81%).

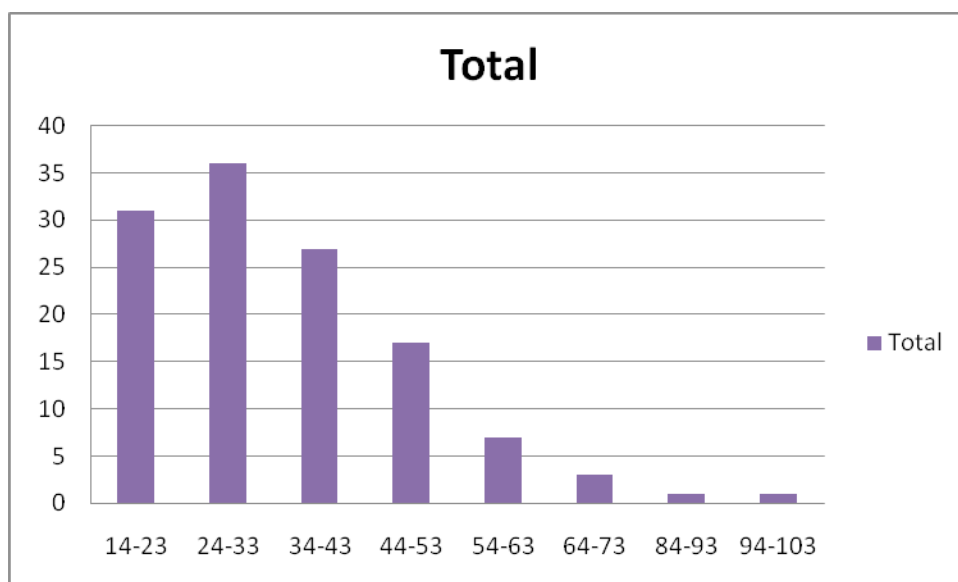


Figure 1: Age distribution among suicidal cases

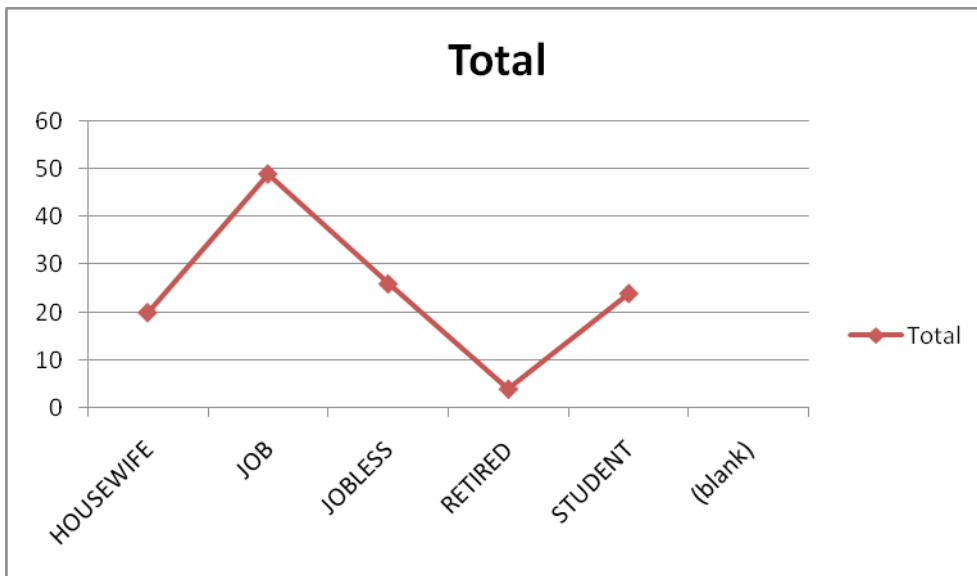


Figure 2: Occupation of victims of suicide.

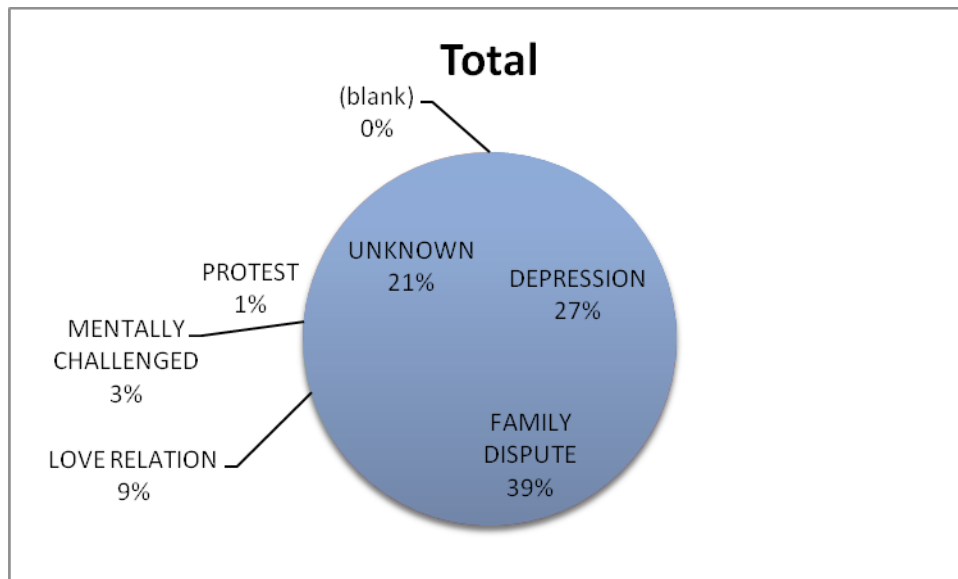


Figure 3- Reasons for suicide among cases.

### Discussion

The present study demonstrates the sociodemographic profile of complete suicide cases brought for autopsy at our center. Suicidality represents a major healthcare problem particularly in low and middle-income countries.<sup>(5)</sup>As a developing nation, India is also struggling with the same issue and efforts are being made to combat. The study showed men were more vulnerable to suicide compared to women (76.42% v/s 22.76%) with a ratio between the two was 3.3:1. A study by Nunez et. al. found similar results with 86% men of the total victims and the ratio between men: women

were 6:1<sup>(6)</sup> Suicidal attempts were higher in females but the rate of complete suicide was comparatively higher in males.<sup>(9)</sup> Conversely, suicide was more common among males but suicidal behavior was more common among females.<sup>(7)</sup> A similar retrospective study done in Kuwait from the year 2014-2018, included 297 cases and showed that 81.1% were males and surprisingly of all cases 60.2% were Indians and only 7.4% were Kuwaitis.<sup>(8)</sup>

The average age of victims committing suicide by any method was 35 years and the most susceptible age group was 14-33yrs. Many evidences are available which suggests that the young individuals in their 2<sup>nd</sup> to

3<sup>rd</sup> decade of life were the major contributors to overall suicidal deaths.<sup>(5)</sup> Nunez-Samudio V et. al. found 20-29 years as the most affected age group.<sup>(6)</sup> A systematic review showed an overall high prevalence of suicide rates in the 20-29 years age group but females were predominant in committing suicides for age-group under 30 years whereas males were leading for age group 30 years or older.<sup>(13)</sup> Regarding the area of population more vulnerable to suicides, urban population reported more deaths compared to rural. The possible reason could be the stress at workplace, busy life style, high cost of living etc.

India's contribution to the global suicide rate has increased from 25.3% in 1990 to 36.6% in 2016 among women and from 18.7% to 24.3% among men.<sup>(10)</sup> In a study conducted among different states of India, suicide rates per one lakh population increased from 14.9 in 2001 and 15.4 in 2016. It was also observed that developed states reported higher suicide rates as compared to less developed ones.<sup>(11)</sup> India is ranked 19<sup>th</sup> among the world in the context of suicides.<sup>(12)</sup> One of the sorrowful aspects of suicides in India is farmer suicide, it is mainly linked to marginal return from farmland, lack of income streams, indebtedness, crop failure due to factors like rain, loss of social status, and failure to fulfill social role compels a person to commit suicide.<sup>(12)</sup>

The present study found family disputes and depression were the most common cause of committing suicides. A similar study showed 33.7% of people commit suicide for personal reasons and 24.4% for unknown reasons, in which no specific cause was found.<sup>(11)</sup> A strong association was observed between suicide, comorbid physical or psychiatric ailments and substance abuse, especially alcohol.<sup>(12)</sup> Suicides are mostly related to psychiatric problems like depression, as demonstrated in another study.<sup>(5)</sup> Among the low socio-economic states of the country, mental illness, alcohol abuse and interpersonal difficulties were the major problems.<sup>(13)</sup> The most preferred method of suicide by any gender in our study was hanging (49.59%) followed by poisoning (37.39%). The method of suicide preferred by males was also hanging followed by poisoning and drowning. Comparatively among females, the method of choice was poisoning followed by hanging. Many studies found similar results of hanging as the most common method of suicide followed by self-poisoning and use of firearms.<sup>(5)</sup> The use of firearms is more prevalent in the western world due to ease in issuing of licensed weapons as compared to our country where it is difficult to obtain

the license, however the incidences of firearm suicides are not uncommon among armed forces. Contrary to our findings Dandona R et. al. found poisoning as the leading method of suicide followed by hanging.<sup>(11)</sup> Similarly, Rane A et al. found hanging as a leading method followed by poisoning. Self-Immolation was also common among women as seen in dowry deaths.<sup>(13,17)</sup> Hanging requires any household material which can be used as a ligature, mostly committed when alone.

The type of poison most commonly consumed was organophosphates in 43.47% autopsied cases. The type of poison was unknown in 34.78% of cases. Several studies also found pesticides as a leading cause of poisoning especially organophosphate compounds.<sup>(5,11-15)</sup> Easy availability at home and easy access to household poison is a possible cause of suicides due to poisoning. The green revolution averted the deaths from famine but also introduced pesticides such as Parathion and Endrin's to poor rural people who were not trained and equipped to use and store it.

In the present study, most victims of suicide were in the job (39.83%), followed by jobless (21.13%), students (19.51%) and housewives (16.26%). A stressful environment at work may be the possible risk factor for suicidal thoughts.<sup>(18)</sup> In a study conducted by Lim AY et. al. In Korea, it was seen that out of 124 participants, 39.5% and 15.3% presented with clinical levels of depression and suicidal ideation respectively.<sup>(19)</sup> Another cross-sectional study conducted by Ahn SH et. al. showed that in woman workers, suicidal ideation/attempt significantly correlated with the physical environment, lack of reward, and occupational climate. But in cases of men workers, depression rather than job stress correlated with experiences of suicidal ideation/attempt.<sup>(20)</sup> Among medical residents, burnout is a common phenomenon due to overburden of work.<sup>(21)</sup> The study also showed that 64.05% of interns, 40% of junior residents show burnout thoughts. Surgical specialty residents are more prone to burnout phenomenon. No gender difference was observed in burnout.<sup>(21)</sup>

One of the important aspects of suicides among young generation is peer pressure. Internet and social media is an easily accessible platform to communicate stress but unfortunately, different method of suicides are also not difficult to find.<sup>(15,16)</sup> A relationship was observed between internet use and self-harm behavior particularly associated with internet addiction; which is very common in vulnerable age groups of our study.<sup>(16)</sup>



The suicidal death rate in India is higher than expected for its socio-demographic index level, especially for women; with substantial variations in the magnitude and man to woman ratio between the states.<sup>(10)</sup>The government should develop suicide prevention programs considering these variations among different states and strata of society to address the specific issues leading to suicides.

### Conclusion

The rate of suicides is increasing at an alarming pace in our region. The young aged male individuals contribute to the major proportion of total suicides. Though urbanization is essential for economic growth, it is also posing risk of suicides in young individuals because of increasing stress to meet the survival needs. Individuals in jobs are committing more suicides than jobless which indirectly represent the stressful environment they are working in. Persons with suicidal thoughts or under psychiatric medication or depression must not be left alone because majority of the victims committed suicides when left alone. Even minor psychiatric issues should not be ignored and proper consultation needs to be taken. Norms should be set by the government over selling of agricultural insecticides as it is very easy to purchase such poisons. Gender equality could significantly reduce the number of suicides in females.

**Ethical Clearance:** Approval has been taken from institutional ethical committee of AIIMS-Rishkesh.

**Source of Funding:** Self.

**Conflict of Interest:** Nil.

### References

1. World Health Organisation. Suicide in the world: Global Health Estimates. World Health Organisation. 2019;1-33.
2. Gad Elhak SA, El-Ghazali AM, Salama MM, Aboelyazeed. Fatal suicide cases in Port Said city, Egypt. *Journal of Forensic and Legal Medicine*. 2009;16(5):266-8. DOI.10.1016/j.jflm.2008.12.006.
3. K. stojkoski, M. grozeva. Strategy for forensic analysis of suicide cases in Bulgaria. *Trakaria journal of sciences*. 2005;3(4):18-20.
4. National Crime Record Bureau. Accidental Deaths and Suicides in India. National Crime Record Bureau. Ministry Home Affairs Govt of India.2018;53(9):1-312. <https://ncrb.gov.in/sites/default/files/ADSI-2018-FULL-REPORT-2018.pdf>. Accessed on 26-08-2020 at 21:35.
5. Bachmann S. Epidemiology of Suicide and the Psychiatric Perspective. *Int J Environ Res Public Health*. 2018;15(7):1425. Published 2018 Jul 6. doi:10.3390/ijerph15071425.
6. Nunez-Samudio V, Jimenez-Dominguez A, Lepez Castillo H, Lamdiros I. Epidemiological characteristic of suicide in Panama 2007-2016. *Medicine (Kansas)*.2020;56(9):E442. doi:10.3390/medicina56090442.
7. Milner A., Scovel AJ et. al. Shift in gender equality and suicide: A [panel study of changes over time in 87 countries. *Journal of affect disorders*. 2020;276:495-500. doi: 10.1016/j.jad.2020.07.105.
8. Al-Wahab, Al-Kandery N, et. al. Pattern of suicide in Kuwait from 2014-2018. *Journal of public health*. 2020;187:1-7. doi: 10.1016/J.puhe.2020.07.032.
9. Mc loughlin AB, Gould MS, et.al. Global trends in teenage suicide.2003-2014. *Quarterly journal of medicine*.2015;108(108):765-780. doi: 10.1093/qjmed/hcv 026.
10. India state level disease burden initiative suicide collaborators. Gender differentials and state variation in suicide deaths in India: The global burden of disease study 1990-2016. *Lancet Public Health*. 2018;3(10):e489. doi: 10.1016/S2468-2667(18)30138-S.
11. Dandona R, Kumar GA et. al. Lessons from a decade of suicide surveillance in India: who? Why? and how?. *International journal of epidemiology*. 2017;46(3):983-993. doi:10.1093/ije/dyw113.
12. Garg K. et. al. Depression, suicidal ideation and resilience among rural farmers. *Journal of Neuroscience rural practice*. 2019;10(2):175. doi: 10.4103/jnrp\_339\_18.
13. Rane A, Nadkarni A, Suicide in India: A systematic review. *Shanghai Arch. Psychiatry*. 2014;26(2):69-80. doi: 10.3969/j.issn.1002-0829.2014.02.003.
14. Mew EJ, Padmanathan P, Konradson F, et.al. The global burden of fatal self poisoning with pesticides. 2006-2015. Systematic review. *Journal of Affect disorder*. 2017;219:93-104. doi:10.1016/j.jad.2017.05.202.
15. Karunarathne A, Gunell D, Konnadsen F, Eddleston M. How many premature deaths from pesticide suicide have occurred since the

- agricultural green revolution?. *Clinical Toxicology Phila.* 2020;58(4):227-232. doi:10.1080/15563650.2019.1662433.
16. Merchet A, Hantonk et.al. Systematic review of relationship between internet use, self-harm, and suicidal behaviour in young people: The good, the bad and the unknown. *PLOS One.* 2017;12(8):e0181722. doi:10.1317/journal.pone.0181722.
17. Kaur N, Byard RW. Bride burning: A unique and on-going form of gender violence. *Journal of forensic and legal medicine.* 2020;75:102035. doi:10.1016/j.jflm.2020.102035.
18. Milner A, La Montage AD et al. Job stressors and employment precocity as risks for thoughts about suicide: An Australian study using ten to men cohort. *Annals work of exponential Health.* 2018;62(5): 583-590. doi:10.1093/annweh/wxy024.
19. Lim AY, Lee SH, Jeon Y et. al. Job seeking stress, mental health problem and the role of perceived social support in university graduates in Korea. *Journal of Korean Medical Services.* 2018;33(19):e149. D10. doi:10.3346/jkms.2018.33.e149.
20. Ahn SH, Lee YJ, Jang EC et.al. A study of job stress, suicidal ideation and suicidal attempts in display manufacturing workers: A cross sectional study. *Annals of occupational and environmental medicine.* 2020;32:e16. doi:10.35371/aoem.2020.32.e16.
21. Ratnakaran B, Prabhakaran A. et.al. Prevalance of burnout and its correlates among residents in a tertiary medical center in Kerela, India: A cross sectional study. *Journal of postgraduate Medicine.* 2016;62(3):157-161. doi:10.4103/0022-3859.184274.

# Study of the Balance System between Some Enzymatic and Non-enzymatic Antioxidants in Blood Serum of Patients with Rheumatoid Arthritis in Mosul City, Iraq

Walaa A. Al-Jawadi<sup>1</sup> Muna H. Jankeer<sup>2</sup>

<sup>1</sup>Lecturer, Professor, Optics Technologies Department, Al-Noor University College, Iraq,

<sup>2</sup>Biology Department, Science College, Mosul University, Iraq

## Abstract

Rheumatoid arthritis (RA) is a chronic systemic inflammatory disease with an unknown etiology, which effects on many tissues and organs. Therefore, the present study aimed to demonstrate the role of the rheumatoid arthritis in causing oxidative stress by studying the level of balance between Malondialdehyde MDA (as an indicator of oxidation) and non-enzymatic and enzymatic antioxidants in the blood serum of 95 patients of both sexes, whose ages ranged between (18-74) years, as well as 50 healthy people of both sexes and of the same ages of the injured, it was considered as a control group. The results showed a significant increase ( $P \leq 0.05$ ) in the concentration of MDA in the serum of patients at 362% compared with the healthy control group. While the results showed a significant decrease in the concentration of non-enzymatic antioxidants represented by glutathione GSH, albumin and uric acid in serum at 48%, 17% and 6% respectively, compared with control. The results also showed a significant decrease in the activity of the enzymatic antioxidants represented by superoxide dismutase SOD and ceruloplasmin in the serum at 63% and 10% respectively, while the activity of glutathione peroxidase GPX showed a significant increase by 44% compared with control. The results of the current study showed an increase in the rising or falling of these studied variables more in female serum than males with RA. We conclude from this study a misalign of balance system between oxidants and non-enzymatic and enzymatic antioxidants, which indicates that RA disease caused oxidative stress in these patients, which leads to the long-term deterioration of the patient's condition.

**Keywords:** Rheumatoid arthritis, Antioxidants, Malondialdehyde, Glutathione Peroxidase.

## Introduction

Rheumatoid arthritis (RA) is a chronic idiopathic systemic inflammatory disease, that causes cartilage damage bone ulcers and joint destruction in severe cases and often loss of function a lity. RA affects about 1% of the world's population and affects females more than males in a ratio of 1:3, this disease can begin at any age, but it often occurs in the age groups of (30-35) years, but this does not prevent it occurs in children and elderly. RA affects Juveniles under the age of 16 and is called Juvenile Rheumatoid Arthritis (JRA)<sup>(1)</sup>. Oxidative stress is defined as an imbalance between free radicals produced by many cellular biological processes and the defensive susceptibility to antioxidants in the body, and is accompanied by an increase in lipid peroxidation, which

results in subversive damage to different body tissues<sup>(2)</sup>. Ighodaro and Akinloye<sup>(3)</sup> indicates that the imbalance between free radicals and the antioxidants in the cells leads to a rise in the free radicals cuff at the expense of the antioxidants cuff in those cells, to the degree that exceeds the resistance of the body, and consequently, it produces free radicals such as Reactive Nitrogen Species (RNS) and Reactive Oxygen Species, (ROS) leading to disruptive damage to different tissues in the body, which leads to organ damage, loss of biological functions, and occurrence of various diseases, including RA, various types of cancer, cardiovascular disease<sup>(4)</sup>.

Exposure to free radicals from a variety of sources of living organisms leads to development of a series of defensive mechanics represented in the effectiveness of

antioxidants that continuously resist the harmful effects of free radicals formed in the body, as the body generates or provides defensive systems called antioxidants<sup>(5)</sup>, which are produced internally or supplied from external sources, So the need for antioxidants has become greater than the increase in the production of free radicals due to the contestant exposure to pollutants, toxic substances, medicines and diseases that increase oxidative stress<sup>(6)</sup>.

**The present study aimed** to know the level of oxidative stress caused by RA disease in patients of both sexes by studying the level of MDA which represents one of the final products of lipid peroxidation and some of non-enzymatic and enzymatic antioxidants in serum.

## Materials and Method

**Sample Collection:** The current study included 95 patients with RA of both sexes (23 Males and 72 females), whose ages ranged between (18-74), who visited the Arthritis Division at Salam Teaching Hospital and outpatient clinics in the city of Mosul, after the disease was diagnosed by specialist doctors through a set of tests described by the American Society of Arthritis<sup>(7)</sup>, as well as 50 healthy people of both sexes with same ages of the patients and it was considered as a control group.

**Measuring Biochemical Parameters:** The biochemical parameters were measured in serum as follows:

1. Serum of lipid peroxidation (Malondialdehyde MDA) concentration (as oxidant marker) by thiobarbituric acid (TBA) modified method<sup>(11)</sup>
2. Serum of glutathione (GSH) concentration modified Ellman's reagent method<sup>(12)</sup>
3. Serum of albumin concentration by bromacresol green method<sup>(13)</sup>
4. Serum of uric acid concentration by urease enzymatic method<sup>(14)</sup>
5. Serum of Superoxide dismutase (SOD) activity was measured by modified photochemical Nitro Blue Tetrazolum(NBT) method<sup>(15)</sup>
6. Serum of glutathione peroxidase (GPx) activity was measured by colorimetric method<sup>(16)</sup>

Serum of ceruloplasmin activity was measured by spectrophotometric modified method<sup>(17)</sup>

**Statistical Analysis** of the results was carried out with Duncan's test

## Results and Discussion

**1. Malondialdehyde (MDA) Concentration (As oxidative indicator):** Table(1) showed a significant increase ( $P \leq 0.05$ ) in the concentration of MDA in the serum of patients with RA by 362% compared with the healthy Control group, and the results of table (2) showed a significant increase in the conc. of MDA in the serum of females patients at 367% more than conc. in the serum of male patients at 339% compared with healthy. The results of this study are consistent with previous studies, as they indicated high MDA conc. in serum of patients with RA<sup>(15)</sup>.

Several authors suggested that increased reactive oxygen species(ROS) levels in RA may in a pro-oxidation environment, which in turn could result in increased MDA conc. As a result, lipid peroxidation may have a role in the pathogenesis of patients with RA<sup>(16)</sup>.

## 2. Non-Enzymatic Antioxidants Concentration

**2.1 Glutathione (GSH) Concentration (As an indicator of oxidative stress):** Table (1) showed a Significant decrease ( $P \leq 0.05$ ) in the concentration of GSH in the serum of patients with RA by 48% compared with the control. The results of table(2) also showed a significant decrease in the conc. of GSH in the serum of male and female patients with RA by 49% and 47% respectively compared to GSH conc. in the serum of healthy. The results of this study are in agreement with the findings of each of<sup>(17)</sup>.

The reason for the decrease in GSH conc. is due to the increased consumption of GSH as a non - enzymatic antioxidant(endogenous) in removing free radicals and preventing oxidation, as it transforms from the active reduced form GSH to the inactive oxidized form GSSG, GSH has a major role in protecting cells from free radicals damage, and in general that the result of infection with some diseases will lead to a decrease in GSHconc. due to the production of free radicals, which leads to its consumption as an antioxidant. GSH is an indicator of increased oxidative stress<sup>(18)</sup>.

**Table (1): The comparison of serum malondialdehyde (MDA), some non-enzymatic and enzymatic antioxidants between RA patients and healthy control group for both sexes**

Parameters	Studied groups	Healthy control (n = 50)			Patients (n = 95)		
		Mean±SD*	%	%	Mean±SD*	%	%
MDA conc. (µ mol/L)		1.200±0.043b	100	-	5.543±0.388a	462	362+
GSH conc. (µ mol/L)		4.955±0.198a	100	-	2.560±0.155b	52	48-
Albmin conc. (g/dl)		4.348±0.129a	100	-	3.595±0.109b	83	17-
Uric Acid conc. (mg/dl)		4.998±0.343a	100	-	4.786±0.297b	96	4-
SOD activity (ΔO.D)		0.0917±0.047a	100	-	0.0343±0.003b	37	63-
GPx activity (µ mol/L)		3.829±0.224b	100	-	5.512±0.390a	144	44+
Ceruloplasmin activity (µ mol/L)		209.03±1.767a	100	-	187.56±1.260a	90	10-

\*The numbers are followed by different letters horizontally indicate a significant difference at the level of probability (P ≤ 0. 05) and correct reverse according Duncan’s test.

The sign (+) are means an increase.

The sign (-) are mean an decrease.

**2.2 Albumin Concentration:** Table (1) showed a significant decrease (P≤0.05) in the conc. of albumin in the serum of patients with RA by 17% compared with the healthy group. The results in Table (2) showed a significant decrease in the conc. of albumin in the serum of females with RA by 22% higher than that of males, as the ratio of decrease in the serum of males at 14% compared with the control. The results of the current study are consistent with the findings of previous studies<sup>(19)</sup>. The reason for the low albumin conc. is due to its effectiveness as a non-enzymatic antioxidant(endogenous), which contains sulfahydret (SH-) groups, which are associated with free radicals and nullify their effectiveness. Also, albumin is associated with unsaturated fatty acids

found in low density lipoproteins (LDL), and it protects them from the oxidation process, which is why researchers called the albumin sacrificial antioxidant<sup>(20)</sup>.

**2.3 Uric acid concentration:** Table(1) showed a slightly significant decrease (P ≤ 0.05) in the uric acid conc. in the serum of patients with RA by 4%, and the results in table (2)also showed a nonsignificant decrease in the uric acid conc. in the serum of males with RA by 6% while in females by 2% compared with the control. The results of this current study correspond to the findings of<sup>f(20,21)</sup>. The reason for the low conc. of uric acid is due to the fact that it represents a natural scavenger of proxynitrite radical. Uric acid is a non-enzymatic antioxidant,

**Table 2: The comparison of serum malondialdehyde (MDA), some non-enzymatic and enzymatic antioxidants between both male and female RA patients and male and female healthy control group.**

Parameters	Studied groups	Sexes	Healthy control (n = 50)			Patients (n = 95)		
			Mean±SD*	%	%	Mean±SD*	%	%
MDA conc. (µ mol/L)		Males	1.244±0.060b	100	-	5.456±0.321a	439	+339
		Females	1.156±0.621b	100	-	5.396±0.624a	467	+367
GSH conc. (µ mol/L)		Males	5.160±0.385a	100	-	2.623±0.311b	51	-49
		Females	4.750±0.081a	100	-	2.496±0.140b	53	-47
Albmin conc. (g/dl)		Males	4.430±0.275a	100	-	3.79±0.055b	86	-14
		Females	4.340±0.111a	100	-	3.40±0.136b	78	-22
Uric Acid conc. (mg/dl)		Males	5.763±0.202a	100	-	5.410±0.202a	94	-6
		Females	4.232±0.523b	100	-	4.163±0.118b	98	-2

Parameters	Studied groups	Sexes	Healthy control (n = 50)			Patients (n = 95)		
			Mean±SD*	%	%	Mean±SD*	%	%
SOD activity (ΔO.D)		Males	0.0734±0.149a	100	-	0.0360±0.005b	49	-51
		Females	0.0719±0.111a	100	-	0.0327±0.002b	46	-54
GPx activity (μ mol/L)		Males	3.4350±0.138c	100	-	4.875±0.369b	142	-42
		Females	4.224±0.278b	100	-	6.150±0.468a	146	-46
Ceruloplasmin activity (μ mol/L)		Males	185.93±2.005c	100	-	165.33±1.791d	89	11-
		Females	232.13±1.588c	100	-	209.78±1.967b	90	10-

\*The numbers are followed by different letters horizontally indicate a significant difference at the level of probability ( $P \leq 0.05$ ) and correct reverse according Duncan's test.

The sign (+) are means an increase.

The sign (-) are mean an decrease

as it plays an important role in protecting cells from ROS resulting from certain diseases, which leads to its consumption as an antioxidant, it is an indicator of increased oxidative stress<sup>(20)</sup>.

However, GSH, albumin and uric acid conc. in serum were significantly lower in patients ( $P \leq 0.05$ ) and concluded that these results suggest that increase oxidative stress present in patients with RA may lead to compensatory changes in the conc. of another antioxidants. These changes, in turn, may provide additional protection against lipid peroxidation in RA<sup>(17)</sup>.

The pathogenesis of this disease is linked with the composition of free radicals at the places of inflammation<sup>(22)</sup>. Several studies reported a low antioxidant. Levels are a risk factors indicated that the inflammatory process produces ROS and decreased antioxidant levels, which may worsen the symptoms of the RA<sup>(16)</sup>

**3. Enzymatic antioxidants:** Table(1) showed a significant decrease ( $P \leq 0.05$ ) in the activity of superoxide dismutase (SOD) and ceruloplasmin enzymes by 63% and 10% respectively, whereas the activity of glutathione peroxidase (GPx) enzyme showed a significant increase by 44% in the serum of patients with RA by compared with the control. The results in table (2) also showed a significant decrease in the activity of SOD in female serum by 54% while in males by 51%, and the results showed a significant decrease in the activity of ceruloplasmin in males by 11% while in females by 10%, while showed the activity of GPx significantly increased in females by 46% while in males by 42%

compared with the control group. The results of this study are identical to the findings of previous studies<sup>18</sup>. The decreased SOD activity in serum of patients with RA may be attributed to increase of free radical especially that the superoxide ( $O_2^{*-}$ ) and hydrogen peroxide ( $H_2O_2$ ) inhibit the enzyme and reduce its activity. The enzyme decreased or increased according to the disease case, in this study, may indicate a degradation of these enzymatic antioxidants by free radicals during detoxification processes and it appears that increased level of ( $O_2^{*-}$ )<sup>(23)</sup>.

## Conclusion

We conclude from this study that an imbalance in the balance system of oxidants, enzymatic and non-enzymatic antioxidants, had a significant impact on the deterioration of the condition of patients with RA. The RA caused oxidative stress.

**Acknowledgements:** The authors are very grateful to the Mosul University/Science Collage/Biology Department for their provided facilities, which helped to improve the quality of this work.

**Conflict of Interest:** None of the authors has any Conflicts of Interest to declare.

**Source of Funding:** Self

**Ethical Clearance:** The project was approved by the local ethical committee (Science College, Mosul University, Iraq).

## Reference

1. Zerbini C, Clark P, Mendez – Sanchez L, Pereira R, Messina O and Lane N. Biologic therapies and bone loss in rheumatoid arthritis Osteoporos Int. 2018, 31:198 - 216.
2. Mahdi J, Jewad A and Kassin M . Oxidative stress status in patients with rheumatoid arthritis. ThiQar Med. J. 2018, 16 (2): 21-28.
3. Ighodaro O and Akinloye O. First line defense antioxidants superoxide dismutase (SOD), catalase (CAT) and glutathione peroxidase (GPx): Their fundamental role in the entire antioxidant defense gird. Aleand. J. Med. 2018, 54: 287-293.
4. Ahn B, Ranjit R, Permkumar P, Pharaoh G, Piekarz K, Matsuzaki S, Claflin D and Remmen H. Mitochondrial oxidative stress impairs contractile function but paradoxically increase muscle mass via fiber branching J. Sarco Musc. 2019, 10: 411-428.
5. Satish B and Dilipkumar P. Free radicals natural antioxidants and their reaction mechanism. J. Ro.Sci. Chem. 2015, 5: 27986-28006.
6. Rahal A, Kumar A, Singh V, Yadav B, Tiwari R, Chakraborty S and Dhama K. Review Article, Oxidative stress, prooxidants and antioxidants: the interplay. BioMed. Res. Int. 2014, 1-19.
7. Arnett F C, Edworthy SM, Bloch DA. The American Rheumatism Association 1987 revised criteria for the classification of rheumatoid arthritis. Arth. Rheu. 1988, 31(3), 315-324.
8. Guidet B and Shah S. (1989). Am. J. Physiol., 257(26). F440. Cited by Muslih, R. K.; Al – Nimer, M. S. and Al Zamely, O. y. (2002). The level of malondialdehyde after activation with H<sub>2</sub>O<sub>2</sub> and CuSO<sub>4</sub> and inhibition by deferoxamine and molsidomine in the serum of patient with a cute myocardial infraction. Nat. J. Chem., 5:139–149.
9. Sedlak J and Lindsay R H. (1968). "Analytical Biochemistry". P.192. Cited by Al Zamely, O.; Al Nimer, M and Muslih, R (2001).
10. Doumens B, Watson W and Biggs H. Albumin standerds and the measurement of serum albumin with bromocresol green. Clin. Chem. Acta. 1971, 31: 87– 96.
11. Newman DT and Price C P. "Renal and nitrogen merabolism". Cited by Tietz, N.W. (1999). "Textbook of Clinical Chemistry". 3rd ed. N.R. Burtis, E. R. Ashwood, W. B. Saunders Company, Philadelphia, USA. 1999. Pp.477-530.
12. Brown MS and Goldstein A. (1983). Ann. Rev. Biochem., 25, 233. Cited by Al Zamely et al., (2001).
13. Emerson E. The condensation of aminoantipyrine II a new color test for phenolic Compounds. J. Org. Chem. 1943, 8(5):417-428.
14. Menden E, Boiano J, Murthy L and Petring H. Modification of phenylenediamine oxidase, method to permit non-automated ceruloplasmin determination in batches of rat serum or plasma micro samples Analytical. 1977, 10: 197-204.
15. Waqas M, Saeed U, Saeed S, Asif S, Malik A and Tariq R. Augmented points of lipid peroxidation and appearance of prophetic variables and their affiliation to develop rheumatoid arthritis. European J. Pharma. Med. Res. 2019, 6(6): 181-186.
16. Hammodat Z M. (2013). Isolation and purification latent metalloproteinase-1 from patients with rheumatoid arthritis in Ninevah governorate. PhD. Thesis. Science College, Mosul University, Iraq.
- [17. Al - Youzbaki W, fatehi H and Yassen A .Oxidant and antioxidant status in patients with rheumatoid arthritis treated by methotrexate. Iraqi J. Comm. Med. 2013, 1: 63-67.
18. Fonseca L, Nunes - Souza V, Goulart M and Robelo L. Oxidative stress in rheumatoid arthritis: What the future might hold regarding novel biomarkers and add - on therapies. Oxidative Med. Cell. Long. 2019, 16:1-17.
19. Ernest H, Stelzer k, Andreas W, ULF – Muller L and Stehle G. Albumin - based drug delivery as novel therapeutic approach for rheumatoid arthritis. J. Immunol. 2003, 170:4793-4801.
- 20] Kleb NT. (2014). Study the level of oxidative stress and some physiological parameters of rheumatoid arthritispateints. Msc. Thesis, Science College, Tikrit University, Iraq (In Arabic).
21. Naji ZM, Mohammed M and Muhammad M F. Uric acid as a natural scavenger of peroxy nitric in a sample of Iraqi patients with rheumatoid arthritis. Iraq J. Pharm. Sci. 2012, 21(2):51-55.
22. Alorainy M. Effective of allopurinol and vitamin E on rat model of rheumatoid arthritis. Int. J. Health Sci. Qassim Unive .2002, 2:59-67.
23. Karatas F, Ozates L, Canatan H, Halifeoglu I, Karatepe M and Colak R. Antioxidant status and lipid peroxidation in patients with rheumatoid arthritis. Indian J. Med. Res. 2003, 118:178-181.

# The Concentration of Lead and Cadmium in the Gill and Muscle of Common Carp Fish (*Cyprinus carpio*) in Three Fish Farms in DhiQar City–South Iraq

Wesan Fadhel Khalef<sup>1</sup>, Zainab Mohsen Ibrahim<sup>2</sup>, Bushra Ali Ghyadh<sup>2</sup>

<sup>1</sup>Assistant Lecturer, <sup>2</sup>Lecturer Department of Biology, College of Science, Thi-Qar University, Iraq

## Abstract

The present study was conducted to estimate the concentration of lead and cadmium element in gill and muscle of fish *Cyprinus carpio* in three fish farms derive their water from Garraf channel, a branch of the Tigris River in the province of DhiQar. The results of the present study that the concentration of trace elements (cadmium and lead) in the gills was higher than delimiters standard for joining the World Health where it is dangerous for human consumption, either in the muscles was lower concentration of them in the gills, we conclude from this study that fish consumption Farm at the present time does not cause marked damage but in the future cause a problem should be avoided.

**Keywords:** *Cyprinus carpio* trace elements, fish farms.

## Introduction

The fish farming tributaries economic task in many countries of the world and taking this role is rising day after day, especially in recent years for several reasons articulated by the report issued by the bound food and agriculture and organization<sup>1</sup>, which pointed out that most of the marine fisheries reached the stage saturation so that it cannot increase no matter how wild fish harvests increased fishing activity, and that fish stocks continues to decline due to an environmental fettle and overfishing, and the same source pointed out that aquaculture can contribute to the increase of fish products.

Aquaculture's success on a number of interrelated factors and may vary from the most important of those that specializes in environmental and water and the quality of water basins and of the most important environmental factors affecting fish farming, including pollutants that affect its presence on the suitability and

appropriate environment and water for fish breeding and including trace minerals process<sup>2</sup>

The aim of the study: Due to the lack of an integrated study on fish farms and the extent of contamination of trace elements and what are the cause

## Materials and Method

**Description study area:** Samples are taken the common carp (*Cyprinus carpio*) seasonally from winter 2018 to the autumn of 2018, the number 9 fishs per season from careless stations ranged in length from 20-25 cm of the three fish farms in the province of DhiQar inches these farms manner drill and fill the docks using pumps diesel, the area of each farm almost one acre and derive their water from Garraf channel, a branch of the Tigris River.

### The study stations:

1. **The station (Fish Farm) first:** Located near the Gharraf River after leaving the hand victory north of DhiQar surrounding this Farm Agricultural Land and population centers on the opposite bank of the farm on the river Garraf
2. **The station (Fish Farm) Second:** Just 15 km away from the first is located near the Gharraf River after

---

### Corresponding Author:

**Bushra Ali Ghyadh**

Lecturer Department of Biology, College of Science, Thi-Qar University, Iraq  
e-mail: bushraali339@gmail.com



leaving the contraption area in the district of Shatra surrounded by agricultural lands and small villages the station

3. **The station (Fish Farm) third:** Just 15 km from the second substation and is considered one reference where is located near the River Garraf before entering to hand Garraf and surrounded

Port Lands uncultivated and localities do not exist around. Separated gill and muscles Fish separately and cut into small pieces and dried oven electric degree 120 ° and milled and Nkhalt and digested by acid intensive depending on how <sup>6</sup> and measured trace elements by spectrum atomic absorption flame device and expressed it units (mcg/g dry weight).

## Results

The results show as in figures below:

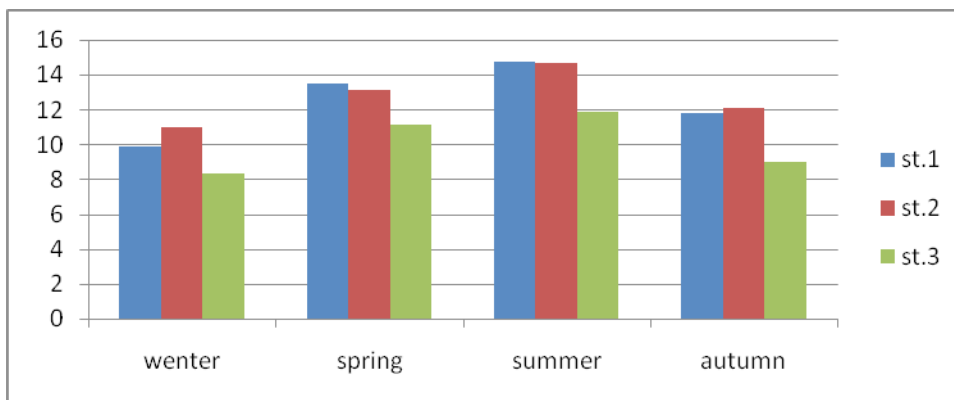


Figure 1: Concentration for cadmium (mg/l) in fish gill of common carp fish in the study stations

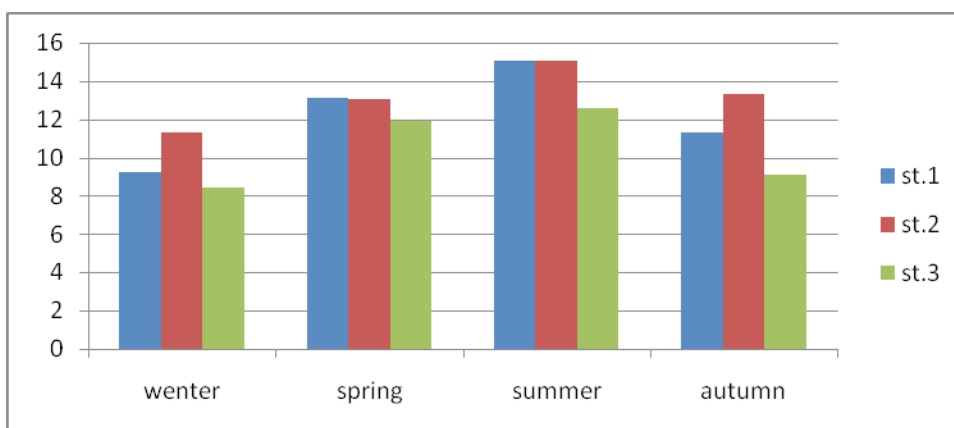


Figure 2: Concentration for lead in fish gill of common carp fish in the study stations

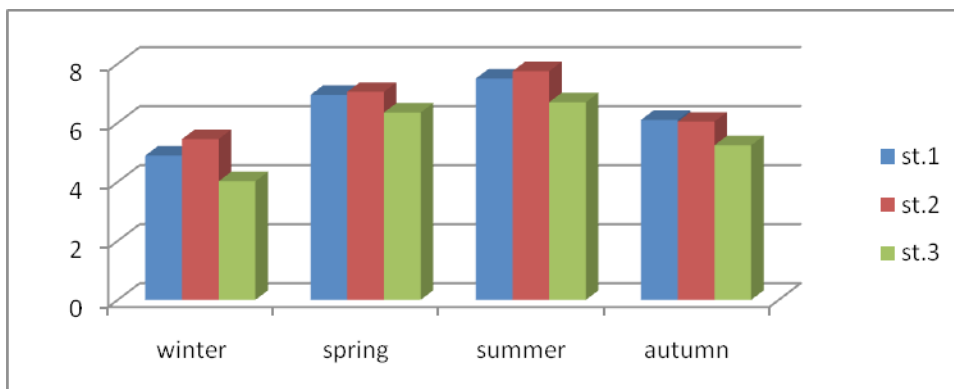
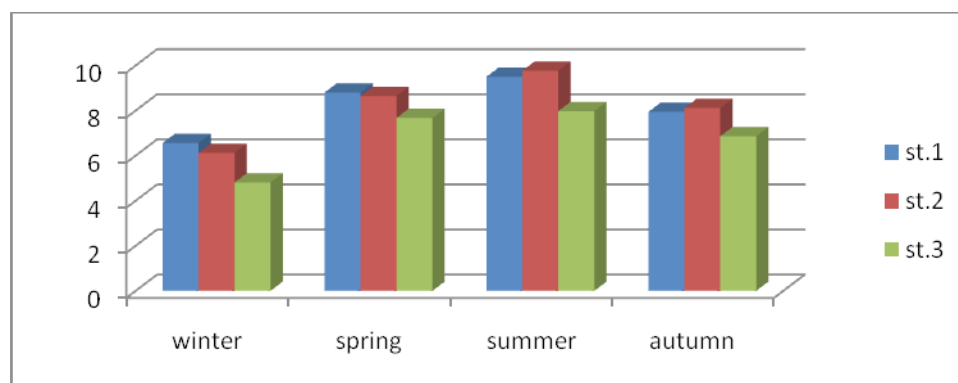


Figure 3: Concentration for cadmium in the muscles of the common carp fish in the study stations



**Figure 4: Concentration lead in the muscles of common carp fish in the study stations.**

## Discussion

The study of fish muscle content of trace elements is important and that which is to know the amount up to which the human body as a Gmaoua key and cheap<sup>3</sup> as the concentration of the components found in the body of water does not reflect the degree of contamination without necessarily accumulation in the neighborhoods<sup>4</sup> the study results showed high cadmium and lead concentration in the gill and muscles Blowfish

Careless for the first, the second station Compared with the third leg the fact that the station (1.2) are similar in pollution sources trace elements waste human, fertilizers and pesticides<sup>8</sup>. The concentration of cadmium and lead is the highest in the gills of it in the muscles because of that first considered the site is important to enter the heavy elements and cause the effects of destructive gill<sup>5</sup>, and have their accumulation in the muscles less because of the lack of correlation trace elements muscle protein<sup>6</sup>. The increase in the concentration careless in the summer due to evaporation, leaving the salts of heavy metals to increase its concentration in the water, which shows its effect by increasing its accumulation in fish as a result of increasing the amount of heavy-element taken from the water<sup>7</sup>.

## Conclusions

1. Eating gills is safer because it is more exposed and in contact with trace elements.
2. The cause of the accumulation in the tissues of the fish careless that elements in the water freely easier for fish taken from her.
3. The severity of the tendency of these elements to the accumulation in the members fish shows easily

lured and its association with elements ubiquitous organ and this form does not exist in a natural state (in the absence of pollution) indicating that they entered the outsourcing of polluting downtown.

**Conflict of Interests:** Nil.

**Ethical Clearance:** Take from stations in DhiQar by approval ethical committee.

**Funding:** Self-funding.

## References

1. FAO primary aquatic animal health care in rural, smel-scale, aquaculturedevel. FAO, fish tech. 2004. 406:55-61.
2. Jamal, Amin Abdul Muti. Agriculture and Fish House first part of scientific books 337 p.2006.
3. Olaifa .F. G.; Olaifa, A.K. and onwude, T.E. Lethal and sublethal effects of copper to the African cat fish Afr. J. Biomed. res. 2004,7:65-70.
4. Gulfraz, M.: Ahmed, T. and Afzal, H. Concentration levels of heavy metals in fish and relevant water from rawal and mangla of biological science,2001.1(5):414-416.
5. Bols,N.C.; Brubacher, J.L. Exotoxicology and innate immunity in fish dev. Comp. immunol. 2001. 25(8):853-873.
6. Canli, M. and kalay, M. Levels of heavy metals(cd,pb,cu,cr,andni)in tissue of caprinuscarpio, Barbuscapito from the seyhanriver, turke y . J. Zool. 1998. 22:149-157.

7. Adeyeye, E.I.; Akinyugha, N.J.; Fesobi, M.E. and Tenabe, V.O. Determination of some metal in *Carrasgariepius* (Cuvier & Valenciennes) *Cyprinocarpio* (L) fish in poly culture fresh water pond and their environment. *Aquatic* .1996.47:205-214.
8. Khalaf azwar Numan, al-Jaafari, Asmaa Rashid, Elias, Suhadsadik and Wrood, Mary Ishaac. Bio-accumulation of some heavy metals in some fish tissues Ataiwana of the Diyala River, *Journal of Life Sciences Research* .1986.45-27 (1) 17.

# Characteristics, Effective Reproduction Number (Rt), and Prediction SIR Model of Covid-19 at Banyumas District, Central Java, Indonesia

Yudhi Wibowo<sup>1</sup>, Nendyah Roestijawati<sup>2</sup>, Siti Munfiah<sup>3</sup>, Sadiyanto<sup>4</sup>, Arif Burhanudin<sup>5</sup>, Misti Rahayu<sup>6</sup>

<sup>1</sup>Assistant Professor in Department of Community Medicine, <sup>2</sup>Assistant Professor in Department of Community Medicine, <sup>3</sup>Instructor in Department of Community Medicine, Faculty of Medicine, Jenderal Soedirman University, Purwokerto, Indonesia, 53112, <sup>4</sup>Practitioner and Staff, <sup>5</sup>Practitioner and Staff <sup>6</sup>Practitioner and Staff at the Banyumas District Health Office, Central Java

## Abstract

**Background:** The Covid-19 pandemic has spread to 215 countries and territories since the outbreak first occurred in Wuhan, China. Indonesia has also declared the Covid-19 national disaster since 2 positive patients were found on March 2, 2020 and there has been a rapid spread to various regions in Indonesia including Banyumas District. This study aims to determine the risk factors, effective reproduction number and predictions SIR of Covid-19 in the Banyumas District for the period of 16 March - 14 June 2020.

**Method:** This study is a cross-sectional design. Cases are patients with confirmed covid-19 in the area. Minimum sample size was 43 and total sample size was 70 people. Univariate analysis was used to describe of characteristics, estimate to determine effective reproduction number, and SIR model to determine prediction of covid-19.

**Result:** As of June 14, 2020, in Banyumas District there were 392 suspected cases, 70 confirmed cases, 58 cases were recovered and 4 people died. The characteristics of the confirmed cases were the age group of 15-24 years as much as 21.1%, males 62%, 52.1% have a history of travel to/from out of town, and 91.5% showed symptoms especially fever symptoms as much as 81.7%. The effective reproduction number (Rt) for the period March 16, 2020-June 14, 2020 was 1.81 (0.83-3.35; 95% CrI). SIR model predictions, that the peak of the outbreak will occur on June 21, 2020 with the number of confirmed cases of 4,312 people.

**Conclusions:** The covid-19 outbreak in Banyumas District was still out of control and still ongoing. It is recommended to continue to increase discipline of health protocols, get used to wearing masks, keep a distance and wash hands with soap and strengthen tests, traces and treatments and also protect vulnerable groups.

**Keywords:** *Characteristics, effective reproduction number (Rt), SIR model of confirmed covid-19, Banyumas District.*

---

## Corresponding Author:

**Dr. Yudhi Wibowo, M.Ph**

Department of Public Health & Community Medicine  
Department, Faculty of Medicine, Jenderal Soedirman  
University Purwokerto, Banyumas, Central Java,  
Indonesia, Jl. Dr. Gumbreg No. 1, Mersi, East  
Purwokerto 53112

Phone: +62281-622022/08112621904

e-mail: dryudhiwibowo2005@gmail.com

## Introduction

Corona virus disease-19 (covid-19) is an infectious disease caused by Severe Acute Respiratory Syndrome-Corona Virus-2 (SARS-CoV-2) formerly known as 2019-nCoV. This disease originated from 41 cases of pneumonia without known cause in Wuhan, Hubei Province, China on December 30, 2019 and there is a history of contact with the seafood market.<sup>1-4</sup>

On March 11, 2020, WHO declared a global co-19 pandemic. This is because in the last 2 weeks there has been an increase in cases outside China 13 times and the number of affected countries increased 3 times.<sup>5,6</sup> As of May 5, 2020, the co-19 pandemic has spread to 215 countries and territories. Globally there were 3,525,116 confirmed covid-19 cases and 243,540 deaths.<sup>7</sup>

While in Indonesia as of May 6, 2020, there were 12,071 confirmed co-19s and 872 deaths. In Central Java, as of June 13, 2020 there were 2,066 positive and 147 people died and became the fourth epicenter after DKI Jakarta, East Java and West Java,<sup>8</sup> while in Banyumas District there were 69 positive people and 4 people died. Characteristics of positive cases for a while as much as 60.6% are male and dominated by adolescents (10-19 years) as much as 16.7%.

At present, most countries, including Indonesia, are preparing for a new normal life, as well as the Banyumas District. WHO has issued public health criteria to adjust public and social health measures in the context of covid-19. According to WHO, the covid-19 outbreak was controlled if  $R_t < 1$  for at least 2 weeks.<sup>9</sup> This study aims to determine the characteristics, effective reproduction number & prediction of the SIR model of Covid-19 disease in Banyumas District, Central Java.

## Method

**Research Design:** This study was an observational analytic study using a cross-sectional design i.e. retrieval data and risk factors are carried out at one time. This study also uses Epiestim software to calculate the number of reproductive effectives and computer equipment to calculate the prediction of the SIR covid-19 outbreak model in Banyumas District.

**Research Subjects:** The population of this study was sourced from secondary data from the Banyumas District Health Office for the period March 16 to June 14, 2020. Suspect cases were cases that meet the criteria for suspicion according to WHO. Confirmation cases were cases with positive PCR results.<sup>10</sup>

The sample size was determined based on the significance level of 0.05, the strength of the test 80%, the proportion  $p=q=0,5$ , obtained a sample size of at least 43 people and in this study the total sample size was 71 confirmed cases and 392 suspected cases.

**Data Collection:** The data was sourced from secondary data collected by the Banyumas District Health Office for the period March 16 to June 14, 2020. These data were the results of a survey containing names, addresses, age, sex, date of onset, symptoms and signs as well as travel history from/to outside city.

**Effective Reproduction Number ( $R_t$ ):** The effective reproduction number ( $R_t$ ) is an important parameter to find out whether outbreak control is effective or additional interventions are needed.<sup>11</sup>  $R_t$  values represent the number of new secondary cases that are infected from one infective case at time  $t$ . If  $R_t > 1$ , the possibility of disease will become epidemic, if  $R_t = 1$ , the disease becomes endemic and if  $R_t < 1$ , the possibility of disease will disappear from circulation.<sup>12</sup>

To calculate the  $R_t$  in this study using EpiEstim software based on Excel developed by Cori et al in 2013<sup>13</sup> and corrected by Thomson et al in 2019<sup>14</sup>. The mean serial interval (SI) and standard deviation (SD) using the results of the study of Tindale et al, namely the average  $SI = 4.56$  and  $SD = 0.95$ .<sup>15</sup>

**Prediction SIR Model:** The SIR model as the initial formula that has been formulated by Kermack and McKendrick<sup>16</sup> is a differential system  $S(t); I(t); R(t); \gamma > 0$ :

$$S_t = -SI; \quad (1a)$$

$$I_t = SI - \gamma I; \quad (1b)$$

$$R_t = \gamma I; \quad (1c)$$

The interpretation of this model is very easy. The Susceptible individual population decreases through interaction with infective people, whose numbers increase through this mechanism. On the other hand, the population of infective individuals decreases because some individuals recover or die, and thus fill the Recover class. This epidemic model is known as the Susceptible, Infective, and Recover/Removed (SIR) epidemic model. The SIR model is very useful for predicting the future, end and peak of epidemics and other activities related to epidemic diseases.<sup>17</sup>

In this study,  $R$  = number of patients who recovered + who died. The description of the SIR model for Recover returning to Susceptible because the world outbreak of COVID-2019 has developed that patients who recover can be re-infected.<sup>18</sup>

S in this study is based on the estimated number of people who should be examined according to WHO standards of 1/1000 population per week.<sup>19</sup> During the period of March 16 to June 14, 2020 (13 weeks), the population of Banyumas District was 1,840,152 people, so  $1,840 \times 13 = 23,922$  people as Suspected (S).

**Data Analysis:** Secondary data were analyzed to describe the characteristics of confirmed cases according to age group, sex, travel history to/from out of town, symptoms and signs. Rt was analyzed using EpiEstim to obtain median Rt and 95% CrI. The prediction of the SIR model with computer software was analyzed to determine the prediction of the outbreak peak and the end of the covid-19 outbreak in Banyumas District.

**Ethical Clearance:** This study was approved by the Commission on Health Research Ethics, Medical School, Jenderal Soedirman University (Unsoed) with Ref no: 151/KEPK/VI/2020.

### Results

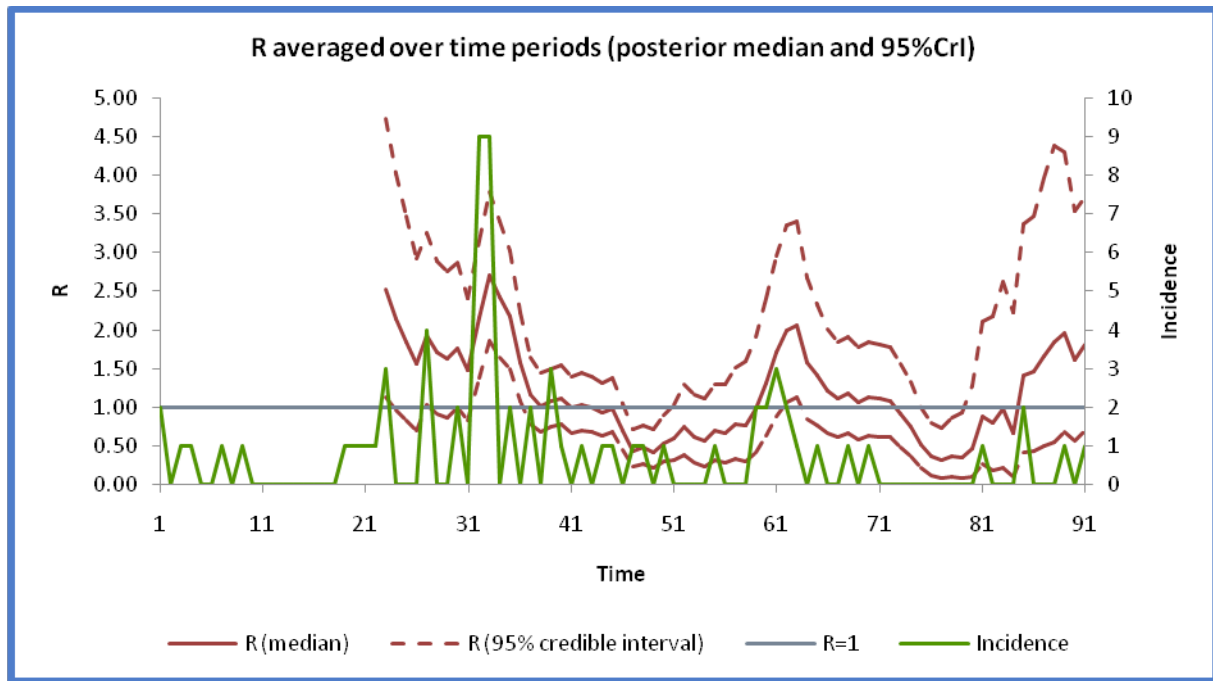
Banyumas District is one of the districts in Central Java, Indonesia. Banyumas District consists of 27 sub-districts and 331 villages/outlands with an area of 132,759 hectares and a population of 1,840,152 people. During the period from March 16 to June 14, 2020, there were 392 suspected cases, 71 confirmed cases, 58 cases were recovered and 4 cases died due to covid-19. Characteristics of 71 confirmed cases when first treated, are presented in Table 1.

**Table 1. Characteristics of Comfirmed Covid-19 Cases**

Characteristics		n	%
<b>1</b>	<b>Age Group (year)</b>		
	0-<5	2	2.8
	5-14	5	7.0
	15-24	15	21.1
	25-34	10	14.1
	35-44	10	14.1
	45-54	8	11.3
	55-64	11	15.5
	65-74	5	7.0
	75-84	5	7.0
	>84	0	0

Characteristics		n	%
<b>2</b>	<b>Gender</b>		
	Male	44	62.0
	Female	27	38.0
<b>3</b>	<b>Travel history</b>		
	Yes	37	52.1
	Not	34	47.9
<b>4</b>	<b>The symptoms</b>		
	Yes	65	91.5
	Fever	58	81.7
	Cough	33	46.5
	Flu	4	5.6
	Sore throat	1	1.4
	Headache	1	1.4
	Malaise	1	1.4
	Nauseous vomit	1	1.4
	No appetite	1	1.4
	Dyspneu	4	5.6
	Not	6	8.5
<b>5</b>	<b>Death</b>	<b>4</b>	<b>5.6</b>
	<b>Age group (year)</b>		
	45-54	2	50.0
	55-64	1	25.0
	75-84	1	25.0
	<b>Gender</b>		
	Male	2	50.0
	Female	2	50.0

According to Table 1, the 15-24 years age group most suffering from covid-19 were 21.1%, 62% were male, 52.1% had a history of travel to/from out of town and 91.5% showed symptoms with main symptoms were fever (81.7%) and cough (46.5%). Cases that have died amounted to 4 people or a mortality rate of 5.6% with the age of 45 years and over and have comorbid diseases. Effective reproduction number (Rt) for the period March 16 to June 14, 2020, obtained  $Rt = 1.81$  (0.83-3.35; 95% CrI) as shown in Figure 1. In the past 14 days, the trend of Rt can be seen in Table 2.



**Figure 1. Trends of Effective Reproductive Number (Rt) of Covid-19 in Banyumas District, Period March 16 to June 14, 2020**

**Table 2. Trends of effective reproductive numbers (Rt) of covid-19 for the last 14 days**

No.	Date	0,05 Q	M	0,95 Q
1	01-Jun-20	0,14	0,36	0,77
2	02-Jun-20	0,1	0,34	0,81
3	03-Jun-20	0,15	0,47	1,12
4	04-Jun-20	0,33	0,89	1,87
5	05-Jun-20	0,25	0,8	1,9
6	06-Jun-20	0,3	0,97	2,29
7	07-Jun-20	0,14	0,67	1,89
8	08-Jun-20	0,52	1,41	2,97
9	09-Jun-20	0,54	1,45	3,07
10	10-Jun-20	0,62	1,66	3,51
11	11-Jun-20	0,68	1,84	3,88
12	12-Jun-20	0,83	1,96	3,84
13	13-Jun-20	0,68	1,61	3,15
14	14-Jun-20	0,83	1,81	3,35

According to Table 2, Rt Covid-19 from 1-14 June 2020 (last 14 days) still obtained  $R_t < 1$  but upper bound  $> 1$  &  $R_t > 1$  (red color). The Covid-19 outbreak in

Banyumas District was predicted for the next 100 days from June 14, 2020 with the SIR model and the results are presented in Figure 2 and Table 3.

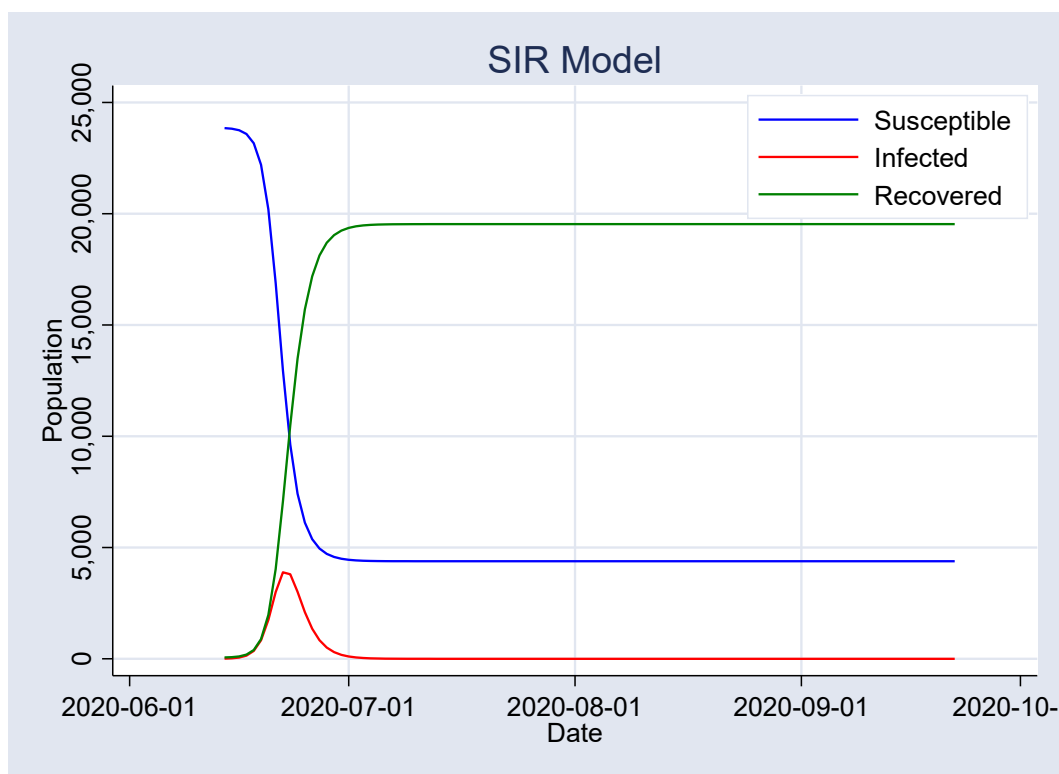


Figure 2. SIR Model of Covid-19 Outbreak in Banyumas District

Table 3. SIR Model of the Peak and end of Covid-19 Outbreak

Population	2020-06-14	2020-06-22	2020-09-22
Susceptible	23,848	12,948	4,348
Infected	9	3,886	0
Recovered	62	7,083	19,534
<b>Total</b>	<b>23,918</b>	<b>23,918</b>	<b>23,918</b>

### Discussion

The 15-24 years age group is the highest group suffering from confirmed covid-19 cases in Banyumas Districts. It is appropriate that covid-19 can affect all ages.<sup>20</sup> Specifically, in Banyumas District, this age group is related to school-age children where at the beginning of the outbreak, no action has yet been taken to close the learning process at school. Some schools even have study tours outside the city. Of course, this increases the risk of covid-19 transmission. There were 52.1% of confirmed cases have a history of travel from/out of town and certainly increase the risk of covid-19 transmission.<sup>21</sup>

The confirmed covid-19 cases were 62% male. Covid-19 sufferers are mostly male, this is associated with the possibility of men smoking more, and

women have protection from the X chromosome and sex hormones which play an important role in innate immunity and adaptation.<sup>22-24</sup>

There were 4 cases of death (mortality rate 5.6%) due to covid-19 and age 45 years or more and had comorbid disease. Old age and the presence of chronic comorbid diseases can increase the fatality of covid-19 disease. Although the covid-19 fatality rate at the age of 80 years or more between China and Italy is the same.<sup>22,25</sup> According to the Centers for Disease Control and Prevention (CDC) the age group (≥65 years) and all ages with comorbid diseases such as chronic lung disease, moderate-severe asthma, heart disease, immunocompromis (cancer treatment, smoking, organ transplantation or bone marrow, immune deficiency, uncontrolled HIV/AIDS, prolonged use of corticosteroids, and other treatments that weaken



the immune system), severe obesity, diabetes mellitus, chronic kidney disease, and liver disease, increase the risk of suffering from severe covid-19.<sup>20</sup>

The effective reproduction number (Rt) in the last 14 days, namely June 1, 2020 to June 14, 2020, is obtained  $R_t > 1$ .<sup>9</sup> Predictions with the SIR model that the peak of the outbreak will occur on June 22, 2020 with the number of cases as many as 3,886 and the outbreak will subside on September 22, 2020. This indicates that the covid-19 outbreak in Banyumas Districts has not been controlled. Therefore, efforts to increase discipline on health protocols, to get used to using masks, keep a distance from others at least 1-2 meters and wash hands with soap. contact tracing, testing and treatment continue to be improved and protect vulnerable groups.

### Conclusions

The covid-19 outbreak in Banyumas Districts is still not controlled. Therefore, it is still necessary to remain disciplined about health protocols and other prevention efforts. Tracing contacts, testing and treatment continues to be strengthened while still protecting vulnerable groups.

**Conflict of Interest:** The authors declare that they have no competing interests.

**Acknowledgment:** Thank you to the Jenderal Sudirman University, The Institute for Research and Community Service, Faculty of Medicine, Banyumas District Health Office and Community Health Care for their cooperation and assistance.

**Source of Funding:** This research was independently funded. It was a collaboration between the Faculty of Medicine, Jenderal Soedirman University and the Banyumas District Health Office, Central Java.

### References

1. WHO. Coronavirus [Internet]. Geneva: WHO; 2020. p. tab1. Available from: [https://www.who.int/health-topics/coronavirus#tab=tab\\_1](https://www.who.int/health-topics/coronavirus#tab=tab_1)
2. WHO. Naming the coronavirus disease (COVID-19) and the virus that causes it. World Heal Organ [Internet]. 2020; Available from: [https://www.who.int/emergencies/diseases/novel-coronavirus-2019/technical-guidance/naming-the-coronavirus-disease-\(covid-2019\)-and-the-virus-that-causes-it](https://www.who.int/emergencies/diseases/novel-coronavirus-2019/technical-guidance/naming-the-coronavirus-disease-(covid-2019)-and-the-virus-that-causes-it)
3. Isaac I. Bogoch, Alexander Watts, Andrea Thomas-Bachli, Carmen Huber MUGK and KK. Pneumonia of unknown aetiology in Wuhan, China: potential for international spread via commercial air travel. J Travel Med [Internet]. 2020; Available from: <https://doi.org/10.1093/jtm/%0Aataa008>
4. Lu H, Stratton CW, Tang YW. Outbreak of pneumonia of unknown etiology in Wuhan, China: The mystery and the miracle [Internet]. Journal of Medical Virology. 2020. Available from: <https://doi.org/10.1002/jmv.25678>
5. Sohrabi C, Alsafi Z, O'Neill N, Khan M, Kerwan A, Al-Jabir A, et al. World Health Organization declares global emergency: A review of the 2019 novel coronavirus (COVID-19). International Journal of Surgery. 2020.
6. Cucinotta D, Vanelli M. WHO declares COVID-19 a pandemic. Acta Biomedica. 2020.
7. WHO. Coronavirus disease [Internet]. Vol. 2019, World Health Organization. 2020. p. 2633. Available from: <https://www.who.int/emergencies/diseases/novel-coronavirus-2019>
8. Kemenkes R. Situasi Terkini Perkembangan Coronavirus Disease (COVID-19) 5 Mei 2020 [Internet]. Jakarta; 2020. Available from: <https://covid19.kemkes.go.id/situasi-infeksi-emerging/info-corona-virus/situasi-terkini-perkembangan-coronavirus-disease-covid-19-5-mei-2020/#.XrJDkkgzblU>
9. World Health Organisation. Considerations in adjusting public health and social measures in the context of COVID-19. World Heal Organ [Internet]. 2020;(May):1–7. Available from: <https://www.who.int/publications-detail/risk->
10. WHO. World Health Organization. Global Surveillance for human infection with coronavirus disease (COVID-19). Interim Guid [Internet]. 2020;(February):27–9. Available from: [https://www.who.int/publications-detail/global-surveillance-for-human-infection-with-novel-coronavirus-\(2019-ncov\)](https://www.who.int/publications-detail/global-surveillance-for-human-infection-with-novel-coronavirus-(2019-ncov))
11. Nishiura H, Chowell G. The effective reproduction number as a prelude to statistical estimation of time-dependent epidemic trends. In: Mathematical and Statistical Estimation Approaches in Epidemiology. 2009.
12. Camacho A, Kucharski A, Aki-Sawyer Y, White MA, Flasche S, Baguelin M, et al. Temporal

- changes in ebola transmission in sierra leone and implications for control requirements: A real-time modelling study. Vol. 7, PLoS Currents. 2015.
13. Cori A, Ferguson NM, Fraser C, Cauchemez S. Package 'EpiEstim' July. American Journal of Epidemiology. 2013.
  14. Thompson RN, Stockwin JE, van Gaalen RD, Polonsky JA, Kamvar ZN, Demarsh PA, et al. Improved inference of time-varying reproduction numbers during infectious disease outbreaks. *Epidemics*. 2019;
  15. Tindale L, Coombe M, Stockdale JE, Garlock E, Lau WYV, Saraswat M, et al. Transmission interval estimates suggest pre-symptomatic spread of COVID-19. medRxiv. 2020;
  16. W. O. Kermack and A. G. McKendrick. A contribution to the mathematical theory of epidemics. In: Proceedings of the Royal Society of London Series A, Containing Papers of a Mathematical and Physical Character. 1927.
  17. Hethcote HW. Mathematics of infectious diseases. *SIAM Rev*. 2000;
  18. Yadav DRS. Mathematical Modeling and Simulation of SIR Model for COVID-2019 Epidemic Outbreak: A Case Study of India. medRxiv. 2020;
  19. World Health Organization. Considerations for public health and social measures in the workplace in the context of COVID-19. World Heal Organ [Internet]. 2020;(May):1–7. Available from: <https://www.who.int/publications-detail/risk->
  20. Centers for Disease Control and Prevention. People who are at higher risk for severe illness | CDC [Internet]. Centers for Disease Control and Prevention. 2020. Available from: [https://www.cdc.gov/coronavirus/2019-ncov/need-extra-precautions/people-at-higher-risk.html?CDC\\_AA\\_refVal=https%3A%2F%2Fwww.cdc.gov%2Fcoronavirus%2F2019-ncov%2Fhcp%2Funderlying-conditions.html](https://www.cdc.gov/coronavirus/2019-ncov/need-extra-precautions/people-at-higher-risk.html?CDC_AA_refVal=https%3A%2F%2Fwww.cdc.gov%2Fcoronavirus%2F2019-ncov%2Fhcp%2Funderlying-conditions.html)
  21. Bi Q, Wu Y, Mei S, Ye C, Zou X, Zhang Z, et al. Epidemiology and Transmission of COVID-19 in Shenzhen China: Analysis of 391 cases and 1,286 of their close contacts. medRxiv. 2020;
  22. Chen N, Zhou M, Dong X, Qu J, Gong F, Han Y, et al. Epidemiological and clinical characteristics of 99 cases of 2019 novel coronavirus pneumonia in Wuhan, China: a descriptive study. *Lancet*. 2020;
  23. Cai H. Sex difference and smoking predisposition in patients with COVID-19. *The Lancet Respiratory Medicine*. 2020.
  24. Jaillon S, Berthenet K, Garlanda C. Sexual Dimorphism in Innate Immunity. *Clinical Reviews in Allergy and Immunology*. 2019.
  25. Onder G, Rezza G, Brusaferro S. Case-Fatality Rate and Characteristics of Patients Dying in Relation to COVID-19 in Italy. *JAMA - Journal of the American Medical Association*. 2020.

# Medico-Legal Outlooks in Preventing Traffic Violations and Accidents by Enforcing the Structure and Function of the Police Unit

Yusriyadi

Lecturer at Faculty of Law, Diponegoro University, Indonesia

## Abstract

By using medico-legal outlooks, the focus of this research is the structure, function and role of the Dikyasa Unit as part of law enforcement by the Police. This focus is normatively found in Law Number 22 of 2009 concerning Road Traffic and Transportation. There are two problems, first, what is the structure, function and role of the Dikyasa Unit and what are the two social and personal factors that affect the function and role of the Dikyasa Unit. To analyze this problem, a research was conducted in the Legal Area of the Semarang Police as an alternative legal study that positions the law in a broader community context. The research findings show that firstly, the Dikyasa Unit is in charge of fostering community participation and traffic education and secondly there are social and personal factors that affect the function and role of the dikyasa unit.

**Keywords:** *Traffic violations, accidents, police, function, medico-legal perspective.*

## Introduction

The structure, function and role of the Dikyasa Unit then in preventing traffic violations and accidents, are essentially part of law enforcement by the Police. The Dikyasa Unit then provides guidance and outreach to the community. The National Police, as one of the road transport traffic stakeholders, plays an active role in preventing traffic violations and accidents.

As the expected outcomes of Law No. 22 of 2009, the World Health Organization (WHO- World Health Organization) made an official statement, that by 2030 traffic accidents are the fifth cause of the “top ten” human deaths. In Indonesia, the death toll from traffic accidents is increasing. In 2013, there were 28,161 people, an increase of 1.8 percent compared to 2012 with 25,944 people who died. Article 2 of Law no. 22/2009 mentions

road transportation as one of the national transportation based on the principles of benefit, joint effort, fairness, equality, balance, public interest, integration, legal awareness and self-confidence. The goal is to create road traffic and transportation services in a safe, secure, orderly, smooth and integrated manner. The development of transportation demands the availability of means of transportation with various implications. The more means of transportation, the more road users are at risk of driving safety. As the number of road users increases, the number of traffic violations and accidents increases. These problems underlie the importance of this research.

**Problem:** There are two problems, namely: First, what is the structure, function and role of the Dikyasa Unit? Second, what social and personal factors influence the function and role of the Dikyasa Unit?

**Literature Review:** This research can be called an alternative legal study that positions law in the context of a broad society<sup>1</sup>. Qualitative data consists of primary and secondary data. The data sources are in the form of words and actions, accompanied by additional data such as documents<sup>2</sup>. Primary data sources were obtained from informants, namely members of the Dikyasa Unit through observation, interviews, document

---

## Corresponding Author:

Yusriyadi

Lecturer at Faculty of Law, Diponegoro University,  
Indonesia

e-mail: yusriyadi.undip@gmail.com

interpretation. Researchers as participant observe/key instrument. Interpretation and checking of the validity of the data using technical analysis models<sup>3,4</sup>. Researchers as participant observe/key instrument. The theory used is the theory of law enforcement from Chambliss & Seidman and Soekanto theory of the effectiveness of law, normative logic, not emphasized and more to empirical reality<sup>5,6</sup>.

Two theories are used to analyze two problems, namely Chambliss & Seidman's theory of law enforcement and Soerjono Soekanto's theory of the effectiveness of legislation<sup>7</sup>. The two theories are relevant for use in socio legal studies. Here, law is not only a normative document, but also as a socio-cultural symptom<sup>8</sup>. Normative logic (deductive-normological) is not emphasized, but rather empirical reality. By Chambliss & Seidman, this empirical reality is called social force and individual force<sup>5</sup>. Apart from these two theories, the concept of operational management of the Traffic Police is also used.

#### **Structure, Function and Role of Dikyasa Units:**

Law enforcement essentially is to realize the objectives of law, namely justice, certainty, and benefits<sup>9</sup>. Law is conceptualized as statutory regulation (*Sollen*) which must be realized, as well as as a social institution, so that this type of research is non-doctrinal. Law is seen as both the dependent and independent variable.

Initially, the analysis of the research results would be compiled based on field findings, but due to the Corona Virus Disease 2019 (COVID-19) outbreak which was declared a global pandemic by the World Health Organization (WHO) March 11, 2020, the research was not carried out optimally. Not maximizing, especially after the publication of the Semarang Regent Instruction No. 2 of 2020 concerning the Implementation of Restrictions on Community Activities in the Context of Accelerating the Management of Corona Virus Disease (Covid-19) as a protocol, so that the analysis is more based on literature study.

**Affecting Social and Personal Factors:** Law is made to be implemented, therefore it is not surprising that people say that law can no longer be called law when it has never been implemented<sup>10</sup>. Research on the role and function of this unit in power also wants to examine these roles and functions in the realm. Empirical, so that it is consistent with the notion of law as something that must be implemented.

In particular, the form of law can be seen through explicitly formulated rules. Within those legal principles, actions that must be carried out are contained in none other than law enforcement<sup>10</sup>. Discussing the function and role of the unit *dikyasa* essentially also talks about the implementation of abstract legal ideas (*Sollen*) into reality. From here we enter into a discussion about the operation of law in society which includes the role and function of the unit in power. The roles and functions of the *dikyasa* unit occupy an important and decisive position in preventing traffic violations and accidents. Legal objectives can ultimately become a reality in or through the roles and functions of the unit in power.

The role and function of the *dikyasa* unit is a function of the work of the influence of social and personal forces. It cannot be ignored the fact that law enforcers, *cq* unit *dikyasa* and adat community members will tend to give their own interpretation of the functions and roles that must be carried out. There are social and personal forces. This research stems from the awareness to distinguish law in the books and law in action.

The function and role of the unit is closely related to the law enforcement system, whose elements are (1) substance, (2) structure and (3) culture. To study the social and personal factors that contribute to the implementation of the function and role of the unit in power, the theory of Chambliss & Seidman<sup>5</sup>, theory Soekanto & Mamudji<sup>11</sup> is used regarding the effectiveness of a statutory regulation.

In addition to this theory, the concept of literature on the operational management of the Traffic Police is also used. This management refers to a process of planning, organizing, implementing, supervising and controlling in order to carry out police operations in order to achieve predetermined objectives effectively and efficiently.

Measuring the progress of an organization at all levels always concerns the neatness of the elements in order to achieve its goals. A neat organization, for example a crime organization, if it is neatly organized, it is often eradicated by the unorganized truth enforcers. Management has a literal meaning as "the art of implementing and managing" it is very crucial for the implementation of tasks in the organization. The art of implementing and managing this in the context of carrying out organizational tasks is in principle building synergy of every element of the activities involved in it.

The implementation of the functions and roles of the *dikyasa* unit is essentially a manifestation of legal ideas, or legal objectives become reality. The implementation of the functions and roles of the *dikyasa* unit is part of law enforcement. In understanding the implementation of these functions and roles, it can be started by analyzing the process of the operation of law in society.

William J. Chambliss & Robert B. Seidman basically reveals about the process of law operation in society<sup>5</sup>. This process is determined by the operation of the entire social and personal complex of each of the stakeholders. This theory of the operation of law in society can be used as an analogue regarding the implementation of the function and role of the unit in power. The implementation of the functions and roles of the *Dikyasa* Unit is determined by the operation of the entire social and personal complex of each of the role holders, namely the parties involved in it. Through Chambliss & Seidman's theory, it can be described, revealed and even explained the implementation of the function and role of the unit in the field.

In line with Chambliss & Seidman<sup>5</sup>, Satjipto Rahardjo<sup>12</sup>, states that the enactment of law as a process involves various elements, namely (1) the regulations themselves, (2) citizens as the regulatory environment, (3) implementing bureaucratic activities and (4) the existing and participating socio-political-economic-cultural framework determines how each element in the law carries out what it is a part of.

These elements can be seen in relation to one another in a dynamic interaction process, for example the relationship between statutory regulations (cq. The National Police Law and others), and citizens using the means of transportation as their custom. These laws and regulations are seen in the "expectation and performance patterns" (expectation and performance), which contains the hope that citizens, as legal codes, can implement them at a practical level as a means of fulfilling their obligations. Even though normatively these functions and roles have been "punished" in the statutory regulations, this does not mean that since then the roles and functions of the powerful unit have been completed.

The implementation of the functions and roles of the *dikyasa* unit is a sub system of the traffic law enforcement system. It contains elements as subsystems, namely (1) substance, (2) structure and (3) culture. The substance

relates to its normative aspects, namely positive law which regulates the structure, function and role of the unit in power. Satjipto Rahardjo<sup>12</sup> states that the enactment of law as a process involves various elements, namely (1) the regulations themselves, (2) the citizens as the customary rules, (3) the activities of the implementing bureaucracy and (4) the socio-political-economic-cultural framework exist and participate determine how each element in the law carries out what is part of it. In this research, these elements are seen in a dynamic interaction process, for example the relationship between laws and regulations (cq. The National Police Law, etc.) and the customs, namely citizens using transportation, the laws and regulations can be seen in the "pattern of expectations and implementation". Normatively, these functions and roles have been "punished", but that does not mean that since then the roles and functions of the unit have been resolved.

The implementation of the functions and roles of the *dikyasa* unit is essentially a manifestation of legal ideas, or legal objectives become reality. The implementation of the functions and roles of the *dikyasa* unit is part of law enforcement. Referring to Chambliss & Seidman, in analyzing the function and role of the unit *dikyasa*, it begins with analyzing the process of the operation of law in society<sup>5</sup>. This process is determined by the operation of the whole complex of social and personal forces of the role holder<sup>13</sup>. This means that the effectiveness of legislation is influenced by several factors, namely legal/statutory factors, law enforcement, facilities or facilities, society, and culture<sup>11</sup>. These factors are closely related, because they are the essence or measure of the effectiveness of law enforcement.

## Conclusion

Within the scope of the organization, the Semarang Police has a *Dikyasa* Traffic Unit as an element of implementing the main tasks that is under the invisible, tasked with fostering community participation and traffic education. In carrying out its duties, the *Dikyasa* unit carries out the function of carrying out community participation fostering through cross-sectorial cooperation, carrying out public education in the field of traffic, carrying out studies and engineering of traffic problems, carrying out coaching and counseling to students, communities, driving schools, and groups, implementing coordination with related agencies regarding cross-sectorial cooperation on traffic problems and innovation in the traffic sector. The unit *dikyasa*,

led by Kanit Dikyasa and in carrying out its duties is responsible to the visible and then under the control. The function and role of the unit is arguably part of law enforcement. The social and personal factors that dominate each other in the implementation of the functions and roles of the powerful unit in preventing traffic violations and accidents, the process of law operation in society, are determined by the operation of the whole complex of social and personal power of the role holders.

**Ethical Clearance:** This research was ethically approved by Faculty of Law, Universitas Diponegoro, Semarang, Indonesia

**Funding:** This research receives funding from Faculty of Law, Universitas Diponegoro, Semarang, Indonesia.

**Conflict of Interests:** There are no conflict of interests

### References

- [1. Irianto S. Memperkenalkan Kajian Sosio-Legal dan Implikasi Metodologisnya. dalam Sulistyowati Irianto dkk. Kajian Sosio-Legal. Denpasar: Pustaka Larasan. 2012.
2. Moleong LJ. Metodologi penelitian kualitatif.
3. Corbin JM. Basics of qualitative research: Grounded theory procedures and techniques. Sage; 1990.
4. Basrowi S. Memahami penelitian kualitatif. Jakarta: Rineka Cipta. 2008:128-215.
5. Chambliss WJ, Seidman RB. Law, order, and power. Reading, MA: Addison-Wesley; 1971.
6. Soekanto S. Kegunaan sosiologi hukum bagi kalangan umum. Citra Aditya Bakti; 1992.
7. Soekanto S. Mengenal sosiologi hukum. Alumni; 1979.
8. Atmasasmita R. Teori hukum integratif: rekonstruksi terhadap teori hukum pembangunan dan teori hukum progresif. Genta Publishing; 2012.
9. Rahardjo S. Legal studies. Publisher Alumni, Moulds II, Bandung. 1986.
10. Rahardjo S. Hukum Dalam Perspektif Sosial. Bandung: Alumni. 1981.
11. Soekanto S, Mamudji S. Penelitian Hukum Normatif Suatu Tinjauan Singkat, cet. 16. Rajawali Pers, Jakarta. 2014.
12. Rahardjo S. Aneka Persoalan Hukum dan Masyarakat. Alumni; 1977.
13. Rahardjo S. Masalah penegakan hukum: suatu tinjauan sosiologis. Sinar Baru; 1980.

# Knowledge and Practice of Pregnant Iraqi Women about COVID-19 Preventive Measures

Thikra N. Abdulla<sup>1</sup>, Weqar Akram<sup>2</sup>, Taghreed MardanAbullah<sup>3</sup>

<sup>1</sup>Ass. Pro. Department of Obs. & Gyn., Al-Kindy College of Medicine, Baghdad University, <sup>2</sup>Lecturer, Department of Obs. & Gyn., Al-Kindy College of Medicine, Baghdad University, <sup>3</sup>Specialist Obstetrics & Gyn., Abugraib General Hospital

## Abstract

**Background:** Pregnant women with SARS-CoV-2 infection must be identified and treated early because they are a group susceptible to higher risk as more cases of infection appear, the timely diagnosis will allow us to select which patients merit maternal surveillance. Much closer fetal and/or timely hospital admission with an immediate impact on emergency clinical practice

**Objective:** To assess the knowledge and practice of pregnant Iraqi women about COVID-19 preventive measures.

**Patients and Method:** A cross sectional study conducted at the Private clinics for Gynecology and Obstetrics in Baghdad/Iraq for two months, from 1 of May 2020 to the end of Jun 2020. The study sample is 400 pregnant women that are attending private clinics for antenatal care, studying their knowledge about COVID-19 infection and their approach.

**Results:** The Knowledge score level were found Inadequate in (72%) of the participant and adequate in (28%), the main source of information about the COVID-19 prevention in multiple answers question was TV, which presented in 338 (84.5%), then 234 (58.5%) from family and friends, 229 (57.25%) and 103 (25.75%) mentioned that their information from HCWs. 2/3<sup>rd</sup> of the participants were presented with poor practice (67.25%) while less than 1/3<sup>rd</sup> (32.75%) with good practice.

**Conclusion:** Knowledge score level were found Inadequate in (72%) of the participant and 2/3<sup>rd</sup> of the participants were presented with poor practice (67.25%) while less than 1/3<sup>rd</sup> (32.75%) with good practice.

**Keyword:** COVID-19, Knowledge, Practice, Pregnant, prevention, infection.

## Introduction

On December 2019, an outbreak of a respiratory syndrome was emerged in Wuhan in China that alerted severe acute disease (SARS) caused by a new Coronavirus (SARS-CoV-2), on March 2020, the WHO

declared the disease as pandemic, To date, SARS-CoV-2 infected millions of peoples and causing several thousands of death and it still progressing in many countries.<sup>(1)</sup>

The risk factors that are associated with both SARSas higher mortality are age over 65 years, obesity, diabetes, hypertension, The hypothesis related to these comorbidities is the over expression of ACE 2 receptors, which could facilitate the entry of the virus into the pneumocyte, where it would replicate exponentially and attract to leukocytes and macrophages that would produce pro-inflammatory cytokines that would give rise to SARS. So far, the evidence is inconclusive as

---

### Corresponding Author:

**Dr. Thikra Najim Abdulla**

Ass. Pro. Department of Obs. & Gyn., Al-Kindy College of Medicine, Baghdad University  
e-mail: drthikra@yahoo.com  
Contact Number: +9647901429658

to whether pregnancy confers greater susceptibility to serious complications and vertical transmission of mother-fetus.<sup>(2)</sup> However, the data are very limited by the low incidence of the disease, so only in 32 cases of pregnant women with SARS-CoV-2, 7 (22%) were asymptomatic, 2(6%) were admitted to the intensive care unit, 15(47%) developed preterm delivery, 1(3%) developed stillbirth, and there was a neonatal death.<sup>(3)</sup>

The infection by the new Coronavirus SARS-CoV-2, is an unprecedented pandemic and therefore a public health emergency, highly contagious and producing severe acute respiratory syndrome (SARS). The incubation period is 3-7 days, but can vary between 1-14 days.<sup>(4)</sup> Fever is the most frequent symptom contributed for 88.7%, followed by cough in 67.8% of cases, myalgia, sputum dyspnea, sore throat, headache, and diarrhea in a rate ranged 3.8% to 38.1%, Complications such as pneumonia with infiltrates bilateral, syndrome of distress respiratory acute, arrhythmia, acute kidney injury, cardiac abnormalities and liver damage are common in symptomatic patients with comorbidities.<sup>(5)</sup>

The transmission of diseases is primarily, by direct person-to-person contact transmission between infected and non-infected individuals.<sup>(6)</sup>

Pregnant women do not appear to be more susceptible to contracting the infection, nor to presenting serious complications, but the existing data are limited.

In any case, pregnant women with SARS-CoV-2 infection must be identified and treated early because they are a group susceptible to higher risk as more cases of infection appear, the timely diagnosis will allow us to select which patients merit maternal surveillance -Much closer fetal and/or timely hospital admission with an immediate impact on emergency clinical practice.<sup>(7)</sup>

There is little evidence about the possibility of mother-fetus transmission. As the pregnant patient is classified as a vulnerable group there is no solid evidence of a higher risk of infection or complications, all patients suspected having SARS-CoV-2 infection should be referred to a COVID referral unit to perform aSARS-CoV-2 diagnostic molecular test. Timely referral of all pregnant patients suspected of SARS-CoV-2 infection to specialized COVID units with obstetric care are recommended.<sup>(8)</sup>

On the other hand, infected pregnant women with decreased fetal movements, vaginal bleeding, severe

headache that does not go away with pain reliever, tinnitus, rupture of membranes, sudden and significant edema of the lower extremities with high suspicious symptoms or a serious symptom, it is required to transfer by ambulance to the nearest COVID referral center.<sup>(9)</sup>

The patient must wear a surgical mask at all times and must be sent to the special isolation zone established for each hospital unit. Avoid entrance of the companion who must wait outside the building or in the waiting room. The most important thing is to assess whether the patient has serious features that require an early intervention. For this reason, the first thing to do is to assess whether the patient is serious or not and then assess for the diagnosis of COVID-19 infection.<sup>(10)</sup>

Treatment of COVID-19 during pregnancy still under debate; there are more than 49 randomized clinical trials in the world in search of a cure for SARS-CoV-2 infection. However, of the proposed treatments, their safety, effectiveness, dose, stage of disease to be administered, and safety during pregnancy are still unclear. Treatments such as Hydroxychloroquine are safe in pregnancy and appear to be promising, however, information on its efficacy and safety, as well as its dose and stage of disease to which it should be administered comes from non-randomized studies and not blind.<sup>(11)</sup> Every pregnant woman should go for obstetric reassessment in a specialized referral hospital. Fetal viability in all trimesters and fetal weight will be added by percentile calculation of weight for gestational age and Doppler (in cases less than 10th percentile of weight) in third trimester.<sup>(12)</sup>

There is evidence that post-infection patients remain positive for SARSCoV-2 infection for 7 days after the resolution of the clinical picture.

Patients with a negative test should rule out influenza or other infectious pathologies. These patients should be managed according to their symptoms or obstetric pathology of preference in hospitalization area outside of isolation and out of risk of infection with COVID-19.<sup>(13)</sup>

Clinically, pregnant women during her hospital stay must be kept in isolation. It is not contemplated accompaniment by family. The patient should be monitored for pulse-oximetry and vital-signs regularly at least 4 times a day and fetal heart rate monitoring 1 time a day. Terminating a pregnancy in a patient with SARS-CoV-2, in stable patients there is no indication to interrupt the pregnancy. Whenever possible. The decision



to terminate the pregnancy in stable patients will be done under multidisciplinary consensus due to unfavorable evolution according to maternal deterioration.<sup>(14)</sup>

Maternal and fetal well-being should be monitored. In the case of fetal surveillance, conducting continuous electronic monitoring of fetal heart rate for 20 minutes, can help us identify changes in fetal physiology reflected in normal patterns and abnormal of it.<sup>(15)</sup> Postnatally, it is unknown if infection with SARS-COV2 can be pass through breast milk and there is a little evidence about SARS-CoV in mother’s milk. Recent studies documented negative evidence about the transmission through breast milk and all samples were reported negative. Currently experience is limited and it is a subject under investigation.<sup>(16)</sup>

**Aim of the Study:** To assess the knowledge and practice of pregnant Iraqi women about COVID-19 preventive measures.

**Patients and Method**

A cross sectional study conducted at the Private clinics for Gynecology and Obstetrics in Baghdad/Iraq for two months, from 1 of May 2020 to the end of Jun 2020. The study sample is 400 pregnant women that are attending private clinics for antenatal care, studying their knowledge about COVID-19 infection and their approach.

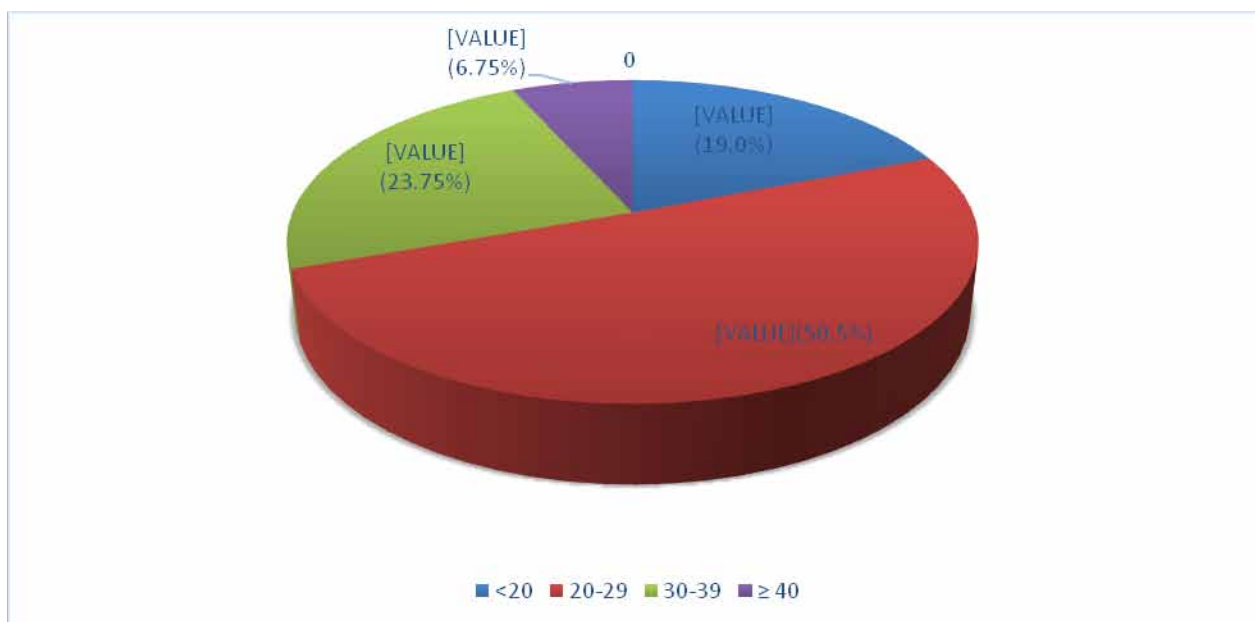
A detailed questioner from each patient after taking her consent verbally for participation, it should include the following: patient educational state and residence and home conditions.

The questionnaire included: information about the virus, did she hear about it, form where she heard,, does she believe about it, is the virus the same to common flu, what causes this disease, transmission mode and duration of symptoms since transmission, how patient suspect infection, how serious she thinks the disease, could it be asymptomatic, who can get the disease, does she think that pregnant women are liable to get it more than general population, does she think it is more severe during pregnancy, how does it spread, what can kill the virus, what are the protective personal approaches, does she believe and practice the following: social distance, hand washing, wearing mask, not contact with suspected or sick people, isolation if suspected, cleaning surfaces, using antiseptics, consult a doctor if suspect symptoms.

**Statistical Analysis:** A pretested and validated questionnaire was used to collect the data. Data analysis was done using SPSS version 23

**Results**

As shown in figure 1 the main age group were between (20-29) years old as (50.5%) of the participants were found in this group, (23.75%) was in age group (30-39). 19% in <20 years and (6.75%) in ≥40 years.



**Fig 1: Age distribution of the studied group**

Table 1 show that the Knowledge score level were found Inadequate in (72%) of the participant and adequate in (28%)

**Table 1: Knowledge score level**

Variable		N	%
Participants' knowledge level about COVID-19	Inadequate	288	72.0
	Adequate	112	28.0
<b>Total</b>		<b>400</b>	<b>100.0</b>

The main source of information about the COVID-19 prevention in multiple answers question was social media, which presented in 338 (84.5%), then 234 (58.5%) from family and friends, TV in 229 (57.25%)

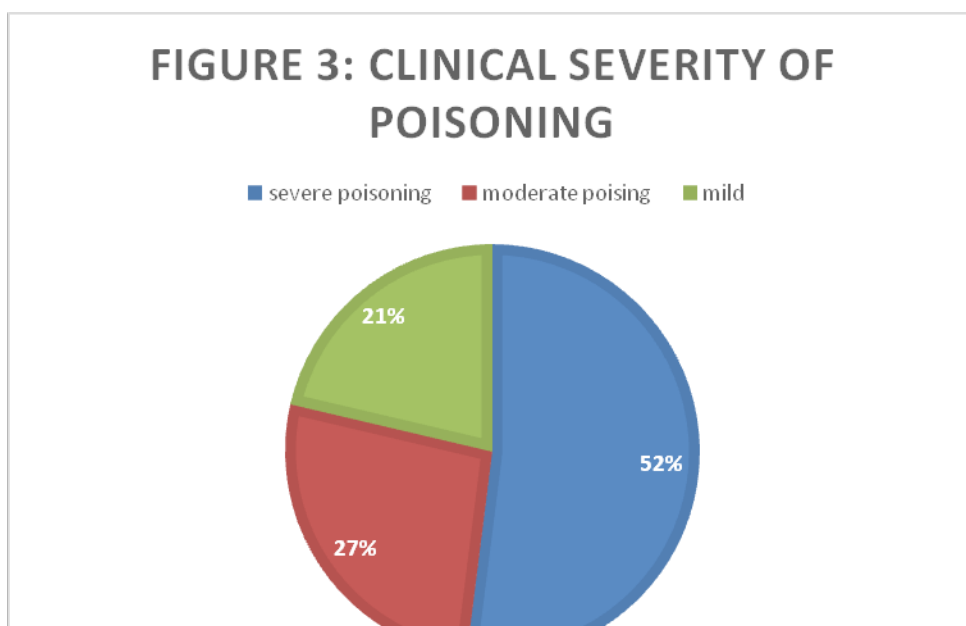
and 103 (25.75%) mentioned that their information from HCWs (table 2).

**Table 2: Sources of their information**

Source of information*	No	%
Social media	338	84.5
Family and Friends	234	58.5
TV	229	57.25
HCWs	103	25.75

\*Multiple Responses

384 (96%) of the pregnant women heard about corona virus at the time of the study while 16(4%) don't heard about it (fig 2).



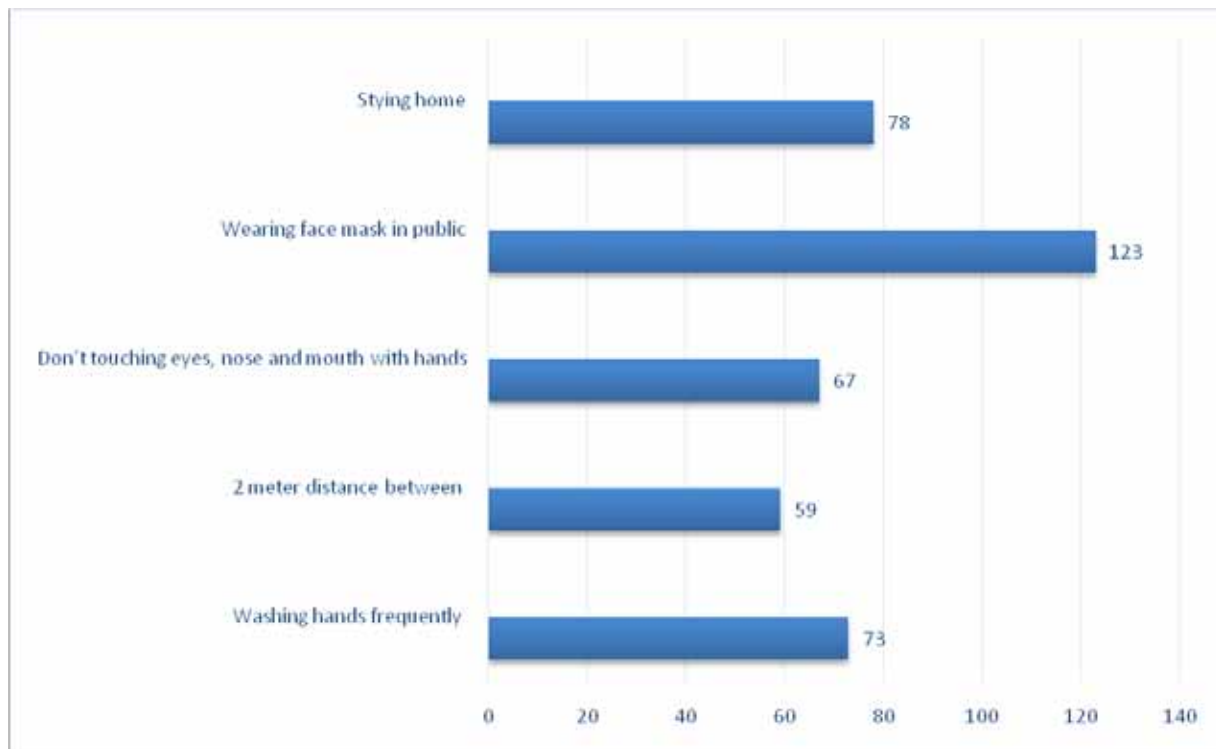
**Fig 2: Heard about Novel coronavirus**

Table 3, mentioned that about 2/3<sup>rd</sup> of the participants were presented with poor practice (67.25%) while less than 1/3<sup>rd</sup> (32.75%) with good practice

**Table 3: Practice level about prevention of COVID-19 infection**

Variable		N.	%
Participants' practice level about prevention of COVID-19	Poor	269	67.25
	Good	131	32.75
<b>Total</b>		<b>400</b>	<b>100.0</b>

For the participant practice response for preventing COVID-19 show that 73 (18.25.0%) choose the washing hands frequently as major preventive way, 59 (14.75%) said that a distance for 2 meters and more between the people can prevent the infection with disease. 67 (16.75%) choose do not touch eye, nose and mouth with hands, 123 (30.75%) choose wearing mask was the common way to prevent the infection, and 78 (19.5%) mentioned staying home was the way to prevent infection with the disease (fig 3).



**Fig 3: Response of participants among practice of preventing COVID-19**

### Discussion

The current study provide a shed light about the level of knowledge and practice among preventive measurement of COVID-19 infection in pregnant Iraqi women. The current study show that the level of knowledge were inadequate in about 3/4<sup>th</sup> of the participants, which is not in agreement with Nawafor J et al, <sup>(17)</sup> study carried in Nigeria, revealed that (60.9 %) of the pregnant women were presented with adequate knowledge. This may be due to their people trusted to the news when heard from their government that is opposite to our peoples.

The main source of information of the participants in the present study about the COVID-19 prevention in multiple answers question was TV, then family and friends, lastly was from HCWs. Which is in agreement with Bekele D et al,<sup>(18)</sup> study when they revealed that social media were the main source of information for the participants, then TV. Moreover, Olapegba et al., found that media was the main source of their information. <sup>(19)</sup>

The majorities of the respondents were heard about the COVID-19 at the time of the study, this is more than that found in a study carried by Ikhaq A et al, in Pakistan

found 90% of the respondents were heard about the disease. <sup>(19)</sup> GeoPoll et al in their survey carried on three African countries revealed that more than (94%) of the participants were heard about the COVID-19. <sup>(20)</sup>

In the present study participant said that the most common way to prevent the infection were by do not touch eye, nose and mouth with hands (30.75%), then (19.5%) mentioned staying home. This is not in agreement with Azlan A et al, study carried in Malaysia when found that proper washing hand is the common way to prevent infection with COVID-19 then avoiding crowded area. And the least common was those choosing wearing of face mask. <sup>(21)</sup> Poor practice were common in the present study while Al-Hanawi M et al in their study done in Saudi Arabia revealed good practice score with good knowledge score in the studied group. <sup>(22)</sup>

### Conclusion

Knowledge score level were found Inadequate in (72%) of the participant and 2/3<sup>rd</sup> of the participants were presented with poor practice (67.25%) while less than 1/3<sup>rd</sup> (32.75%) with good practice.

**No conflicts of interest**

**Source of Funding:** Self

**Ethical Clearance:** Was taken from the scientific committee of the Iraqi Ministry of health

**References**

1. Huang C, Wang Y, Li X, Ren L, Zhao J, Hu Y, Zhang L, Fan G, Xu J, Gu X, Cheng Z. Clinical features of patients infected with 2019 novel coronavirus in Wuhan, China. *The lancet*. 2020 Feb 15;395(10223):497-506.
2. Rebello CJ, Kirwan JP, Greenway FL. Obesity, the most common comorbidity in SARS-CoV-2: is leptin the link?. *International Journal of Obesity*. 2020 Jul 9:1-8.
3. Yan J, Guo J, Fan C, Juan J, Yu X, Li J, et al. Coronavirus disease 2019 (COVID-19) in pregnant women: A report based on 116 cases. *American journal of obstetrics and gynecology*. 2020 Apr 23.
4. Franjić S. COVID-19 in Croatia. *Asploro Journal of Biomedical and Clinical Case Reports*. 2020;3(2):106.
5. El-Baz LM, Elwakeel KZ, Elgarahy AM. COVID-19 from mysterious enemy to an environmental detection process: a critical review. *Innovative Infrastructure Solutions*. 2020 Dec; 5(3):1-3.
6. Al-Balas M, Al-Balas HI, Al-Balas H. Surgery during the COVID-19 pandemic: a comprehensive overview and perioperative care. *The American Journal of Surgery*. 2020 Jun 1; 219(6):903-6.
7. Ellington S, Strid P, Tong VT, Woodworth K, Galang RR, Zambrano LD, et al. Characteristics of women of reproductive age with laboratory-confirmed SARS-CoV-2 infection by pregnancy status—United States, January 22–June 7, 2020. *Morbidity and Mortality Weekly Report*. 2020 Jun 26; 69(25):769.
8. Karimi-Zarchi M, Neamatzadeh H, Dastgheib SA, Abbasi H, Mirjalili SR, Behforouz A, et al. Vertical transmission of coronavirus disease 19 (COVID-19) from infected pregnant mothers to neonates: a review. *Fetal and pediatric pathology*. 2020 Apr 1:1-5.
9. Al-kuraishy HM, Al-Maiah TJ, Al-Gareeb AI, Musa RA, Ali ZH. COVID-19 pneumonia in an Iraqi pregnant woman with preterm delivery. *Asian Pacific Journal of Reproduction*. 2020 May 1;9(3):156.
10. Desborough J, Hall SL, de Toca L, Davis S, Roberts L, Kelaher C, Kidd M. Australia's national COVID-19 primary care response. *Med J Aust*. 2020 Apr 29;1.
11. Favilli A, MatteiGentili M, Raspa F, Giardina I, Parazzini F, Vitagliano A, et al. Effectiveness and safety of available treatments for COVID-19 during pregnancy: a critical review. *The Journal of Maternal-Fetal & Neonatal Medicine*. 2020 Jun 5:1-4.
12. NOVAC MV, Iliescu DG, TUDORACHE S, MANOLEA M, MEETESCU RE, VRABIE S, Novac MB, Alexandru DO, DIJMARESCU L. Ultrasound Evaluation of Fetal Biometry and Doppler Parameters in the Third Trimester of Pregnancy Suspected of Intrauterine Growth Restriction. *Current Health Sciences Journal*. 2018 Jan;44(1):23.
13. Centers for Disease Control and Prevention. interim clinical guidance for management of patients with confirmed 2019 novel coronavirus (2019-nCoV) Infection. Updated February. 2020;12.
14. Wu YT, Li C, Zhang CJ, Huang HF. Is termination of early pregnancy indicated in women with COVID-19?. *European Journal of Obstetrics and Gynecology and Reproductive Biology*. 2020 May 20.
15. Marim F, Karadogan D, Eyuboglu TS, Emiralioglu N, Gurkan CG, Toreyin ZN, et al. Lessons Learned so Far from the Pandemic: A Review on Pregnants and Neonates with COVID-19. *The Eurasian Journal of Medicine*. 2020 Jun;52(2):202.
16. Lackey KA, Pace RM, Williams JE, Bode L, Donovan SM, Järvinen KM, et al. SARS-CoV-2 and human milk: What is the evidence?. *Maternal & Child Nutrition*. 2020 Apr 11:e13032.
17. Nwafor JI, Aniukwu JK, Anozie BO, Ikeotuonye AC. Knowledge and practice of preventive measures against COVID-19 infection among pregnant women in a low-resource African setting. *medRxiv*. 2020 Jan 1.
18. Bekele D, Tolossa T, Tsegaye R, Teshome W. The knowledge and practice towards COVID-19 pandemic prevention among residents of Ethiopia. An online cross-sectional study. *BioRxiv*. 2020 Jan 1.
19. Ikhlaq A, Hunniya BE, Riaz IB, Ijaz F. Awareness

- and Attitude of Undergraduate Medical Students towards 2019-novel Corona virus. *Pakistan Journal of Medical Sciences*. 2020 May;36(COVID19-S4):S32.
20. GeoPoll. A study of the knowledge and perceptions of coronavirus (COVID-19) in South Africa, Kenya, and Nigeria. 2020. Available at: <https://reliefweb.int/report/world/coronavirus-africa-study-knowledge-and-perceptions-coronavirus-covid-19-south-africa>. Accessed on 23/8/2020
  21. Azlan AA, Hamzah MR, Sern TJ, Ayub SH, Mohamad E. Public knowledge, attitudes and practices towards COVID-19: A cross-sectional study in Malaysia. *Plos one*. 2020 May 21;15(5):e0233668.
  22. Al-Hanawi MK, Angawi K, Alshareef N, Qattan AM, Helmy HZ, Abudawood Y, et al. Knowledge, Attitude and Practice Toward COVID-19 Among the Public in the Kingdom of Saudi Arabia: A Cross-Sectional Study. *Frontiers in Public Health*. 2020;8.

# The Study Effects of *Quercus infectoria* on the Oral Environment in Gingivitis Patients

Ali Hasanain Alhamadani<sup>1</sup>, Rana Talib Al-Muswie<sup>2</sup>, Sameerah Jameel Tarfa<sup>2</sup>

<sup>1</sup>Lecturer, Instructor at Nursing College/Al-Muthanna University. Iraq,

<sup>2</sup>Lecturer. Instructor at Dentistry College/Thi\_Qar University. Iraq

## Abstract

Gingivitis is an inflammatory response of the gingival tissues to the metabolic products and pathogenic toxins of bacteria found in oral gingiva. Clinical indicators are redness, edema and swelling of the local gingival tissue.

Study comprised of 35 participants of age between 25-45 years who were clinically examined and divided into three group gingivitis of female, gingivitis of male and healthy control, These were classified according to the values of gingival index score.

*Q. infectoria* were applied topically to participants were suffering from gingivitis, In addition Strips of pH indicator paper were also used to diagnose the effect of *Q. infectoria* on the pH of the oral pathophysiology. Diagnoses and follow-up product were performed in a dental clinic under the supervision of a dentist by used gingival index for two weeks.

The progress of gingival measured in female group in terms of mean, standard deviation and variance were 0.7,0.135 and 0.018 before treatment while 0.3, 0.125 and 0.015 after treatment however for male group were 0.678, 0.189 and 0.03 before treatment while 0.291, 0.132 and 0.01 after treatment.

We observed the great efficacy of the herb product against gingivitis In addition, Significant changes in the PH of the mouth were also observed after using *Q. infectoria*, as it was found that PH value is close to neutral and within the normal range for all patients.

According to results were due to the fact that *Q. infectoria* contain large amounts of tannin and other compounds that constrict vessels and tissues and are effective as an anti-inflammatory for retention of gum tissue there for we recommend used for treatment.

**Keyword:** *Gingivitis, Oral pathophysiology, Q. infectoria, Saliva, anti-inflammatory*

## Introduction

Oral mucosa essentially goes about as a barrier against the external harmful environments. Loss of its barrier function due to diseases or injury will cause significant dysfunction within the oral cavity<sup>1</sup>.

The oral mucosa is the soft tissue covering of the oral hole, including the buccal mucosa and the gingivae . It has a wide range of different functions and consists of a distinct layered structure that is similar to the structure and function of skin<sup>2</sup>.

Mechanical stress is continuously placed on the oral environment by activities and lead to sudden changes in temperature and pH meaning it must have the option to adjust to change rapidly . Because of these unique physiological features<sup>3</sup>, One of the main functions of the oral mucosa is to physically protect the underlying tissues from the mechanical forces, organisms and toxins in the mouth<sup>4</sup> . Keratinised mucosa is tightly bind to the hard palate and gingivae. It represents 25% of all oral mucosa. It supports underlying tissues by resisting the loading forces exerted during mastication<sup>5</sup>.

Due to its area at the passage of the stomach related and respiratory lots and its closeness to the teeth, the oral mucosa is exposed to various normal and man-made xenobiotics<sup>6</sup>. The peculiar architecture and absorption characteristics of the oral mucosa, particularly in areas of extreme thinness, coupled with the rich microorganism flora of the mouth, makes the oral mucosa exposed to many change in physiology tissue<sup>7</sup>.

Gum disease is the most widely recognized type of oral infection,, is characterized by inflammation of the soft tissue without evident clinical attachment loss. Studies on gingivitis have been conducted in many parts of the world with people of different ethnic and cultural backgrounds<sup>8</sup>.

The more extended that plaque and tartar remain on your teeth, the more they irritate the gingiva, the part of your gum around the base of your teeth, causing inflammation. In time, your gums become swollen and bleed easily. Tooth decay additionally may result. If not treated, gingivitis can advance to periodontitis and possible tooth loss<sup>9</sup>.

Within this pH scale of alkalinity and acidity, healthy saliva should generally be slightly acidic and fall between a 5.6 and a 7.9 when saliva exceeds or falls below this range, numerous health complications can occur. Consider that the body is mostly involved of water, which is a neutral substance. If the body drops too far out of the semi-neutral zone, which is approximately a pH level of 7.4, the whole chemical balance shifts and this is where problems can create.<sup>10</sup>

In the event that salvia is excessively acidic, which means it drops below 7.0 at that point it causes an oxygen-denied condition that expands the hazard for tooth demineralization, cavities and tooth decay. This risk increases because bacteria thrive in this type of environment. It is also important to note that foods containing sucrose, glucose, lactose, and starches provide food for the bacteria, allowing them to survive and reproduce<sup>11</sup>

Medicinal plants produce biologically active compounds and this is common in most compounds extracted from plants. *Q. infectoria* is one of the most widely used traditional medicines in Asia found in Cyprus, Syria, Turkey and Greece<sup>12</sup>.

*Q. infectoria* is a small tree with a height of about 2 meters The main constituents of the galls are gallic

acid (2–4%), Gallo tannic acid (50–70%), ellagic acid, starch, and sugar Galls in traditional Indian medicine it was used as a toothpaste to treat gum disease and oral cavity<sup>13</sup>. It has also been used to treat internal bleeding, gonorrhea, tonsillitis and menstruation. It also possesses antibacterial, antiviral, pesticidal, fungal, and anti-inflammatory properties.

*Q. infectoria* is determined as a natural caustic which has antibacterial and antioxidants properties as well as containing several important bioactive compounds such as tannic acid, flavonoids, gallic acid, ellagic acid and others<sup>14</sup>. All of these bioactive constituents are scientifically demonstrated to give many benefits to human kind, particularly as far as pharmacological studies. Hence, due to this reason, a series of research has been conducted to recognize its beneficial effects in pharmaceuticals area<sup>15</sup>.

It has been used since ancient time to treat the inflammatory disease in oriental traditional medications. Additionally, pharmacology tests have demonstrated that the galls of *Q. infectoria* possess astringent, antitremorine, local anesthetic, antiviral, antibacterial and larvicidal<sup>15</sup>.

The aim of this study is to observe the physiological changes and pH of gingivitis patient by using the properties of *Quercus infectoria* that was used as a topical powder. And Can it be used as an alternative treatment instead of chemical drugs

## Materials and Method

**Sample Characteristic:** Thirty-five case (20 female and 15 male) examinations were performed by single dentist, who were calibrated to the exact procedures for disease diagnosis,

Clinical examination was performed by using periodontal probe and glass of mouth to obtain gingival index (Loe and Silness, 1963) and then analyzed data to see physiological change after using product.

The mean gingival index was used for the assessment of severity of gingival inflammation in the study sample. Slight gingivitis was defined as gingival index 0.1-1, moderate gingivitis as gingival index 1.1-2.0, and severe gingivitis as gingival index 2.1-3.0.

The effect of *Q. infectoria* on the pH of gingivitis has been diagnoses by used Strips of pH Indicator. saliva was collected for all participants, 5 ml were collected

from each one, and pH values were measured before and after using the product.

**Plant Materials:**

- The galls of *Q. infectoria* were purchased from the market and used as plant materials for this study
- The product was crushed to small pieces using a sterile pestle and mortar and powdered in an electric grinder.
- The powder was put in plastic containers .
- Patients were diagnosed by a specialist dentist and the cans were then delivered to each of them.
- The topical powder was used by the patient twice a day, in the morning and before bedtime.
- The patients were reviewed at the doctor’s clinic after two weeks of using the products and the results were recorded by a personal physician.
- The LD50 was determined using the classical LD50 method of Behrens and Karbers (1953). No side effects have been reported for using this product in the various studies that have worked.

**Result**

This is clinical study that showed the effect of galls of *Q. infectoria* extracts on people who have gingivitis . Thirty-five people participated in this study. Participants separated for three group G1,20 Female (Table1), G2,10 male (Table2) and G3,5 person as control. all of patient had Physiological problems in the gum tissue like dusky red, swollen, tender gums that bleed easily, especially when you brush your teeth.

The results were observed after using equal quantities of galls of *Q. infectoria* .It showed a significant (p<0.05) improvement in the decrease and regression of the inflamed oral tissues for both group.

The progress of gingivitis in group one before and after treatment were 0.7, 0.135, 0.018 and 0.3, 0.125, 0.015 for mean, standard deviation and variance respectively (Figure 1), while progress of gingivitis in group two before and after treatment were 0.678, 0.189,0.03 and 0.291, 0.132, 0.01 for mean, standard deviation and variance respectively (Figure 2).

On the other hand, the salivary pH in gingivitis was more acidic than the control group, pH is maintained near neutrality (6.7-7.3) by saliva In control group while

gingivitis was (5.8 -6.8). the Result showed the average pH was 7.24 ± 0.10 after two weeks of using the product. This implies that the physiology of processes taking place within oral tissue is wide ranging and complex. Different levels of pH indicate different chemical environments which may imply that different disease.

**Table 1. Comparison of group of female gingivitis before and after treatment with *Q. infectoria***

No	Age	Before	NO	After
1	20	0.9	1	0.5
2	21	0.7	2	0.3
3	24	0.6	3	0.2
4	25	0.7	4	0.2
5	25	0.8	5	0.4
6	27	1	6	0.3
7	28	0.9	7	0.3
8	29	0.8	8	0.2
9	29	0.7	9	0.2
10	31	0.6	10	0.3
11	32	0.9	11	0.3
12	33	0.9	12	0.1
13	33	0.6	13	0.5
14	34	0.7	14	0.2
15	36	0.5	15	0.2
16	36	0.7	16	0.3
17	40	0.8	17	0.3
18	42	0.9	18	0.6
19	44	0.8	19	0.2
20	45	0.6	20	0.4

**Table 2. Comparison of group of male gingivitis before and after treatment with *Q. infectoria***

No	Age	No	Before	After
1	25	1	0.7	0.26
2	26	2	0.5	0.3
3	28	3	0.69	0.28
4	29	4	0.66	0.5
5	30	5	0.57	0.2
6	32	6	0.29	0.16
7	33	7	0.9	0.5
8	34	8	0.84	0.36
9	44	9	0.73	0.25
10	55	10	0.9	0.1



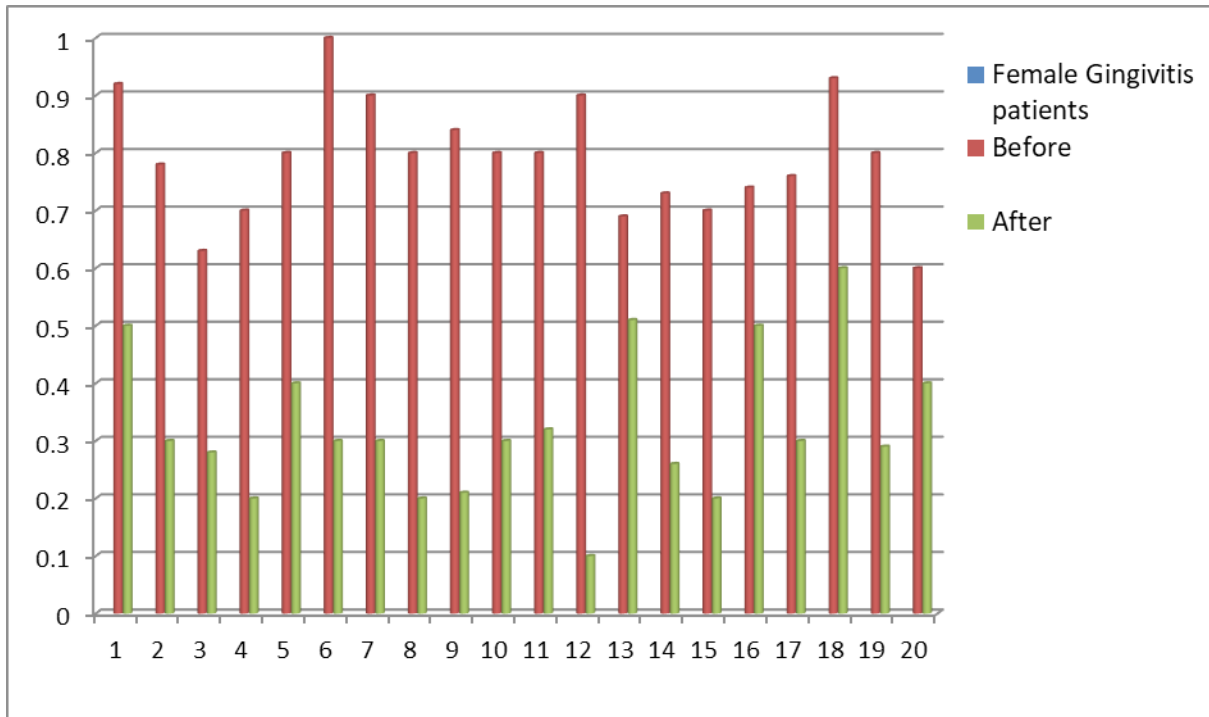


Figure 1. Comparison of group of female gingivitis before and after treatment with *Q. infectoria*

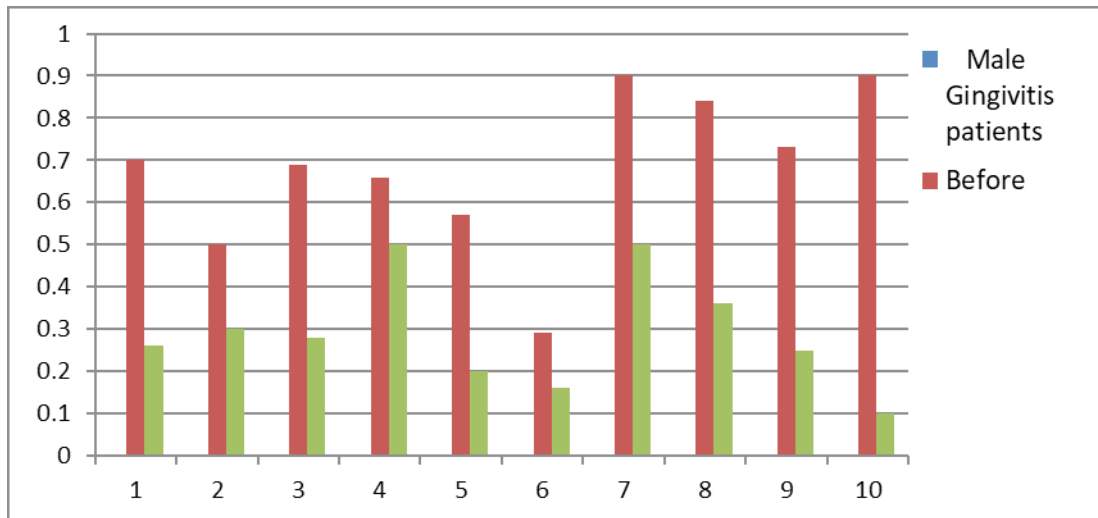


Figure 2. Comparison of group of male gingivitis before and after treatment with *Q. infectoria*

### Discussion

This study has proved the high potential in oral physiology during using of galls of *Q. infectoria*, Pharmacologically the galls are claimed to have various biological activities such as astringent effect, anti-inflammatory and antibacterial.

We show gingivitis patient have various symptom and manifest like moderate glazing, oedema, redness, and hypertrophy; bleeding on sensing but after two

week of used product and According to the diagnosis and continuous careful study of each patient, the results proven high improvement in oral physiology,

Where a significant improvement in healthy gums function was observed, as the color of the gum tissue changed to pale pink while physiologic stippling of gum and tough have a limited sensibility to pain, temperature, and pressure. This improvement in gum tissue is due to *Quercus Infectoria* contain polyphenols which have great reducing power and serve as antioxidant.

An improvement in the oral tissues has also been observed for gingivitis patient suffering from severe inflammation this is due to one of the main reasons that cause gingivitis by infection of bacteria, fungi or viruses which make form plaque that can cling to the teeth which lead to irritate the gums, causing them to become inflamed. The inflamed gums bleed and swell. It is these bleeding and swollen gums that we recognize as gingivitis, Therefore, *Q. infectoria* have a great effect for treating gingivitis, due to their being a good antibacterial and antiviral.

The main constituents found in the galls of *Q. infectoria* are tannin (50-70%) and small amount of free gallic acid and ellagic acid there for possess pleiotropic therapeutic activities, with particular efficacy against inflammatory diseases, Different formulations can be made in form of gels, ointments, mouthwashes and powder to be effectively used for the treatment of gingival diseases.

The resting pH of the oral cavity is between 5 and 9, it is also known to vary widely depending on a number of factors. A change in pH level was seen in severe gingival inflammation.

As the difference in the degree of pH of the mouth depends on the type of food, physiological processes and stress. also various Studies shown growth of microorganisms that effect on PH like *P. gingivalis* grows at a pH of 6.5-7.0, *P. intermedia* grows at a pH of 5.0-7.0 and *F. nucleatum* grows at a pH of 5.5-7.0. 5, 6.

The results showed a significant improvement in the acidity of the mouth and its transformation into neutral, as a result of the use of *Q. infectoria*, which regression and reduced gingivitis and removed the factors that lead to increased acidity in the mouth.

### Conclusion

These results shows a significant change after using herbal product in gingivitis patients, also the salivary pH shows improvement acidity in oral saliva .Therefore, we recommend using this *Q. infectoria* as an alternative treatments instead of drugs, as an improvement in oral and gum function has been observed without any side effect.

**Conflict of Interests:** Nil.

**Ethical Clearance:** Take from density Centre in Al Muthanna University by approval ethical committee.

**Funding:** Self-funding.

### References

1. Izumi K, Kato H, Feinberg SE. Tissue Engineered Oral Mucosa. In: Stem Cell Biology and Tissue Engineering in Dental Sciences. 2015.
2. Papapanou PN, Sanz M, Buduneli N, Dietrich T, Feres M, Fine DH, et al. Periodontitis: Consensus report of workgroup 2 of the 2017 World Workshop on the Classification of Periodontal and Peri-Implant Diseases and Conditions. In: Journal of Clinical Periodontology. 2018.
3. Fatima S, Farooqi AHA, Kumar R, Kumar TRS, Khanuja SPS, Others. Antibacterial activity possessed by medicinal plants used intooth powders. *Antibact Act Possess by Med plants used intooth powders*. 2000;
4. Yang DJ, Moh SH, Son DH, You S, Kinyua AW, Ko CM, et al. Gallic Acid Promotes Wound Healing in Normal and Hyperglucidic Conditions. *Molecules*. 2016;
5. Tonetti MS, Greenwell H, Kornman KS. Staging and grading of periodontitis: Framework and proposal of a new classification and case definition. *J Periodontol*. 2018;
6. Takahashi N. Acid-neutralizing activity during amino acid fermentation by *Porphyromonas gingivalis*, *Prevotella intermedia* and *Fusobacterium nucleatum*. *Oral Microbiol Immunol*. 2003;
7. Gottrup F, Ågren MS, Karlsmark T. Models for use in wound healing research: A survey focusing on in vitro and in vivo adult soft tissue. *Wound Repair and Regeneration*. 2000.
8. Chapple ILC, Mealey BL, Van Dyke TE, Bartold PM, Dommisch H, Eickholz P, et al. Periodontal health and gingival diseases and conditions on an intact and a reduced periodontium: Consensus report of workgroup 1 of the 2017 World Workshop on the Classification of Periodontal and Peri-Implant Diseases and Conditions. In: Journal of Clinical Periodontology. 2018.
9. Haschek WM, Rousseaux CG, Wallig MA. *Fundamentals of Toxicologic Pathology: Second Edition*. Fundamentals of Toxicologic Pathology: Second Edition. 2009.
10. Galgut PN. The relevance of pH to gingivitis and periodontitis. *J Int Acad Periodontol*. 2001;
11. Baliga S, Muglikar S, Kale R. Salivary pH: A

- diagnostic biomarker. *J Indian Soc Periodontol.* 2013;
12. Nagori BP, Solanki R. Role of medicinal plants in wound healing. *Res J Med Plant.* 2011;
  13. Diğrak M, Alma MH, İlçim A, Şen S. Antibacterial and antifungal effects of various commercial plant extracts. *Pharm Biol.* 1999;
  14. Jalalpure SS, Patil MB, Alagawadi KR. Wound healing activity of the galls of *Quercus infectoria* olivier. *J Nat Remedies.* 2002;
  15. Kaur G, Athar M, Alam MS. *Quercus infectoria* galls possess antioxidant activity and abrogates oxidative stress-induced functional alterations in murine macrophages. *Chem Biol Interact.* 2008;

# Relations between Interlukin-6 and Some Biochemical Parameters in Diabetic Foot Syndrome

Raid M.H. Al-Salih<sup>1</sup>, Zeena M. Ali<sup>2</sup>

<sup>1</sup>Prof., <sup>2</sup>Researcher, University of Thi-Qar–College of Science–Department of Chemistry

## Abstract

The aim of this study is to predict the incidence of diabetic foot syndrome in type 2 diabetic patients by measuring some parameters (IL-6, FBS, MDA, CP, BMI). Samples were obtained from (75) type II diabetic patients with and without diabetic complications (diabetic foot and diabetic neuropathy), as well as (25) healthy controls as a control group. They were divided into four groups: Group A (the control group):- It included (25) healthy individuals aged between (35-70 years). Group B (Diabetics type II without complications):- Includes (25) patients, their ages range (35-70 years). Group C (diabetic patients with diabetic neuropathy):- It included (25) patients whose ages ranged from (35-70 years). Group D (diabetic patients with diabetic foot syndrome):- Included (25) patients whose ages ranged from (35-70 years). The results showed a significant increase in the levels of (IL-6, FBS, MDA, CP) in all groups of type II diabetes patients with and without complications compared to the control group ( $P \leq 0.05$ ). There was a significant increase in the parameters measured in the group of diabetic patients with type II diabetic foot syndrome (DF) compared to the group of diabetic patients with type II disease Diabetic neuropathy (DN), and the results also showed a significant increase in group DN compared to group of type II diabetic patients (DM) ( $P \leq 0.05$ ). Our study show Interleukin-6 values, as well as oxidative stress, could predict the future incidence of diabetic foot syndrome.

**Keywords:** *Diabetic foot syndrome, Diabetes mellitus type 2, Diabetic neuropathy, FBG, IL-6, and oxidative stress.*

## Introduction

Diabetes mellitus (DM) describes a group of metabolic disorders characterized by high blood glucose levels. People with diabetes have an increased risk of developing a number of serious life-threatening health problems resulting in higher medical care costs, reduced quality of life, and increased mortality<sup>(1)</sup>. The global diabetes prevalence in 2019 is estimated to be 9.3% (463 million people), rising to 10.2% (578 million) by 2030 and 10.9% (700 million) by 2045. The prevalence is higher in urban (10.8%) than rural (7.2%) areas, and in high-income (10.4%) than low-income countries

(4.0%). One in two (50.1%) people living with diabetes do not know that they have diabetes<sup>(2)</sup>. Chronic Diabetic Complications Microvascular complications include:

Retinopathy, Diabetic Neuropathy, Diabetic Nephropathy, Diabetic foot<sup>(3)</sup>. Between 13% and 26% of diabetics report painful chronic polyneuropathy. About 50% of patients with diabetes mellitus develop symptomatic peripheral neuropathy within 25 years of disease onset.

Sensory neuropathy is the primary cause of more than 60% of diabetic foot ulcers. Diabetic peripheral neuropathy is a microvascular complication of diabetes mellitus and in type 2 diabetes, not only hyperglycemia but also other metabolic alterations and persistent inflammatory status due to adiposity play a major role in axon injury<sup>(4)</sup>. Diabetic foot is one of the most feared complications of diabetes mellitus. Diabetes and its complications as foot ulcers may develop as a result

---

### Corresponding Author:

**Prof. Dr. Raid M.H. Al-Salih**

University of Thi-Qar–College of Science–Department of Chemistry

e-mail: raidstry@gmail.com

of polyneuropathy, ischaemic causes, or as a result of all<sup>(5)</sup>. Hyperglycemia causes tissue injury leading to vascular damage through generation of free radicals and their effect on endothelium in diabetics. oxidative stress plays an important role in the development of Cardio Vascular Diseases (CVD) and diabetes by imbalance of ROS production, and has close relationship with inflammation. It was observed that the lipid peroxidation are increased in patients with MS and it is directly related with the development of atherosclerosis together with establishment of pro-inflammatory state<sup>(6,7)</sup>. Also, diabetes can be regarded as a pro-oxidant state caused by increased lipid oxidation<sup>(8)</sup>. Hyperglycemia generates reactive oxygen species (ROS), which in turn cause damage to the cells in many ways. Damage to the cells ultimately results in secondary complications in diabetes mellitus<sup>(9)</sup>.

Oxidative stress induced by reactive oxygen species (ROS), which results from hyperglycemia measured with (FBG), which are the first parameters that give the indication of diabetes<sup>(10)</sup>. Diabetes is characterized by hyperglycemia along with biochemical changes to glucose and lipid peroxidation. Several studies have evaluated free radical and antioxidant-induced lipid oxidation in diabetics<sup>(11,12)</sup>. Some complications of diabetes are associated with increased free radical-induced lipid peroxidation activity and accumulation of lipid peroxidation products<sup>(13)</sup>. Abnormally high levels of oxidation and a simultaneous decrease in antioxidant defense mechanisms can damage cellular organelles and lead to oxidative stress<sup>(14)</sup>. Under normal physiological conditions, there is a critical balance in the generation of oxygen free radicals and the antioxidant defense systems that organisms use to deactivate and protect themselves against free radical toxicity<sup>(15)</sup>. An imbalance of oxidative/antioxidant balance creates a condition known as oxidative stress. It is well known that oxidative stress is a component of molecular and cellular tissue damage mechanisms in a broad spectrum of human diseases<sup>(16)</sup>. Interleukin-6 (IL-6), a major cytokine mediator of the acute-phase response, which stimulates acute-phase protein production in the liver and has diabetogenic actions. The highest levels of acute-phase markers and IL-6 were found in those patients with most features of the insulin resistance syndrome (metabolic syndrome X: glucose intolerance, hypertriglyceridemia, low levels of serum high-density lipoprotein cholesterol, [central] obesity, accelerated atherosclerosis, and hypertension)<sup>(17)</sup>. Through the review, you present from

such a series situation view we design this study to evaluate the level of Interleukin-6 as an inflammatory agent, and we see the possible relationship between interleukin levels and levels of (FBG), (BMI) and oxidative stress.

## Patients and Method

### Design of Study

The study is conducted at the Diabetes and Endocrinology Center in Thi-Qar and in the biochemistry laboratory in college of science, at the period between (November, 2019) to (May,2020). It included (100) cases, (25) control and (75) patients. There were (100) male and female subjects, control and diabetic of type 2 with and without complication diabetic aged (35-70) years were included in this study. They divided into four groups as the following:-

**Group A (Control):** Included fifty (25) healthy subjects aged (35-70).

**Group B (Diabetes type 2):** Included (25) patients with diabetes mellitus type 2 aged (35-70).

**Group C (Diabetes Type 2 with neuropathy)** Included (25) patients with metabolic syndrome aged (35-70).

**Group D (Diabetes Type 2 with diabetic foot syndrome)** Included(25) patients with diabetic foot syndrome aged(35-70)

### Collection of Blood Sample:

After overnight fasting for about 8 hr, (8 mL) of venous Blood samples were collected between 8:00 and 10:00 am from type 2 diabetic patients and controls then divided into the following:

- (2ml) of blood sample was taken to measure ESR.

- (3 ml)of the blood sample was transferred to tubes containing EDTA (Ethylene diamine tetra acetic acid) and used for HbA1c, CRP, hsCRP estimation.

- (3ml) were transferred to a plain tube and allowed to clot at room temperature to get serum by putting it in empty disposable tubes and centrifuged to separate it at 3000 rotor per minute (rpm) for 10 min, the serum samples were separated and stored at (- 20°C) for later measurement biochemical parameters, unless used immediately.

### Determination of Biochemical Parameters

**Interleukin 6 (IL-6):** Enzyme Linked Immunosorbent Assay (ELISA) technique was used to measure, serum levels of Interlukine-6 (IL-6 ELISA Kit Dublin, Ireland), in diabetic patients with & without complication diabetes type2 and control group<sup>(18,19)</sup>

**Fasting Blood Glucose (FBG):** Glucose was determined after enzymatic oxidation in the presence of glucose oxidase . The hydrogen peroxide formed reacts under catalysis of peroxidase, with phenol and 4-aminophenazone to form a red-violet quinoneimine dye as indicator<sup>(20)</sup>.

**Ceruloplasmin (Cp):** Serum Cp concentration was measured by the method of<sup>(21)</sup>. It is based on the ceruloplasmin-catalyzed oxidation of colorless para-phenylene diamine (PPD) to blue-violet oxidize form. The reaction is followed photometrically and the blank value is determined after inhibition of the enzyme with sodium azide<sup>(22)</sup>.

**Lipid Peroxidation Marker (Serum MDA):** Lipid peroxidation was determined by using the thiobarbituric acid method. MDA concentrations were calculated, using the molar extinction coefficient of MDA ( $\epsilon_{MDA}$ ) equal to  $1.56 \times 10^5 \text{ mol}^{-1} \cdot \text{cm}^{-1}$ <sup>(23)</sup>

**Statistical Analysis:** The statistical analysis proceeded in all groups of study, descriptive statistics analyzed by using one-way analysis of variance (ANOVA) were performed using mean and standard deviations (SDs) with least significant difference (LSD) test for continuous variables ( $p$  value  $\geq 0.05$ ) was considered to be significant. All analyses were performed with the Statistical Package for the Social Sciences SPSS for Windows (version 23.0, SPSS Inc, Chicago, III).

## Results and Discussions

**Clinical and Characteristic Features of the Studied Groups:** There are 100 case studies included in this study, with a difference between the groups of type 2 diabetes patients and the health control group in each of them (IL-6,FBG), oxidative stress (MDA,CP), and without difference in each (age, gender, and body mass index).

**Interleukin 6 (IL-6):** Table (1) shows the statistically significant increase in the levels of (IL-6) in patient groups compared to the control group ( $P \leq 0.05$ ),

and there is a significant increase in group (DF) compared to groups (DN) and (DM), and also a slight difference was found between group (DN) and group (DM)( $P \leq 0.05$ ). The results of this study agree with A previous study like<sup>(24-26)</sup>.

The most important factor in the development of foot ulcer is peripheral neuropathy. Diabetic peripheral neuropathy is one of the most serious complications of type 2 diabetes mellitus (T2DM) that decreases the quality of life of T2DM patients<sup>(27)</sup>. T2DM is a metabolic pro-inflammatory disorder characterized by chronic hyperglycemia and increased levels of circulating cytokines suggesting a causal role of inflammation in its etiology. Interleukin (IL)-6, is an important proinflammatory cytokine, that plays a potential pathological role in Diabetic foot disorder. Proinflammatory cytokines are involved in the pathogenesis of Diabetic foot disorder. Interleukin-6 (IL-6) plays an important role in the inflammatory and autoimmune processes<sup>(28)</sup>.

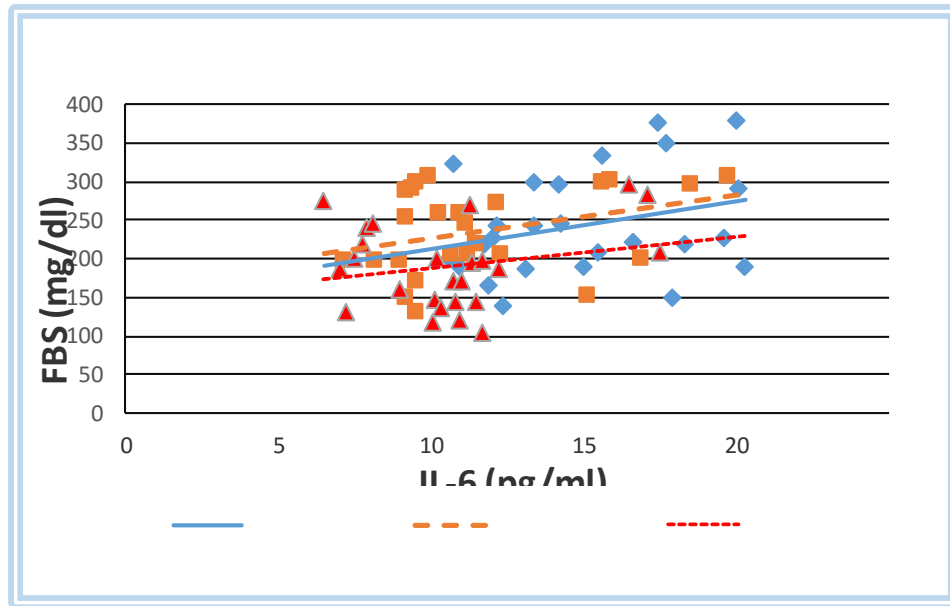
IL-6 levels are closely related to insulin resistance in type 2 diabetes patients and its complications<sup>(29)</sup>. IL-6 level is associated with slow flow/microvascular dysfunction<sup>(30)</sup>. Local levels of inflammatory mediators are associated in the uncontrolled type 2 diabetic patients<sup>(31)</sup>. Type 2 diabetes has been identified as an immune disease that leads to weak insulin signals and selective destruction of insulin-producing beta cells in which cytokines play an important role<sup>(32)</sup> as well as this study<sup>(33)</sup> showed higher values of (IL-6) for patients with type II diabetes compared to the control group. And it was proven through the study that (IL-6) reduces insulin sensitivity in the body<sup>(34)</sup> and thus the concentration of (IL-6) independently predicts the future risks of developing type 2 diabetes and its complications<sup>(35)</sup> On the other hand, we know that type II diabetes is associated with an mainly with an increase in the waist circumference clinically, and people who suffer from obesity fat tissue represents 50% of the body weight and is the first part of the immune system, as well as the (IL-6) secreted from many tissues, including fat tissue<sup>(36)</sup> and this explains for us a difference in levels The (IL-6) between study groups according to different body mass index.

**Fasting Blood Glucose Concentration:** Table (1) shows a significant increase in the concentration of (FBG) in all patient groups compared to the healthy group ( $P \leq 0.05$ ). We observed a significant increase in

the concentration of (FBG) in group (DF) and (DN) compared to group (DM) ( $P \leq 0.05$ ). This result is consistent with the results of the study<sup>(37)</sup>.

The fasting blood glucose level, which is measured after a fast of 8 hours, is the most commonly used indication of overall glucose homeostasis, largely because of disturbing events. A persistent elevation in blood glucose leads to glucose toxicity, which contributes to cell dysfunction and the pathology grouped together as complications of diabetes<sup>(38)</sup>. Glucose can be transported from the intestines or liver to other tissues in the body via the bloodstream. Long-term hyperglycemia causes many health problems including heart disease, cancer, eye, kidney, and nerve damage<sup>(39)</sup>. There is a significant

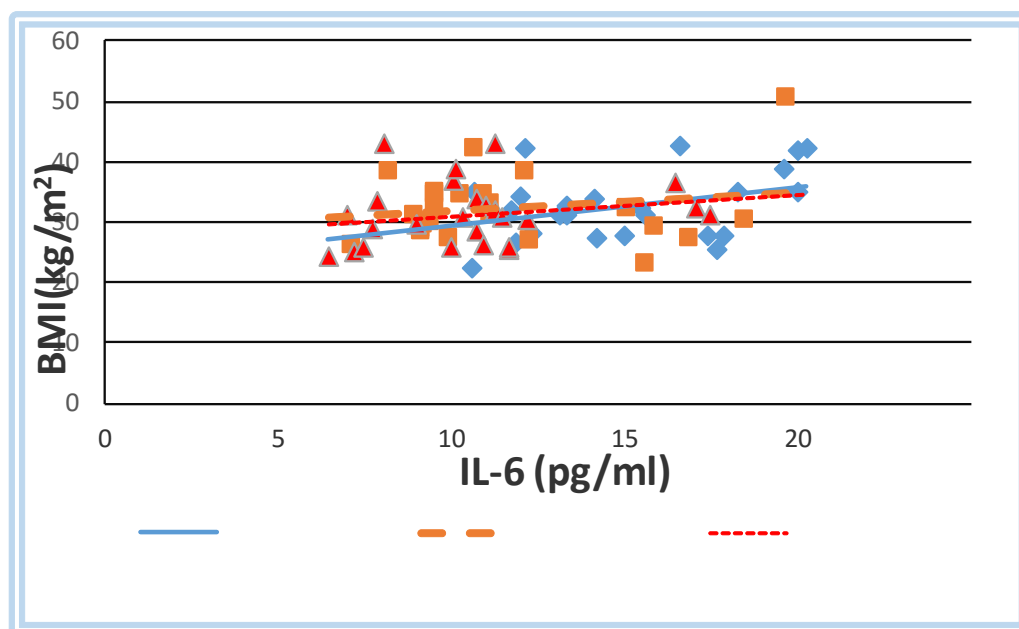
increase in the concentration of (FBG) in group (DF) and (DN) because all patients suffering from diabetic foot and neuropathy are patients with type 2 diabetes and obese and their period of diabetes has exceeded 10 years or more. Self-management (controlling the fasting blood sugar level) of diabetes is an essential element to prevent or mitigate complications of diabetes, as<sup>(40)</sup> it was stated that (FBG) levels increased in diabetic foot patients compared to diabetic patients, because the chronic elevation (FBG) leads to diabetic neuropathy. Which is the gateway to diabetic foot syndrome, as revealed in this study<sup>(37)</sup>. There is a positive correlation between IL-6 and FBG levels in each of DF ( $r = 0.29$ ), DN ( $r = 0.33$ ) and DM ( $r = 0.21$ ) as shown in figure(1).



**Fig (1): Correlation between IL-6 and FBG**

**Body mass index (BMI):** In all groups, we observed a general increase in BMI due to obesity, but the results for all age groups showed an increase in BMI in all patient groups compared to the control group ( $p \leq 0.05$ ). Table (1) show increase simple significance in group DF compared to DN and DM ( $P \leq 0.05$ ). These results are consistent with the results of<sup>(41)</sup>. Obesity is one of the variables that can be changed to reduce the possibility of foot ulceration, and this is especially important because patients who suffer from diabetic foot ulcers often suffer

from obesity. Therefore, weight reduction helps relieve pressure on the feet, and also reduces the incidence of diabetic neuropathy. Thus, mitigating the potential strong effect of BMI through appropriate dietary and metabolic control measures the complications of type 2 diabetes in general and of morbidity and the presentation of diabetes in particular<sup>(41)</sup>. There is a positive correlation between IL-6 and BMI levels in each of DF ( $r = 0.37$ ), DN ( $r = 0.19$ ) and DM ( $r = 0.19$ ) as shown in figure(2).



**Fig (2): Correlation between IL-6 and BMI**

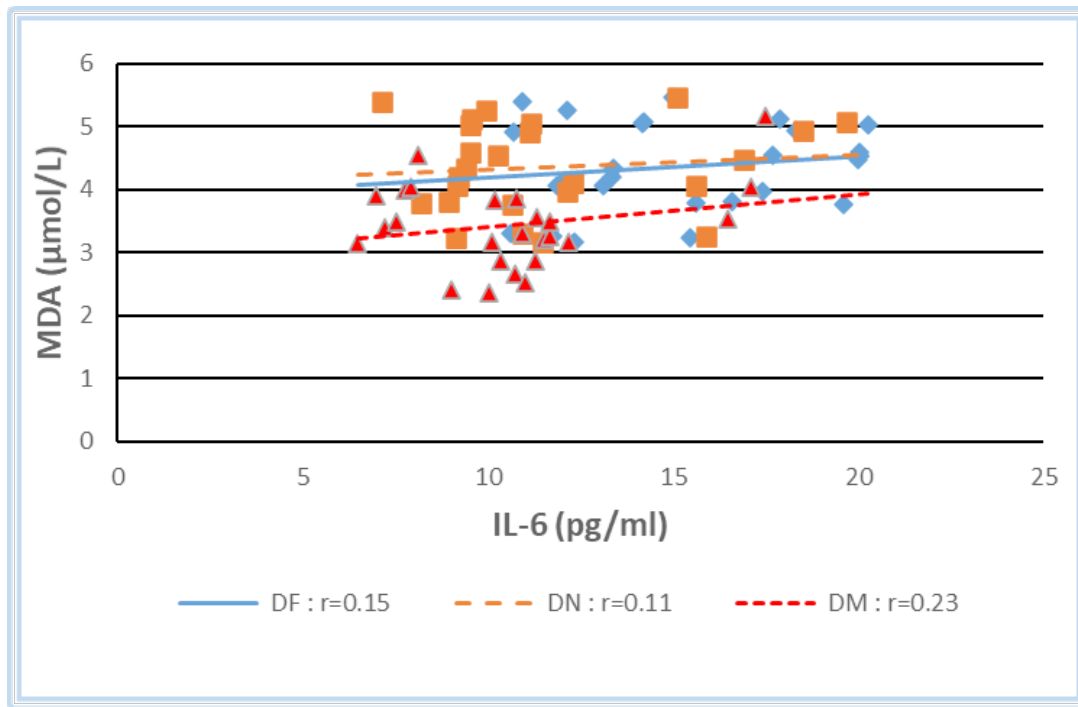
#### **Serum Malondialdehyde (MDA) Concentration:**

The table (1) shows a statistically significant increase in the concentration of (MDA) in all patient groups compared to the control group ( $P \leq 0.05$ ). We noticed a significant increase in the concentration of (MDA) in group (DF) and (DN) compared to group (DM) ( $P \leq 0.05$ ). We did not notice a statistically significant difference between Both groups (DF) and (DN) ( $P \leq 0.05$ ). However, we found slight significant differences in the serum concentration between groups (DF) and (DN) .. The results of this study were consistent with the results of a study such<sup>(42)</sup>.

Oxidized lipids have a signaling function in pathological situations, are proinflammatory agonists and contribute to neuronal death under conditions in which membrane lipid peroxidation occurs<sup>(43)</sup>. Results indicate that lipid peroxidation has a role in the pathogenesis of several such as inflammatory<sup>(44)</sup>. A level of MDA indicates the degree of lipid oxidation resulting from the oxidative degradation of polyunsaturated fatty

acids due to increased production of free radicals and impaired antioxidant defenses. Excess fat during each oxidation process may damage various body tissues<sup>(45)</sup>. Elevated levels of (MDA) may indicate oxidative stress associated with disease activity and its treatment. Diabetic neuropathy may arise from a combination of nerve and microvascular deficits. Oxidative stress can greatly contribute to these deficiencies and may be a direct result of hyperglycemia. Short postprandial peaks in plasma glucose are sufficient to generate the oxidative stress of hyperglycemia. In contrast, acute glucose deprivation also induces apoptosis of peripheral neurons through a mechanism that at least partially involves oxidative stress<sup>(46)</sup>. Treatments like antioxidants that target oxidative stress are the best solution to control blood glucose levels and thus prevent neuropathy as well as other complications of diabetes<sup>(47)</sup>. There is a positive correlation between IL-6 and MDA levels in each of DF ( $r = 0.15$ ), DN ( $r = 0.11$ ) and DM ( $r = 0.23$ ) as shown in figure(3).



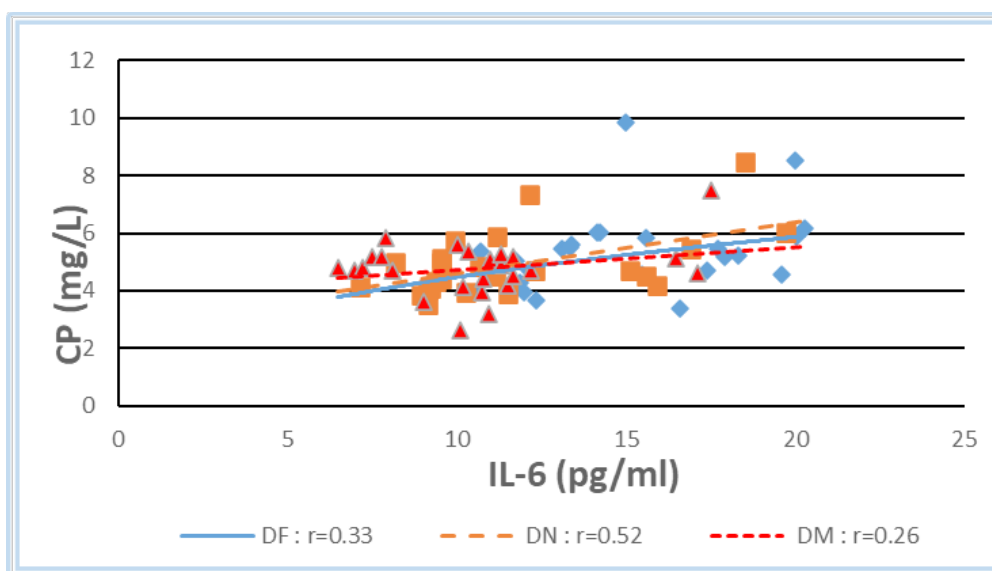


**Fig (3): Correlation between IL-6 and MDA**

#### **Serum Ceruloplasmin (Cp) Concentration:**

The table (1) indicates a significant increase in the concentration of (CP) for all groups of patients compared with the control group ( $P \leq 0.05$ ). There was a statistically significant increase in group (DF) compared to group (DM) ( $P \leq 0.05$ ). We did not notice significant differences in groups (DN). When compared with the two groups (DF) and (DM) ( $P \leq 0.05$ ), the results of this study were identical to that of<sup>(48)</sup>. CP plays a role in many biological functions including copper transport, coagulation, angiogenesis, ferroxidase activity, and defense against oxidative stress<sup>(49)</sup>. Coagulation and angiogenesis have a role in diabetes complications. The antioxidant properties of CP are attributed to its ability to inhibit lipid oxidation, scavenge superoxide, and isolate free copper ions<sup>(49,50)</sup>. CP a protein with specific domains capable of facilitating cellular energy production and preventing the formation of oxygen radicals, and its role in iron metabolism<sup>(51)</sup>. When there is an abnormality in secretion CP, the excess iron is deposited in the liver, pancreas, and retina, leading to

cirrhosis and endocrine abnormalities such as diabetes and vision loss respectively<sup>(52,53)</sup>. The mechanism behind the positive association between ceruloplasmin levels and the development of diabetic complications is largely unknown. One plausible explanation is that ceruloplasmin might act as a pro-oxidant under conditions of increased oxidative stress, such as in type 2 diabetes mellitus<sup>(53)</sup>. Although ceruloplasmin possesses antioxidant properties due to its ferroxidase activity, increased generation of ROS disrupts the binding of copper from ceruloplasmin<sup>(54)</sup>. Ceruloplasmin is an acute phase reactant, and the serum concentration increases during inflammation, infection, and trauma largely as the result of increased gene transcription in hepatocytes mediated by the inflammatory cytokines<sup>(55)</sup>. This explains the positive relationship between levels of (CRP, ESR and HS-CRP) that appeared in our study and (CP), as well as the positive correlation between it and (IL-6). There is a positive correlation between IL-6 and CP levels in each of DF ( $r = 0.33$ ), DN ( $r = 0.52$ ) and DM ( $r = 0.26$ ) as shown in figure (4).



**Fig (4): Correlation between IL-6 and CP.**

**Table 1: Characteristic data for all studied groups.**

Parameter	Groups	N	Mean	Std. Deviation
IL_6 (pg/ml)	Control	25	8.89 <sup>c</sup>	1.02
	Diabetes	25	10.63 <sup>b</sup>	2.93
	Neuropathy	25	11.66 <sup>b</sup>	3.34
	Diabetic foot	25	14.97 <sup>a</sup>	3.19
L.S.D	1.30			
FBG (mg/dl)	Control	25	101.96 <sup>c</sup>	13.23
	Diabetes	25	190.0 <sup>b</sup>	54.76
	Neuropathy	25	236.44 <sup>a</sup>	55.19
	Diabetic foot	25	244.52 <sup>a</sup>	68.66
L.S.D	24.54			
CP (mg/L)	Control	25	4.08 <sup>c</sup>	0.78
	Diabetes	25	4.76 <sup>b</sup>	0.92
	Neuropathy	25	4.89 <sup>ab</sup>	1.13
	Diabetic foot	25	5.34 <sup>a</sup>	1.39
L.S.D	0.50			
BMI (Kg/m <sup>2</sup> )	Control	25	30.43 <sup>b</sup>	4.510
	Diabetes	25	31.26 <sup>ab</sup>	5.26
	Neuropathy	25	32.13 <sup>ab</sup>	5.79
	Diabetic foot	25	33.70 <sup>a</sup>	8.92
L.S.D	2.98			
MDA (μmol/L)	Control	25	1.89 <sup>c</sup>	0.44
	Diabetes	25	3.43 <sup>b</sup>	0.65
	Neuropathy	25	4.32 <sup>a</sup>	0.72
	Diabetic foot	25	4.36 <sup>a</sup>	0.71
L.S.D	0.30			

## Conclusions

There are oxidative stress and a disturbance in the balance of oxidants and antioxidants in diabetic foot syndrome, neuropathy, and diabetes, which are associated with high levels of glucose. Diabetes and its complications can be controlled by correcting this disorder. IL-6 Positive correlation with (FBG,MDA,CP,BMI).

**Ethical Clearance and financial support:** Lastly the ethical approval for this study was issued by the ethical committee of college of science of Thi-Qar university. Moreover there was a financial support from college of science in Thi-Qar university.

**Conflict of Interest:** Nil

## References

1. Cho NH, Shaw JE, Karuranga S, Huang Y, da Rocha Fernandes JD, Ohlrogge AW, et al. IDF Diabetes Atlas: global estimates of diabetes prevalence for 2017 and projections for 2045. *Diabetes Res Clin Pract.* 2018 Apr;138:271–81.
2. Saeedi P, Petersohn I, Salpea P, Malanda B, Karuranga S, Unwin N, et al.; IDF Diabetes Atlas Committee. Global and regional diabetes prevalence estimates for 2019 and projections for 2030 and 2045: Results from the International Diabetes Federation Diabetes Atlas, 9th edition. *Diabetes Res Clin Pract.* 2019 Nov;157:107843.
3. Asareer, Y.; Salman, K. And Abdul-Kader, A. (2010) "The Association Between Metabolic Syndrome And Type Two Diabetes Mellitus In Basrah" College Of Medicine University Of Basrah.
4. Dietrich I, Braga GA, de Melo FG, da Costa Silva AC. The Diabetic Foot as a Proxy for Cardiovascular Events and Mortality Review. *Curr Atheroscler Rep.* 2017 Oct;19(11):44.
5. Sallam A, Sharawy A. Role Of Interleukin-6 (IL-6) And Indicators Of Inflammation In The Pathogenesis Of Diabetic Foot Ulcers. *Aust J Basic Appl Sci.* 2012;6.
6. Yubero-Serrano EM, Delgado-Lista J, Peña-Orihuela P, Perez-Martinez P, Fuentes F, Marin C, et al. Oxidative stress is associated with the number of components of metabolic syndrome: LIPGENE study. *Exp Mol Med.* 2013 Jun;45(6):e28.
7. Jialal I, Devaraj S, Adams-Huet B, Chen X, Kaur H. Increased cellular and circulating biomarkers of oxidative stress in nascent metabolic syndrome. *J Clin Endocrinol Metab.* 2012 Oct; 97(10):E1844–50.
8. Devaraj S, Goyal R, Jialal I. Inflammation, Oxidative Stress, And The Metabolic Syndrome. *US Endocrinol.* 2008;4(2):32–7.
9. Ramachandran A, Das AK, Joshi SR, Yajnik CS, Shah S, Kumar KP. Current Status Of Diabetes In India And Need For Novel Therapeutic Agents. *J Assoc Physicians India.* 2010;58:7–9.
10. Ginsberg HN, Elam MB, Lovato LC, Crouse JR 3rd, Leiter LA, Linz P, et al.; ACCORD Study Group. Effects of combination lipid therapy in type 2 diabetes mellitus. *N Engl J Med.* 2010 Apr;362(17):1563–74.
11. Maritim AC, Sanders A, Watkins Iii JB. Diabetes, oxidative stress, and antioxidants: a review. *J Biochem Mol Toxicol.* 2003;17(1):24–38.
12. Stephens JW, Gable DR, Hurel SJ, Miller GJ, Cooper JA, Humphries SE. Increased plasma markers of oxidative stress are associated with coronary heart disease in males with diabetes mellitus and with 10-year risk in a prospective sample of males. *Clin Chem.* 2006;52(3):446–52.
13. Cannon CP. Balancing the benefits of statins versus a new risk—diabetes. *Lancet.* 2010;375(9716):700–1.
14. American Diabetes Association. Standards of medical care in diabetes—2013. *Diabetes Care.* 2013;36 Supplement 1:S11–66.
15. Zalba, G., Fortuño, A., & Díez, J. (2006). Oxidative stress and atherosclerosis in early chronic kidney disease.†
16. Wolff SP. Diabetes mellitus and free radicals: free radicals, transition metals and oxidative stress in the aetiology of diabetes mellitus and complications. *Br Med Bull.* 1993;49(3):642–52.
17. Pickup JC, Chusney GD, Thomas SM, Burt D. Plasma interleukin-6, tumour necrosis factor  $\alpha$  and blood cytokine production in type 2 diabetes. *Life Sci.* 2000;67(3):291–300.
18. Mörs K, Kany S, Hörauf JA, Wagner N, Neunaber C, Perl M, et al. Suppression Of The Interleukin-1 $\beta$ -Induced Inflammatory Response Of Human Chang Liver Cells By Acute And Subacute Exposure To Alcohol: An In Vitro Study. *Croat Med J.* 2018;59(2):46–55.

19. Hornef MW, Frisan T, Vandewalle A, Normark S, Richter-Dahlfors A. Toll-Like Receptor 4 Resides In The Golgi Apparatus And Colocalizes With Internalized Lipopolysaccharide In Intestinal Epithelial Cells. *J Exp Med.* 2002;195(5):559–70.
20. Trinder P. Determination Of Glucose In Blood Using Glucose Oxidase With On Alternative Oxygen Receptor *Ann. Clin Biochem.* 1969;6:24–7.
21. Menden C, Boian J, Murthy L, And Petering HG. Plasma Antioxidant. *Anal Lett.* 1977;10:197.
22. Ravin HA. An Improved Colorimetric Enzymatic Assay Of Ceruloplasmin. *J Lab Clin Med.* 1961;58:161–8.
23. Wills E. Role Of Fatty Acid In The Pathogenesis Of Insulin Resistance And Niddm. *Biological Chemistry Journal.* 1969;113:315.
24. Kofteridis D, Samonis G, Karatzanis AD, Fragiadakis GM, Bourolias CA, Maraki S, et al. C-Reactive Protein And Serum Procalcitonin Levels As Markers Of Bacterial Upper Respiratory Tract Infections. *Am J Infect Dis.* 2009;5(4):289–94.
25. Ali Hadi, Y., M Nada, S., Hameed Yousif, W., & Ridha Jaafar, M. Association Of Proinflammatory Cytokines (Interleukin 6 And Interleukin 8) With Diabetes Mellitus Type 2 In Baghdad Population. *Karbala Journal Of Pharmaceutical Sciences.* 2014;5(8):21–5.
26. Ali EN, Khadem AA, Muhammed HJ. Determination Of IL-6 And CRP In Patients With Type Two-Diabetes Mellitus In Baghdad/Iraq. *Journal Of University Of Babylon For Pure And Applied Sciences.* 2019;27(3):302–7.
27. Mansoor Q, Javaid A, Bilal N, Ismail M. Angiotensin-Converting Enzyme (ACE) Gene II Genotype Protects Against The Development Of Diabetic Peripheral Neuropathy In Type 2 Diabetes Mellitus. *J Diabetes.* 2012;4(3):257–61.
28. Siemińska L, Wojciechowska C, Kos-Kudła B, Marek B, Kajdaniuk D, Nowak M, et al. Serum Concentrations Of Leptin, Adiponectin, And Interleukin-6 In Postmenopausal Women With Hashimoto's Thyroiditis. *Endokrynol Pol.* 2010;61(1):112–7.
29. Lukic L, Lalic NM, Rajkovic N, Jotic A, Lalic K, Milicic T, et al. Hypertension In Obese Type 2 Diabetes Patients Is Associated With Increases In Insulin Resistance And IL-6 Cytokine Levels: Potential Targets For An Efficient Preventive Intervention. *Int J Environ Res Public Health.* 2014;11(4):3586–98.
30. Guo F, Dong M, Ren F, Zhang C, Li J, Tao Z, et al. Association Between Local Interleukin-6 Levels And Slow Flow/Microvascular Dysfunction. *J Thromb Thrombolysis.* 2014;37(4):475–82.
31. Duarte PM, Bezerra JP, Miranda TS, Feres M, Chambrone L, Shaddox LM. Local Levels Of Inflammatory Mediators In Uncontrolled Type 2 Diabetic Subjects With Chronic Periodontitis. *J Clin Periodontol.* 2014;41(1):11–8.
32. Pickup JC. Inflammation And Activated Innate Immunity In The Pathogenesis Of Type 2 Diabetes. *Diabetes Care.* 2004;27(3):813–23.
33. Zozulinska D, Majchrzak A, Sobieska M, Wiktorowicz K, And Wierusz-Wysocka B. Serum Interleukin-8 Level Is Increased In Diabetic Patients. *Diabetologia.* 1999;42:117–8.
34. Hotamisligil GS. Mechanisms Of TNF- $\alpha$ -Induced Insulin Resistance. *Exp Clin Endocrinol Diabetes.* 1999;107(02):119–25.
35. Pradhan AD, Manson JE, Rifai N, Buring JE, Ridker PM. C-Reactive Protein, Interleukin 6, And Risk Of Developing Type 2 Diabetes Mellitus. *JAMA.* 2001;286(3):327–34.
36. Graham TE, Kahn BB. Tissue-Specific Alterations Of Glucose Transport And Molecular Mechanisms Of Intertissue Communication In Obesity And Type 2 Diabetes. *Horm Metab Res.* 2007;39(10):717–21.
37. Parhi A, Das S, Mahapatra S, Pradhan N, Behera M, Patnaik B, et al. The Level And Role Of Interleukin-17 In Patients Of Type 2 Diabetes Mellitus With And Without Complications. *J Diabetes Mellitus.* 2019;9(4):176–85.
38. Wasserman DH. Four Grams Of Glucose. *Am J Physiol Endocrinol Metab.* 2009;296(1):E11–21.
39. Pouncey A. Excess Sugar Linked To Cancer. *Br Dent J.* 2013;214(4).
- 40- Navichareern, R. (2012). Diabetes Self-Management, Fasting Blood Sugar And Quality Of Life Among Type 2 Diabetic Patients With Foot Ulcers. *Journal Of The Medical Association Of Thailand= Chotmaihet Thangphaet,* 95(2), 156-162.
41. Vela SA, Lavery LA, Armstrong DG, Anaim AA. The Effect Of Increased Weight On Peak Pressures:

- Implications For Obesity And Diabetic Foot Pathology. *J Foot Ankle Surg.* 1998;37(5):416–20.
42. Singh SK, Sahay RK, Krishna A. Oxidative Stress In Diabetic Foot Ulcer. *Diabetes Metab Syndr.* 2008;2(2):109–13.
  44. Farooqui T, Farooqui AA. Lipid-Mediated Oxidative Stress And Inflammation In The Pathogenesis Of Parkinson’s Disease. *Parkinsons Dis.* 2011;.
  45. Armstrong AM, Chestnutt JE, Gormley MJ, Young IS. The Effect Of Dietary Treatment On Lipid Peroxidation And Antioxidant Status In Newly Diagnosed Noninsulin Dependent Diabetes. *Free Radic Biol Med.* 1996;21(5):719–26.
  46. Honma H, Podratz JL, Windebank AA. Acute Glucose Deprivation Leads To Apoptosis In A Cell Model Of Acute Diabetic Neuropathy. *J Peripher Nerv Syst.* 2003;8(2):65–74.
  47. Vincent AM, Russell JW, Low P, Feldman EL. Oxidative Stress In The Pathogenesis Of Diabetic Neuropathy. *Endocr Rev.* 2004;25(4):612–28.
  48. Prabhu K, Sharma D, Belle VS, Sundaram M, Gyawali P, Thakur RK. Diabetes With Complication-Scope Of Serum Ceruloplasmin As A Biomarker. *Journal Of International Academic Research For Multidisciplinary.* 2014;2(5):841–6.
  49. Floris G, Medda R, Padiglia A, Musci G. The Physiopathological Significance Of Ceruloplasmin: A Possible Therapeutic Approach. *Biochem Pharmacol.* 2000;60(12):1735–41.
  50. Gutteridge JM. Antioxidant Properties Of Ceruloplasmin Towards Iron-And Copper-Dependent Oxygen Radical Formation. *FEBS Lett.* 1983;157(1):37–40.
  51. Takahashi N, Ortel TL, Putnam FW. Single-Chain Structure Of Human Ceruloplasmin: The Complete Amino Acid Sequence Of The Whole Molecule. *Proc Natl Acad Sci USA.* 1984;81(2):390–4.
  52. Leoni V, Albertini R, Passi A, Abuja PM, Borroni P, d’Eril GM, et al. Glucose Accelerates Copper-And Ceruloplasmin-Induced Oxidation Of Low-Density Lipoprotein And Whole Serum. *Free Radic Res.* 2002;36(5):521–9.
  53. Memişoğulları R, Bakan E. Levels Of Ceruloplasmin, Transferrin, And Lipid Peroxidation In The Serum Of Patients With Type 2 Diabetes Mellitus. *J Diabetes Complications.* 2004;18(4):193–7.
  54. Shukla N, Maher J, Masters J, Angelini GD, Jeremy JY. Does Oxidative Stress Change Ceruloplasmin From A Protective To A Vasculopathic Factor? *Atherosclerosis.* 2006;187(2):238–50.
  55. Gitlin JD. Transcriptional Regulation Of Ceruloplasmin Gene Expression During Inflammation. *J Biol Chem.* 1988;263(13):6281–7.

# Prevalence of Work from Home on Female-it Workers, on Neck Pain and its Psycho-Social Effects During Epidemic Period

Taruna Verma<sup>1</sup>, Rituraj Verma<sup>2</sup>, Diksha Bameta<sup>3</sup>, Vikas Sharma<sup>4</sup>, Sonia Saroha<sup>5</sup>, Ashu Taneja<sup>6</sup>

<sup>1</sup>Assistant Professor, Galgotias University, Greater Noida, U.P., <sup>2</sup>Associate Professor, Galgotias University, <sup>3</sup>Student of Physiotherapist, Galgotias University, <sup>4</sup>Assistant Prof. Galgotias University, <sup>5</sup>Assistant Prof. Baba Mastnath University, <sup>6</sup>Consultant Physiotherapist

## Abstract

The outbreak of (COVID-19) has created a global health crisis that has had a deep impact on the way we perceive our world and our everyday lives. This survey was helpful to know the impact of neck pain and leisure activity during lockdown of Female IT workers while remaining at work, and to analyse psycho-social effect on neck pain.

**Methodology:** Female office workers with neck pain (n = 60) completed a survey about impact of their neck pain and leisure activities. Consequences of neck pain were evaluated with questions on self-reported impact on work and leisure activity. Responses to survey questions were analysed using descriptive analyses.

**Result:** The point prevalence of NP was significantly related to age, gender, health status, job satisfaction, and length of employment.

**Conclusions:** The findings provide evidence that the impact on work and leisure was substantial.

**Keywords:** Neck Pain, Office Employee, Prevalence, Risk Factors, Consequence, Quality of Life.

## Introduction

Neck pain is very common in the society, particularly in office workers. Neck pain related disability has health and economic impact both at individual and community level. Community based studies worldwide reported annual prevalence of neck pain ranging from 15 to 44%.<sup>[1]</sup> Globally one-year prevalence of neck pain related disability has been reported ranging from 7%<sup>[2]</sup> to 11%.<sup>[1]</sup> Prevalence of neck pain among office workers is higher than in the general community.<sup>[3]</sup> Globally, one-year prevalence of neck pain among administrative workers has been reported between 15%<sup>[4]</sup> to 34.4%.<sup>[5]</sup>

It is considered as a major public health problem, both in terms of health and overall well-being of the person and the society<sup>[6-8]</sup>. It has imposed relatively high direct and indirect costs, and may affect the quality of life and working condition of patients<sup>[6,9,10]</sup>. Among occupational groups, office workers, especially intensive computer users, are at high risk for developing Neck

Pain<sup>[11-18]</sup>. Prolonged use of computers during daily work activities and recreation is often cited as a cause of neck pain.

The term work-related neck pain is employed in this research; “computer” refers to desktop and laptop or notebook personal computers, video display units, and video display terminals, to include the use of keyboards and pointing devices (i.e., mice, trackballs).

By defining the pain, “pain is associated with tissue injury and an capability to identify pain sensations.”<sup>[19]</sup>. This pain and disability is due to the pressure of socioeconomic problems, especially reimbursement to which involves blow injuries<sup>[20]</sup>. Cervical pain involving skull and neck zone was the outcome of mechanical syndromes, shock, as well as provocative degenerative diseases<sup>[21]</sup>. This pain occurring from constant postures was defines i’Nonspecific Neck Pain.’’<sup>[22]</sup>. The continuous usage of computers, with wrong posture and sit with rounded shoulders be able to interrupt the normal

lodortic curve of neck that can lead towards muscular discrepancy and therefore neck pain.<sup>[23]</sup> Continuous work on computers and constant load on para spinal neck muscles lead to stretch weakness and pain.<sup>[24]</sup> Electromyographic studies revealed that the muscles of neck like upper trapezius and cervical erector spinal muscle (CES) had constant loading throughout typing and mouse use.<sup>[25]</sup>

Increasing computer-based tasks at the workplace may cause poor working postures and repetitive movements, especially in head and neck regions <sup>[26]</sup>. Different studies have demonstrated that office workers were at high risk of developing Neck Pain, yet, they reported different prevalence rates <sup>[26-28]</sup>.

A number of studies have been carried out to investigate the association between neck pain and occupation. Larsman et al. <sup>[29]</sup> reported that 70% of medical secretaries had job-related neck pain. For academic staff in Hong Kong, the one-year prevalence of neck pain has been reported as 62%.<sup>[30]</sup> A high prevalence and incidence of neck and shoulder pain (work-related diseases) is present in the working population, especially in computer-based employment.<sup>[31,32]</sup>

In general, the percentage of neck pain among women appears to be higher than that in men,<sup>[33]</sup> and their excursion of head retraction and protrusion is than men in a normal situation.<sup>[34]</sup>

In an epidemiological study by Jensen et al., carried out on office workers, 53% female workers of call centers reported having NP <sup>[26]</sup>.

Neck pain was more common in female computer operators. It was more common in middle class computer operators as compared to others. 67.3% of computer operators of localized neck and 32.7% complained of radiating neck pain. Neck pain occurred in computer operators due to wrong posture. It reduced the performance of computer operators..

Those persons who work more than two hours on computers are more likely to develop postural neck pain and other musculoskeletal problems at neck region.<sup>[35]</sup> Greater than 50% of the computer operators have pain in neck, shoulder, arms, wrists and fingers.<sup>[36]</sup> In one study, 285 of the over-all Dutch employed people worked on pain in the neck, shoulder arms, hands or wrists in the earlier twelve months of employment.<sup>[37]</sup>

The etiology of work-related neck pain disorders (NPD) seems to be multidimensional is associated with physical and psychosocial factors <sup>[38]</sup>. A number of factors, including individual factors (e.g. gender and age)<sup>[28,39,40]</sup>, and work related factors (e.g repetitive work, prolonged sitting, and static posture), Work-related psychosocial factors, such as interpersonal associations at work, funds, and finances appear to play a major role on the occurrence of NP <sup>[38, 41, 42]</sup>.

Computer users had symptoms of discomfort in posture, headaches, discomforts in the neck and shoulder due to pain.<sup>[43]</sup> Computer worker had been related with poor posture and musculoskeletal neck and upper extremity pain.<sup>[44]</sup> Prevalence of the complaints that had been identified to increase risk of neck pain in computer operators were, reduce in work location ergonomic, employment duration, continuous sitting in front of computer wrong body biomechanics and work station:<sup>[45]</sup> Rationale of this study was to spread awareness about neck pain in computer operators and to determine the prevalence of neck pain in computers users.

The outbreak of the novel corona virus (COVID-19) and the subsequent work-from-home imperatives and lockdown led to significant economic disruptions around the world. For despite being at home all day, remote workers in the the time of corona virus face key challenges that can affect engagement, satisfaction, productivity and mental health. Effects of the pandemic on employees mental health cannot be ignored. Work related muscular-skeletal disorders of the neck are major problem among employees who spend a great deal of time using laptop. Today, a large number of people use laptop for work and recreation, taking up a great deal of their time each day. Such survey would help me to knowing the impact of neck pain and leisure activity during lockdown of female IT workers while remaining at work. No clinical sample, would be collected or the study. This research focused on neck pain in female IT workers as females consistently demonstrate an increased prevalence of neck disorders and usually over-reported in the office worker population. Consequences of neck pain were evaluated with questions on self-reported impact on work and leisure-activity. Responses to survey questions were analyzed using descriptive analyses.

**The purpose of our study were:** (a) to investigate the prevalence of neck pain and leisure activities among Indian female IT-workers who is currently doing work

from during epidemic period and the impact of work from home on neck pain (b) to analyse psycho-social effect on neck pain and the ratio between these two variables.

**Research Hypothesis:** There will be significant relation of Impact of Neck pain and Psycho-social effects during Work from Home among Indian Female-IT workers during Epidemic period

**Null Hypothesis:** There will be no significant relation of Impact of Neck pain and Psycho-social effects during Work from Home among Indian Female-IT workers during Epidemic period

### Methodology

**Type of Study:** Cross sectional normative study design with non random convenient sampling

**Ethical Clearance:** Prior to conduct of the study institutional ethical approval & an informed consent in writing were obtained from all the participants

**Sample Size:** 60 participants

**Inclusion Criteria:** Participants were included in the study if they were normal healthy individuals within the age range of 25-45 years.

**Exclusion Criteria:**

Maligancy

History of central or peripheral nervous system disorders

Medical diagnosis of systemic, muscular or connective tissue

History of significant injury to neck or upper thoracic region

History of thoracic or cervical spine surgery

Headaches within the last years that resulted in limitation of daily activity

The general questionnaire contained demographic characteristics and background data such as gender, age, height, weight and marital status. The specific questionnaire included questions the existence and duration of neck pain, working posture and duration (for example sitting or positions during work), duration of working on the laptop, the prevalence of NP, and

possible risk factors for NP in Female IT- worker’s along with the consequences. The validity and reliability of the questionnaires were evidenced. To detect the rate of NP prevalence, six month during epidemics period, work-from-home, prevalence were recorded. The definition of NP was stated in the questionnaire as pain, ache, or discomfort in the area between the occiput and third thoracic vertebra, and between the medial borders of the scapula. A drawing demarcating of the anatomical area was provided in the questionnaire.

### Result Analysis

The results showed that during the pandemic period, prevalence of neck Mild to Moderate. Elongated working hours on the computer, taking a prolonged sitting position, overtime, and static postures were the most irritating factors, respectively (P < 0.001).

**Pie Chart:** The result of this study supports that 60 people who are doing work from home 6-12 hour or more then 12 hours least suffering from discomfort and pain in neck, in this study we are finding that people doing work from home 23% people said it increase the stress level, 33% people said it increase work, 11% uncomfortable, 33% comfortable.



**Figure 1: It shows the result of work load and stress level, number of people who are doing work from home at least 6-12 hours in a day.**

**Demographic data analysis:** Data processing and analysis was done with graph Pad’s website includes the portion of manual graph Pad Prism (window version 8pro) the pie-chart and t-test analysis were used for statistical correlation. The t score is a ratio between the difference between two groups and the difference within the groups. Our small t-score denotes that the groups are similar. AP > 0.05 was considered not statistically significant.



**P value and statistical significance:** The two-tailed P value equals 0.9825. By conventional criteria, this difference is considered to be not statistically significant.

**Confidence interval:** The mean of Group One minus Group Two equals -0.33. 95% confidence interval of this difference: From -39.97 to 39.30. **Intermediate values used in calculations:**  $t = 0.0234$   $df = 4$  standard error of difference = 14.275

**Table No. 1**

Group	Group One	Group Two
Mean	19.67	20.00
SD	22.81	9.54
SEM	13.17	5.51
N	3	3

## Discussion

This study identified that the severity of neck pain in female IT workers is mild to moderate but that it has negative impact on their work and leisure time activity.

Immediate prevalence of NP was significantly related to female gender. Our study supports previous studies, indicating that NP was a more common complaint among female office employees than male<sup>[1,28,30,46]</sup>. Wijnhoven et al., in their study, also showed that prevalence rates of musculoskeletal pain were higher for females than males<sup>[47]</sup>.

The general questionnaire contained demographic characteristics and background data such as gender, age, height, weight, and marital status. The specific questionnaire included questions regarding the existence and duration of neck pain, working posture and its duration (for example sitting or standing positions during work), duration of working on the computer, the prevalence of NP, and possible risk factors for NP in office worker's population along with the consequences. The validity and reliability of the questionnaires were evidenced<sup>[48]</sup>.

Ariens et al.<sup>[41]</sup> also demonstrated that sitting for more than 95% of the working time could enhance the risk of NP. Other studies also confirmed our results and indicated that longer time spent on the computer and improper work conditions may contribute to the development of NP among office workers<sup>[47,49]</sup>.

Our study revealed certain work-related

determinants, such as working hours on the computer, prolonged sitting, and forward flexion posture during working, which were the most common factors that enhanced the risk of developing NP among office employees<sup>[47]</sup>.

## Conclusion

Thus, my research work has proved that there was a non-significant relation of Impact of Neck pain and Psycho-social effects during work from Home among Indian Female-IT workers during Epidemic period. Some protective strategies such as having a break during hours and performing regular daily exercises were found as useful protective factors to reduce the incidence of NP in office employees.

**Source of Funding:** Self

**Conflict of Interest:** Nil

## References

1. Korhonen T, Ketola R, Toivonen R, Luukkonen R, Häkkänen M, Viikari-Juntura E. Work-related and individual predictors for incident neck pain among office employees working with video display units. *Occup Environ Med* 2003;60:475-82.
2. Fejer R, Kyvik KO, Hartvigsen J. The prevalence of neck pain in the world population: A systematic critical review of the literature. *Eur Spine J* 2006;15:834-48.
3. Lau EM, Sham A, Wong KC. The prevalence of and risk factors for neck pain in Hong Kong Chinese. *J Public Health Med* 1996;18:396-9
4. De Loose V, Burnotte F, Cagnie B, Stevens V, Van Tiggelen D. Prevalence and risk factors of neck pain in military office workers. *Mil Med* 2008;173:474-9.
5. Shannon HS, Woodward CA, Cunningham CE, McIntosh J, Lendrum B, Brown J, et al. Changes in general health and musculoskeletal outcomes in the workforce of a hospital undergoing rapid change: A longitudinal study. *J Occup Health Psychol* 2001;6:3-14
6. Ranasinghe P, Perera YS, Lamabadusuriya DA, Kulatunga IS, Jayawar-dana N, Rajapakse S, et al. Work-related complaints of arm, neck and shoulder among computer office workers in an Asian country: prevalence and validation of a risk-factor questionnaire. *BMC Musculoskelet Disord*.

- 2011;12:68. doi: 10.1186/1471-2474-12-68. [PubMed:21463513].
7. Daffner SD, Hilibrand AS, Hanscom BS, Brislin BT, Vaccaro AR, Albert TJ. Impact of neck and shoulder pain on overall health status. *Spine (Phila Pa 1976)*. 2003;28(17):2030–5. doi:10.1097/01.BRS.0000083325.27357.39. [PubMed:12973155].
  8. Eltayeb S, Staal iJB, Kennes J, Lamberts PH, de Bie RA. Prevalence of complaints of arm, neck and shoulder among computer office workers and psychometric evaluation of a risk factor questionnaire. *BMC Musculoskelet Disord*. 2007;8:68. doi:10.1186/1471-2474-8-68. [PubMed:17629925].
  9. Bassols A, Bosch F, Banos JE. How does the general population treat their pain? A survey in Catalonia, Spain. *J Pain Symptom Manage*. 2002;23(4):318–28. [PubMed:11997201].
  10. Borghouts JA, Koes BW, Vondeling H, Bouter LM. Cost-of-illness of neck pain. The Netherlands in 1996. *Pain* 1999;80(3):629–36. [PubMed:10342424].
  11. Brandt LP, Andersen JH, Lassen CF, Kryger A, Overgaard E, Vilstrup I, et al. Neck and shoulder symptoms and disorders among Danish computer workers. *Scand J Work Environ Health*. 2004;30(5):399–409. [PubMed:15529803].
  12. Jensen C. Development of neck and hand-wrist symptoms in relation to duration of computer use at work. *Scand J Work Environ Health*. 2003;29(3):197–205. [PubMed:12828389].
  13. Juul-Kristensen B, Jensen C. Self-reported workplace related ergonomic conditions as prognostic factors for musculoskeletal symptoms: the "BIT" follow up study on office workers. *Occup Environ Med*. 2005;62(3):188–94. doi:10.1136/oem.2004.013920. [PubMed:15723884].
  14. Ortiz-Hernandez iL, Tamez-Gonzalez S, Martinez-Alcantara S, Mendez Ramirez I. Computer use increases the risk of musculoskeletal disorders among newspaper office worker. *Arch Med Res*. 2003;34(4):331–42. doi:10.1016/S0188-4409(03)00053-5. [PubMed:12957532].
  15. Ijmker S, Huysmans MA, van der Beek AJ, Knol DL, van Mechelen W, Bongers PM, et al. Software-recorded and self-reported duration of computer use in relation to the onset of severe arm-wrist-hand pain and neck shoulder pain. *Occup Environ Med*. 2011;68(7):502–9. doi:10.1136/oem.2010.056267. [PubMed:21045214].
  16. Szeto GP, Straker L, Raine S. A field comparison of neck and shoulder postures in symptomatic and asymptomatic office workers. *Appl Ergon*. 2002;33(1):75–84. [PubMed:11831210].
  17. Szeto GP, Straker LM, O'Sullivan PB. A comparison of symptomatic and asymptomatic office worker performing monotonous keyboard work-2: neck and shoulder kinematics. *Man Ther*. 2005;10(4):281–91. doi: 10.1016/j.math.2005.01.005. [PubMed:15996890].
  18. van den Heuvel SG, van der Beek AJ, Blatter BM, Bongers PM. Do work-related physical factors predict neck and upper limb symptoms in office workers? *Int Arch Occup Environ Health*. 2006;79(7):585–92. doi: 10.1007/s00420-006-0093-8. [PubMed:16710709].
  19. Wright A. A Criticism of the IASIP's Definition of Pain. *J Consciousness Studies* 2011;18:19-44.
  20. Carroll L. The factors associated with neck pain and its related disability in the Saskatchewan population. *Spine* 2000;25:1109-17.
  21. Krause N, Burgel B, Rampel D. Effort reward imbalance and one-year change in neck-shoulder and upper-extremity pain among call centre computer operators. *Scand J Work Environ Health* 2010;36:42-53.
  22. Core P, Cassidy JD, Carroll L. The epidemiology of neck pain: what we have learned from our population-based studies. *J Canadian Chiropr Assoc* 2003;47:284-90.
  23. Green BN. A literature review of neck pain associated with computer use : public health implications. *J Can Chiropr Assoc* 2008;52:161-7.
  24. Green BN. A literature review of neck pain associated with computer use : public health implications. *J Can Chiropr Assoc* 2008;52:161
  25. Blatter B, Heinrich J. RSI-klachten in de Nederlandse beroepsbevolking: trends, risicofactoren en verklaringen. *Tijdschrift voor gezondheidswetenschappen*. 2005;83:16-24.
  26. Jensen C, Finsen L, Søgaard K, Christensen H. Musculoskeletal symptoms and duration of computer and mouse use. *Int J Ind Ergonom*. 2002;30(4-5):265–75. doi:10.1016/s0169-

- 8141(02)00130-0. iiiiiI
27. Chiu TT, Ku WY, Lee MH, Sum WK, Wan iMP, Wong CY, et al. AI study on the prevalence of and risk factors for Ineck pain among university academic staff iin Hong Kong. *J Occup Rehabil.* 2002;12(2):77–91. I[PubMed:12014228]. iiiiiI
  28. Kamwendo K, Linton SJ, Moritz U. Neck and shoulder disorders in imedical secretaries.Part I. Pain prevalence and irisk factors. *Scand J Rehabil Med.* 1991;23(3):127–33. [PubMed: 1962155]. iiiiiI
  29. Larsman P, Kadefors R, Sandsjö L. Psychosocial Iwork conditions, perceived stress, perceived muscular tension,and ineck/shoulder symptoms among medical secretaries. *Int Arch Occup Environ Health.*2013;86:57–63. iiiiiI
  30. Chiu TT, Ku WY, Lee MH, Sum WK, Wan MP, Wong CY, et al. A study on itheIprevalence of and irisk factors for ineck ipain among iuniversity academic staff iin Hong Kong. *J Occup Rehabil.* 2002;12:77–91. iiiiiI
  31. Sadeghian F, Raei M, Ntani G, Coggon D. Predictors of iincident and persistent neck/shoulder pain in Iranian workers: a cohort study. *PLoS One.* 2013;8:e57544. doi:10.1371/journal.pone.0057544. Epub 2013 Feb 28. iiiiiI
  32. Weevers H-JA, Van der Beek AJ, Anema iJR, Van der Wal G, Van iMechelen W. Work-related diseaselin general practice: a systematic review. *Fam Pract.* 2005;22:197–204.
  33. de iKoning CHP, van den Heuvel SP, Staal JB, SmitsEngelsman BCM, Hendriks EJM. Clinimetri evaluation iof iactive range of imotion measures iin ipatients iwith inon-specific neck ipain: a systematic review. *Eur Spine J.* 2008;17:905–921. iiiiiI
  34. Severinsson Y, Elisson L, Bunketorp O. Reliability of imeasuringIthe cervical sagittal translation mobility with a isimple method iin a clinical setting. *Rehabil Res Pract.* 2012;2012:629104. doi:10.1155/2012/629104
  35. Aggarwal P, Reza MK. Impact of iComputer use on iPrevalence of iNeck Pain iand Consequent Disability. *IIndia J Physiotherapy Occupational Ther* 2013;7:102.
  36. Cagnie B, Danneels L, Van iTiggelen D, De Loose V, Cambier D. Individual iand iwork related irisk factors for ineckIpain among office workers : a icross sectional study. *Eur Spine J* 2007;16:679-86.
  37. Mc Lean L, Tingley M, Scott R, Rickards J. Computer terminal iwork iand ithe benefit of Imicrobreaks. *Applied Ergonomics* 2001;32:225-37.
  38. Linton iSJ. AIreview of ipychological irisk ifactors in back iand ineck ipain. *Spine (Phila iPa 1976).* 2000; 25(9):1148–56. [PubMed:10788861]. iiiiiI
  39. Evans O, Patterson iK. Predictors of ineck and ishoulder Ipain Iin Inonsecretarial computer users. *Int J Ind Ergonom.* 2000;26:357–65. iiiiiI
  40. Korhonen T, Ketola R, Toivonen R, Luukkonen IR, Hakkanen M, ViikariJuntura E. Work related iand individual predictors for Iincident neck ipain among ioffice employees working iwith ivideo display Iunits. *Occup iEnviron iMed.* 2003;60(7):475–82. [PubMed:12819280]. iiiiiI
  41. Ariens GA, Bongers PM, Hoogendoorn WE, Houtman IL, van der Wal G, van iMechelen iW. High quantitative ijob demands iand ilow coworkerIsupport iasIriskIfactors for Ineck Ipain: results ofIa prospective cohort istudy. *Spine (Phila iPa 1976).* 2001;26(17):1896–901. [PubMed:11568702] discussion 1902-3. iiiiiI
  42. Piranveyseh P, Motamedzade iM, Osatuke K, Mohammadfam I, Moghimbeigi A, Soltanzadeh A, et al. Association ibetween psychosocial, organizational and Ipersonal ifactors and iprevalence of Imusculoskeletal IdisordersIin ioffice workers. *IntJ iOccup. Saf iErgon.* 2016;22(2):267–73. do i:10.1080/10803548.2015.1135568. [PubMed: 26757785]. iiiiiI
  43. Bernaards CM, Ariens GA, Hildebrandt iVH. The cost ieffectiveness of ia ilife style physical iactivity Iintervention Iin iaddition to Ia iwork style iintervention ion Ithe irecovery ifrom Ineck iand Iupper limb symptoms IinIcomputer workers. *BMC IMusculoskeltal Disord* 2006;7(1):80.
  44. Yasmin iN, Bhuiyan iM, Lahiry S. Work-Related iMusculosleltal iDisorders iAmong iComputer iUsers. In:9th iSouth ieast IAsian Ergonomics IConference,2008,22-24 October. Bangkok, Thailand. Available. from: iwww.SEAES2008.org.
  45. Szeto iGPY, Straker LM, O’Sullivan PB, Neckshoulder muscle activity Iin igeneral Iand Itask-specific Iresting postures of isymptomatics

- computer users with chronic neck pain. *Manual Therapy* 2009;14:338-45.
46. Wijnhoven HA, de Vet HC, Picavet HS. Prevalence of musculoskeletal disorders is systematically higher in women than in men. *Clin J Pain*. 2006;22(8):717–24. doi: 10.1097/01.ajp.0000210912.95664.53. [PubMed: 16988568].
47. Côté P, van der Velde G, Cassidy JD, et al. The burden and determinants of neck pain in workers: results of the Bone and Joint Decade 2000–2010 Task Force on Neck Pain and Its Associated Disorders. *J Manipulative Physiol Ther*. 2009;32:S70–
48. Ehsani F, Mosallanezhad Z, Ahmadizade Z, Taghipour M. Relationship between working with computer and forward head posture and neck pain among office workers. *Physical Treatments-Specific Physical Therapy J*. 2013;3(2):29–33.
49. Rodrigues EV, Gomes AR, Tanhofffer AI, Leite N. Effects of exercise on pain of musculoskeletal disorders: a systematic review. *Acta Ortop Bras*. 2014;22(6):334–8. doi: 10.1590/1413-78522014220601004. [PubMed: 25538482].

# Comparison between the Classical Symphony and Self Selected Music on Muscle Endurance in Young Obese Males

V. Mahammad Rafi<sup>1</sup>, A. Sangeetha<sup>2</sup>, Adlin K. Kazia<sup>3</sup>, S. Prem Kumar<sup>4</sup>, B. Arun Kumar<sup>5</sup>, B. Vijayalakshmi<sup>6</sup>

<sup>1</sup>III M.Sc Medical Physiology, Saveetha Medical College, <sup>2</sup>Assistant Professor, Dept of Physiology, Saveetha Medical College, <sup>3</sup>III M.Sc Medical Physiology, Saveetha Medical College, <sup>4</sup>Associate Professor, Dept. of Physiology, Saveetha Medical College, <sup>5</sup>Assistant Professor, Dept of Physiology, JIPMER, Karaikal, <sup>6</sup>Professor and HOD, Dept. of Physiology, Saveetha Medical College

## Abstract

**Introduction:** Music captures attention, triggers a wide range of emotions, regulates mood and arousal, increases work output, induces states of higher functioning, reduces inhibitions and encourages rhythmic movement. Music has ergo-genic effect as well.

**Aim:** To evaluate the comparison between classical symphony music and self selected music on muscular endurance levels in young obese males.

**Materials and Method:** BMI assessment was performed for all participants and the 30 individuals falling under obese category were recruited in the study (BMI >30 Kg/m<sup>2</sup>). The participants were asked to listen to classical symphony music 15 min for 20 days, the muscle endurance test was done by Mosso's ergography and hand dynamometry. After a month the same participants were recalled. The participants were asked to listen to any music of their choice and were grouped under self-selected music. Muscle endurance test was done by hand dynamometry and Mosso's ergography method. Both the values of muscle endurance were compared by using independent paired t test and SPSS software statistical assessment tools were used.

**Result:** After using self-selected music the muscle endurance significantly increased using hand dynamometry (p<0.005) and Mosso's ergography (p<0.05).

**Conclusion:** There may be an improved functioning of neural system due to the influence music. Therefore, music may be used as an additional aid for obese individuals to maintain their skeletal muscle endurance during any physical activity and aerobic exercise

**Keywords:** Physical activity, Music, Mosso's ergography, Hand dynamometry.

## Introduction

Obesity is one of most neglected public health problems. Exercising helps to improve body composition and decrease body fat and body weight<sup>(1)</sup>. Nowadays

it has become a big concern for the youth of today's generation. Accumulation of fat has been classified as mild overweight (excess fat of 20% to 40%), moderate (41% to 100% overweight), and severe (over 100% overweight)<sup>(2)</sup>. It exposes the person to make health risk conditions like sudden death, diabetes of type 2, cardiovascular diseases, sleeplessness, depression and osteoarthritis. It can be a genetic problem or a disorder that is caused due to unhealthy lifestyle habits. Obesity results in sudden disturbance in physical activity as well as emotional disturbance and also a important cause for chronic health problems<sup>(2)</sup>. Music is an ergogenic aid. The common positive outcomes when combining music

---

### Corresponding Author:

**Dr. A. Sangeetha**

Assistant Professor, Department of Physiology,  
Saveetha Medical College and Hospitals, Thandalam  
e-mail: sangeethasrmc@yahoo.com  
Mobile: 9444686966

and exercise appear to be decreased ratings of perceived exertion, increased performance measures, improved mood and increased arousal<sup>(3)</sup>.

Karageorghis has indicated that music is used to alter psychomotor arousal and thus can act either as a stimulant or sedative. Music reduces a performer's attention therefore the person gets diverted from sensations of fatigue and tiredness and enhances the positive dimensions of mood like happiness, vigor and tempers anger, depression, tension<sup>(4)</sup>. Music plays a significant role in emotion, raises spirits, regulates mood<sup>(5)</sup>, evokes memories, increases work output and also induces states of higher functioning and reduces inhibitions. In sports science, there is evidence of a positive effect of music on grip strength and performances in other physical activities and other endurance<sup>(6)</sup> thus, music is a powerful key. Lack of sufficient physical activity is a significant factor for obesity. If there is a positive relationship between music and exercise performance (e.g., duration, intensity) the music could help to increase exercise adherence/reduce exercise dropout<sup>(7)</sup>.

The preferred music may facilitate focus on the music or other external stimuli rather than the discomforts that often accompany strenuous exercise. Thus, music also has the capability to evoke pleasant associations, possibly masking unpleasant stimuli or serve as a distraction to internal feelings associated with pain and discomfort<sup>(8)</sup>. There are studies explaining the differences in slow beat and fast beat music on physical activity but there no research comparing the different types of music.

Listening to music during strength workouts has become a very common practice. Listening to music induced a significant increase of strength endurance performance and no effects on maximal strength<sup>(8)</sup>. Musical preference reflects the level of arousal needed to perform certain tasks<sup>(9)</sup>. Specifically, when doing physically demanding work or exercise, choosing inspiring music that the person preferably enjoys is a worthy strategy to follow<sup>(10)</sup>. A study has tested the effects of fast, energizing music and slow, relaxing music played prior to handgrip dynamometer performance<sup>(11)</sup>. Slow asynchronous music (< 110 bpm) is generally inappropriate for exercise or training contexts unless used to limit effort exertion or as an auditory backdrop for warm-up/cool-down activities. It has also been proven that there was a positive-linear relationship between

exercise heart rate and music-tempo preference<sup>(12,13)</sup>.

Therefore, the present study was conducted to compare the effect of classical symphony (<110 bpm) and self-selected music on muscle endurance. The goal of the present study was to examine which music (self-selected and classical symphony) influences the level of exercise intensity and duration.

## Materials and Method

The cross sectional study was started after getting approval by institutional review board. Thirty one resistance-trained medical students were randomly selected and exposed to classical symphony music and self-selected music. The sample size was calculated based on the study by Bartolomei S et al<sup>(14)</sup>. After getting informed consent the study was carried out from April 2019 to July 2019. The study was conducted in Research lab, department of physiology, Saveetha medical college. The research lab was maintained with zero noise disturbances during the study.

The undergraduate students were identified from Saveetha Medical College aged 18–24years. Alcoholics, smokers, subjects with history of diabetes, hypertension and any student with musculoskeletal disorders were excluded. The procedures and benefits of the study were explained to the subjects, before starting each procedure. In this study only male participants were recruited as male has increased muscle mass compared to female. BMI assessment was done. The individuals falling under the obese (>30 Kg/m<sup>2</sup>) category were recruited in the study.

**Phase I:** During phase I classical symphony music was shared to the participants in MP4 format (<110 bpm) prior to the study period. The music selected by the participants were left to their own choice. There was no particular intensity or frequency to choose self-selected music. Participants were asked to listen to classical symphony music for a period of 15 min for 20 days using headphones with closed eyes in a closed room to avoid external deviation. Participants were allowed to listen to the respective music anytime during these days. They were asked to perform hand grip test and Mosso's Ergography after listening to the music on 20<sup>th</sup> day<sup>(15)</sup>. Endurance values were noted.

**Phase II:** The same participants were reassessed after a month and during this one month resting period the participants were allowed to have normal routine

life and not to listen to classical symphony music. They were asked to listen to self-selected music for period of 15 minutes for 20 days using headphones with closed eyes. On the 20<sup>th</sup> day the subjects were made to take muscle endurance test, using handgrip dynamometry & Mosso’s ergography The tests were done in the research lab, Physiology department and monitored keenly by the investigator in the research lab. The values of muscle endurance by classical symphony music and self-selected music recorded on 20<sup>th</sup> day of each group were compared among obese male subjects using independent paired T- test.

**Mosso’s Ergography test (joule):** Subject was made to sit comfortably and asked to insert the index and ring finger into the tube holders and to lift the load by maximal contraction of middle finger until the muscle undergo fatigue. For every 30 sec, 500gms of weight were added. Work done was recorded as graph. Using mosso’s ergography, formula used to calculate work done was  $W = F \times S$ . W= work done, [where F = load in kg, S = sum of the vertical amplitude] in each ergogram

**Hand grip test (kg):** Proper instructions were given to the subjects: arm should touch lateral side of the body, the forearm should keep in 90° then place the hand dynamometer in the participant’s hand and request the participant to squeeze to his maximum, the needle will automatically record the force (in Kg).

**Statistical Analysis:** The results for Hand grip test and Mosso’s ergography in obese individuals were compared before and after music using the independent samples T – test. Statistical significance was set at  $p < 0.05$  using SPSS software version 26.0 .

**Result**

The mean age of the participants was  $19.58 \pm 2.0$  years. Their mean BMI ( $\text{Kg/m}^2$ ) was  $33.4 \pm 1.94$ .

**Table 1: Hand Dynamometry: Comparison between Classical symphony music and Self selected music**

Parameter	Mean±SD	P –value
Classical symphony music	29.83±2.63	0.021
Self selected music	47.27±4.09	

Table 1 and 2 indicates the values resulted in Hand dynamometer ( $p < 0.021$ ) and Mosso’s ergography (0.003) respectively. These results clearly show that

the work done improved after listening to self-selected music compared to classical symphony music.

**Table 2: Mosso’s Ergography: Comparison between Classical symphony music and Self-selected music**

Parameter	Mean±SD	P –value
Classical symphony music	239.2±34.39	0.003
Self-selected music	330.35±20.75	

**Discussion**

The present study sought to examine the effects of different kinds of music on the exercise performance on muscle endurance in young obesity male subjects. Specifically, two different types of music were examined: self-selected (SSM) music, and classical (CSM) music. Many authors have indicated that overweight and obesity, expressed by the Body Mass Index (BMI), negatively influence the level of endurance-strength abilities.<sup>(4,16,17)</sup>

Survey-based data revealed that musical rhythm has a generic stimulative effect on the human organism irrespective of any synchronisation. Hence, in addition to activating few neural structures of brain in a periodic way in order to promote rhythmical movement, music may also cause significant stimulation of those parts of the brain that regulates arousal, namely the limbic and reticular activating systems<sup>(17)</sup>. Previous research suggests that exercise performance and duration can be influenced for at least two reasons: i) It is possible that the self-selected music provides higher levels of state motivation, thereby increasing exercise performance and endurance in the SSM as opposed to the CM conditions. ii) Listening to motivational music can help the exerciser experience more dissociative thoughts, taking the focus off of the potential discomfort of exercise and internal cues (e.g., self-talk).<sup>(18)</sup>

Several neural mechanisms may explain the ergogenic impact of music on short- term maximal exercise<sup>(19,20)</sup>. The present have used two method to measure muscle endurance in the young male subjects hand dynamometry and Mosso’s ergography. Like a previous study, using mosso’s ergography, subjects were asked to lift from low weight (500gms) to high weight (4000gms) by the middle finger maximal contraction until the subjects gets fatigue<sup>(21)</sup>. Some studies suggest that the introduction of music has a psychobiological impact on the exerciser demonstrated by changes in perceived muscle endurance<sup>(22)</sup>.

The amount of physical activity performed overall, as well as the physiological response to the exercise, increased with exercise duration, in order to improve the benefits of exercise<sup>(23,24)</sup>. The present study also indicated that self-selected music has showed significant increase in muscle endurance. Energy and tiredness are often cited as reasons for why people don't exercise. However, exercise has a positive impact on both dimensions of affect. The present study showed significant increase in energy immediately following exercise.

There are numerous evidences to suggest that music, particularly high tempo, can have a positive impact on sporting performance particularly on muscular exercises. However, this has primarily been demonstrated in endurance based exercise rather than fine motor control activities<sup>(25-27)</sup>. It is interesting to note that performances were greatest in the present study when listening to self-selected music.

Negative aspects of affect, such as high levels of stress and tension, are often associated with an overall lack of well-being, decreasing feelings of tension and stress is an important aspect of regulating affect and mood disorders by listening music<sup>(28)</sup>. A study has demonstrated increased performance during an explosive exercise and an altered mood state when listening to self-selected music<sup>(5)</sup>. Therefore, listening to SSM might be beneficial for acute power performance. The current results showed significant changes in feelings of stress, tensions especially muscle endurance performance.

**Limitations:** The study population was chosen in a random manner and there are chances of bias. Only two types of music were compared to see the effect of muscle endurance. The work could be further extended with various types of music. The individual differences within the group and group differences were not done. The music intensity and frequency was not exactly fixed as they were asked to listen to self-selected music. The study can be further extended to compare the effect of degree of music on muscle endurance.

### Conclusion

In light of this study finding, music can be used as an additional aid for obese individuals to improve their skeletal muscle endurance during any physical activity. As well as the music helps to change mood out & stress etc. Our research confirmed also the self selected music is the best one when compared to classical symphony music.

**Ethical Clearance:** The study was conducted after getting approval from institutional review board (SMC/IEC/2018/11/253)

**Conflict of Interest:** Nil

**Source of Funding:** Self funding

### References

1. Ismail, M. The Effects of Mixed Exercise (ABOXERCISE) on Cardiovascular Endurance, Muscular Endurance and BMI level in 30-to 40-Year-Old Obese Males. *Pertanika Journal of Social Sciences & Humanities*, 2018; 26(3), 1519 - 1527.
2. Booth FW, Roberts CK, Laye MJ. Lack of exercise is a major cause of chronic diseases. *Compr Physiol*. 2012; 2(2), 1143-1211.
3. Matthew S. Biagini Effects of self-selected music on strength, explosiveness, and mood *Journal of Strength and Conditioning Research*, 2012; 26(7),1934-1938.
4. Jarraya, M., Chtourou, H., Aloui, A., Hammouda, O., Chamari, K., Chaouachi, A., & Souissi, N, et al. The effects of music on high-intensity short-term exercise in well trained athletes. *Asian journal of sports medicine*, 2012; 3(4), 233.
5. Biagini, M. S., Brown, L. E., Coburn, J. W., Judelson, D. A., Statler, T. A., Bottaro, M & Longo, N. A, et al Effects of self-selected music on strength, explosiveness, and mood. *The Journal of Strength & Conditioning Research*, 2012; 26(7), 1934-1938.
6. Van den Elzen N, Daman V, Duijkers M, et al. The Power of Music: Enhancing Muscle Strength in Older People. *Healthcare (Basel)*. 2019; 7(3): 82
7. Baldari, C., Macone, D., Bonavolontà, V., & Guidetti, L. Effects of music during exercise in different training status. *The Journal of sports medicine and physical fitness*, 2010;50(3), 281-287.
8. Boutcher, S. H., & Trenske, M. The effects of sensory deprivation and music on perceived exertion and affect during exercise. *Journal of Sport and Exercise Psychology*, 1990;12;167-176.
9. North, A.C. and Hargreaves, D.J. Musical preferences during and after relaxation and exercise. *American Journal of Psychology*, 2000;113(1), 43-67.



10. Crust, L. Carry-over effects of music in an isometric muscular endurance task. *Perceptual Motor Skills*, 2004;98 (3 Pt 1), 985-991.
11. Karageorghis, C. I., Drew, K. M., & Terry, P. C. Effects of pretest stimulative and sedative music on grip strength. *Perceptual and Motor Skills*, 1996;83, 1347-1352.
12. Iwanaga, I. Relationship between heart rate and preference for tempo of music. *Perceptual and Motor Skills*, 1996a; 81, 435-440.
13. Iwanaga, I. Harmonic relationship between preferred tempi and heart rate. *Perceptual and Motor Skills*, 1996b; 81, 67-71.
14. Bartolomei S, Di Michele R, Merni F. Effects of self-selected music on maximal bench press strength and strength endurance. *Percept Mot Skills*.2015; 120(3), 714- 721.
15. Eliakim, M., Meckel, Y., Nemet, D., & Eliakim, A. The effect of music during warm-up on consecutive anaerobic performance in elite adolescent volleyball players. *International journal of sports medicine*. 2007; 28(04), 321-325.
16. Rafi, V. M., Sangeetha, A., & Vijayalakshmi, B. Effect of classical symphony music on muscular endurance in young obese males. *International Journal of Medical Research and Pharmaceutical Sciences*. 2019;6 (6);1-6.
17. Stork, M. J., & Martin Ginis, K. A. Listening to music during sprint interval exercise: The impact on exercise attitudes and intentions. *Journal of sports sciences*.2017;35(19);1940-1946.
18. Stork, M. J. . Staying 'onbeat' with interval training: the effects of music on exercise enjoyment and performance during sprint interval training. 2014; (Doctoral dissertation).
19. Chtourou, H., Jarraya, M., Aloui, A., Hammouda, O., & Souissi, N. . The effects of music during warm-up on anaerobic performances of young sprinters. *Science & Sports*. 2012;27(6);e85-e88.
20. Di Meo, S., Iossa, S., & Venditti, P. Improvement of obesity-linked skeletal muscle insulin resistance by strength and endurance training. *Journal of Endocrinology*.2017;234(3);R159-R181.
21. Giulio, C. D., Daniele, F., & Tipton, C. M. Angelo Mosso and muscular fatigue: 116 years after the first Congress of Physiologists: IUPS commemoration. *Advances in physiology education*.2006;30(2), 51-57.
22. Mayer, J. M., Nuzzo, J. L., Chen, R., Quillen, W. S., Verna, J. L., Miro, R., & Dagenais, S. The impact of obesity on back and core muscular endurance in firefighters. *Journal of obesity*, 2012.
23. Atan, T. Effect of music on anaerobic exercise performance. *Biology of sport*, 2013;30(1), 35.
24. Waterhouse, J., Hudson, P., & Edwards, B.. Effects of music tempo upon submaximal cycling performance. *Scandinavian journal of medicine & science in sports*. 2010;20(4), 662-669.
25. Nethery VM Competition between internal and external sources of information during exercise: influence on RPE and the impact of the exercise load. *J Sports Med Phys Fitness* 2002;42, 172-178.
26. Potteiger JA, Schroeder JM, Goff KL Influence of music on ratings of perceived exertion during 20 minutes of moderate intensity exercise. *Percept Mot Skills* 2000;91, 848-854.
27. Szmedra L, Bacharach DW Effect of music on perceived exertion, plasma lactate, norepinephrine and cardiovascular hemodynamics during treadmill running. *Int J Sports Med* 1998;19, 32-37.
28. Shields, M. C. Physical Activity Predicts Emotion-Context-Sensitivity 2014 Doctoral dissertation, Kent State University.

# Factors Affecting Romantic Relationship Satisfaction of University Students

Kyu Eun Lee<sup>1</sup>, Hae Kyung Chang<sup>2</sup>

<sup>1</sup>Professor, Department of Nursing, Catholic Kwandong University, Republic of Korea,

<sup>2</sup>Professor, Department of Nursing, Hanseo University, Republic of Korea

## Abstract

**Background/Objectives:** The purpose of this study was to identify the factors affecting romantic relationship satisfaction of university students.

**Method/Statistical analysis:** This study was conducted with 187 students from four universities in cities and provinces nationwide. Data were collected from September to October 2019 using a self-administered questionnaire. Collected data were analyzed through the stepwise regression analysis using the SPSS statistics program.

**Findings:** The final regression model showed that self-esteem, anxiety attachment, and avoidance attachment were significant predictors related to romantic relationship satisfaction in university students and explained 34.7% of the variance in romantic relationship satisfaction.

**Improvements/Applications:** The university student period is a time to form an adult attachment, thereby preparing for a happy marriage in the future by increasing the romantic relationship satisfaction. Therefore, it is necessary to develop and apply the educational programs that can increase self-esteem and positive heterosexual relationship for university students.

**Keywords:** *University students, sexual attachment, sexual attitude, self-esteem, romantic relationship satisfaction.*

## Introduction

The time in university is a transitional stage from adolescence to adulthood<sup>[1]</sup>, and it can be seen in the three main area of identity exploration: love, work, and worldviews which is the late period of adolescence and early period adulthood<sup>[2]</sup>. In Korea, many young people begin to date only after entering university<sup>[3]</sup>. A satisfactory experience through the romantic relationship with a partner enhances an individual's psychological

health and level of happiness, allows them to feel positive emotions, and influences the development of positive self-concept<sup>[4]</sup>. Romantic relationship satisfaction refers to the subjective evaluation, attitude, and positive feelings about relationships<sup>[5]</sup>, and attachment is one of key factors related to relationship satisfaction<sup>[6]</sup>.

Adult attachment is the result of a process in which the attachment target shifts from the primary caregiver to friends and lovers as an individual enters into adulthood<sup>[7]</sup>. For university students in the emerging adulthood, who are in the process of forming adult attachment, the experience of healthy romantic relationship is important in itself. In particular, individuals with stable attachment in relationships with partners have displayed positive characteristics such as confidence, happiness, and constructive approaches toward relationship conflicts, while individuals with high levels of attachment anxiety

---

### Corresponding Author:

**Hae Kyung Chang**

Professor, Department of Nursing, Hanseo University,  
Republic of Korea

e-mail: hkchang@hanseo.ac.kr

and avoidance showed negative characteristics such as discomfort, jealousy, etc., in their relationships<sup>[7,8]</sup>. Therefore, in order for unmarried men and women to maintain a satisfactory relationship with the opposite sex, the sexual aspect must be considered, and for this, an individual's attitude toward sex is important.

Sexual attitude is one's own cognitive perspective on an individual's sexual aspect, is formed through sexual behaviors, and enables individuals to determine current and future sexual behavior based on it<sup>[9]</sup>. Positive sexual attitudes not only affect personality maturity, but also premarital and post marital sex life<sup>[10]</sup>.

Self-esteem, meanwhile, is a key factor in determining an individual's behavior and adaptation, and it is essential for the healthy sexual function in romantic relationships<sup>[11]</sup>. Specifically, Lee's study<sup>[12]</sup>, which finds that teenagers with low self-esteem are more exposed to unwanted sex, suggests that self-esteem is related to satisfaction in relationships. Prior studies in Korea frequently show that sexual attitude affects satisfaction in relationships, but the direction of the influence is different. Although the results are inconsistent, it is clear that sexual attitude is correlated with relationship satisfaction<sup>[13]</sup>. In addition, there are studies on adult attachment and satisfaction with romantic relationship, but there is a only of handful of research on the mechanism. Moreover, there is no research on an integrated approach to the factors affecting the satisfaction of relationships among university students. Therefore, this study aims to provide the necessary basic data to establish healthy romantic relationships and appropriate sexual attitudes of university students by identifying the determinants in relationship satisfaction of university students using variables of various aspects.

## Method

**Subjects:** The subjects of this study were students of universities located in four cities and provinces in Korea and were convenient-sampled to male and female university students with dating experience. Using G\*Power 3.12, the sample size of the study was set to be 160, where the median size effect is 0.15, a significance level is 0.05, and the number of predictor variables is 8, to secure 95% of the statistical power for regression analysis. Therefore, in this study, a total of 187 questionnaires were included in the final analysis after distributing the questionnaire to 192 people considering the dropout rate of 20%.

## Tools:

**Adult Attachment:** The Experience in Close Relationship (ECRS), developed by Brennan et al.<sup>[14]</sup>, was used. Adult attachment measurement tools consist of two areas: 18 questions for avoidance attachment and 18 questions for anxiety attachment. The higher the score on a 5-point scale of 36 questions, the higher the avoidance attachment and anxiety attachment. In this study, Cronbach's  $\alpha$  were found to be 0.74 (avoidance attachment), 0.87 (anxiety attachment), and 0.83 overall

**Sexual Attitude:** The sexual attitude measurement tool developed by Woo<sup>[10]</sup> was used. The tool was comprised of 35 questions with a 5-point scale. A higher score means a more open sex attitude, and a lower score means a more conservative sex attitude. Cronbach's  $\alpha$  in this study was found to be 0.74

**Self-esteem:** The self-esteem measurement tool developed by Rosenberg<sup>[15]</sup> was used. The self-esteem measurement tool consists of 10 questions with a 5-point scale. A higher score means a higher degree of self-esteem. Cronbach's  $\alpha$  in this study was found to be 0.82

**Romantic relationship satisfaction:** The romantic relationship satisfaction measurement tool developed by Lee<sup>[16]</sup> was used. The tool consists of 41 questions with a 5-point scale. A higher score means higher romantic relationship satisfaction. Cronbach's  $\alpha$  in this study was found to be 0.92.

**Data collection:** For the data collection, universities located in four different regions across the country from September 9 to October 31, 2019 were randomly selected. Through a research assistant at each local university, the purpose and method of the study were explained to the study subjects, and written consents from the subjects who exhibited voluntary participation were received. The research assistants explained that the collected data would not be disclosed or used for any purpose other than research, that the subject's personal information would be kept confidential and guarantee anonymity, and that the subject could stop participating in the research at any time if desired. The data were collected using structured questionnaires and it took 10~15 minutes to complete the questionnaire.

**Ethical Considerations:** This study was conducted after receiving research approval from the Institutional Review Board (IRB) of University C to project the subjects in prior to conducting the study (IRB No: CKU-19-01-0207)

**Data Analysis Method:** The collected data were processed by computer statistics using SPSS/WIN 22.0 program. Descriptive statistics for the general characteristics and variables of the subjects were obtained. The difference in Romantic relationship satisfaction level was determined according to general characteristics t-test, ANOVA, and post-test Scheffé test. The correlation between the Romantic relationship satisfaction and the variables was analyzed by Pearson’s correlation coefficient. In addition, in order to identify factors affecting the Romantic relationship satisfaction, it was analyzed by stepwise multiple regression after multicollinearity diagnosis.

## Result

**General characteristics of subjects:** Mean age of the subjects was 21.03(±2.06) years old and 20 to 29 years old group was the most among these with 134 persons (71.7%). The distributions of the gender were 95 male (50.8%), 92 female (49.2%). There were 1<sup>st</sup> 55(29.4%), 2<sup>nd</sup> 41(21.9%), 3<sup>rd</sup> 39(20.9%) and 4<sup>th</sup> 52(27.8%) in the Grade. Residence was living alone 82(43.9%), dormitory 72(38.5%) (Table 1).

**Table 1. General Characteristics and Difference in Degree of Romantic Relationship Satisfaction according to General Characteristics**

Characteristics	Categories	n(%) M±SD	Romantic relationship satisfaction			
			M±SD	t/F	p	Scheffé
Age	Teens (10’s)	53(28.3)	2.60±0.52	0.09	.929	
	Twenties (20’s)	134(71.7)	2.59±0.52			
			21.03±2.06			
Gender	Male	95(50.8)	2.53±0.54	-1.73	.085	
	Female	92(49.2)	2.66±0.50			
Grade	1 <sup>st</sup>	55(29.4)	2.56±0.49	2.42	.067	
	2 <sup>nd</sup>	41(21.9)	2.76±0.45			
	3 <sup>rd</sup>	39(20.9)	2.62±0.55			
	4 <sup>th</sup>	52(27.8)	2.48±0.56			
Residence	Home	31(16.6)	2.60±0.47	0.38	.767	
	Dormitory	72(38.5)	2.64±0.48			
	Living alone	82(43.9)	2.56±0.55			
	Etc.	2(1.1)	2.44±1.28			

**Descriptive statistics of the study variables:** Attachment averaged 2.78(±058). In addition, the average sexual attitude was 3.04 (±0.36), and the self-esteem was 3.66 (±0.62) (Table 2).

**Table 2. Descriptive Statistics of the Study Variables**

Variables	Mean	SD	Min	Max
Avoidance attachment	2.73	0.44	1.33	3.72
Anxiety attachment	2.78	0.58	1.28	4.67
Sexual attitude	3.04	0.36	1.46	4.43
Self-esteem	3.66	0.62	1.30	4.90
Romantic relationship satisfaction	2.59	0.52	1.27	4.24

**Difference in degree of romantic relationship satisfaction according to general characteristics:** The degree of romantic relationship satisfaction was non-significantly different according to general characteristics (Table 1).

**Correlation between romantic relationship satisfaction and variables:** The degree of romantic relationship satisfaction of the subjects was positively

correlated with self-esteem ( $r=0.53$ ,  $p<0.001$ ) and negatively correlated with avoidance attachment ( $r=-0.40$ ,  $p<0.001$ ), anxiety attachment ( $r=-0.42$ ,  $p=0.008$ ), and sex attitude ( $r=-0.19$ ,  $p=0.008$ ). In other words, a higher degree of self-esteem, lower avoidance and anxiety attachment, and more conservative sexual attitudes all led to higher satisfaction in romantic relationships (Table 3).

**Table 3. Correlations Coefficient among the Variables**

Variables	Avoidance attachment	Anxiety attachment	Sexual attitude	Self-esteem
	r (p)	r (p)	r (p)	r (p)
Romantic relationship satisfaction	-0.40 ( $<.001$ )	-0.42 ( $<.001$ )	-0.19 (.008)	.53 ( $<.001$ )

**Influencing factors on romantic relationship satisfaction:** As a result of verifying the multicollinearity before performing regression analysis, the variance expansion index (VIF) among the variables is 1.140 to 1.561, which is less than 10, which can be considered free of autocorrelation. In addition, the Durbin-Watson statistic that confirms the independence among the error terms was found to be 1.594, which satisfies the assumption of independence. A total of four independent

variables were used to identify the determinants of romantic relationship satisfaction: adult attachment (avoidance attachment and anxiety attachment), sexual attitude, and self-esteem. The stepwise regression analysis results are as follows: self-esteem ( $\beta=0.330$ ,  $p<0.001$ ), anxiety attachment ( $\beta=-0.237$ ,  $p<0.001$ ), and avoidance attachment ( $\beta=-0.209$ ,  $p=0.002$ ). The exploratory power of the three variables 34.7%, and the most influential variable was self-esteem (Table 4).

**Table 4. Influencing Factors on Romantic Relationship Satisfaction**

Variables	B	$\beta$	t	p
Intercept	-2.334		-5.371	$<.001$
Self-esteem	.275	.330	4.574	$<.001$
Anxiety Attachment	-.213	-.237	-3.601	$<.001$
Avoidance Attachment	-.246	-.209	-3.166	.002
F = 33.875, $p < .001$ , Adj R2 = .347				

**Discussion**

In this study, the romantic relationship satisfaction level of the university students was 2.59 points on a scale within a range from 1 to 5. This score was lower than the average of 3.47 points of the local university students, which was measured with the identical measurement tool<sup>[17]</sup>.

As a result of examining the correlation between university students' romantic relationship satisfaction and their variables, it was found that adult attachment had a negative correlation with romantic relationship satisfaction. This result is consistent with Choi and Kim<sup>[17]</sup> and Yildiz, Cokamay, and Artar<sup>[18]</sup>. In general, the two dimensions of adult attachment, avoidance attachment and anxiety attachment, are viewed

as unstable attachment, and there tend to be more relationship problems as the degree of adult attachment grows stronger<sup>[19]</sup>. Anxiety attachment in this study had a stronger negative correlation with romantic relationship satisfaction than did avoidance attachment, which is similar to the results in the previous literature<sup>[17]</sup>.

People with high anxiety attachment tend to focus on their stress, reflect on negative thoughts, and emotion-centered coping strategies. On the other hand, those with a high level of avoidance attachment use strategies that cognitively and behaviorally distance themselves from the cause of stress<sup>[20]</sup>.

The university students' sexual attitude and romantic relationship satisfaction were found to have a negative correlation, which was consistent with the prior result of Hendrick, Hendrick, and Reich<sup>[21]</sup> that more conservative sexual attitude leads to higher romantic relationship satisfaction. Conversely, a study of unmarried men and women with sexual experience reports a significant positive correlation between sexual consciousness and romantic relationship satisfaction<sup>[13]</sup>, showing no consistency in the correlation between sexual attitude and romantic relationship satisfaction. In the future, if one establishes a strategy to maintain a satisfactory relationship by identifying the attitude of individuals, he or she will be able to increase satisfaction on the relationship.

Furthermore, romantic relationship satisfaction is higher in the group with high self-esteem<sup>[22]</sup>, which is consistent with the results of this study. Through these results, one will be able to enhance romantic relationship satisfaction by turning negative sexual attitude into positive sexual attitude when establishing a strategy to maintain a satisfactory romantic relationship.

After analyzing the effects on romantic relationship satisfaction in the study, self-esteem, ( $\beta=0.330$ ,  $p<0.001$ ), anxiety attachment ( $\beta=-0.237$ ,  $p<0.001$ ), and ( $\beta=-0.209$ ,  $p=0.002$ ) explain 34.7% of romantic relationship satisfaction. Among them, self-esteem was the most influential variable on relationship satisfaction. It can be interpreted that those who love themselves and feel valued maintain satisfactory relationships with their partners<sup>[23]</sup>. There are several factors in the characteristics which people with low self-esteem exhibit in relationships. First, they need more acceptance and incorrectly perceive others' attitude. These people believe that they need to live up to the specific standards

they have set for themselves or need to have valuable traits to be loved and accepted by important people, so they underestimate the positive attitudes their partners have toward themselves or evaluate less of their partners' attitude<sup>[11]</sup>. If the partner's continued acceptance is suspected, he or she could distance himself or herself from the partner, devalue romantic relationships, be unnecessarily disappointed in them, and end the relationship in dissatisfaction<sup>[24]</sup>.

Anxiety and avoidance attachment, which are forms of unstable attachment among adult attachments, were the second and third factors that explained the relationship satisfaction of the university students. Hazan and Shaver<sup>[7]</sup> argue that adult attachment is the one of the most well-known variables in predicting relationship satisfaction and is related with romantic relationships in adulthood. Their findings demonstrate that positive emotions as happiness and trust are usually reported in relationships in the case of stable attachment, whereas instable attachment types such as avoidance or anxiety feel a lot of negative emotions such as discomfort or jealousy in relationships.

The overall results suggest that it is necessary for university students, in order to improve the romantic relationship satisfaction, to have a positive and active life attitude toward their own lives so that they can establish positive sexual attitudes and enhance their self-esteem.

## Conclusions

In this study, self-esteem, anxiety attachment, and avoidance attachment were significant predictors that influence university students' romantic relationship satisfaction and the three variables' explanatory power was 34.7%. Based on these results, it is necessary for university students to develop a sense of self-respect and experience the process of exchanging positive feelings with their partners in order to improve their satisfaction with romantic relationships.

This study is meaningful in that it takes account sexual attachment variables, a new concept in nursing, into account to provide nursing intervention to enhance healthy relationship satisfaction of university students.

**Ethical Clearance:** Not required

**Source of Funding:** Self

**Conflict of Interest:** Nil

## References

1. Koh MJ, Song MK. The relationship between insecure adult attachment and romantic relationship satisfaction of university students: the mediating effect of avoidant-restrictive emotion regulation style. *J EmotBehav.* 2017;33(1):1-21.
2. Arnett JJ. Emerging adulthood: a theory of development from the late teens through the twenties. *AmPsychol.* 2000; 5(55): 469-480.
3. Seong JA, Hong HY. The effect of insecure adult attachment on fear of intimacy in the romantic relationships of early adulthood: the mediating effect of rejection sensitivity and self-disclosure. *The Korean Journal of Counseling and Psychotherapy.* 2014;26 (2):387-412.
4. Na HK. The mediating effect of emotional clarity on the relationship between relationship uncertainty and satisfaction of romantic relationship. [Master's Thesis]. EwhaWomans University, Seoul; 2018.
5. Fletcher GJ, SimpsonJA, Campbell L, Overall, NC. Pair-bonding, romantic love, and evolution the curious case of homo sapiens. *Perspect Psychol Sci.* 2015 Jan;10(1):20-36. <https://doi.org/10.1177/1745691614561683>
6. Kim MS. The relationship satisfaction level of romantic couples according to adult attachment styles. *Korean Journal of Social and Personality Psychology.* 2008;22 (2):59-74.
7. Hazen C, Shaver P. Romantic love conceptualized as an attachment process. *JPersSoc Psychol.* 1987;52(3):511-524.
8. Kazan D, Calear AL, Batterham PJ. The impact of intimate partner relationships on suicidal thoughts and behaviors: a systematic review. *J AffectDisord.* 2016 Jan 15;190:585-598.
9. Luster SS, Nelson LJ, Poulsen FO, Willoughby BJ. Emerging adult sexual attitudes and behaviors: does shyness matter?. *Emerging Adulthood.* 2013;1(3):185-195. <https://doi.org/10.1177/2167696813475611>
10. Woo GH. Sexual knowledge, attitude and sexual behavior of university students. [Master's Thesis]. Gong Ju University, Gongju; 2011.
11. Erol RY, Orth U. Development of self-esteem and relationship satisfaction in couples: two longitudinal studies. *Development Psychology.* 2014;50:2291-2303. <https://doi.org/10.1037/a0037370>
12. Lee SK. Relationship between the level of sexual contacts and self-esteem, self-assertiveness of teenage girls who have or had boyfriend. *Korean J Women Health Nurs.* 2001;7(2):212-228.
13. Bae YJ, Lim S. Mediating effects of consensual unwanted sexual behavior and sexual consciousness in adult attachment and heterosexual satisfaction of Korean unmarried men and women. *Asia-pacific Journal of Multimedia Services Convergent with Art, Humanities, and Sociology(AJMAHS).* 2018;8(9): 691-702.
14. Brennan KA, Clark CL, Shaver PR. Self-report measurement of adult attachment: an integrative overview. In Simpson JA, Rholes WS(Eds.). *Attachment theory and close relationships.* New York: Guilford Press; 1998.
15. Rosenberg M. *Society and adolescent self-image.* Princeton University Press, Princeton, NJ;1965.
16. Lee BD. Adult attachment and satisfaction of heterosexual relations: focusing on the mediating effect of rejection sensitivity and attribution style. [Master's Thesis]. Korea University, Seoul;2000.
17. Choi M, Kim H. The effect of university students' adult attachment on the satisfaction of romantic relationship: mediating effect of the emotional dysregulation. *Journal of Rehabilitation Psychology.* 2019;26(3):3-87.
18. Yildiz AD, Cokamay G, Artar M. Romantic relationship satisfaction levels of female university students in Turkey: examining through attachment dimensions, perceived abuse in relationship and future time orientation of relationship. *Bartın University Journal of Faculty of Education.*2017;6(1):365-384. <https://doi.org/10.14686/buefad.285018>
19. Fraley RC, Shaver PR. Adult romantic attachment: theoretical developments, emerging controversies, and unanswered questions. *RevGen Psycho.* 2000;4:132-154. <https://doi.org/10.1037/1089-2680.4.2.132>
20. Shaver P, Mikulincer M. Attachment-related psychodynamics. *AttachHum Dev.* 2002; (2):133-161.
21. Hendrick C, Hendrick SS, Reich D A. The brief sexual attitudes scale. *JSex Res.*2006;43:76-86. <https://doi.org/10.1080/00224490609552301>
22. Choi EJ. The influence university student'adult attachment on their satisfaction with romantic relationship: mediating effects of self-esteem.

- [Master's Thesis]. Pyeongtaek University, Pyeongtaek; 2015.
23. Eom H, Chung H. Effect of primary triad experience on self-esteem and dating relationship dissatisfaction among university-students. *Family and Environment Research*. 2006; 44(2): 137-152.
24. Murray SL, Holmes J, Griffin DW. Self-esteem and the quest for felt security: How perceived regard regulates attachment processes. *J Pers Soc Psychol*, 2000;78:478-498.



# Non-Invasive Monitoring of Blood Glucose Concentration Based on Insulin Secretion Level Using NIR Spectroscopy for Diabetes Detection

D. Arul Kumar<sup>1</sup>, T. Jayanthi<sup>2</sup>

<sup>1</sup>Research Scholar, Department of Electronics and Communication Engineering, Sathyabama Institute of Science and Technology, Chennai, India, <sup>2</sup>Principal, Panimalar Institute of Technology, Chennai, India

## Abstract

Diabetes claims millions of lives every year. Diabetes Mellitus is a metabolic disorder that occurs due to the increase in blood sugar level. The blood sugar level control by insulin secreted from pancreas. The diabetes classify as type 1 and type 2 depending on insulin secretion. The type 2 diabetes is more common in people than type 1 diabetes. Traditionally, the blood glucose level estimate with glucometer and blood test. However, the test require invasive blood pricking for blood glucose measurement. The measured blood glucose value also varies due to amount of blood taken for testing, part of blood used for testing, depth of finger pricking, physical activity, stress and underlying illness. Hence, the insulin secretion from pancreas monitor for accurate prediction of blood glucose level. The blood glucose level varies with respect to insulin secretion from pancreas. In this paper, we propose a non-invasive approach to estimate blood glucose accurately through NIR spectroscopy for diabetes control. The NIR spectroscopy signal obtained from pancreas process through Rational Dilation Wavelet Transform to determine the insulin secretion level. The non-invasive NIR spectroscopy method measures glucose level with 90% accuracy compared to lab results.

**Keywords:** Type 2 Diabetes, RADWT, NIR spectroscopy, Insulin.

## Introduction

Diabetes mellitus characterizes by the abnormal increase of sugar level in the blood. When the glucose level in the blood increases, it induces the insulin release from the pancreas. Insulin causes fat cells and muscle to remove glucose from the blood and causes the liver to metabolize glucose and thus reduce blood sugar to normal levels. People with diabetes have high levels of blood sugar since, pancreas does not produce insulin. The diabetic person have minimal count of  $\beta$ -cells in pancreas which secretes low insulin.

The most general forms of diabetes are type 1, type 2 diabetes, and gestational diabetes. The type 1 diabetes is an autoimmune disorder where, the body attacks the pancreas making it unable to produce insulin resulting in minimal insulin secretion. The type 2 diabetes cause due to factors such as metabolic disorders, age, overweight, obesity, physical inactivity and unhealthy food consumption. The  $\beta$  cell in pancreas produce insufficient insulin coupled with organ resistance to insulin and

result in high blood glucose level. The gestational diabetes occurs during pregnancy.

Currently, the blood glucose level control by medication and insulin injection coupled with diet control and physical activity. The blood glucose level determine by blood test or glucometer. The first introduced blood glucose meter was Ames Reflectance Meter. The Ames Reflectance Meter enables diabetic patients to monitor the blood glucose levels themselves. Reflomat is another portable and compact blood glucose meter designed for health care professionals. The Reflomat requires only a small amount of blood to determine blood glucose level. The foresaid meter needs extraction of blood samples through fingertip pricking, ear pricking. The blood glucose monitoring require taking test for up to 4 times every day. Therefore, continuously pricking of finger, ear for blood to determine blood glucose level may cause infection, and calcified nodules. The blood sugar level estimated by glucometer are inaccurate due to damaged blood cells. Further, the frequent skin pricking

is uncomfortable, inconvenient and cause skin irritation. Hence, precise, convenient, safe and comfortable blood glucose measurement method is required.

The blood glucose also measure by non-invasive method. The polarization change is the first introduced non-invasive technique where combination of helium and neon based laser light is coupled to a linear polarizer and the phase matches with the rotation vector is relative to glucose.

Raman Spectroscopy can detect low frequency modes. A Surface Enhanced Raman Spectroscopy (SERS) detects the interaction between glucose molecules and SERS active surface. The monochromatic light on molecule result in photon energy shift. The energy shift of photon is proportional to molecular bond vibration. The molecular vibration have specific Raman spectrum band. The spectrum band features vary for different molecules such as glucose.

Fluorescent spectroscopy is an electromagnetic spectroscopy technique that can analyze a sample's fluorescence. Fluorescent Spectroscopy utilizes visible light spectrum, to detect energy emitted at different wavelength from glucose molecule. Near-Infrared (NIR) spectroscopy employs near-infrared light of wavelength 780-2500nm. In NIR spectroscopy, glucose level estimates with respect to the variations in the light intensity. Mid-Infrared (MIR) spectroscopy is developed from NIR spectroscopy that utilizes the near infrared light of wavelength 2500-10000nm. MIR spectroscopy is sharper and does not penetrate through the skin effectively. Absorption spectroscopy in the infrared (IR) region is a significant technique for finding unidentified biological substances in aqueous solutions. The technique is based on the process that every molecule has particular resonant absorption peaks. These peaks are caused by molecule's rotational and vibrational oscillations.

**Literature Survey:** Non-invasive blood glucose monitoring perform through in vitro and in vivo analysis of Differential Continuous Wave Photo Acoustic Spectroscopy (DCW-PAS). The DCW-PAS approach uses amplitude modulation with dual wavelengths of light to identify glucose concentration level. The analysis compares DCW-PAS evaluations including results from invasive blood glucose sensor evaluations of healthy people's Oral Glucose Tolerance Tests (OGTTs). The blood glucose level estimation from photo-acoustic

signal and invasive sensors have good correlation. [1]

The blood glucose level measure with plasmonic sensor made of barium flint glass, gold film and silicon nitride ( $\text{Si}_3\text{N}_4$ ) substrate. The plasmonic sensor rejects infrared wavelength on normal incidence because of coupling between plasmonic wave and incident plane wave. The impact of glucose concentration or ambient refraction analyze for plasmonic structure sensitivity to blood glucose. [2]

A Spoof Surface Plasmon Polariton (SSPP) endfire sensor monitors aqueous glucose solutions and measures on-body glucose. The SSPP endfire sensor radiates an endfire beam into a glucose water solution with minimal effective aperture. At the sensor's CPW port, a set of triangular ground planes suppresses the side-lobes and limit glucose sensing. The SSPP endfire sensor's slow wave nature provides the way for measuring glucose concentrations with enhanced sensitivity. [3]

Non-invasive blood glucose monitoring offers an effective solution to diagnose patients with diabetes the glucose response characterize at low Radio Frequency (RF) signals. The relative permittivity and conductivity of aqueous solutions obtain for various glucose concentrations using an impedance analyzer in the frequency range 1 KHz to 1MHz. Further, the blood impedance measure for glucose monitoring the bio-impedance, measure from forearm during cardiac cycle with polygraph at 1000 Hz. The difference in bio impedance evaluate for cardiac cycle. The influence of blood glucose concentration on bio impedance evaluate to remove tissue influence on blood glucose concentration. [4]

The design of a microwave sensor for non-invasive monitoring of blood glucose concentration is presented. Three distinct microwave resonator structures analyze as suitable candidates. The microwave resonator has an open structure to place patient's finger. The finger's shape and size should fit in the resonator. The variation in blood glucose concentration alters the tissue's dielectric properties and changes the structure's resonant frequency. [5]

A combined millimeter-wave radar system detects various glucose concentration levels of duplicate blood samples made in the laboratory. The mm-wave radar non-invasively monitors blood glucose of patients with diabetes. The mm-wave radar signal with Discrete Time

Fourier Transform finds various glucose concentrations in hemoglobin samples. [6]

The near infrared spectroscopy non-invasively measures glucose concentration in blood. The infrared light pass through finger and blood glucose concentration evaluate by calculating absorbance through Beer-Lambert law. The infrared absorbance is equivalent to blood glucose concentration and finger thickness. [7]

A sensitive Glucose fringe field Microstrip Line (MLIN), Material under Test (MUT) – glucose as substrate detects concentration of glucose and ports. The electromagnetic field from MLIN interacts with MUT and show variation in  $|S_{11}|_{\min}$ . The glucose concentration estimate by Single variate, multivariate and multivariate estimation with bin correlation algorithm. [8]

An implanted sensor with telemetry system monitors subcutaneous tissue glucose for long term in diabetic patients. The implantable sensor consist of immobilized glucose oxidase membrane, polydimethylsiloxanemembrane, catalase connected to electrochemical oxygen detection and telemetry system for wireless data transmission. [9]

A planar microwave sensor monitors glucose level continuously. The sensor element contains four different hexagonal-shaped complementary split ring resonators (CSRR) resembling honey-cell pattern. The resonator was fabricated on a FR4 dielectric substrate and connected to planar micro strip with dielectric substrate. The CSRRs were connected through microstrip transmission line to a radar system operating at 2.4-2.5 GHz. The combined sensor system achieves a good sensitivity in detecting the glucose levels that dissolves in the blood similar to aqueous solutions. [1] A substrate integrated waveguide (SIW) planar sensor's design measured blood glucose concentration non-invasively. The SIW planar sensor's structure resembles traditional band stop filter. The SIW planar sensor, yields a considerable and localized field improvement in the sensing region, the inter-digital arms and the slots on the SIW planar sensor cavity's upper conductor are utilized. Additionally, fingertip is utilized as material under test (MUT) and the effects of finger prints and the finger's displacement are analyzed. [11]

The ZnO based ultrasonic piezoelectric Micro-Electronics Mechanical Systems (MEMS) receiver monitors blood glucose. The radial displacement and the surface of the ultrasonic piezoelectric MEMS receiver produce voltage due to pressure and stress. The voltage

vary with respect to blood concentration level. The simulation analysis of glucose data showed agreeable correlation with glucometer reading. [12]

The blood glucose monitor with RF/microwave technology. The RF sensor measure blood glucose level by detecting dielectric changes of blood. The dielectric variation due to glucose causes the sensor frequency to shift below 8Mhz. The frequency shift also occur due to blood layer, skin, fat, pressure and position of finger. [13]

A wearable, minimum invasive autonomous and pseudo-continuous blood glucose monitoring. This wearable micro system design obtains a whole blood sample from a little lanced skin wound utilizing a new micro-actuator based on a shape memory alloy (SMA) and straightly measures the blood glucose level from the blood sample. [14]

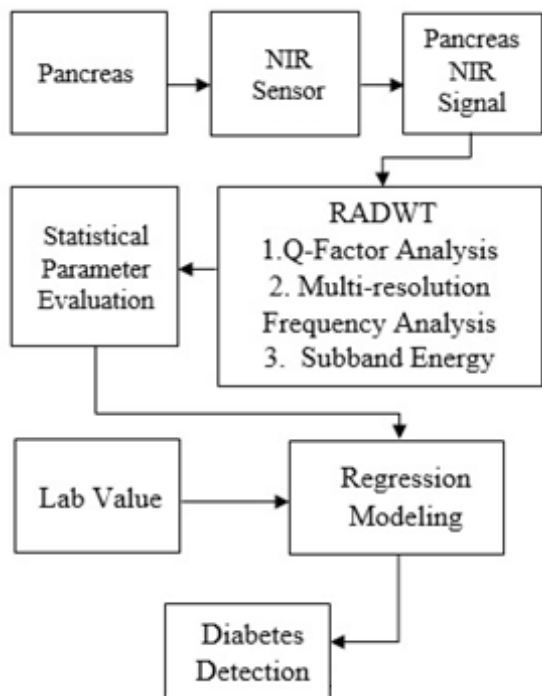
A wirelessly powered implantable electrochemical sensor system monitors blood glucose continuously. The system was powerby 13.56 MHz inductive link and an ISO 15693 radio frequency identification (RFID) standard for telemetric communication. The sensor system comprises awinding ferrite antenna, a RFID front-end, a 10-bit sigma-delta analog to digital converter (ADC), a long-term glucose sensor, an on-chiptemperature sensor, a potentiostatand a digital baseband for controlling and processing protocol. A high frequency (HF) external readerpowers, commands and configures the sensor system directly. The off-chip support circuitry requiresa glucose micro-sensor and a tuned antenna. [15]

## Methodology

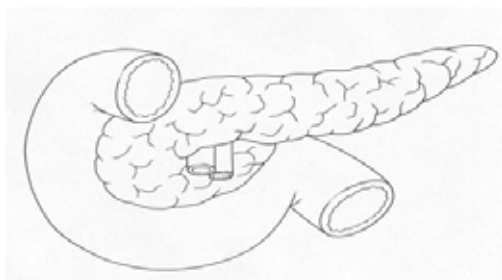
The non-invasive technique of diabetes detection is performed by measuring the blood glucose concentration through NIR spectroscopy. The NIR spectroscopy measures blood glucose concentration by evaluating insulin secretion from pancreas. The NIR sensor is placed on the pancreas region. Figure 1 shows the overview of diabetes prediction withreflected infrared from pancreas.

Pancreas is a gland that is six inches long and located in the abdomen. It is flat and pear shaped, surrounded by liver, small intestine, spleen, stomach. The pancreas's endocrine cells produce hormones. Hormones are substances that regulate or control particular functions in the body. Hormones are generally formed in one part of the body and passed through the blood to react on another part of the body. The two important pancreatic

hormones are insulin and glucagon. The endocrine cells such as the islet cells present in the pancreas produce and secrete glucagon and insulin in the blood. Glucagon increases the blood sugar level while insulin lowers the blood sugar level. The two hormones function together to maintain proper blood sugar level. The figure 2 shows the structure of pancreas.



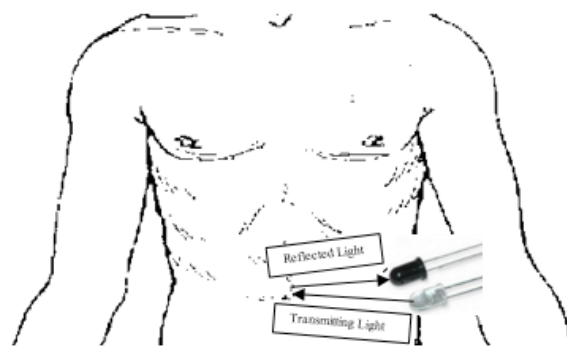
**Figure 1. Overview of diabetes detection with NIR through RADWT algorithm.**



**Figure 2. Structure of Pancreas**

To find the insulin secretion level from pancreas, NIR spectroscopy is used. NIR spectroscopy is a spectroscopic technique that utilizes the electromagnetic spectrum's from near infrared region. NIR spectroscopy is used in various medical applications such as pulse oximetry, blood sugar level monitoring, neurology and urology. The NIR sensor is placed on the pancreas region as shown in figure 3. The reflected infrared signal from pancreas acquire with data acquisition tool. The infrared signal from pancreas of normal and diabetic person. The

pancreas infrared signal obtain for before meal and after meal condition. The acquired infrared signals processes through Rational Dilation Wavelet Transform (RADWT) to determine infrared variation due to insulin secretion. In RADWT, the Q-factor value change for resolution and subband energy level of pancreas NIR signal.



**Figure 3. NIR Diode Placed on the Pancreas Region**

**Rational Dilation Wavelet Transform (RADWT):** The Dyadic Wavelet Transform is an effective transformation tool for sparsely representing the smooth signals and it is a constant Q-factor transform and a critically sampled wavelet transform. However, its frequency resolution is poor and has a low Q-factor. The Dyadic Wavelet Transform is not effective for processing NIR signals with oscillatory nature. Some techniques like Cosine Modulated Filter Banks, Short Time Fourier Transform (STFT), wavelet packets are traditionally used for oscillatory type signals rather than using dyadic wavelet transform. The transforms do not have a constant Q-factor. So an efficient transform with constant and high Q-factor and high frequency resolution is required. Another category of wavelet transforms like overcomplete wavelet transform performs efficiently than critically sampled wavelet transforms like dyadic wavelet transform. Overcomplete wavelet transforms extend an  $N$ -point NIR signal to a set of  $M$  coefficients with  $M > N$ . Several overcomplete invertible wavelet transforms such as double density wavelet transform, dual tree complex wavelet transform and undecimated wavelet transform exists. These wavelet transforms achieve over completeness through increasing only the temporal sampling in all frequency bands. The frequency spacing between adjacent frequency bands should be reduced to utilize the overcomplete wavelet transform's redundancy. These overcomplete wavelet transforms are based on rational dilations. The figure 4 represents the Rational Dilation Wavelet Transform (RADWT) where

$H(\omega)$  is high pass filter,  $G(\omega)$  is low pass filter,  $p$  and  $q$  are rational dilation factors and  $s$  is redundancy factor.

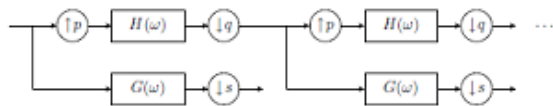


Figure 4. RADWT

The selection of dilation factor close to one, a wavelet can be dilated from scale to scale and multi resolution frequency analysis of the NIR signal can be performed. Additionally, the dilation factors  $p$  and  $q$  and the redundancy factor  $s$  enhance the Q-factor and frequency resolution of the NIR signal. The Q factor of the signal resolution depend on the rational dilation factors  $q$  and  $p$ . The filter banks of RADWT is shown in figure 5.

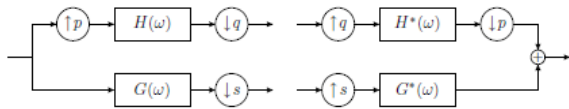


Figure 5. Filter Bank of the proposed RADWT

The perfect reconstruction filters for the filter bank shown in figure 5 is derived. The parameters  $p$ ,  $q$  and  $s$  are positive integers that satisfy  $1 \leq p < q$  and  $p/q + 1/s \geq 1$ . The integers  $p$ ,  $q$  are coprime. For perfect reconstruction  $p + 1 = q = s$ . The only condition for perfect reconstruction filters is

$$\frac{1}{pq} \left| H\left(\frac{\omega}{p}\right) \right|^2 + \frac{1}{s} |G(\omega)|^2 = 1 \text{ for } \omega \in [0, \pi] \quad (1)$$

Finally, the perfect reconstruction filters are given as

$$H(\omega) = \begin{cases} \sqrt{pq} & \omega \in \left[0, \left(1 - \frac{1}{s}\right)\frac{\pi}{p}\right) \\ \sqrt{pq}\theta \left(\frac{\omega - a}{b}\right) & \omega \in \left[\left(1 - \frac{1}{s}\right)\frac{\pi}{p}, \frac{\pi}{q}\right) \\ 0 & \omega \in \left[\frac{\pi}{q}, \pi\right] \end{cases}$$

$$G(\omega) = \begin{cases} 0 & \omega \in \left[0, \left(1 - \frac{1}{g}\right)\pi\right) \\ \sqrt{s}\theta_c \left(\frac{\omega - p\alpha}{pb}\right) & \omega \in \left[\left(1 - \frac{1}{g}\right)\pi, \frac{p}{q}\pi\right) \\ \sqrt{s} & \omega \in \left[\frac{p}{q}\pi, \pi\right] \end{cases} \quad (2)$$

### Results and Discussion

The NIR sensor position over pancreas of diabetic person and infrared signal acquire for before meal

consumption and after meal consumption. The infrared signal acquired before meal consumption is shown in figure 6.

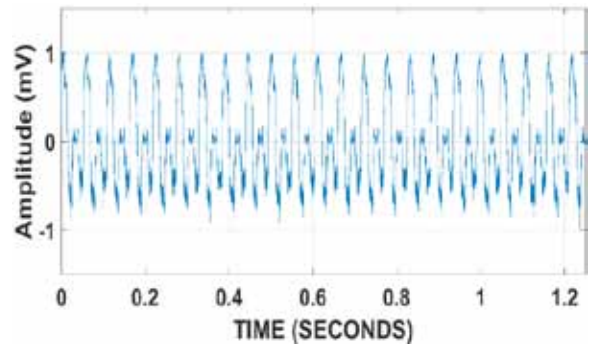


Figure 6. Pancreas NIR signal (Before meal consumption)

The acquired NIR signal decompose up to 11 levels to determine subband signal influenced by pancreas insulin secretion. The NIR signal process through RADWT for multi-resolution frequency analysis. The decomposed subband signal is shown in figure 7. Figure 8 shows the reconstructed subband signal from individual subband.

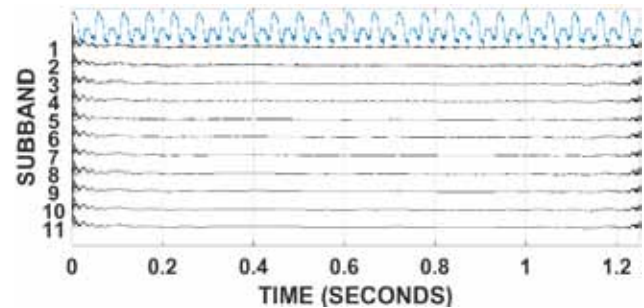


Figure 7. NIR signal decomposition with RADWT (Before meal consumption)

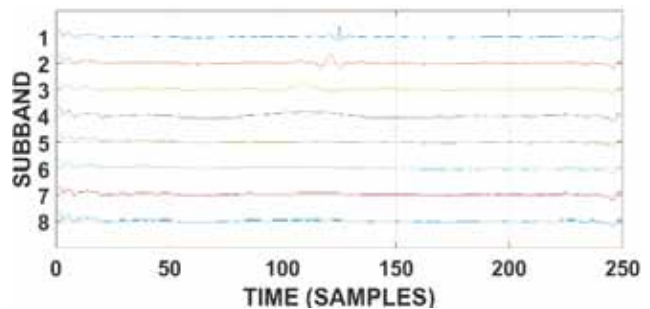
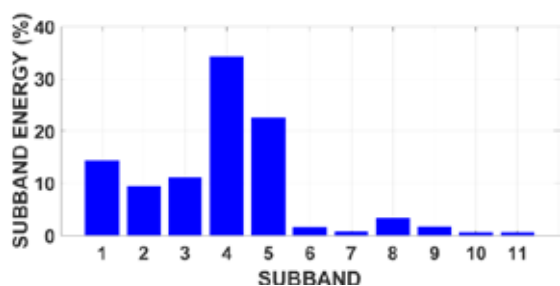


Figure 8. Reconstructed subband signal of the pancreas NIR signal (Before Meal consumption)

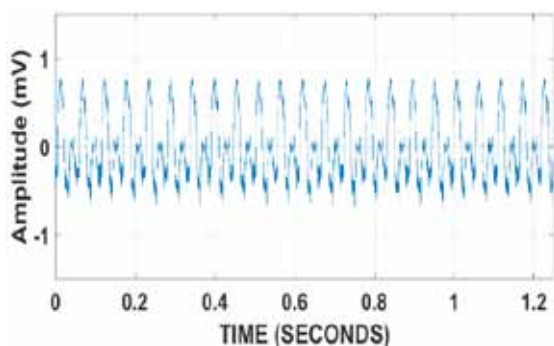
The multiresolution analysis evaluate for NIR signal subband energy. The RADWT, decomposes the signal and subband energy evaluate for each subband signal. The subband energy level of the NIR signal before meal consumption is shown in figure 9.



**Figure 9. Subband Energy Level of the Pancreas NIR signal (Before meal consumption)**

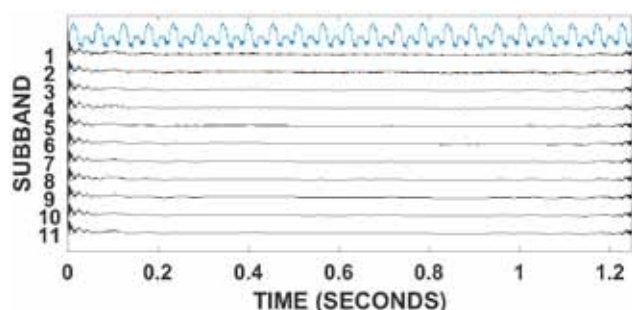
In figure 9 the subband energy level is low due to low insulin secretion from pancreas. The low insulin secretion from pancreas cause high blood glucose level. The subband energy level attains a maximum of 24% at fifth subband.

The pancreas NIR signal was obtained from pancreas with NIR sensor after mealconsumption is shown in figure 10.

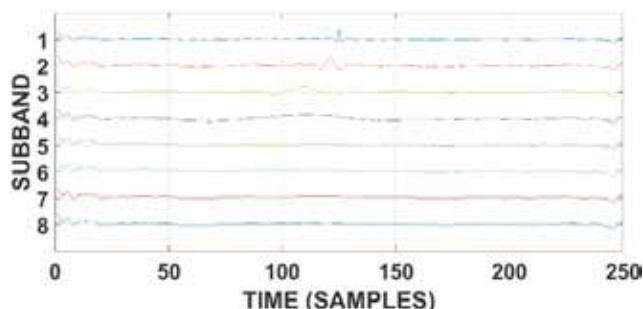


**Figure 10. Pancreas NIR signal (After meal consumption)**

The decomposed signal with RADWT is shown in figure 11. The subband signal reconstructed with RADWT from individual subband is shown in figure 12. In figure 12, the subband energy increases when the insulin secretion level from pancreas increase.



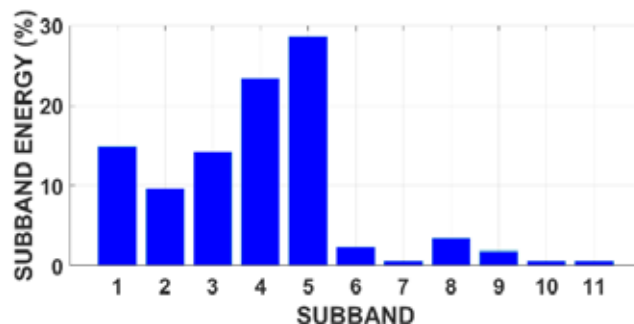
**Figure 11. NIR signal decomposition with RADWT (After meal consumption)**



**Figure 12. Reconstructed subband signal of the pancreas NIR signal (After meal consumption)**

The subband energy level reconstructed NIR signal with RADWT from pancreas after meal consumption is shown in figure 13.

In figure 13, the subband energy level increases due to insulin secretion from pancreas. The subband energy level attains a maximum of 28% for fifth subband. The increase in pancreas insulin secretion lowers blood glucose level.



**Figure 13. Subband Energy Level of the Pancreas NIR signal (After meal consumption)**

The NIR signal from pancreas of non-diabetic person was obtained for before food consumption and after food consumption scenarios. The NIR subband energy variation was similar to diabetic person. However, the subband energy increased to maximum of 35% at fifth subband before food consumption and increased further to 42% after food consumption due to high insulin response. The subband energy increased proportional to insulin response from pancreas. The high insulin response from pancreas regulated blood sugar level. The table 1 gives information about subband energy, insulin response and glucometer reading of diabetic and non-diabetic person.

**Table 1: NIR signal parameter of diabetic and non-diabetic person.**

Parameters	Diabetic person		Nondiabetic person	
	Before meal consumption	After meal consumption	Before meal consumption	After meal consumption
Subband energy	24	28	15	21
Glucometer values	183	240	95	132
Lab results	165	228	90	120

**Regression Modeling:** The regression modeling is a statistical procedure used to estimate the linear or straight-line relationship that relates two or more variables. The linear relationship represents amount of change in one variable that relates with change in another variable. The regression modeling also evaluate for statistical significance, to check whether the linear relationship emerge by chance or not. The two variable regression model includes two variables such as an independent variable and a dependent variable. The independent variable causes changes in the dependent variable.

**Linear Regression:** Linear regression model determines relationship between two variables through fitting a linear equation for observed data. One variable is considered as an explanatory variable, and the other is considered as a dependent variable.

The equation of a linear regression line is of the form

$$Y = a + bX \tag{3}$$

where,

$X$  is the explanatory variable.

$Y$  is the dependent variable.

The slope of line is  $b$ , and the intercept is  $a$  (the value of  $y$  when  $x = 0$ ). The formula for computing intercept  $a$  and slope  $b$  is given as

$$a = \frac{(\sum y)(\sum x^2) - (\sum x)(\sum xy)}{n(\sum x^2) - (\sum x)^2}$$

$$b = \frac{n(\sum xy) - (\sum x)(\sum y)}{n(\sum x^2) - (\sum x)^2} \tag{4}$$

The blood glucose level of diabetic person obtain from subband energy and lab values represent by equation

$$Y = 14.20 * X - 159.0 \tag{5}$$

and the blood sugar level of non-diabetic person represent by

$$Y = 6.393 * X - 1.357 \tag{6}$$

**Conclusion**

A non-invasive technique for monitoring blood glucose concentration is presented. The blood glucose level determine with insulin secretion level from pancreas, NIR sensor measures the insulin secretion level in pancreas. The intensity of the NIR light varies according to the insulin secretion level in pancreas. The NIR signal obtained from the pancreas is processed through RADWT to evaluate the insulin level in pancreas. The RADWT subband energy level is relative to insulin secretion from pancreas. The subband energy is low when the insulin secretion level in pancreas is low, before food consumption and the sub band energy level is high when insulin secretion level in pancreas increase after food consumption. The subband energy of NIR signal validates with glucometer measurement results.

**Conflict of Interest:** The authors declare no conflict of interest.

**Source of Funding:** Self

**Ethical Clearance:** All procedures were in accordance with the 1964 Helsinki Declaration (and its amendments). No approval by ethical committee or institutional review board was required. Informed.

**References**

1. Yujiro Tanaka, Takuro Tajima, Michiko Seyama, Kayo Waki. Differential Continuous Wave Photoacoustic Spectroscopy for Non-Invasive Glucose Monitoring. IEEE Sensors Journal 2020;20(8): 4453-4458.

2. Sandeep Kumar Chamoli, Subhash Chandra Singh, Chunlei Guo. Design of Extremely Sensitive Refractive Index Sensors in Infrared for Blood Glucose Detection. *IEEE Sensors Journal* 2020; 20(9): 4628-4634.
3. Abhishek Kandwal, Zedong Nie, Tobore Igbe, Jingzhen Li, Yuhang Liu, Louis WY Liu, Yang Hao. Surface Plasmonic Feature Microwave Sensor with Highly Confined fields for Aqueous-Glucose and Blood-Glucose Measurements. *IEEE Transactions on Instrumentation and Measurement* 2020; 9456(c): 1-9.
4. Jingzhen Li, Tobore Igbe, Yuhang Liu, Zedong Nie, Wenjian Qin, Lei Wang, Yang Hao. An Approach for Noninvasive Blood Glucose Monitoring Based on Bioimpedance Difference Considering Blood Volume Pulsation. *IEEE Access* 2018; 6: 51119-51129.
5. Maria Celeste Cebedio, Lucas Andres Rabioglio, Ivan Exequiel Gelosi, Ramiro Avalos Ribas, Alejandro Jose Uriz, Jorge Castineira Moreira. Analysis and Design of a Microwave Coplanar Sensor for Non-Invasive Blood Glucose Measurements. *IEEE Sensors Journal* 2020; 20(18): 10572-10581.
6. Ala Eldin Omer, George Shaker, Safieddin Safavi-Naeini, Kevin Murray, Richard Hughson. Glucose Levels Detection Using mm-Wave Radar. *IEEE Sensors Letters* 2017; 2(3): 1-4.
7. Shyqyri Haxha, Jaspreet Jhoja. Optical Based Noninvasive Glucose Monitoring Sensor Prototype. *IEEE Photonics Journal* 2016; 8(6):1-11.
8. Shao Ying Huang, Omkar, Yu Yoshida, Adan Garcia, Xavier Chia, Wen Chuan Mu, Yu Song Meng, Wenwei Yu. Microstrip Line-Based Glucose Sensor for Noninvasive Continuous Monitoring using the Main Field for Sensing and Multivariable Crosschecking. *IEEE Sensors Journal* 2018; 19(2): 535-547.
9. Joseph Y Lucisano, Timothy L Routh, Joe T Lin, David A Gough. Glucose Monitoring in Individuals with Diabetes Using a Long-Term Implanted Sensor/Telemetry System and Model. *IEEE Trans Biomed Eng* 2017; 64(9): 1982-1993.
10. Ala Eldin Omer, George Shaker, Safieddin Safavi-Naeini. Portable Radar-Driven Microwave Sensor for Intermittent Glucose Levels Monitoring. *IEEE Sensors Letters* 2020; 4(5): 21-24.
11. Sina Kiani, Pejman Rezaei, Mahmood Karami, R. A. Sadeghzadeh. Band-stop filter sensor based on SIW cavity for the non-invasive measuring of blood glucose. *IET wireless Sensor Systems* 2019; 9(1): 1-5.
12. Hara Prasada Tripathy, Priyabrata Pattanaik, Sushanta Kumar Kamilla, Rajesh Kumar Tripathy. A Simulation Approach to Study the Effect of Ultrasonic MEMS Based Receiver for Blood Glucose Sensing Applications. *IEEE Sensors Letters* 2017; 1(5): 1-4.
13. Volkan Turgul, Izzet Kale. Simulating the Effects of Skin Thickness and Fingerprints to Highlight Problems with Non-Invasive RF Blood Glucose Sensing from Fingertips. *IEEE Sensors Journal* 2017; 17(22): 7553-7560.
14. Gang Wang, Michael D Poscente, Simon S Park, Christopher N Andrews, Orly Yadid-Pecht, Martin P Mintchev. Wearable Microsystem for Minimally Invasive, Pseudo-Continuous Blood Glucose Monitoring: The e-Mosquito. *IEEE Transactions on Biomedical Circuits and Systems* 2017; 11(5): 979-987.
15. Zhibin Xiao, Xi Tan, Xianliang Chen, Sizheng Chen, Zijian Zhang, Hualei Zhang, Junyu Wng, Yue Huang, Peng Zhang, Lirong Zheng, Hao Min. An implantable RFID sensor tag toward continuous glucose monitoring. *IEEE Journal of Biomedical and Health Informatics* 2015; 19(3): 910-919.



# Effects of Multidrug-Resistant Organism Infection Control Simulation Program on the Infection Control Fatigue, Job Stress, and Performance of Nurses

Mi Hyang Lee

Associate Professor, Department of Nursing, College of Nursing, Konyang University 158,  
Gwanjeodong-ro, Seo-gu, Daejeon, South Korea

## Abstract

**Background:** This study was conducted to develop a training program simulating multidrug-resistant organism infection control for nurses and to verify its effectiveness.

**Method:** This was a randomized, control-group, pretest-posttest design study carried out with a total of thirty-one nurses. A general lecture on theories was provided to the control group, while the developed simulation training program was implemented for the experimental group.

**Result:** The results showed that the experimental group who received the multidrug-resistant infection control simulation training program recorded higher infection control performance than the control group who received lecture-based training ( $p=.029$ ). However, there was no statistically significant difference in infection control fatigue and job stress between the two groups.

**Conclusion:** It was found that the simulation training program is an effective intervention that can improve the performance of infection control. Repeated research on diverse variables is necessary in the future in order to continuously measure the effectiveness of the simulation training program.

**Keywords:** MDROs, Fatigue, Job stress, Performance, Simulation training.

## Introduction

Healthcare-associated infections have steadily been on the rise due to a widespread use of invasive treatment method and an increase in multidrug-resistant organisms (MDROs)<sup>[1]</sup>. Healthcare-associated infections caused by MDROs, in particular, are known to exacerbate the medical condition of patients and even raise mortality,<sup>[2]</sup> in addition to increasing the hospitalization period and medical costs, thereby causing more financial burden on patients and their families<sup>[3]</sup>. They are problematic even from the viewpoint of healthcare institutions in relation to increased costs from patient isolation, lack of space for isolation and greater workload for the medical staff to control and prevent the spread of infection<sup>[4]</sup>.

Nurses taking part in the treatment of infected patients experience physical and mental burden arising from the difficulties related to wearing personal protective equipment (PPE) and managing patients<sup>[5]</sup>. On

the other hand, there are patients who believe that the medical staff is to blame for the occurrence of MDROs, which causes the relationship between such patients and the medical staff to rapidly deteriorate, and this in turn further increases mental fatigue for the medical staff<sup>[6]</sup>. When nurses nursing patients infected with MDROs the more fatigue they will experience due to increased workload such as hand hygiene and wearing PPE, and under these circumstances, they will likely have difficulty concentrating on their job and become more easily distracted, resulting in poorer job performance<sup>[7]</sup>. Therefore, in order to provide quality nursing services to patients, it is necessary to reduce the infection control fatigue experienced by nurses.

Nurses tend to experience high job stress due to the high demand for professional knowledge and skills, interpersonal conflict with patients, higher nursing quality demanded by patients, and occupational nature in

dealing with human lives<sup>[8]</sup>. Nurses who are involved in treating a patient with infectious diseases, in particular, experience emotional pain due to the idea that they themselves are responsible for the patient's infection or death and fear that they could become a medium and spread the infection to other patients<sup>[9]</sup>. The higher the job stress faced by nurses, the more difficult it is for them to provide quality nursing to patients, and it also leads to reduced productivity and work efficiency<sup>[10]</sup>. Plus, higher job stress leads to a higher chance of a burnout<sup>[8]</sup>, which eventually lead to higher turnover. Therefore, it is necessary to reduce the job stress that may occur when nurses care for patients infected with MDROs.

Nurses were found to experience high stress in relation to professional expertise and PPE among other factors when nursing patients infected with MDROs. According to a study conducted by Lee<sup>[11]</sup>, 67.8% of nurses in small- and medium-sized hospitals have received training for MDRO infection control, while 86.1% have had experience in nursing patients with infected with MDROs. In other words, it was found that there were cases in which nurses had to care for patients infected with MDROs without having received any MDRO infection control training, and insufficient knowledge of infection control would likely have increase the level of stress they experienced. Moreover, MDRO infection control training mostly consists of lectures on theoretical knowledge, which makes it is difficult for nurses to apply the knowledge they gain in practice. Simulation training has recently been introduced in the healthcare sector, and it is known to be highly effective in allowing trainees apply the theories they have learned in lectures to clinical performance<sup>[12]</sup>.

Simulation training is a method of training that helps improve the clinical competency of nurses in a safe educational environment where there is no potential harm to patients, and it is a method of training that helps cultivate comprehensive performance capacity suitable for various situations<sup>[13]</sup>. As for prior studies that examined simulation training for nurses, Lee and Ahn<sup>[14]</sup> reported improved knowledge of emergency situations, clinical performance capacity, and performance confidence, and Cho et al.<sup>[1]</sup> reported that it helped enhanced the infection control performance of participating nurses.

Accordingly, this study was conducted with the aim of examining the effects of MDRO infection control training on the infection control fatigue, job stress, and performance of nurses.

**Study Objectives:** The purpose of this study is to determine the effects of MDRO infection control simulation training on infection control fatigue, job stress and performance of nurses. The specific objectives are as follows:

1. Verify the difference in the level of fatigue from infection control before and after MDRO infection control simulation training;
2. Verify the difference in the level of job stress from infection control before and after MDRO infection control simulation training;
3. Verify the difference in the level of infection control performance before and after MDRO infection control simulation training.

## Method

**Study Design:** This was a randomized, control-group, pretest-posttest design study carried out with the application of an MDRO infection control simulation training program to verify its effectiveness.

**Participants:** The subjects in this study were nurses in a certain region who voluntarily agreed to participate in this study with an understanding of the purpose and procedure of the study. The number of samples required for the study was calculated using the G\*power 3.1 program, and the number of samples required for t-test was calculated based on a significance level of .05, group number of 2, effect size of .08, and power of .80. The minimum number of samples for analysis was found to be 26 for the experimental group and 26 for the control group. Due to the outbreak of COVID-19, some of the subjects refused to participate in the study, and ultimately, there were 17 subjects in the experimental group and 14 subjects in the control group.

## Measurements:

1. **Fatigue from infection control:** A total of 29 questions were asked based on a 5-point Likert scale, with the highest score indicating the highest level of fatigue. As for the reliability of the tool, Cronbach's alpha was measured to be .94.
2. **Job stress from infection control:** A total of 32 questions were asked based on a 5-point Likert scale, with the highest score indicating the highest level of job stress. Cronbach's alpha was .96.
3. **MDRO infection control performance:** A total of 16 questions were asked based on a 5-point Likert

scale, with the highest score indicating the highest level of MDRO infection control performance. Cronbach’s alpha was .92.

**Intervention**

**1. Preliminary Survey:** Both the control group and the experimental group were asked to fill out a questionnaire on fatigue, job stress, and performance in relation to MDRO infection control without receiving any infection control training. The subjects were not given any information on whether they belonged to the control group or the experimental group.

**2. Intervention**

**1. Experimental Group:** The developed MDRO infection control simulation scenario was administered by a nurse specializing in infection control. One virtual patient, one legal guardian, and one nurse were selected, and three nurses with at least five years of experience or more at the medical institution performed the evaluation based on a checklist.

The scenario consisted of nursing activities routinely performed in the ward, such as administering medication, measuring vital signs, and emptying urine bags for MDRO patients in isolation. The checklist required the evaluators to perform evaluation on the nursing activities before entering the patient room and while in the patient room, use of PPE and hand hygiene practice when leaving the patient room, etc. After the scenario was administered, corrections were made through a 15-minute debriefing process, and manual demonstration training was conducted.

**2. Control Group:** A nurse specializing in infection control gave an hour-long lecture explaining the

definition of MDRO, transmission method, and theories related to contact isolation based on a PowerPoint presentation.

**3. Follow-up Survey:** Immediately after the simulation training and lecture-based training, the same questionnaire was distributed to both the experimental group and the control group. After the final questionnaire was completed, simulation training was administered to the control group.

**Statistical Analysis:** The data collected were analyzed using the SPSS/WIN 21.0 program, based on the following analysis method: The test of homogeneity between the experimental group and the control group was carried out by the Chi-square test, Fisher’s exact test, and Mann-Whitney U test depending on the characteristics of the variables. The hypotheses with respect to the MDRO infection control fatigue, job stress, and performance were tested using the Mann-Whitney U test.

**Findings:**

**Characteristics of Test Subjects and Test of Homogeneity:** The results of the test of homogeneity according to the general characteristics of the subjects are shown in Table 1. There were no significant differences in age, sex, affiliated department, MDRO infection control training in the past year, or prior experience in nursing an MDRO-infected patient between the control and experimental groups (Table 1). A comparison of infection control fatigue, job stress, and performance between the two groups before the simulation training program showed no significant difference between them (Table 2). As there was no significant difference between the control group and the experimental group, they were deemed homogeneous.

**Table 1. General Characteristics of the Experimental and Control Groups (n=31)**

Variable	Categories	Cont. (n=14)	Exp. (n=17)	U/ $\chi^2$	p
		n(%)	n(%)		
Age		31.71±10.77	34.35±7.28	-.811	.424
Sex	Male	1 (7.1)	3 (17.6)	.754	.607
	Female	13 (92.9)	14 (82.4)		
Affiliated department	Ward	9 (64.3)	10 (58.8)	.097	1.000
	Special department	5 (35.7)	7 (41.2)		

Variable	Categories	Cont. (n=14)	Exp. (n=17)	U/ $\chi^2$	p
		n(%)	n(%)		
MDRO infection control training received in the past year	Yes	3 (21.4)	8 (47.1)	2.203	.258
	No	11 (78.6)	9 (52.9)		
Prior experience in nursing an MDRO-infected patient	Yes	10 (71.4)	5 (29.4)	.003	1.000
	No	4 (28.6)	12 (70.6)		

**Table 2. Test of Homogeneity Between the Experimental and Control Groups in Dependent Variables (n=31)**

Variable		Cont. (n=14)	Exp. (n=17)	U	p
		M±SD	M±SD		
Infection control fatigue	Pre-test	3.37±.53	3.56±.43	116.5	.922
Infection control job stress	Pre-test	3.55±.58	3.66±.57	103.0	.544
Infection control performance	Pre-test	4.15±.44	4.42±.34	72.0	.064

**Effects of MDRO Infection Control Simulation Training Program:** Hypothesis 1: The hypothesis that the “experimental group receiving simulation training will experience lower infection control fatigue than the control group receiving lecture-based training” was tested, and the results showed no statistically significant difference, with the experimental group recording 3.40±.49 and the control group 3.45±.51 (U=109.5,  $p=.710$ ). Therefore, Hypothesis 1 was not supported.

The hypothesis that the “experimental group receiving simulation training will experience lower infection control job stress than the control group receiving lecture-based training” was tested, and the

results showed no statistically significant difference, with the experimental group recording 3.62±.58 and the control group 3.50±.54 (U=92.0,  $p=.297$ ). Therefore, Hypothesis 2 was not supported.

Hypothesis 3: The hypothesis that the “experimental group receiving simulation training will exhibit better infection control performance than the control group receiving lecture-based training” was tested, and the results showed no statistically significant difference, with the experimental group recording 4.60±.32 and the control group 4.18±.54 (U=64.0,  $p=.029$ ). Therefore, Hypothesis 3 was not supported.

**Table 3. Differences between the Control and Experimental Groups in the Variables Examined After Simulation Training (n=31)**

Variable	Cont. (n=14)	Exp. (n=17)	U	p
	M±SD	M±SD		
Infection control fatigue	3.45±.51	3.40±.49	109.5	.710
Infection control job stress	3.50±.54	3.62±.58	92.0	.297
Infection control performance	4.18±.54	4.60±.32	64.0	.029

**Table 4. Differences in the Variables Examined before and After the MDRO Infection Control Simulation Training (n=31)**

Variable	Group	Pretest	Posttest	Pre-post Difference	U	p
		M±SD	M±SD	M±SD		
Infection control fatigue	Con. (n=14)	3.37±.53	3.45±.51	.08±.22	109.5	.710
	Exp. (n=17)	3.56±.43	3.40±.49	.04±.49		

Variable	Group	Pretest	Posttest	Pre-post Difference	U	p
		M±SD	M±SD	M±SD		
Infection control job stress	Con. (n=14)	3.55±.58	3.50±.54	-.04±.30	98.5	.421
	Exp. (n=17)	3.66±.57	3.62±.58	-.04±.55		
Infection control performance	Con. (n=14)	4.15±.44	4.18±.54	.04±.38	91.0	.279
	Exp. (n=17)	4.42±.34	4.60±.32	.18±.46		

## Discussion

This study was conducted with the aim of developing an MDRO infection control simulation training program and verifying its effectiveness. With homogeneous experimental and control groups, the MDRO infection control simulation training program was administered to the former. The results of verifying the MDRO infection control fatigue showed that it decreased by 0.16 points from 3.56 points to 3.40 points, on average, for the experimental group, while it increased by 0.08 points from 3.37 points to 3.45 points for the control group. However, the difference was not statistically significant. Even in the case of job stress, it decreased by 0.04 points from 3.66 points to 3.62 points, on average, for the experimental group, and it decreased by 0.05 points from 3.55 points to 3.50 points for the control group. The difference was not statistically significant. Although it is difficult to compare the changes in the levels of infection control fatigue and job stress resulting from the simulation training intervention, as there have not been prior studies examining these two variables, it is believed that it would be difficult to directly reduce infection control fatigue and job stress with short-term training. In this study, infection control fatigue and job stress were evaluated immediately after the application of the simulation training program, which is thought to be too short to truly evaluate the effectiveness of the training program on these two variables. It is predicted that it will be better to compare the changes in the infection control fatigue and stress before and after the application of the intervention program while allowing the participating nurses actually apply what they have learned in the clinical setting for some time. Thus, it is suggested that a re-evaluation be performed 4 to 8 weeks after the simulation training program intervention.

The infection control performance was verified after applying the MDRO infection control simulation training program, and the results showed it increased by 0.18 points from 4.42 points to 4.60 points for the

experimental group, and it increased by 0.3 points from 4.15 to 4.18 points for the control group. The difference between the two groups was found to be statistically significant. This was similar to the findings reported by Cho et al.<sup>[1]</sup> that infection control performance was enhanced after simulation training, while there was no difference in the infection control awareness and self-efficacy. The results were similar to the findings reported by Lee and Ahn<sup>[14]</sup> in regard to their study on nurses.

Simulation training helps trainees synthesize and apply knowledge rather than simply acquiring knowledge<sup>[15]</sup>. It is believed that the subjects in this study exhibited enhanced performance by affirming and applying the knowledge they had previously learned in theoretical education on MDROs through simulation.

Based on these results, it is believed that it will be effective to use the simulation training method to improve the MDRO infection control performance of nurses. Going forward, it will be necessary to develop various scenarios and repeat this research in order to understand the effects of simulation using a control group. It will also be necessary to evaluate infection control fatigue and job stress 2 to 4 weeks after training in order to evaluate the effectiveness of the simulation training program in an ongoing manner.

## Conclusion and Recommendations

In this study, a simulation training program was developed and applied, and the differences in infection control fatigue, job stress, and performance between the experimental group and the control group after the application of the MDRO infection control simulation training program were examined. The results showed that the simulation training program is an effective intervention for improving infection control performance. In order to continuously measure the effectiveness of simulation training in the future, it will be necessary to conduct this research repeatedly on various variables.

**Source Funding:** This study was carried out as a research project of the National Research Foundation of Korea.

**Conflict of Interest:** None

**Ethical Clearance:** This research has ethical clearance from the Institutional Review Board of Konyang University (KYU-2020-030-01).

## Reference

1. Cho SS, Kim KM, Lee BY, Park SA. The effects of simulation-based infection control training on the intensive care unit nurses' perception, clinical performance, and self-efficacy of infection control. *Journal of Korean Clinical Nursing Research*. 2012;18(3):381-390.
2. Diaz Grandados GA, Zimmer SM, Klein M, Jernigan JA. Comparison of mortality associated with vancomycin-resistant and vancomycin-susceptible enterococcal bloodstream infections: a meta-analysis. *Clinical Infectious Disease*. 2005; 41(3):327-333.
3. Neidell MJ, Cohen B, Furuya Y, Hill J, Jeon CY, Glied S, Larson EL. Costs of healthcare and community-associated infections with antimicrobial-resistant versus antimicrobial-susceptible organisms. *Clinical Infectious Disease*. 2010;55(6):807-815.
4. Oh SH. Current status of infection control of multidrug-resistant organisms in hospitals with more than 200beds in the republic of Korea. *The Korean Journal of Health Service Management*. 2014;8(4):163-173.
5. Corley A, Hammond NE, Fraser JF. The experiences of health care workers employed in an Australian intensive care unit during the H1N1 influenza pandemic of 2009: a phenomenological study. *International Journal of Nursing Studies*. 2010;577-585.
6. Holroyd E, McNaught C. The SARS crisis: reflections of Hong Kong nurses. *International Nursing Review*. 2008;55(1):27-33.
7. Jung YJ, Kang SW. Differences in sleep, fatigue, and neurocognitive function between shift nurses and non-shift nurses. *Korean Journal of Adult Nursing*. 2017;29(2):190-199.
8. Kang JS, Lim JY. Effects of clinical nurses resilience on job stress and burnout. *Journal of the Korea Contents Association*. 2015;15(11):263-273.
9. Khalid I, Khalid TJ, Qabajah MR, Barnard AG, Qushmaq IA. Healthcare workers emotions, perceived stressors and coping strategies during a MERS-CoV outbreak. *Clinical Medicine & Research*. 2016;14(1):7-14.
10. Sood A, Prasad K, Schroeder D, Varkey P. Stress management and resilience training among department of medicine faculty: A pilot randomized clinical trial. *Journal of General Internal Medicine*. 2016;26(8):858-861.
11. Lee MH. Knowledge and education needs related to multidrug-resistant organisms infection control among small and medium size hospital nurses. *Journal of the Korea Academia-Industrial cooperation Society*. 2020;21(4):463-470.
12. Jeffries PR. A framework for designing, implementing and evaluating simulations used as teaching strategies in nursing. *Nursing Education Perspectives*. 2007;26(2):96-103.
13. Waxman KT. The development of evidence-based clinical simulation scenarios: Guidelines for nurse educators. *Journal of Nursing Education*. 2010;49(1):29-35.
14. Lee YH, Ahn HY. The effects of simulation education for new nurses on emergency management using low-fidelity simulator. *Journal of Korean Academic Society of Nursing education*. 2019;25(3):331-343.
15. Norman J. A systematic review of the literature on simulation in nursing education. *The ABNF Journal*. 2012;23(2):24-28.

# Assessment of Breast Cancer Risk by Gail Model in Women of Thi-Qar

Sara OmranIssa<sup>1,2</sup>, Zainab H. Farhood<sup>1</sup>, Zaman Subhi Madlool<sup>1</sup>

<sup>1</sup>Assistant Lecture at Department of Biology, College of Education for Pure Science, University of Thi-Qar/Iraq, <sup>2</sup>saraom895@gmail.com

## Abstract

The aim of current study to assess the high incidence of breast cancer (BC) and the effect of its early diagnosis on decreasing morbidity and mortality among Iraqi women. A descriptive cross-sectional study was conducted and data were collected from 106 women in Thi-Qar by a questionnaire consisted of demographic and breast cancer risk (BCR) factors questions. Breast cancer risk was calculated using the BCR Assessment Tool (BCRAT) of the National Cancer Institute's online version (Gail Model). Results: The average age of women was  $43.44 \pm 11.3$  years. Ten (9.4%) women have first degree relatives who had BC and five of them have more than one. Fifty (45.3%) had their menarche at 12–13 years of age, 32 (29.2%) had their first birth at 20-24 year of age. The mean five year BCR for all women was  $1.25 \pm 1.46\%$ , and 15 (14.15%) of them had a five year BCR  $>1.7\%$ . Mean lifetime BCR up to age 90 years was  $13.11 \pm 12.76\%$  and 8 (7.54%) women had high risk. Based on these findings, it may be suggested that Gail Model for BCR assessment can help healthcare providers in Iraq to estimate an individual's probability of developing BC for early detection and prevention.

**Keywords:** Gail model; Breast cancer; Thi-Qar.

## Introduction

Breast cancer is the most common type of cancer in women. It is estimated that about 1.4 million new cases every year all over the world, and this disease accounts for about 25% of all cancer cases in women and is the second most common after lung cancer. This can happen in men, but this is uncommon. The incidence of this disease is much higher in developed countries than in developing countries (IARC, 2010). Incidence is increasing rapidly in many newly industrialized countries due to changing lifestyles in developed countries [1]

In 2010, it was recorded that 721 of the women who underwent a breast examination at the examination center for early detection of breast cancer in Iraq, 143 cases of this disease were diagnosed (19.8%). Although 90.6% of women initially self-discovered these lumps, Another study conducted in 2012 to explore the knowledge, attitudes and practices towards breast cancer in a sample of educated women, revealed that nearly half of the participants had a low knowledge score for this disease (less than 50%). The study indicated that 90% of the

participants heard about breast self-examination (BSE), however, we only found only 43% of them practiced this technique [2].

First type assesses the likelihood of BRCA mutations such as the Claus model where all predictions are based only on family history [3] The second type of risk factor used in BC includes the Gail model (GM) and the modified model (GM2) that calculates 5-year BCR and lifetime [4] GM is the most widely used risk prediction mode and the land has been studied, validated and applied in various studies around the world [5-7] So the aim of the current study was to apply GM2 to the Iraqi population and assess whether it could be used to assess BC prediction for women Iraqi women.

## Materials and Method

This study is a cross-sectional design and descriptive. The data were collected from 106 women who had applied to Bint Al Huda Hospital in Thi-Qar, a city in southern Iraq. The purpose of the study was explained to each woman and those who refused to participate

were excluded. A total of 106 women in the ages of 35 years and older were included and data were collected between May and June 2020.

The questionnaire was used in this study based on the online version of the National Cancer Institute’s Breast Cancer Risk Assessment Tool (BCRAT) also known as Gail Model available at (<http://www.cancer.gov/bcrisktool/>) which has questions about the five-year and lifetime BC risk based on age, age at first live birth, age at menarche, first degree relative numbers with BC, previous breast biopsies with or without atypical hyperplasia, BRCA mutations and woman race<sup>[8]</sup>

The questionnaire also had additional questions about sociodemographic features such as occupation, education, marital status, family income and husband education level. Unknown BRCA mutations and the white race/ethnicity (Caucasian) variables were used for all the women in this study in estimating their risks<sup>[9]</sup> For five-year risk assessment, a rate of 1.7% or less was defined as low risk while a rate of 1.7% or more was defined as high risk<sup>[4,9]</sup> Lifetime risks were classified as usual (<15%), moderate (15–30%), or strong (>30%)<sup>[10,11]</sup> Descriptive statistics including the mean, standard deviation and percentage was used to analyze data.

### Results

The socio-demographic features studied showed that 39(36.8%) of the women had completed primary,

secondary or high schools and 59 (54.7%) had completed diploma, college or postgraduate studies, and of their husbands there were 47 (55.6%) completed diploma, college or postgraduate studies and 39 (40.2%) completed primary, secondary or high schools. Thirty eight (34.9%) were teaching staff and 53(50.9%) housewives. There are 81 (75.5%) married, 8 (7.6%) unmarried, 9 (9.4%) divorced and 8 (7.9%) widow. About 12 (14.4%) of them had high level family income, 85(77.4%) had middle level and 9 (8.5%) had low level income (Table 1). The five-year and lifetime BCR variables studied showed that the mean age of women was 43.44± 11.3 years (range 35–67 years) and that 50 (45.3%) of the participants had their menarche at the age of 12–13 years, 32 (29.2%) of women had their first live birth between the ages of 20–24 years and 22(19.8%) between 25–29 years. There were 10 (9.4%) of the participants reported having first degree relatives who had diagnosed with breast cancer. Only 5 (3.8%) women reported two first-degree relative with breast cancer, four (4.7%) had undergone one breast biopsy and 8(8.5%) had more than one. five of the participants reported having atypical hyperplasia (Table 2).Based on the modified Gail model, the women in this study had a mean five years risk of 1.25± 1.46 and a mean of lifetime risk of 13.11± 12.76%. The minimum and maximum values were 0.3%, 7.1% and 3.7%, 39.6% for the five years and lifetime risks, respectively. In comparison with women of the same age and average risk factors, 19 (7.6%) had a higher five years risk and 6 (2.4%) had higher lifetime risk (Table 3).

**Table 1: Socio demographic information about the women included in the study, 35 years and over (N=106)**

Occupation	Marital status	Family income	Education level	Husband educ. Level
Teaching staff (38)34.9%	Married (81)75.5%	Low (9)8.5%	Prim.School (23)20.8%	Prim. School (14)14.4%
Employees (12)11.3%	Unmarried (8)7.6%	Middle (85)77.4%	Med.school (11)11.3%	Med .school (12)12.4%
Workers (1)1%	Divorced (9)9.4%	High (12)14.1%	High school (5)4.7%	Highschool (13)13.4%
Students (2)1.9%	Widow (8)7.5%		Diploma (16)14.2%	Diploma (9)10.3%
Housewives (53)50.9%			College (20)16%	College (28)27.8%
			Higher study (23)24.5%	Higher study (10)17.5%
			Uneducated (8)8.5	Uneducated (5)4.2%

**Table 2: Women risk factor values used in the BCRAT in women, 35 years and over (N=106)**

Age	Age at menarche	At a first live birth	No. of first degree relatives with BC	Having a biopsy
35-44 (59) 52.8%	Unknown(24) 23.6%	Not married(8) 8.5%	One relative (10) 9.4%	One biopsy (4)4.7%
44-54 (34) 30.2%	7-11 (4)3.7%	Unknown(2) 1.9%	>One relative (5) 3.8%	>One biopsy (8) 8.5% had atypical hyperplasia



Age	Age at menarche	At a first live birth	No. of first degree relatives with BC	Having a biopsy
55-64 (12) 16%	12-13( 50) 45.3%	No birth (6) 5.7%	Zero relative 91(85.84%)	
>65 years (1) 1%	>14(28) 27.4%	>20years(20) 19.8%		
		20-24years(32) 29.2%		
		25-29years(22) 19.8%		
		>30(16) 15.1%		

**Table 3: Calculated BCR in women,35years and over (N=106)**

Five years risk Number and percentage	Lifetime risk
Standard of Gail Model 1.02%	Standard of Gail Model 11.21%
Mean of five-year risk of all Women 1.25± 1.46%	Mean risk of all women up to age 90 years 13.11± 12.76%
Low risk 91(85.84%)	Usual risk 91(85.84%)
High risk 15 (14.15%)	Moderate risk 7(6.60%)
	High risk 8(7.54%)

## Discussion

With the increase in breast cancer rates in Iraq, it is important to screen for women at high risk for early detection and prevention. Biostatistician Mitchell Gill developed a mathematical model in 1989 to assess the risk of BCR based on the results of a large screening study of 284,780 women who underwent annual mammography screening, and because of the reliability and validity of the GM., It was used in the current study<sup>[18]</sup>.

As 18.1% among the USA women over the age of 40 in Mermer and Meseri study whereas it was 2.5% among the women aged 35–60 in Abu-Rustum et al. study<sup>[12,13]</sup>. Ewaid and Al-Azzawi in their study<sup>[14]</sup> found that the five year risk rate in Iraqi women was 0.95% and the lifetime risk was 11.134%. Fikree and Hamadeh<sup>[15]</sup> reported that the five year risk in Bahraini women was 0.7% and the lifetime risk was 9.3%. Erbil et al<sup>[16]</sup>

The Gail model qualifies women age 35 and older to try BC prevention if they have a five-year risk of 1.7% or more. In this study, there were 15 women who had a 5-year higher risk. Therefore, these women are eligible for BC prevention

Strategies. Iraqi Cancer Council statistics showed an increase in the incidence of BC in young Iraqi

women [ICB, 2010]. In this study, although the risk at five years and during ninety years of life was lower than the standard for the Gail model, those with a Gail score equal to or greater than 1.7% were considered high risk and recommended regular mammograms.<sup>[17,18]</sup> Chemoprophylaxis<sup>[32]</sup> and even prophylactic mastectomy<sup>[18,17]</sup>.

## Conclusion and Recommendation

Women's Iraqi should be given the chance to survey their risk of BC and give them direct screening strategies. The relationship between the possibility of ethnic differences and the environmental pollution might affect the applicability of the Gail model, so these factors must be studied well.

**Financial Disclosure:** There is no financial disclosure

**Conflict of Interest:** None to declare

**Ethical Clearance:** All experimental protocol were approved under university of Thi-Qar collage of education for pure sciences, biology department and all experimental carried out accordance with approved guidelines

## References

1. Veronesi, U.; Goldhirsch, A.; Orecchia, R.; Viale, G. and Boyle, P. Breast cancer. *Lancet*, 2005;365, 1727–1741.
2. Alwan, N.A). Breast cancer: demographic characteristics and clinic-pathological presentation of patients in Iraq. *East Mediterr Health J*. Nov. 2010b; 16 (11) : 1159 - 64.
3. Amir E, Freedman OC, Seruga B, Evans DG. Assessing women at high risk of breast cancer: review of risk assessment models. *J Natl Cancer Inst* 2010;102:1–12.
4. Bevers TB, Anderson BO, Bonaccio E, et al. NCCN clinical practice guidelines in oncology: breast cancer screening and diagnosis. *J Natl Compr Canc Netw* 2009;7:1060–96.
5. Eadie L, Enfield L, Taylor P, Michell M, Gibson A. Breast cancer risk scores in a standard screening population. *Breast Cancer Manage* 2013;2(6):1–17.
6. Erbil N, Dundar N, Inan C, Bolukbas N. Breast cancer risk assessment using the Gail model: a Turkish study. *APJCP* 2015, 2015.16.1.303.
7. Baytchev G, Inkov I, Kyuchukov N, Zlateva E. Breast cancer risk evaluation – a correlation between mammographic density and the Gail model. *I J Surgery Med* 2015;1(1):18–21.
8. Gail M, Brinton L, Byar D, et al. Projecting individualized probabilities of developing breast cancer for white females who are being examined annually. *J Natl Cancer Inst* 1989;81:1879–86.
9. De La Cruz P, Brittingham A. *The Arab population: 2000*. Washington, DC: US Census Bureau; 2003.
10. Ulusoy C, Kepenekci I, Koşse K, et al. Applicability of the Gail model for breast cancer risk assessment in Turkish female population and evaluation of breastfeeding as a risk factor. *Breast Cancer Res Treat* 2010;120:419–24.
11. Quillin JM, Fries E, McClish D, et al. Gail Model risk assessment and risk perceptions. *J Behav Med* 2004;27:205–14
12. Mermer G, Meseri R. Evaluation of breast cancer risk status of women aged 40 and above, living in Kemalpaşa District, Izmir. *STED J* 2011;20:51–6.
13. Abu-Rustum NR, Herbolzheimer H. Breast cancer risk assessment in indigent women at a public hospita. *Gynecol Oncol* 2001;81:287–90.
14. Ewaid, S. H., & Al-Azzawi, L. H. A. Breast cancer risk assessment by Gail Model in women of Baghdad. *Alexandria journal of medicine*, (2017);53(2), 183-186.
15. Fikree M, Hamadeh R. Breast cancer risk assessment among Bahraini Women. *Bahrain Med Bull* 2013;35(1).
16. Panahi G, Shabahang H, Sahebghalam H. Breast cancer risk assessment in Iranian women by Gail model. *MJIRI* 2008;22 (1):37–9.
17. Olopade OI, Artioli G. Efficacy of risk-reducing salpingo-oophorectomy in women with BRCA-1 and BRCA-2 mutations. *Breast J* 2004;10(1):S5–9.
18. Tierney LM, McPhee SJ, Papadakis MA. *Current medical diagnosis and treatment*. 44th ed. New York: McGraw-Hill; 2005. p. 682–4.

# ***In Silico* Study Chitosan Snail Shell as Antioxidant Through Interesting NRF2-KEAP1 in Hypercholesterolemia**

**Umarudin<sup>1</sup>, Dewi Ratih Tirto Sari<sup>2,3</sup>, Fatchiyah Fatchiyah<sup>2,3</sup>, Sri Rahayu<sup>2,3</sup>, Sri Widyarti<sup>2,3</sup>, Warsito<sup>4</sup>**

<sup>1</sup>Student, Department of Biology, Faculty of Mathematic and Natural Science, Brawijaya University, Malang, Indonesia, <sup>2</sup>Lecturer, Department of Biology, Faculty of Mathematic and Natural Science, Brawijaya University, Malang, Indonesia, <sup>3</sup>Researcher, Research center of SMONAGENES, Brawijaya University, Malang, Indonesia, <sup>4</sup>Lecturer, Department of Chemistry, Faculty of Mathematic and Natural Science, Brawijaya University, Malang, Indonesia

## **Abstract**

Hypercholesterolemia is one of the leading causes of endothelial dysfunction. Hypercholesterolemia can result in oxidative stress that exceeds antioxidant defenses. One of the antioxidants is snail shell chitosan. The research aimed to analyze the study of *in silico* chitosan snail shell as an antioxidant through inhibition of nrf2-keap1 in hypercholesterolemia. This research method is the 3D structure of Keap1 and Nrf2 (ID: 5CGJ) proteins. Canonical chitosan smiles (C<sub>56</sub>H<sub>103</sub>N<sub>9</sub>O<sub>39</sub>) (ID: 71853) were modelled with Corina software to obtain 3D structures. Chitosan was analyzed by Lipinski test. Molecular docking was analyzed by interacting chitosan, Nrf2 and Keap1 with HEX 8.0 software and visualized by discovery studio version 4.1. Data analysis was used descriptively. The results of the study of chitosan with Keap1 and Nrf2 had 43 amino acid residues (GLU444, ARG447, ASN387, ASP448, GLU79, LEU84, ALA407, TRP450, LEU76, ALA407, GLU447, LEU452, ASN495, ASN387, GLN73, GLU72, ASP79, ASP538, ASP589, GLU82, PHE70, LEU75, ASP77, GLY80, GLY81, LEU84, GLU540, ASP589, PRO549, ASN469, ASN517, ARG536, VAL536, THR545, ASP589, LEU84, GLU540, ASP538, ASP58979) and hydrogen, electrostatic, and hydrophobic bonds. Snail shell chitosan has potential activity as hypercholesterolemia because it has an affinity with nrf2 and keap1 proteins which can prevent the switch on gene process in the formation of antioxidants.

**Keywords:** *Hypercholesterolemia, oxidative stress, snail shell chitosan, NRF1, KEAP1.*

## **Introduction**

The cholesterol diet can change the picture of lipoproteins to be more atherogenic, namely increasing LDL, lowering HDL levels, and increasing plasma cholesterol. Increasing LDL levels in the body will increase the risk of LDL oxidation caused by various factors such as free radicals. Oxidized LDL will be recognized by the scavenger receptor in macrophages

and will become foam cells. The more LDL levels in the plasma, the more it will be oxidized and captured by macrophage cells, causing accumulation of macrophage cells. This accumulation causes reverse cholesterol transport to become unbalanced, which results in hypercholesterolemia<sup>1,2</sup>.

Oxidative stress occurs due to an imbalance between increased free radical production and decreased antioxidant capacity. The decline in antioxidants is mainly due to impaired activation of nuclear factor-erythroid-2 related factor 2 (Nrf2) and keap1, the transcription factor that regulates genes encoding antioxidants and detoxification enzymes<sup>3-5</sup>.

In the presence of oxidative stress, electrophiles and reactive oxygen species (ROS) can react with KEAP1

---

### **Corresponding Author:**

**Umarudin**

Department of Biology, Faculty of Mathematics and Natural Science, Brawijaya University, Malang, Indonesia

e-mail: umarudin@student.ub.id

sensor cysteines, including cysteine 151 (C151), C273, and C288, possibly releasing NRF2 from KEAP1-mediated degradation<sup>6-8</sup>, so that newly synthesized NRF2 occurs in the nucleus and activates the expression of scattered Nrf2 and degradation occurs in the cytoplasm<sup>9</sup>. KEAP1-NRF2 activates NRF2. Activated NRF2 accumulates in the nucleus, resulting in interactions with transcription factors and other cofactors to regulate the transcription of the target gene, which encodes a protein whose role is antioxidants<sup>10</sup>.

Exogenous antioxidants are needed to compensate for this is snail shell chitosan. So far, snail shell chitosan has not been studied scientifically as an antioxidant *in silico*. In this study, using *in silico* with computational modelling which is closely related to *in vitro* and *in vivo* experiments. This modelling plays a role in the field of medicinal chemistry to find bioactive compounds that have drug candidates<sup>10-13</sup> *in silico* test using docking molecules that are predicted as target cells to be determined. This research aims to analyze preliminary studies of molluscs as chitosan producers and to predict activity as antioxidants.

## Method

The 3D structures of Keap1 and Nrf2 proteins (ID: 5CGJ) were downloaded from the PDB database. Canonical smiles chitosan (C<sub>56</sub>H<sub>103</sub>N<sub>9</sub>O<sub>39</sub>) (ID: 71853) from the PubChem database modelled with Corina software to obtain 3D structures. Chitosan was analyzed by Lipinski test. Molecular docking was analyzed by interacting chitosan, Nrf2 and Keap1 with HEX 8.0 software and visualized by discovery studio version 4.1. The analysis includes H-bond, SAS, Hydrophobicity, Aromatic, Interpolated Charge, and Ionizability.

## Results

Table 1 shows that the conditions that must be met by a compound based on Lipinski are a molecular weight of the compound <500 Da, there are no compounds with more than 5 hydrogen bond donors, the number of hydrogen acceptors <10, while for molar refractivity ranges from 40-130 and the value Log P <5, the ligand tested has met the requirements so that it is confirmed to be able to pass through the cell membrane.

**Table 1. Lipinski Test Results**

Ligand	Molecular Weight (Da)	Number of Hydrogen Bonds	Amount of Acceptor Hydrogen Bonds	Molar Refractivity	Log p	Term
Chitosan	312 Da	5	6	77.146	-0.053	Meets specifications

## Discussion

In this study, the molecules studied had a higher number of rotatable bonds and had a good ability to bind Nrf2 and Keap1 because the molecules used were polymers. It is seen that the number of hydrogen bond acceptors is directly related to the binding properties of the amino acid residues; It can be seen that the results of docking chitosan→keap1, chitosan + Keap1→Nrf2, chitosan→Nrf2, chitosan + Nrf2→Keap1. The results of chitosan docking to 1 amino acid residue were SER391, SER408, THR388, ARG447, GLU444, ASP389, GLU444, ARG447, ASN387, and ASP448 with the hydrogen bond category. Docking, chitosan + Keap1→Nrf2 amino acid residues produced are SER391, SER408, THR388, ARG447, GLU444, ASP389, GLU79, LEU84, ALA407, TRP450, LEU76, ALA407, GLU447, LEU452, ASN495, GLN387, AL73A69, ASP77, THR80, LEU84, PHE83, GLU79

with the hydrogen bond category, the resulting docking results of chitosan→Nrf2 amino acid residues are LEU84, ALA72, GLN75, GLU72, ASP77, GLU79, ASP79, ASP77, LEU84, and GLU79 The bonds obtained are electrostatic and hydrogen. In contrast, the results of chitosan + Nrf2→Keap1 docking are ARG536, ASP538, LEU84, ALA72, GLN75, ASP589, GLU82, PHE70, LEU75, ASP77, GLU79, THR80, GLY80, GLY81, LEU84, GLU540, ASP589, PRO549, ALA69, PHE83 ASN517, ARG536, VAL536, THR545, ASP589, LEU84, ASP77, GLU540, ASP538, ASP589, ALA548, TRP591 and GLU79, electrostatic, hydrogen, and hydrophobic bonds.

The docking results showed that the different amino acid residues were chitosan →keap1: GLU444, ARG447, ASN387, and ASP448. Chitosan + Keap1→Nrf2 are GLU79, LEU84, ALA407, TRP450, LEU76, ALA407, GLU447, LEU452, ASN495, ASN387,

GLN73, Chitosan→Nrf2: GLU72, ASP79. Chitosan + Nrf2→Keap1: ARG536, ASP538, ASP589, GLU82, PHE70, LEU75, ASP77, GLY80, GLY81, LEU84, GLU540, ASP589, PRO549, ASN469, ASN517, ARG536, VAL536, THR545, ASP538, LEU ASP589, ALA548, TRP591 and GLU79.

Hydrophobic interactions play a role in determining the stability of the ligands against androgen receptors. Hydrophobic interactions avoid a liquid environment and tend to cluster within the globular structure of proteins. The results of this study are by several previous studies which stated that drug candidates generally have the number of hydrogen bonding bonds<sup>14-16</sup>, because the average number of hydrophobic atoms in drugs is generally<sup>16</sup>, with one to two donors and three to four acceptors<sup>17</sup>, so that hydrophobic interactions play an important role in drug candidates because they can increase the binding affinity between target interfaces. The in silico test proved that the binding affinity and drug efficacy associated with hydrophobic bonds could be optimized by combining them at the hydrogen bond site<sup>18,19</sup>. However, this approach is not the only primary method for designing a drug. The formation of hydrophobic bonds minimizes the interaction of nonpolar residues with water. Chitosan + Keap→Nrf2 obtained 3 hydrophobic bonds, namely ALA407, TRP450, and LEU76. Chitosan + Nrf2→Keap1 obtained 3 hydrophobic bonds, namely ALA69, PHE70, and PHE83. The residue on these amino acids is hydrophobic and nonpolar. Nonpolar (hydrophobic) amino acid residues tend to form groups in the interior of the protein<sup>20,21</sup>.

Based on the value of the bond energy obtained, it shows that chitosan compounds have potential activity as hypercholesterolemia because they have an affinity and form hydrogen-protein bonds between chitosan and nrf2 and keap1 proteins, so that chitosan can block receptors (keap1) and ligands (nrf2) so that they can be inhibited.

### Conclusion

In conclusion, Snail shell chitosan has potential activity as hypercholesterolemia because it has affinity by forming hydrogen bonds with nrf2 and keap1 proteins and can inhibit hypercholesterolemia in silico.

**Conflict of Interest:** The author declare that they have no conflict of interest.

**Source of Funding:** This study was supported by LPDP BUDIDN.

**Acknowledgements:** We thank Arif Nur Muhammad Ansori, Viol Dhea Karisma, Rasyadan Taufiq Probojati for editing the manuscript.

**Ethical Approval:** Not needed.

### References

1. Powers SK, Jackson MJ. Exercise Induced oxidative stress: cellular mechanisms and impact on muscle force production. NIHPA Manuscript; 2010.
2. Yang R. Effect of antioxidant capacity on blood lipid metabolism and lipoprotein lipase activity of rats fed a high-fat diet. *Nutrition*. 2006; 22: 1185-1191.
3. Small DM, Coombes JS, Bennet N, *et al*. Oxidative stress, anti-oxidant therapies and chronic kidney disease. *Nephrol*. 2012; 17: 311-321.
4. Ruiz S, Pergola PE, Zager RA, Vaziri ND. Targeting the transcription factor Nrf2 to ameliorate oxidative stress and inflammation in chronic kidney disease. *Kidney Int*. 2013; 83(6): 10291041.
5. Aminzadeh MA, Nicholas SB, Norris KC, Vaziri ND. Role of impaired Nrf2 activation in the pathogenesis of oxidative stress and inflammation in chronic tubule-interstitial nephropathy. *Nephrol Dial transpl*. 2013; 28(8): 2038-45.
6. Kim HJ, Vaziri ND. Contribution of impaired Nrf2-Keap1 pathway to oxidative stress and inflammation in chronic renal failure. *Am J Physiol Renal Physiol*. 2010; 298: F662-F671.
7. McMahon K, Itoh M, Yamamoto, *et al*. Keap1-dependent proteasomal degradation of transcription factor Nrf2 contributes to the negative regulation of antioxidant response element-driven gene expression. *J Biol Chem*. 2003; 278: 21592–21600.
8. Baird L, Lleres D, Swift S, *et al*. Regulatory flexibility in the Nrf2-mediated stress response is conferred by conformational cycling of the Keap1-Nrf2 protein complex. *Proc Natl Acad Sci*. 2013; 110: 15259–15264.
9. Kansanen E, Kuosmanen SM, Leinonen H, *et al*. The keap1-Nrf2 pathway: mechanisms of activation and dysregulation in cancer. *Elsevier. Redox Biology*. 2013; 1: 45-49.

10. He F, Ru X, Wen T. NRF2 a Transcription factor for stress response and beyond. *Int J Mol Scie.* 2020; 21: 4777, 2-23.
11. Schlick. *Molecular modeling and simulation, an interdisciplinary guide.* 2nd ed., New York. Springer Science+Business Media; 2010.
12. Ahmed A, Kazemi S, Gohlke H. *Protein flexibility and mobility in structure-based drug design, Dissertation, Frankfurt Germany, JW Goethe-University; 2007.*
13. Siswandono. *Kimia medisinal I, edisi kedua, Surabaya: Airlangga University Press; 2016.*
14. Fagerholm. Prediction of human pharmacokinetics gut wall metabolism. *J Phar Pharmacol.* 2007; 59: 1335-1343.
15. Pornputtpong N, Suriyapakorn B, Satayamapakorn B, *et al.* In silico analysis for factors affecting anti-malarial penetration into red blood cells. *Trad Med J.* 2020; 20(1): 7-15.
16. Panigrahi SK. Strong and week hydrogen bonds in protein-ligand complexes of kinases: a comparative study. *Amino Acids.* 2008; 34: 617–633.
17. Davis AM, Teague SJ. Hydrogen bonding, hydrophobic interactions, and failure of the rigid receptor hypothesis. *Angew Chem Int Ed.* 1999; 38: 736–749.
18. QianSB, WaldronL, ChoudharyN, *etal.* Engineering a ubiquitin ligase reveals conformational flexibility required for ubiquitin transfer. *J Biol Chem* 284: 26797–26802
19. LIPINSKI, C. A. Lead- and drug-like compounds: the rule-offive revolution. *Drug Disc. Today: Technol.* 2004; 1: 337-341.
20. Sharp KA, Honig B. Electrostatic interactions in macromolecules: theory and applications. *Annu Rev Biophys Biophys Chem.* 1990; 19: 301-322.
21. Bosshard HR, Marti DN, Jelesarov I. Protein stabilization by salt bridges: concepts, experimental approaches and clarification of some misunderstandings. *J. Mol. Recogn.* 2004; 17(1): 1-16.
22. Buckingham AD, Fowler PW, Hutson JM. Theoretical studies of van der Waals molecules and intermolecular forces. *Chem Rev.* 1988; 88(6): 963–988.

# Synthesized Gold Nanoparticles Using *Pseudomonas* Supernatant and Study the Physical Characterization–Antiproliferative Activity of Breast Cancer Cells (MCF-7)

Karrar Nadhim<sup>1</sup>, Nibras Nazar Mahmood<sup>2</sup>, Aseel Mustafa<sup>1</sup>

<sup>1</sup>Assist. Lect., Physics Department, Mustansiriyah University, Iraq,

<sup>2</sup>Prof., Biological Department, Mustansiriyah University, Iraq

## Abstract

In this paper we used a biological method to prepare gold nano particles as a simple technique, environmentally friendly and limited toxics compared with chemical and physical method. Where used *Pseudomonas* bacteria supernatant to prepare gold nano particles and use this supernatant to reduction gold salt ( $\text{HAuCl}_4 \cdot 4\text{H}_2\text{O}$ ) and converted to AuNPs. XRD measurement showed the average the crystallite size ranging from (9.2-11.4) nm, UV-VS spectrum exhibited the maximum absorbance peak at (530)nm and optical energy gap ( $E_g = 1.88$ )e.v, FESEM image showed the shapes of AuNPs as (spherical and semispherical), TEM image showed the formation of particles as clusters, spherical and hexagonal shapes. AuNPs was used as anticancer cell line where testing against breast cancer line (MCF-7) and interested result indicated that can be used AuNPs in reliably as an active treatment to those have breast cancer (MCF-7).

**Keywords:** Gold Nanoparticles, MCF-7, Anticancer.

## Introduction

Gold is one of precious metals that was discovered in nature by human and used in jewelry making Gold is also used not only for jewelry, but also for industrial uses and applications in the fields of biology and medicine etc.<sup>(1)(2)(3)(4)(5)</sup>

Physical and chemical method succeeded in the manufacture of many nanomaterials that are high purity, but in return there are negative sides such as the high cost and risks of chemical reactions The biological method has no chemical risks as well as is less costly and environmentally friendly. Biosynthesis of gold is being different size from Several nanometer to hundreds of nanometers and different shapes.<sup>(6)(7)(8)</sup>

AuNPs are formed by the reduction of Gold salts in the solution through various reduction agents in the solution.<sup>(9)(10)</sup>

Rapid reduction results NPs in large particles and spherical shape in general as for slow reduction results NPs in small particles.<sup>(7)(9)</sup>

**Safety aspect of NPs:** The properties of Many Materials change when they are reduced to nanoscale as the surface area of the particles increased resulting in interactions with environment. Nanomaterials are of limited toxicity and therefore have the advantage in medicine, biochemistry and nanotechnology.<sup>(11)(12)(13)(14)</sup>

## Materials and Method

To preparing the Nutrient broth medium (NBM) we suspended 0.8 gm of the medium in 100 ml deionized water. Mix well and dissolve with frequent agitation for one minute until complete dissolution. And finally sterilizes it in Autoclave for 15 min in 15 lb and 121 C.<sup>(15)</sup>

***Pseudomonas* culture:** To preparing of *Pseudomonas* culture solution, under sterile environment, we were

---

### Corresponding Author:

**Karrar Nadhim**

Assist. Lect., Physics Department, Mustansiriyah University, Iraq

e-mail: karrar.nadhim@yahoo.com.au

taken a full loop of new activated *Pseudomonas* bacteria (which provided from biological department- Science Faculty/University of mustansiriyah) and cultured in 100 ml flask of nutrient broth medium then incubated for 24hr under 37 °C.

**Preparation of bacterial supernatant:** After 24hr of culturing, we centrifuge the culture tube at 5000 rpm, and take the supernatant in quiet and kept it in +4 °C, until preparing gold nanoparticles.

Preparation 0.02 M of gold (III) chloride tetrahydrate (HAuCl<sub>4</sub>·4H<sub>2</sub>O) stock solution:

To preparation of a stock solution of gold salts, dissolved 1gm of (HAuCl<sub>4</sub>·4H<sub>2</sub>O) in 100ml of deionized water. Then we calculated the stock concentration according to the following equation:-<sup>(16)</sup>

$$M = \frac{Wt}{Mwt} \times \frac{1000}{V}$$

M=Molarity,

Wt=weight of (HAuCl<sub>4</sub>·4H<sub>2</sub>O) (1)gm

Mwt= Molar mass of HAuCl<sub>4</sub>·4H<sub>2</sub>O is 411.8476 g/mol

V=Volume of deionized water=100ml

$$\text{So: } M = \frac{1\text{gm}}{411.8476 \text{ gm/mol}} \times \frac{1000}{100\text{ml}}$$

$$= 0.02 \text{ Molar}$$

**Synthesis of (Au-NPs) by using *Pseudomonas* bacteria:** To synthesis of Au-NPs, 0.5 ml of HAuCl<sub>4</sub>·4H<sub>2</sub>O stock solution which prepared was added dropwise in 25 ml glass tube with screw cupcontains of 2ml of bacterial supernatant and 7.5 ml deionized water as shown (figure 1) a,b,c, the final volume will be 10ml. The concentration of HAuCl<sub>4</sub>·4H<sub>2</sub>O in this solution calculated according to the following equation:-<sup>(17)</sup>

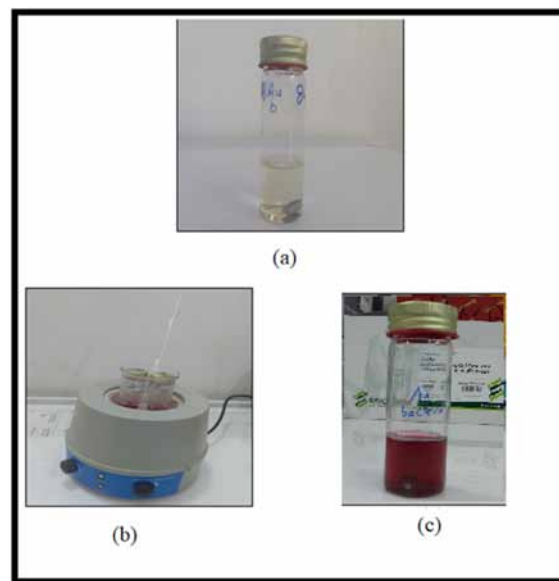
$$C1 \times V1 = C2 \times V2$$

$$0.02 \times 0.5 = C2 \times 10$$

$$C2 = \frac{0.02 \times 0.5}{10} = 0.001 \text{ Molar}$$

Then, the glass tube was placed in the heating mantle with inserting the thermometer and thermostat,

the temperature was raised until 80-85°C for 30 min, the color of the solution will change to dark red which indicated to synthesized the gold nanoparticles. Also, we controlled the pH value (7.5-8) of this reaction by added 0.25 ml of NaOH at concentration 0.1 Molar.



**Figure (1) prepared gold nanoparticles from bacteria supernatant**

- (a) Solution contain of (0.5 ml of HAuCl<sub>4</sub>·4H<sub>2</sub>O+ 2 ml of bacteria supernatant+ 7.5 mlD.W)
- (b) Solution of Au NPs during preparation
- (c) Solution of Au NPs after preparation

## Results and Discussion

**XRD analysis:** Formation of gold nanoparticles by biological method using Bacterial supernatant was assured by XRD spectrum as shown in figure (5) peaks (111) (200), (220), and (311) point out FCC phase of gold nanoparticle, the peak broadening in XRD pattern indicates that small nanocrystallite are work out in specimens.

The average crystallite size was calculated using scherrer's equations and its values was found to be in the range (9.2 to 11.4) nm. Result of figures (2)a are agreement with<sup>(18)</sup>

**UV-Vis measurements:** The absorbance spectra for sample of gold NPs solution prepared from bacteria supernatant was investigated by uv-vis spectroscopy. (Figure 2) b shows absorbance spectra of Au NPs solution at concentration (100 ppm) with images of collides. Investigation shows presence of absorbance peak at 530



nm for NPs prepared from bacteria supernatant. Which corresponding to surface plasmon resonance (SPR) of Au NPs, and this result is agreement with<sup>(19)(20)(21)(22)</sup>

The optical energy gap ( $E_g^{op}$ ) of AuNPs is calculated from the following equation:

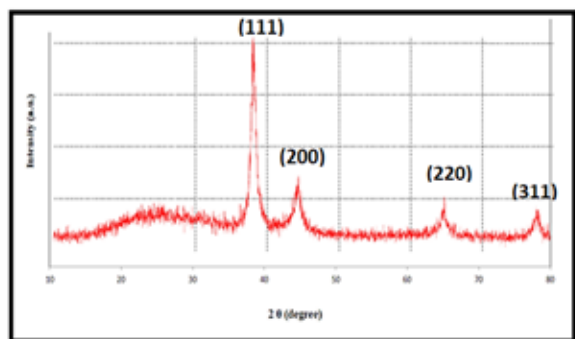
$$\propto h\nu = B(h\nu - E_g)^n$$

Where ( $h\nu$ ) is incident photon energy

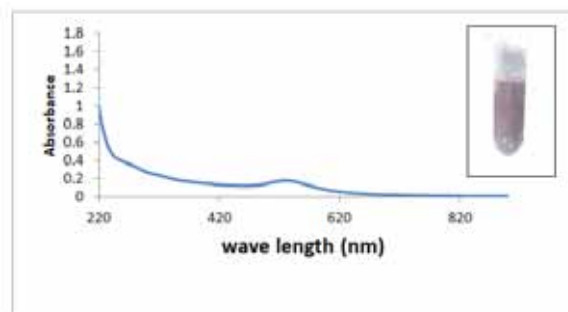
(B) is constant, (n) is constant take Value (1/2, 3/2, and 3) depend on type of the optical transitions (direct or indirect)

where the values of energy gap for AuNPs solution prepared from bacterial supernatant ( $E_g^{op} = 1.88$ ) e.v, the reason for appearance band gap energy due to quantum size effect.

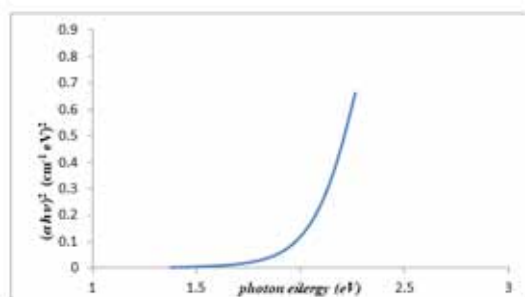
The figures (2)a,b,c show XRD pattern, Absorbance and optical energy gap for gold nanoparticle



(a)



(b)



(c)

**Figure(2): a) XRD pattern of gold nanoparticles prepared by Biological method using Bacteria supernatant, b) Absorbance as a function of wavelength for gold colloids nanoparticles prepared by Biological method using Bacteria supernatant, c) Variation of  $(\alpha h\nu)^2$  with  $h\nu$  for direct transition in Au NPs prepared from Bacteria supernatant**

**FE-SEM:** By examining the FE-SEM of gold nanoparticles prepared from Bacteria supernatant, as shown a (figure 3 a) imagewith magnification (100 kx). the shapes were semispherical and spherical with random shapes. and it can be note that the agglomeration percentage is high in the image. The average of grain size was found in the range from (12.13 – 37.8)nm.

**TEM:** Figure (10b,c) show the TEM image of Gold nanoparticles - prepared from bacterial supernatantat (pH = 7.5-8) and concentration (100ppm), with (125000x) magnification, the image reveal formation of gold nanoparticles with spherical,semispherical and hexagonal shapes. The average particle diameter between (10 to 40) nm, which agreement with FE-SEM result and very closely with XRD result.(figure b,c)



Figure (3)a: FE-SEM images recorded by deposited gold-DW nanoparticles on pure glass slide; b,c: TEM image of gold nanoparticles prepared by Biological method using Bacteria supernatant

**Cytotoxic Effect of synthetic Au-NPs using *Pseudomonas sp.* supernatant on MCF-7 Tumor Cell Lines using MTT colorimetric assay:** The cytotoxic activity of Au-NPs which synthesized via using *Pseudomonas sp.* supernatant was determined by MTT colorimetric assay. As shown in Table 1 and (figure 4), the cytotoxic (Viability percentage) of created Au-NPs was not affected significantly ( $p > 0.05$ ) with 6.25 and 12.5  $\mu\text{g/mL}$  concentrations. While, the cytotoxicity was increasing significantly with increasing of synthesized Au-NPs concentrations ( $P < 0.05$ ). Moreover, this assay

showed that the minimum inhibitory concentration of MCF-7 cells and WRL68 by reaction with synthesized Au-NPs were obtained at 6.25  $\mu\text{g/mL}$  ( $95.602 \pm 1.505$  and  $95.833 \pm 0.579$  respectively). However, the maximum inhibition concentration at 400  $\mu\text{g/mL}$  ( $54.707 \pm 1.124$  and  $77.585 \pm 1.238$  respectively; Table (1). Also, when reacted of synthesized Au-NPs with the normal cell line cells, the median lethal dose ( $IC_{50}$ ) was 117.4, while it was reduced to 51.66 in MCF-7 cells (figure 11) and this result agree with<sup>(23)</sup>.

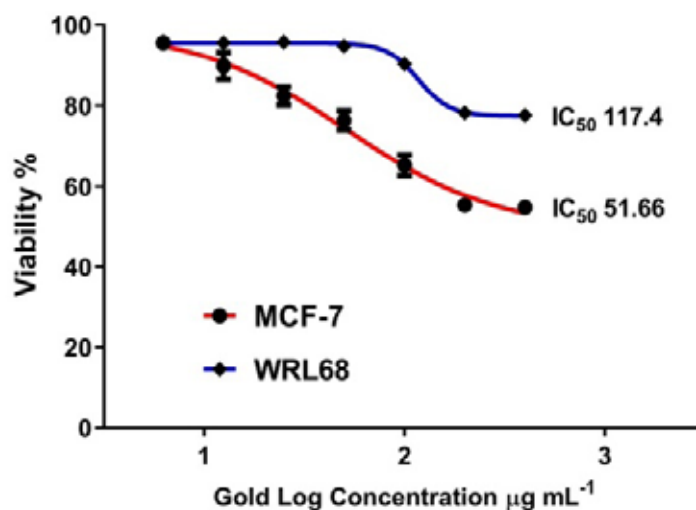


Figure. 4 Comparison of the viability percentage of MCF-7 cells and WRL68 versus the logarithm of the concentration of synthetic Au-NPs using *Pseudomonas sp.* supernatant.

Table 1: Viability percentage of MCF-7 and WRL68 tumor cell line, and degree of freedom (Df) regarding to different concentrations of synthesized Au-NPs using *Pseudomonas sp.* supernatant

Mean percentage (%) for each cell line					
Row stats	Au-NPs Concentration (ppm)	MCF-7		WRL68	
		Mean±SD	Df (n-1)	Mean±SD	Df (n-1)
1	400	54.707±1.124	2	77.585±1.238	2
2	200	55.324±1.219	2	78.241±1.632	2

Mean percentage (%) for each cell line					
Row stats	Au-NPs Concentration (ppm)	MCF-7		WRL68	
		Mean±SD	Df (n-1)	Mean±SD	Df (n-1)
3	100	65.201±2.604	2	90.316±1.772	2
4	50	76.350±2.401	2	94.753±0.788	2
5	25	82.407±2.259	2	95.795±0.372	2
6	12.5	98.892±3.323	2	95.602±0.531	2
7	6.25	95.602±1.505	2	95.833±0.579	2

**Ethical Clearance:** The Research Ethical Committee at scientific research by ethical approval of both MOH and MOHSER in Iraq.

**Conflict of Interest:** None

**Funding:** Self-funding

### References

- Salata OV Application of nanoparticles in biology and medicine. *J Nanobiotechnol* (2004) 2:3–9
- Sperling RA, Gil PR, Zhang F, Zanella M, Parak WJ Biological application of gold - nanoparticles. *Chem Soc Rev* (2008) 37:1896–1908
- Cai W, Gao T, Hong H, Sun J Applications of gold nanoparticles in cancer nanotechnology, *Nanotechnol Sci Appl* (2008) 1:17–32
- Chen PC, Mwakwari SC, Oyelere AK, Gold nanoparticles: from nanomedicine to nanosensing. *Nanotechnol Sci Appl*,(2008) 1:45–66
- Vieira RSHS, Volesky B, Biosorption: a solution to pollution. *Int Microbiol*,(2000), 3:17–24
- Brust M, Walker M, Bethell D, Schiffrin DJ and Whyman R Synthesis of thiol derivatised gold nanoparticles in a two-phase liquid/liquid system. *Chem Commun*:(1994), 801-802
- Selvakannan PR, Mandal S, Phadtare R, Pasricha R, Sastry M, Capping of gold nanoparticles by the amino acid lysine renders them water-dispersible. *Langmuir*,(2003),19:3545–3549
- Daniel M-C, Astruc D, Gold nanoparticles: assembly, supramolecular chemistry, quantum size-related properties, and applications toward biology, catalysis and nanotechnology. *Chem Rev*,(2004), 104:293–346
- Handley DA, Method for synthesis of colloidal gold, Chap. 2. In: Hayat MA (ed) *Colloidal gold: principles, method and application*, vol 1. Academic, San Diego, (1989), pp 13–33
- Masala O, Seshadri R, Synthesis routes for large volumes of nanoparticles. *Annu Rev Mater Res*, (2004), 34:41–81
- Gwinn MR, Vallyathan V, Nanoparticles: health effects: pros and cons. *Environ Health*, (2006), Persp 114:1818–1825
- Akerman ME, Chan WC, Laakkonen P, Bhatia SN, Ruoslahti E, Nanocrystal targeting in vivo. *Proc Nat Acad Sci USA*,(2002),99:12617–12621
- Cao YC, Jin R, Mirkin CA, Nanoparticles with Raman spectroscopic fingerprints for DNA and RNA detection. *Science*,(2002),297:1536–1540
- Georganopoulou DG, Chang L, Nam J, Thaxton CS, Mufson EJ, Klein WL, Mirkin CA From the cover: nanoparticle based detection in cerebral spinal fluid of a soluble pathogenic biomarker for Alzheimers disease. *Proc Natl Acad Sci*,(2005), 102:2273–2276
- Bruchez J, Moronne MM, Gin P, Weiss S, Alivisatos AP Semiconductor nanocrystals as fluorescent biological labels. *Science*, (1998), 281:2013–2016.
- MacFaddin J. F., *Media for the Isolation-Cultivation-Identification-Maintenance of Medical Bacteria*, Vol. 1, Williams and Wilkins, Baltimore,1985.
- Chris Hren (Author), Peter J. Mikulecky, *Chemistry Workbook For Dummies with Online Practice, For Dummies*; 2017,3 edition.
- Vo, T. T., Nguyen, T. T. N., Huynh, T. T. T., Vo, T. T. T., Nguyen, T. T. N., Nguyen, D. T., Nguyen, T. D. Biosynthesis of silver and gold nanoparticles using aqueous extract from crinum latifolium leaf and their applications forward antibacterial effect and wastewater treatment. *Journal of Nanomaterials*, 2019. <https://doi.org/10.1155/2019/8385935>

19. Kumar PV, Kala SMJ, Prakash K.S. Green synthesis of gold nanoparticles using *Croton Caudatus* Geisel Leaf extract and their biological studies. *Materials Letters*,(2018),236: 12
20. Chen MN, Chan CF, Huang SL, Lin YS. Green biosynthesis of gold nanoparticles using *Chenopodium formosanum* shell extract and analysis of the particles' antibacterial properties. *J Sci Food Agric*.(2019). 99(7):3693-3702
21. Ben Tahar, I., Fickers, P., Dziedzic, A., Płoch, D., Skóra, B., & Kus-Liśkiewicz, M., Green pyomelanin-mediated synthesis of gold nanoparticles: modelling and design, physico-chemical and biological characteristics. *Microbial Cell Factories*,(2019), 18(1), 210
22. Manar E Selim 1, Awatif A Hendi, "Gold nanoparticles induce apoptosis in MCF-7 human breast cancer cells", *Asian Pac J Cancer Prev* . 2012;13(4):1617-20.
23. Manar E Selim, Awatif A Hendi, Gold nanoparticles induce apoptosis in MCF-7 human breast cancer cells, *Asian Pac J Cancer Prev* . 2012,13(4):1617-20.

# Molecular Detection of Tumor Necrosis Factor-Alpha (TNF- $\alpha$ ) Gene in Mycotic aborted Placenta of Ewes Using RT-PCR

Bushra Hamza Fares<sup>1</sup>, Hameed Abdul Hussain Al-tememy<sup>2</sup>,  
Ban Abbas Abdulmajeed<sup>3</sup>, Mohammed M. Dakheel<sup>4</sup>

<sup>1</sup>Assistant Professor, Department of Pathology/Faculty of Veterinary Medicine/University of Kufa/Iraq, <sup>2</sup>Scientific Researcher, Department of Poultry Diseases/Najaf Veterinary Hospital/Iraq, <sup>3</sup>Professor, Department of Pathology/College of Veterinary Medicine/University of Baghdad/Iraq, <sup>4</sup>Lecture, Department of Veterinary Public Health/College of Veterinary Medicine/University of Baghdad/Iraq

## Abstract

**Background:** Abortion is associated with altered inflammatory molecule expression at the maternal-fetal interface. (TNF- $\alpha$ ) are inflammatory proteins and display cytokine as a function that enhances the leukocyte recruitment to the inflammatory site.

**Objectives:** This work aimed at establishing the TNF- $\alpha$  gene expression in mycotic aborted placental animals as opposed to normal delivery.

**Materials and Method:** Using the technique Real Time-Polymerase Chain Reaction (RT-PCR), TNF- $\alpha$  DNA, tested in the mycotic aborted Placenta group (15 cases), normal delivery group (15 cases).

**Results:** The levels of TNF- $\alpha$  DNA expressed in the Placenta varied significantly between the two groups ( $P < 0.05$ ), respectively. The expression of TNF during abortion was significantly higher than in normally delivered models.

**Conclusion:** These findings indicate that both cytokines Th1 and Th2 play a key role in the pathogenesis of abortion. TNF  $\alpha$  is likely a source of abortion's genetic susceptibility. There had been a strong correlation between the two cytokines and abortion.

**Keywords:** Tumor necrosis, Factor-alpha, (TNF- $\alpha$ ) gene, RT-PCR, Mycotic abortion.

## Introduction

Inflammatory processes caused by host resistance to infection or by infection-independent immune disorders pose a major challenge for successful pregnancy<sup>[1,2]</sup>. Inflammatory mediators, particularly tumor necrosis factor- $\alpha$  (TNF $\alpha$ ), which act on the gestational tissues to damage the supply and function of the placental blood<sup>[3]</sup> and cause fetal injury<sup>[4]</sup>, eventually leading to

placental and fetal death. In fact, the predominance of cellular immunity in abortion results in a rejection of the embryo. TH-1 type cells induced by the infection may cross the interface of the fetus or may produce trophoblastic inflammatory cytokines<sup>[5]</sup>.

The development of these cytokines is partially regulated by genetic regulation and the level of production of cytokines has been found to be associated with genetic polymorphisms, particularly TNF  $\alpha$  and IFN gamma<sup>[6]</sup>. There is a relation between TNF- $\alpha$  gene polymorphism and abortion risk<sup>[7]</sup>. Mycotic abortion (fungal abortion, mycotic placentitis), caused by many fungi, is a cosmopolitan, contagious, intermittent, animal, particularly sheep, infection of the genital tract; moreover, Magee and Cox<sup>[8]</sup> found that passive

---

### Corresponding Author:

**Bushra Hamza Fares**

Assistant Professor, Department of Pathology/Faculty of Veterinary Medicine/University of Kufa/Iraq  
e-mail: aimen.mohammed@alkafeel.edu.iq

serum transfer from the Formalin-killed spherules (FKS) mice vaccine did not protect the recipients; however, Raghupathy<sup>[9]</sup> who also noticed that neither serum nor immune B-cells transferred protection against mice attack. However, the role of a coccidioidomycosis humoral-immune response remains unclear<sup>[10]</sup>.

In this study, real-time polymerase chain reaction (RT-PCR) detected the expression of TNF- $\alpha$  DNA in mycotic aborted sheep for Placenta; thus, revealing the link between aberrant TNF- $\alpha$  DNA expression and abortion. It is the first study that showed that mycotic aborted animals had increased expression of alpha TNF. In fact, changed expression of those inflammatory molecules can contribute to the pathophysiology of abortion.

### Materials and Method

Fifteen samples of the mycotic of the aborted placenta, which was collected from aborted ewes, were collected from various areas of Al-Najaf City, and fresh placental tissue was subjected to complete DNA extracted using Genomic DNA Mini Extraction Kit (KAPA BIOSYSTEM, USA).

These samples were taken from November 2018 to November 2019, following instructions from the manufacturer RT-PCR for the molecular analysis of the genes TNF-alpha. Fresh placental tissue was subjected to complete DNA extraction using the Genomic DNA Mini Extraction Kit (KAPA BIOSYSTEM, USA), following the manufacturer instructions.

**Quantitative Real-time PCR:** Real-time PCR was made using TNF alpha primers (forward GAA TAC CTG GAC TAT GCC GA, reverse CC TCA CTT CCC TAC ATC CCT) according to the manufacturer's protocol (Applied Biosystem).

Quantitative RT-PCR reactions were conducted in 20  $\mu$ l containing 10  $\mu$ l KAPA SYBER\* (KR0393\_S – v2.17) FAST qPCR Master Mix(2X), 0.4  $\mu$ l forward Primer(10  $\mu$ M), 0.4  $\mu$ l Reverse Primer(10  $\mu$ M), 0.4 d UTP (10  $\mu$ M), 0.4 ROX High/Low, 0.4  $\mu$ l KAPA RT Mix (50x), and 3  $\mu$ l deionized water DNA template up to 20  $\mu$ l. The cycling conditions were as follows for all genes: 10 min at 95 °C, 40 cycles of 30 seconds at 95 °C, 40 cycles of 30 seconds at 95 °C, 1 min at 55 °C and 1 min at 72 °C followed by a melt curve starting at 65 °C rising to 94 °C at 0.3 per-second.

**Statistical Analysis:** The differences between the means were analyzed with Student's t-test for unpaired samples; the *P-value* < 0.05 was considered to be significant the differences between. Analysis of the aborted and normal expressions of TNF alpha placental samples were performed using SPSS v.19.0 (SPSS Inc., Chicago, USA).

### Results

The placenta immune response was characterized by an analysis of the aborted TNF- $\alpha$  and normal placentomes of delivery, Table(1). All the cytokines showed substantial increases compared to the animals given one. Those results were analyzed when aborted animals did not show any differences with the control sheep; thus, the interpretation was identical regardless of the duration of the abortion. Similarly, the increase in TNF- $\alpha$  transcription among the aborted groups was similar.

**Table 1: Comparison of cytokine expression between two groups**

	Mean	N	Std. Deviation	Std. Error
Normal	17.5200	15	0.76278	0.31141
Aborted	22.1067	15	3.05502	1.24721

TNF- $\alpha$  DNA levels expressed in Placenta differed considerably between the two groups ( $P < 0.05$ ) respectively. The number of cases showing over-expression of TNF alpha in the aborted placenta was 15 of 20 (80 %), which was statistically important from controls.

In placental aborted research median alpha, TNF fold transformation was found to be 22.1067 Relative to the controls which were 17.5200.

### Discussion

The inflammatory response in abortion which is necessary for an ordinary pregnancy is sought to be altered. Nonetheless, a motherly immune response is a primary determinant of success or failure in pregnancy<sup>[11]</sup>. However, the inflammation of mediated pregnancy is a well-studied phenomenon in rodents, which is used as a basis for spontaneous pregnancy loss. Further, Aberrant inflammatory and environment are related to uteroplacental perfusion dysfunction, the incidence of thrombotic events, and placental and fetal hypoxia<sup>[12]</sup>.

Several studies on the role of TNF polymorphisms show the impact of the various alleles on *in vitro* and *in vivo* production of TNF levels<sup>[12]</sup>. Nevertheless, a recent study showed that not only polymorphisms within the TNF cluster are necessary to regulate the production of TNF but also receptors (TNF R)<sup>[13]</sup>. This result suggested that research into polymorphisms within the TNF cluster and TNF receptors will be important in understanding the role of TNF regulation in a given disease.

A substitution of (G) to (A) in role-308 in the tumour necrosis factor-alpha (TNF-alpha) gene promoter increases the transcription of TNF-alpha *in vitro* by around 6 to 9 folds<sup>[13]</sup>. Paracoccidioidomycosis (PCM) has associated polymorphisms in other genes, such as cytokines, which play a role in the immune response, which involve polymorphisms of IL-10(1082 G/A) and TNF- $\alpha$  (-308 G/A) in PCM patients. It has been found that while homozygous, the IL-10-1082 G allele may be correlated with an increased risk of disease contracture<sup>[14]</sup>.

Placental cytokines such as IL6, TNF  $\alpha$ , and TGF  $\beta$  have been reported to play roles in necrotic and aponecrotic trophoblast cell death by influencing caspase and endothelial cell activation activities. IL6, IL1, and TNF  $\alpha$  are thought to play important roles in early pregnancy and also to be elevated in inflammatory states<sup>[15]</sup>. High levels of pro-inflammatory molecules such as TNF  $\alpha$ , IFN-gamma, IL-6 and IL-10 and inflammatory leukocytes (macrophages, neutrophils, lymphocytes) were found in women with recurrent pregnancy loss (RPL) compared to women with normal pregnancy<sup>[16]</sup>.

Baud and Karin<sup>[17]</sup>, elevated levels of pro-inflammatory cytokine in the macrophage triggered by IFN-gamma and TNF-alpha. IFN  $\gamma$  was formed from trophoblasts and endometrial mucosal cells at moderate levels. It's consistent with other findings from the mouse study<sup>[18]</sup>. Since its ability to control immunologically important transcription, this is a type II interferon and controller of a wide variety of cellular processes. Therefore, this study hypothesized that maternal overexpression of the TNF alpha gene may increase the recruitment of inflammatory leukocytes in the maternal-fetal interface, resulting in uteroplacental perfusion deficiency, development of thrombotic events and placental hypoxia, finally abortion of embryos. This study also examined the altered expression of TNF alpha in 15 aborted placenta versus 15 normal placenta,

subjects as controls. TNF alpha gene has been evaluated using quantitative real-PCR to assess if the pattern of differential expression of such transcript analysis has been performed.

The level of TNF alpha protein in the placental tissue of the aborted ewes has increased significantly ( $p < 0.05$ ) compared to controls. Thus, this is the first study that predicted the role of the inflammatory molecules TNF alpha. The research opens up a new perspective to understanding the role of TNF alpha in pregnancy maintenance and outcome. In this context, Th2 or Th3 cytokines, such as IL-4, IL-10 or TGF- $\beta$ , would promote pregnancy survival, while the development of excessive pro-inflammatory cytokines (i.e., TNF- $\alpha$  or IFN  $\gamma$ ) would assess fetal rejection<sup>[19]</sup>.

The TNF-alpha is primarily expressed by mononucleomacrophage, CD4 + Th1, cell NK, etc. Yet apart from these immune cells, certain reproductive tissues can also express this cytokine<sup>[13]</sup>. It was observed that the expression of TNF- $\alpha$  DNA decreased significantly in normal delivery compared to that of abortion, which was consistent with Kirwan *et al.*<sup>[14]</sup> findings. Monzón-Bordonaba *et al.*<sup>[22]</sup> reported that lower TNF- $\alpha$  concentrations could improve pregnant women's energy metabolism and their embryo development, increase synthetic progesterone and chorionic gonadotropin levels, and stimulate trophoblast to generate urokinase-type plasminogen activator (uPA). It promotes the deterioration of decidual cell ectomatrix and placenta implantation and eventually plays a role in pregnancy sustainability.

Chaouat *et al.*<sup>[23]</sup> found that higher TNF- $\alpha$  concentrations can lead to abortion by the promotion of trophic cell apoptosis, the elevation of synthetic PG E2, excitation of uterine smooth muscle, stimulation of Th1 type of immunological reaction, rejection of embryonic tissue, coagulative system activation leading to placenta trophic vessel thrombosis. Thus, the proportion of CD4 + T cells in the peripheral blood of early pregnant women had decreased significantly, presumably as a result of physiological changes in several hormones during pregnancy contributing to certain changes in the maternal immune system and ensuring the development of relatively lower levels of TNF- $\alpha$  in pregnant maternity.

A study showed that abortion was related to an irregular rise in the TNF- $\alpha$  serum protein, which the expression of TNF- $\alpha$  increased significantly locally in

different types of cells at the maternal-fetal interface during a spontaneous abortion, and 94% of these TNF- $\alpha$  were located in the mother's peripheral blood cycles<sup>[24]</sup>. Furthermore, Zenclussen *et al.*<sup>[25]</sup> found that P-selectin within the vascular wall of decidua is significantly increased in patients with normal spontaneous abortion, and, in combination with P-selectin ligand on the surface of TNF- $\alpha$ -expressing Th1 cells, local migration of Th1 cells from the peripheral blood to the maternal/fetal interface results.

Chaouat *et al.*<sup>[26]</sup> reported that PBMCs were accumulated locally through a series of complicated mechanisms at the maternal-fetal interface and secreted a larger amount of TNF- $\alpha$  in the form of paracrine or autocrine, possibly resulting in abortion. Although the causal-effect relationship between abnormal expression of TNF- $\alpha$  and abortion is not yet clear, abortion may be correlated with TNF- $\alpha$  gene polymorphisms<sup>[27]</sup>. A study has recently found, from the immunogenetic point of view, that the gene polymorphism occurred in women with a tendency to abortion, cytokine modification may typically be affected by many factors during a spontaneous abortion<sup>[28]</sup>. Nevertheless, the above study raised a train of new thoughts, the exact mechanisms of TNF- $\alpha$  leading to abortion are not completely understood, and whether the initiator or the successor case is an irregular expression has not been confirmed, requiring more research on many aspects of gene polymorphism, gene transcription, and expression of TNF- $\alpha$  and INF gamma receptors. Moreover, a recent study reported that a significant link between recurrent pregnancy loss and polymorphisms were studied. This research confirmed that TNF- $\alpha$  polymorphisms might be a susceptible factor of recurrent pregnancy loss cases. Therefore, this study concluded that TNF- $\alpha$  polymorphisms were the possible genetic problem of pregnancy loss<sup>[29]</sup>.

**Ethical Clearance:** The Research Ethical Committee at scientific research by ethical approval of both MOH and MOHSER in Iraq

**Conflict of Interest:** None

**Funding:** Self-funding

### References

- Laird, S. M., Tuckerman, E. M., Cork, B. A., Linjawi, S., Blakemore, A. I. F., & Li, T. C. A review of immune cells and molecules in women with recurrent miscarriage. *Hum Reprod Update*, (2003). 9(2), 163-174.
- Christiansen, O.B., Nielsen, H.S., Kolte, A.M. Inflammation and miscarriage. *Semin Fetal Neonatal Med*, (2006). 11:302–308.
- Keelan, J., Blumenstein, M., Helliwell, R.J.A., Sato, T.A., Marvin, K.W., & Mitchell, M.D. Cytokines, prostaglandins and parturition—a review. *Placenta*, (2003). 24, S33-S46.
- Dammann, O., Leviton, A., Nelson, K. B., Redline, R. W., Speer, M. E., Cole, S., & Goodrum, L. A. Perinatal pathology, the placenta, and litigation: an open forum. *Hum. Pathol.*, (2003). 34(6), 522-527.
- Royle, C., Lim, S., Xu, B., Tooher, J., Ogle, R., & Hennessy, A. Effect of hypoxia and exogenous IL-10 on the pro-inflammatory cytokine TNF- $\alpha$  and the anti-angiogenic molecule soluble Flt-1 in placental villous explants. *Cytokine*, (2009). 47(1), 56-60.
- Cavalcanti, Y.V.N., Brelaz, M.C.A., Neves, J.K.D.A.L., Ferraz, J.C., & Pereira, V.R.A. Role of TNF-alpha, IFN-gamma, and IL-10 in the development of pulmonary tuberculosis. *Pulmonary medicine*, (2012). 2012.
- Christiansen, O. B., Andersen, A. M. N., Bosch, E., Daya, S., Delves, P. J., Hviid, T.V., & van der Ven, K. Evidence-based investigations and treatments of recurrent pregnancy loss. *Fertil Steril*, (2005). 83(4), 821-839.
- Magee, D. M., & Cox, R. A. Vaccine development for coccidioidomycosis. In *Human Fungal Pathogens* (pp. 243-257). Springer, Berlin, Heidelberg. (2004).
- Raghupathy, R. Th-1-type immunity is incompatible with successful pregnancy. *Immunology today*, (1997). 18(10), 478-482.
- Pal, M. (2007). *Veterinary and medical mycology*. Directorate of Information and Publications of Agriculture, Indian Council of Agricultural Research.
- Cai, J., Li, M., Huang, Q., Fu, X., & Wu, H. Differences in cytokine expression and STAT3 activation between healthy controls and patients of unexplained recurrent spontaneous abortion (URSA) during early pregnancy. *PloSone*, (2016). 11(9): 12-17
- De La Torre, Y. M., Buracchi, C., Borroni, E. M., Dupor, J., Bonocchi, R., Nebuloni, M., & Bulla, R. Protection against inflammation-and autoantibody-



- caused fetal loss by the chemokine decoy receptor D6. *Proceedings of the National Academy of Sciences*, (2007). 104(7), 2319-2324.
13. Gorivodsky, M., Zemlyak, I., Orenstein, H., Savion, S., Fein, A., Torchinsky, A., & Toder, V. TNF-alpha messenger RNA and protein expression in the uteroplacental unit of mice with pregnancy loss. *J Immunol*, (1998). 160(9), 4280-4288.
  14. Kirwan, J. P., Hauguel-De Mouzon, S., Lepercq, J., Challier, J. C., Huston-Presley, L., Friedman, J. E., & Catalano, P. M. TNF-alpha is a predictor of insulin resistance in human pregnancy. *Diabetes*, (2002). 51(7), 2207-2213.
  15. Ali, R., & Khan, I. H. Mycotic abortion in cattle. *Pak Vet J*, 26:44-46.
  16. Anderson, M. L. (2007). Infectious causes of bovine abortion during mid-to late-gestation. *Theriogenology*, (2006). 68(3), 474-486.
  17. Prud'Homme, G. J., & Piccirillo, C. A. The inhibitory effects of transforming growth factor-beta-1 (TGF- $\beta$ 1) in autoimmune diseases. *Journal of autoimmunity*, (2000). 14(1), 23-42.
  18. Costeas, P.A., Koumouli, A., Giantsiou-Kyriakou, A. Th2/Th3 cytokine genotypes are associated with pregnancy loss. *Hum Immunol*, (2004). 65(2): 135-41.
  19. Baud, V., Karin, M. Signal transduction by tumor necrosis factor and its relatives. *Trends in Cell Biol*, (2001). 11(9), 372-7
  20. Arslan, E., Çolakoğlu, M., Çelik, Ç., Gezginç, K., Acar, A., Çapar, M., & Akyürek, C. Serum TNF- $\alpha$ , IL-6, lupus anticoagulant and anticardiolipin antibody in women with and without a past history of recurrent miscarriage. *Arch Gynecol Obstet*, (2004). 270(4), 227-229.
  21. Bates, M. D., Quenby, S., Takakuwa, K., Johnson, P. M., & Vince, G. S. Aberrant cytokine production by peripheral blood mononuclear cells in recurrent pregnancy loss?. *Hum Reprod*, (2002). 17(9), 2439-2444.
  22. Monzón-Bordonaba, F., Vadillo-Ortega, F., & Feinberg, R. F. Modulation of trophoblast function by tumor necrosis factor- $\alpha$ : a role in pregnancy establishment and maintenance?. *American journal of obstetrics and gynecology*, (2002). 187(6), 1574-1580.
  23. Chaouat, G., Diallo, J. T., Volumenie, J. L., Menu, E., Gras, G., Delage, G., & Mognetti, B. Immune suppression and Th1/Th2 balance in pregnancy revisited: a (very) personal tribute to Tom Wegmann. *Am J Reprod Immunol*, (1997). 37(6), 427-434.
  24. Chaouat, G., Kolb, J.P., & Wegmann, T.G. The murine placenta as an immunological barrier between the mother and the fetus. *Immunol Rev*, (1983). 75(1), 31-60.
  25. Zenclussen, A. C., Fest, S., Sehmsdorf, U. S., Hagen, E., Klapp, B. F., & Arck, P. C. Upregulation of decidual P- selectin expression is associated with an increased number of Th1 cell populations in patients suffering from spontaneous abortions. *Cell Immunol*, (2001). 213(2), 94-103
  26. Chaouat, G., Lédée-Bataille, N., Zourbas, S., Ostojic, S., Dubanchet, S., Martal, J., & Frydman, R. Cytokines, implantation and early abortion: re-examining the Th1/Th2 paradigm leads to question the single pathway, single therapy concept. *Am J Reprod Immunol*, (2003). 50(3), 177-186.
  27. Choi, Y. K., & Kwak-Kim, J. Cytokine gene polymorphisms in recurrent spontaneous abortions: a comprehensive review. *American Journal of Reproductive Immunology*, (2008). 60(2), 91-110.
  28. Bonney, E. A., & Matzinger, P. The maternal immune system's interaction with circulating fetal cells. *The Journal of Immunology*, (1997). 158(1), 40-47.
  29. Aboutorabi, R., Behzadi, E., Sadegh, M. J., Fatehi, S. P., Semsarzadeh, S., Zarrin, Y., & Mostafavi, F. S. The Study of Association Between Polymorphism of TNF- $\alpha$  Gene's Promoter Region and Recurrent Pregnancy Loss. *J Reprod Infertil*, (2018). 19(4), 211.

# Detection of *Legionella pneumophila* and *Legionella dumoffii* Biochemically in Water Samples in Baghdad City, Iraq

Jundi Alak Mahdi Al-Buhilal<sup>1</sup>, Taghreed Khudhur Mohammed<sup>1</sup>

<sup>1</sup>Assistant Professor/Institute of Medical Technology-Almansour, Middle Technical University, Baghdad/Iraq

## Abstract

**Background:** Legionellae can be isolated from various sources of water. *Legionella pneumophila* is transmitted via contaminated water and caused many diseases like pneumonia; lungs abscesses and fever.

**Objectives:** Isolation and identification of *L. pneumophila* from environmental samples; study the factors that affect the frequency of *L. pneumophila*; and some oxidizing substances on their growth.

**Materials and Method:** A total of one hundred water samples were collected from Cooling tower; Water tanks; Tap water and Swab from inner tap water. All samples were cultured on Buffered charcoal yeast extract (BCYE) agar and Buffered charcoal yeast extract (BCYE) broth to isolate *Legionella pneumophila* and *Legionella dumoffii*. Effect of pH; temperature; chlorine; Iron and effect of soluble zinc on *L. pneumophila* growth were studied.

**Results:** The isolates gave positive results for the tests of catalase, oxidase, gelatin degradation, nitrate reduction and beta-lactamase. Iron; Soluble Zinc; Chloride; Calcium hardness (CaCO<sub>3</sub>); Turbidity and silver were ≤ 3ppmas; 1-3 ppmas; 0.2-0.5 ppm; 600 ppm; ≤ 0.3 and 3 ppmas respectively. The distribution of *L. pneumophila* in the water samples were studied.

**Conclusion:** Fatal *L. pneumophila* may be transmitted by drinking contaminated water and led to death because they caused pneumonia.

**Keywords:** *Legionella pneumophila*, *Legionelladumoffii*, Water sources, Antibiotic resistance.

## Introduction

*Legionella pneumophila* (*L. pneumophila*) is a Gram negative bacillus, grow and multiply under aerobic conditions in the presence of cysteine and iron, hydrolyses gelatin and produces urease. It is positive for oxidase and catalase. The colonies colour is white to greyish. It grows on yeast extract agar<sup>[1]</sup>. It has been isolated from patients suffering from Legionnaires (respiratory system infections), drinking water, lakes, hot water tanks and cooling towers. *L. pneumophila* isolated from tap water; and from tankers in Baghdad and Basra cities. Many Iraqi researchers found that 75 isolates of

*L. pneumophila* were isolated from 96 water samples which susceptible to many antibiotics (Gentamicin, Streptomycin, Rifampin, chloramphenicol) and resistance to Penicillin and Cephalothin<sup>[2]</sup>. Another study revealed that one hundred ten *L. pneumophila* isolates were isolated from cooling towers in General Company for the manufacture of biofertilizer/Basra, (96.3%) of isolates were sensitive to Chloramphenicol and the Refampein while (14.5%) of isolates were sensitive to Polymaxin B<sup>[3]</sup>. Forty-nine isolates of *L. pneumophila* were isolated from 222 precipitation water tanks and filtration tanks in Basra governorate. All isolates were resistant to ampicillin while susceptible to doxycycline<sup>[4]</sup>. Most of Legionnaires' Diseases (90%) caused by *L. pneumophila*, followed by *L. dumoffii*<sup>[5]</sup>. The aims of the current study are isolation and identification of *L. pneumophila* from environmental samples; study the factors that affect the frequency of *L. pneumophila*; and some oxidizing substances on their growth.

## Corresponding Author:

Jundi Alak Mahdi Al-Buhilal

Assistant Professor/Institute of Medical Technology-Almansour, Middle Technical University, Baghdad/Iraq  
e-mail: drjundialak@gmail.com

## Materials and Method

1. **Water sample collection:** A total of one hundred water samples (1000 mL from each sample) were collected from:

- Cooling tower (25 samples).
- Water tanks (25 samples).
- Tap water (25 samples).
- A swab from inner tap water (25 samples).

Each sample was collected in a sterile glass container. All samples were transported to the laboratory immediately in the icebox.

2. **Water samples concentration<sup>[6,7,8]</sup>:** the concentrations of the water samples were done by centrifugation at 3000 round per minute for 5 minutes. The supernatants were discarded, and the sediments were kept in the sterile container for minutes. Then the sediments were concentrated by using Millipore membrane filter (with pore size 0.2  $\mu$ m). The filter membrane resuspended with 10 mL of original water and vortexed for mixing (400 r.p.m. for 10 minutes). Then 0.1 mL of samples were cultured on *Legionella* isolation media (triplicate plates):

- Buffered charcoal yeast extract (BCYE) agar (Oxoid) containing (Yeast Extract 10 g/L; Charcoal 2.0g/L; Ferric Pyrophosphate 0.25 g/L; ACES Buffer 10.0g/L; Potassium Carbonate 2.3 g/L and Agar 14.0g/L) supplemented with  $\alpha$ -ketoglutarate, vancomycin, polymyxin B, and anisomycin. The pH of medium adjusted to 6.9.
- Buffered charcoal yeast extract (BCYE) broth (Oxoid) to encourage the growth of *Legionella*. Then spread on BCYE agar.

All plates were incubated at 37°C with 2% CO<sub>2</sub>. The culture media plates were examined after 2, 3, 5, 6, and 7 days of incubation to detect the *Legionella* colonies (white, convex, circular, 2 mm in diameter, like ground glass in their appearance. While the swabs of water samples were cultured on BCYE agar directly; the plates were incubated at 37°C with 2% CO<sub>2</sub> and then examined after 5 days of incubation.

3. ***L. pneumophila* identification:** Many biochemical tests were done to identify *L. pneumophila* <sup>[9]</sup>:

- Gram staining.

- Urease test.
  - Nitrate test.
  - Oxidase testing (using 1% *N,N,N',N'*-Tetramethyl-*p*-phenylenediamine dihydrochloride).
  - Catalase test (using Hydrogen peroxide; 3% H<sub>2</sub>O<sub>2</sub>).
  - Gelatin liquefaction test (using gelatin agar stab).
4. **Effect of pH on *L. pneumophila* growth:** Tubes containing 10 mL of nutrient broth (Oxoid) with L-cysteine in various ranges of pH (6, 6.5, 7, 7.5, and 8) were inoculated with *L. pneumophila* isolates. All tubes after inoculation with bacteria under study were incubated at 37°C for 5 days. Then, the turbidity of each tube was measured by using turbidimeter apparatus to determine the growth of *L. pneumophila* in different pH values. After that, 0.1 mL of bacterial growth was taken from each tube and inoculated on BCYE agar; the plates were incubated at 30°C for 5 days to calculate the number of viable bacteria in different pH levels <sup>[10]</sup>.
5. **Effect of chlorine on *L. pneumophila* growth:** It was done with serial dilutions of free chlorine (0.1-1.5) mg/L in sterile 0.85% normal saline. All tubes after inoculation with bacteria; were incubated at 25°C for 30 minute. 0.01 ml from each dilution was inoculated on BCYE agar and incubated to study the effect chlorine on bacteria <sup>[11]</sup>
6. **Effect of temperatures on *L. pneumophila* growth:** All isolates were cultured on BCYE agar in incubated in different temperatures (20, 25, 30, 35, 37, 40 and 45) °C <sup>[11]</sup>.
7. **Effect of soluble zinc on *L. pneumophila* growth<sup>[12]</sup>**
8. **Effect of Iron on *L. pneumophila* growth<sup>[12]</sup>**
9. **Turbidity measuring<sup>[13]</sup>**

## Results and Discussion

The results showed that the isolated bacteria were Gram negative bacilli, motile, grown on (CYEA), which contains the yeast extract and cysteine. The isolates gave positive results for the tests of catalase, oxidase, gelatin degradation, nitrate reduction and beta-lactamase. They gave negative results to ferment sugars (glucose, maltose, lactose); and showed a bright blue color under ultraviolet light. So, the isolates were identified as the *Legionella pneumophila*. Analysis results of water samples were fixed in the table (1) and (2).

**Table 1: Biochemical analysis results of water samples**

Iron (Fe <sup>+2</sup> ) (ppmas)	Soluble Zinc (Zn <sup>+2</sup> ) (ppmas)	Chloride (ppm)	Calcium hardness (CaCO <sub>3</sub> ) (ppm)	Turbidity	Ag (ppmas)
≤ 3	1-3	0.2-0.5	600	≤ 0.3	3
ppmas: part per mas Ag: Silver ppm: part per million					

The distribution of *L. pneumophila* in the water samples were 22(34.37%); 18(28.12%); 15(23.43%) and 9(14.06%) in cooling tower; tanks; tab water and swab from tab water respectively. The frequency of isolates

number 1 from positive samples were 22,15,14,9 for cooling tower, water tanks, tab water and swabs from tab water respectively.

**Table 2: Distribution of *Legionella pneumophila* isolates according to water sources**

(%) Isolate of no. 2 from total positive sample	Frequency of isolate no. 2 from positive sample (%)	Isolate of no.1 from a total positive sample (%)	Frequency of isolate no.1 from positive sample	Negative sample (%)	Positive sample (%)	No. of sample	Source of samples	No
80(20/25)	20(46.51)	88(22/25* 100)	22(36.66)	3(9.33)	22(34.37)	25	Cooling tower	1
48(12/25)	12(27.91)	60(15/25* 100)	15(25)	7(19.44)	18(28.12)	25	Tanks	2
40(10/25)	10(23.25)	56(14/25* 100)	14(23.33)	10(27.77)	15(23.43)	25	Tab water	3
4(1/25)	1(2.32)	36(9/25* 100)	9(15)	16(44.44)	9(14.06)	25	Swab from tab	4
<b>172172/4=43</b>	<b>43(100)</b>	<b>240(240/4=60)</b>	<b>60(100)</b>	<b>36(100)</b>	<b>64(100)</b>	<b>100</b>		<b>Total</b>

In one positive sample; two isolates may appear and in some samples, only one isolate appeared (frequency).

Two species of *Legionella* were isolated from water samples. The first was (60) isolates of *Legionella pneumophila*; and the second was (43) of *L. dumoffi*. The frequency of two species of *Legionella* in the cooling tower was more than other water samples, and the frequency of *Legionella pneumophila* was more than the frequency of *L. dumoffi*.

The frequency of *L. pneumophila* at pH<sub>7</sub> (88.3%) and this was more at pH<sub>8</sub> (60, 61.1 %) respectively. Whereas, the frequency at temperature 37°C (83.3%) was more than at 40°C and 45°C (73.3 and 63.37)% respectively. The current results showed also that the frequency of *L. pneumophila* was better at 0.3 ppm of R. chlorine when compared with 0.5 and 0.7 ppm of R. chloride. The frequency of *L. pneumophila* was high at 10 ppm of dissolved Oxygen and 3 ppm of Iron. Ag (silver) inhibited the growth of *L. pneumophila* at a concentration of 3ppm (table 2).

The results of the current study were incompatible with other studies. In Iran, only one isolate (2.9%) of *L.*

*pneumophila* was isolated from water [11]. Whereas, in Saudi Arabia; the rate of *L. pneumophila* in water tanks was (8%), and most the isolates were grown better in pH<sub>6</sub> and pH<sub>7</sub>; survived in temperature at 42°C and normal level of chlorine in water tanks. The other researches also isolated *L. dumoffi* (2%) [12].

The results of the present study are compatible with Al-Sulamiet al [4]. *L. pneumophila* isolates were detected in 6 from 19 water stations in Basra governorate; the average of residual chlorine concentration was (0-1.03) mg/L.

*Legionella pneumophila* was emphasized for frequency in all water samples collected and it was the predominant species among other species affiliated with the *Legionella* spp. The spread of this species is evidence of the favourable environmental conditions, which increased the chance their presence in the samples, were indicated that these bacteria survive in temperatures between 40-42 °C, pH between 5.6-8.7 and high concentrations of chlorine ranged from 5.0-0.6 µg/ml [13].

Felice et al [14] isolated *L. pneumophila* from water

pools in Venezia Giulia, Italy. The prevalence of *L. pneumophila* was (82% of positive samples). In the Netherlands, 33.2% of water drinking water samples taking from buildings had *L. pneumophila*. This study was done to re-plan the drinking water management because *L. pneumophila* considered a dangerous bacterium which causing pneumonia and urinary tract infections [15]. 89 samples (43.6%) of 204 water samples (showerhead, taps in kitchens and tanks) had *L. pneumophila* in Kuwait, diagnosed with Real-Time Polymerase Chain Reaction [16]. Other studies showed that the prevalence of *L. pneumophila* in different water sources was (80%) in Mosul governorate/North of Iraq. The isolated *L. pneumophila* isolates were killed at 55°C for 30 min and 70°C for 5 min. Also, the isolates of bacteria were killed after exposure to UV light; 70% ethanol; 20% Isopropanol and 1% formalin [17]. Gauadet al. [18] determined the frequency of *L. pneumophila* in patients suffered from pneumonia and urinary tract infections using PCR technique. The percentage of *L. pneumophila* was 30% at hospitals in Baghdad city. The researchers suspected that the sources of *Legionella pneumophila* were drinking water or ventilation and cooling opening [18]. In Australia, the sources of *L. pneumophila* are shows, washing machines, swimming pools and lakes. The most isolates of *L. pneumophila* isolated from the water with temperature ranged from (>20 °C) to (<60 °C), and water containing free residual chlorine (<0.5 mg/L) [19-22].

**Ethical Clearance:** The Research Ethical Committee at scientific research by ethical approval of both MOH and MOHSER in Iraq

**Conflict of Interest:** None

**Funding:** Self-funding

### References

1. Subbaram K., Kannan H., and Masadeh M. M. A. Isolation, identification, characterization and antibiotic sensitivity profile of pathogenic *Legionella pneumophila* isolates from different water sources, *Asian Pacific Journal of Tropical Biomedicine*, 2017; 7(5): 411– 415.
2. Al-Bohlal J. A. M. Susceptibility of some *Legionella* species to eight antimicrobial agents, *AL-TAQANI*, 2008; 21(3): 1-7.
3. Al-Bohlal J. A. M. and Hadi M. A. Incidence of multiple antibiotic resistance among strains of pathogenic *Legionella pneumophila* isolated from cooling towers, *AL-TAQANI*, 2010; 23(4): 1-9.
4. Al-Sulami A.A., Al-Tae A.M.R. and A.A. Yehyazarian, Isolation and identification of *Legionella pneumophila* from drinking water in Basra governorate, Iraq, *EMHJ*, 2013; 19(11): 936–941.
5. Velonakis EN, Kiouisi IM, Koutis C, Papadogiannakis E, Babatsikou F, Vatopoulos A. First isolation of *Legionella* species, including *L. pneumophila* serogroup 1, in Greek potting soils: possible importance for public health. *Clin Microbiol Infect*. 2010 Jun; 16 (6):763-6. doi: 10.1111/j.1469-0691.2009.02957.x. Epub 2009 Sep 11.
6. Luo X, Wasilko DJ, Liu Y, Sun J, Wu X, Luo ZQ, et al. Structure of the *Legionella* virulence factor, SidC reveals a unique PI(4) Pspeci binding domain essential for its targeting to the bacterial phagosome. *PLoS Pathog* 2015; 11(6): e1004965.
7. Phin N, Parry-Ford F, Harrison T, Stagg HR, Zhang N, Kumar K, et al. Epidemiology and clinical management of Legionnaires' disease. *Lancet Infect Dis* 2014; 14(10): 1011-21.
8. Fallon, R. J. *Legionella*. In *Practical Medical Microbiology*. 14<sup>th</sup> ed. Churchill Livingstone inc. New York, (1996).
9. Wolter N, Carrim M, Cohen C, Tempia S, Walaza S, Sahr P, et al. Legionnaires' disease in South Africa, 2012–2014. *Emerg Infect Dis* 2016; 22(1): 131-3.
10. R M Wadowsky, R Wolford, A M McNamara, R B Yee, Effect of temperature, pH, and oxygen level on the multiplication of naturally occurring *Legionella pneumophila* in potable water. *Applied and Environmental Microbiology*, 1985; 49(5): 1197-1205.
11. Tabatabae M.; Hemati Z.; Moezzi M. and Azimzadah. Isolation and identification of *Legionella* spp. from different aquatic sources in south-west of Iran by molecular and culture method. *Molecular Biology Research Communications*, (2016).5:215-223,
12. Subbaram K.; Kannan H. and Masadeh M. Isolation, identification, characterization and antibiotic sensitivity profile of pathogenic *Legionella pneumophila* isolates from different water sources. *Asian pac. J. Trop. Biomed.*, (2017).7 (5):411-415

13. Stone, M.; Ahmed G. and Evans J. The continuing risk of domestic hot water scales to the elderly, Burns J.(2000). 26:347-350,
14. Felice A., Franchi M., De Martin S., Vitacolonna N., Lacumin L. and Civilini M. Environmental surveillance and spatio-temporal analysis of Legionella spp.in a region of northeastern Italy(2002-2017).PLOS One.,(2019). 14(7):e0218687
15. Van der LugtW.EuserSM.,Bruin JP., den Boer JW. and Yzermen. EPF. Wide - scale study of 206 buildings in the Netherlands from 2011 to 2015 to determine the effect of drinking water management plans on the presence of Legionellaspp.,Water Research J., Sep.,(2019).15;161:581-589
16. Al-Matwah Q.,Al-Zenki F., Qasem J.,Al-Waalan T. and Ben Heji A. Detection and Quantification of Legionella pneumophila from water systems in Kuwait residential facilities, Journal of pathogens, (2012). Article ID 138389,5 pages,
17. Al-Allaf M.A. and Al-Rawi A.M. The effect of some physical and chemical inhibitors on growth of Legionella pneumophila. Al-Rafidain science journal, (2007).18(12):48-55,
18. Gaud Sh., Abdulrahman The.,Muhamed A., Jawad A. and Hassan J. Clinical utility of urinary antigen test and molecular method for detection of Legionella pneumophila. Iraq JMS, (2018).16(2):207-215,
19. CDC (2014). Legionella (Legionnaires' disease and Pontiac fever), Centers for Disease Control and Prevention, Atlanta, [www.cdc.gov/Legionella/index.html](http://www.cdc.gov/Legionella/index.html).
20. CIBSE Minimizing the risk of Legionnaires' disease, Chartered Institution of Building Services Engineers, London. (2013).
21. Decker BK, Palmore TN The role of water in healthcare-associated infections. Current Opinion in Infectious Diseases (2013). 26:345–51.
22. enHealth Guidelines for Legionella control in the operation and maintenance of water distribution systems in health and aged care facilities. Australian Government, Canberra. Edited and designed by Biotext Pty Ltd. Published by SA Health. (2015).

# The Relationship between Some Blood Components and Wool Production and Some of its Physical Traits in the Local Arabian Sheep

Hafed Musa Ali AL-Tae<sup>1</sup>, Rahman Hussein Hamza Al-Qasimi<sup>2</sup>, Azhar Abdulabbas Jaffar Shareef<sup>3</sup>

<sup>1</sup>Assis. Prof., College of Food Sciences/Al-Qasim Green University/Iraq, <sup>2</sup>Lecturer College of Veterinary Medicine/Al-Qasim Green University/Iraq, <sup>3</sup>Lecturer, Marshes Research Center/Thi-Qar University/Iraq

## Abstract

The variation in the wool traits of Iraqi sheep is very large and is affected by non-genetic and genetic factors. The study was carried out in the fields of Al-Kafeel station in Karbala governorate on a sample consisting of 26 heads of local Arabian sheep to find out the relationship between wool production (raw wool weight, clean wool weight) and some of its physical traits (tuft length, fiber length, fiber diameter) with some Blood components (glucose, total protein, growth hormone, thyroxine hormone), as the results showed a positive significant regression of the raw and clean wool weight and the diameter of the fiber on the percentage of glucose in the blood and with a regression coefficient of 0.117, 0.023, and 0.224 respectively, while the two traits of the strand length and the length of the fiber did not record a significant regression on the level of glucose in the blood.

**Keywords:** Arabian sheep, thyroxine hormone, fibrous diameter.

## Introduction

Iraqi sheep are one of the types of producing coarse wool that is used in the manufacture of carpets, floor furnishings and blankets, and the wool industry needs an integrated plan that begins first with improving its production in quantity and quality for the purposes of the carpet industry. The variation in the wool traits of Iraqi sheep is very large and is affected by non-genetic and genetic factors<sup>[1]</sup> the weight of the wool is the main indicator of wool production, and this in turn depends on a number of physical traits of wool, such as the ratio of clean wool, the length of the strand, the length of the fiber, the diameter of the fiber, the density and other traits, and its direct relationship with many internal, physiological and health factors that occur on the animal and therefore it is an economic traits. Important because it plays an influential role in the manufacturing

process and its yields according to the types of wools produced from these animals <sup>[2]</sup>. The production of wool and its physical traits can be predicted through the association with chemical blood traits, some hormones and metabolic enzymes to improve the wool production trait through early selection. Where some researchers noticed a significant relationship between wool production and some of its traits with some blood components such as total protein, glucose and others <sup>[3]</sup>. From this standpoint, the aim of this study came to know the relationship between some blood components such as glucose, total protein, growth hormone, and thyroxin in a sample of local Arabian sheep for selection purposes and to improve wool production and traits at an early date to accelerate improvement programs.

## Materials and Method

This study was carried out in the fields of Al-Kafeel station in Karbala governorate on a sample of 26 heads of local arabian sheep to find out the relationship between wool production (raw wool weight, clean wool weight) and some of its physical traits (tuft length, fiber length, fiber diameter) with some blood components (Glucose, total protein, growth hormone, thyroxine hormone).

---

### Corresponding Author:

**Rahman Hussein Hamza Al-Qasimi**

Lecturer College of Veterinary Medicine/Al-Qasim Green University/Iraq

e-mail: rahmanalqassimi@gmail.com

**Collection and analysis of blood samples:** Blood samples were collected in clean and sterile plastic test tubes without anticoagulant and serum was isolated using a 3000 rpm centrifuge. For the purpose of separating the blood from the rest of the components, the concentration of biochemical parameters was measured according to the method of work attached to each kit by the French company Biolabo SA in measuring the concentration of glucose and total protein using a Spectrophotometer, and it was adopted to measure the concentration of growth hormone and thyroxin hormone on the method described on the measuring kit provided by the American company Monobind Inc.

**Measuring wool production and its physical traits:** Sheep were sheared at the beginning of April and weighed directly to know the weight of the raw wool. Before shearing, a wool sample of 10×10 cm was taken from the area in the center of the right side of the animal (the last six ribs) as the best sampling area, according to [4]. After taking the weights of raw wool samples, these samples were washed in three containers on liquid soap to remove dirt and dirt with stirring and squeezing, and then dried at room temperature for 48 hours, then weighed the clean wool samples to extract the ratio of clean wool and clean wool weight as in the following formula:

$$\text{Clean wool ratio} = (\text{clean sample weight} / \text{raw sample weight}) \times 100$$

$$\text{Clean wool weight} = \text{Clean wool\%} \times \text{Raw wool Weight}$$

The length of the tuft was measured after taking three tufts randomly from each sample and their lengths were measured using the usual ruler and without tensile or pulling, from the tuft base to the end of it. Special clips to be as tight and straight as possible to adjust their true length. The diameter of the fiber was measured using a German-born Primo microscope containing an AxioCam in the Histology and Anatomy Laboratory of the Faculty of Veterinary Medicine/Al-Qasim Green University, where ten fibers were taken from each sample and the general rate was extracted. The fiber was placed under the microscope and appears on the computer screen. Connected to the microscope, a straight line is drawn between the ends of the fiber diameter using the mouse, and the diameter of the fiber appears in the micron [5].

**Statistical Analysis:** The program [6] was used in the statistical analysis to estimate the regression coefficients (trait of wool production on the studied blood trait) and the values of the parameter of determination, to be used in the selection and improvement programs.

## Results and Discussion

The average weight of the raw and clean wool was 1.53, 0.97 kg, while the general averages of the traits were the length of the strand and the length of the fiber was 11.81, 14.54 cm and the diameter of the fiber 24.97 microns, which is similar to the results of [3,5]. As for the blood components, the mean of glucose was 66.57 mg/100 ml, total protein 5.68 g/100 ml, 9.83 ng/ml for growth hormone, and 31.74 nmol/liter for thyroxine (Table 1), and these rates are within the normal limits recorded by [7].

**Table (1): General mean ± standard error for studied traits**

Traits	Means	Standard error
Raw wool Weight (kg)	1.53	0.30
Clean wool Weight (kg)	0.97	0.21
Length of tuft (cm)	11.81	1.17
Length of fiber (cm)	14.54	1.16
Diameter of fiber (microns)	24.97	2.88
Glucose (mg/100mL)	66.57	6.13
Total protein (g/100ml)	5.68	0.98
Growth hormone (ng/ml)	9.83	1.19
Thyroxine hormone (nmol/L)	31.74	2.86

The current study shows that there is a positive significant regression at the level of  $P \leq 0.05$  for the weight of the raw and clean wool and the diameter of the fiber on the percentage of glucose in the blood and with a gradient factor of 0.117, 0.023, 0.224, respectively, where the high level of glucose in the blood mg/100 ml gives an increase in the weight of the raw and clean cotton of 0.117 0.023 kg, respectively, and 0.224 microns in the diameter of the fiber, with a determination factor of 0.31, 0.25, and 0.20, respectively (Table 2). In agreement with [8,9], the two characteristics of tuft length and fibril length did not record a significant regression on the level of glucose in the blood.



**Table (2): Regression of the production of studied wool traits on blood glucose**

Traits	Regression coefficient b-	Straight line equation	Significance	Coefficient of determination -R <sup>2</sup>
Raw wool Weight	0.171	$y^{\wedge} = 0.821 + 0.0117X$	*	0.31
Clean wool Weight	0.032	$y^{\wedge} = 0.838 + 0.0023X$	*	0.25
Length of tuft	0.0405	$y^{\wedge} = 9.048 + 0.0403X$	NS	0.05
Length of fiber	0.0506	$y^{\wedge} = 10.65 + 0.0582X$	NS	0.07
Diameter of fiber	0.223	$y^{\wedge} = 10.27 + 0.224X$	*	0.2
Not significant : NS, (P≤0.05) : *				

It is evident from Table (3) that there is a highly significant positive regression at the level (P≤0.01) for the wool weight of the raw jelly over the total protein in the blood and with a gradient coefficient of 0.169, meaning that an increase in the level of total protein in the blood g/100 ml leads to an increase in the weight of the raw jute by 0.169 kg. With a determination factor of 0.39, the two trait of the clean wool weight and the length

of the fiber also significantly decreased by (P (0.05) on the crude protein percentage and with a regression factor of 0.083 and 0.383 respectively, meaning that increasing the level of total protein in the blood g/100 ml leads to an increase in the clean wool weight by 0.083 Kg, with a determination factor of 0.29, an increase in fiber length by 0.383 cm, and a determination factor of 0.23. in the blood

**Table (3) Regression of the production of studied wool recipes on total blood protein**

Traits	Regression coefficient b-	Straight line equation	Significance	Coefficient of determination -R <sup>2</sup>
Raw wool Weight	0.169	$y^{\wedge} = 0.605 + 0.169X$	**	0.39
Clean wool Weight	0.083	$y^{\wedge} = 0.501 + 0.083X$	*	0.2
Length of tuft	0.185	$y^{\wedge} = 10.69 + 0.185X$	NS	0.02
Length of fiber	0.383	$y^{\wedge} = 12.306 + 0.383X$	*	0.23
Diameter of fiber	0.836	$y^{\wedge} = 20.422 + 0.836X$	NS	0.08
Not significant: NS, (P≤0.01) : **, (P≤0.05) : *				

Table (4) shows the presence of a negative significant regression at the level of P≤0.05 for the weight of the raw and clean wool at the level of growth hormone in the blood and with a regression factor of 0.016 - 0.048, respectively, meaning that an increase in the level of growth hormone in the blood ng/ml gives a decrease in the weight of the raw wool. And clean by 0.016 and 0.048 kg, respectively, with a determination factor of 0.34 and 0.19, respectively. as for the diameter of the

fiber, it recorded a positive significant regression with the level of P≤0.05 on the growth hormone in the blood, with a regression factor of 0.673 and a determination factor of 0.503, meaning that the increase in the level of growth hormone ng/ml gives an increase the fibril diameter was 0.673 microns, while the strand length and fibril length did not record a significant decline in the level of growth hormone in the blood.

**Table (4) Regression of the production of wool traits studied on the level of growth hormone**

Traits	Regression coefficient b-	Straight line equation	Significance	Coefficient of determination-R <sup>2</sup>
Raw wool Weight	-0.016	$y^{\wedge}=1.776 -0.016X$	*	0.34
Clean wool Weight	-0.048	$y^{\wedge}=01.487 -0.048X$	*	0.19
Length of tuft	0.064	$y^{\wedge}=11.12 +0.0095X$	NS	0.02
Length of fiber	0.202	$y^{\wedge}=12.53 +0.202X$	NS	0.03
Diameter of fiber	0.673	$y^{\wedge}=18.58 +0.673X$	*	0.05
Not significant : NS, (P≤0.05) : *				

The current study did not show a significant regression for all the studied traits (raw wool weight, clean wool weight, length of tuft, fiber length, and fiber diameter) on the level of thyroxine hormone in the blood.

We conclude from this study the possibility of using some metabolic and hormonal compounds in the blood to accelerate the selection programs and improve some of the productive trait of the local Arabian sheep.

**Ethical Clearance:** The Research Ethical Committee at scientific research by ethical approval of both MOH and MOHSER in Iraq.

**Conflict of Interest:** None

**Funding:** Self-funding

### References

- Ahmed, N. N; Samem F. Al-Dabbagh; Nabeel A.J AL-Masry. Study of Some Genetic and Non-genetic Factors Affecting Wool Growth and It's Relation with Some Blood Biochemical Components in Iraqi Sheep. Tikrit University Journal. (2012)12(1):42-49.
- AL-Dabbagh, S. F. A comparison of the Productive and Physiological Performance of Both Milk and Wool Traits in Awassi and Hamdani Ewes. Ph.D Thesis. Coll. Agric. Univ. Mosul.(2009)
- AL\_Dabbagh, S. F. M. Evaluation of genetic parameters of milk products, some of its ingredients, wool products and some physical characteristics in two breeds of Iraqi sheep. J. Mesopotamia. (2011) 22 (4): 57-48.
- Taddeo, H.R; L. Duga; P. Willemas and R. Samlo; Variation of mohair quality over the body in Angora goats. Small. Run. Reas. 36 (2000) (3) :285 – 291.
- Al Qasimi, R. H. H. Effect of age of ewe and sex of lamb and genotypes for hormonal growth and Insulin-like growth factor in some of the production traits of the local Awassi sheep. Ph.D Thesis. Coll. Agric. Univ. Basra.(2019)
- SPSS, Statistical Package of Social Science .Ver . 22. Application Guide .Copy right by SPSS Inc. USA.(2013)
- Shareef, A. A. J. The Relationship between Haplotypes of pou1fl Gene with Productive and Physiological Awassi Ewes and their Lambs. Ph.D Thesis. Coll. Agric. Univ. Basra.(2019)
- Mert, N., Gunduz, H., Akgunduz, V. and Akgunduz, M. Correlation between biochemical parameters and production traits in Merino cross sheep. III. Glucose, Alkaline phosphatase, ceruloplasmin. Turk. J. Vet. Anim. Sci., (2003)27: 583-588.
- Raouf, S. O. Estimating the genetic and phenotypic parameters of newborn growth and evaluating the Hamdian ewes for productive traits. PhD thesis. Faculty of Agriculture. Salah al-Din University. (2005).

# Evaluating the Sensitivity of (miR-378) as a Circulatory Screening Biomarker for Diabetic Cardiomyopathy: Comparative Study

Sana Abdul-Jabbar Ali<sup>1</sup>, Hyder Hashim Al-Shlah<sup>2</sup>, Mais Mazin Al-Hamdani<sup>3</sup>, Oday Jasim Al-salihi<sup>4</sup>

<sup>1</sup>Assistant Lecturer, Al-Safwa University, Iraq, <sup>2,4</sup>Prof., Faculty of Medicine/Babylon University/Iraq,

<sup>3</sup>Assistant Lecturer, Faculty of pharmacy/Al-Ayen University/Iraq

## Abstract

**Background:** Diabetic cardiomyopathy is one of the serious complication of diabetes mellitus, with a silent development and it is often underestimated, Currently available diagnostic techniques are limited in their ability to identify patients who present with uncommon symptoms or silent myocardopathy in its early stages.

**Aim:** To evaluate role of miRNA-378 compared to GLS as a sensitive biomarker for early detection of subclinical diabetic cardiomyopathy.

**Method:** The echocardiographic assessment for GLS was done for control group (H) and normotensive diabetic patients and these patients were divided into (CD) group without cardiomyopathy, and (M)group with cardiomyopathy diagnosed by negative GLS and positive GLS, respectively .Group (F) include Hypertensive and/or ischemic diabetic patients with overt heart failure.

**Results:** There is significant elevation in miR-378 Ct value between H in one side & other three diabetic gps. (CD, M, F) as presented in table (3-17) ( $p < 0.05$ ). There is significant elevation in miR-378 Ct value in M than CD groups. There is significant elevation in Ct value in F than M gp. ( $p=0.000$ ). In the ROC curve (AUC) was 0.965. The sensitivity and specificity were 0.978 and 0.646, respectively according to the chosen cut-off value.

**Conclusion:** This study showed that miRNA-378 could be regarded as a novel sensitive biomarker which could play a significant role for early detection of subclinical diabetic cardiomyopathy.

**Keywords:** Diabetic cardiomyopathy, screening, GLS, sensitivity, miRNA-378.

## Introduction

Diabetic cardiomyopathy was first described by Rubler in 1972 [1,2]. The term describes several mechanisms involved in the pathogenesis of this entity including changes in myocardial structure and metabolism that are not directly attributed to other co-morbidities

such as coronary artery disease (CAD) or hypertension. Left ventricular hypertrophy, myocardial lipotoxicity, increased oxidative stress, cell death from apoptosis, impaired contractile reserve, altered substrate utilization as free fatty acids (FFA), mitochondrial dysfunction and fibrosis are among the mechanisms involved with these changes in structure and metabolism contributing to the progression of heart failure [2]. Cardiac magnetic resonance (CMR) is the gold standard in the assessment of myocardial fibrosis given that T1 sequences separate normal from fibrotic tissue [3]. Nonetheless, CMR is not widely available, and it is time and cost consuming with longer and exhausting protocols. Speckle tracking echocardiography has been validated against magnetic

---

### Corresponding Author:

Sana Abdul-Jabbar Ali

Assistant Lecturer, Al-Safwa University, Iraq

e-mail: saagzz2012@yahoo.com

resonance imaging<sup>[4,5]</sup>. Global longitudinal strain (GLS) is the simplest deformation parameter specified by Speckle tracking echocardiography and probably the closest to routine clinical application<sup>[6]</sup>. Quantitative assessment of myocardial function is now possible with this technique<sup>[7]</sup>. Routine use of Speckle tracking echocardiography in daily clinical practice is not cost-effective in this scenario and currently impractical for large-scale population screening. Therefore, assessment of individual risk factors becomes very important in clinical practice especially in primary care settings. More than half of patients with heart failure have preserved ejection fraction (HFpEF)<sup>[8]</sup>. In several studies, BNP proved to be a suboptimal screening test to detect pre-clinical LV dysfunction or LVH<sup>[9-11]</sup>. For all these reasons novel sensitive markers are needed. Although many substances have been suggested as biomarkers for DbCM, none have qualified for clinical use. Diagnosis and therapies are difficult because of a lack of specific biomarkers and imaging techniques. There is a need to anticipate the progression of heart failure in patients with diabetes and for that reason we propose a strategy of non-invasive analysis of inflammation-fibrosis LVD. The detection of appropriate biomarkers could potentially permit routine population-wide screening, allowing early diagnosis and anticipation of cardiac dysfunction, and stratify these subclinical cases<sup>[12,13]</sup>.

MicroRNAs (miRNAs) are short noncoding RNAs that modify gene expression by regulating mRNA stability or translation during various disease processes. Each mRNA regulates expression of multiple genes. Dysregulated miRNAs are potentially involved in the pathogenesis of DbCM<sup>[14]</sup>. There are multiple miRNAs that have been implicated with the progression of disease. After release from the cell, these molecules remain stable in extracellular fluids and can be measured by quantitative polymerase chain reaction (qPCR)<sup>[15]</sup>. Clinical studies have proposed peripheral blood microRNAs (miRNAs) as sensitive, specific and non-invasive biomarkers for the early monitoring of alterations in cardiac viability, structure, and function. Distinctive circulating miRNA signatures with clinical value have been described in various cardiomyopathies and type 2 diabetes and its related vascular complications<sup>[16,17]</sup>.

### Subjects, Materials and Method

**Subjects:** From May 2018 to April 2019, a total of 75 patients with DM2 and 25 control subjects who were aged 40–65 yr were prospectively enrolled from Diabetic Center, CCU, and Echo Unit in Merjan Medical City (M.M.C.) admitted as diagnosed cases of DM2 by expert physicians. Each 25 patients group has a definite characters as in table (1).

**Table (1): Diagnostic criteria of study groups**

CD group	Normotensive diabetic patients without cardiomyopathy diagnosed by negative strain echo study
M group	Normotensive diabetic patients with cardiomyopathy diagnosed by positive strain echo study
F group	Hypertensive and/or ischemic diabetic patients with heart failure diagnosed by conventional echo study
H group	Apparently healthy subjects with negative strain echo study

All were subjected to clinical examination including, heart rate and blood pressure. Further clinical details are shown in Supplementary Table (2).

**Table (2): Clinical data for patients in all study groups and control subjects**

Variables	Groups				
	CD Group	M Group	F Group	H Group	
Total number (n)	25	25	25	25	
Age/mean ± SD	52.76±6.3	53.04±6.2	58.44±5.9	50.88±8.1	
Gender	Male	14	15	18	17
	Female	11	10	7	8
BMI (Kg/m <sup>2</sup> )/mean ± SD	26.4±4.1	32.1±5.3	30.6±3.5	29.2±5.9	
Family history of DM2	+ve	19	17	18	4
	-ve	6	8	7	21
HbA1c%	8.5±2.3	8.9±2.3	9.1±2.2	4.4±0.27	

## Method

**Echocardiography:** The gold standard biomarker of diagnosis was GLS% which was defined as the average longitudinal strain at end-systole in 18 segments. By regarding cut-off value of GLS = -18% according to (Islam E. Shehata et al<sup>[18]</sup>) who reported that a GLS cutoff of <-18.1% was able to accurately “predict subclinical LV systolic dysfunction”.

**Strain echocardiography:** Speckle tracking strain mode was selected on the echo-machine during apical 4, 2 and 3-chamber imaging and three consecutive cycles were recorded at a frame rate of 60 to 80 frame/sec. The LV is divided into 6 walls (inferoseptum, lateral, anterior, inferior, posterior and anteroseptal walls) every wall is divided into basal, mid and apical segments except the anteroseptum and posterior wall divided into basal and mid segments only, the global PLSL value for each participant were calculated as the average of values of the 16 segments<sup>[18]</sup>.

### Blood collection and Laboratory method:

Venous blood was acquired by venipuncture without anticoagulant treatment. Samples were centrifuged and subsequently aliquoted and stored at -80 °C prior to analysis. For RNA isolation, an miRNeasy Mini Kit (Sigma/USA) was used to extract total RNA from 500 µl of serum. Reverse transcription (RT) was performed using a TaqMan MicroRNA Reverse Transcription Kit (Sigma/USA). The RT product was preamplified, and level of miR-378-5p (assay MIRAP00354) were measured by qPCR using a TaqMan miRNA assay (Applied Biosystems). miRNA species with CT value ≥35 were considered below the detection threshold. The serum miRNA expression levels in individual samples were determined by a TaqMan probe-based RT-qPCR on a 7300 Real-Time PCR Sequence Detection System (Applied Biosystems). Because U6 and 5S rRNA are degraded in serum samples and the lack of a consensus housekeeping miRNA for the RT-qPCR analysis of serum miRNAs, miRNA expression was normalized to serum volume<sup>[19]</sup>. For serum and exosome samples. Influence of haemolysis was discarded by analysing the Ct values of miR-23a and miR-451a<sup>[20]</sup>.

## Results and Discussion

**The difference in miRNA-378 circulating level in different study groups:** There is significant elevation in the Ct value of miR-378 with the progression of the diabetic cardiomyopathy as presented in table (4)

indicating its down regulation as the disease progress. This result agreed with (Rui Guo et al) who classify miR-378 as anti-hypertrophic miRNAs as it is downregulated with the development of DbCM<sup>[21]</sup>.

This result disagreed with (Sarah Costantino,) who stated that miR-378 is one of key initiators of apoptosis, were significantly over expressed in the diabetic heart and intensive glycemic control was unable to revert these changes<sup>[22]</sup>. The complex biology of miRNAs may also influence the respective findings. The miRNA profile of a given cell is highly specific to the stressor which it is exposed and suggests that miRNA expression in the human heart is dynamically regulated as a function of the pathophysiological context<sup>[23]</sup>.

There is significant elevation in miR-378 Ct value between H & other three diabetic gps. (CD, M, F) as presented in table (5) p< 0.05; which represent its relevance to DM2. This result agreed with (Ivana Knezevic et al) who reported that in tissues such as fibroblasts and fetal hearts, where insulin-like growth factor receptor-1(IGF1R) levels are high, we found either absent or significantly low miR-378 levels, suggesting an inverse relationship between these two factors<sup>[24]</sup>. IGF-R are hybrid receptors which are more abundant when insulin receptors are down-regulated in response to the hyperinsulinemia as seen in insulin-resistant patients with DM2 as stated by Liam J. Murphy<sup>[25]</sup> Also it agreed with (Assmann et al<sup>[26]</sup>) who stated that it is down regulated with DM2. miR-378 down regulation relevance to DM2 approved by (Yong Zhang et al<sup>[27]</sup>) when they found that Tg mice had a significant overall increase in body O<sub>2</sub> consumption, CO<sub>2</sub> production, and energy expenditure.

The significant elevation in miR-378 Ct value in M than CD groups indicate its downregulation with the development of cardiomyopathy in its subclinical state as that miR-378 downregulated in case of hypertrophy development and oxidative stress increase<sup>[28]</sup>. These findings confirm the potential role of these modulators in identifying DbCM in relevance to their role in mitochondrial metabolism of cardiomyocyte via FoxO-1 as presented by (Puthanveetil, P.<sup>[29]</sup>) who stated that overexpression of FoxO1 mimics a hyperglycemic effect on vascular endothelium and also that hyperglycemia-induced endothelial dysfunction is mediated through FoxO1. miR-378 mimics reduced Akt phosphorylation also resulted in decreased phosphorylation of FoxO1, ultimately leading to FoxO1 activation. This effect was

also perceived in a H<sub>2</sub>O<sub>2</sub>-induced oxidative stress model in rat cardiomyocytes. So downregulation of miR-378 resulted in increased expression of FoxO1 which resulted in mitochondrial dysfunction trigger cardiac cell death in diabetic heart disease.

There is significant elevation in Ct value in F than M gp. (p=0.000) which indicate more downregulation of miR-378 in F gp. than M gp.as presented in table (5). This lower expression may be due to different

pathophysiological background related to hypertension & ischemia as concluded by (Jan Fiedler et al<sup>[30]</sup>) who published that presence of miR-378 attenuated ischemia-induced apoptosis by inhibiting caspase-3 expression in cardiac myocytes and blunted cardiac hypertrophy and dysfunction upon cardiac overload by targeting Ras signaling. So may be the ischemic hypertensive metabolic changes resulted in downregulation of miR-378.

**Table (4): ANOVA–All Groups with Ct of miR-378**

Descriptive				
Ct of miR-378				
Groups	Mean	Std. Deviation ±	95% Confidence Interval for Mean	
			Lower Bound	Upper Bound
CD	19.6	2.1	18.80208	20.54192
F	30.4	3.4	28.97827	31.89006
H	17.6	2.9	16.30735	18.89526
M	25.9	3.4	24.39589	27.45138

**Table (5): Comparison between groups**

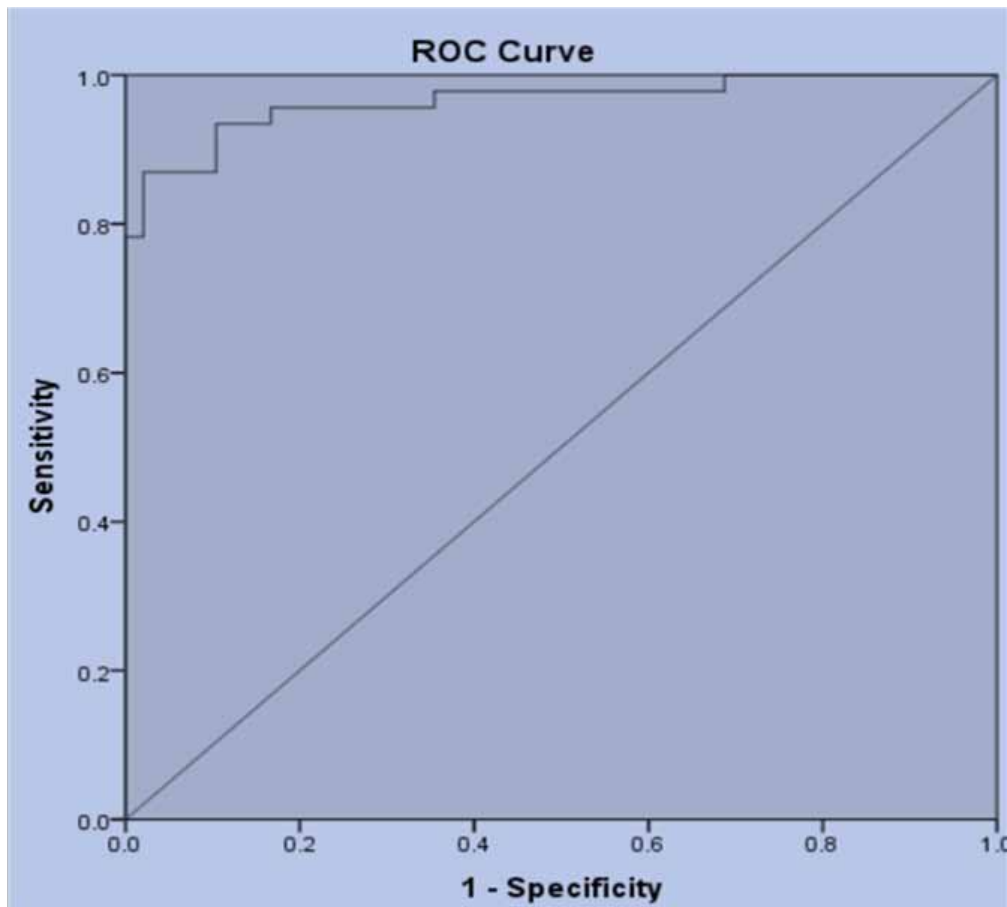
Multiple Comparisons					
Dependent Variable: Ct of miR-378					
LSD					
Groups		Mean Difference	p-value	95% Confidence Interval	
				Lower Bound	Upper Bound
H	CD	-2.070	.020	-3.80996-	-.33143-
	F	-12.832	.000	-14.58941-	-11.07632-
	M	-8.322	.000	-10.11752-	-6.52714-
M	CD	6.251	.000	4.49190	8.01137
	F	-4.510*	.000	-6.28734-	-2.73372-

\*. The mean difference is significant at the 0.05 level

**miRNA-378 as a screening marker:** To evaluate the potential diagnostic value of miRNA-378, the ROC curve has been used. For cut-off value, values exceeding the cut-off are positive, while those below the cut-off are negative.

It is found that the area under the ROC curve (AUC) was 0.965 (Fig. 1). The sensitivity and specificity were

0.978 and 0.646, respectively. The cut-off Ct value was 20.06, it was appeared to have independent associations with the clinical end-points that are studied. As a blood-based marker, the miR-378 characteristics as highly sensitive may improve the screening values of DbCM. These results suggested that miR-378 may be highly sensitive and moderately specific enough to detect DbCM.



**Figure (1): ROC curves for miRNA-378 Ct value in all study groups**

The extremely high sensitivity (0.978) of miR-378 to identify DbCM patients from non-symptomatic diabetic individuals exceeded our most optimistic expectations.

These findings strengthen the clinical applicability of circulating miR-378 as a biomarker of diabetic cardiomyopathy in type 2 diabetes patients.

### **Conclusion**

Serum miR-378 expression level can be regarded as a non-invasive tool to improve the detection, prediction, and monitoring of cardiac-related complications in the early stages of diabetes.

**Ethical Clearance:** The Research Ethical Committee at scientific research by ethical approval of both MOH and MOHSER in Iraq

**Conflict of Interest:** None

**Funding:** Self-funding

### **References**

1. Rubler S, Dlugash J, Yuceoglu YZ, et al. New type of cardiomyopathy associated with diabetic glomerulosclerosis. *Am J Cardiol.* 1972;30:595-602.
2. Boudina S, Abel ED. Diabetic cardiomyopathy, causes and effects. *Rev Endocr Metab Disord.* 2010;11:31-9.
3. Saeed M, Van TA, Krug R, et al. Cardiac MR imaging: current status and future direction. *Cardiovasc Diagn Ther.* 2015;5:290-310.
4. Amundsen BH, Helle-Valle T, Edvardsen T, et al. Noninvasive myocardial strain measurement by speckle tracking echocardiography: validation against sonomicrometry and tagged magnetic resonance imaging. *J Am Coll Cardiol.* 2006;47:789-93.
5. Saito M, Okayama H, Yoshii T, et al. Clinical significance of global two-dimensional strain as a surrogate parameter of myocardial fibrosis

- and cardiac events in patients with hypertrophic cardiomyopathy. *Eur Heart J Cardiovasc Imaging*. 2012;13:617-23.
6. Yingchoncharoen T, Agarwal S, Popovic ZB, et al. Normal ranges of left ventricular strain: a meta-analysis. *J Am Soc Echocardiogr*. 2013;26:185-91.
  7. Mor-Avi V, Lang RM, Badano LP, et al. Current and evolving echocardiographic techniques for the quantitative evaluation of cardiac mechanics: ASE/EAE consensus statement on methodology and indications endorsed by the Japanese Society of Echocardiography. *Eur J Echocardiogr*. 2011;12:167-205.
  8. Hogg K, Swedberg K, McMurray J. Heart failure with preserved left ventricular systolic function; epidemiology, clinical characteristics, and prognosis. *J Am Coll Cardiol*. 2004;43:317---27.
  9. Fang ZY, Schull-Meade R, Leano R, Mottram PM, Prins JB, Marwick TH. Screening for heart disease in diabetic subjects. *Am Heart J* 2005 Feb 1;149(2):349-354.
  10. Redfield MM, Rodeheffer RJ, Jacobsen SJ, Mahoney DW, Bailey KR, Burnett JC. Plasma brain natriuretic peptide to detect preclinical ventricular systolic or diastolic dysfunction. A community-based study. *Circulation* 2004;109:3176-3181.
  11. Kiencke S, Handschin R, von Dahlen R, et al. Pre-clinical diabetic cardiomyopathy: prevalence, screening, and outcome. *Eur J Heart Fail* 2010 Sep;12(9):951-957.
  12. Devereux RB, Roman MJ, Paranicas M, et al. Impact of diabetes on cardiac structure and function: the Strong Heart Study. *Circulation* 2000;101:2271-2276.
  13. Swoboda PP, McDiarmid AK, Erhayiem B, et al. Diabetes mellitus, microalbuminuria, and subclinical cardiac disease: identification and monitoring of individuals at risk of heart failure. *J Am Heart Assoc* 2017 Jul 1;6(7), e005539.
  14. Quiat D, Olson EN. MicroRNAs in cardiovascular disease: from pathogenesis to prevention and treatment. *J Clin Invest* 2013 Jan;123(1):11-18
  15. de Gonzalo-Calvo, D., Cenarro, A., Civeira, F. & Llorente-Cortes, V. microRNA expression profile in human coronary smooth muscle cell-derived microparticles is a source of biomarkers. *Clin Investig Arterioscler*. (2016).28, 167–177
  16. Ortega, F. J. et al. Profiling of circulating microRNAs reveals common microRNAs linked to type 2 diabetes that change with insulin sensitization. *Diabetes Care*. (2014).37, 1375–1383
  17. Guo R, Nair S. Role of microRNA in diabetic cardiomyopathy: from mechanism to intervention. *Biochim Biophys acta (BBA)-molecular basis Dis*. 2017;1863(8):2070–7.
  18. Shehata IE, Eldamanhory AS, Shaker A. Early predictors of left ventricular dysfunction in hypertensive patients: comparative cross-section study. *Int J Cardiovasc Imaging*. 2020;1–10.
  19. Wang J, Pei Y, Zhong Y, Jiang S, Shao J, Gong J. Altered Serum MicroRNAs as Novel Diagnostic Biomarkers for Atypical Coronary Artery Disease. 2014;9(9): 17-22
  20. Blondal, T. et al. Assessing sample and miRNA profile quality in serum and plasma or other biofluids. *Method*.(2013). 59, S1–6
  21. Guo R, Nair S. Role of microRNA in diabetic cardiomyopathy: from mechanism to intervention. *Biochim Biophys acta (BBA)-molecular basis Dis*. 2017;1863(8):2070–7.
  22. Costantino S, Paneni F, Lüscher TF, Cosentino F. MicroRNA profiling unveils hyperglycaemic memory in the diabetic heart. *Eur Heart J*. 2015;37(6):572–6.
  23. Waldenström, A., Genneback, N., Hellman, U. & Ronquist, G. Cardiomyocyte microvesicles contain DNA/RNA and convey biological messages to target cells. *PLoS One*. (2012).7, e34653
  24. Knezevic I, Patel A, Sundaresan NR, Gupta MP, Solaro RJ, Nagalingam RS, et al. A novel cardiomyocyte-enriched MicroRNA, miR-378, targets insulin-like growth factor 1 receptor implications in postnatal cardiac remodeling and cell survival. *J Biol Chem*. 2012;287(16):12913–26.
  25. Liam J. Murphy, Insulin-Like Growth Factor-I: A Treatment for Type 2 Diabetes Revisited, *Endocrinology*, Volume 147, Issue 6, 1 June 2006, Pages 2616–2618
  26. Assmann TS, Recamonde-Mendoza M, Costa AR, Puñales M, Tschiedel B, Canani LH, et al. Circulating miRNAs in diabetic kidney disease: case–control study and in silico analyses. *Acta Diabetol*. 2019;56(1):55–65.



27. Zhang Y, Li C, Li H, Song Y, Zhao Y, Zhai L, et al. miR-378 activates the pyruvate-PEP futile cycle and enhances lipolysis to ameliorate obesity in mice. *EBioMedicine*. 2016;5:93–104.
28. Nagalingam RS, Sundaresan NR, Gupta MP, Geenen DL, Solaro RJ, Gupta M. A cardiac-enriched microRNA, miR-378, blocks cardiac hypertrophy by targeting Ras signaling. *J Biol Chem*. 2013;288(16):11216–32.
29. Puthanveetil P. FoxO1–miRNA interacting networks as potential targets for mitochondrial diseases. *Drug Discov Today*. 2019;24(1):342–9.
30. Fiedler J, Baker AH, Dimmeler S, Heymans S, Mayr M, Thum T. Update on non-coding RNAs in vascular disease—from basic discoveries to clinical applications. *Cardiovasc Res*. 2018;

# Effects of Duration of Diabetes and Diabetes Therapy (Metformin) on Fbxw7 Levels in Iraqi Type II Diabetic Patients

Suhayla K. Mohammed<sup>1</sup>, Hayyan I. Al-Taweil<sup>2</sup>, NouraKaram M. Salih<sup>3</sup>,  
Samer Abdulhasan Muhi<sup>4</sup>, Ekhlass M. Taha<sup>5</sup>

<sup>1</sup>Instructor, Department of Chemistry College of Science for women University of Baghdad, Al-Jadriya Baghdad Iraq, <sup>2</sup>Assist. Prof., Department of Clinical Laboratory Science. Mohammed Al-Mana College for Medical Sciences. Al-Khobar, Eastern Province, Kingdom of Saudi Arabia, <sup>3</sup>Assist. Prof., Department of Science, Faculty of Engineering, Infrastructure University Kuala Lumpur, Jl-nikram/Uniten, Kajang, 43000, Selangor Darul El Ehsan, Malaysia, <sup>4</sup>Lecturer, Al-yarmouk Teaching Hospital, Al-Yarmouk Baghdad Iraq, <sup>5</sup>Assist. Prof., Department of Chemistry College of Science for women University of Baghdad, Al-Jadriya Baghdad Iraq

## Abstract

**Background:** This study concentrated on evaluation the FBXW7 levels and other markers in T2DM patients related to the duration of metformin monotherapy and duration of T2DM.

**Method:** The current study includes 60 diabetic patients type II and 30 control subjects. The groups of patients were subdivided in to two groups: (group I) (30) Newly diagnosed T2DM which also subdivided to two groups (> 1 year, and <1 year). Group II(30) T2DM (who were treated with metformin monotherapy) which also subdivided into two group (> 1 year and <1 year). In the present study FBXW7, FetuinA, pentraxin3, Nitric oxide and insulin were determined by the enzyme linked immune sorbent assay (ELISA). Biochemical markers, fasting serum glucose, and lipide profile were determined through spectrophotometere technique in patients and control groups.

**Result:** The levelsof glucose, HbA1c and IR significantly affected byincrease the duration of disease While each of fbxw7, pentraxin 3, NO, and fetuin A not influenced by increase duration of disease. There was non-significant effect of metformin therapy duration on levels of Fbxw7, fetuinA, pentraxin3 and lipid profile. While IR showed significant decrease when the duration of treatment increase.

**Conclusion:** Fbxw7, fetuinA, pentraxin3 and NO are not affected by long duration of therapy or by duration of disease while glucose, HbA1c, and IR are affected by increase duration of disease only. Whereas insulin and IR are affected by both; duration of disease and therapy.

**Keywords:** FBXW7, pentraxin3, nitric oxide, Type II diabetes, metformin, duration.

## Introduction

Among the most challenging health problems of the (21<sup>st</sup> century) is diabetes mellitus [1]. It is a chronic condition characterized by high levels of glucose in blood, resulting in significant damage to multiple organs including the heart, kidney, liver, eyes and vessels [2]. Weak glycemic regulation is known to be correlated substantially with a longer period of diabetes. Diabetes

---

### Corresponding Author:

**Ekhlass M. Taha**

Assist. Prof., Department of Chemistry College of Science for women University of Baghdad, Al-Jadriya Baghdad Iraq

e-mail: ikhlasmb\_chem@csw.uobaghdad.edu.iq

is a progressive disease and as glucose levels increase, more medicines are required to regulate it<sup>[3]</sup>. Metformin monotherapy is first treatment in diabetes type 2 patients which initiated when non-pharmacological therapy has failed to reach sufficient glycemic regulation<sup>[4]</sup>. Data from other studies showed that drug therapy of T2DM becomes more complex in longer duration of disease<sup>[5]</sup>. Fbxw7 is one of Fbox proteins and an important part of SCF E3 ligase complex that target proteins for the degradation<sup>[6][7]</sup>. Fbxw7 protects against hyperglycemia, insulin resistance, and the glucose intolerance. Previous studies in obese patients showed hepatic down regulation of fbxw7<sup>[8]</sup>. Fetuin A, named also  $\alpha$ -2 Hermans-Schmid glycoprotein AHSG is an acidic glycoprotein with molecular weight 64 KD<sup>[9]</sup>. It belongs to protease inhibitor cysteine superfamily<sup>[10]</sup>. Fetuin A is associated with high risk of diabetes, especially in people with high plasma glucose<sup>[11,12]</sup>. Studies to identify the markers for diabetes 2 and its associated cardiovascular complications are important to control the disease, prevent the onset and progression of lethal complications at early stage<sup>[13]</sup>. Pentraxin 3 are an acute phase protein superfamily which induce each of short pentraxin like c reactive protein (CRP) and long pentraxin like pentraxin 3 (PTX3)<sup>[14]</sup>. Actually, serum PTX3 level in patients with diabetes has been shown to be positively associated with atherosclerotic markers<sup>[15,16]</sup>. Nitric oxide (NO) is one of most common substances in the mammals which is considered as an internal gaseous free radical<sup>[17]</sup>. Previous studies suggested an alteration in serum NO levels in T2DM<sup>[18]</sup>. Some studies documented raise in NO rates in patients with diabetes while others reported lower in levels<sup>[19,20]</sup>. In the present study, we examined the effect of duration of T2DM disease and duration Therapy on fbxw7 and other parameters.

## Materials and Method

Serum sample from Ninety subjects were selected to perform this project, average between 37 to 69 years. They were divided into 3 groups as follows: A control group consisted of 30 apparently healthy individuals. Group 1 included 30 newly diagnosed (T2DM) without treatment, and group 2 included 30 patients on metformin monotherapy. Each group of patients' sub divided into two groups, > 1 year and < 1 year. Both groups collected from National Diabetes Center for Treatment and Research at Al Mustansiriyah University/Iraq. Patients with heart disease, liver disease, hypertension, kidney disease and smoker patients were excluded.

Blood samples were taken after overnight fasting. From each patient and control, 10 ml of blood was obtained. Two ml was dispensed in ethylenediaminetetraacetic acid (EDTA) tube. This blood was used for HbA1c estimation. Serum that obtained was used in determination of other parameters. Serum fetuin A was estimated by quantitative sandwich enzyme immunoassay technique, using the kit from Cusabio, China. FBXW7 was determined by competitive enzyme immunoassay technique using the kit from Biosource, USA. Enzymatic colorimetric method was used for serum glucose determination using the kit supplied by Randox UK. Insulin was determined by ELISA technique, using the kit supplied by Demeditec, Germany. Serum cholesterol and triglyceride were measured using the kit supplied by Spinreact, Spain. While serum HDL was determined by the kit supplied by Randox UK. Results were summarized as mean  $\pm$  SD. Statistical analysis program (SPSS 25) have been performed for analysis of the results. Student t-test has been used to identify the significant differences. Dendrogram have been used to identify the similarity between variables.

## Results and Discussion

**Effect of disease duration on diabetes related parameters:** Analysis of baseline characteristics table 1, showed that glucose level, HbA1c and insulin resistance IR significantly affected by the duration of disease, glucose level and IR showed significant increase in group of patient with duration of disease > 1 year, also HbA1c show significant decrease in patient group > 1 year. While BMI, WHtR, AI, and lipid profile showed non-significant difference between patient groups. A relation between FBS and duration of diabetes in this study is in agreement with the results obtained by a previous study which reported that the incidence of severe hyperglycemia increased with age and duration<sup>[21]</sup>. Long duration of Diabetes is known to be associated with poor control, possibly due to decrease secretion of insulin over time due to B cell failure, which makes the response to diet alone or oral agents unlikely<sup>[22]</sup>. The levels of Fbxw7 significantly increase in newly diagnosed DM as compared to control but the increase was non-significant with prolong the duration of disease as shown in Table 2. This increase may be due to damage tissues caused by diabetes lead to decrease fbxw7 in tissues and increase secretion in blood. While each of pentraxin 3, NO, and fetuin A not influenced by increase duration of disease.

**Table 1. Baseline characteristics of studied subjects**

Parameters	Control Group I	Newly DM (without therapy) Mean±Sd		P Value
		Group II (<1 year)	Group III (>1 year)	
BMI Kg/m <sup>2</sup>	26.7±2.87	30±4.6a	28.7±2.8	a0.041
WHtR	0.52±0.04	0.59 ± 0.058a	0.58±0.037	a0.015
FSG(mg/dl)	89.1±3.82	173.35±75.78a	197.20±28.83b,c	a0.0001 b0.0001 c 0.282
HbA1c%	5.26±0.44	9.34±2.15a	8.42±1.50b,c	a0.0001 b0.0001 c 0.17
Insulin(μU/ml)	13.67±8.11	12.32±4.18	19.24±17.4	>0.05 ns
HOMA-IR	2.98±1.8	5.08±2.42a	9.8±8.67 b,c	a0.04 b0.001 c0.003
TG(mg/dl)	114.15±20.7	160.82±126a	129.4±58.3	a 0.05
TC(mg/dl)	164.7±20.46	179.94±43.8	198.2±58.2	>0.05 ns
LDL-C(mg/dl)	96.4±15.69	110.15±32.9	128.4±53.4	>0.05 ns
HDL-C(mg/dl)	45.4±12.8	37±9.5a	44±8.4	a 0.047
VLDL-C (mg/dl)	22.7±4	32.1±25a	25.8±11.7	a0.047
Atherogenic index	0.4±0.16	0.57±0.24a	0.42±0.29	a0.033

P-value was calculated between groups and presented by the symbols below:

Group I (control) and group II (Newly diagnosed <1 year) represented by symbol (a)

Group III (Newly diagnosed >1 year) represented by symbol(b)

Group II and group III represented by symbol (c).

**Table 2. Effect of duration of disease on levels of FBXW7, Fetuin A, pentraxin3 and nitricoxide for newly diagnosed DM group**

Parameters	Control Group I	Newly DM (without therapy) Mean±SD		P value
		Group II (<1 year)	Group III (>1 year)	
FBXW7	1.12±0.9	2.56±1.18a	2.65±0.82b	a0.0001 b0.005
FetuinA	178.9±85.63	210±153	283.5±95.6	>0.05 ns
Pentraxin3	574.5±263.9	718.7±184	746.7±85.8	>0.05 ns
Nitricoxide	7.6±2.6	13.3±4.97	18.3±16.7	>0.05 ns

\*The mean difference is significant at the 0.05 level.

p-value was calculated between groups and presented by the symbols below:

Group I (control) and group II (Newly diagnosed <1 year) represented by symbol (a)

Group III (Newly diagnosed >1 year) represented by symbol (b)

Group II and group III represented by symbol (c).

**Effect of duration of metformin therapy on diabetic-related parameters:** Metformin is an antidiabetic medication that decreases peripheral resistance to insulin, increase peripheral uptake of glucose and reduces liver gluconeogenesis<sup>[23,24]</sup>. The results in the present study investigated the effects of duration of metformin therapy on fbw7 and other diabetic- related parameters. The result in table 3 revealed that insulin and IR significantly influenced by duration of therapy

and their levels decrease significantly by increase the duration of therapy, while there was non-significant difference in BMI, WHtR, AI, glucose, HbA1c, and lipid profile between groups of patient with treatment < 1 year and >1 year. Such finding are consistent with Delman Najim et al<sup>[25]</sup>, which revealed metformin as an antidiabetic agent to decrease blood insulin levels and insulin resistance.

Also table 4 showed that the levels of Fbxw7, fetuin A, pentraxin3, and NO not influenced by the duration of therapy and there were non-significant difference in these parameters between patient groups themselves.

**Table 3. Effect of duration of metformin in treatment on parameters.**

Parameters	Control Group I	DM with metformin Mean±SD		P Value
		Group II (<1 year)	Group III (>1 year)	
BMI Kg/m <sup>2</sup>	26.7±2.87	34.3±6.09a	31.2±5.57b	a0.000b0.002
WHtR	0.52±0.04	0.63±0.07a	0.60±0.11b	a0.002b0.001
FSG(mg/dl)	89.1±3.82	136.5±16.8a	134.19±38.6b	a0.011 b0.001
HbA1c%	5.26±0.44	7.65±.85a	7.38±1.19b	a0.0001b0.0001
Insulin(μU/ml)	13.67±8.11	20.01±11a	10.18±5 c	a0.049 c0.002
HOMA-IR	2.98±1.8	6.82±4.13a	3.34±1.8c	a0.005c0.003
TG(mg/dl)	114.15±20.7	139.75±60.4	116.4±52.66	>0.05 ns
TC(mg/dl)	164.7±20.46	174.7±38.2	172.3±40.81	>0.05 ns
LDL-C(mg/dl)	96.4±15.69	103.53±33.5	106.6±39.20	>0.05 ns
HDL-C(mg/dl)	45.46±12.8	43.46±10.9	43.66±14.61	>0.05 ns
VLDL-C (mg/dl)	22.7±4	27.87±11.8	23.25±10.43	>0.05 ns
Atherogenic index	0.4±0.16	0.48±0.27	0.41±0.26	>0.05 ns

\*The mean difference is significant at the 0.05 level.

p-value was calculated between groups and presented by the symbols below:

Group I (control) and group II (Newly diagnosed <1 year) represented by symbol (a)

Group III (Newly diagnosed >1 year) represented by symbol (b)

Group II and group III represented by symbol (c).

**Table 4. Effect treatment duration (metformin) on levels of FBXW7, Fetuin A, pentraxin3 and nitricoxide for T2DM on metformin monotherapy group.**

Parameters	Control Mean±SD	DM with metformin		P Value
		Group II (<1 year)	Group III (>1 year)	
FBXW7	1.12±0.9	0.77±0.61	1.07±1.18	>0.05 ns
FetuinA	178.9±85.6	170.5±65.8	166±97.60	>0.05 ns
Pentraxin3	574.5±263.9	595.3±188	602.7±224.3	>0.05 ns
Nitricoxide	7.6±2.6	10.8±6.49	27.1±32.2b	b0.002

\*The mean difference is significant at the 0.05 level.

p-value was calculated between groups and presented by the symbols below:

Group I (control) and group II (Newly diagnosed <1 year) represented by symbol (a)

Group III (Newly diagnosed >1 year) represented by symbol (b)

Group II and group III represented by symbol (c).

## Conclusion

Duration of disease and treatment appear effect on some parameters and not effected other parameters Fbxw7, fetuin A, pentraxin3 and nitric oxide are not

affected by the long duration of therapy or by the duration of disease while glucose, HbA1c, and IR are affected by increase duration of disease only. Whereas insulin and IR are affected by both; duration of disease and therapy.

**Ethical Clearance:** The Research Ethical Committee at scientific research by ethical approval of both MOH and MOHSER in Iraq

**Conflict of Interest:** None

**Funding:** Self-funding

### References

1. International Diabetes Federation. IDF Diabetes Atlas, 6th ed. Brussels, Belgium: International Diabetes Federation;(2013). <http://www.idf.org/diabetesatlas>.
2. C.Mátyás, Pathophysiology and pharmacology of nitric oxide-cyclic guanosine monophosphate signaling in diabetic cardiomyopathy. Doctoral dissertation, Budapest: Semmelweis University;(2017).
3. M.Badedi, Y.Solan, H.Darraj, A.Sabai, M. Mahfouz, S.Alamodi, A.Alsabaani, Factors Associated with Long-Term Control of Type 2 Diabetes Mellitus. *Journal of Diabetes Research*(2016), <http://dx.doi.org/10.1155/2016/2109542>
4. M.Janić, S.Volčanšek, M.Lunder, A.Janež, Metformin: from mechanisms of action to advanced clinical use. *Zdravniski Vestnik*. (2017) 1;86
5. Y.O.Yaseen, J. J. Atyia, Facts about type 2 diabetes mellitus and its control in Misan governorate: singlecenter experience. *The medical journal of Basrah university*, (2018)36.
6. Q.Li, Y.Li, J.Li, Y.Ma, W.Dai, S.Mo, Y.Xu, X.Li, S.Cai, FBW7 suppresses metastasis of colorectal cancer by inhibiting HIF1 $\alpha$ /CEACAM5 functional axis. *International Journal of Biological Science*, (2018) 14(7): 726–735.doi: 10.7150/ijbs.24505
7. M.Takada, M.Zhuang, H.Inuzuka, J.Zhang, G.Zurlo, J.Zhang, EglN2 contributes to triple negative breast tumorigenesis by functioning as a substrate for the FBW7 tumor suppressor. *Oncotarget*, (2017)8:6787.doi: 10.18632/oncotarget.14290
8. J.ZhaoX., Xiong, Y.Li, X.Liu, T.Wang, H.Zhang, Hepatic F-box protein FBXW7 maintains glucose homeostasis through degradation of fetuin-A, *Diabetes*. (2018)67;818-30.doi: 10.2337/db17-1348. Epub 2018 Feb 23.
9. S.Sindhu, A.Nadeem, A.Rasheed, Fetuin a (AHS)G) in metabolic and inflammatory diseases: a foe or a friend, *Diabetes Obesity International Journal*, (2016)1:1-5.
10. R.S. Komsa-Penkova, G.M. Golemanov, Z.V. Radionova, P.T. Tonchev, S.D. Iliev, V.V. Penkov, Fetuin-A–Alpha2-Heremans-Schmid Glycoprotein: From Structure to a Novel Marker of Chronic Diseases Part 1. Fetuin-A as a Calcium Chaperone and Inflammatory Marker. *Journal of Biomedical and Clinical Research*, (2017)10;90-7.
11. C.L. Udeh, Fetuin-A: A Biomarker for Type II Diabetes Mellitus. *International Journal of Biomedical Materials Research*, (2017)5; 72-77DOI: 10.11648/j.ijbmr.20170506.12
12. Q.Sun, M.C.Cornelis, J.E.Manson, F.B.Hu, Plasma levels of fetuin-A and hepatic enzymes and risk of type 2 diabetes in women in the U.S. *Diabetes*, (2013)62: 49–55.doi: 10.2337/db12-0372.
13. G.Lowe, M.Woodward, G.Hillis, A.Rumley, Q.Li, S.Harrap, M.Marre. Circulating inflammatory markers and the risk of vascular complications and mortality in people with type 2 diabetes and cardiovascular disease or risk factors: the ADVANCE study, *Diabetes*, (2014)163;1115-23. doi: 10.2337/db12-1625.
14. F.Bonacina, A.Baragetti, A.L.Catapano, G.D.Norata, Long pentraxin 3: experimental and clinical relevance in cardiovascular diseases. *Mediators of inflammation*. (2013)2013doi: 10.1155/2013/725102
15. Y.Takashi, M.Koga, Y.Matsuzawa, J. Saito, M.Omura, T. Nishikawa, Circulating pentraxin 3 is positively associated with chronic hyperglycemia but negatively associated with plasma aldosterone Concentration, *PLoS ONE*, (2018)13 <https://doi.org/10.1371/journal.pone.0196526>
16. A.Shindo, H.Tanemura, K.Yata, K.Hamada, M. Shibata, Y.Umeda, & W.Taki, Inflammatory biomarkers in atherosclerosis: pentraxin 3 can become a novel marker of plaque vulnerability, *PLoS one*, (2014)9, e100045doi: 10.1371/journal.pone.0100045
17. N.N.Oudah, Purification and Characterization of Arginase and Measuring the Nitric Oxide Levels in Iraqi Diabetes Mellitus Type II Patients. Doctoral dissertation, Baghdad University, Baghdad, (2018).
18. O. Ozcelik, S. Algul, Nitric oxide levels in response to the patients with different stage of diabetes. *Cell Mol Biol*, (2017)63; 49-52. doi:10.14715/cmb/2017.63.1.10

19. P.Tessari, D.Cecchet, A.Cosma, M.Vettore, A.Coracina, R.Millioni, Nitric oxide synthesis is reduced in subjects with type 2 diabetes and nephropathy. *Diabetes*, (2010)59;2152-9DOI: 10.2337/db09-1772.
20. K Maejima, S Nakano, M Himeno, S Tsuda, H Makiishi, T Ito, A Nakagawa, T Kigoshi, T Ishibashi, M Nishio, K Uchida, Increased basal levels of plasma nitric oxide in Type 2 diabetic subjects. Relationship to microvascular complications. *Journal of Diabetes Complications*, (2001)15;135-43doi: 10.1016/s1056-8727(01)00144-1.
21. J.S. Yun, S.H.Ko, Risk factors and adverse outcomes of severe hypoglycemia in type 2 diabetes mellitus. *Diabetes Metabolism Journal*, (2016)40; 423-432. <https://dx.doi.org/10.4093%2Fdmj.2016.40.6.423>
22. UK Prospective Diabetes Study (UKPDS) Group. Intensive bloodglucose control with sulphonylureas or insulin compared with conventional treatment and risk of complications in patients with Type 2 diabetes. *Lancet*, (1998)352; 837–853.[https://doi.org/10.1016/S0140-6736\(98\)07019-6](https://doi.org/10.1016/S0140-6736(98)07019-6)
23. M. P. van der, M. A. Elst E. M. van de Garde E. G . van Mil C .A. J Knibbe M .M. van der Vorst, Long-term treatment with metformin in obese, insulin-resistant adolescents: results of a randomized double-blinded placebo-controlled trial. *Nutrition & diabetes*, (2016)6; e228doi: 10.1038/nutd.2016.37..
24. Z.Polianskyte-Prause, T.A. Tolvanen, S.Lindfors, V. Dumont, M.Van, H. Wang, S. N. Dash, M. Berg, J.Naams, L.C.Hautala, H.Nisen, T.Mirtti, P.Groop, K.Wähälä, J.Tienari, and S.Lehtonen. Metformin increases glucose uptake and acts renoprotectively by reducing SHIP2 activity. *The FASEB journal*, (2019)33; 2858-2869.
25. H.D. Najim, I.A. Majeed, A.M.Rahmah. Effects of Metformin &/or Glimpiride on Resistin Level and Related Biochemical Markers in Type 2 Diabetes Mellitus. *Al-Mustansiriyah Journal of Pharmaceutical Sciences (AJPS)*,(2014)14;78-88.

# Color Change of Two Different Nano-Hybrid Resin Composite Materials after Staining and Bleaching. (An *in vitro* Study)

Zahraa Sabah Abdul Wahhab<sup>1</sup>, Emad Farhan Alkhalidi<sup>2</sup>

<sup>1</sup>B.D.S., Conservative Dentistry Department/Dentistry College/Mosul University/Iraq,

<sup>2</sup>Assist. Prof. Dr. Ph.D. Oral Sciences, Conservative Dentistry Department/Dentistry College/Mosul University/Iraq

## Abstract

**Purpose:** To investigate the effects of staining and bleaching on color change of two different Nano-Hybrid resin composite materials.

**Materials and Method:** In total, 48 samples were fabricated (24 samples from each Nanotype). Samples of each composite group were sub-divided into three sub-groups (n=8). Samples of *Stain sub-groups* immersed in coffee solution for 48 hours at 37°C; in *Stain Bleach sub-groups*, samples were stored in coffee solution for 48 hours at 37°C then bleached with 30% H<sub>2</sub>O<sub>2</sub>; in *Bleach sub-groups*, samples were bleached with 30% H<sub>2</sub>O<sub>2</sub>. After that, color measurements were recorded again for each sub-group.

**Results:** After staining and bleaching, all sub-groups of both tested materials demonstrated clinically acceptable color change ( $\Delta E < 3.3$ ) with significant differences ( $P < 0.05$ ).

**Conclusion:** Color change of the two tested materials do not affected by staining and bleaching.

**Keywords:** Composite resin, color change, staining, bleaching, hydrogen peroxide.

## Introduction

The esthetic success of resin composite restoration depends greatly on its optical appearance and color match with the surrounding natural dentition; to render a restoration imperceptible, restoration materials should reproduce color of natural teeth and maintain long-term color stability and resistance to discoloration<sup>(1)</sup>. Many parameters affect the color stability of resinous materials like type and volume of resin material, size and type of filler particles, and the coloring agents. Extrinsic discoloration can be caused by dietary and smoking habits, and adsorption or absorption of water-

soluble stains within the composite organic matrix<sup>(2)</sup>. Stains can be removed partially or totally by brushing with toothpastes, polishing and bleaching; tooth bleaching is considered a conservative, easy and efficient method for teeth whitening, and nowadays, tooth bleaching has become a routine treatment in common dental practice. Bleaching treatments can improve the color of discolored teeth and, at the same time, may yield color alterations of the existed composite restorations on teeth; also, composite restorations might undergo changes due to softening effects of bleaching which ultimately affect their clinical durability<sup>(3)</sup>. With the application of Nanotechnology to dental composites, Nano Hybrid composites have been used as restorative materials for their favorable mechanical properties. However, there is a controversy regarding their color stability after staining and bleaching. Therefore, this study investigated the color change of two Nanohybrid composite materials after staining by coffee and bleaching with 30% hydrogen peroxide. The null hypothesis suggested that staining and bleaching have no influence on color of both tested materials.

---

### Corresponding Author:

**Emad Farhan Alkhalidi**

Assist. Prof. Dr. Ph.D. Oral Sciences, Conservative Dentistry Department/Dentistry College/Mosul University/Iraq

e-mail: dr.emadalkhalidi@gmail.com



## Materials and Method

**Samples Fabrication:** Twoesthetic Nano Hybridcomposite materials (Joyfil Nano hybrid composite, and Omnichroma resin based composite) were tested in this study (Table 1). In total, 48 disc samples (24 samples from each Nanotype), 5 mm in diameter and 2 mm in thickness, were fabricated using Polyurethane mold. The mold was placed on a transparent celluloid matrix over a glass slab and filled with the tested material, then the surface of the mold was covered with another matrix and a glass slab. A 500g load was placed for 30 seconds on the top of each sample to allow the excess material to leak out<sup>(4)</sup>. Load was then discontinued and the sample was light cured for 40 seconds using (LED light curing unit, Blue phase, Woodpecker, China) with 1000mW/cm<sup>2</sup> light intensity. Specimens were stored in artificial saliva at 37°C for 24 h<sup>(5)</sup>. Specimens of each composite material were divided into two major groups:

**Gp1:** Joyfil composite. (24 samples),

**Gp2:** Omnichroma composite. (24 samples).

Each composite group was further randomly subdivided into three sub-groups, each of which contained 16 samples (8 samples of each composite type) as follow:

- **Stain sub-groups:** Specimens were stained by incubating the samples in coffee solution at 37°C for 48 hours, then color change measurements were recorded.
- **Stain Bleach sub-groups:** Firstly, specimens stained in coffee solution for 48 hours then chemically bleached by 30% H<sub>2</sub>O<sub>2</sub> gel; after that, color change measurements were recorded.
- **Bleach sub-groups:** Specimens were chemically bleached with 30% H<sub>2</sub>O<sub>2</sub> gel then color change measurements were recorded.

**Table (1): Materials used in the study**

Material name	Type	Composition	Manufacture
Joyfil	Nano Hybrid universal composite (Shade:A <sub>2</sub> )	<b>Matrix:</b> BIS-GMA <b>Filler:</b> Non- agglomerated 7 nm nano-silica filler in size and aggregated schott glass/silica nano-cluster filler. Range is 0.7µm (74%w, 58.89%v)	3D Dental, USA
Omnichroma	Nano Hybrid composite (Universal shade)	<b>Matrix:</b> 1,6(methacryl ethyloxycarbonylamino), UDMA, TEGDMA. <b>Filler:</b> Spherical silica-zirconia filler. Ranging from 0.2-0.6micron (Mean particle size is 0.3µm (79%w, 68%v).	Tokuyama Dental, Japan
Dash Chairside whitening system	In-office chemical bleaching	30%Hydrogen peroxide	Philips, USA

**Staining Method:** Samples of Stain and Stain Bleach sub-groups of both composite materials were stained by coffee solution which was prepared by mixing (1.5g) of coffee powder (Nescafe Classic, Nestle, Indonesia) in 120 ml of boiling water according to manufacturer's instructions. Samples of both sub-groups were incubated in coffee solution for 48 hours at 37°C<sup>(1)</sup>. After staining, samples of Stain sub-groups were washed with distilled water and air-dried to be ready for recording color measurements, while samples of Stain Bleach sub-groups were rinsed with distilled water and incubated again in artificial saliva at 37°C until performing bleaching procedure.

**Bleaching Procedure:** Samples of Stain Bleach and

Bleach sub-groups were chemically bleached with 30% H<sub>2</sub>O<sub>2</sub> (Dash Chairside whitening system, Philips, USA). Bleaching gel was applied in an equal amount on the specimen for 45 minutes in three cycles, each cycle lasted 15 minutes according to manufacturer's instructions. After bleaching, samples were washed under running water for 1 minute to eliminate bleaching material remnants and then air-dried before color measurements were recorded.

**Color measurement procedure:** Color measurements were taken first for all sub-groups using VITA Easyshade®V Spectrophotometer and considered as initial data. After staining and bleaching procedures, color measurements were taken again for all samples

of both materials. VITA Easy shade is a simple click digital spectrophotometer that provides an instant shade read out. The measurements depend on the CIE L\*a\*b\* (Commission International del'Eclairage) color system to perform color change test (6). Color is measured in three coordinate dimensions: L\* refers to lightness and its value range from (0) for perfect black to (100) for perfect white; the a\* value is a measure of red-green axis, (+a\*=red, -a\*=green); the b\* value is a measure of yellow-blue axis, (+b\*=yellow, -b\*=blue)(5). Measurements were repeated for 3 times for each specimen and color change (ΔE) values were recorded according to the formula

$$\Delta E^* = \sqrt{(\Delta L^*)^2 + (\Delta a^*)^2 + (\Delta b^*)^2}$$

**Statistical analysis:** Normality test was used to check the normal distribution of the data and non-parametric tests were chosen since the data follow abnormal distribution. Friedman's test of related samples was used to test the significance of staining and bleaching at P<0.05 among and between the three sub-groups of both tested materials. Mann-Whitney U Test for independent samples was used to compare (ΔE) mean values between every two similar sub-groups of the two materials.

### Results

The ΔE\* values of all sub-groups were recorded and analyzed. According to many studies there are three

different intervals for(ΔE): ΔE<1, imperceptible by human eye, 1<ΔE<3, recognized only by skilled persons; and ΔE ≥3.3, easily observed by human eye (clinically unacceptable) (1). Mean and standard deviation of (ΔE) values are displayed in Table(2). All sub-groups of the two materials showed clinically acceptable color change (ΔE<3.3). Friedman's test demonstrated significant differences (P<0.05) in color change among all sub-groups for both tested materials as demonstrated in Table(3). As the sub-groups of both materials were significantly different, Friedman's test was used again to compare each two pairs of sub-groups in both materials to indicate the difference between which sub-groups. In Joyfil composite sub-groups, there were significant differences (P<0.05) between Stain sub-group with both Stain Bleach and Bleach sub-groups. However, no significant difference (P>0.05) was seen between Stain Bleach and Bleach Joyfil sub-groups. For Omnichroma sub-groups, the results showed significant difference (P<0.05) between Stain Bleach and Bleach sub-groups. In contrast, there was no significant difference (P>0.05) between the other pairs of sub-groups as seen in Table(4). Mann-Whitney U Test used to compare the (ΔE) mean values of each two similar sub-groups of both composite materials, the results revealed significant differences (P<0.05) between Stain sub-groups and also between Bleach sub-groups. However, no significant difference (P>0.05) was seen between Stain Bleach sub-groups of both materials as seen in Table(5) and Figure(1).

**Table (2): Mean and standard deviation of Color Change (ΔE) for all sub-groups of both tested materials**

Sub-groups	Joyfil (ΔE)		Omnichroma (ΔE)	
	Mean	Std. Deviation	Mean	Std. Deviation
Stain	3.2	0.382324	2.03375	0.587001
Stain Bleach	1.64	0.822540	1.68750	0.339695
Bleach	2.04875	0.252102	2.47125	0.414882

**Table (3): Comparison of (ΔE) values among all sub-groups of both tested material**

Test	Joyfil		Omnichroma	
	Test statistic	Sig	Test statistic	Sig
Related-Samples Friedman's Two-Way Analysis of Variance by Ranks	13	0.002	10.750	0.005

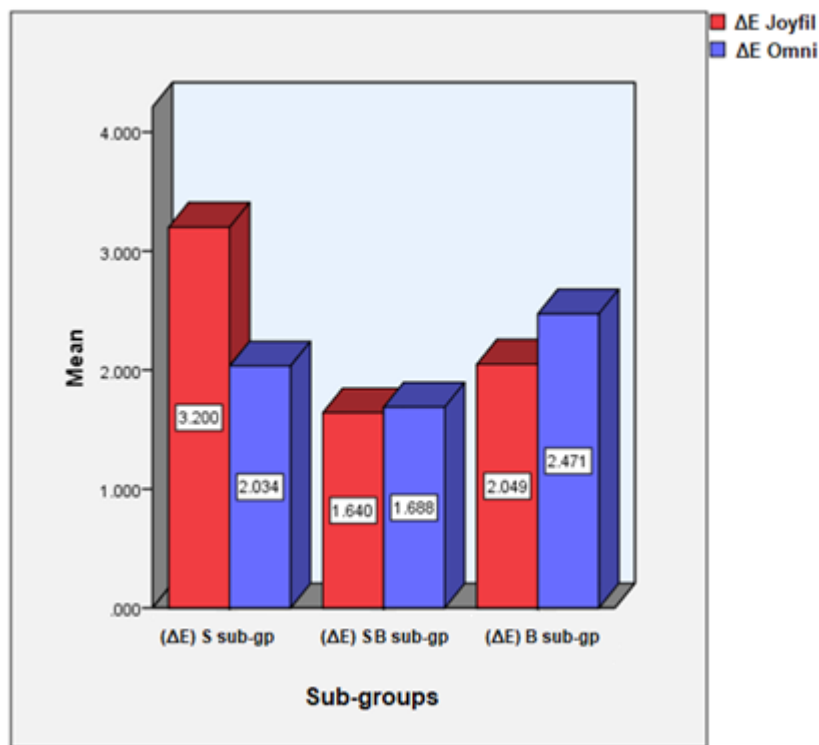
**Table (4): Comparison the ( $\Delta E$ ) values for each two pairs of sub-groups for both tested materials.**

Joyfil	Test Statistic	Sig	Omnichroma	Test Statistic	Sig
Pair 1 SB sub-g – B sub-g	-0.500	0.952	Pair 1 SB sub-gp – S sub-gp	0.625	0.634
Pair 2 SB sub-g– S sub-g	1.750	0.001	Pair 2 SB sub-gp – B sub-gp	-1.625	0.003
Pair 3 B sub-g – S sub-g	1.250	0.037	Pair 3 S sub-gp – B sub-gp	-1.000	0.137

(S sub-gp: Stain sub-gp, SB sub-gp:Stain Bleach sub-gp, B sub-gp:Bleach sub-gp).

**Table (5): Comparison between the ( $\Delta E$ ) mean values for all sub-groups of both tested materials.**

( $\Delta E$ ) of sub-groups of Joyfil and Omnichroma composites	Test statistic	Sig
( $\Delta E$ ) S sub-gp (Joyfil) and ( $\Delta E$ ) S sub-gp (Omni)	3.000	0.001
( $\Delta E$ ) SB sub-gp (Joyfil) and ( $\Delta E$ ) SB sub-gp (Omni)	41.000	0.382
( $\Delta E$ ) B sub-gp (Joyfil) and ( $\Delta E$ ) B sub-gp (Omni)	52.0000	0.038



**Figure (1): Comparison between the mean of ( $\Delta E$ ) values for each two similar sub-groups of both tested materials.**

### Discussion

Resin composites are frequently used esthetic restorations in dentistry for their excellent aesthetic properties and adequate strength; composite restorative materials should mimic the appearance of natural teeth and one of main causes for replacement of restorations is when they reflect unacceptable color match with the surrounding dentitions<sup>(7)</sup>. For achieving desirable esthetics in dentistry, composite restorations should be able to maintain intrinsic color stability and resistance

to surface staining. However, over time, composite restorations in the oral environment acquire external stains and develop internal discoloration which may be explained by the biphasic nature of the material (composed of matrix and fillers) that facilitates inclusion of external stains in its structure<sup>(8)</sup>. Coffee was selected in this study because it is frequently consumed beverages and it has a strong potential to stain teeth and restorative materials. Many studies have used coffee as a staining solution<sup>(1,3,7,9,10)</sup> and according to coffee manufacturers,

it requires an average of 15 minutes to drink a cup of coffee; coffee drinkers consume an average of 3.2 cups of coffee per day; therefore, specimens storage in coffee solution for 48 h equals an average of two months of coffee intake<sup>(9)</sup>. The findings of the present study showed that coffee induced clinically acceptable color change ( $\Delta E < 3.3$ ) in specimens of stain sub-groups for both tested materials with significant differences ( $P < 0.05$ ) between the two sub-groups. Discoloration by coffee attributed to both absorption and adsorption of polar colorants onto the surface of materials<sup>(7)</sup>. Another reason can be related to fluid uptake by resin composites as when composite can absorb water, so it can absorb other colored solutions; the increase in fluid uptake was related to incorporation of hydrophilic monomers in composite resin matrix. Bis-GMA and TEGDMA are hydrophilic monomers, but fluid uptake in Bis-GMA increased from 3 to 6%, while in TEGDMA it increased from 0 to 1%<sup>(2)</sup>. Although presence of Bis-GMA and TEGDMA in the two tested materials, their color change after staining was clinically acceptable. However, Omnichroma Stain sub-group was significantly less than Joyfil Stain-sub-group which can be attributed to the presence of UDMA in its resin matrix which is more stain resistant than Bis-GMA with low water sorption and solubility. The acceptable color change and low staining susceptibility after staining for both tested materials can be explained by low resin content in the two materials (26% for Joyfil and 21% for Omnichroma). The findings of this study came in agreement with the results of some studies who obtained acceptable color change ( $\Delta E < 3.3$ ) of resin composites after staining with coffee<sup>(1,11)</sup>. In contrast, other studies found that coffee had induced severe clinically unacceptable staining ( $\Delta E > 3.3$ ) of resin composite samples<sup>(3,7,9,10)</sup>. This discrepancy in results were probably related to differences in staining methodologies like the type of immersion solution and immersion time; also, the differences in chemical composition of resin composite used may affect the results.

The interaction between bleaching agents and composite materials is of clinical significance and should be focused on; the bleaching system used in the current study was chemically activated with 30%  $H_2O_2$ . Hydrogen peroxide is a strong oxidizing agent that generates free radicals which have an extensive ability for diffusion and penetration the surface of composite materials then producing degradation of polymer network; thus, a resin composite with higher resin content is expected to be

more pronounced to degradation and subsequently may undergo more color change<sup>(12)</sup>.

Ideally, bleaching after staining would be considered good if ( $\Delta E$ ) values decreased and perfect if ( $\Delta E$ ) values are equal to zero because this means that the restorative materials have returned to their baseline color before staining<sup>(1)</sup>. The findings of this study showed that bleaching after staining for both Joyfil and Omnichroma Stain Bleach sub-groups also gave acceptable color change ( $\Delta E < 3.3$ ) with no significant differences ( $P > 0.05$ ) which refers to that bleaching following staining was effective in reducing the discoloration for both tested materials as the ( $\Delta E$ ) values after bleaching were decreased from the ( $\Delta E$ ) obtained after staining. These results came in accordance to some studies that found bleaching treatments have decreased ( $\Delta E$ ) values of composite tested materials to a clinically acceptable level even after severe color change due to staining; they attributed this to superficial cleansing of the specimens by bleaching agents not due to internal bleaching<sup>(8,13)</sup>. In contrast with these results, others stated that bleaching after staining with a high concentration of  $H_2O_2$  gave high and unacceptable color alteration ( $\Delta E > 3.3$ ) for the tested materials and explained their results that high concentrations of  $H_2O_2$  may cause chemical softening of restorative materials leading to more color change<sup>(1,14)</sup>.

After bleaching, ( $\Delta E$ ) values of both tested materials for bleach sub-groups were also within the acceptable range ( $\Delta E < 3.3$ ). However, the ( $\Delta E$ ) values of Omnichroma study samples was significantly higher ( $P < 0.05$ ) than that of Joyfil study samples. Omnichroma composite has average filler particles size of  $0.3\mu m$  and lower amount of resin matrix (21%) by weight with different percentages of UDMA and TEGDMA, so it is expected to show low color change, but the results demonstrated the opposite. In contrast, Joyfil is Bis-GMA based resin material with average filler particles size of  $0.7\mu m$  and resin matrix of (26%) by weight, but it showed less color change compared to Omnichroma resin composite. This finding may be explained by the differences of bond interfaces between resin matrix and fillers or the type of prepolymerized filler particles incorporated in these two materials that may influence the effect of bleaching agent on them.

With respect to comparison of ( $\Delta E$ ) values among the three sub-groups in each tested material, the results showed significant difference among all sub-groups of the two tested material which may refer to that staining

and bleaching can change the color of tested samples but with acceptable levels.

Some limitations in this study can be pointed out like immersion of study samples in a single type of staining beverage; which can't reflect the actual staining potential of human dietary behavior. Also, this is an *in vitro* study, so it is impossible to directly mimic oral conditions because food and beverages ingestion is a dynamic process that doesn't allow sustained static retention of stain in the oral cavity.

### Conclusion

1. The two Nano-Hybrid composite tested materials reacted similarly to staining and bleaching.
2. Staining by coffee and bleaching by 30% $H_2O_2$  didn't influence the color of both tested materials as  $\Delta E$  values were within acceptable range ( $\Delta E < 3.3$ ).

**Ethical Clearance:** The Research Ethical Committee at scientific research by ethical approval of both MOH and MOHSER in Iraq

**Conflict of Interest:** None

**Funding:** Self-funding

### References

1. ElSayad II. Color and translucency of finished and unfinished esthetic restorative materials after staining and bleaching. *Saudi Dent J*. 2018; 30(3):219-225.
2. Bagheri R, Burrow MF, Tyas M. Influence of food-simulating solutions and surface finish on susceptibility to staining of aesthetic restorative materials. *J Dent*. 2005;33(5):389-398.
3. Villalta P, Lu H, Okte Z, Garcia-Godoy F, Powers J. Effects of staining and bleaching on Colorchange of dental composite resins. *J Prosthet Dent*. 2006;95(2):137-142.
4. Bahari M, Chaharom MEE, Daneshpooy M, Gholizadeh S, PashayiH. Effect of bleaching protocols on surface roughness and biofilm formation on silorane-based composite resin. *Dent Res J*. 2019;16(4):264-270.
5. Telang A, Narayana IH, Madhu KS, Kalasaiah D, Ramesh P, Nagaraja S. Effect of Staining and Bleaching on Colorstability and Surface Roughness of Three Resin Composites: An *in vitro* study. *Contemp Clin Dent*. 2018;9(3):452-456.
6. Hussein MA. Preparation and evaluation of new self-adhesive resin cement with nano-Hydroxyapatite Particles (An *in vitro* study). Ph.D. Thesis. Mosul University, College of Dentistry. Mosul/Iraq. 2019.
7. Tuncer D, Karaman E, Firat E. Does the temperature of beverages affect surface roughness, hardness, and Colorstability of a composite resin?. *Eur J Dent*. 2013;7(2):165-171.
8. Pruthi G, Jain V, Kandpal HC, Mathur VP, Shah N. Effect of Bleaching on Color Change and Surface Topography of Composite Restorations. *Int J*. 2010;1-7.
9. Hafez R, Ahmed D, Yousry M, El-Badrawy O, El-Mowafy O. Effect of In-Office Bleaching on Color and Surface Roughness of Composite Restoratives. *Eur J Dent*. 2010;4(2):118-127.
10. Tiani F, Jin YAP AU, WANG X, GAO X. Effect of staining solutions on Color of pre-reacted glass-ionomer containing composites. *Dent Mater J*. 2012;31(3):384-388.
11. Topcu FT, Sahinkesen G, Yamanel K, Erdemir U, Oktay EA, Ersahan S. Influence of different drinks on the colour stability of dental resin composites. *Eur J Dent*. 2009;3(1):50-56.
12. Durner J, Obermaier J, Ilie N. Investigation of different bleaching conditions on the amount of elutable substances from nano-hybrid composites. *Dent Mater*. 2014;30(2):192-199.
13. Poggio C, Beltrami R, Scribante A, Colombo M, Chiesa M. Surface discoloration of composite resins: Effects of staining and bleaching. *Dent Res J*. 2012;9(5):567-73.
14. Mohammadi N, Kimyai S, Abed-Kahnamoii M, Ebrahimi-Chaharom, ME, Sadr A, Daneshi M. Effect of 15% carbamide peroxide bleaching gel on Colorstability of giomer and microfilled composite resin: An *in vitro* comparison. *Med Oral Patol Oral Cir Bucal*. 2012;17(6):e1082-e1088.

# The Effect of Interfering Waves Strategy in Developing Some Basic Volleyball Skills for Intermediate First Graders

Aujeed Madlool Abbas<sup>1</sup>, Sattar Jaber Ashour<sup>2</sup>, Bashar Akram Mohammed<sup>2</sup>, Jabbar Ali Kathim<sup>3</sup>

<sup>1</sup>Lect., <sup>2</sup>Assist. Lect., <sup>3</sup>Assist. Prof., Al-Qasim Green University/College of Physical Education and Sports Sciences/Iraq

## Abstract

The research objectives to reveal the effect of using the interfering waves strategy in learning some basic skills in the game of volleyball (serve from the bottom facing, receiving the serve from the bottom, and preparing from the top) for the first intermediate students, the researchers used the experimental method, and the research sample consisted of (32 A student with (16) students in each group, and by lottery two groups were named to represent one of them the experimental group and the other the control group, and parity was achieved between the two groups in the variables (age, weight, and height) in addition to achieving parity between them in basic skills (under study), And the overlapping waves strategy was used with the experimental group players, but with the control group, the method was used by the trainer, and the implementation of the experiment took nine weeks with two educational units per week for each group of 18 educational units, and the time for one educational unit was (45) minutes, and the experiment started on 10/2/2018 until 1/15/2019.

The researchers used the following statistical method: the mean, standard deviation, simple correlation coefficient (Pearson), (t) test for two related means and two equal samples, and (t) test for two unrelated means and two equal samples. And after analyzing the data statistically, the researchers reached conclusions, the most important of which are:

1. The use of the overlapping waves strategy had a clear role in learning some basic skills (under study) for the experimental group players.
2. Take advantage of the overlapping waves strategy in physical education lessons for all school levels.

**Keywords:** *Interfering waves, activity of players; role of education; brain enhancement; strategy and skills.*

## Introduction

Physical education is considered a science like the rest of the sciences. It uses the latest scientific method and method developed by scientists and researchers in a manner consistent with the nature of all society and its circumstances. This is what has contributed to the

upgrading and development of physical education from scientific and educational institutions to the community. Sports activities are also an important means to achieve educational goals. This is because the academic subject is not a self-directed goal to be achieved. Rather, these activities have become means that the teacher can invest to reach through them to achieve the goals set according to the concept of modern education.<sup>1</sup>

It also aims to prepare students to reach their simple abilities to the highest possible level, and to work on their numbers and make them successful academics, and in order to achieve these goals it is necessary to deliver the teaching curriculum vocabulary to the learner according to scientific foundations and strategies commensurate

---

### Corresponding Author:

**Aujeed Madlool Abbas**

Lect., Al-Qasim Green University/College of Physical Education and Sports Sciences/Iraq

e-mail: dr.aujeedmadlool@sport.uoqasim.edu.iq

with their abilities, including the interlocking waves strategy, which is one of the teaching strategies that It works to provide and guide students when studying a specific problem and to reach appropriate solutions in an organized manner that contributes to saving time and effort by the teacher, especially in difficult situations or aspects that require accuracy in their implementation.<sup>2</sup>

As none of the skills are more important than others, as they are the movements that the learner should implement, according to the circumstances required by the volleyball game, in order to reach positive results, economy, effort and delay in the state of fatigue. Through the foregoing, the importance of researching the variables that it studies is the strategy of overlapping waves and its role in developing social, psychological, skill and physical skills, which is a fundamental factor in achieving mental health, as well as its importance in learning basic skills in volleyball, to be an effective means for teachers to benefit from And, as well as the importance of the research sample, which is represented by middle first-grade students who represent future teachers, also the importance is embodied in preparing educational units according to the strategy of overlapping waves to depend on what the learner has of information or previous perceptions about the skill (to be learned) and employing it in the learning process for the new skill And according to his own capabilities and abilities, and it is done through educational units and in the form of cooperating groups, each of which has multiple duties and tasks, which provides a great opportunity in learning.<sup>3</sup>

The common strategy in learning basic skills in the game of volleyball is the strategy that follows the American approach that makes the teacher a decision-maker, imposing it on students not to exploit this strategy and diminish its advantages, but our current era is an era of cognitive prosperity and educational work, and this is what the researchers observed (Being a student, trainer, and teacher) while watching practical lectures of volleyball and personal interviews with some teachers of physical education and sports sciences, as teaching strategies must keep pace with this development, as working according to a strategy followed by the teacher determines the abilities and creative capabilities of the learner. Studies revealed that there are many teaching strategies, each of which has a special position in terms of goals and characteristics and has an effective role in learning basic skills as well as speeding up its learning. However, these strategies do not meet enough attention

from most of the workers in the field of teaching in physical education and sports science,<sup>4</sup> as the lack of Reliance on modern educational strategies represents the problem of research, so the researchers decided to use a strategy Interlacing waves by preparing educational units according to this strategy in learning some basic skills in volleyball.

#### **Research Objectives:**

1. Knowing the effect of using the interfering waves strategy in investing the time of the physical education lesson for first intermediate students.
2. Knowing the effect of using the interfering waves strategy in learning some basic volleyball skills for first intermediate grade students
3. Identify the effect of educational units according to the strategy of overlapping waves in learning some basic skills in volleyball for students (experimental group) in pre and posttests.
4. Identify the effect preference in the post-tests between the two groups (control and experimental).

#### **Research Hypotheses:**

1. There is a positive effect for educational units according to the strategy of overlapping waves in learning some basic skills of volleyball for first intermediate grade students.
2. There is a preference in influencing the strategy of overlapping waves (the experimental group) and the strategy followed (the control group) in learning some basic skills of volleyball for students of the first intermediate grade and in favor of the strategy of overlapping waves (the experimental group).

#### **Research Fields:**

- The human field: The first intermediate grade students are (13-14) years old in Al- Irfan Intermediate School for Boys.
- Time range: 10/2/2018 - 1/15/2019.
- Spatial field: the internal and external arena of the school.

### **Research Methodology**

The researchers used the experimental approach in the manner of equal groups, because it searches for the cause, and how it occurs, as it is defined as “what the researchers introduce from a variable in reality, and this is an intended change.”<sup>5</sup>

And because the experimental method “represents the most honest approach to solving many practical problems in a scientific and theoretical manner,”<sup>6</sup> So researchers used to reach the desired results.

**Research community and sample**

**Research community:** The research community is determined from two students, whose number is (52) students, and whose average age ranges between (13-14) years.

**The research sample:** The research sample was chosen deliberately from the original research community, and by drawing lots, and by (32) students,

representing 61.5% of the research community, as they were divided into two equal groups, and by (16) students per group, which is an appropriate percentage to represent a community Research is a real and honest representation.

The researchers excluded a number of sample individuals to achieve homogeneity, and the excluded ones are:

1. Exploratory experience personnel.
2. Older than (12-13) years.
3. Students are practicing the game.

**Table 1. Shows the research population, its selected sample, and the percentage**

Variables	N	Number of sample selected	Percentage
A sample pilot experiment	10	32Student	61.5%
The two students are the oldest year	5		
Students are practicing the game	5		

**The homogeneity of the sample and the equivalence of the two research groups**

**Homogeneity of the sample:** Before starting the implementation of the educational curriculum,

the researchers resorted to checking the homogeneity of the research sample in the variables related to the morphological measurements (height, weight, age), and as shown in Table (2).

**Table 2. Shows the homogeneity of the sample members in the variables (Age, Weight and Length)**

Variables	Mean	SD	Median	Skewness	N
Age (in months)	133.5	133	3.8	0.44	32
Weight (Kg)	41.3	41	4.5	0.32	
Length (Cm)	143.13	143	6.18	0.05	

**The two research groups are equivalent:** Before starting the implementation of the educational curriculum, the researchers resorted to checking the parity of the

two groups of research in the variables related to skill tests, which are the accuracy of performance of the skills under study, as shown in Table (3).

**Table 3. Shows the equivalence of the experimental and control groups in accuracy tests for the skills of preparation and reception of serve and serve from the bottom facing the volleyball**

Variables	Control group		Experimental group		(t) calculated*	Type of significance
	Mean	SD	Mean	SD		
Accuracy test preparation skill	2.05	0.43	2.06	0.37	1.09	No sig.
Test the accuracy of the serve reception skill	0.92	0.23	1.22	0.7	1.25	No sig.
Accuracy test of serve skill from below	1.57	0.53	1.40	0.35	1.05	No sig.

\*The tabular score = (2.14) at the level of significance (0.05) and the degree of freedom (30).



**Aids, devices and tools used in the research:**

- Arab and foreign sources.
- Personal interviews.
- Auxiliary work team
- Tests and measurements
- Weight measuring device.
- A length measuring tape.
- (2) electronic stopwatch.
- Volleyball balls, number (8).
- Volleyball court.
- Colorful adhesive tape.

**Tests used in the research:** The selection of tests is one of the important steps in scientific research in order to measure the variables related to the research. Selection “is a set of exercises given to the individual aiming to define his abilities, aptitudes, or sufficiency”.<sup>7</sup>

After the researchers, being a teacher, trainer, and player, were informed of most of the available resources related to his research, standardized tests were chosen to measure my skills (reception, serve from the bottom, preparation from the top, and serve from the bottom facing) with the volleyball of the age stage of the research sample. Because it suits the extent of validity and suitability for the age of the research sample.

**Field research procedures**

**Pre-tests:** The pre-tests were conducted for the research sample, after implementing two initial educational units, in which they included an explanation of the preparation skill through an explanation of the skill. Then the research sample applied this skill during the educational unit, and at the end of the unit, pre-tests for technical performance and accuracy of the preparation skill were conducted on Monday 10/10/2018.

**The educational curriculum:**

**As for the vocabulary of the educational curriculum, it was as follows:**

- The educational curriculum took (18) weeks divided into (3) weeks for the preparation skill, (3) weeks for the reception skill, (3) weeks for the serve skill from the bottom confrontation, and by two educational units per week, thus the total number of educational units for the preparation skill reached (6) Educational units for each skill, by two educational units per week, so the total number of educational curriculum units is (18) units for all skills.
- The teaching unit time (45) minutes.

**Post tests:** After completing (6) educational units in a period of (3) weeks to learn the skill of preparation, and with two educational units per week, the post tests were conducted for the two experimental groups, and under the same conditions that were in the pre-tests for this skill, and the post tests were conducted on Monday 5/11/2018.

**Results and Discussions**

**Table 4. Shows the mean of mean, standard deviations, and the two values of (t) calculated and tabular between the pre and posttests of the skills under investigation (the control group)**

Variables	Pretest		Posttest		(t) calculated	(t) tabulated	Type of significance
	Mean	SD	Mean	SD			
Transmitter from the bottom	17.93	2.18	25.2	3.26	4.76	2.13	Sig.
Preparation from above	9.6	2.64	19.13	2.31	3.04		Sig.
Receive the serve from the bottom	9.80	2.86	19.00	2.47	2.99		

**Table 5. Shows the mean of mean, standard deviations, and the two values of (t) calculated and tabular between the pre and posttests of the skills under investigation (experimental group)**

Variables	Pretest		Posttest		(t) calculated	(t) tabulated	Type of significance
	Mean	SD	Mean	SD			
Transmitter from the bottom	17	2.79	32.07	3.12	4.95	2.13	Sig.
Preparation from above	10.33	2.56	24.00	2.04	4.48		Sig.
Receive the serve from the bottom	10.26	2.54	24.47	2.82	3.36		

**Table 6. Shows the mean of mean, standard deviations, and two t-values calculated and tabular between the post tests of the skills under investigation (experimental and control group)**

Variables	Control group		Experimental group		(t) calculated	(t) tabulated	Type of significance
	Mean	SD	Mean	SD			
Transmitter from the bottom	25.2	3.26	32.07	3.12	2.69	2.04	Sig.
Preparation from above	19.13	2.31	24.00	2.04	2.82		Sig.
Receive the serve from the bottom	19.00	2.47	24.47	2.82	3.14		

The researchers attribute this development in the level of learning of the individuals of the research sample to the use of the strategy of overlapping waves, and this method has a different concept in the performance of the duty assigned to the learner, whereby it is to determine multiple levels of performance for the same assignment divided among all students in the manner of groups and stimulate competition between them and other groups as per His technical ability to perform, that is, at whatever level he begins to perform.<sup>9</sup>

The goal of the educational unit is to contain all students to perform the same duty to move in the process of dimensions to inclusion. Hence, the teacher’s tasks are clear as he is responsible for implementing the educational and training process through the use of the interlocking wave strategy, which achieves the desired purpose of the educational, educational and social concept first by containing all students and at the same time working to develop the skills performance of two students in addition to the effectiveness of the educational units using this method that contributed to the development Physical and skillful capabilities.<sup>10</sup> Through the foregoing, the development of some basic skills in volleyball cannot be achieved in the desired manner except through the use of various educational method in the process of learning and training that achieve the desired purpose.<sup>11</sup>

The researchers attribute this superiority in performance to the strategy that was used in the

application, as the researchers used the strategy of overlapping waves in education, since this strategy has advantages that can constitute a great addition in the learning and teaching process represented in transforming the educational material into multiple stages. The learner uses more than one sense in his learning, as well as investing the previous information in a way that serves and develops the learning process, and this increases the learning opportunities and the great ability to comprehend and comprehend and thus the possibility of applying the student to what he has learned to the fullest. “The best model for learning is to be through vision. Nevertheless, the stimulation and acceleration of learning will occur if the information is presented and processed by more than one sense”.<sup>12</sup>

### Conclusions

1. The strategy of overlapping waves used in the research has a positive effect, and the great and effective impact on the learning process and the development of some basic skills in volleyball.
2. Take advantage of the strategy of overlapping waves in physical education lessons for all academic levels of the proposed educational units, an active role in developing students ’level of learning some volleyball skills.
3. The interlocking wave strategy is the best in learning some basic skills in volleyball than the method used by the teacher with students and thus achieved the

goals and objectives that were set in order to achieve them.

4. The experimental group that learned according to the strategy of interfering waves was superior to the control group that used the strategy used in the post-test in learning some basic skills of volleyball for students.

**Ethical Clearance:** The Research Ethical Committee at scientific research by ethical approval of both MOH and MOHSER in Iraq.

**Conflict of Interest:** None

**Funding:** Self-funding

### References

1. HozamAlqizwini; Recreational Education: (Baghdad, Arab House for Printing, 1988).
2. Saad Eddin Abul Fotouh Al-Sharnoubi; Basic Concepts and Treatments in Statistics, 1st Edition: (Alla Alexandria, Al-Radaa Technical Press, 2001).
3. Farida Ibrahim: Kinetic education for kindergarten and elementary levels, 1st floor, Kuwait, Dar Al-Qalam, 1987.
4. Qasim Al-Mandalawi (and others); Tests, measurement and evaluation in physical education: (Mosul, Higher Education Press, 1990)
5. Muhammad Hassan Allawi. Osama Kamel Ratib: Scientific Research in Physical Education and Sports Psychology, Cairo, Arab Thought House, 1999
6. Muhammad Khalifa Barakat: Educational Psychology - Part 1 - Kuwait - Dar Al-Qalam for printing and publishing.
7. Mohamed SobhiHassanein; Measurement and Evaluation in Physical Education: (Cairo, Arab Thought House, 1995).
8. Mohammed Abdel-Halim; Descriptive and Inferential Statistics in Educational and Psychological Sciences: (Kuwait, Al-Falah Library, 1986).
9. Mahmoud Dawood Al-Rubaie and Saeed Saleh: Method and Method of Teaching Physical Education, 1st Edition, Baghdad, Dar Al-Kutub, Printing and Publishing House, 2011.
10. Mahmoud Dawood Al-Rubaie: Theories and Method of Physical Education, Baghdad, House of Books, Printing and Publishing, 2000.
11. Mostafa Soueif: An Introduction to Social Psychology, 2nd Edition, Cairo, Dar Al Maaref, 1960.
12. Mustafa Mohammed; Recent trends in teaching physical education and sports, 1st Edition: (Egypt, Al-Radaa Press, 2001).

# Diagnostic Study of Some Microbiological Dacryocystitis with in Baghdad City Patients

Zena K. Khalil<sup>1</sup>, Ala'a K. Husain<sup>2</sup>, Saif S. Al-Kamil<sup>3</sup>

<sup>1</sup>Assist. Prof., <sup>2</sup>Optometrist, <sup>3</sup>Biologist, Al-Mansur Medical Technical Institute/Middle Technical University/Iraq

## Abstract

The study was conducted from May -November 2019 among 114 dacryocystitis patients attending to ophthalmology department of Al-Yarmuk central hospital in Baghdad city. From of 114 patients with dacryocystitis, 90 (79%) patients had bacterial dacryocystitis, 24 (21%) with fungal dacryocystitis. According to the results 83(73%) recorded with chronic dacryocystitis and 31(27%) with acute dacryocystitis. The high percentage was bacterial dacryocystitis (32%), fungal dacryocystitis (38%) were at age of  $74\pm 0.3$  y and the low percentage of bacterial was (11%) at  $63\pm 0.5$  y and with fungal dacryocystitis (8%) at age of  $42\pm 0.3$ y. Patients with bacterial dacryocystitis had diabetes mellitus (56 %),arthritis and hypertension (28%,16 %) while the DM with fungal dacryocystitis (46%), arthritis, hypertension (38 %,16 %), *S.aureus* 23(26%), *S.epidermidis* 18 (20%),*Streptococcus spp.* 14 (16%), *Pseudomonas spp.* 11 (12%), *E. coli* 10 (11%), *Enterobacter spp* 9 (10%) finally *Proteus spp.* 5 (6%), while *Aspergillus flavus* represented 9 (37%) as causing fungal dacryocystitis, *Aspergillus fumigates* 7 (29%), *Aspergillus niger* 4 (17%)and *Candida spp* 4 (17%) . The antibiotic susceptibility tests revealed that *S. aureus* isolates were sensitive to Chloramphenicol (83%),. *S.epidermidis* isolates showed sensitivity to Gentamycin and Tetracycline (88%), *Streptococcus spp* showed the susceptibility to Erythromycin (93%), Ciprofloxacin (86%) respectively,*Pseudomonas spp* isolates considered highly sensitive to Tetracycline and Chloramphenicol (91%), *E.coli* isolates were also susceptible to Chloramphenicol (90%), *Enterobacter spp* were sensitive to Tetracycline and Gentamicin (78%),*Proteus spp* isolates seems sensitive to Chloramphenicol and Tetracycline (100%), *Aspergillus spp.* and *Candida spp.* isolates remain sensitive to Itraconazole, Voriconazole .

**Keywords:** Dacryocystitis, bacterial and fungal infuctions, antibiotic susceptibility tests, Baghdad.

## Introduction

Dacryocystitis refers to lacrimal sac inflammation, which can be due to obstruction or blockage of normal tears drainage which leads to anathoe secondary infection and this is related to structural abnormality or eye disorders, and traumatic injury<sup>[1]</sup> . In acutetype of dacryocystitis which is basically caused by nasolacrimal duct abscess and maybe sometimes it is accompanied by dissemination of another infection as orbital cellulitis or thrombosis of the superior ophthalmic vein, and

sometimes cavernous sinus, the patient presents with pain, redness, and edema around the lacrimal sac<sup>[2]</sup>. Diagnosis is depended on symptoms and signs and when pressure over the lacrimal sac causes reflux of mucoid material through the puncta. while the chronic form is associated with a mass under the medial canthal tendon and chronic conjunctivitis with epiphora. polymicrobial dacryocytitis were common and concurrently isolated from bacterial, fungal, and viral origin<sup>[3,4]</sup>. In general gram-positive bacteria were most common which were followed by gram-negative bacteria of both anaerobic and aerobic origin. most reports showed that fungal pathogens like *Fusarium spp.*, *Aspergillus spp.* and *Candida albicans* were the predominant ones isolated in dacryocystitis patients with other bacterial pathogens<sup>[5,6]</sup>. It is important to mention that the clinical results, broad-spectrum antibiotic therapy till now are not effective to be as a diagnostic tool or a therapeutic

---

### Corresponding Author:

**Zena K. Khalil**

Assist. Prof., Al-Mansur Medical Technical Institute/  
Middle Technical University/Iraq

e-mail: zenakasse2009@gmail.com

strategy. so, in each geographic area, total information about nearly the most microorganisms which responsible for dacryocystitis is very necessary, as well as, the pattern of antibiotic susceptibility<sup>[7]</sup>.

The study was done to identify the microbial etiology and of dacryocystitis and investigate the patterns of antibiotic susceptibility among adult patients in Baghdad city.

### Patients and Method

The study was conducted from May -November 2019 among 114 dacryocystitis diagnosed patients attending to ophthalmology department of Al-Yarmuk teaching hospital in Baghdad city. the information documented directly from the patients. data were collected using a structured and pre-tested questionnaire. Patients were examined by an ophthalmologist and specimens were collected from those patients presented dacryocystitis in their nasolacrimal discharge under sterile conditions. Specimens were collected with a sterile cotton swabs and inoculated on blood agar, MacConkey agar, Chocolate agar (Oxoid, Hampshire, UK) and Sabouraud agar (Biolife/Italy). when incubation time is over, biochemical reaction tests then done to confirm the species, API system was used (bio Merieux).<sup>[8]</sup> For examination of hyphae and spore morphological microscopically, lacto phenol-stain was used<sup>[9]</sup>.

**Antibiotic Susceptibility:** Antimicrobial susceptibility testing was performed following the disk diffusion technique according to the Clinical and Laboratory Standards Institute (CLSI),<sup>[10]</sup>. The following antibiotic disks were used; “Erythromycin (15 µg), Clarithromycin (15 µg), Chloramphenicol (30 µg), Clindamycin (2 µg), Tetracycline, (30 µg), Doxycycline (30 µg), Amikacin (30 µg), Gentamicin

(10 µg), Ciprofloxacin (5 µg), Ceftriaxone (30 µg) supplied by (Oxoid, Hampshire, UK)”. Strains of “*Staphylococcus* (ATCC 25923), *E. coli* (ATCC 25922) and *Pseudomonas aeruginosa* ATCC 27853” were used as controls. CLSI M38-A2 BMD method for antifungal drugs susceptibility<sup>[11]</sup>. The following antifungal agents:

“Voriconazole (1 µg), fluconazole (25 µg), itraconazole (10 µg), ketoconazole (50 µg) metronidazole (50 µg), and amphotericin B (20 µg)”. *Candida krusei* ATCC 6258 used as a control, the results of susceptibility were recorded as sensitive, intermediate and resistant.<sup>[12]</sup>

**Statistical Analysis:** Chi-square test and t-test used to analyze the findings as (P value <0.05) used to find the significance of difference<sup>[13]</sup>.

### Results

From 114 patients with dacryocystitis, there were 90 (79%) patients of bacterial dacryocystitis and 24 (21%) with fungal dacryocystitis. Men with bacterial dacryocystitis were 52 (58%) and women 38 (42%), men diagnosed with fungal dacryocystitis were 17 (71%) and women 7 (29%). According to the results 83 (73%) recorded with chronic dacryocystitis and 31 (27%) with acute dacryocystitis.

Patients with bacterial dacryocystitis (32%), fungal dacryocystitis (38%) were at the mean age of 74±0.3 y, lowest ratio with bacterial was (11%) at 63±0.5 y and with fungal dacryocystitis (8%) at age of 42±0.3y, the significant differences recorded between groups, table 1.

Most bacterial dacryocystitis patients were having DM (56%) and the others having arthritis or hypertension (28%, 16%) while the DM with fungal dacryocystitis represented (46%) then arthritis or hypertension (38%, 16%).

**Table 1: Bacterial and fungal dacryocystitis related to the age groups**

Age-years	Mean of ±SD	N. of patients, bacterial dacryocystitis %	N. of patients, Fungal dacryocystitis %
15-25	20±0.5	21(23%)	6(25%)
26-36	31±0.7	13(14%)	2(8%)
37-47	42±0.3	18(20%)	2(8%)
58-68	63±0.5	10(11%)	5(21%)
69-79	74±0.3	28(32%)	9(38%)

p value (< .05)

*S.aureus* seemed as the most common cause of bacterial dacryocystitis 23(26%), secondly *S.epidermidis* 18(20%), *Streptococcus spp.* 14(16%), *Pseudomonas spp.* 11 (12%), *Escherichia coli* 10(11%), *Enterobacter spp* 9(10%) and *Proteus spp.* 5(6%),

and while *Aspergillusflavus* represented 9(37%), *Aspergillusfumigates* 7(29%), *Aspergillus niger* 4 (17%) and *Candida spp* 4(17%) were the main causative agents of fungal dacryocystiti as in table 2.

**Table 2: Types of bacterial and fungal isolates from patients**

Type of bacterial strain	Number %	Type of fungal strain	Number %
S.aureus	23(26%)	Aspergillus flavus	9(37%)
S.epidermidis	18(20%)	Aspergillus fumigatus	7(29%)
Streptococcus	14(16%)	Aspergillus niger	4(17%)
Pseudomonas	11(12%)	Candida	4(17%)
Escherichia coli	10(11%)		
Enterobacter spp	9(10%)		
Proteus spp	5(6%)		
<b>Total</b>	<b>90(100%)</b>	<b>Total</b>	<b>24(100%)</b>

The resent results revealed the susceptibility of *S. aureus* isolates to Chloramphenicol (83%) followed by Amikacin and Gentamycin (78%), *S.epidermidis* isolates showed high susceptibility to Gentamycin and

Tetracycline (88%) then Erythromycin and Amikacin (83%),*Streptococcus spp* showed the susceptibility to Erythromycin (93%), Ciprofloxacin (86%), table 3.

**Table 3: Susceptibility patterns of *S.aureus*, *S.epidermidis* and *Streptococcus spp* isolates.**

Antibiotics	<i>S.aureus</i> n = 23			<i>S.epidermidis</i> n = 18			<i>Streptococcus spp</i> n = 14		
	S	I	R	S	I	R	S	I	R
Chloramphenicol	19(83%)	1(4%)	3(13%)	15(83%)	1(6%)	2(11%)	11(79%)	2(14%)	1(7%)
Gentamycin	18(78%)	2(9%)	3(13%)	16(88%)	1(6%)	1(6%)	-	-	-
Tetracycline	17(74%)	2(9%)	4(17%)	16(88%)	1(6%)	1(6%)	11(79%)	1(7%)	2(14%)
Erythromycin	16(69%)	2(9%)	5(22%)	15(83%)	1(6%)	2(11%)	13(93%)	-	1(7%)
Amikacin	18(78%)	-	5(22%)	15(83%)	1(6%)	2(11%)	-	-	-
Doxycycline	16(69%)	2(9%)	5(22%)	11(61%)	2(11%)	5(28%)	-	-	-
Ciprofloxacin	-	-	-	-	-	-	12(86%)	1(7%)	1(7%)
Ceftriaxone	-	-	-	-	-	-	10(71%)	1(7%)	3(22%)

*Pseudomonas spp* isolates were high susceptible to Tetracycline and Chloramphenicol (91%), Ciprofloxacin (82%) and Amikacin and Gentamycin (73%) each of them, *E.coli* isolates reported susceptible for Cloramphenicol (90%), Ciprofloxacin (80%) but they were resistant to Amikacin and Tetracycline (80%,90%).

*Enterobacter spp* remained susceptible to each of Tetracycline and Gentamicin (78%), Amikacin (67%), *Proteus spp* confirmed susceptible to Cloramphenicol and Tetracycline (100%), Ciprofloxacin and Ceftriaxone (80%), table 4.

**Table 4: Susceptibility of *Pseudomonas spp*, *Escherichia coli* and *Enterobacter spp*.**

Antibiotic	<i>Pseudomonas spp.</i> n = 11			<i>Escherichia coli</i> n = 10			<i>Enterobacter spp</i> n = 9			<i>Proteus spp</i> n = 5		
	S	I	R	S	I	R	S	I	R	S	I	R
Chloramphenicol	10(91%)	1(9%)	-	9(90%)	1(10%)	-	5(56%)	2(22%)	2(22%)	5(100%)	-	-
Amikacin	8(73%)	1(9%)	2(18%)	1(10%)	1(10%)	8(80%)	6(67%)	2(22%)	1(11%)			
Tetracycline	10(91%)	1(9%)	-	-	1(10%)	9(90%)	7(78%)	1(11%)	1(11%)	5(100%)	-	-
Doxycycline	7(64%)	2(18%)	2(18%)	6(60%)	2(20%)	2(20%)	5(56%)	3(33%)	1(11%)			
Ciprofloxacin	9(82%)	1(9%)	1(9%)	8(80%)	2(20%)	-	5(56%)	2(22%)	2(22%)	4(80%)	1(20%)	-
Gentamycin	8(73%)	1(9%)	2(18%)	6(60%)	1(10%)	3(30%)	7(78%)	1(11%)	1(11%)	2(40%)	1(20%)	2(40%)
Ceftriaxone										4(80%)	1(20%)	-

(90%) *Aspergillus spp* when tested to Itraconazole, Voriconazole, Amphotericin B and Natamycin, they considered sensitive at (80%,70%,60%), *Candida spp*.

confirmed high sensitive to Itraconazole (100%) and (75%) to the rest of antifungal types used in the study, table 5 .

**Table 5: Susceptibility of “*Aspergillus spp* and *Candida spp*”.**

Drug	<i>Aspergillus spp</i> n = 20			<i>Candida spp</i> n = 4		
	S	I	R	S	I	R
Amphotericin B	14(70%)	3(15%)	3(15%)	3(75%)	1(25%)	-
Natamycin	12(60%)	3(15%)	5(25%)	3(75%)	1(25%)	-
Itraconazole	18(90%)	1(5%)	1(5%)	4(100%)	-	-
Voriconazole	16(80%)	2(10%)	2(10%)	3(75%)	1(25%)	-

## Discussion

The study revealed that patients with bacterial dacryosistitis were (79%) and (21%) were having fungal dacryocystitis, men represented the highest levels (58%), (71%) respectively, the highest ratio of males related to microbial dacryocystitis as a compression to females has been recorded in some other studies<sup>[14,15]</sup>. Acute and chronic dacryocystitis forms were found in the study, but (73%) were chronic, as a same as found in many previous studies that explained the role of chronic structural disorders of the tears drainage<sup>[16]</sup>. Patients with microbial dacryosistitis at mean age of 74±0.3 were high and started to decrease, these finding are disagreed to other study in Baghdad, this may related to selecting of the known causes of infection<sup>[17]</sup>. Bacterial dacryosistitis patients, recorded with DM were (56%) and the rest patients recorded with arthritis and increase of blood pressure (28%,16%) while the diabetic with fungal dacryosistitis were (46%), arthritis then hypertension (38%,16%), these findings disagreed with other studies depending on the age and some other

chronic disease may be due to health style including food as well as environmental changes<sup>[18,19]</sup>. *S.aureus*, the common cause of dacryosistitis 23(26%), *S.epidermidis* 18 (20%) in the second degree then *Streptococcus spp.* 14(16%), *Pseudomonas spp.* 11 (12%), *Escherichia coli* 10 (11%), *Enterobacter spp* 9(10%) and *Proteus spp.* 5(6%), the main causes of keratitis were *Aspergillus flavus* 9(37%), *Aspergillusfumigates* 7(29%), *Aspergillus niger* 4 (17%),*Candida spp* 4(17%), the results agreed to other studies in Baghdad<sup>[20,21]</sup>. Other study mentioned that *Pseudomonas spp.* represented most of bacterial isolates, as well as, *Staphylococcus spp.* while the fungal causes detected in 15 cases.<sup>[22]</sup> these result scan be changed depending on the climatic disturbance conditions or socioeconomic parameters<sup>[23]</sup>. G+ and G- bacterial isolates were almost susceptible to the antibiotics in the study and these findings were similar to different other studies<sup>[24,25]</sup> fungal isolates appeared its high susceptibility to the common antifungal drugs, *Aspergillus spp*, were clearly had asensitive reactions to Itraconazole, Voriconazole. *Candida* recorded sensitive

when tested, these seems to have a great match with some results done<sup>[26]</sup>.

## Conclusions

Among dacryocystitis patients, *S. aureus* came in the highest ratio of g+ bacterial isolates, *S. epidermidis* secondly while *g-Pseudomonas spp* looked very dominant. *Aspergillus spp* was the highest among the fungus then *Candida spp*. All of gram + and gram -, as well as the fungus seems highly susceptible for the different antibiotics discs, so, we recommend the importance of antimicrobial susceptibility testing which must be done as a routine clinical, diagnostic practices method to manage the resistance patterns of microbial infections a long time hoping to complete the treatment strategies supporting and continuous personal educations to control the improper self-medication.

**Ethical Clearance:** The Research Ethical Committee at scientific research by ethical approval of both MOH and MOHSER in Iraq

**Conflict of Interest:** None

**Funding:** Self-funding

## References

1. Harish V, Benger RS. Origins of lacrimal surgery, and evolution of dacryocystorhinostomy to the present. *Clinical and Experimental Ophthalmology* 2014; 42: 284–287. [DOI: 10.1111/ceo.12161]
2. Wladis E.J., Shinder R., LeFebvre D., Sokol J., Boyce M. Clinical and microbiologic features of dacryocystitis-related orbital cellulitis. *Orbit* 2016; 35(5):258–261. [DOI: 10.1080/01676830.2016]
3. Goel R, Nagpal S, Kumar S, et al. Transcanalicular laser-assisted dacryocystorhinostomy with endonasal augmentation in primary nasolacrimal duct obstruction: our experience. *Ophthal Plast Reconstr Surg* 2017; 33:408–12. [DOI: 10.1097/IOP.0000000000000802]
4. Raposo A, Piqueras F, García-Purriños F, et al. Influence of septal deviation on the prognosis of transcanalicular diode laser-assisted dacryocystorhinostomy. *J Ophthalmol.* 2016; 2016:9573760 [DOI: 10.1155/2016/9573760]
5. Li EY, Wong ES, Wong AC, Yuen HK. Primary vs Secondary Endoscopic Dacryocystorhinostomy for Acute Dacryocystitis With Lacrimal Sac Abscess Formation: A Randomized Clinical Trial. *JAMA Ophthalmol.* 2017;135(12):1361-1366. [DOI: 10.1001/jamaophthalmol.2017.4798]
6. Pornpanich K, Luemsamran P, Leelaporn A, et al. Microbiology of primary acquired nasolacrimal duct obstruction: simple epiphora, acute dacryocystitis, and chronic dacryocystitis. *Clin Ophthalmol* 2016; 10:337–342. [DOI: 10.2147/OPHTH.S100280]
7. Feijó ED, Caixeta JA, de Souza Nery AC, et al. A comparative study of modified transcanalicular diode laser dacryocystorhinostomy versus conventional transcanalicular diode laser dacryocystorhinostomy. *Eur Arch Otorhinolaryngol* 2017; 274:3129–3134. [DOI:10.2147/OPHTH.S100280]
8. Pandya VB, Lee S, Benger R, et al. External dacryocystorhinostomy: assessing factors that influence outcome. *Orbit* 2010; 29(5):291-297. [DOI:10.3109/01676830.2010.485715]
9. Feng YF, Cai JQ, Zhang JY, Han XH. A meta-analysis of primary dacryocystorhinostomy with and without silicone intubation. *Can J Ophthalmol* 2011; 46(6):521-527. [DOI:10.1016/j.jcjo.2011.09.008]
10. Ozsutcu M, Balci O, Tanriverdi C, Demirci G. Efficacy of adjunctive mitomycin C in transcanalicular diode laser dacryocystorhinostomy. *Eur Arch Otorhinolaryngol* 2017; 274:873–877. [DOI: 10.1007/s00405-016-4308-7]
11. Prakash R, Babu RG. A Bacteriological Study of Dacryocystitis. *J Clin Diagn Res.* 2012;6(4):652–655.
12. Eshraghi B, Abdi P. Microbiologic spectrum of acute and chronic dacryocystitis. *Int J Ophthalmol.* 2014;7(5):864–867.
13. Assefa Y, Moges F, Endris M, Zereay B, Amare B, Bekele D. Bacteriological profile and drug susceptibility patterns in dacryocystitis patients attending Gondar University Teaching Hospital. *BMC Ophthalmol.* 2015;15(1).
14. Chaudhary M, Bhattarai A, Adhikari S, Bhatta D. Bacteriology and antimicrobial susceptibility of adult chronic dacryocystitis. *N J Oph.* 2010; 2(4):105–113.
15. Madhusudhan MY, Ismail N, Hussein A. Microbiological aetiology of acute dacryocystitis in hospital Universiti Sains Malaysia, Kelantan Malaysia. *J Acute Dis.* 2012;1(1):31–34.
16. Sarkar I, Choudhury S, Bandyopadhyay M.



- A Clinicobacteriological Profile of Chronic Dacryocystitis in Rural India. *Int J Health Sci Res.* 2015;5(7):82–87
17. Chen L, Fu T, Gu H, Jie Y, Sun Z, Jiang D et al. Trends in dacryocystitis in China: a STROBE-compliant article. *Medicine (Baltimore)* .2018; 97(26):e11318
  18. Das JK, Deka AC. Bacteriology of chronic dacryocystitis .*India J Clin Diagn Res.* 2014;(24) 322-345.
  19. Amin RM, Hussein FA, Idriss HF, Hanafy NF, Abdallah DM. Pathological, immunohistochemical and microbiological analysis of lacrimal sac biopsies in patients with chronic dacryocystitis. *Int J Ophthalmol.* 2013;6(6):817–826. [PMC free article] [PubMed] [Google Scholar]
  20. Kebede A, Adamu Y, Bejiga A . Bacteriological study of dacryocystitis among patients attending in Menelik II Hospital, Addis Ababa, Ethiopia. *Ethiop Med J.*2010; 48(1):29–339.
  21. Mandal R, Banerjee AR, Biswas MC, Mondal A, Kundu PK, Sasmal NK . Clinicobacteriological study of chronic dacryocystitis in adults. *J Indian Med Assoc.* 2018; 106(5):296–298.
  22. Mills DM, Bodman MG, Meyer DR, Morton AD. The microbiologic spectrum of dacryocystitis: a national study of acute versus chronic infection. *Ophthal Plast Reconstr Surg* .2017;23(4):302–306.
  23. Shahraki K, Makateb A, Shirzadi K, Khosravifard K. Frequency of bacterial samples from patients with chronic acquired nasolacrimal duct obstruction. *Med Arch.* 2016; 70(6):433–436.
  24. Sun X, Liang Q, Luo S, Wang Z, Li R, Jin X . Microbiological analysis of chronic dacryocystitis. *Ophthalmic Physiol Opt.* 2015; 25(3):261–263.
  25. Wayne, PA: Performance standards for antimicrobial susceptibility testing. 2017; 27th ed. clinical laboratory standard institute supplement M100.
  26. Zeng B, Wang P, Xu LJ, Li XY, Zhang H et al. Amniotic membrane covering promotes healing of cornea epithelium and improves visual acuity after debridement for fungal keratitis. *Int. J. Ophthalmol.* 2014;7:785-9.

# The Effect of the Physical and Artistic Education Lesson Through Play and Art in Developing Some Motor Abilities and Reducing Mobility for Pupils in the Fifth Grade of Primary School of the Primary Stage

Aujeed Madlool Abbas<sup>1</sup>, Nawfal Shamkhi Naji<sup>2</sup>, Haider Sami Muhammad<sup>3</sup>, Jabbar Ali Kathim<sup>4</sup>

<sup>1</sup>Lect., <sup>2</sup>B.Sc. Researcher, <sup>3</sup>Assist. Lect., <sup>4</sup>Assist. Prof., Al-Qasim Green University/College of Physical Education and Sports Sciences/Iraq

## Abstract

The research objectives to reveal the effect of the physical and artistic education lesson during play and art to develop some motor abilities and reduce hyperkinetic among fifth grade pupils. The researchers used the experimental approach, and the research sample consisted of (66) students and (10) students in each group, and about By drawing lots, two groups were named to represent one of them the experimental group and the other the control group, and parity was achieved between the two groups in the variables (age, weight, and height) as well as achieving parity between them in terms of motor abilities (under study) and their hypermobility, and playing and practicing technical drawings with Pupils of the experimental group As for the control group, the method used by the teacher was used, and the implementation of the experiment took nine weeks with two educational units per week for each group of 18 educational units, and the time of one educational unit reached (45) minutes, and the implementation of the experiment was started. On Sunday, 10/2/2018, until Thursday, January 14, 2019.

**After analyzing the data statistically, the researchers reached the following two conclusions:**

1. Learning by playing and art during the physical and artistic education lesson had a clear role in developing some of the experimental group's motor abilities.
2. The learning style by playing and art collectively led to the reduction of hyperactivity and distraction, and the formation of good relationships between them.

**Keywords:** *Physical, artistic, health; brain development; primary schools; and motor abilities.*

## Introduction

The primary stage is one of the important developmental inputs in the development of human resources. When the child enrolls in middle school, his primary concerns are learning and developing some motor, physical and skill abilities.

As the primary stage is an important stage of a person's life, it is the stage of basic learning, and it requires dealing with it by physical processes and not with abstract matter. Learning goes through a stage of development imposed by the nature of the age and depends on the useful function of what we learn in the sense that we transform the facts of science into practical practices and not be satisfied with practices Based on memorization, indoctrination, or the use of some pictures, and in order to reach the child during the educational process to such advanced stages of mental, motor and scientific development, it is necessary to use interesting educational method that stimulate their preferences and desires and encourage them to learn

---

### Corresponding Author:

**Dr. Aujeed Madlool Abbas**

Lect., Al-Qasim Green University/College of Physical Education and Sports Sciences/Iraq

e-mail: dr.aujeedmadlool@sport.uoqasim.edu.iq

and their learning style through play and art. Primary school pupils need to have a good and sound mental, psychological and physical development,<sup>1</sup> and this need is related to satisfying other needs, as the child's mobility, psychological, social and intellectual capacity does not grow, and his scientific knowledge and experiences do not increase unless his motor development is sound through playing and drawing in the physical and artistic education lesson.<sup>2</sup>

And because the style of learning by playing and art through my studies of sports and art depends mainly on the ability to creativity and show technical and sports skills, because they are a lesson in which the students feel happiness, freedom of movement and expressing their happiness through drawing in colors, installing manual artworks, discharging excess energy and reducing aggressive behavior. The style of learning by playing and art is one of the important method that it is preferable to use with this age group, especially if this method is combined or combined with the development of motor abilities and the reduction of their hyperkinetic, especially since the learning process through some games and the participation of students with collective artistic work that gives the lesson a kind of Excitement and excitement, and thus learning becomes more acceptable while ensuring the active participation of all children, and from here came the importance of research through the use of learning by playing and art through my studies of physical and technical education, and thus linking with the development of motor abilities and reducing their hyperkinetic that students need at this age.<sup>3</sup>

Through the researchers following up on the behavior of children in some school as they are teachers of technical and sports education, they found a clear weakness in the performance of motor abilities, excessive random behavior, and aggressive and chaotic behavior in a group of them as a result of their distinctive movement behavior with excessive activity and many movements, and this is called excessive movement activity, which is a behavioral state.<sup>4</sup>

#### **Research Objectives:**

1. Recognizing the effect of learning by playing and art on reducing hyperactivity among fifth grade primary students.
2. Recognizing the effect of learning by playing and art on developing motor abilities among fifth grade students

#### **Research Hypotheses:**

1. There is an effect of learning by playing, learning by playing and art, in reducing hyperkinetic among fifth-grade students.
2. There are significant differences between the pre and posttests in favor of the post tests for the two research groups.

#### **Research Fields:**

- The human field: Fifth grade pupils of primary school in Babil Governorate/Abi Tamam Primary School for Boys.
- Time range: for the period from 10/2/2018 to 1/15/2019
- Spatial field: the courtyards and halls of Abi Tammam Primary School, Al-Hashemiya District/ Babel Governorate.

#### **Research methodology and field procedures:**

##### **Research Methodology:**

The process of researchers' selection of the methodology used in their research, which must suit the nature of the problem to be studied, is of great importance in reaching a solution to that problem.

##### **Research community and sample**

**Research Community:** Determining the research community is one of the important steps and stages in the process of conducting the research.<sup>5</sup> Researchers can deal with the entire community with the research if this community falls within the limits of its capabilities and capabilities.<sup>6</sup> The research community is defined as "all of the individuals, events, or things who are the subject of the research problem"<sup>7</sup> The research community included primary school pupils (fifth grade primary) of (11-12) years of age from boys only, their number reached (66) students, and in the Abi Tamam Primary School in the Hashemite District Center, Babil Governorate.

**Research Samples:** As it is known that the sample is that part of the society that the researchers want to conduct its study on, "it must be representative of all the vocabulary of that community and that this representation is supposed to be honest"<sup>8</sup>.

**Accordingly, the research samples were divided into:**

**The first exploratory sample:** It is the sample through which the level of understanding of the sample members and their comprehension of the paragraphs of the hyperkinetic scale was identified, as well as ensuring the possibility of carrying out the tests for the most important motor abilities, and this sample consisted of (25) students.

**The second exploratory sample:** It is the sample through which it was ascertained that the curriculum prepared by the researchers could be implemented. This sample consisted of (15) students.

**Application sample (experimental group and control group):** The researchers selected members of the application sample from Abi Tammam Primary School, and this sample consisted of two divisions of the fifth grade of primary school, as all students of these two classes did not participate in the main experiment to prepare the scale, as well as in the exploratory experiment of the curriculum prepared by the researchers, and it was excluded The students who failed and selected pupils at

the age of (11-12) years, and the students who could not participate in the lesson for medical reasons and because of their ages older than (12) years and their number (6) were excluded, as the total sample amounted to (20) students and by (10) students From each division, then after drawing a lot between them, one of the people was chosen to be an experimental group and the other a control group.

**Table 1. Shows the homogeneity of the sample in the variables of age, height and weight**

Variables	Units	Mean	Median	SD	Skewness
Age	Month	124.5	124	3.61	0.42
Length	Cm	139.05	139	4.22	0.04
Weight	Kg	36.057	36	5.71	0.03

It can be seen from Table (2) that the value of the skewness coefficient ranges between (0.03) to (0.42) and it is confined to ( $\pm 1$ ). This means that the sample is normally distributed, indicating its homogeneity.

**Table 2. Shows the equivalence of the control and experimental groups in the pre-tests for the research variables**

Variables	Experimental group		Control group		(t) value	Statistical significance
	Mean	SD	Mean	SD		
Moving balance	8.34	1.522	8.6	1.3	0.48	No sig.
Agility	23.9	0.96	21.6	1.08	0.78	No sig.
Compatibility	15.49	1.23	15.6	1.09	0.34	No sig.
Hyperkinetic	34.75	6.32	35.25	6.34	0.14	No sig.

**Determine the tests:** The selection and determination of tests is not an easy process, as the test must be based on accurate scientific foundations in order to achieve the purpose for which it was established, as the test is “an important means of measurement and it is a tactic of measurement”.<sup>9</sup> After the researchers looked at a number of scientific sources, letters, dissertations and available scientific research related to the study of the research and as a teacher and trainer in the field of sports, a number of tests for football skills were collected, after which some tests were chosen on the experimental and control group.

**Research procedures on sample application**

**Pre-tests:** Pre-tests were conducted to measure the kinetic satisfaction of the experimental group of (10)

students on Wednesday, 10/12/2018 at nine o'clock in the morning at the yard of the Abi Tammam Primary School in the Abi Tamam Primary School, and pre-tests were also conducted to measure the hyperkinetic of the control group of its number. (10) Students on Thursday 10/13/2018 at ten in the morning in one of the classrooms at Abi Tamam Primary School.

**The main experience:** The main experiment was started on Sunday 10/16/2018 until Sunday 10/1/2019, when the two educational approaches were applied according to the different educational method for each curriculum and the same capabilities under consideration, and the two groups were performing their work as follows:

**Post tests:** After completing the main experiment, and for the purpose of determining the level reached by the research sample with its two groups (experimental and control) in motor satisfaction and the basic skills under investigation, and to determine the extent to which the two groups have benefited from the application of (play, art, and the method used), post-tests of the two groups

were conducted for a period of 13/1/2019 to 1/14/2019, and the researchers made sure that the conditions are similar to the pre-tests in terms of location, time, and the presence of the assistant work team. The same steps were used in the pre-test in the method of measuring the achievement of students in each test.

### Results and Discussions

**Table 3. Shows the average of means, standard deviations, and two t-values calculated and tabular between the pre and post tests for the skills under investigation (experimental group)**

Variables	Pretest		Posttest		(t) calculated	(t) tabulated	Indication of differences
	Mean	SD	Mean	SD			
Moving balance	8.34	1.522	5.91	0.90	3.32	2.26	Sig.
Agility	23.9	0.96	19.23	0.91	6.72		Sig.
Compatibility	15.49	1.23	10.75	1.36	8.12		
Hyperkinetic	34.75	6.32	25.13	3.18	5.95		

**Table 4. Shows the average of the mean, standard deviations, and two t-values calculated and tabular between the pre and posttests of the skills under investigation (the control group)**

Variables	Pretest		Posttest		(t) calculated	(t) tabulated	Indication of differences
	Mean	SD	Mean	SD			
Moving balance	8.6	1.3	6.9	1.3	2.5	2.26	Sig.
Agility	21.6	1.08	19.7	1.7	3.01		Sig.
Compatibility	15.6	1.09	12.3	1.2	6.4		
Hyperkinetic	35.25	6.34	32.88	5.94	1.78		

**Table 5. Shows the average of means, standard deviations, and two t-values calculated and tabular between the post tests of the skills under investigation (experimental and control group)**

Variables	Control group		Experimental group		(t) calculated	(t) tabulated	Indication of differences
	Mean	SD	Mean	SD			
Moving balance	6.9	1.3	5.91	0.90	2.24	2.13	Sig.
Agility	6.9	1.3	19.23	0.91	6.72		Sig.
Compatibility	19.7	1.7	10.75	1.36	2.72		
Hyperkinetic	12.3	1.2	25.13	3.18	3.05		

The experimental group in improving performance and motor abilities, the researcher attributes it to the effect of the method applied by the pupils of the experimental group, and the various physical, movement and artistic small games it contained through drawing and handicrafts that contributed to improving the physical, motor, mental, mental and social abilities through the

collective participation of the pupils. Suitable for their abilities and capabilities, and I took into consideration the peculiarity of this age stage, as (Kurt Maynell, 1987) indicates that this age stage is the best stage for motor learning, especially the ability to act in terms of motor activity and purposeful motor control, as the locomotors transport improves and becomes good especially for

the use of the trunk. And large kinematic fluidity. As the physical and artistic education lesson focused on games and artistic participations that suit their motor, artistic, mental and physical abilities,<sup>10</sup> which in turn gave the pupils the ability to learn better, as the sources indicate, "An individual who has a level of physical and movement abilities will help to develop basic skills."<sup>11</sup>

The biological development of the student at this age stage has an important role in developing many skills and physical and motor qualities, the most important characteristic of this age stage is learning the movements that are characterized by balance, such as games of time, running, alignment, balance, agility, flexibility, etc. Of the abilities and physical and movement characteristics and swimming, which is an extension of the basic movements that the child has learned and mastered in earlier stages, and therefore the learning capacity of the child is high and accurate and has a high movement compatibility that reaches the highest possible in many sporting activities.<sup>12</sup>

The researcher attributes the reason for this to the fact that playing with games and artistic participations greatly reduced the excessive motor activity of its members, as the existence of an effective educational approach to the method of linking play and art for late primary school students has an effective positive effect in reducing the undesirable behavior in which it is motor activity Plus, as the curriculum relied mainly on drawing the child's attention to something he loves and pushing him to patience to modify his behavior, gradually and by using several method, including positive support for appropriate as well as material behavior, taking into account the importance of the child's nature, and that he cannot settle and calm for a long time. One of the method of behavioral therapy is positive reinforcement, which is "the provision of material and moral reinforcements for the child's positive behavior, through symbolic reinforcements, and then these symbolic reinforcements are replaced by concrete reinforces such as gifts."<sup>13</sup>

### Conclusions

1. Learning by playing through the study of physical and artistic education made the research sample reach the best in the physical, skill, motor and moral levels, as the results indicated that many developments occurred in the abilities of students, and this is what fulfills the hypothesis of the research.

2. Achieving very high results in the tests under investigation.
3. The learning style through play and art collectively led to the reduction of hyperactivity and distraction, and the formation of good relationships between them.
4. Improved motor abilities after playing games and practicing technical drawings for formations due to their reliance on technical, collective, movement and sports aspects.

**Ethical Clearance:** The Research Ethical Committee at scientific research by ethical approval of both MOH and MOHSER in Iraq

**Conflict of Interest:** None

**Funding:** Self-funding

### References

1. Ahmed Abdel Dayem Al-Wazir, Ali Mustafa Taha: A Trainer's Guide in Volleyball, Tests/Planning/Records, 1st Edition, (Cairo: Arab Thought House, 1999).
2. Ahmad Abdul-Rahman (and others): The Scientific Foundations of Kinetic Education, 1st Edition, Kuwait: Dar Al-Qalam for Publishing and Distribution, 1990.
3. Al-Ruby, Ahmed Omar Suleiman: Perceptual-motor capabilities of the child, theory and measurement, Arab Thought House, Cairo, 1995.
4. Saad Eddin Abul Fotouh Al-Sharnoubi; Basic Concepts and Treatments in Statistics, 1st Edition: (Alla Alexandria, Al Radaa Technical Press, 2001).
5. Abd Ali Nassif and Qassem Hassan Hussein; Principles of Mathematical Training Science, 1st Edition: (Mosul, Dar Al Kutub for Printing and Publishing, 1988)
6. Saba Abdel Moneim Mohamed Al Mahfouz. The Impact of a Mentoring Program to Reduce Excessive Activity in Kindergarten Children, Master's Thesis, University. Baghdad/College of Education for Girls, 2010.
7. QasimLazamSabr: Topics in Kinetic Learning, Iraq, Higher Education Press, 2005, Muhammad Jasim al-Yasiri and Marwan Abdul Majid; statistical method in the fields of educational research, 1st Edition: (Amman, Al-Warraq Foundation for Publishing and Distribution, 2001).

8. Qais Naji: *Developing Physical Ability in School Age*, Higher Education Press, Baghdad, 1989
9. Kurt Maynell: *Kinetic Learning*, (translation) Abd Ali Nassif, Ministry of Higher Education, University of Baghdad, 1987.
10. Muhammad Sobhi Hassanein: *Measurement and Evaluation in Physical Education and Sports, Part 1*; (Cairo, Arab Thought House, 1995).
11. Mohammed Abdel-Halim; *Descriptive and Inferential Statistics in Educational and Psychological Sciences*: (Kuwait, Al-Falah Library, 1986).
12. Muhammad Abd Al-Fattah Al-Sayrafi; *Scientific Research, Applied Guide for Researchers*, 1st Edition: (Amman, Wael for Publishing and Distribution, 2002).
13. Mamdouh Abdel Moneim and Issa Abdullah; *Measurement, psychological evaluation, and narration*, first edition: (Beirut, Al-Falah Library, 1995).

# Molecular Study of Genetic Diversity in *Escherichia coli* Isolated from Tap Water in Baquba

Noor Jameel Allhaby<sup>1</sup>, Hadi Rahman Rasheed Al-Taai<sup>2</sup>

<sup>1</sup>Postgraduate, <sup>2</sup>Prof. Dr., College of Science, Diyala University, Iraq

## Abstract

One hundred and ten samples of the tap water in Baquba city were collection .Ten isolates were obtained. The results of the sensitivity test showed that 10 isolates were multidrug, 10 isolates exhibited moderate resistance ranging from 5-8 antagonists. Through the use of the RAPD-PCR profiling system, the vast majority of *Escherichia coli* strains under study have large genomes and high virulence factors by belonging to group A2. Results of genetic profiling using the ERIC- PCR and BOX-PCR system showed several groups of isolates were identified as having a genetic variation and B2 group was given the highest proportion of ERIC- PCR system,70% in ERIC While A2 group was given the highest proportion of BOX- PCR system,40% in the BOX indicating that there is a negative spread The present study indicates that there is a correlation between taxonomic systems was evident by the distribution of isolates in each pattern and group.

**Keywords:** *E. coli*, ERIC-PCR, BOX-PCR, RAPD-PCR.

## Introduction

*Escherichia coli* is a gram-negative bacteria belonging to the Enterobacteriaceae family, short bacilli, facultative anaerobic<sup>(1)</sup>. *E. coli* is a major component of the human normal intestinal flora. Among the intestinal pathogens<sup>(2)</sup>. There are several virulence factors that contribute to *E. coli* pathogenicity, such as enterotoxins, endotoxin and biofilm formation<sup>(3)</sup>. These bacterial strains are a potential reservoir for antimicrobial resistance genes<sup>(4)</sup>. The widespread development of resistance to several different antibiotics is generally as a result of lateral or horizontal gene transfer. Many studies have demonstrated that plasmid transfer between bacteria occurs in diverse environments<sup>(5)</sup>. *E. coli* bacteria are used as biomarkers such as their use as a source of faecal contamination in environmental samples. Where the presence of these strains (whose habitat is the intestines of humans and animals) in the water indicates fecal pollution resulting from humans

or animals, and thus environmental pollution.<sup>(6;7)</sup>. PCR fingerprinting method like enterobacterial repetitive intergenic consensus (ERIC- PCR) and BOX-PCR has been extensively used to study genetic relationship as they have discriminatory capability in differentiating different genera of bacteria<sup>(8)</sup>.

The aim of this study is study virulence factors and genetic diversity for *E. coli* bacteria isolates from environmental sources (water).

## Materials and Method

***E. coli* sample collection and identification:** In this study, ten isolates of *E. coli* were isolated from 110 tap water sample at the Baquba city,during October-December 2019.

Take known volume (30 mL) of water samples collected from tap water in Baquba city, cultured on Maconkey broth medium to ensure that the samples are contaminated with Gram-negative bacteria, and then cultured on contaminated samples on Maconkey agar plates, and then cultured on Eosin methylene blue agar plates for isolation of enteric bacteria. Gram stain and other biochemical tests were used such as IMViC Tests,Urea and Kligler Iron Agar.<sup>(9)</sup>.

---

### Corresponding Author:

Noor Jameel Allhaby

Postgraduate, College of Science, Diyala University,  
Iraq

e-mail: norjamil1986@gmail.com



**Susceptibility test of antibacterial agents:** Susceptibility of all the isolates to different antibiotics was determined by the disc diffusion method as recommended by the Clinical and Laboratory Standards Institute (CLSI) (10). The antibiotic discs used in this study were (Tetracycline (30µg), Imipenem (10µg), Doxycycline (30µg), Aztreonam (30µg), Levofloxacin (5µg), Cefuroxime (30µg), Trimethoprim-sulfamethoxazole (1.25/23.75µg), Azithromycin (15µg), Cefoxitin (30µg), Ticarcillin-clavulanate (75/10µg), Cefpodoxime (10µg), Ampicillin-sulbactam (10/10µg)) Each antibiotic concentration was applied on the surface of Muller Hinton agar plates inoculated with *E. coli* isolates and incubated at 37°C for 24 h.

**Biofilm formation detection using Micro Titer Plate method (MTP):** The bacterial isolates were cultured on nutrient broth for 18- 24 hr at 37°C aerobically. About 200 µL of the bacterial suspensions were transferred into polystyrene plates containing 96 wells and a broth without bacterial inoculum was used as a negative control. The plate was incubated for 24 hr. The bacterial suspensions then removed and each well was washed three times with sterile saline solution (0.9% NaCl). The cells stuck on the walls were fixed with 200 µL of methanol for 10-15 minutes. The methanol was removed, the plates were left at room temperature to dry and they were stained with 200 µL of crystal violet 0.5% for 10-15 minutes. The plates then washed with distilled water 2-3 times and dried at room temperature. The absorbency was taken in an ELISA reader at wavelength of 630 nm, <sup>(11)</sup>. The value of the optical densities for each isolate (OD<sub>i</sub>) was obtained by averaging the three wells, and this value was compared to the optical density of the negative control (OD<sub>c</sub>). The isolates were classified into four categories, according to the mean optical densities (OD<sub>i</sub>) in relation to the OD<sub>c</sub> results. If OD<sub>i</sub> ≤ OD<sub>c</sub>; considered non-adherent, OD<sub>c</sub> ≤ OD<sub>i</sub> ≤ 2\*OD<sub>c</sub>; considered moderately adherent and if 2\*OD<sub>c</sub> ≤ OD<sub>i</sub> which considered strongly adherent<sup>(12)</sup>.

**Detection of Acyl-homoserine lactone(AHL) by colorimetric method:** The isolates were incubated in 5 mL Mueller Hinton broth overnight at 37°C. 1.5 mL of the suspension was centrifuged at 10,000 rpm for 15 min, the supernatant was transferred and this step was repeated twice Subsequently liquid-liquid extraction using ethyl acetate for 10 min and the organic phase (top) was removed. Next, the samples were dried at 40°C, they transferred 40 µL to a microplate and added 50 µL of 1:1 solution of hydroxylamine 2 M: NaOH 3.5

M and 50 µL of 1:1 solution of FeCl<sub>3</sub> 10% in HCl 4 M: Ethanol 95%. Finally, the optical density at 520 nm was measured in a plate reader.<sup>(13)</sup>

### Rep-PCR profile and dendrogram construction (ERIC, RAPD, BOX)

*E. coli* DNA was prepared for PCR according to the method described <sup>(14)</sup>.

Rep-PCR was performed using The ERIC forward primer (5'-ATGTAAGCTCCTGGGGATTAC-3') and reverse primer (5'AAGTAAGTGACTGGGGTGAGCG-3')<sup>(15)</sup> were used to amplify repetitive equences present in the chromosomal DNA of *E. coli* isolates. ERIC-PCR was carried in 25µl, volume comprising of 100ng of *E. coli* DNA, 1.5µl (10 pmol) of each primer and 12.5µl Mastermixe. Filtered water was added to the mixture to make a final volume of 25µl. Reactions were carried out using a programmable thermocycler according to the following thermocycling conditions: initial denaturation at 94 °C for 1 minute, with the next 30 cycles consisting of a denaturation step at 94 °C for 30 seconds, annealing at 52 °C for 35 seconds, extension at 72 °C for 4 minutes, and a final extension for 5 minutes at 72 °C.

RABD(1247) (5 - AAGAGCCCGT-3) <sup>(16)</sup>. PCR was carried out in a 25µl reaction mixture, comprising of 100 ng of *E. coli* DNA, 1.5µl (10 pmol) each primer and 12.5µl Mastermixe. Filtered water was added to the mixture to make a final volume of 25µl. conditions were as follows 95°C for 15 min, 35 cycles of 94°C for 1 min, 38°C for 1 min and 72°C for 2 min, with a final 10 min elongation step at 72°C.

BOX (5 - CTACGGCAAGGCGAC-GCTGACG-3) (17). PCR was carried out in a 25µl reaction mixture, comprising of 100 ng of *E. coli* DNA, 1.5µl (10 pmol) each primer and 12.5µl Mastermixe. Filtered water was added to the mixture to make a final volume of 25µl.

Conditions were as follows: after an initial denaturation at 94\_C for 5 min, 35 cycles of denaturation (94\_C, 1 min), annealing (40\_C, 2 min) and extension (72\_C, 2 min) were performed, followed by a final extension (72\_C, 10 min). Amplicons (15µl) were analyzed PCR products were detected in 1.5 % agarose gel, stained with ethidium bromide and visualized by transilluminator. Dendrograms were constructed using unweighted pair-group method of arithmetic average (UPGMA).

## Results and Discussion

Ten *E. coli* isolates were obtained from 110 samples represented 9.09 % from the total samples collected from tap water the Baquba City between October to the December 2019. *E. coli* identified known through the classical diagnostic and genetic diagnostic tests. All results shown in figure 1,2,3 and 4 also in Table 1.

All isolates of *E. coli* were tested for antibiotic sensitivity test according to disk diffusion test against 12 different antibiotics previously mentioned. The percentage of resistance to the antibiotics used as follows: Aztreonam was 80%, Cefpodoxime 70%, Trimethoprim- sulfamethoxazole 55 %, Cefoxitin 45%, Cefotaxime 45%, Doxycycline 70%, Azithromycin 60%, Ticarcillin-clavulanate 25%, Ampicillin-sulbactam 15%, Tetracycline 65%, Levofloxacin 50 % and Imipenem 30% as shown in the chart 1.

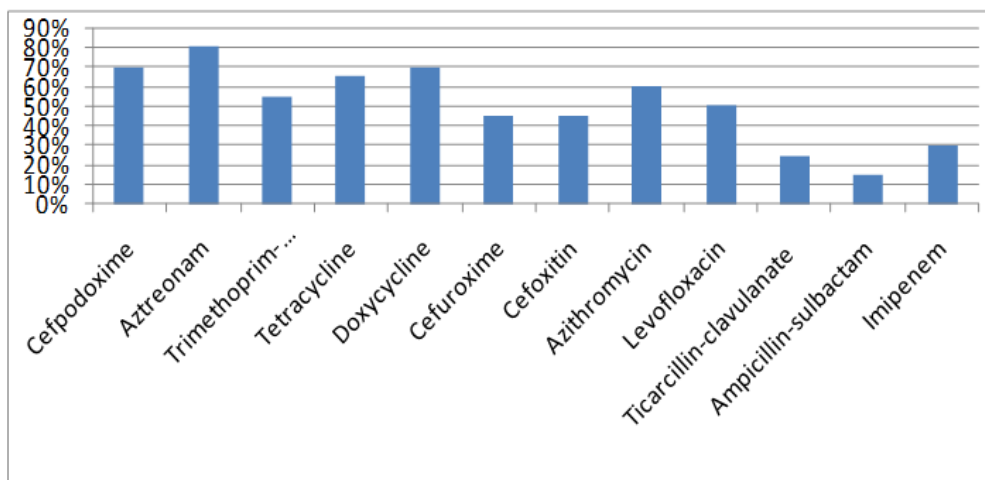


Fig. 1 : A diagram showing the resistance level of isolates for each Antibiotic

Transmission of the resistance between the intestinal family strains and the transition may be through spaying or bacterial coupling. Break the betalactam ring, or add proximity between the antibody and target sites (PBPs) or alter the permeability barrier<sup>(18,19)</sup>.

**Biofilm formation (Micro-titer plate method (MTP)):** All *E. coli* isolates from water were 10 (100%) isolates forming biofilms, 80% of isolates were Moderate biofilm where 20% of isolates were strongly biofilm

In other studies on bacterial resistance and biofilm formation in *E. coli*. in study for a total of 88 isolates the percentages of non-forming strains and weak, moderate and strong production capacity biofilms were 6.8, 36, 39.7 and 17.4%, respectively<sup>(20)</sup>

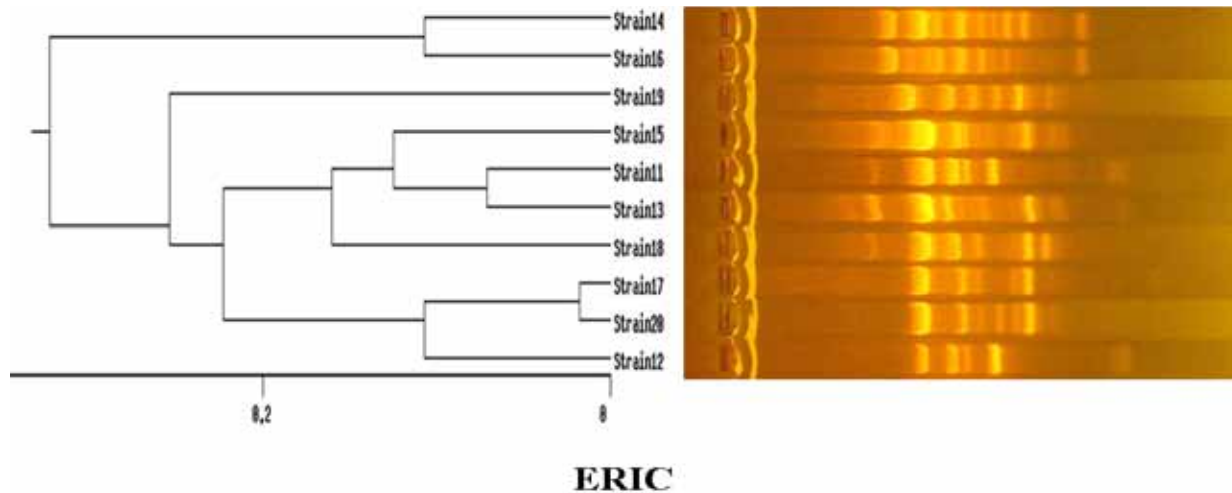
**Detection of Acyl-homoserine lactone (AHL) by colorimetric method:** Nine *E. coli* isolates from water (90%) isolates Producer of Acyl-homoserine lactone.

Several studies have reported that *E. coli* is not able to produce AHL, yet has the ability to alter their pattern of gene expression and phenotypic properties in response to AHL<sup>(21)</sup>.

### Genotyping systems:

**ERIC-PCR Profiling System:** The isolates are classified according to the ERIC typing system and on the basis of the number of bands they own and according to the Dic program, the two main groups are appeared Group A and Group B:

The A group was characterized by having only 2 isolates. While group B was characterized by 8 isolates out of a total of 10 isolates under study. This group was divided into 2 subgroups under Group B, B1, B2 as shown in Diagram 2. The B1 group has one isolate only. The B2 group has 7 isolates.

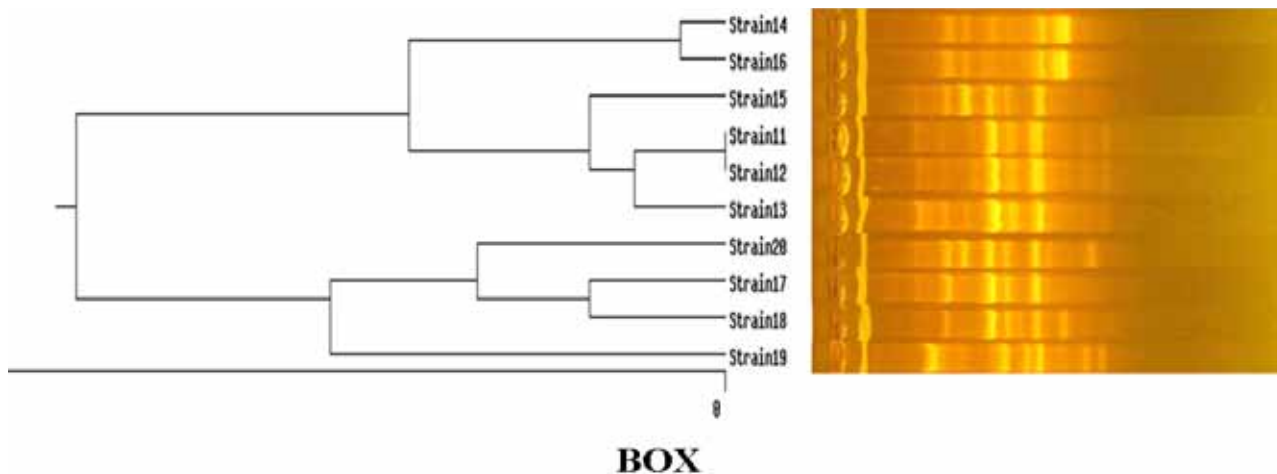


**Fig. 2 :Dendritic analysis,and The resulting packets of ERIC - PCR reaction to some isolates of E.coli bacteria. (using electric relay technology for 1.5 hours and a voltage of 50 volts. The letter M denotes the volumetric guide 1kb**

Many of the studies that used the ERIC-PCR system . Some of them differed in the size of the bands, their number or the number of patterns that emerged. Part of this difference may be due sometimes to the numerical variation of isolates used . The study explained that eighteen profiles each contained 2 to 5 isolates showing a similar genetic pattern. Similar genotype <sup>(22)</sup>, The study showed that genetically modified isolates of the ERIC system of 27 different types can be grouped into 4 groups with similarities from 86 percent. Its bands are from 3 to 15 and the size is from 0.1 to 5.0 kb. <sup>(23)</sup>

**BOX-PCR Profiling System:** The isolates are classified according to the BOX typing system and on the basis of the number of bands they own and according to the Dic program, the two main groups are appeared Group A and Group B:

The A group was characterized by having 6 isolates. This group was divided into 2 subgroups under Group A, A1, A2 . The A1 group has two isolates. The B2 group has 4 isolates. While group B was characterized by 4 isolates. This group was divided into 2 subgroups under Group B, B1, B2 as shown in Diagram 3. The B1 group has one isolate only. The B2 group has 3 isolates.



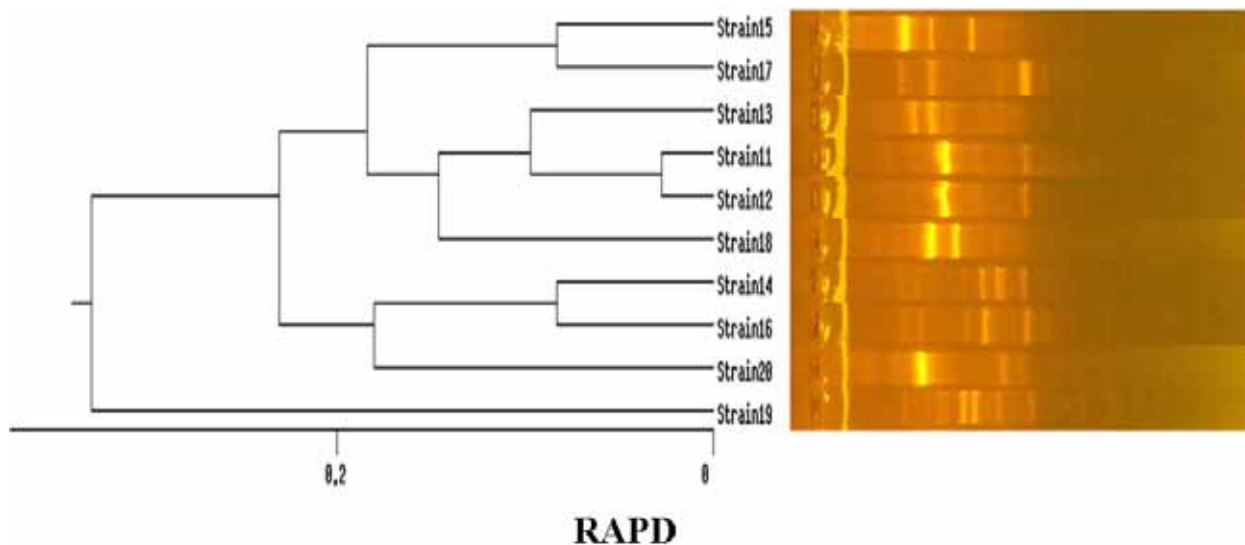
**Fig. 3 :Dendritic analysis and the resulting packets of BOX- PCR reaction to some isolates of E.coli bacteria. (using electric relay technology for 1.5 hours and a voltage of 50 volts. The letter M denotes the volumetric guide 1kb)**

BOX-PCR was second only to the PCR-5 GTG method. The researchers noted that the method of BOX-PCR showed high discriminative strength by generating 127 clear packets ranging from 0.16 to 3.9 kB whereas ERIC-PCR generated 61 packets ranging from 0.56 to (24). The study also showed that stereotyping method that exploit the repeated elements distributed to the genome are more useful for assessing genetic diversity(25).

**RAPD -PCR Profiling System:** The isolates are classified according to the RAPD typing system and on the basis of the number of bands they own and according

to the Dic program, the two main groups are apaered Group A and Group B:

The A group was characterized by having 6 isolates. This group was divided into 2 subgroups under Group A, A1, A2 . The A1 group has two isolates. The A2 group has 4 isolates. While group B was characterized by 3 isolates . This group was divided into 2 subgroups under Group B, B1, B2 as shown in Diagram 6. The B1 group has two isolated. The B2 group has one isolate. While one isolation was out group.



**Fig. 4: Dendritic analysis and The resulting packets of RAPD- PCR reaction to some isolates of *E. coli* bacteria. (using electric relay technology for 1.5 hours and a voltage of 50 volts. The letter M denotes the volumetric guide 1kb)**

The presented dual RAPD-PCR method has demonstrated a high level of resolution that allows for identification of distinct *E. coli* clones. Historically, RAPD assays have exhibited low reproducibility(26).

**Table 1: Patterns of total isolates of *E. coli* according to the ERIC, BOX, RAPD system, number and percentage according to each category.**

ERIC	A		B1	B2	
No. isolated	2		1	7	
Percentage %	20%		10%	70%	
BOX	A1	A2	B1	B2	
No. isolated	2	4	3	1	
Percentage %	20%	40%	30%	10%	
RAPD	A1	A2	B1	B2	Out group
No. isolated	2	4	2	1	1
Percentage %	20%	40%	20%	10%	10%
Total	10 (100%)				

## Conclusion

The present study indicates that there is a correlation between taxonomic systems was evident by the distribution of isolates in each pattern and group.

**Ethical Clearance:** The Research Ethical Committee at scientific research by ethical approval of both MOH and MOHSER in Iraq

**Conflict of Interest:** None

**Funding:** Self-funding

## References

1. Kaper JB, Nataro JP, Mobley LT. Pathology *Escherichia coli*. *Nat Rev Microbiol*. 2004;2: 123–140.
2. Doughari HJ, Ndakidemi PA, Human IS, Benade S. Virulence factors and antibiotic susceptibility among verotoxin non O157: H7 *Escherichia coli* isolates obtained from water and wastewater samples in Cape Town, South Africa. *Afri. J. Biotechnol*. 2011; 10(6): 60-68.
3. Farrokh C, Jordan K, Auvray F, Glass K, Oppegaard H, Raynaud S. Review of Shiga-toxin-producing *Escherichia coli* (STEC) and their significance in dairy production. *Int. J. Food. Microbiol*. 2013; 162: 190-212.
4. Le Page S, Dubourg G, Baron SA, Rolain JM, Raoult D. Global increase in resistance to antibiotics: a snapshot of resistance from 2001 to 2016 in Marseille, France. *Eur J Clin. Microbiol. Infect. Dis*. 2019; 38: 395-407.
5. Jarocki P, Podleśny M, Komoń-Janczara E, Piotr J, Kucharska J, Glibowska A, Targoński Z. Comparison of various molecular methods for rapid differentiation of intestinal bifidobacteria at the species, subspecies and strain level. *BMC. Microbiol*. 2016; 22(16): 159.
6. Berendonk TU, Manaia CM, Merlin C, Fatta-Kassinos D, Cytryn E, Walsh F, Martinez JL. Tackling antibiotic resistance: The environmental framework. *Nat. Rev. Microbiol*. 2015; 13: 310–317.
7. Montealegre MC, Roy S, Böni F, Hossain MI, Caduff L. Risk Factors for Detection, Survival, and Growth of Antibiotic-Resistant and Pathogenic *Escherichia coli* in Household Soils in Rural Bangladesh. *Applied Environmental Microbiol*. 2018; 84 (24): 8–18.
8. Momtaz H, Karimian A, Madani M, Safarpour DF, Ranjbar R, Sarshar M. Uropathogenic *Escherichia coli* in Iran: serogroup distributions, virulence factors and antimicrobial resistance properties. *Ann Clin Microbiol Antimicrob*. 2013; 12(8).
9. Chess T. *Microb*. 18th edition. McGraw Hill. United State. 2012
10. CLSI (Clinical & Laboratory Standards Institute). Performance standard for antimicrobial susceptibility testing Seventeenth informational supplement. 2018; 27(1): 100-170.
11. Tang J, Kang M, Chen H, Shi X, Zhou R., Chen J. The Staphylococcal nuclease prevents biofilm formation in *Staphylococcus aureus* and other biofilm-forming bacteria. *Sci. China. Life*. 2011;54(9):863-9.
12. Almeida C, Azevedo NF, Santos S, Keevil CW. Correction: Discriminating Multi-Species Populations in Biofilms with Peptide Nucleic Acid Fluorescence In Situ Hybridization (PNA FISH). *PLoS ONE*. 2013; 8 (6): 101-371.
13. Dietrich J, Mckee A, Keasling J. High-Throughput Metabolic Engineering: Advances in Small-Molecule Screening and Selection. *Rev. Bioche*. 2010;79:563-590.
14. Adwan K, Jarrar N, Abu-Hijleh A, Adwan G, Awwad E. Molecular characterization of *Escherichia coli* isolates from patients with urinary tract infections in Palestine. *Journal of Medical Microbiology* 2014; 63: 229–234.
15. Ardhami MA, Ranjbar R. Molecular typing of uropathogenic *E. coli* strains by ERIC-PCR method. *Medi. Bacteriol*. 2016;8(4):2291-2296.
16. Nielsen KL, Godfrey PA, Stegger M, Andersen PS. Selection of Unique *Escherichia coli* Clones by Random Amplified Polymorphic DNA (RAPD): Evaluation by Whole Genome Sequencing. *J. Microbiol. Method*. 2014;5:101-103.
17. Gambero ML, Blarasin M, Bettera S, Albo JG. Genetic diversity of *Escherichia coli* isolates from surface water and groundwater in a rural environment. *J. Water Health*. 2017;15(5):757-765.
18. Turner PJ. Extended-spectrum, B-lactamase. *Clin. Infect. Dis*. 2005; 41(suppl. 4), s273-5.
19. Prats G, Miretis B, Miro E. Cephalosporin Resistant *Escherichia coli* among summer camp attendees

- with salmonellosis . *Emerg. Infect. Dis.* 2003; 9(10), 1273-1278.
20. Shikh H, Shakibaie MR. Proteus Strains Isolated from Hospitalized Patients; Matter of Hospital Hygiene and Antimicrobial Stewardship. *Pak. J. Biol. Sci.* 2013; 16(22):1496-1502.
21. Ahmer BM. Cell-to-cell signalling in *Escherichia coli* and *Salmonella enterica*. *Mol. Microbiol.* 2004; 52(4):933-945.
22. Xia Y, Liang Z, Su X, Xiong Y. Characterization of carbapenemase genes in enterobacteriaceae species exhibiting decreased susceptibility to carbapenem in a university hospital in Chongqing, China. *Ann Lab Med.* 2012; 32, 270-275.
23. Alitheen Z Y, Raha NS, Samuel A, Yeap L. Random amplified polymorphic DNA-PCR and ERIC PCR analysis on *Vibrio parahaemolyticus* isolated from cockles in Padang, Indonesia. *International Food Research Journal.* 2009;16: 141-150.
- 24- Mohapatra BR, Broersma K, Mazumder A. Comparison of five rep-PCR genomic fingerprinting method for differentiation of fecal *Escherichia coli* from humans, poultry and wild birds Authors. *Microbiology Letters* 2007;98–106.
25. Van belkum A, Hermans PW. BOX PCR Fingerprinting for Molecular Typing of *Streptococcus pneumoniae*. *Method Mol Med.* 2001;48, 159-168.
- 26- Meunier JR, Grimont PA. Factors affecting reproducibility of random amplified polymorphic DNA fingerprinting. *Res Microbiol.* 1993;144:373–379.

# Asprosin Role for Obese Male Patients with Diabetic Mellitus Type II

Dina A.M. Al-Khafajy<sup>1</sup>, Maysaa J. Majeed<sup>1</sup>, Omar F. Al-Azzawi<sup>1</sup>; Ayad Ismael Khaleel<sup>2</sup>

<sup>1</sup>Researcher, <sup>2</sup>Prof., <sup>3</sup>Associate. Prof., University of Baghdad, Medicine Faculty, Baghdad, Iraq, <sup>4</sup>Lecturer, Al-Qasim Green University, Agriculture Faculty, Department of Horticulture, Babylon, Iraq

## Abstract

Hormones, their receptors, and the associated signaling pathways make compelling drug targets because of their wide-ranging biological significance to study the role of asprosin in obese male patients with diabetic mellitus type II. ELISA method was used to assay asprosin and insulin. Blood was taken with drawn sample from 30 obese normal patients with age range (40-60) years, 30 diabetic patients with age range (40-60) years at duration of disease (1-5) years and 30 normal healthy patients. The mean difference between T2DM according to insulin % ( $23.8 \pm 0.6$ ) was increased than the mean of IFG ( $17.7 \pm 1.0$ ) (P 0.000). The mean difference between T2DM according to asprosin ( $122.1 \pm 21.8$ ) was increased than the mean of IFG ( $51.4 \pm 2.7$ ) (P 0.000), the mean differences between DM2 and IFG cases in different weight groups (Ob., Ow. and Nw) according to insulin was studied, the results showed that, there were significant differences in DM and IFG obese groups (G1 and G2) according to insulin ( $24.18 \pm 1.13$ ,  $15.56 \pm 0.66$ ) P (0.00), however, there were significant differences between DM and IFG in Normal weight groups (G5 and G6) according to insulin ( $19.98 \pm 0.93$ ,  $11.12$ ) P (0.00), while no significant differences between DM and IFG in Over weight groups (G3 and G4) according to insulin ( $27.22 \pm 0.34$ ,  $28.56 \pm 1.59$ ) P (0.42). The mean differences between diabetic mellitus type 2 and impaired fasting glucose cases in different weight groups (obese, over weight and normal weight) according to Asprosin were shown in Table (3), Figure (). The results showed that, there were significant differences between DM and IFG in obese groups (G1 and G2) according to Asprosin ( $307.42 \pm 8.4$ ,  $66.3 \pm 2.2$ ) P (0.00), However, there were significant differences between DM and IFG in overweight groups (G3 and G4) according to Asprosin ( $28.3 \pm 0.5$ ,  $51.7 \pm 3.2$ ) P (0.00) In addition to that, there were significant differences between DM and IFG in normal weight groups (G5 and G6) according to Asprosin ( $30.5 \pm 1.7$ ,  $21.2 \pm 1.6$ )

**Keywords:** *Asprosin, obese patients, Diabetic Mellitus Type 2, IFG.*

## Introduction

T2DM accounts for between 90% and 95% of diabetes, with highest proportions in low- and middle income countries<sup>(1)</sup>. It is a common and serious global health problem that has evolved in association with rapid cultural, economic and social changes, ageing populations, increasing and unplanned urbanization, dietary changes such as increased consumption of highly processed foods and sugar sweetened beverages, obesity, reduced physical activity, unhealthy lifestyle and behavioural patterns, fetal malnutrition, and increasing fetal exposure to hyperglycemia during pregnancy. T2DM is most common in adults, but an increasing number of children and adolescents are also affected<sup>(2)</sup>. The major causative of T2DM is due to the combination

of disorder in insulin secretion via pancreatic  $\beta$  cells and peripheral insulin resistance (IR)<sup>(3)</sup>. IR as a result of defects within signaling pathways of insulin in its target tissues<sup>(4)</sup>. Insulin is a peptide hormone made up of 51 amino acids (a.a), it is created by the  $\beta$ -cells of the pancreas. Insulin peptide is primarily produced as preproinsulin and fractionate into proinsulin and later split into two peptides are C-peptide and insulin<sup>(5)</sup>. Numerous factors are known to affect insulin formation. The unique and most significant physiological method that stimulates the process of transcription and translation at gene of insulin and RNA respectively is metabolism of glucose<sup>(6)</sup>. In response to elevated glucose in the blood after ingestion and absorption from food, insulin is secreted in two phases and connects to insulin

receptors expressed in muscle, liver and adipose tissue. The secretion of insulin from  $\beta$ -cells of the pancreas is induced by elevation level of glucose mainly of fatty acid and amino acids in the blood. In both humans and rodents, after ingestion and absorption of food, glucose triggers a higher insulin response relative to other nutrients<sup>(8)</sup>, the same amount of fat or combination of fat and protein results in just about a twofold elevation in plasma insulin level relative to the basal level<sup>(8)</sup>.

## Materials and Method

This study performed during period from September 2019 to December 2019 the subject were selected from Teaching Hospital/Medical City. Questionnaires were filled by participants and to get the agreement to participants in this study to collect the information of control and patients group. Blood samples were collected from control and patients group. The sample was drawn from the vein and stored by using (5mL) disposable syringe, all samples were collected in fasting status. The sample was keep into dispensable tubes containing a gel which facilitate the separation processes of serum and allowed to clot at 37°C approximately at ten-fifteen min and then centrifuged at 2000 Xg for ten-fifteen min then the serum was stored at (-20°C) until analysis (serum insulin and asprosin).

**Subjects (patients and control groups):** Subject were enrolled in this study to three group First group: patients 30 normal obese male with age range (40-60) years. Second group: DM type 2 (30) male with age range (40-60) years the duration of disease (1-5) years. Third group: 30 normal healthy male documented by physician or lab investigation matched in their age in both obese group.

**Exclusion Criteria:** Any Patient with the following problems was excluded from the current study. with renal dysfunction. Patient with heart diseases and hypertension. Patient with thyroid disorder. Insulin drug dependency. Any person with the chronic liver disease. Type 1 diabetic patient.

**Inclusion Criteria:** According to American diabetes association ADA criteria all patients are classified as DM type 2 by measurement blood glucose and HbA1c (ADA diabetes care 2019 Jan, 42:s13-s28). Also regard to WHO criteria all patients are classified according BMI.

**Measurement of Human asprosin<sup>(9)</sup>:** Standard wells, a volume of 50 $\mu$ l of the standard solutions were

added to the standard wells. Then a volume of 10 $\mu$ l of the sample was added followed by 40 $\mu$ l of sample diluent was added to the testing sample well, in blank nothing to add. After that, a volume of 100 $\mu$ l of HRP-conjugate reagent was added to each well and then covered by used adhesive strip followed by incubation for sixty min at 37°C. The cover on a plate was removed and starting to wash process, the wash process was repeated for four times using 400 $\mu$ l of Wash Solution each time by an auto washer. A volume of 50 $\mu$ l of chromogen solution (A) and (B) was added to each well and mixed gently and followed by incubation period at 37°C for 15 min. This addition should be protected from light. Next a volume of 50 $\mu$ l Stop Solution was added to each well. The color in the wells converts from blue color to yellow color. If the color in the wells become green or the color change does not appear uniform, the plate should gently covered to ensure good mixing. Afterwards a microtiter plate reader was used to read the absorption within 15 min at 450 nm.

**Measurement of insulin<sup>(10)</sup>:** Standard wells, a volume of 50 $\mu$ l of the standard solutions were added to the standard wells. Then a volume of 10 $\mu$ l of the sample was added followed by 40 $\mu$ l of sample diluent was added to the testing sample well, in blank nothing to add. After a volume of 100 $\mu$ l of HRP-conjugate reagent was added to each well and then covered by used adhesive strip followed by incubation for sixty min at 37°C. The cover on a plate was removed and starting to wash process, the wash process was repeated for four times using 400 $\mu$ l of Wash Solution each time by an auto washer. After that, a volume of 50 $\mu$ l of chromogen solution (A) and (B) was added to each well and mixed gently and followed by incubation period at 37°C for 15 min. This addition should be protected from light. Then a volume of 50 $\mu$ l Stop Solution was added to each well. The color in the wells converts from blue color to yellow color. If the color in the wells become green or the color change does not appear uniform, the plate should gently covered to ensure good mixing. A microtiter plate reader was used to read the absorption within 15 min at 450 nm.

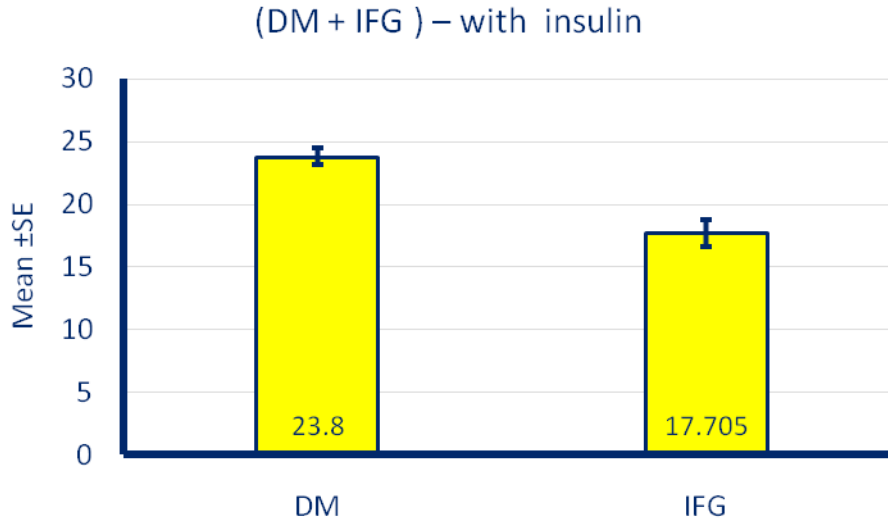
**Statistical Analysis:** The version twenty of SPSS was used to complete Statistical analysis. (Means  $\pm$  SD) were used to represent the variables. The comparison between patients group and control group was done by use student t-test; with a *p*-value of  $\leq 0.001$  was considered a significant. The method that used to find the relationship between two continuous variables was correlation coefficient (*r*).



**Ethical Approval:** Agreement from patients for sampling collection and carrying out this work is obtained from each patient.

**Results**

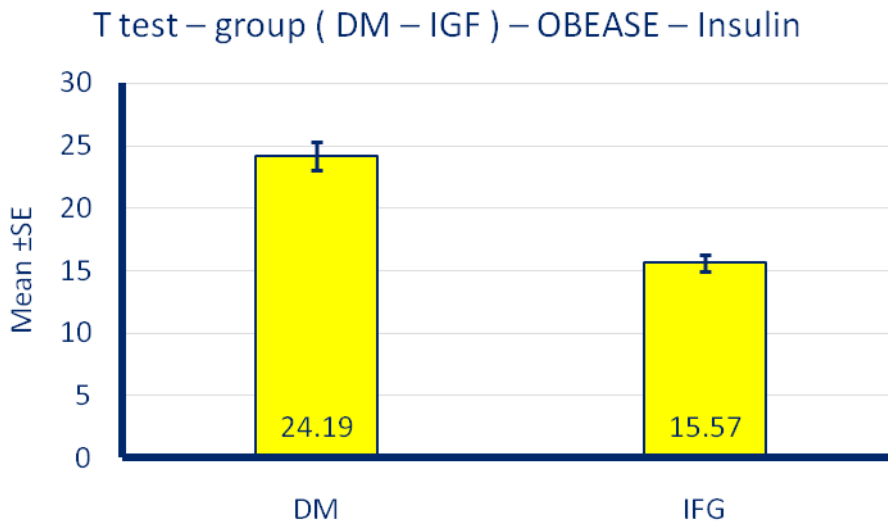
In Figure (1), the mean difference between T2DM according to insulin % ( $23.8 \pm 0.6$ ) was increased than the mean of IFG ( $17.7 \pm 1.0$ ) (P 0.000). The mean difference between T2DM according to asprosin ( $122.1 \pm 21.8$ ) was increased than the mean of IFG ( $51.4 \pm 2.7$ ) (P 0.000).



**Figure (1) Mean difference between diabetic mellitus type 2 (DM2) and impaired fasting glucose (IFG) patients according to insulin P (0.000).**

In Figures (2), the mean differences between DM2 and IFG cases in different weight groups (Ob., Ow. and Nw) according to insulin was studied, the results showed that, there were significant differences in DM and IFG obese groups (G1 and G2) according to insulin ( $24.18 \pm 1.13, 15.56 \pm 0.66$ ) P (0.00), however,

there were significant differences between DM and IFG in Normal weight groups (G5 and G6) according to insulin ( $19.98 \pm 0.93, 11.12$ ) P (0.00), while no significant differences between DM and IFG in Over weight groups (G3 and G4) according to insulin ( $27.22 \pm 0.34, 28.56 \pm 1.59$ ) P (0.42).



**Figure (2): Mean differences between DM 2 and IFG cases in Ob. Cases in different weight groups according to insulin P (0.00)**

The mean differences between diabetic mellitus type 2 and impaired fasting glucose cases in different weight groups (obese, over weight and normal weight) according to Asprosin were shown in Table (3). The results showed that, there were significant differences between DM and IFG in obese groups (G1 and G2) according to Asprosin ( $307.42\pm 8.4$ ,  $66.3\pm 2.2$ ) P

(0.00), However, there were significant differences between DM and IFG in overweight groups (G3 and G4) according to Asprosin ( $28.3\pm 0.5$ ,  $51.7\pm 3.2$ ) P (0.00). In addition to that, there were significant differences between DM and IFG in normal weight groups (G5 and G6) according to Asprosin ( $30.5\pm 1.7$ ,  $21.2\pm 1.6$ ).

**Table (3): The mean difference between DM2 & IFG cases in different weight groups (Obese, Overweight, Normal weight according to Asprosin**

Groups	Sub groups	Asprosin ng/L	P-value
Obese	DM/G1	$307.42\pm 8.4$	0.00
	IFG/G2	$66.3\pm 2.2$	
Over weight	DM/G3	$28.3\pm 0.5$	0.00
	IFG/G4	$51.7\pm 3.2$	
Normal weight	DM/G5	$30.5\pm 1.7$	0.001
	IFG/G6	$21.2\pm 1.6$	

## Discussions

These results were agreement with results obtained by<sup>(11)</sup> who found that, there were significant differences between IFG and Insulin and ( $P < 0.005$ ). Another study of<sup>(12)</sup> found that, there were significant differences between T2DM and insulin  $P < 0.001$ . Asprosin functions to increase plasma glucose levels, and circulating asprosin levels are increased by fasting (a baseline glucose condition) and decreased by feeding a high glucose condition<sup>(13)</sup>. Asprosin might be a risk factor associated with the development of T2DM. Adipose tissue has the endocrine role to regulate metabolism and balance energy homeostasis<sup>(14)</sup>. Several adipose tissue-secreted molecules can either enhance or impair insulin action<sup>(15)</sup>. Insulin resistance, a major cause of T2DM, is one of the most remarkable changes which occur with excess adiposity. Thus, obesity is causally inked to a constellation of metabolic diseases such as T2DM and metabolic syndrome<sup>(16)</sup>. Humans with insulin show pathologically elevated plasma asprosin, and its loss of function through immunological or genetic means has a profound glucose and insulin lowering effect secondary to reduced hepatic glucose release<sup>(17)</sup>. Therefore, therapeutically targeting asprosin might be beneficial in type 2 diabetes mellitus patients<sup>(18)</sup>. Hepatic glucose release into the circulation is vital for brain function and survival during periods of fasting and is modulated by an array of hormones that precisely

regulate plasma glucose levels. A fasting-induced protein hormone that modulates hepatic glucose release. It is the C-terminal cleavage product of profibrillin, and we name it Asprosin<sup>(19)</sup>. Asprosin is secreted by white adipose, circulates at nanomolar levels, and is recruited to the liver, where it activates the G protein-cAMP-PKA pathway, resulting in rapid glucose release into the circulation<sup>(20)</sup>.

## Conclusion

There were significant differences between DM2 patients according to asprosin and insulin, and there were significant differences between IFG cases according to asprosin and insulin.

**Ethical Clearance:** The Research Ethical Committee at scientific research by ethical approval of both MOH and MOHSER in Iraq

**Conflict of Interest:** None

**Funding:** Self-funding

## References

- Melmed S. Hypothalamic-Pituitary Regulation. In: Conn's Translational Neuroscience. 2017. p. 317–31.
- Ascenzi F, Barberi L, Dobrowolny G, Villa Nova

- Bacurau A, Nicoletti C, Rizzuto E, et al. Effects of IGF-1 isoforms on muscle growth and sarcopenia. *Aging Cell*. 2019;18(3).
3. Crisan C, Chande A, Williams K, Raghuram V, Rishishwar L, Steinbach G, et al. Analysis of *Vibrio cholerae* genomes using a novel bioinformatic tool identifies new, active Type VI Secretion System gene clusters. *bioRxiv*. 2019;526723.
  4. Findeis-Hosey JJ, Yang Q, Spaulding BO, Wang HL, Xu H. IMP3 expression is correlated with histologic grade of lung adenocarcinoma. *Hum Pathol*. 2010;41(4):477–84.
  5. Alehagen U, Aaseth J, Alexander J, Johansson P, Larsson A. Supplemental selenium and coenzyme Q10 reduce glycation along with cardiovascular mortality in an elderly population with low selenium status – A four-year, prospective, randomised, double-blind placebo-controlled trial. *J Trace Elem Med Biol*. 2020;61.
  6. Dulskas A, Patasius A, Linkeviciute-Ulinskiene D, Zabuliene L, Smailyte G. A cohort study of antihyperglycemic medication exposure and survival in patients with gastric cancer. *Aging (Albany NY)*. 2019;11(17):7197–205.
  7. Brown E, Rajeev SP, Cuthbertson DJ, Wilding JPH. A review of the mechanism of action, metabolic profile and haemodynamic effects of sodium-glucose co-transporter-2 inhibitors. Vol. 21, *Diabetes, Obesity and Metabolism*. 2019. p. 9–18.
  8. Montagna S, Omicini A. Agent-based modeling for the self-management of chronic diseases: An exploratory study. *Simulation*. 2017;93(9):781–93.
  9. Diagnosis and classification of diabetes mellitus. *Diabetes Care*. 2014;37(SUPPL.1).
  10. J.E. OM. ECONOMIC BURDEN OF DISEASES RELATED TO OVERWEIGHT AND OBESITY IN COLOMBIA. *Value Heal*. 2018;21:S448–9.
  11. Lascar N, Brown J, Pattison H, Barnett AH, Bailey CJ, Bellary S. Type 2 diabetes in adolescents and young adults. Vol. 6, *The Lancet Diabetes and Endocrinology*. 2018. p. 69–80.
  12. Szilagyi A. Relationship(s) between obesity and inflammatory bowel diseases: possible intertwined pathogenic mechanisms. Vol. 13, *Clinical Journal of Gastroenterology*. 2020. p. 139–52.
  13. Badhwar R, Kaur G, Popli H, Yadav D, Buttar HS. Pathophysiology of Obesity-Related Non-communicable Chronic Diseases and Advancements in Preventive Strategies. In: *Pathophysiology of Obesity-Induced Health Complications*. 2020. p. 317–40.
  14. Song Z, Dai X, Yu H, Luo Q, Zhang H, Wu L. Increased Serum IGFBP-1 and Reduced Insulin Resistance After Roux-En-Y Gastric Bypass in Chinese Patients with Type 2 Diabetes: a 6-Month Follow-Up. *Obes Surg*. 2018;28(10):3165–71.
  15. Mamo Y, Bekele F, Nigussie T, Zewudie A. Determinants of poor glycemic control among adult patients with type 2 diabetes mellitus in Jimma University Medical Center, Jimma zone, south west Ethiopia: A case control study. *BMC Endocr Disord*. 2019;19(1).
  16. Shahwan MJ, Jairoun AA, Farajallah A, Shanabli S. Prevalence of dyslipidemia and factors affecting lipid profile in patients with type 2 diabetes. *Diabetes Metab Syndr Clin Res Rev*. 2019;13(4):2387–92.
  17. Deye N, Vincent F, Michel P, Ehrmann S, Da Silva D, Piagnerelli M. Celiac disease: Evolution of the epidemiological profile over the last decade. *J Pediatr Gastroenterol Nutr*. 2016;
  18. Wei M, Wei M, Brandhorst S, Shelehchi M, Mirzaei H, Cheng CW, et al. Fasting-mimicking diet and markers/risk factors for aging, diabetes, cancer, and cardiovascular disease. *Sci Transl Med*. 2017;1(February).
  19. Vimalaswaran KS, Bodhini D, Lakshmi Priya N, Ramya K, Anjana RM, Sudha V, et al. Interaction between FTO gene variants and lifestyle factors on metabolic traits in an Asian Indian population. *Nutr Metab*. 2016;13(1).
  20. Cheung LTF, Chan RSM, Ko GTC, Lau ESH, Chow FCC, Kong APS. Diet quality is inversely associated with obesity in Chinese adults with type 2 diabetes. *Nutr J*. 2018;17(1).

# The Effect of the Advanced Organizations 'Strategy on Attentional Control and Learning Some Offensive Skills Installed with Basketball for Students

Ahmedkhalid Awad

*Lect., Al Maarif University College, Department of Physical Education and Sports Sciences, Iraq*

## Abstract

The researcher used the experimental method with the two experimental and control groups with the two pre and post tests on his sample of 65 students from the second stage students in the University College of Knowledge, Department of Physical Education and Sports Sciences. Researcher measure attentional control on a sample The main experiment, in addition to conducting skill tests, after which the curriculum for the strategy of advanced organizations was applied, and then the researcher used appropriate statistical means to extract the results, and in the light of the results he reached a number of conclusions, which are that the attentional control helped the students in the smart diversity in thinking method and solving the problems they face, the effect The units prepared by the researcher over the experimental group, as they outperformed the control group in developing the offensive skills combined with basketball because they were suitable for the sample and varied with its exercises, tools and method used, and in light of the conclusions the researcher recommends the following: Examine the students and know the level of attention control they have at the beginning of each An educational season, the adoption of educational units prepared according to the strategy of advanced organizations in learning complex offensive skills with basketball, the need to pay attention to modern teaching strategies that carry with them method based on behavioral and constructivist theories and meaningful learning that contribute to raising the level of students and developing the educational process.

**Keywords:** *Strategy, attention and skills; rehabilitations; students activity; teaching modern.*

## Introduction

Students in general, and university students in particular, are the basic building block for community building as they are the source of conscious young energies capable of building society in a way that makes it a developed society. Therefore, caring for the level of this segment and preparing it well must be a priority and this is done through the use of thoughtful strategies and plans that raise the mental and scientific level Strategies are considered one of the most important types of educational plans based on the foundations of

psychological theory that give the learner experiences and effective mental capabilities that will activate the role of the learner within the educational community. Strategies often focus on the mental aspect, method of thinking, and the emotional state of students, and strategies transfer practices and theoretical sciences. To be applied, as is the case in the sports field, where these strategies play an important role in learning skills and raising them to higher levels by providing him with information and directing him towards correct learning method as well as enhancing the learner's self and his internal ability to reach the state of learning and then creativity in the learned skill.<sup>1</sup>

The strategy of advanced organizations is one of the strategies that can be used to facilitate learning, and it consists of an introduction and an introductory material that is presented to the learner prior to learning the new material and is general and comprehensive, aiming to provide the learner with a general knowledge base on

---

### Corresponding Author:

**Ahmedkhalid Awad**

Lect., Al Maarif University College, Department of Physical Education and Sports Sciences, Iraq  
e-mail: a.k.awad@uoa.edu.iq

which to build in the formation of concepts, principles and main ideas. Attention control is important in the learning process by enabling the individual to regulate his behavior and control it. The student who is able to observe himself is the one who has positive internal directives towards the educational process and thus is able to plan for his learning and organize himself as he is the most capable of solving problems and facing the challenges that it is imposed by difficult tasks, and self-monitoring can give the learner an opportunity to develop his learning styles and give him better competencies for performance by demonstrating greater levels of ability and motivation.<sup>2</sup>

The basketball game is one of the competitive team games that took the lead in terms of its spread in the world and which contains in its content a number of complex offensive skills, as the complex offensive skills are important and difficult skills that the player cannot easily perform, as they need a longer time and a greater effort to learn and master it, as learning and mastering it is an effective element in achieving the best results in matches. Hence the importance of research in using this strategy in developing attentional control and learning the offensive skills combined with basketball because of the important educational steps it contains in addition to the use of various educational methods that help to transmit information more clearly and this is what called the researcher to conduct experimental research in order to contribute to developing the educational process and enriching it by creating effective means that stimulate the minds of students, thus helping to facilitate information acquisition, storage and retrieval faster.<sup>3</sup>

**Research Objectives:**

1. Identifying the degree of attention control among second-stage students in the University College of Knowledge/Department of Physical Education and Sports Sciences.
2. Preparing educational units using the strategy of advanced organizations to learn some offensive skills combined with basketball for the research sample.
3. Identify the impact of the advanced organizations' strategy on attention control and learn some offensive skills combined with basketball for the research sample.

**Research Fields:**

- **The human field:** A sample of the second year

students in the University College of Knowledge/ Department of Physical Education and Sports Sciences.

- Time range: The period from 2-11-2019 to 1-13-2020.
- Spatial field: the interior hall and classrooms of the University College of Knowledge.

**Research Methodology**

**Research community and sample:** The research community was determined by the intentional method, and they are the second stage students in the University College of Knowledge/Department of Physical Education and Sports Sciences for the academic year (2019-2020) and their number is (95) students distributed among (3) people. Division (A) is the experimental group of (33) students, and Division (B) is the control group, whose number is (32) students, so that the total number is (65) students.

**Table 1. Shows the division of the research sample**

Classes	Groups	Number of student
A	Experimental	33
B	Control	32
C	Pilot	5
<b>Total</b>	-	<b>70</b>

Means, devices and tools used in the research

- Arab sources.
- Attention Control Scale.
- Tests used.
- Educational units.
- Statistical means.
- Polling questionnaires.
- Forms to record and dump data.
- Observation and experimentation.
- A questionnaire for the attentional control scale.
- Dell computer (1).
- Sony (1) photography camera.
- A tape measure to measure distances.
- Manual stopwatch, count (1).
- Legal basketball Molten 6G, count (33).

**Field research procedures**

**Determination of complex offensive skills in basketball:** Skills are learned from the first stage. Therefore, within the second phase curriculum of the first semester is learning to link between previously learned offensive skills, and among these skills is handling, patience and scoring.<sup>4</sup>

**Determine the skill tests:** Often the researcher needs to choose or develop multiple tests to measure some of the variables that are related to the phenomenon to be measured, so the researcher must choose some tests that measure what you really want to measure, so the researcher, being a teaching basketball specialist, chose the compound offensive tests.<sup>5</sup>

**The following describes the tests used in the research:**

**The first test: receiving and a high chuck ending in peaceful correction<sup>6</sup>**

- The purpose of the test: To measure the ability to receive and dribble (dribble) high, ending in peaceful scoring.
- Necessary tools: A basketball court, four hurdles, a person, eight (8) legal basketballs, a leather tape measure (20 meters), a tape, an electronic stopwatch, two chairs, and a whistle.

**The second test: Receipt ending with a jump shot<sup>7</sup>**

- **The purpose of the test:** To measure the ability to receive ending with a jumping shot - two points.
- **Necessary tools:** A basketball court, three barriers, 10 legal basketballs, a leather tape measure (20 meters), adhesive tape, an electronic stopwatch, two chairs, and a whistle.

**Determine the scale used:**

**Attention Control Scale:** The researcher has reviewed many sources, scientific references, studies and research for the purpose of finding a scale through which to identify the amount of attention control for a sample of research, and the researcher did not find anything other than the scale prepared by,<sup>8</sup> which consists of (37) paragraphs Distributed in three dimensions (attention focus - attention shift - control flexibility of attention) I have placed five alternatives in front of each paragraph and the answer is one of the alternatives and it applies to me always, applies to me, applies to sometimes, applies to me rarely, does not apply to me at all.<sup>9</sup>

**The Attention Control Scale Correction Method:**

To calculate the degree that the respondent gets through his answer to the scale paragraphs, the researcher identified five alternatives and five weights, which are (they apply to me always, they apply to me often, they apply to me sometimes, they apply to me rarely, they do not apply to me) by comparing the laboratory answer with the correct answers prepared in advance Its grades were determined gradually for positive (1,2,3,4,5) and negative (5,4,3,2,1) paragraphs, and accordingly, the lowest score for the scale obtained by the laboratory is (37) and the highest score (185) with an hypothetical average (111).

**Pre-tests:** The researcher carried out the pre-tests on the research sample (control group and experimental group) during two consecutive days. On Tuesday, November 5, 2019 AD, the Attention Control Scale was applied in one of the classrooms in the University College of Knowledge, Department of Physical Education and Sports Sciences. Students answer the scale paragraphs honestly and objectively, because of its great importance for scientific research and the educational process.

**Table 2. Shows the parity of the two research groups in the pre-skill tests and the Attention Control Scale**

Tests	Experimental group			Control group			(t) value	Statistical significance
	N	Mean	SD	N	Mean	SD		
Attention Control Scale	33	119.520	2.849	32	111.540	4.895	1.612	No sig.
Receipt and high chuck ending in peaceful correction	33	2.23	0.461	32	1.90	0.323	0.087	No sig.
Receipt ending by shooting from a jump	33	2.27	0.116	32	1.82	0.114	0.313	No sig.

**Results and Discussions**

**Table 3. Shows the mean, standard deviations, and the value of (t) calculated between the pre-test and the post-test of the experimental group in the investigated variables**

Variables	Pretest		Posttest		Mean diff.	SD diff.	(t) value	Statistical significance
	Mean	SD	Mean	SD				
Attentional control	119.520	2.849	162.436	3.364	42.796	8.563	25.966	Sig.
Receipt and high chuck ending in peaceful correction	2.23	0.461	3.01	0.138	0.76	0.126	31.556	Sig.
Receipt ending by shooting from a jump	2.27	0.116	3.25	0,110	0,97	0.115	43.945	Sig.

**Table 4. Shows the mean, standard deviations, and the value of (t) calculated between the pre-test and the post-test of the control group in the searched variables**

Variables	Pretest		Posttest		Mean diff.	SD diff.	(t) value	Statistical significance
	Mean	SD	Mean	SD				
Attentional control	111.540	4.895	150.40	16.47	41.434	17.336	12.420	Sig.
Receipt and high chuck ending in peaceful correction	1.90	0.323	2.26	0.141	0.34	0.135	13.127	Sig.
Receipt ending by shooting from a jump	1.82	0.114	2.30	0.123	0.44	0.110	21.027	Sig.

**Table 5. Shows the mean, standard deviations, and the value of (t) calculated between the experimental and control groups in the post tests of the investigated variables**

Variables	Experimental group		Control group		(t) value	Statistical significance
	Mean	SD	Mean	SD		
Attentional control	162.436	3.364	150.400	16.470	8.232	Sig.
Receipt and high chuck ending in peaceful correction	3.01	0.138	2.26	0.141	4.262	Sig.
Receipt ending by shooting from a jump	3.25	0.110	2.30	0.123	3.640	Sig.

Through the results that were presented and analyzed in the tables above for the pre and posttests of the experimental group, we find that there is a remarkable development in the level of skills learning, and the researcher attributes the moral differences between the pre and posttests of the experimental group to the effectiveness of the strategy of the advanced organizations because it encouraged students to organize their ideas according to their method appropriate to their abilities. Mentality by placing students in new educational situations in which they can develop the information they possess and stimulate their mental abilities, which leads to the survival of the information for a longer period.<sup>10</sup>

The researcher attributes the moral differences between the pre and posttests of the Attention Control

Scale to the effectiveness of the strategy used. The acquisition of attention control by group members is evident by that it enables the individual to regulate and control his behavior and that the student who is able to observe himself is the one who has positive internal directives towards the educational process. An ability to solve problems and face the challenges posed by educational situations, as self-monitoring can give students an opportunity to develop learning method and acquire better competencies for performance by showing greater levels of ability and motivation.<sup>11</sup>

To consider the research sample are students of the second stage, as they have previous experience with basketball skills, and this provides them with the ability to enter new information and link it to the information obtained in the educational position with the information

he has in his cognitive structure and this is clearly reflected in improving his level of achievement and increasing his motivation for learning. And the impact of learning remains and all this leads to directing the mind with flexibility and attention between and within tasks to achieve the maximum extent of performance.<sup>12</sup>

As for the control group, the researcher attributes the simple development of it to the fact that the method used in learning are traditional with little diversification and rarely have excitement or suspense,<sup>13</sup> (The lack of use of learning strategies and the lack of diversification in method in addition to the absence of some kind of excitement. And the excitement in physical education lessons leads to the lack of development of the level of the control group significantly,<sup>14</sup> In addition, the role of the student or the learner is limited to the role of the recipient, since the method used in teaching the control group is a method that depends on the teacher in a very large percentage, while the role of the student is secondary (as the traditional method is an imperative style on the part of the teacher and makes the student bound by the instructor's instructions and does not give him the freedom to perform, since the student's role here is to receive information and directions, which affects the level of his education).<sup>15</sup>

### Conclusions

1. Attention control helped students to have a smart diversity in thinking styles and problem solving.
2. Karen's model and the method used by the teacher contributed to the development of mental fitness, attentional control, and attacking skills combined with basketball among the research sample, but to varying degrees.
3. The effect of the units prepared by the researcher on the experimental group, as they outperformed the control group in developing the offensive skills combined with basketball because they were suitable for the sample and varied with its exercises, tools and method used.

**Ethical Clearance:** The Research Ethical Committee at scientific research by ethical approval of both MOH and MOHSER in Iraq.

**Conflict of Interest:** None

**Funding:** Self-funding

### References

1. Thanaa Abd al-Wadud Abd al-Hafiz al-Shammari Cognitive overlap and attentional control and their relationship to test anxiety among university students, unpublished PhD thesis, Baghdad Ibn Rushd University, (2015).
2. Hanan Taher Hassan, The effect of the comparative competition style according to the method of family upbringing in reducing the learned disability and learning the skill of passing volleyball among middle school students (Master Thesis, College of Physical Education and Sports Sciences for Girls, University of Baghdad, 2016).
3. Hawra Salman Jassim; Cognitive motivation and its relationship to attention control and information processing among university students, PhD thesis, College of Education for Girls - University of Baghdad, (2017).
4. Safia Muhammad Kal, Self-monitoring and its relationship to internal and external motivation among Yarmouk University students, unpublished master's thesis, Faculty of Education, Yarmouk University, (2012).
5. Adel Abdel-Rahman Nassif, and others, the impact of advanced organizations on the literary achievement of fourth-grade students in the subject of Arabic grammar and retention: (published research, Al-Fath magazine, Issue fifty, 2012).
6. Academy of the Arabic Language. Glossary of Psychology and Education. A1: (Cairo: General Authority for the Affairs of the Emiri Press, 1984).
7. Faris Sami as a young man; Building and standardizing a test battery to measure some offensive skills combined with basketball for youth, PhD thesis, University of Baghdad, College of Physical Education, (2006).
8. Hoda Abdul Sami Abdul-Wahab, the effect of the proactive thinking strategy in learning some basic volleyball skills for players (13-14) years old: (PhD thesis/College of Physical Education and Sports Sciences for Girls/University of Baghdad, 2015).
9. Athab NA. An Analytical Study of Cervical Spine Pain According to the Mechanical Indicators of the Administrative Work Staff. *Indian Journal of Public Health Research & Development.* 2019;10(5):1348-54.



10. Athab NA, Hussein WR, Ali AA. A Comparative Study for Movement of Sword Fencing Stabbed According to the Technical Programming in the Game of Fencing Wheelchairs Class B. *Indian Journal of Public Health Research & Development*. 2019;10(5):1344-7.
11. Alsayigh HA, Athab NA. The Study of Rectus Femoris Activity after Knee Joint Rehabilitation. *International Journal of Pharm Tech Research*. 2016;9(9):360-5.
12. Alsayigh HA, Athab NA, Firas M. The Study of Electrical Activity of the Triceps Brachia Muscle according to the Chemical Changes of Water Loss during Spike in Volleyball. *Journal of Global Pharma Technology*. 2017:57-62.
13. Allard, F., Graham, S., & Paarsalu, M. E. (1980). Perception in sport: Basketball. *Journal of Sport and Exercise Psychology*, 2(1), 14-21.
14. McInnes, S. E., Carlson, J. S., Jones, C. J., & McKenna, M. J. (1995). The physiological load imposed on basketball players during competition. *Journal of sports sciences*, 13(5), 387-397.
15. Aglioti, S. M., Cesari, P., Romani, M., & Urgesi, C. (2008). Action anticipation and motor resonance in elite basketball players. *Nature neuroscience*, 11(9), 1109.

# The Effect of Rehabilitative Physical Exercises to Develop Some Aspects of Muscle Strength and Range of Motion in Rehabilitating the Deltoid Muscle of the Shoulder Joint of Badminton Players

Mustafa Muhammad Ali Farhan<sup>1</sup>, Salman Dawood Tuaimah<sup>2</sup>

<sup>1</sup>Lect., Wasit University, College of Physical Education and Sports Sciences, Iraq,

<sup>2</sup>Asst. Lect., Wasit Governorate, MOE, Iraq

## Abstract

The importance of the research came in preparing rehabilitative exercises for the deltoid muscle in the shoulder joint using exercises with different resistances and angles. The researchers believe that the problem is that the rehabilitation programs that suffer from a lack of reliance on various exercises, devices and weights, as well as angles to determine the degree of pain, which is one of the most important factors in the speed of the process Rehabilitation and symmetry of recovery Therefore, the researcher decided to prepare rehabilitative exercises for the deltoid muscle injury using some different resistance, weights and angles, and try to benefit from them to rehabilitate these injuries to return the injured to practicing sports activity in the shortest possible period. The research aims to:

1. Preparing rehabilitative exercises for the deltoid muscle injury using some different resistances, weights and angles for the subjects of the research sample.
2. Identifying the effect of rehabilitative exercises for the deltoid muscle injury by using some different resistances, weights and angles among the members of the research sample.

The experimental method was used with one group and the number of injured (4) badminton was advanced in Wasit governorate for the 2018-2019 season, and the researchers concluded that the proposed rehabilitative exercises have a positive effect by restoring the normal range of motion on the muscle groups working on a joint, and it is recommended that the means should be used. Therapeutic and auxiliary means to rehabilitate muscle injury in carrying out rehabilitative exercises in line with the level of injury.

**Keywords:** *Rehabilitative physical exercise, deltoid muscle, shoulder joint and badminton.*

## Introduction

The ability of this joint to move is very large as it moves in all directions, but it lacks some strength and consists of the humerus joint with the muscular fossa

of the scapula. The shoulder blade injury is one of the common injuries in badminton, where many occur either as a result of a strong movement such as sending or when pressing over the head, especially when the player neglects the appropriate warm-up procedure to prepare the joint muscles well, which leads to the rupture of the joint fibers and the occurrence of internal bleeding that results in the passage of time Calcium calcification, which requires removal by surgery, so attention must be paid to warm-up exercises, especially strength and flexibility exercises, in addition to performing some real movements of sending or pressing during the warm-up

---

### Corresponding Author:

**Mustafa Muhammad Ali Farhan**

Lect., Wasit University, College of Physical Education and Sports Sciences, Iraq

e-mail: mustafa\_teacher81@yahoo.com

period without a ball first and then using the ball in order to increase the readiness of the joint muscles and prepare them for the performance of physical effort, and the importance of the research came In using rehabilitative exercises to injure the deltoid muscle in badminton players for the purpose of subjecting them to this type of rehabilitation and in order to achieve complete recovery.<sup>1</sup>

The researcher believes that the problem is that the rehabilitation programs that suffer from a lack of reliance on various exercises, devices and weights, as well as angles to determine the degree of pain, which are considered one of the most important factors in the speed of the rehabilitation process and the symmetry of recovery. And try to benefit from them to rehabilitate these injuries, to return the injured to practicing sports activity in the shortest possible period.<sup>2</sup>

**Research Objectives:**

1. Preparation of a proposed rehabilitation approach to rehabilitate the deltoid muscle injury in badminton players.
2. To recognize the effectiveness of rehabilitative exercises in rehabilitating the deltoid muscle injury of badminton players.

**Hypothesis:**

- Rehabilitation exercises have a positive effect in rehabilitating the partial rupture of the deltoid muscle in badminton players.

**Fields of Research:**

- The human field: a sample of advanced badminton players in Wasit governorate clubs.
- Timing range: 5/1/2019 to 15/7/2019.
- Spatial domain: badminton playgrounds in Wasit Governorate.

**Research Methodology:** The researcher used the experimental method for its relevance to the nature of the research.

**The research community and its sample:** The researcher selected the research sample in an intentional way to include a number of players injured in the semantic muscle of the shoulder joint, and their number reached (4) injured players playing badminton for Wasit Governorate for the 2018 season and they were homogeneous in the research variables as in Table (1).

**Table 1. Shows the homogeneity between individuals of the research sample in the morphological measurements and the study variables**

Variables	Measuring unit	Mean	Standard deviation	Mediator	Coefficient of torsion
Length	cm	181.75	5.377	182.50	-0.574
Weight	kg	65.25	1.708	65.50	-0.753
Biological age	Year	21.50	5.802	21	0.491
Tide forward shoulder	Degree	17	1.826	17	0.000
Shoulder movement	Degree	35	3.559	34	0.842
Explosive force	Mater	4.754	0.45	4.902	-0.986
Fast power	Number	6.416	0.523	6.250	0.952

The results of Table (1) show that the values of the torsion coefficients for the variables contained in it were specified between ( $\pm 1$ ), and that they are within the (kaus) curve of the normal distribution, which means the homogeneity of the search sample.

**Method of gathering information**

- Arab and foreign references and sources.

- Standardized tests for some physical characteristics and the normal range of motion of the shoulder joint.
- Stopwatch .
- Height and weight measuring device.
- The geometer.
- Tape measure.

- Medicine balls of (3-5) Kg.
- Various sports iron weights and equipment.

### **Tests of the normal range of motion of the shoulder joint<sup>3</sup>**

The dynamic range of the shoulder joint was measured.

#### **Shoulder Extension Forward:**

- The laboratory sits facing the device, with its arm at an angle (90) between the upper arm and the forearm.
- The arm is placed on the device and on the far side of the arm.
- The lab pushes its arm forward.
- The arm fixed on the device is parallel to the torso.
- The moving arm on the device is parallel to the hummers.
- Read and record the degree achieved from the extent of the arm's reach to the highest point of the degree of pain and the measurement with the tape attached to the device.
- The ideal range of motion for shoulder flexion motion is (0-60) degrees.

#### **Extended Shoulder Movement:**

- The laboratory sits facing the device, with its arm at an angle (90) between the upper arm and the forearm.
- The arm is placed on the device and on the far side of the arm.
- The laboratory is removing his arm out of the body.
- The arm fixed on the device is parallel to the torso.
- The moving arm on the device is parallel to the hummers.
- Read and record the degree achieved from the extent of the arm's reach to the highest point of the degree of pain and the measurement with the tape attached to the device.
- The ideal range of motion for off-shoulder extension motion is (0-60) degrees.

### **Muscle strength tests**

#### **Test of throwing a 3 kg medicine ball with two hands from a sitting position on a chair<sup>4</sup>**

- The purpose of the test: to measure the explosive power of the muscles of the arms and shoulder.
- The tools used: a medicine ball weighing (3) kg, a measuring tape, and a chair with a strap for fixing the trunk.
- Description of the test method: The laboratory sits on the chair and the medical ball is carried by hands over the head and the torso is adjacent to the edge of the chair, the belt is placed around the trunk of the laboratory and held from the back in a controlled manner for the purpose of preventing the laboratory from moving forward during the throwing of the ball with the hands, so that the process of throwing the ball with two hands without using the trunk Each laboratory is given three attempts to score the best.
- Scoring: The distance between the front edge of the chair and the closest point the ball makes on the floor is calculated.

#### **From the front support position, bend the arms and extend them in (10) seconds<sup>5</sup>**

- The purpose of the test: to measure the velocity characteristic of the muscles in the arms.
- Tools used: a verifier to evaluate and calculate the correct attempt, stopwatch.
- Performance description: From the front stand position, the tester bends the elbows until it touches the ground with the chest, then returns again to the stand. The performance is repeated as many times as possible within (10) seconds according to the specified conditions.
- It is not allowed to stop during the test.
- The body must be straight during the performance.
- The necessity to bend the elbows completely and extend them to their maximum extent
- Any violation of the conditions, the attempt will be canceled
- Recording: Counts the number of times the correct performance is repeated within (10) seconds.

**Pilot Study:** In order to identify the positive and negative aspects that may appear in the future and for the purpose of avoiding them and developing, deleting or modifying some research steps and to ensure the suitability of the proposed period of time for the rehabilitative unit and for the purpose of ensuring the safety of the work of devices and tools and identifying the validity of the measurements and tests used in the research and the ability of the researcher and the work team on its performance and implementation, the researcher conducted a preliminary exploratory experiment on a sample of (2) individuals from infected patients on Saturday (4/5/2019). When conducting the pilot experiment, the same conditions and conditions as the main experiment must be met as much as possible so that Taking its results .<sup>6</sup>

**An exploratory experiment was conducted as follows:**

1. An exploratory experience to see the success of the tests in the curriculum, validity, equipment and tools, their safety, and the assistant staff.
2. Knowing the difficulties and obstacles that the researcher may face while applying the exercises.
3. Making some adjustments to the vocabulary of the rehabilitation curriculum in terms of repetition and sequence of rehabilitative exercises placed therein.
4. Conducting a rehabilitation unit to know the time and recurrence.

**Pre-tests:** The researcher conducted the pre-tests procedures (before the rehabilitative curriculum) after taking the magnetic resonance rays and then determining the severity of the injury by reading the resonance by a specialist doctor. The pre-tests were done on Thursday 9/5/2019 at exactly five o'clock in the afternoon in Wasit Stadium on the search group after That the test is shown to the research sample in order to obtain all the variables through performance.

**The proposed rehabilitation curriculum (the main experiment):** The researcher prepared the rehabilitative exercises using the proposed device and using multiple means and added weights (weights) for a period of two months and at three rehabilitative units per week, then he presented them to the experts to see the suitability of the exercises that he applied to the injured:

- The prepared rehabilitation curriculum includes performing exercises to rehabilitate shoulder

joint injuries. The purpose of these exercises is to rehabilitate the deltoid muscle of the shoulder joint as well as increase the range of motion and try to return the range of motion to the normal range and in all directions of movement.

- The researcher took into account the principle of a gradual increase in the resistance position, from easy to difficult, by using passive exercises at the beginning of the curriculum (the first week), then gradually increasing the difficulty of exercises in the following weeks, using self-resistance exercises (weight and body parts) with the development of external resistances.
- The rehabilitative unit included physical exercises and the exercises were using body weight and weights, and the focus was on the use of resistance and then exercises using medical balls in order to give the body an opportunity and sufficient time to recover from the injury before the injured muscle returns to its normal state before the injury as much as possible and to engage in any physical activity that requires effort. Physical level of intensity, in addition to performing various movements in different directions that would give the injured shoulder joint the ability to restore the normal range of motion that was determined by the injury, especially when the members of the sample are among the players who suffer from a specific injury, as for physical exercises The researcher was keen on preparing a method that would rehabilitate the working muscles on the shoulder joint in general and the deltoid muscle in particular, and it depends on the strength and flexibility of the muscles working on it. The exercises to increase the range of motion and rehabilitate the working muscle that are very necessary in sports such as tennis, badminton, handball and swimming,<sup>7</sup> the researcher took care of the diversification and change in the rehabilitative exercises used in terms of the type of exercises and their basic conditions.

**The content of the rehabilitative exercise was:**

1. The exercises included work on pain control, rehabilitation of injured tissues, and focus on correcting joint function and returning to normal position.
2. The difficulty of rehabilitative exercises was adopted from (50%) to the arrival of the injured similar to severe recovery (80%) for strength and range of

motion exercises, and the number of repetitions and groups depending on the source .<sup>8</sup>

3. The time period for implementing the rehabilitative exercises amounted to (8) consecutive weeks.
4. The number of rehabilitative units per week reached (3) sessions on (Saturday, Monday, and Wednesday) days of the week.
5. The total number of college rehabilitative units (sessions) is (24) rehabilitative units.
6. The rehabilitation unit time (30) minutes.

**Post test:** After the end of the qualifying curriculum, the post-test was conducted on the research sample on Thursday 4/7/2019 at 5 p.m., taking into account the same pre-test conditions on a laboratory, as the researcher was keen to create the same conditions for testing in terms of time and place and the assistant work team Same (in the pre and post tests), tools and devices in order to fix the variables as much as possible.

### Statistical method:

The researchers used the social statistical bag (SPSS) to calculate each of the values of:

- Mean .
- Mediator .
- Standard deviation .
- Coefficient of torsion.
- t-test for cross-linked samples.

### Results and Discussions

Presentation and analysis of the results of the pre and post test for the range of motion and physical tests of the deltoid muscle of the shoulder joint for the research group

**Table 2. Shows the means, standard deviations, and the calculated value (t) and the significance of the kinematic and physical range test for the pre and post tests.**

Variables	Measuring unit	Pretest		Posttest		p	Pe	(t) Calculated	Moral value	Indication
		Mean	St.d	Mean	St.d					
Tide forward shoulder	Cm	17	1.826	22.75	1.708	5.75	1.258	9.139	0.003	Moral
Shoulder movement	Cm	35	3.559	39.75	3.304	4.75	1.708	5.563	0.011	Moral
Explosive force	Mater	4.613	0.395	5.261	0.263	0.64	1.649	3.724	0.014	Moral
Fast power	Number	6.416	0.523	7.816	0.447	1.4	1.716	3.355	0.035	Moral

Significance when (Sig)> (0.05), degree of freedom (n - 1) = 4 - 1 = 3, significance level (0.05)

Table (2) shows us the values of the mean and the standard deviation and the extent of their difference before and after the implementation of the rehabilitative curriculum for the tests of the normal range of motion and the muscle strength of the deltoid muscle of the shoulder joint, which indicates that the differences are in the post test, meaning that there is an effect of the experimental variable, and to know the truth of this Change and its statistical significance The researcher used the (t) test for the correlated samples, as we find that the mean of the tide variable forward in the pre-test reached (17) with a standard deviation (1.826), while the mean in the post test reached (22.75) and with a standard deviation (1.708). The calculated value of (t) reached (9.139), which is greater than its tabular value of

(3.182) under the level of significance (0.05) and at the degree of freedom (3), which indicates the existence of a significant difference between the pre and post tests and in favor of the post test.

Table (2) shows us that the mean of the outward tide variable in the pre-test reached (35) with a standard deviation (3.559), while the mean in the post test reached (39.75) and with a standard deviation (3.304), and the calculated value of (t) reached (5.563) and it is greater than its tabular value of (3.182) below the level of significance (0.05) and at the degree of freedom (3), which indicates the existence of a significant difference between the pre and post tests and in favor of the post test.

While we find that the mean of the variable (explosive power) in the pretest was a value of (613.4) and a standard deviation of (395.0), while we find that the mean in the post test of the variable itself was a value (261.5) and a standard deviation of (263.0), and when calculating the value of (t), we find it with a value of (724.3) and since the statistical significance is (014.0) and it is less than the level of significance (05,0), this indicates the presence of significant differences between the pre and post tests and in favor of the test Post. Whereas we find that the mean of the variable (force characterized by velocity) in the pre-test was the value (416.6) and a standard deviation of (523,0), while we find that the mean in the post test of the variable itself was the value (816,7) and a standard deviation Its value is (047,0) and when calculating the value of (t), we find it with a value of (355,3), and since the statistical significance is (013,0) and it is less than the level of significance (05,0), this indicates the presence of significant differences between the pre and post tests For the benefit of the post test.

By looking at the results of Table (2), the two researchers note that there are differences in the mean between the two pre and post tests in the variables of the kinematic range (extension backward, forward bending, transmission) for the research group and in favor of the post test compared to the pre-test, <sup>9</sup>“That the increased range of motion means an improvement in the elasticity of the muscles and ligaments surrounding the joint as well as an improvement in the work of the neuromuscular in controlling the work of the sensors responsible for providing the sensory information to the brain about this range.”<sup>10</sup> From here as if the proposed device and the application of applied exercises prepared have a positive effect in improving The kinematic ranges of the corners of the shoulder joint and its reflection on their athletic level, their return to the fastest period of time, and their activity again, “It is necessary to obtain a situation in which the main parts of the body are balanced and regular above the fulcrum and the organizational relationship between these parts Sound so that it can carry out its functions efficiently and with less effort”.<sup>11</sup>

By reviewing the results, the researcher found that the improvement between the pre-test and the post test led to a remarkable improvement in the forward bending test, which the researcher attributes to that the rehabilitative exercises that contain different types of method of developing the range of motion before exercises of fixed and moving flexibility and the work of these exercises slowly and broadly Mobility helped in

obtaining these results as (obtaining sufficient flexibility for the muscles, tendons, and ligaments of a particular joint or a group of joints in a particular movement or activity depends on the amount and intensity of the exercises that perform in a wide range of movement as well as on the degree of flexibility acquired prior to the individual) .<sup>12</sup>By reviewing the results, the researcher found that the significant change in the range of motion and passing most of the variables to the minimum range of the ideal range of motion to the effectiveness of the rehabilitative exercises on the proposed device in rehabilitating the affected area of the deltoid muscle because the exercises increase the body’s flexibility and activity and increase the neuromuscular compatibility .<sup>13</sup>

We also note that the development of force resulted from the use of auxiliary means, where the researcher used, in addition to gradual physical pregnancy and exercises using weights gradient in the last weeks of the curriculum, which had a clear effect on the development and increase of strength. Future progress will be linked first of all, not to an increase in training reluctance. It will relate to the most effective selection of training method and how to focus on synthesizing training doses that achieve the best results, and this in itself will require accurate knowledge of the vital effects of the exercises used in training”.<sup>14</sup>

## Conclusions

1. Rehabilitation exercises have an effect by restoring the normal range of motion and flexibility of the deltoid muscle of the shoulder joint among the subjects of the research sample.
2. The development in the motor ranges of the shoulder joint is related to the disappearance of pain. Therefore, the positive effect of the rehabilitative approach in reducing or eliminating pain resulted in a clear improvement in the range of motion.

**Ethical Clearance:** The Research Ethical Committee at scientific research by ethical approval of both MOH and MOHSER in Iraq.

**Conflict of Interest:** None

**Funding:** Self-funding

## References

1. Abdel-Rahman Issawi: Measurement and Experimentation in Psychology and Education, Beirut, Dar Al-Nahda Al-Arabiya, 1974.

2. Ahmad Al-Sabahi Awadallah: Sports Health and Physiotherapy, Beirut, Saida, Al-Asriyya Library, 1973.
3. Hamill, Joseph; Knutzen, Kathleen M, Biomechanical Basis of Human Movement, 3rd Ed, Copyright, Lippincott Williams & Wilkins, 2009.
4. Ibtihaj Rifaat: Proposed Training Requirements and Their Impact on Some Functional Variables and Measures for the Left Ventricle, Master Thesis, University of Baghdad, College of Physical Education and Sports Sciences, 2001.
5. K. Lee Lerner and Brenda Wilmoth Lerner, World of sports science, editors. r, Library of Congress Cataloging-in-Publication. 2007.
6. Muhammad Hassan Allawi and Muhammad Nasreddin Radwan: Kinetic Performance Tests, 1st Edition, Cairo, Arab Thought House, 1982.
7. Resan Khuraibet, Abu El-Ela Abdel Fattah: Sports Training, 1st floor, Cairo, The Book Center for Publishing, 2016.
8. Sakina Kamil Hamza Al-Jarallah: The Impact of a Proposed Rehabilitation Approach in the Treatment of Some Soft Tissue Injuries in the Shoulder Joint: PhD Thesis, Iraq, University of Babylon, College of Physical Education, 2006.
9. Sarih Abdul Karim Al-Fadhli, Abdul Razzaq Jaber Al-Majdi: Functional Anatomical Analysis and Mechanics of Sports Games, 1st Edition, Adnan House for Printing, Publishing and Distribution, Baghdad, 2017.
10. Sorour Asaad Mansour: Texture, its defects and deformities, means of treatment and method of preserving it: (Cairo, Dar Al Maarif, 1985).
11. Wadih Yassin Al-Tikriti, Yassin Taha Al-Hajjar: Physical Numbers for Women, University of Mosul, Dar Al-Kutub for Printing and Publishing, 1986.
12. Fouad Al-Samarrai, Hashem Al-Samarrai: Sports Injuries and Physical Therapy, 1st Edition, Jordan, Amman, Middle East Printing Company, 1988.
13. Athab NA, Hussein WR, Ali AA. A Comparative Study for Movement of Sword Fencing Stabbed According to the Technical Programming in the Game of Fencing Wheelchairs Class B. Indian Journal of Public Health Research & Development. 2019;10(5):1344-7.
14. Athab NA. An Analytical Study of Cervical Spine Pain According to the Mechanical Indicators of the Administrative Work Staff. Indian Journal of Public Health Research & Development. 2019;10(5):1348-54.
15. Alsayigh HA, Athab NA. The Study of Rectus Femoris Activity after Knee Joint Rehabilitation. International Journal of Pharm Tech Research. 2016;9(9):360-5.
16. Alsayigh HA, Athab NA, Firas M. The Study of Electrical Activity of the Triceps Brachia Muscle according to the Chemical Changes of Water Loss during Spike in Volleyball. Journal of Global Pharma Technology. 2017:57-62.
17. Athab NA, Hassan AA. Analysis Study to the Joint Pain of Knee with Indication of Loading Mechanics for Players the researchers. 2010.



# Human Folate Receptor-1 Gene Expression and Correlation with Physiological Leptin hormone in Obese and Non-obese Subjects

Areej GH Al-Charak<sup>1</sup>, Hawraa H. Naji<sup>2</sup>, Hamzah H. Kzar<sup>2</sup>

<sup>1</sup>Assis. Prof., Department of Physiology, Pharmacy, and Chemistry, Veterinary Medicine, Al-Qasim Green University, Iraq, <sup>2</sup>Lecturer, Department of Physiology, Pharmacy, and Chemistry, Veterinary Medicine, Al-Qasim Green University, Iraq

## Abstract

**Background:** One of the most important agents that must be found in all dividing cells is folate.

**Aim:** Assessment of human folate receptor-1 gene expression and correlation with leptin hormone in obese and non-obese subjects of Babylon province, Iraq.

**Subjects and Method:** This study included 60 obese subjects (OS) in the range of age (10-45 years) and 30 normal weight subjects (NOS) in range age of (11-43 years). FOR-1 gene expression were assessing by qRT-PCR after RNA extraction from fresh blood of all obese and normal subjects and immediately converting into cDNA. Leptin was assessed by ELISA method.

**Results:** The results suggesting that founds the positive correlation ( $r^2=0.447$ ) between ages of OS and levels of LEP (ng/ml). The results of this study showed significant differences ( $p\text{-value}<0.05$ ) in levels of leptin (LEP) between OS and NOS groups. The results showing that the FOR-1 gene expression ratio in NOS compare to expression OS were 11.9 and 7.1.

**Conclusion:** FOR-1 have a higher expression in OS compare to NOS and this may be useful in diagnostic and therapeutic tools in diseases or cancers in OS.

**Keywords:** Obese subject, non-obese subject, leptin, folate receptor-1, SNP.

## Introduction

A complex, multifactorial, and largely preventable disease is called obesity<sup>[1]</sup>. It is typically defined quite simply as excess body weight for height and this simple definition contradict with an etiologically complex phenotype primarily associated with excess adiposity, or body fatness, that can manifest metabolically and not

just in terms of body size<sup>[2]</sup>. One of the most important agents that must be found in all dividing cells is folate. It is one of the importance factors from providing methyl groups for remethylation of homocysteine (Hcy) to methionine and through Sadenosylmethionine (SAM) for one-carbon metabolism, providing cofactors for the synthesis of purines, phospholipids, and certain amino acids<sup>[3]</sup>. Kamen B et al (2004) has been reported that the folate receptor-1 (FOR-1) has high affinity for serum folate by 100-200 times than reduced folate carriers<sup>[4]</sup>. The gene for folate receptor, named FOLR1, consists of seven exons and spans over 6.7 kbp<sup>[5]</sup>. The polypeptide hormone that is produced by adipose tissues in proportion to their triglyceride content, links changes in body energy (fat) stores to adaptive responses in the central control of energy balance<sup>[6]</sup>. The major physiologic role

---

### Corresponding Author:

**Hamzah H. Kzar**

Lecturer, Department of Physiology, Pharmacy, and Chemistry, Veterinary Medicine, Al-Qasim Green University, Iraq

e-mail: hamza14shukri72@gmail.com

of LEP is to respond to and defend against reductions of body fat (and thus leptin) that might impair survival and reproductive fitness, evolutionary considerations, together with a large body of experimental data, indicate that<sup>[7]</sup>. The aim of this work is assessment of human folate receptor-1 gene expression and correlation with leptin hormone in obese and non-obese subjects of Babylon province, Iraq.

### Material and Method

**Study Design:** This study included 60 obese subjects (OS) in the range of age (10-45 years) and 30 normal weight subjects (NOS) in range age of (11-43 years). FOR-1 gene expression were assessing by qRT-PCR after RNA extraction from fresh blood of all obese and normal subjects and immediately converting into cDNA.

**Determination of LEP hormone levels:** LEP levels were measured by using ELISA kit and the method performed depending on the manufacturer’s protocol.

**Gene expression analysis:** PCR was carried out in a total volume 25 µl of reaction mixture with Taqman polymerase and carried by the thermocycler (Exycycler 96, bioneer, Korea) and subjected to denaturation at 95 C° for 3 min, followed by 30 cycles of 95 C° for 20 sec, 58.5 C° for 45 sec and the final extension phase at 72 C° for 7 min.

### Results

Clinical characteristics of OS group is shown in table 1:

**Table 1: Clinical characteristics of Obese Subject group**

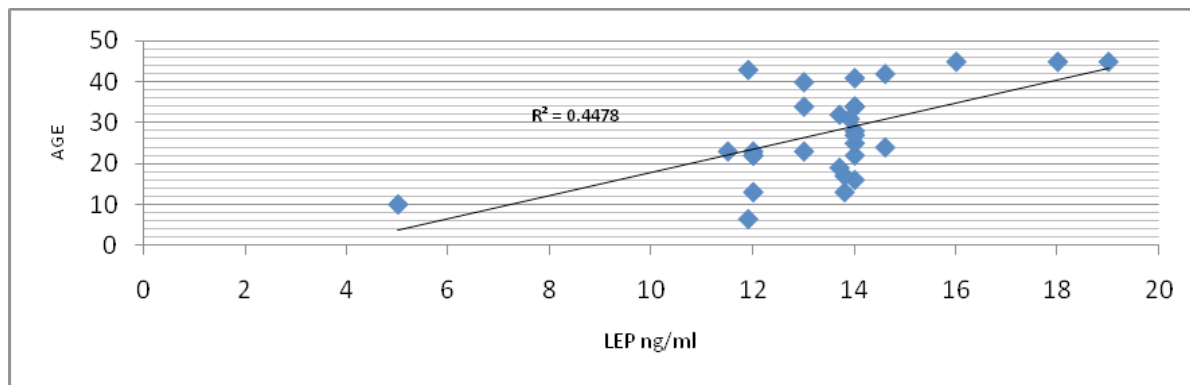
Clinical Variables	No. Total=60	Percentage (%)
<b>Age</b>		
10-25	22	37
26-45	38	63
<b>Gender</b>		
Male	37	62
Female	23	38
<b>Education status</b>		
Yes	29	48
No	31	52
<b>Dwelling</b>		
Rural	33	55
Urban	27	45

The results of this study showed significant differences (p-value< 0.05) in levels of leptin (LEP) between OS and NOS groups, as show in table 2:

**Table 2: LEP levels in study groups**

Groups	LEP (ng/ml) Mean± SD	P-value
<b>OS</b> n = 60	17.9±1.7	0.0000
<b>NOS</b> n = 30	11.9±1.3	

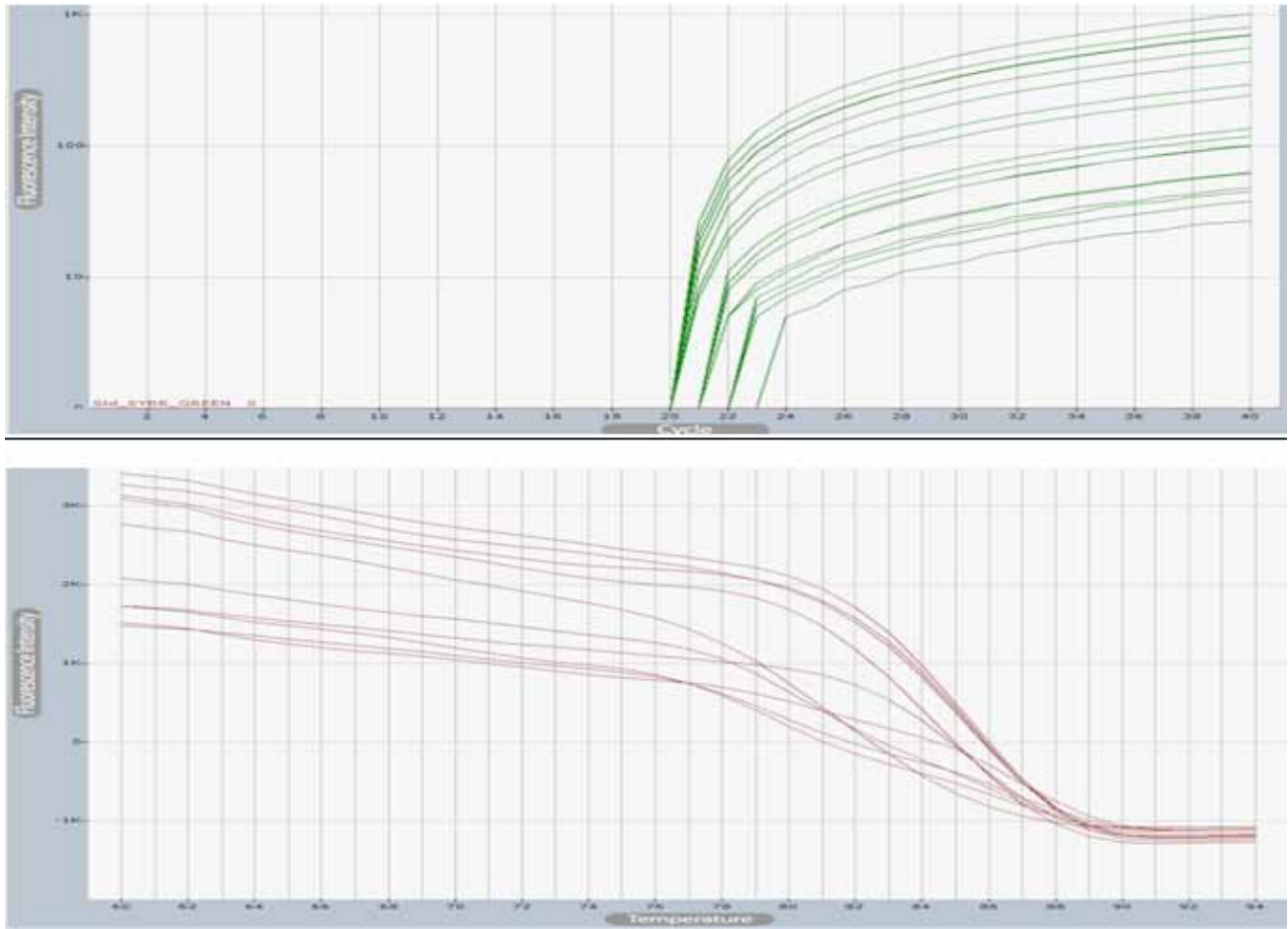
The results suggesting that founds the positive correlation (r<sup>2</sup>=0.447) between ages of OS and levels of LEP (ng/ml), as shows in figure 1:



**Figure (1): Correlation between ages of OS with LEP levels**

The gene expression analysis of target and reference genes based on estimation of threshold value (Ct) for real amplification of gene of interest (GOI), FOR-1 (Genbank ID: NM2348, 6614 nucleotides) and housekeeping gene (HKG), GAPDH (Genbank ID: NM\_002046, 1005

nucleotides) in OS and NOS groups. The Ct value was calculated as average of triplicate, The amplification and melting curves of FOR-1 gene expression is shown in figure 2:



**Figure 2:**The amplification and melting curves of FOLR-1 gene expression in OS and NOS groups

The results showing that the FOR-1 gene expression ratio in NOS compare to expression OS were 11.9 and 7.1. is show in table 3:

**Table 3:** FOR-1 gene expression ratio in OS compare to expression NOS

Gene	Type of case	Efficiency %	GEF	p-value
FOR-1/GAPDH	OS	80	7.1	0.000
FOR-1/GAPDH	NOS	93	11.9	

**Discussion**

The tumor-associated antigen that binds folate and folate drug conjugates with very high affinity and shuttles is FOLR-1 and these bound molecules inside cells via specific way called an endocytic mechanism<sup>[8]</sup>.

Folate Receptor-1 (FOR-1), Proton Coupled Folate Transporter (PCFT), and Reduced Folate Carrier (RFC) are the cellular uptake of folate considered a specific transport mechanisms<sup>[9]</sup>. The receptor-mediated endocytosis/exocytosis is FOR-1 transporter for folate and functions at a neutral to mildly acidic pH. The

mediates of the co-transport PCFT, has optimal activity at low pH and, accounts for the low pH folate transport activity in the intestine<sup>[10,11]</sup>. This study not agree with study carried by *Carter et al., 2011* that say that fetal folate concentrations were similar in obese women as compared with normal weight women. Protein expression of FOR-1 in microvillus membranes was increased (+173%), in RFC was decreased (-41%), and in PCFT was unchanged. However, activity of FOR-1, PCFT, and RFC was unaltered in obesity<sup>[12]</sup>. The results of this study showed significant differences (p-value < 0.05) in levels of leptin (LEP) between OS and NOS groups. *Myers et al., 2010* give an example is the finding that leptin overexpression in OS, which initially promotes leanness, results in increased adiposity in the long-term and this not agreement with the results of present study<sup>[13]</sup>. The following up of obese subjects more easy by estimation the LEP hormone and this agree with study that say of the progression and responding to chemotherapy treatment may be more easy by estimation the glucose transporting, angiogenesis, and apoptotic markers in women with BC<sup>[14]</sup>. Moreover, this study suggested that higher levels of LEP are associated with increased folate receptor gene expression in obese subjects. The results also showing that the FOR-1 gene expression ratio in NOS compare to expression OS were 11.9 and 7.1. In conclusion the results suggested that FOR-1 have a higher expression in NOS compare to OS and this may be useful in diagnostic and therapeutic tools in diseases or cancers compare to NOS.

**Ethical Clearance:** The Research Ethical Committee at scientific research by ethical approval of both MOH and MOHSER in Iraq

**Conflict of Interest:** None

**Funding:** Self-funding

### References

1. Hruby, A., & Hu, F. B. The Epidemiology of Obesity: A Big Picture. *Pharmacoeconomics*, 2015; 33(7), 673–689.
2. Hu FB. Obesity epidemiology. Oxford University Press; Oxford; New York.: 2008;498.
3. Frosst P, Blom HJ, Milos R, et al. A candidate genetic factor for vascular disease: a common mutation in methylenetetrahydrofolate reductase. *Nat Genet*. 1995; 10: 111-113.
4. Kamen BA and Smith AK. A review of folate receptor alpha cycling and 5-methyltetrahydrofolate accumulation with an emphasis on cell models in vitro. *Adv Drug Deliv Rev*. 2004;56:1085-1097.
5. Elwood PC, Nachmanoff K, Saikawa Y, et al. The divergent 5' termini of the alpha human folate receptor (hFR) mRNAs originate from two tissue-specific promoters and alternative splicing: characterization of the alpha hFR gene structure. *Biochemistry*. 1997;36: 1467-1478.
6. Myers MG, Jr, Munzberg H, Leininger GM, Leshan RL. The geometry of leptin action in the brain: more complicated than a simple ARC. *Cell Metab*. 2009;9:117–123.
7. Schwartz MW, Woods SC, Porte D, Jr, Seeley RJ, Baskin DG. Central nervous system control of food intake. *Nature*. 2000;404:661–671.
8. Zhao R, Matherly LH, Goldman ID. Membrane transporters and folate homeostasis: Intestinal absorption and transport into systemic compartments and tissues. *Expert Rev Mol Med*. 2009; 28,11:4.
9. Qiu A, Jansen M, Sakaris A, Min SH, Chattopadhyay S, Tsai E, et al. Identification of an intestinal folate transporter and the molecular basis for hereditary folate malabsorption. *Cell*. 2006; 1;127(5):917–28.
10. Yasuda S, Hasui S, Yamamoto C, Yoshioka C, Kobayashi M, Itagaki S, et al. Placental folate transport during pregnancy. *Biosci Biotechnol Biochem*. 2008;72(9):2277–84.
11. Henriques C, Trugo NM. Partial characterization of folate uptake in microvillous membrane vesicles isolated from human placenta. *Braz J Med Biol Res*. 1996;29(12):1583–91.
12. Carter MF, Powell TL, Li C, et al. Fetal serum folate concentrations and placental folate transport in obese women. *Am J Obstet Gynecol*. 2011;205(1):83.
13. Myers, M. G., Jr, Leibel, R. L., Seeley, R. J., & Schwartz, M. W. Obesity and leptin resistance: distinguishing cause from effect. *Trends in endocrinology and metabolism*, 2010; 21(11), 643–651.
14. Hamzah H. Kzar, Moshtak A. wtwt, Moaed E. Al-Gazally (2020). Study the Glucose Transport, Angiogenesis and Apoptosis Behavioral through Chemotherapy Treatment According to Receptors Status in Women with Breast Cancer. *Indian Journal of Forensic Medicine & Toxicology*, 2020;14(3), 2555-2559.

# EV Targeting MCF-7 Breast Cancer Cell Lines Inhibit Both mTOR and HIF-1A: Molecular Docking Study

Haider O. Mossa Al-Gazali<sup>1</sup>, Hamzah H. Kzar<sup>2</sup>, Moshtak A. Wtw<sup>3</sup>, Moad E. Al-Gazally<sup>4</sup>

<sup>1</sup>Dr. Ministry of Health, Al-Qasim General Hospital, <sup>2</sup>Lecturer, Veterinary Medicine Collage, Al-Qasim Green University, Iraq, <sup>3</sup>Prof., Collage of Medicine, University of Babylon, Iraq, <sup>4</sup>Prof., Collage of Medicine, Babylon university (Work Now at University of Al-Ameed), Iraq

## Abstract

**Background and Objective:** The mortality dramatically increase in breast cancer are caused by inadequate of the benefits of different types of therapies. mTOR is an atypical serine/threonine protein kinase that belongs to the phosphoinositide 3-kinase (PI3K)-related kinase family. The aim of this study to investigation of ability of EV to inhibiting both mTOR and HIF-1A through MCF-7 BC cell lines targeting and docking study by specific computational program.

**Method:** In vitro cytotoxicity study of different doses of EV were quantitatively measured by employing on MCF-7 cell lines. Docking study was done by computing 3D programs (in silico), the information in protein data bank (PDB) Zinc15docking and phyre2 protein homology tools.

**Results:** There was another suggestion for inhibition of HIF-1A protein (PDB reference code 4AJY) by incubation of MCF-7 cells with 5 mg/day of EV that is may be binding of EV as analogue in other sites differs from active site and may be stimulate the hydroxylation and acetylation of the protein and enhanced normal degradation pathway.

**Conclusion:** This study suggesting the mechanism of inhibition of HIF-1A by EV in addition to inhibition of mTOR pathway.

**Keywords:** Breast Cancer, mTOR, HIF-1A, Everolimus, Docking.

## Introduction

Mammalian target of rapamycin (mTOR) is a protein kinase that regulates proteinsynthesis and cell growth in response to growth factors, nutrients, energy levels, and stress<sup>[1]</sup>. mTOR is an atypical serine/threonine protein kinase that belongs to the phosphoinositide 3-kinase (PI3K)-related kinasefamily and interacts with several proteins to form two distinct complexes named mTORcomplex 1 (mTORC1) and

2 (mTORC2)<sup>[2]</sup>. The mTOR signaling pathway plays an essential role in cell growthand proliferation by coordinating anabolic processes with oxygen,energy and nutrient availability, as well as extracellular cues. One fundamental characteristic of cancer cells resides in their ability to sustain chronic proliferation in the absence of growth-promoting signals. This proliferative advantage is achieved, at least in part, by genetic events that cause aberrant activation of mTORC1 signaling<sup>[3]</sup>. Indeed, mTORC1 lies downstream of the Ras/MAPK and PI3K/Akt signaling pathways, where gain-of-function mutations in Ras, Raf, PI3K and Akt oncogenes, and loss-of-function mutations in the tumor suppressors neurofibromatosis-related protein-1 (NF-1), phosphatase and tensin homolog (PTEN) are found in up to 80% of human cancers<sup>[4]</sup>. The majority of catalytic mTOR inhibitors is currently in phase I clinical trial,

---

### Corresponding Author:

**Hamzah H. Kzar**

Lecturer, Veterinary Medicine Collage, Al-Qasim Green University, Iraq

e-mail: hamza14shukri72@gmail.com

and these compounds are being tested as single agents or in combination with other chemotherapeutic agents. Currently, these compounds are being tested against several types of cancer, including breast cancer, endometrial cancer, non-Hodgkin lymphoma and advanced stages of solid tumors [5]. The HIF-1A subunit has two transactivation domains (TAD): NH<sub>2</sub>-terminal (N-TAD) and COOH-terminal (C-TAD). These two domains are responsible for HIF-1A transcriptional activity [6]. C-TAD interacts with co-activators such as CBP/p300 to modulate gene transcription of HIF-1A under hypoxia. N-TAD is responsible for stabilizing HIF-1A against degradation [7]. Moreover, all HIF-1A subunits are distinct from HIF-1B in that they all have an oxygen-dependent degradation domain (ODDD) overlapping N-TAD in their structures. This ODDD domain is important in mediating O<sub>2</sub> regulation stability [8]. Given that cells and organs need to adapt to changes in oxygen supply, it would not be surprising to find that a significant variety of the HIF-1 target genes are regulated in a tissue-specific manner. To date, there are more than 100 HIF-1A downstream genes identified with varying functions (Table 1.2). HIF-1A activates the expression of these genes by binding to HRE located in their enhancer and promoter regions [9]. Everolimus (RAD001 (40-O-(2-hydroxyethyl)-rapamycin)) (molecular weight, 958.2 g/mol) is an orally active derivative of rapamycin that inhibits the Ser/Thr kinase, mTOR [10]. The aim of this study is to investigate the ability of EV to inhibit both mTOR and HIF-1A through MCF-7 BC cell lines targeting and docking study by specific computational program.

## Materials and Method

### *In vitro* cytotoxicity effect of EV on MCF-7 BC cell lines.

- In vitro cytotoxicity study of different doses of EV were quantitatively measured by employing on MCF-7 cell lines.
- MCF-7 cells were cultivated in RPMI 1640 medium supplemented with 10% FBS and 1% penicillin/streptomycin, non-essential amino acids (0.1 mM), insulin (10 µg/mL) and sodium pyruvate (1 mM) at 37 °C in incubator with 5% CO<sub>2</sub>.
- The cells were seeded in 96-well plate for 1 day, 2 days, and 3 days and then the medium was changed with various concentrations of EV (1, 10, 20, 40, 100 mg/dl).
- In vitro cell viability was determined using the MTT assay as described in following:
 

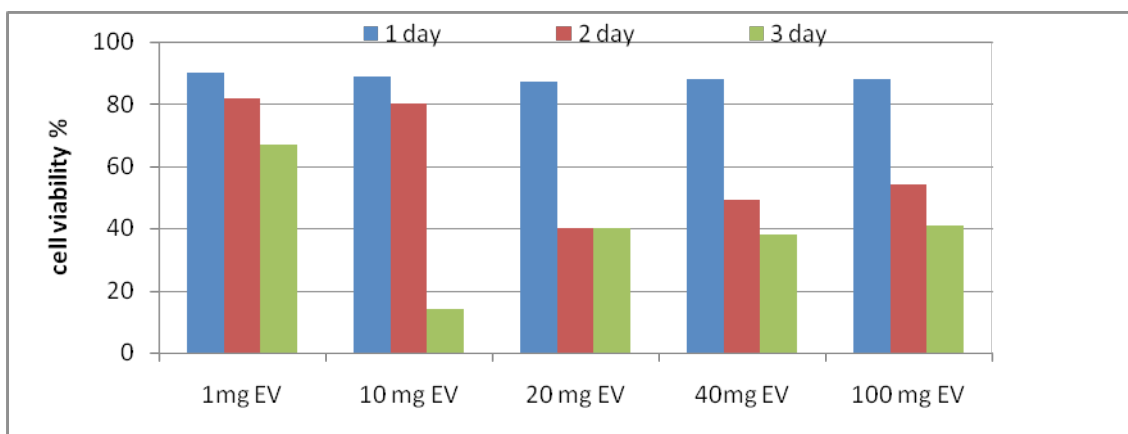
**MTT protocol (1 day):**

  - The cells (1 × 10<sup>4</sup> cells/well) were seeded in 96-well plate with culture medium in final volume of 100 µl/well.
  - The plate was incubated at 37°C (5% CO<sub>2</sub> incubator) for 1 day hr.
  - Cells were then treated with various conc. of EV for one day at 37°C in a 5% CO<sub>2</sub> incubator.
  - One hundred of fresh medium were added.
  - Ten µl of MTT reagent were added to each well of plate.
  - The plate was incubated at 37°C in a 5% CO<sub>2</sub> incubator for 4 hr.
  - The medium was carefully removed from wells.
  - Two hundred µl of DMSO was added to wells and mixed to dissolve all crystals and incubated for 30 min.
  - The absorbance has been read at 540 nm.
  - Untreated cells represent the control cells (not exposed to EV).

Percentage of viability and cytotoxicity  
**Cell viability (%) = (Abs<sub>540</sub> Treated cells / Abs<sub>540</sub> Control cells) × 100, Cytotoxicity (%) = 100 - Cell viability%**

## Results and Discussion

**Cytotoxicity study:** Figure 1 showing the MCF-7 cell viability % between EV at given concentrations and control during 1, 2, and 3 days of period of incubation:



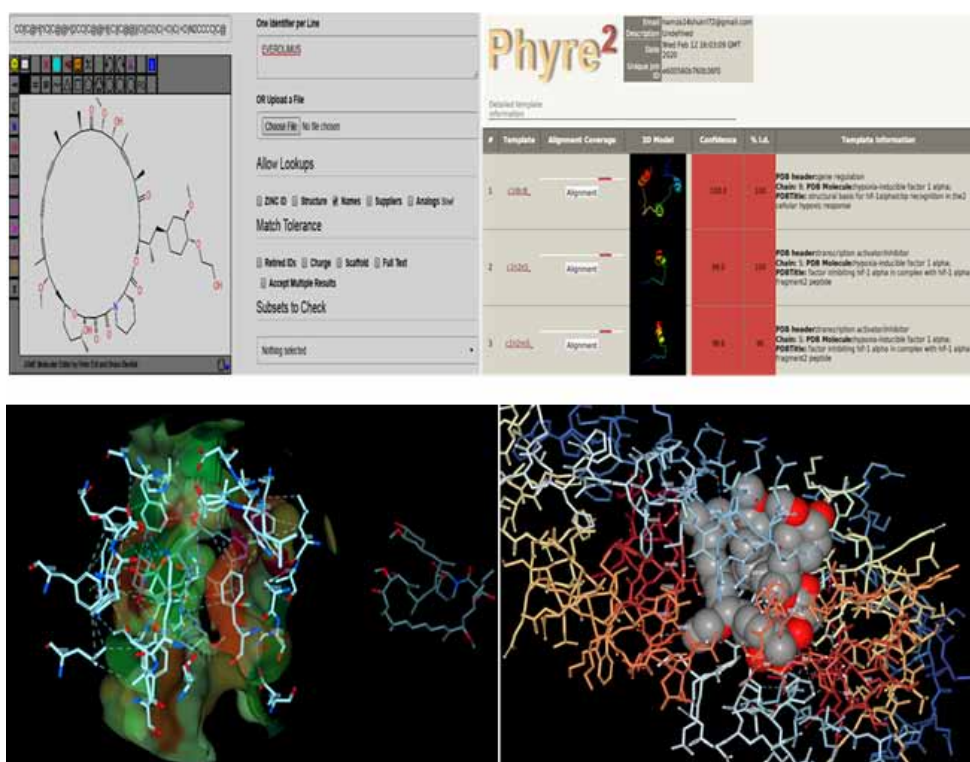
**Figure (1): Viability of MCF-7 BC cell lines cultured with EV in different conc. at 1, 2, and 3 days incubation time, the values are mean (n=3) ± SD.**

MTT assay is one of the common assays used to study cell viability and proliferation. It depends on the ability of viable cells to reduce the yellow MTT dye to insoluble purple formazan crystals. Here, MTT assays were used to study the anti-proliferative activity of EV on MCF-7 cell lines. The results of present study showing that no statistical differences in cell viability % when incubation of EV free with MCF-7 cell lines at one and second day of period of incubation ( $92 \pm 5$ ,  $82 \pm 4$ ) ( $p$ -value  $> 0.05$ ), but the results show significant differences between one and third day of incubation time ( $91 \pm 2$ ,  $65 \pm 3$ ) ( $p$ -value  $< 0.05$ ). The results also showing highly statistically differences in cytotoxicity% when incubation 10 mg of EV with MCF-7 BC cell lines at three day of incubation ( $10 \pm 1$ ) ( $p$ -value  $< 0.001$ ). The chemical structure of EV has more than one hydroxyl groups and this may be facilitated of binding with HIF-1A leading to inhibitory effects. It was reported by *Greenberger L et al.*, (2008) that inhibition of HIF-1A by EZN-2698 attenuates HIF-1A protein level and tumor progression in various in vitro (human prostate and glioblastoma cell lines) and in vivo studies<sup>[11]</sup>. *Georgina N et al.*, (2015) were reported anthracyclines are the potent well-known chemotherapeutic agents, also act as HIF-1A inhibitors by preventing to binding with DNA<sup>[12]</sup>. Another novel class of molecularly targeted anticancer agents consists of inhibitors of heat shock protein 90 (HSP90),

such as geldanamycin, 17-allylamino-geldanamycin (17-AAG) and 17-dimethylaminoethylamino-17-demethoxygeldanamycin, which target HIF-1A for proteasomal degradation<sup>[13]</sup>. A number of HIF-1A inhibitors have been synthesized or discovered for treating cancer, particularly for advanced and refractory solid tumors. They inhibit the expression and/or functions of HIF-1A through direct and indirect mechanisms.

### Molecular docking study

By application molecular docking study and Ligand-based drug design (protein-ligand interaction) of online computing 3D programs (in silico) (<https://www.rcsb.org>), the information in protein data bank (PDB) (<https://www.pdb.org/>), <https://pubchem.ncbi.nlm.nih.gov>, Zinc15.docking and phyre2 protein homology tools there was another suggestion for inhibition of HIF-1A protein (PDB reference code 4AJY) that is may be due to binding of EV as analogue in other sites differs from active site and may be stimulate the hydroxylation and acetylation of the protein and enhanced normal degradation pathway or may be formation the HIF-1A-EV complex that preventing of translocation of HIF-1A into nucleus to binding with HIF-1B and in turn inhibition the controlling of HIF1A-HIF-1B dimer on gene expression of target genes, as showing in figure 1:



**Figure (1): A-Zinc15. docking website for drawing EV structure B-Phyre2 protein homology tool results**

The amino acids sequence of HIF-1A protein is shown in figure 2:

```

10      20      30      40      50
MEGAGGANDK KKISSERRKE KSRDAARSRR SKESSEVFYEL AHQLPLPHNV
60      70      80      90     100
SSHLDKASVM RLTISYLRVR KLLDAGDLDI EDDMKAQMC FYLKALDGFV
110     120     130     140     150
MVLTDGDMI YISDNVNYM GLTQFELTGH SVFDFTHPCD HEEMREMLTH
160     170     180     190     200
RNLVKKGKE QNTQRSFFLR MKCTLSRGR TMNIKSATWK VLHCTGHIHV
210     220     230     240     250
YDTNSNQPC GYKPPMTCL VLIPEIPHP SNIEIPLDSK TFLSRHSLDM
260     270     280     290     300
KFSYCDERIT ELMGYEPEEL LGRSIYEVYH ALDSHDLTKT HHDMFTKGQV
310     320     330     340     350
TTGQYRMLAK RGGYVWVETQ ATVIYNTKNS QPQCIVCVNY VVSGIIQHDL
360     370     380     390     400
IFSLQQTECV LKPVESDMK MTQLFTKVES EDTSSLFDKL KKEPDALTLL
410     420     430     440     450
APAAGDTIIS LDFGSNDTET DDQLEEVPL YNDVMLPSPN EKLQINILAM
460     470     480     490     500
SPLPTAETPK PLRSSADPAL NQEVALKLEP NPESLELSFT MPQIQDQTPS
510     520     530     540     550
PSDGSTRQSS PEPNSPSEYC FYVDSMVNE FKLELVEKLF AEDTEAKNPF
560     570     580     590     600
STQDLDLLE MLAPYIPMDD DFQLRSFDQL SPLESSASP ESASPQSTVT
610     620     630     640     650
VFQQTQIQEP TANATTTTAT TDELKTVT KD RMEDIKILIA SPSPTHIKKE
660     670     680     690     700
TTSATSSPYR DTQSRTASPN RAGKGVIEQT EKSHPRSPNV LSVALSQRTT
710     720     730     740     750
VPHEELNPKI LALQNAQRKR KMEHDGSLFQ AVGIGTLLQQ PDDHAATTS L
760     770     780     790     800
SWKRVKCKS SEQNGMEQKT IILIPSDLAC RLLGQSMDES GLPQLTSYDC
810     820
EVNAPIQGSR NLLQGEELLR ALDQVN
    
```

**Figure (2): Amino acids sequence of HIF-1A protein**



To date, no study have reported that HIF-1A are inhibit by EV. This study reported for the first time about the interactions between EV loaded NPs and HIF-1A. It can be concluded that EV loaded NPs had the potential of inhibiting HIF-1A activity. The molecular protein-ligand docking study suggestion that five amino acids participate in this interaction, the residues were (Asn 670, Phe 540, Val 599, Tyr 522, and Lys 629) participating in hydrogen bonding while the residues

(Thr 611, His 646, Lys 719, Trp 752) (4 bonds) forming van-der Waalsinteractions between protein (HIF-1A) and ligand (EV) with high binding energy -12.2334 kcal/mol. Active binding sites of EV and HIF-1A protein depending on type of interactions is shown in table-1:

Many of the novel anticancer drugs that target specific pathways have been shown to have anti-angiogenic effects that appear to be inhibition of HIF-1A activity, as shown in table-2:

**Table(1): Active binding sites of EV and HIF-1A protein depending on type of interactions**

Target protein (HIF1-A)	Active binding sites	Binding affinity energy
Hydrogen bonding	Asn 670, Phe 540, Val 599, Tyr 522, and Lys 629	-12.2334 kcal/mol
Van-der Waals interactions	Thr 611, His 646, Lys 719, Trp 752	

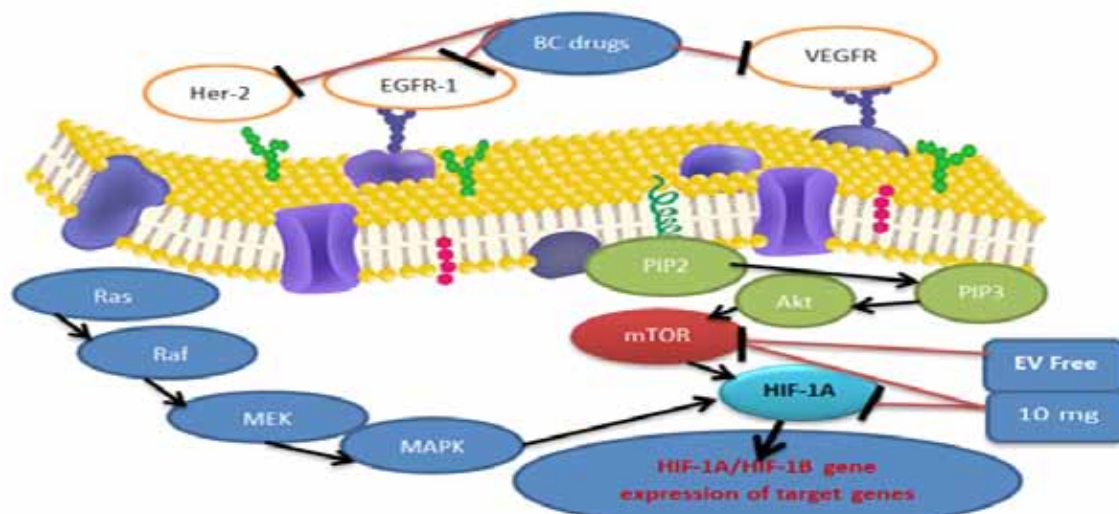
**Table (2): Selected drugs that inhibit HIF-1A activity**

Drug	Effect	Reference
Doxorubicin	Decreased HIF-1A DNA binding	[14]
Cetuximab	Decreased HIF-1A synthesis	[15]
Digoxin	Decreased HIF-1A synthesis	[16]
Trichostatin A	increased HIF-1A degradation	[17]
Allylaminogeldanamycin.	Decreased HIF-1A transactivation	[18]
Taxotere	Decreased HIF-1A synthesis	[19]
Bortezomib	Decreased HIF-1A transactivation	[20]
EZN-2968	Inhibit HIF-1A mRNA expression	[21]
Topotecan	Inhibit HIF-1A mRNA translation	[22]
Everolims	Inhibit HIF-1A mRNA expression	This study

In present study, when HIF-1A mRNA expression decreasing by incubation with EV (10 mg)and in results declines the levels of GLUT-1,CD44 and VEGF (the results not appear in this paper)<sup>[23]</sup>, and this means that the transcription process may be inhibited and all events after this may be not occurs. This events are due to blocking of proteins those responsible on transcription of HIF-1A mRNA such as transcription factors by EV and decrease levels of HIF-1A and in turn prevent translocation it to nucleus and don't binding with HIF-1B on its response elements on DNA. Other explanation is may be due to prevent the signals such as growth factors

to binding on its receptors on cell membrane by blocking this receptors and this need further investigations.

Cellular targets of biological signals in development for BC through hypoxia events. EV free can be inhibit of mTOR, EV loaded NPs can be inhibit of both mTOR and HIF-1A mRNA and protein and in turn controlling on gene expression of target genes through prevent the accumulation, translocation, and binding of HIF-1A with nucleus protein (HIF-1B). The suggested schematic diagram can be summarize all the findings elucidated by the current study, as shown in figure 3:



**Figure (3): Cellular targets of biological signals in development for BC through hypoxia events: EV inhibit both mTOR and HIF-1A.**

### Conclusion

Suggesting the mechanism of inhibition of HIF-1A by EV in addition to inhibition of mTOR pathway

**Data Availability:** The data used to support the findings of this study are available from the corresponding author upon request.

**Ethical Clearance:** The Research Ethical Committee at scientific research by ethical approval of both MOH and MOHSER in Iraq

**Conflict of Interest:** None

**Funding:** Self-funding

### References

- Meng D, Frank A & Jewell J. mTOR signaling in stem and progenitor cells. *Development* (Cambridge, England), 2018; 145(1), dev152595.
- Yang H, Rudge D, Koos J, Vaidialingam, B., Yang H and Pavletich N. mTOR kinase structure, mechanism and regulation. *Nature*, 2013; 497, 217–223.
- Guertin, D. A. and Sabatini, D. M. Defining the role of mTOR in cancer. *Cancer Cell*, 2007; 12, 9–22.
- Menon, S. and Manning, B. D. Common corruption of the mTOR signaling network in human tumors. *Oncogene*, 2008;27 (Suppl 2), S43–S51.
- Benjamin, D., Colombi, M., Moroni, C. and Hall, M. N. Rapamycin passes the torch: a new generation of mTOR inhibitors. *Nat. Rev. Drug Discov.*, 2011; 10, 868–880.
- Gilkes D, Xiang L, Lee S, Chaturvedi P, Hubbi M, Wirtz D, Semenza G. Hypoxia-inducible factors mediate coordinated RhoA-ROCK1 expression and signaling in breast cancer cells. *Proc. Natl. Acad. Sci. U.S.A.* 2014; 111: 384–393.
- Shafit-Zagardo B, Gruber R, DuBois J. The role of TAM family receptors and ligands in the nervous system: from development to pathobiology. *Pharmacology & Therapeutics*. 2018;188:97–117.
- Xia Y, Choi H-K, Lee K. Recent advances in hypoxia-inducible factor (HIF)-1 inhibitors. *Eur J Med Chem*. 2012;49:24–40.
- Befani C, Vlachostergios P, Hatzidaki E, Patrikidou A, Bonanou S, Simos G. Bortezomib represses HIF-1 $\alpha$  protein expression and nuclear accumulation by inhibiting both PI3K/Akt/TOR and MAPK pathways in prostate cancer cells. *J Mol Med*. 2012;90:45–54.
- Benjamin, D., Colombi, M., Moroni, C. and Hall, M. N. Rapamycin passes the torch: a new generation of mTOR inhibitors. *Nat. Rev. Drug Discov.* 2011; 10, 868–880.
- Greenberger L, Horak I, Filpula D, Saprana Petal. ARNA antagonist of hypoxia-inducible factor- 1 $\alpha$ ,

- EZN-2968, inhibits tumor cell growth. *Mol Cancer Ther.* 2008;7:3598–608.
12. Georgina N, et al. HIF-1 $\alpha$  pathway: role, regulation and intervention for cancer therapy. *Acta Pharmaceutica Sinica B.* 2015;5(5):378–389.
  13. García-Pastor C, Benito-Martínez, S, Moreno-Manzano, V, Fernández-Martínez, A, & Lucio-Cazaña, F. Mechanism and Consequences of The Impaired Hif-1 $\alpha$  Response to Hypoxia in Human Proximal Tubular HK-2 Cells Exposed to High Glucose. *Scientific reports*, 2019;9(1), 15868.
  14. Lee K, Qian D, Rey S, Wei H, Liu J, Semenza G. Anthracycline chemotherapy inhibits HIF-1 transcriptional activity and tumor-induced mobilization of circulating angiogenic cells. *Proc Natl AcadSci USA.* 2009; 106: 2353–2358.
  15. Pore N, Jiang Z, Gupta A, Cerniglia G, Kao GD, Maity A. EGFR tyrosine kinase inhibitors decrease VEGF expression by both hypoxia-inducible factor (HIF)-1-independent and HIF-1A dependent mechanisms. *Cancer Res.* 2006; 66: 3197–3204.
  16. Zhang H, Qian DZ, Tan YS, Lee K, Gao P, Ren YR et al. Digoxin and other cardiac glycosides inhibit HIF-1 $\alpha$  synthesis and block tumor growth. *Proc Natl AcadSci USA*, 2008; 105: 19579–19586.
  17. Kong X, Lin Z, Liang D, Fath D, Sang N, Caro J. Histone deacetylase inhibitors induce VHL and ubiquitin-independent proteasomal degradation of hypoxia-inducible factor 1 $\alpha$ . *Mol Cell Biol.* 2007;26: 2019–2028.
  18. Liu YV, Baek JH, Zhang H, Diez R, Cole RN, Semenza GL. RACK1 competes with HSP90 for binding to HIF-1 $\alpha$  and is required for O<sub>2</sub>-independent and HSP90 inhibitor-induced degradation of HIF-1 $\alpha$ . *Mol Cell.* 2007; 25: 207–217.
  19. Escuin D, Kline ER, Giannakakou P. Both microtubule stabilizing and microtubule-destabilizing drugs inhibit hypoxia-inducible factor-1 $\alpha$  accumulation and activity by disrupting microtubule function. *Cancer Res.* 2005; 65: 9021–9028.
  20. Kaluz S, Kaluzov M, Stanbridge EJ. Proteasomal inhibition attenuates transcriptional activity of hypoxia-inducible factor 1 (HIF-1) via specific effect on the HIF-1 $\alpha$  C-terminal activation domain. *Mol Cell Biol.* 2006; 26: 5895–5907.
  21. Greenberger L, Horak I, Filpula D, Sapra P, Westergaard M, Frydenlund H, et al. A RNA antagonist of hypoxia-inducible factor-1 $\alpha$ , EZN-2968, inhibits tumor cell growth. *Mol Cancer Ther.* 2008;7:3598–3608.
  22. Rapisarda A, Uranchimeg B, Sordet O, Pommier Y, Shoemaker R, Melillo G. Topoisomerase I-mediated inhibition of hypoxia-inducible factor 1: mechanism and therapeutic implications. *Cancer Res.* 2004;64:1475–1482.
  23. Hamzah H, Kzar, Moshtak A, wtwt, Moaed E. Al-Gazally. Study the Glucose Transport, Angiogenesis and Apoptosis Behavioral through Chemotherapy Treatment According to Receptors Status in Women with Breast Cancer. *Indian Journal of Forensic Medicine & Toxicology*, 2020;14(3), 2555-2559.

# Road Traffic Accidents and the Traumatic Brain Injuries: A Cross- Sectional Study.

Ali Abbas Hashim Al musawi<sup>1</sup>, Hasan Alwan Baiee<sup>2</sup>

<sup>1</sup>Lecturer, <sup>2</sup>Prof., University of Babylon–Hammurabi College of Medicine/Iraq

## Abstract

**Background:** Street traffic accidents were a main community healthiness problematic particularly in low and middle-income countries, head injuries were found to be the most common injuries. Objectives: to identify the relationship of road traffic injuries with different associated factors.

**Methodology:** This was a cross sectional study conducted on 500 Road Traffic Accidents victims admitted to the emergency unit at Al-Sader Teaching General Hospital in Al Najaf Holy province- Iraq. Data collection was done using a pretested questionnaire. A medical team including neurosurgeon, medical, and orthopedics to identify the types (pattern) of cranio-cerebral injuries evaluated outcomes of the injury cases.

**Results:** Most of the victims are males in their productive age, motorcycle is the most common cause of accidents, head injuries constituted the highest proportion (39.6%), the mortality rate was (13.6%), and unhealthy behaviors during driving were dominated.

**Conclusion:** Cerebral contusions and skull fractures were the most common lesions among head injuries and trauma brain injuries victims.

**Keywords:** Road Traffic Accidents, traumatic brain injuries, driving behavior–Al-Najaf province Iraq.

## Introduction

Globally, nearly 3 400 people die on the world's roads every day. Tens of millions of people are injured or disabled every year. WHO works to raise the profile of the preventability of road traffic injuries<sup>(1)</sup>. WHO article guesses that 1.9 million individuals in the world die yearly by 2020<sup>(2)</sup>, deaths due to street traffic damages occur in little and middle-income nations<sup>(3,4)</sup>. Road traffic crashes cost most countries 3% of their gross domestic product <sup>(5)</sup>. In 2020, the 3<sup>rd</sup> reason of death and morbidity. 50% of the dead are persons with in their productive age <sup>(6)</sup>. The straight and unintended prices advanced in developing republics likened to those in developed republics<sup>(7)</sup>. Rendering to WHO, the

typical yearly mortality rate due to street traffic damage in Iraq is 44.7 (consistent age mortality rate per 100,000 people) <sup>(8)</sup>. Road traffic injuries cause estimated 700 deaths among young people every day <sup>(9)</sup>. Head injuries due to Road Traffic Accidents is a recognized health problem causing death and disability among the victims, the head being the most vulnerable part of the body that is why cranio-cerebral injury is on the top<sup>(10-12)</sup>. The objectives of this study are to identify the relationship of road traffic injuries with different associated factors, and to assess the morbidity and mortality among road traffic victims admitted to the emergency unit of Al- Sadder hospital-AL-Najaf province- Iraq during the year 2016.

## Methodology

Approval of research ethical committee of Al- Najaf health directorate was obtained; verbal consents were taken from patients or their companions after explaining the objective the study. This study was a cross-sectional study conducted in Al –sadder medical city in Al-Najaf province – Iraq, the duration of this study started from

---

### Corresponding Author:

Ali Abbas Hashim Al musawi

Lecturer, University of Babylon–Hammurabi College of Medicine/Iraq

e-mail: aliabbasalmusawi@uobabylon.edu.iq

the beginning of September –to the end of November 2016. The study group included all patients who were admitted to the emergency unit in Al-Sader general hospital who were injured due to Road Traffic Accidents. Exclusion criteria of this study include victims of Road Traffic Injuries (RTIs) that took place in other provinces and admitted for treatment in this general hospital; any RTI occurred on the road without involvement of automobile (e.g. a person falling due to slipping on the road and causing injury) or injury involving not moving vehicle (e.g. when persons injured while washing or repairing a vehicle) <sup>(13)</sup>. Interviewing of patients and or their companions was done by the research team using pretested questionnaire which included: demographic information (age, gender, educational level..etc.), site of injuries, time of accident, driving behavior (having driving license, wearing seat belt and wearing helmets for motorcyclists). Data were completed by reviewing the records of accidents surveillance program and forensic department records. Outcomes of the injury cases were evaluated by a medical team including neurosurgeon, medical, and orthopedics to identify the types (pattern) of cranio-cerebral injuries through Computer Tomography findings like skull fractures, parenchymal injuries, intracranial hemorrhages, and discharge outcome (alive or death). and calculating the case fatalities together with the proportionate mortality ratios through following up cases during the period of the study. Data were analyzed

by using descriptive presentation contain classical Chi-square to test association between the variations by using SPSS version 21 The  $P \leq 0.05$  is considered statistically significant.

### Results

Table (1) explains that male to female ratio equal to 5:1 and most of victims in age group (20-29 years). Males outnumbered significantly females  $p < 0.001$ .

Table (2) reveals that one fourth of the victims are illiterates and about two thirds of them are below the primary school level.

Table (3) shows that the main vehicles causing RTIs in Al-Najaf province was caused by motorcycle (30%) followed by private cars (29%).

Table (4) depicts the time of occurrence of accidents; the highest rate of accidents took place between (9-11 am).

Table (5) shows that out of 217 injured drivers only (29,1%) have driving license. Among 126 drivers accepted to answer the question of wearing seat belt (9.5%) use the seat belt regularly, while none of the (98) motorcycle drivers (0%) mentioned that they used helmet during driving. Table (6) explains that the main site of injury is head (39.6%).

**Table (1) Distribution of Road traffic injuries by age and gender.**

Age Group (Year)	Male		Female		Total		
	No.	(%)	No.	(%)	No.	(%)	
1-9	50	(11.9)	14	(17)	64	(12.8)	sig <0.001
10-19	103	(24.6)	11	(13)	114	(22.8)	
20-29	113	(27)	15	(18)	128	(25.6)	
30-39	73	(17.4)	10	(12)	83	(16.6)	
40-49	44	(10.5)	11	(13)	55	(11)	
50 and more	35	(8.6)	21	(27)	56	(11.2)	
<b>Total</b>	<b>418</b>	<b>100</b>	<b>82</b>	<b>100</b>	<b>500</b>	<b>100</b>	

Male:Female Ratio = 5:1

**Table (2) Distribution of road traffic injuries by educational Levels**

Academic Level	Male		Female		Total		
	No.	(%)	No.	(%)	No.	(%)	
Illiterate	88	(22.9)	27	(35.5)	115	(25)	Chi-Square=13.018 Df=4 Sig.(2-side)=.011
Elementary	173	(45.2)	26	(34.2)	199	(43.2)	
Intermediate	63	(16.4)	8	(10.5)	71	(15.4)	
Secondary	32	(8.3)	7	(9.3)	39	(8.5)	
College	28	(7.2)	8	(10.5)	36	(7.9)	
<b>Total</b>	<b>384</b>	<b>(100%)</b>	<b>76</b>	<b>(100%)</b>	<b>460</b>	<b>(100%)</b>	

**Table (3): Frequency distribution of Road traffic injuries by types of vehicles causing injuries.**

Type of cars	No.	%	
Taxi	112	(22)	Chi-Square=230.392 Df=5 Sig<0.001
Private car	145	(29)	
Bus	70	(14)	
Lorry	22	(4.4)	
Motorcycle	148	(30)	
Other	3	(0.6)	
<b>Total</b>	<b>500</b>	<b>(100%)</b>	

**Table (4) Distribution of Road traffic injuries by Time of occurrence of accidents**

Time	No.	%	
6-8am	102	(20.4)	Chi-Square=173.728 Df=7 Sig<0.01
9-11am	113	(22.6)	
12-2pm	102	(20.4)	
3-5pm	63	(12.6)	
6-8pm	46	(9.2%)	
9-11pm	39	(7.8%)	
12-2am	5	(1%)	
3-5am	30	(6%)	
<b>Total</b>	<b>500</b>	<b>(100%)</b>	

**Table (5): Distribution of Road traffic injuries of drivers according to having driving license, and wearing protection devices**

Legal Behavior	Yes		No		Total		
	No.	(%)	No.	(%)	No.	(%)	
License	63	(29.1)	154	(70.9)	217	(100%)	Chi-Square=52.667 <sup>c</sup> Df=2 Sig<0 .001
Wearing seat	12	(9.5)	114	(90.5)	126	(100%)	
Wearing helmet	0	(0%)	98	(100)	98	(100%)	

**Table (6): Distribution of Road traffic injuries by site of injury**

Site of injury	No.	(%)	
Head	198	(39.6)	Chi-Square=77.264 Df=3 sig.= .000
Upper limb	115	(23)	
Lower limb	127	(25.4)	
Other	60	(12)	
<b>Total</b>	<b>500</b>	<b>(100%)</b>	

## Discussion

RTIs are the leading cause of injuries, account for 27% of the total injury and violence mortality in the Eastern Mediterranean Region<sup>(14)</sup>. The current study depicts that males are the predominant victims and in their productive age, these findings are similar to the findings of other studies in Iraq<sup>(15,21)</sup> and in other countries<sup>(22- 28)</sup>, this could be explained by the fact of high occupational exposure of males to road using and the lack of road safety in the province together with the congested roads of this holy city especially during religious visiting events. Most of the victims have low levels of educations this finding goes in line with other studies<sup>(18,19)</sup>. This finding is also similar to other study conducted in Yazad-Iran<sup>(28)</sup>. The majority of RTI occurred among motorcyclists this finding agrees with the findings of other study conducted in Yemen<sup>(25)</sup> and in Nepal<sup>(27)</sup>, this study identifies that no motorcyclists used helmets, while in a study conducted in Kenya helmets were used by less than one third of motorcycle drivers<sup>(29)</sup> motorcyclists not wearing this protective device are especially vulnerable for severe head injuries<sup>(30)</sup>. The majority of RTIs took place in the daytime mainly at 9 to 12am and 12am to 2pm this finding is similar to a study conducted In Iran<sup>(31)</sup>The most frequently injured body regions as reported in this study was the head, followed by lower extremities this finding is in contrast with findings of other researchers<sup>(32)</sup>, but it goes with the finding of other studies<sup>(27,33)</sup>. Several studies reported that head injury was found to be most common injuries during traffic accidents<sup>(34)</sup>, being 42.1% making a substantial contribution to RTA cases<sup>(35)</sup>, the main reasons of the fatality is severe traumatic brain injury (TBI) produced by head dullpowers<sup>(36,37)</sup>. In low- and middle-income countries 43% of individuals with TBI that cause by cars accidents<sup>(39)</sup>. Although numerous studies have been done, the consequence of skull fracture on TBIs has not been obviously assumed<sup>(14)</sup>. In the current study the types of lesions are; contusions

followed by skull fractures then lacerations this findings are in contrast with report of Pathak et al<sup>(34)</sup> who found that contusion constitutes 5.16% and skull fracture 22.7%, this difference may be related to difference in the severity of traumas due to RTA in our study or may be due to the poor use of the seat belts and helmets. The current study shows that less than one third of drivers have driving license and less than (10%) of drivers wear seatbelts regularly, findings indicate bad road behavior and they are less than that reported by other studies<sup>(11,27,33)</sup>. As a result of the enactment of the seat belt law, in accordance with suggestions from many studies, a significant drop in certain types of injuries<sup>(32)</sup>.

Most of the victims are males in their productive age, motorcycle is the most common cause of accidents, and head injuries constituted the highest proportion, unhealthy behaviors during driving dominated.

**Ethical Clearance:** The Research Ethical Committee at scientific research by ethical approval of both MOH and MOHSER in Iraq

**Conflict of Interest:** None

**Funding:** Self-funding

## References

- Ivers, R., Brown, K., Norton, R. & Stevenson, M. in International Encyclopedia of Public Health (Elsevier Inc., 2016), 02: 393–400.
- World Health Organization. “Global Status Report on Road Safety.” Injury prevention (2015): 11: 318.
- Jindal, AK, and S Mukherji. “World Report on Road Traffic Injury Prevention.” Medical Journal Armed Forces India (2005):61.1 91.
- WHO. “Global Status Report on Road Safety.” Injury prevention (2013): 2: 318.

5. World Health Organization (WHO). "Global Status Report on Road." World Health Organization (2018): 20: 12-19.
6. World Health Organization. "World Health Statistics 2009: Cause-Specific Mortality and Morbidity." [http://www.who.int/whosis/whostat/EN\\_WHS09\\_Table2.pdf](http://www.who.int/whosis/whostat/EN_WHS09_Table2.pdf). N.p., 2009.
7. Ghaffar A, Hyder AA, Masud TI. The burden of road traffic injuries in developing countries: the 1st national injury survey of Pakistan. *Public health*. 2004;118(3):211-7.
8. World Health Organization. "Road Traffic Accidents Death Rate by Country." WHO, Road Traffic Accidents 2014: 1: 1-3
9. Hofman K, Primack A, Keusch G, Hrynkow S: Addressing the growing burden of trauma and injury in low and middle income countries. *Am J PublHlth* 2005;95(1):13-17.
10. H., K., Paparajamurthy, P., K., M. & K., A. A clinical analysis of outcome in management of head injury in patients with highway road accidents. *International Journal of Research in Medical Sciences* 2016, 4: 2079-2083.
11. Chaturvedi K, Mishra A, Chaturvedi P. "Pattern of Head Injuries in Fatal Road Traffic Accidents in Indore Region, M.P". *Journal of Evolution of Medical and Dental Sciences* 2014; 3: 5645-5651.
12. Giri SK, Jakhar JK, Dhatarwal SK. Pattern of Fatal Cranio-Cerebral Injury in Road Traffic Accidents -An Autopsy Based Study. *Indian Acad Forensic Med*. October-Decmeber 2018, 40(4):339-41.
13. Degais W, Awooda H, Elnimeiri M, Kaddam L. Epidemiological Pattern of Injuries Resulting from Road Traffic Accidents in Khartoum, Sudan. *Health* 2018;10, 816-822.
14. Abdulgafoor M. Bachani, Xiaoge Julia Zhang, Katharine A. Allen and Adnan A. Hyder. Injuries and violence in the Eastern Mediterranean Region: a review of the health, economic and social burden. *EMHJ*, 2014; 20(10):644-54.
15. Al-Ghabban S, Abdul-Sahib M, Waleed M. Risk Factors and Pattern of Injuries in Motorcycle Accidents in Holy Karbala.2013; *Karbala J. Med*.6(1):1551-60
16. Aljoborae SFF, Al Humairi AK. A Study of Road Traffic Accidents in Babylon Province. *Medical Journal of Babylon*; 2014;11(4):912-22.
17. Mohammed SJ. Epidemiological study on road traffic accidents in Al-Najaf city during 2011. *kufa Journal for Nursing sciences*.2012.;2(3):138-142.
18. Ismail SA, Hasan MT. Epidemiology of Road Traffic Accidents in Emergency Hospital in Erbil City. *Tikrit Medical Journal*.2012;18(2):182.
19. Abd-Ali; AK: Epidemiology of Road Traffic Injuries In AL-Najaf Governorate Diploma of Family Medicine Dissertation Babylon Medical college 2012 :31-38.
20. Nema IS. Evaluation of Pediatric Head Injuries. *IJMS*.2016;14(1):33-38.
21. Baiee HA, Alaraji KS, Mohammad AJ. Road Traffic Fatalities in Babylon Province-Six Years Epidemiologic Study. *Indian Journal of Forensic Medicine & Toxicology* 2020;14(1):917-922.
22. Patel DJ, Agnihotram G. Study of road traffic accident deaths in and around Bastar Region of Chhattisgarh. *J Indian Acad Forensic Med*. 2010; 32(2): 110-2.
23. Khan ZU, Al-Asiri KM, Iqbal J. Injury patterns from road traffic accidents. *Pakistan J Med Sci*. 2010; 26(2): 394-7.
24. Shalaby SA, Akeed YA, Fawzi MM, et al. Prospective study of some medico-legal aspects of road traffic accidents in great Cairo 2007. *Inter J Acad Res*. 2010; 2(2): 127-37.
25. Abdulla NA. Medico-Legal Study of Non-Fatal Road Traffic Injuries. *IRAQI J MED SCI*, 2013; 11(2):35-143
26. Al-Jubouri SNJ. Spatial analysis of traffic accidents in the Sultanate of Oman (Study in the transport geography). *Al- Adab Journal, Baghdad University*.215; 114:387-420.
27. Karkee R, Lee AH. Epidemiology of road traffic injuries in Nepal, 2001-2013: systematic review and secondary data analysis *BMJ Open*. 2016;6:e010757.
28. Vakili M, Mirzaei M, Pirdehghan A, Sadeghian M, Jafarizadeh M, Alimi M, Naderian S, Aghakoochak A. The Burden of Road Traffic Injuries in Yazd Province - Iran. *Bull Emerg Trauma*. 2016 Oct;4(4):216-222. 29.23.
29. Bachani AM, Koradia P, Herbert HK, Mogere S, Akungah D, Nyamari J, Osoro E, Maina W, Stevens KA. Road traffic injuries in Kenya: the health burden and risk factors in two districts. *Traffic Inj Prev*. 2012;13 Suppl 1:24-30.



30. LiChong S, Tyebally A, Yah Chew S et al. Road traffic injuries among children and adolescents in Singapore – Who is at greatest risk?. *Accident Analysis & Prevention*, March 2017, 100 : 59–64.
31. Moafian G, Aghabeigi MR, Heydari ST, Hoseinzadeh A, Lankarani KB, Sarikhani Y. An epidemiologic survey of road traffic accidents in Iran: analysis of driver-related factors. *Chin J Traumatol*. 2013;16(3):140-4.
32. Mansuri FA, Abdulmohsen H. Al-Zalaba, Zalat M, Reem I. Road safety and road traffic accidents in Saudi Arabia. *Saudi Med J*. 2015; 36(4): 418–424.
33. Ali AM. Road Traffic Accident Fatalities In Tikrit General Hospital . 2005 . *Medical Journal of Tikrit*, 2, (112): 24-27.
34. Pathak AK, Dev R, Awasthi PMC et.al. Study of injuries among road traffic accident victim at LLR hospital, GSVM Medical College, Kanpur U.P. *Gal Int J Health Sci Res*. 2020; 5(1): 80-83
35. Degais, W., Awooda, H., Elnimeiri, M. and Kaddam, L. (2018) Epidemiological Pattern of Injuries Resulting from Road Traffic Accidents in Khartoum, *Sudan. Health*, 10, 816-822.
36. Coronado V.G., Xu L., Basavaraju S.V., McGuire L.C., Wald M.M., Faul M., Guzman B.R., Hemphill J.D. Surveillance for Traumatic Brain Injury-Related Deaths-United States, 1997–2007. Volume 60. Centers for Disease Control and Prevention; Washington, DC, USA: 2011. pp. 1–32.
37. Shang S., Otte D., Li G., Simms C. Detailed assessment of pedestrian ground contact injuries observed from in-depth accident data. *Accid. Anal. Prev*. 2018;110:9–17.
38. Silva S F, Silva S L, Nascimento A C et al. Profile of organ donors in Ceará, northeastern Brazil, from 1998 to 2012. *Transplant Proc*. 2014;46(06):1692–1694.
39. Dunne J, Quiñones-Ossa GA, Still EG, Suarez MN, González-Soto JA, Vera DS, Rubiano AM. The Epidemiology of Traumatic Brain Injury Due to Traffic Accidents in Latin America: A Narrative Review. *J Neurosci Rural Pract*. 2020 Apr;11(2):287-290.
40. Carson H.J. Brain trauma in head injuries presenting with and without concurrent skull fractures. *J. Forensic Leg. Med*. 2009;16:115–120.
41. Ren L, Wang D, Liu X, Yu H, Jiang C, Hu Y. Influence of Skull Fracture on Traumatic Brain Injury Risk Induced by Blunt Impact. *Int J Environ Res Public Health*. 2020 Apr 1;17(7):2392.

# Frequency of Left Ventricle Dysfunction in non-Alcoholic Fatty Liver Disease (NAFLD) Patients Detected by Global Longitudinal Strain and Tissue Doppler Imaging in Babylon Province in Iraq

Haitham Shaalan Sewan<sup>1</sup>, Hassan Salim Aljumaily<sup>2</sup>

<sup>1</sup>Dr. Researcher, Diploma of Internal medicine, Babylon Health Director, Iraq,

<sup>2</sup>Prof., Dr. College of Medicine, Babylon University, Iraq

## Abstract

The aim of the study is an assessment of left ventricle systolic and diastolic function in patients with non-alcoholic fatty liver disease (NAFLD) by measuring global longitudinal strain, and tissue Doppler imaging TDI.

**Method:** A Case-control study enrolled 30 patients with non-alcoholic fatty liver disease (mean age 44.13 years) without a history of cardiac disease and 30 healthy controls (mean age 44.79 years). All participants had been undergone trans-thoracic echocardiography (TTE), tissue Doppler imaging (TDI) for assessment of mitral annular systolic velocity (S'), E/A ratio, and E/e', as well as left ventricle global longitudinal strain (GLS) using speckle tracking echocardiography (STE) technique.

**Results:** NAFLD patients had shown The E/e' ratio was significantly higher in the NAFLD group ( $9.86 \pm 1.69$  vs  $6.85 \pm 1.23$ ), ( $P = < 0.001$ ). The difference in the E/A ratio between the groups was significant ( $P = 0.04$ ). GLS was also significantly lower negative in NAFLD patients in comparison with control ( $-18.85 \pm 1.07$  vs  $-23.05 \% \pm 1.19$ ) but within normal values.

**Conclusion:** There is an increasing risk of subclinical LV dysfunction (systolic and diastolic) in NAFLD patients can be early confirmed by DTI and GLS.

**Keywords:** *Left ventricle dysfunction, non-alcoholic fatty liver disease (NAFLD), global longitudinal strain, Doppler imaging, Babylon province.*

## Introduction

One of the most chronic liver diseases worldwide is a non-alcoholic fatty liver disease (NAFLD) with hepatocytes infiltration by fatty deposit, its prevalence between 25% and 30 in the united states affecting all groups of age, suggesting a serious and growing problem<sup>(1)(2)</sup>. NAFLD involves a wide spectrum of

liver disease inflammation coexist following simple steatosis with different stages of fibrosis reach to hepatic cirrhosis and hepatocellular carcinoma HCC. Non-alcoholic steatohepatitis (NASH) is a subtype of disease progression indicating the extreme form of NAFLD. NAFLD is significantly associated with increased morbidity and mortality due to cardiovascular events<sup>(1)</sup>. The dysfunction of adipose tissue there is what is called adipokine secretion that relates to overweight and obesity which leads to a wide spectrum of diseases mainly cardiovascular disease, although some adipokines have anti-inflammatory and give protection against cardiovascular complications.<sup>(1)</sup>. Sub-clinical defects, CAD, LV, hypertrophy, HF, HHD, and arrhythmias are found in cardiovascular

---

### Corresponding Author:

Haitham Shaalan Sewan

Dr. Researcher, Diploma of Internal medicine, Babylon Health Director, Iraq

e-mail: haitham.saiwan71@gmail.com

diseases. The discharge of mixture mediators including pro-inflammatory, procoagulant, and profibrogenic mediators is involved in the association of atherogenic dyslipidemia, systemic and Hepatic insulin resistance with obesity and hypertension<sup>(2)(3)(4)</sup>. In addition to the history of alcohol use (the appropriate limits of alcohol intake are 70g/week for females and 140 g/week for men), the over nutrition shows central obesity, primarily overweight persons make abdomen ultrasound with fatty changes, a diagnosis of NAFLD, and diagnosis for other liver diseases should be excluded. Although alcohol consumption in low amounts can be protected from complications, the estimated mortality is 1.6-fold. The lifestyle modification through a decrease weight of > 7% is less than 50%. The control of serum lipid is important to decrease the danger of cardiovascular diseases in NAFLD<sup>(5)</sup>. Although liver biopsy is the only effective way to distinguish NASH from NASH in NAFLD, a more new development in a noninvasive way is also possible. Even In the absence of obesity which is morbid, high blood pressure and hyperglycemia, NAFLD may cause impairment of LV function whether diastolic or systolic<sup>(6)</sup>. Speckle-tracking echocardiography (STE) is a new ultrasound technique that is a non-invasive by which we can do an evaluation, quantitatively or objectively for the regional and global function of the myocardium<sup>(7)(8)</sup>. Several studies show that the GLS was significantly reduced in NAFLD<sup>(9)</sup>. The exact mechanism of LV dysfunction is not well known yet, but the mean pathophysiological landmark is the resistance of insulin secretion which is mainly seen in non-alcoholic fatty liver disease (NAFLD), although the same process had been seen in patients of essential hypertension<sup>(10)</sup>. In control subjects without hepatic steatosis, NAFLD patients show atherosclerosis of high prevalence<sup>(11)</sup>

## Method

A case-control study, done at Marjan city Teaching hospital, echocardiography unit, with the cooperation of the GIT disease unit and radiology unit for the period from 1<sup>st</sup> January to 1<sup>st</sup> March 2020. The case-control study included 30 outpatients individuals aged more than 18 years old with NAFLD, 16 females and 14 males. These individuals referred from ultrasound units in Merjan Medical city accidentally found to have fatty liver changes and all of them are non-alcoholic most of them have overweight and obesity with irritable bowel syndrome or renal colic without chronic diseases. Healthy control without previous history of cardiac disease those are 30 include 25 females and 5 males,

These individuals referred from ultrasound units in Merjan Medical city accidentally found to have fatty liver changes. All patients and control underwent conventional echocardiography. The examination was established by using a "Vivid E9 echo machine from GE Healthcare Company with an M5Sc probe with multiple frequencies. The patients had been done in the left lateral position, and views and measurements had been taken according to American guidelines of Echocardiography. A 2-Dimension-speckle tracking strain and TDI had been done to 30 control and 30 of the patients. This study was done in Echo Department in Marjan teaching Medical City. The following patients were not involved in this study:

1. Diabetes Mellitus
2. Hypertensive
3. BMI > 40
4. IHD
5. CMP
6. Other CLD (chronic liver diseases)
7. History of using hepatotoxic drugs

All participants underwent 2-dimensional transthoracic echocardiography, incorporating STE using a Vivid E9 system (GE, Norway). All measurements of 2-D echocardiography were worked and analyzed by the echocardiologist who was blinded to the patient group assignment, depending on the recommendations by the American Society of Echocardiography last one<sup>(12)</sup>. The same ultrasound machine was used to acquire all echocardiograms. The function of the diastole of LV was determined by using pulse wave (PW) and TDI. By using M-mode the systolic, the dimensions of end-diastole and septal thickness of the ventricle had been calculated. Ejection fraction of the left ventricle (LVEF), end-diastole and end-systole volume (EDV, ESV) had been measured with the 4-chambers and 2-chambers apical views, and the modified Simpson's biplane method had been used, which a method acquires the benefit of the enhancement in image inequality and in the ability to see the borders of endocardium clearly in end-systolic and end-diastolic views<sup>(13)</sup>. Guidelines for use TDI to assess the diastolic function: by view of apex run pulse wave of TDI to get on annular velocities of the mitral valve, place the sample view at or 1 cm through the septal and lateral mitral leaflets, sweep the speed from 50 to 100 mm/s when expiration end, the

measure reveal the mean of three or more successive cycles, the measurements start with systolic, early (e'), and late (a') velocities of diastole, to assess entire LV diastolic function, the signals of tissue doppler obtain and calculate the lateral and septal sides of the annulus of the mitral valve and their mean, to outcome relaxation of LV on mitral E velocity, e' can be utilized for correction, and E/e' ratio (a marker of left atrial (LA) pressure) can be requested to predict the pressures of LV filling. The E/A ratio <1.5 along with both E/e' ratio <15 and e' velocity >8 cm/sec was considered as the normal diastolic function<sup>(14)(15)(9)(11)</sup>. The E/e' ratio is not a precise as an index of pressures filling in persons who are normal or patients with annular calcification that is heavy, disease of the mitral valve, and pericarditis that constrictive one<sup>(16)</sup>. By taking an apical 4 chamber view (4CV), PWD was put at the mitral valve tip and then the peak of E and A wave velocity was calculated in addition to measurements of E/A ratio. So the E/e' was measured automatically from the septaland lateral part of the annulus of the mitral valve. Then "Pulmonary capillary wedge pressure (PCWP) was measured by using this formula, PCWP= (E/e' + 4).

**LV Strain using Speckle Tracking Echocardiography (STE):** The deformation analysis is an analytics issue of the shape and mechanics of the ventricles through the cardiac cycle. Deformation can be categorized by the strain of myocardium, rate of strain, and torsion, every one of them refers to a parameter difference in the change of shape during contractility and relaxation<sup>(17)</sup>. The Left ventricular GLS had been measured by the use of STE at the frame rate of 50 to 70 frames/s. It is recommended to begin with an apical three-chamber view (A3C) to choose the frame matching the aortic valve closure, the reference point corresponding to end-systole. In addition to this view, apical four chambers(A4C),and two-chamber view (A2C) which is necessary to complete the assessment. The GLS was automatically measured by the echo

machine as an average of strain obtained from these three views. The normal value in a healthy person is around -20%, while it is abnormal if GLS more than -18 %. On 2-dimensional echocardiography, the GLS appeared the change of the myocardial length of the left ventricle (LV) propionates in-between end-diastole and end-systole. After optimization of the quality of the image, frame rate maximization, and minimization of foreshortening, the measurement of peak mid-wall GLS was taken in the standard of three views and AFI (automated function imaging) application had been averaged.<sup>(18)</sup> Analysis of statistics was carried out using SPSS version 23. variables category were obtained as frequencies and percentages. Continuous variables were presented as (Means  $\pm$  SD). The student t-test was used to compare means between two groups. Chi-square test and Fisher-exact test were used to find the association between categorical variables. A p-value of  $\leq 0.05$  was considered significant.

## Results

In this study, the results were expressed into 2 groups; Non-Alcoholic Fatty Liver disease (NAFLD) and normal control groups. 60 individuals were enrolled in the present study. The mean age of the participants was (44.6)and (47.2) years old in the case and control groups, respectively. Among the patients with NAFLD,(16) were male and (14) were female, with (5) male and (25) female in the control group. The E/e' ratio was significantly higher in the NAFLD group ( $9.86 \pm 1.69$  vs  $6.85 \pm 1.23$ ),  $P \leq 0.001$ ). The difference in the E/A ratio between the groups was significant ( $P = 0.04$ ). GLS was significantly lower negative in NAFLD patients t in comparison with control ( $-18.85 \pm 1.07$  vs  $-23.05 \% \pm 1.19$ ) but within normal values. LVEF was statistically insignificant between the groups. Regarding the lipid profile, the study failed to show a significant difference in Total cholesterol, S.TG, HDL, and LDL between NAFLD and the control group.

**Table 1. The demographic characteristics of the participants and lipid profile.**

Study variables	Control group n=30		NAFLD n= 30		P-value
	Mean	SD	Mean	SD	
Age (Years)	44.6	9.87	47.2	11.13	0.34
BMI (kg/m <sup>2</sup> )	25.38	1.53	28.76	4.91	0.001
Smoking	0.16	0.37	0.07	0.25	0.27

\*p value  $\leq 0.05$  significant

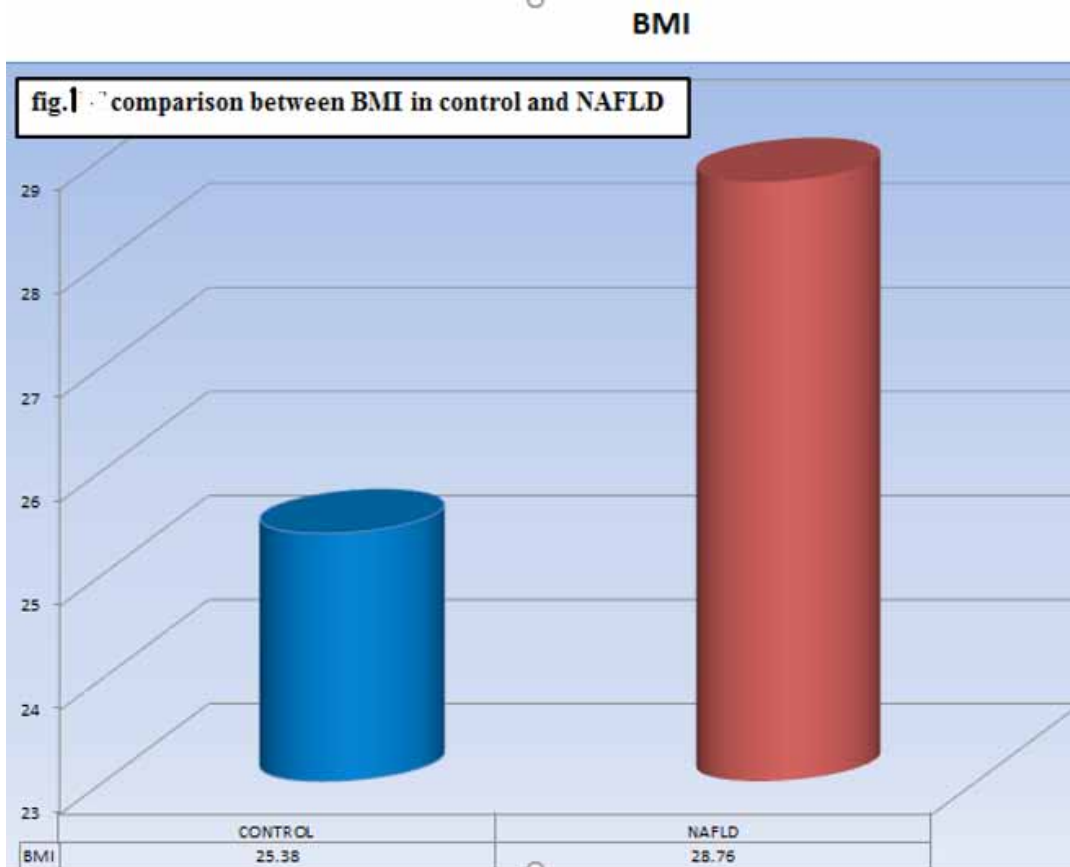
**Table 2. Comparison of lipid profile in each group.**

Study variables	Control Group n=30		NAFLD n= 30		P-value
	No.	%	No.	%	
TG (< 150 mg/dl)	18	60%	20	66.66 %	0.9
Total cholesterol (< 200 mg/dl)	19	63%	23	76.66%	0.82
HDL (>40 mg/dl female 50 mg/dl male)	17	56.66%	19	63.33	0.89
LDL (<130 mg/dl)	21	70%	24	80%	0.87

**Table 3: Comparison of left ventricle systolic and diastolic function parameters between the control group and NAFLD.**

Study variables	Control n=30		NAFLD n=30		P-value
	Mean	SD	Mean	SD	
LVEF (%)	65.26 %	2.39	64.93 %	1.96	0.56
SV (ml/beat)	64.56	3.38	64.40	3.25	0.85
CO (L/min)	4.44	0.40	4.42	0.52	0.86
GLS(%)	-23.05 %	1.19	-18.85%	1.07	< 0.001
S' (cm/s)	11.41	1.14	11.93	1.36	0.11
E/A	1.46	0.33	1.27	0.78	0.22
E/e'	6.85	1.23	9.86	1.69	< 0.001

\*p value ≤ 0.05 significant



**Figure 1: Comparison of BMI between NAFLD and Control group**

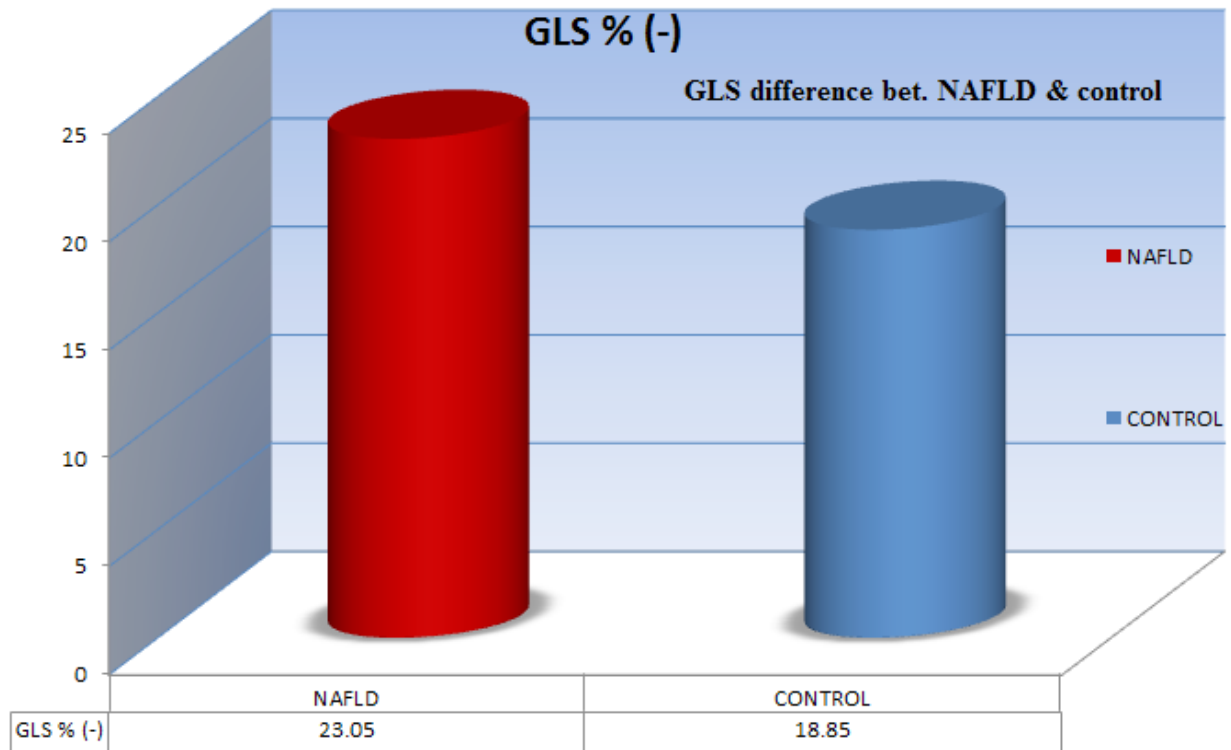


Figure 2. GLS difference between NAFLD and Control

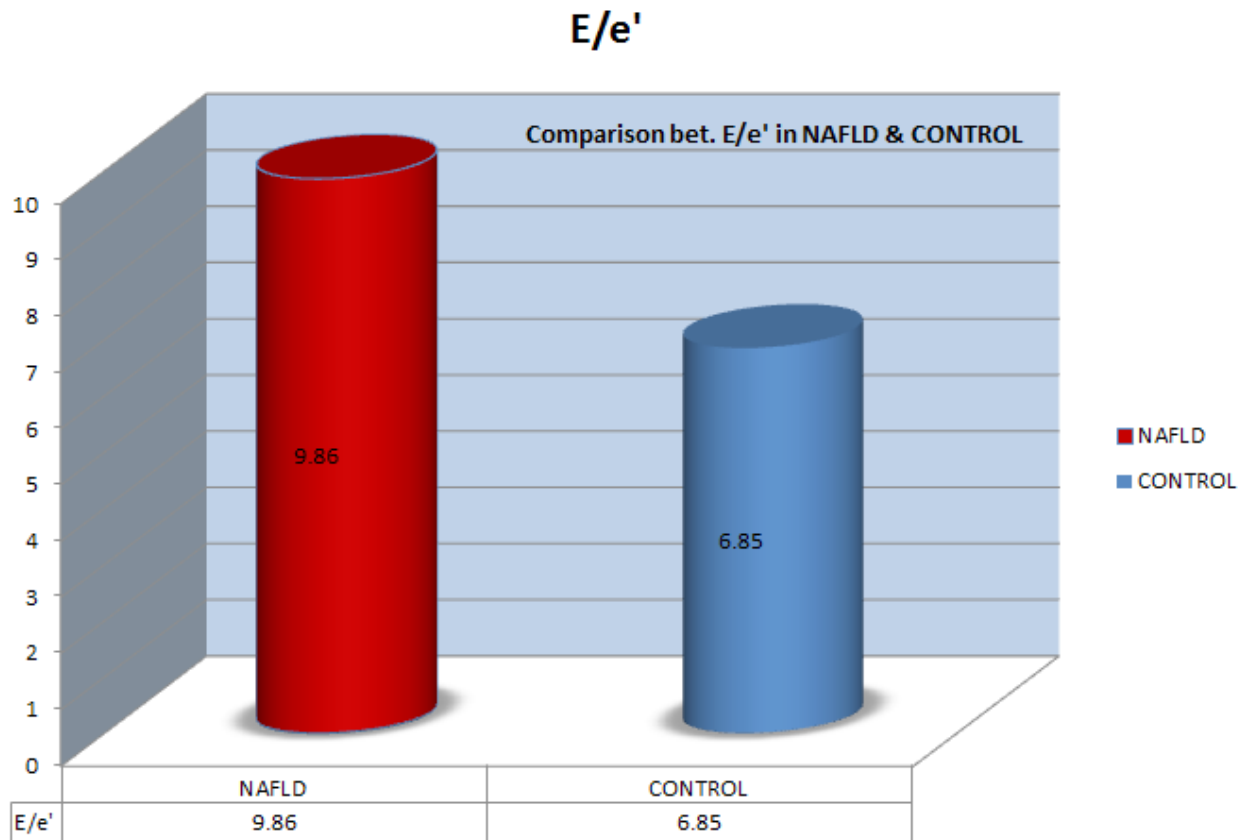


Figure 3. Comparison of E/e' between NAFLD and Control

## Discussion

In this study, there is a significant difference in GLS between NAFLD patients and the control, although there is no significant difference LVEF between both groups. and this compatible with the study done by Zamirian M, Samiee E, Moaref A, Abtahi F, Tahamtan M. 2018<sup>(8)</sup>. GLS, an indicator of systolic function, in patients with NAFLD evaluated with those without NAFLD was reduced; showing superior subclinical systolic dysfunction in NAFLD patients. This result is similar to those stated by Singh et al. and VanWagner et al. in a decreased value of GLS in adolescents and adults with NAFLD(14). The presence of LV diastolic dysfunction, including higher E/e' ratio, lower S', and e' tissue velocity in patients with NAFLD has been mentioned in previous studies using TDI, (6). However, the comparison of LVEF between the two groups did not reveal any significant difference, illustrating that the use of this conventional tool would result in missing the early stages of LV systolic dysfunction<sup>(19)</sup>. Regarding diastolic dysfunction, there is a lower E and E/A ratio in NAFLD patients, furthermore, the Vp and e'weresignificantly lowerand the last most independent parameter associate with NAFLD on multivariate analysis, that a study had been done by Goland et al at 2006<sup>(6)</sup>.Aboutbody lipid deposition, in NAFLD, anepicardial fat thickness, the high one is correlated with the liver fibrosis severity, with a probable pathogenic role keepingthe ectopic fat depots with body organ damage as a whole, when compared with control but still, these changes are statistically not significant and this goes with the study done by Petta S et al at 2015<sup>(20)</sup>. In NAFLD patients, the rise in free fatty acids may lead to lipid deposition on the myocardium, with the sequelaeof the alterations in the left ventricle (LV) performance<sup>(20)(21)(22)</sup>.

## Conclusion

The 2 D Speckle tracking echocardiography by assessing GLS is a sensitive method and more valuable than the ordinary 2D echocardiography in the early detectionof subclinical LV involvement in NAFLD patients. The patients with NAFLD were provedthat have significantly lower e' velocity and higher E/e' ratio in comparison with the individual that age and sex-matched who do not have NAFLD; suggesting the adverse effects of NAFLD on diastolic indices.

**Ethical Clearance:** The Research Ethical Committee at scientific research by ethical approval of both MOH and MOHSER in Iraq

**Conflict of Interest:** None

**Funding:** Self-funding

## References

1. Targher G, Byrne CD, Lonardo A, Zoppini G, Barbui C. Non-alcoholic fatty liver disease and risk of incident cardiovascular disease: a meta-analysis. *J Hepatol.* 2016;65(3):589–600.
2. Temple JL, Cordero P, Li J, Nguyen V, Oben JA. A guide to non-alcoholic fatty liver disease in childhood and adolescence. *Int J Mol Sci.* 2016;17(6):947.
3. Liu H, Lu H-Y. Nonalcoholic fatty liver disease and cardiovascular disease. *World J Gastroenterol WJG.* 2014;20(26):8407.
4. Targher G, Bertolini L, Padovani R, Zenari L, Zoppini G, Falezza G. Relation of nonalcoholic hepatic steatosis to early carotid atherosclerosis in healthy men: role of visceral fat accumulation. *Diabetes Care.* 2004;27(10):2498–500.
5. Hübscher SG. Histological assessment of non-alcoholic fatty liver disease. *Histopathology.* 2006;49(5):450–65.
6. Goland S, Shimoni S, Zornitzki T, Knobler H, Azoulai O, Lutaty G, et al. Cardiac abnormalities as a new manifestation of nonalcoholic fatty liver disease: echocardiographic and tissue Doppler imaging assessment. *J Clin Gastroenterol.* 2006;40(10):949–55.
7. Karabay CY, Kocabay G, Kalayci A, Colak Y, Oduncu V, Akgun T, et al. Impaired left ventricular mechanics in nonalcoholic fatty liver disease: a speckle-tracking echocardiography study. *Eur J Gastroenterol Hepatol.* 2014;26(3):325–31.
8. Zamirian M, Samiee E, Moaref A, Abtahi F, Tahamtan M. Assessment of subclinical myocardial changes in non-alcoholic fatty liver disease: a case-control study using speckle tracking echocardiography. *Iran J Med Sci.* 2018;43(5):466.
9. Pacifico L, Di Martino M, De Merulis A, Bezzi M, Osborn JF, Catalano C, et al. Left ventricular dysfunction in obese children and adolescents with nonalcoholic fatty liver disease. *Hepatology.* 2014;59(2):461–70.
10. Fotbolcu H, Yakar T, Duman D, Karaahmet T, Tigen K, Cevik C, et al. Impairment of the left ventricular systolic and diastolic function in patients

- with non-alcoholic fatty liver disease. *Cardiol J*. 2010;17(5):457–63.
11. Fallo F, Dalla Pozza A, Sonino N, Lupia M, Tona F, Federspil G, et al. Non-alcoholic fatty liver disease is associated with left ventricular diastolic dysfunction in essential hypertension. *Nutr Metab Cardiovasc Dis*. 2009;19(9):646–53.
  12. Lang RM, Badano LP, Mor-Avi V, Afilalo J, Armstrong A, Ernande L, et al. Recommendations for cardiac chamber quantification by echocardiography in adults: an update from the American Society of Echocardiography and the European Association of Cardiovascular Imaging. *Eur Hear Journal-Cardiovascular Imaging*. 2015;16(3):233–71.13. Sadeghpour A. *Case-Based Textbook of Echocardiography*. Case-Based Textbook of Echocardiography. 2018.
  14. VanWagner LB, Wilcox JE, Colangelo LA, Lloyd-Jones DM, Carr JJ, Lima JA, et al. Association of nonalcoholic fatty liver disease with subclinical myocardial remodeling and dysfunction: a population-based study. *Hepatology*. 2015;62(3):773–83.
  15. Sert A, Aypar E, Pirgon O, Yilmaz H, Odabas D, Tolu I. Left ventricular function by echocardiography, tissue Doppler imaging, and carotid intima-media thickness in obese adolescents with nonalcoholic fatty liver disease. *Am J Cardiol*. 2013;112(3):436–43.
  16. Yoshida T, Mori M, Nimura Y, Hikita G, Takagishi S, Nakanishi K, et al. Analysis of heart motion with ultrasonic Doppler method and its clinical application. *Am Heart J*. 1961;61(1):61–75.
  17. Armstrong WF, Ryan T. *Feigenbaum's echocardiography: Seventh edition*. Feigenbaum's Echocardiography: Seventh Edition. LWW; 2012. 1–1676 p.
  18. Fabiani I, Riccardo NR, Santini V, Conte L, Di Bello V. Speckle-Tracking Imaging, Principles and Clinical Applications: A Review for Clinical Cardiologists. *Echocardiogr Hear Fail Card Electrophysiol*. 2016;85–114.
  19. Smekal A, Vaclavik J. Adipokines and cardiovascular disease: A comprehensive review. *Biomed Pap Med Fac Palacky Univ Olomouc*. 2017;161(1).
  20. Petta S, Argano C, Colomba D, Cammà C, Di Marco V, Cabibi D, et al. Epicardial fat, cardiac geometry and cardiac function in patients with non-alcoholic fatty liver disease: association with the severity of liver disease. *J Hepatol*. 2015;62(4):928–33.
  21. Bugianesi E. Nonalcoholic fatty liver disease (NAFLD) and cardiac lipotoxicity: Another piece of the puzzle. *Hepatology*. 2008;47(1):2–4.
  22. Di Sessa A, Umamo GR, Miraglia Del Giudice E, Santoro N. From the liver to the heart: Cardiac dysfunction in obese children with non-alcoholic fatty liver disease. Vol. 9, *World journal of hepatology*. 2017. p. 69–73.



# Levels of Some Biomarkers in Ischemic Heart Disease Patients

Majida Sulaiman Aadai<sup>1</sup>, Mayada Noori Iqbal<sup>2</sup>, Nahlah Ghanim Abdul Majeed<sup>3</sup>

<sup>1</sup>Student, <sup>1</sup>Department of immunology, AL Karama Teaching Hospital, Kut, Iraq, <sup>2</sup>Assist. Prof., College of Health and Medical Technology, Middle Technical University, Baghdad, <sup>3</sup>Department of Immunology, Teaching Laboratories, Baghdad Teaching Hospital, Baghdad, Iraq

## Abstract

The present study is an attempt to investigate the changes in serum soluble suppression of tumorigenicity 2 (sST2) and Interleukin-33 (IL-33) biomarkers levels in Iraqi ischemic heart disease (IHD) patients including stable angina (SA), unstable angina (UA) and myocardial infarction (MI) compared to the healthy controls (HC), and to evaluate the differences in these levels between these diseases combination groups. The IHD's mortality surpass that of every major disease, so it is important that to get such research especially among Iraqi patients. These biomarkers are expressed by myocardial cells, the sST2 is released when there is a myocardial stress while the IL-33 has a cardio protective role, and both are expressed on atherosclerotic plaque which is the most common cause of IHD. Collecting the blood samples from one hundred thirty IHD patients with ages ranged (30-80) years, of both genders, excluding the patient with any autoimmune disease, investigated for sST2 and IL-33 by ELISA technique. This study revealed that the sST2 was highly significantly decreased in all IHD groups compared with HC; the 5% trimmed mean (ng/ml) was 8.48, 8.37, 9.31 versus 23.88 in SA, UA, MI and HC respectively; while the IL-33 was highly significantly decreased in SA and UA groups while not significantly different in MI patients; the 5% trimmed mean (ng/L) was 969.93, 762.21, 1279.45 versus 2110 in SA, UA, MI and HC respectively. Also there was a significant direct correlation between these biomarkers levels in all IHD groups.

**Keywords:** sST2, IL-33, IHD, Stable angina, Unstable angina, Myocardial infarction.

## Introduction

The ischemic heart disease (IHD) is a disease of coronary arteries, so it is also called coronary heart disease (CHD) or coronary artery disease (CAD), in which there is a blood supply reduction to the myocardium, mostly due to atherosclerosis in the coronary arteries. It is the main cause of death worldwide, so it is important in many studies nowadays<sup>(1)</sup>. IHD can be classified into chronic stable angina (SA) and acute coronary syndrome (ACS) that include unstable angina (UA) and myocardial infarction (MI)<sup>(2)</sup>. The primary

prevention of CAD is dependent upon the ability to identify high risk individuals<sup>(3)</sup> and by studying the novel biomarkers long before the development of overt major adverse cardiac events (MACEs)<sup>(4)</sup>. The ST2 is known as interleukin-1 receptor-like-1 (IL1RL1) protein, it has two isoforms; ST2L and sST2, the later can act as a decoy receptor by binding free IL-33, and it reflects the myocardial stress. It provides prognostic information especially in the MI<sup>(5)</sup>. The IL-33 is a cytokine, is a functional ligand for ST2L, is expressed by myocardial cells, it has a cardioprotective role and inhibits the atherosclerotic plaques development; it predicts the mortality and MACEs in the MI patients<sup>(6)</sup>. The present study aimed to investigate the changes in the serum soluble suppression of tumorigenicity 2 (sST2) and Interleukin-33 (IL-33) biomarkers levels, as well as the risk factors such as age, gender, smoking and serum cholesterol level in Iraqi IHD patients who are with SA, UA and MI compared to apparently healthy controls (HC) group.

---

### Corresponding Author:

**Majida Sulaiman Aadai**

Department of Immunology, AL Karama Teaching Hospital, Kut, Iraq

e-mail: majdasulaiman7@gmail.com,

dr.mayadanori@yahoo.com

## Patients and Method

Collecting the blood samples from one hundred thirty patients with ages ranged (30-80) years, of both genders, newly admitted to different Iraqi hospitals (Ibn Al- Betar Teaching Hospital, Baghdad Teaching Hospital and The Iraqi Center for Heart Disease), classifying them into fifty patients with MI, fifty patients with SA and thirty patients with UA according to the clinical manifestations, electrocardiogram findings and laboratory investigations.

Patients with diabetes mellitus [confirmed by blood sugar and hemoglobin A1c levels (by chemistry autoanalyzer (AU480, Beckman))] and with any other autoimmune disease were excluded from this study<sup>(7)</sup>. Thirty five apparently HC were enrolled in this study with the same age range of both genders. A form of questionnaire was applied for both the patients and HC groups. This questionnaire listed some informations especially the age, gender, presence of the medical history

(especially of any autoimmune disease) and whether smoker with its grading or not. Most of the patients serum samples were collected within about (24-48 hours) of the symptom onset and investigated for blood cholesterol level (by chemistry autoanalyzer (AU480, Beckman)), sST2 and IL-33 by enzyme linked immune sorbent assay (ELISA) technique [(sandwichkit) (Human)].

**Statistical analyzing:** Analysis of data was carried out by using the available statistical package of SPSS-22. The significance of the differences of different means (quantitative data) was tested by using Mann – Whitney U test for the differences between two independent means, while Pearson's Correlation Coefficients was calculated for the correlation between two quantitative variables. The correlation coefficient value (r) was either positive (direct correlation) or negative (inverse correlation); in addition to the graphical presentation by using Stem-Leaf Plots and Receiver Operation Characteristic (ROC) curve charts.

## Results

**Table (1): Studied (sST2 and IL-33) biomarkers in all combinations of studied groups.**

Biomarkers	Groups	Stable Angina	Unstable Angina	Myocardial Infarction	Healthy Controls	Combinations Groups	Z-value	P value
	Statistics							
sST2 (ng/ml)	5% Trimmed Mean	8.48	8.37	9.31	23.88	SA x UA	-0.666	0.505 NS
	Median	7.90	7.65	7.90	15.40	SA x MI	-0.179	0.858 NS
	Range (minimum-maximum)	(3.70-20.20)	(2.10-26.00)	(2.40-46.20)	(6.40-53.90)	SA x HC	-5.316	0.000HS
	Interquartile Range	2.63	4.30	1.63	30.10	UA x MI	-0.726	0.468 NS
IL-33 (ng/L)	5% Trimmed Mean	969.93	762.21	1279.45	2110	UA x HC	-4.567	0.000HS
	Median	756.40	756.45	912.40	1340.9	MI x HC	-5.021	0.000HS
	Range (minimum-maximum)	(309.90-3731.50)	(173.60-3574.10)	(705.00-4553.90)	(457.50-4383.2)	SA x UA	-0.925	0.355 NS
	Interquartile Range	281.73	528.13	491.03	3395.3	SA x MI	-3.864	0.000HS
						SA x HC	-2.796	0.005 S
						UA x MI	-3.225	0.001HS
						UA x HC	-3.429	0.001HS
						MI x HC	-0.671	0.503 NS

Data presented as 5% Trimmed Mean, median, Interquartile Range and P value tested by Mann-Whitney U Test. SA: Stable angina; UA: Unstable angina; MI: Myocardial infarction; HC: Healthy controls; HS: Highly significant at P value <0.01; S: Significant at P value <0.05; NS: Non significant at P value >0.05; sST2: soluble suppression of tumorigenicity 2; IL-33: Interleukin-33.

In the table (1), the results of the sST2 and IL-33 biomarkers test had reported low levels of estimates

compared with HC group. The 5% trimmed mean (ng/ml) concerning the sST2 was 8.48, 8.37, 9.31 versus 23.88 in SA, UA, MI and HC respectively; the IL-33 was highly significantly decreased in SA and UA groups while not significantly different in MI patients; the 5% trimmed mean (ng/L) concerning the IL-33 was 969.93, 762.21, 1279.45 versus 2110 in SA, UA, MI and HC respectively. Also this table shows that Mann-Whitney-U test statistic for testing distribution of sST2 and IL-33 biomarker's readings in each pair of probable combinations among studied groups. Regarding to sST2

biomarker, the significant differences are accounted at  $P < 0.01$  among the morbidity groups against the HC, while no significant differences at  $P > 0.05$  among diseases combinations groups such as between SA group and each UA and MI groups, and between UA and MI

groups. Regarding to IL-33 biomarker, the significant differences are accounted at  $P < 0.05$ , except between SA and UA groups, and between MI and HC groups, since no significant differences at  $P > 0.05$ .

**Table (2): Statistics of ROC Curve for studied (sST2 and IL-33) biomarkers responding according to (diseases and healthy) groups.**

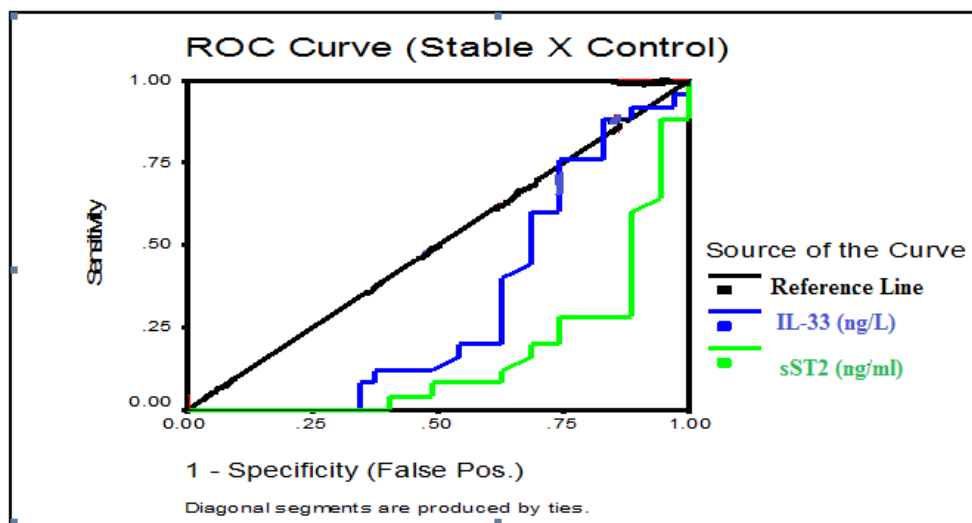
Groups	Biomarkers	Cutoff Point	Sensitivity	Specificity	Area	Standard Error	A. S.	Asymptotic 95% C. I.	
								L. b.	U. b.
Stable Angina	sST2 (ng/ml)	3.850	0.960	0.000	0.160	0.046	0.000 HS	0.070	0.250
	IL-33 (ng/L)	588.25	0.880	0.171	0.321	0.065	0.005 HS	0.194	0.448
Unstable Angina	sST2 (ng/ml)	2.250	0.967	0.000	0.170	0.049	0.000 HS	0.073	0.266
	IL33 (ng/L)	188.35	0.967	0.000	0.252	0.060	0.001 HS	0.134	0.370
Myocardial Infarction	sST2 (ng/ml)	4.350	0.960	0.000	0.179	0.052	0.000 HS	0.077	0.281
	IL33 (ng/L)	730.75	0.960	0.314	0.457	0.073	0.503 NS	0.315	0.599

HS: Highly significant at  $P$  value  $< 0.01$ ; NS: Non significant at  $P$  value  $> 0.05$ ; A. S.: Asymptotic significant; C. I.: Confidence interval; U. b.: Upper bound; L. b.: Lower bound; sST2: soluble suppression of tumorigenicity 2; IL-33: Interleukin-33. The positive actual state is Positive.

In the table (2), the results recorded significant area by Receiver Operation Characteristic (ROC) curve under the guideline of HC group in all IHD groups, with 95% confidence interval (C. I.) of all diseases with HC groups in light of studied sST2 and IL-33 biomarkers. In both SA and UA patients, the results show that the recorded significant area at  $P < 0.01$  concerning both biomarkers, with more accurate concerning sST2 compared with the IL-33, and accordingly indicating that both biomarkers could be reported good indicators for SA and UA diagnosis; while in MI patients, the

results show that the recorded significant area at  $P < 0.01$  concerning sST2 biomarker, and accordingly indicating that the sST2 biomarker could be reported very good indicator for patient's diagnosis with MI, while IL-33 biomarker illustrated weak or non-reliable indicator for MI diagnosis, since significant level was not achieved.

Figures (1,2 and 3) show that the ROC curve distribution concerning the sST2 and IL-33 biomarkers responding according to compare SA, UA and MI patients under the guideline of HC group respectively.



**Figure (1): ROC Curve distribution for studied (sST2 and IL-33) biomarkers distributed according to (stable and healthy) groups. IL-33: Interleukin-33; sST2: soluble suppression of tumorigenicity 2.**

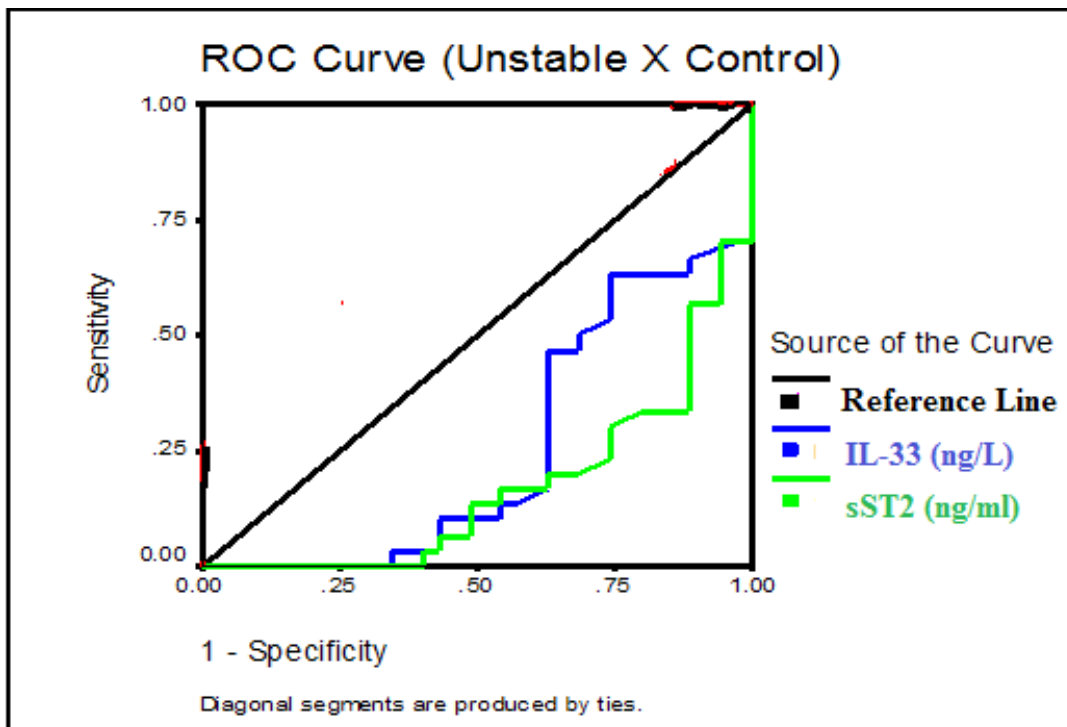


Figure (2): ROC Curve distribution for studied (sST2 and IL-33) biomarkers distributed according to (unstable and healthy) groups. IL-33: Interleukin-33; sST2: soluble suppression of tumorigenicity 2.

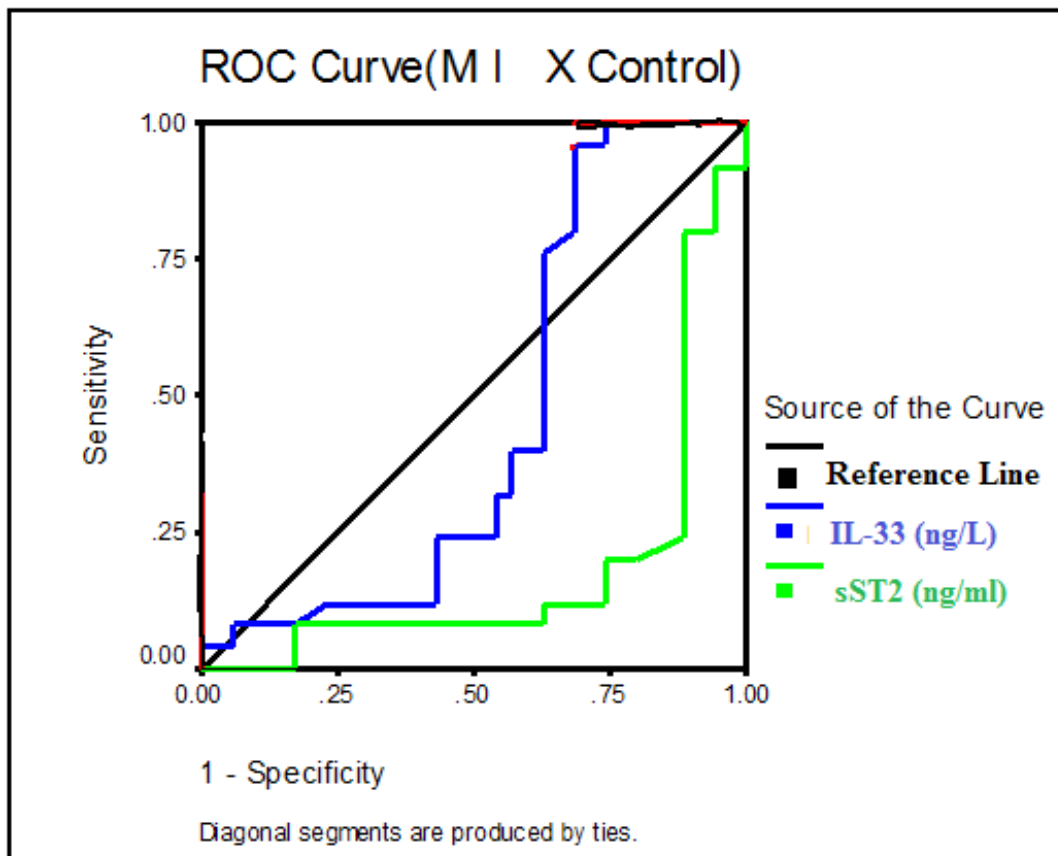


Figure (3): ROC Curve distribution for studied (sST2 and IL-33) biomarkers distributed according to (myocardial infarction and healthy) groups. IL-33: Interleukin-33; MI: Myocardial infarction; sST2: soluble suppression of tumorigenicity 2.

Table (3) shows that there is a perfect positive correlation and a direct proportion between the sST2 and IL-33 biomarkers levels in all disease groups by

using Person’s Correlations Coefficients, with highly significant at P <0.01.

**Table (3): Using Person’s Correlations Coefficientsfor (sST2 and IL-33) biomarkers responding according to stable angina, unstable angina and myocardial infarction groups.**

Morbidity Groups	Marker (ng/ml)	Statistics	IL33 (ng/L)
Stable Angina	sST2	Correlation Coefficient	0.862
		Significant (1-tailed)	0.000HS
		No.	50
Unstable Angina	sST2	Correlation Coefficient	0.469
		Significant (1-tailed)	0.004HS
		No.	30
Myocardial Infarction	sST2	Correlation Coefficient	0.505
		Significant (1-tailed)	0.000 HS
		No.	50

HS: Highly significant at P value <0.01; No.: Number; sST2: soluble suppression of tumorigenicity 2; IL-33: Interleukin-33.

### Discussion

The atherosclerosis formation tends to increase with age<sup>(8)</sup> and most of the IHD cases occur after the age of 65 years<sup>(9)</sup>. The male gender is one of the risk factors for IHD<sup>(10)</sup>, so the present study results were compatible with the results of many studies regarding to the age and gender<sup>(11, 12)</sup>.

Tobacco smoking is the most avoidable and strongest IHD risk factor<sup>(13)</sup>. It causes the death in IHD cases<sup>(14)</sup>, the present study smoking results are exactly compatible with Radovanovic *et al*<sup>(8)</sup> and agree with Mohammad *et al*<sup>(15)</sup> studies results. Blood cholesterol is a predictive risk factors for CAD<sup>(16)</sup>, and it play a role in the atherosclerosis development<sup>(17)</sup>, so the present study cholesterol test results are agree with Chauhan and Trivedi<sup>(13)</sup>, and Oommen *et al*<sup>(18)</sup> studies results.

The ST2 is released when myocytes are under stress or injured<sup>(19)</sup>, it plays a role in inflammatory signaling<sup>(20)</sup>, cardiac fibrosis<sup>(21)</sup>, and is involved in cardiac function and dysfunction<sup>(22)</sup>. In the extra cellular environment, the sST2 can act as a decoy receptor by binding free IL-33<sup>(6)</sup>.

The IL-33 is a functional ligand for ST2L, is expressed by myocardial cells, it has a cardioprotective role and inhibits the atherosclerotic plaques

development<sup>(23)</sup>. IL-33 is expressed by myocardial and coronary arterial smooth muscle cells<sup>(24)</sup>. Both IL-33 and sST2 are expressed in atherosclerotic plaques, when sST2 is binding the free IL-33, the IL-33 level that is available for ST2L binding will be decreased, inhibiting the effects of IL-33/ST2L signaling which has a cardioprotective function<sup>(25)</sup>. This IL-33/ST2L signaling may be triggered by IL-33 or increased by inhibiting sST2<sup>(26)</sup>, so by the measurement of sST2 level, we can understand the role of IL-33 in IHD<sup>(27)</sup>, so it is very important to study them together. Some results suggest that the ST2 concentrations may be elevated in some MI patients<sup>(28,29)</sup>, while some studies revealed that its level may be not elevated in the MI patients<sup>(30)</sup>. It was found that the IL-33 levels were not different between the patients with the MI and the control group<sup>(31)</sup>, while other study showed that the patients with heart failure with non-ischemic etiology had higher IL-33 levels than those with ischemic etiology<sup>(32)</sup>. The presence of the IHD risk factors such as age, gender or smoking does not influence the serum levels of both sST2<sup>(31,33)</sup> and IL-33 biomarkers<sup>(27)</sup>.

Regarding to the sST2 biomarker level, this study recorded that there was some elevation of sST2 level in the HC group in comparison with the lower levels in the morbidity groups; in the HC group, the minimum level was (6.4 ng/ml) and the maximum level was (53.9 ng/ml),

while the minimum level in the morbidity groups was in the UA group (2.1 ng/ml) and the maximum level was in the MI group (46.2 ng/ml). Some studies recorded that there were low levels of sST2 (6.2 ng/ml) in MI<sup>(30, 34, 35)</sup>. The sST2 is also elevated in the asthma and autoimmune disease<sup>(7)</sup>; it reflects a non-specific inflammatory response thus limits its specificity and diagnosis for any disorder including IHD<sup>(5, 36)</sup>. The sST2 peak level occurred at 12 hours<sup>(37)</sup> (6-18 hours of symptom onset) then is followed by a significant decreasing to a stable level by (24-42 hours) after the onset<sup>(21, 33)</sup>.

Early post infarction sST2 values (i.e., < 24 hours after symptom onset) have the greatest significant prognosis<sup>(33)</sup>, as it has been found that the baseline sST2 levels were significantly higher (the cutoff value of 58.7 ng/mL) in those patients who died or developed new MACEs such as heart failure or recurrent MI either in MI, in stable IHD or even in subjects without known IHD, during short-term follow-up (30 days) than those patients without MACEs<sup>(7, 21, 29, 31, 35)</sup>. So the importance of early sST2 levels is for the best prognostic information<sup>(33)</sup>, so that we can prevent morbidity and mortality of the IHD by providing rapid and appropriate therapy<sup>(37)</sup>. In addition to that the most of Iraqi patients are too late to come to the hospital or physician after the beginning of symptom onset, the Iraqi patient may come after 24 hours of his first complain, so the sST2 peak level could not be detected in such situation as we knew that the peak level is 12 hours after the symptom onset.

In comparison with HC group, one of the studies stated that the ST2 baseline level had a clinical significant in SA patients<sup>(33)</sup> and it was reported that there was a significant difference in both UA and MI patients<sup>(31)</sup>. In diseases combination groups, it was showed that there was no significant difference between SA and MI groups, and confirmed that the sST2 has no significant distribution value for combination of UA and MI groups<sup>(34)</sup>. The study of Karimzadeh *et al*<sup>(38)</sup> observed that there was a significant correlation between the serum sST2 and IL-33 biomarkers levels in all the IHD.

In diseases combination groups, concerning to IL-33, it was showed that there was no significant difference between SA and UA groups<sup>(31, 35)</sup>; some studies showed that there was a significant difference between SA and MI groups and suggested that in SA patients, the IL-33 has a protective role against progression to UA or MI stage<sup>(41)</sup>, while it was demonstrated that there was

a significant difference between UA and MI groups regarding to IL-33<sup>(27)</sup>.

**Conflict of Interest:** None

**Source of Findings:** None

**Ethical Clearance:** None

## References

1. Kanu, J. S., Gu, Y., Zhi, S., Yu, M., Lu, Y., Cong, Y., Liu, Y., Li, Y., Yu, Y., Cheng, Y. and Liu, Y. Single nucleotide polymorphism rs3774261 in the AdipoQ gene is associated with the risk of coronary heart disease (CHD) in Northeast Han Chinese population: a case-control study. *Lipids in health and disease*, 2016. 15(1), 6.
2. Bashore, T. M., Granger, C. B., Jackson, K. P., and Patel, M. R. Chapter 10 Heart disease. In Papadakis, M. A., and McPhee, S.J. *Current medical diagnosis and treatment*. 2019, 58<sup>th</sup> ed., pp. 365-392. McGraw-Hill.
3. Jakovljevic, V., and Djordjevic, D. Physical activity for the prevention of cardiovascular diseases. *Serbian Journal of Experimental and Clinical Research*, 2017. 18(2), 99-109.
4. Wang, J., Tan, G. J., Han, L. N., Bai, Y. Y., He, M., and Liu, H. B. Novel biomarkers for cardiovascular risk prediction. *Journal of geriatric cardiology: JGC*, 2017. 14(2), 135-150.
5. Pusceddu, I., Dieplinger, B., & Mueller, T. ST2 and the ST2/IL-33 signalling pathway—biochemistry and pathophysiology in animal models and humans. *Clinica Chimica Acta*, 2019. 495, 493-500.
6. Chen, S., Chen, B., Wen, Z., Huang, Z., and Ye, L. IL-33/ST2-mediated inflammation in macrophages is directly abrogated by IL-10 during rheumatoid arthritis. *Oncotarget*, 2017. 8(20), 32407-32418.
7. Guria, R. T., Marandi, S., and Srivastava, M. Relationship between serum concentration of the soluble interleukin-1 receptor family member ST-2 and serial change in left ventricular function after acute myocardial infarction. *IOSR Journal of Dental and Medical Sciences (IOSR-JDMS)*, 2018. 17(5), Ver. 6, 11-15.
8. Radovanovic, D., Pilgrim, T., Seifert, B., Urban, P., Pedrazzini, G., and Erne, P. Type 2 myocardial infarction: incidence, presentation, treatment and outcome in routine clinical practice. *Journal of*

- Cardiovascular Medicine, 2017.18(5), 341-347.
9. Eljedi, A., and Mushtaha, M. Risk Factors of Coronary Artery Disease in Palestinian Patients Undergoing Coronary Angiography: A Case–Control Study. *Journal of Advances in Medicine and Medical Research*, 2015.5(1), 88-97.
  10. Shen, J., Zhang, J., Wen, J., Ming, Q., Zhang, J., and Xu, Y. Correlation of serum alanine aminotransferase and aspartate aminotransferase with coronary heart disease. *International journal of clinical and experimental medicine*, 2015.8(3), 4399-4404.
  11. Venkatesh K., Deepak D. C., and Venkatesha, V. T. Escalation of coronary atherosclerosis in younger people by comparison of two autopsy studies conducted a decade apart. *Heart views: the official journal of the Gulf Heart Association*, 2018.19(4), 128-136.
  12. Chauhan, P. A., and Trivedi, A. Study of perception and behaviour in patients with coronary heart disease about risk factors and life style modification in tertiary care hospital, Bhavnagar. *International Journal of Community Medicine and Public Health*, 2019.6(4), 1549-1553.
  13. Ciapponi, A., and World Health Organization (WHO). Systematic review of the link between tobacco and poverty. 2014.
  14. World Health Organization. WHO report on the global tobacco epidemic, 2017: monitoring tobacco use and prevention policies. World Health Organization.
  15. Mohammad, A. M., Sheikho, S. K., and Tayib, J. M. Relation of cardiovascular risk factors with coronary angiographic findings in Iraqi patients with ischemic heart disease. *American Journal of Cardiovascular disease research*, 2013.1(1), 25-29.
  16. Borland, M. (2018). Exercise-based cardiac rehabilitation, physical fitness, and physical activity in cardiac disease. *Sahlgrenska Academy, University of Gothenburg*.
  17. Yang, N., Feng, J. P., Chen, G., Kou, L., Li, Y., Ren, P., Zhao, L. L., and Qin, Q. Variability in lipid profile among patients presented with acute myocardial infarction, unstable angina and stable angina pectoris. *Eur Rev Med Pharmacol Sci*, 2014. 18(24), 3761-3766.
  18. Oommen, A. M., Abraham, V. J., George, K., and Jose, V. J. Prevalence of coronary heart disease in rural and urban Vellore: a repeat cross-sectional survey. *Indian heart journal*, 2016. 68(4), 473-479.
  19. Villacorta, H., and Maisel, A. S. Soluble ST2 testing: a promising biomarker in the management of heart failure. *Arquivos brasileiros de cardiologia*, 2016.106(2), 145-152.
  20. Pfetsch, V., Sanin, V., Jaensch, A., Dallmeier, D., Mons, U., Brenner, H., ... and Koenig, W. Increased concentrations of soluble ST2 independently predict cardiac and total mortality but not non-fatal cardiovascular events in stable coronary heart disease patients. *Atherosclerosis*, 2017.263, e46-e47.
  21. Aleksova, A., Paldino, A., Beltrami, A. P., Padoan, L., Iacoviello, M., Sinagra, G., and Maisel, A. S. Cardiac Biomarkers in the Emergency Department: The Role of Soluble ST2 (sST2) in Acute Heart Failure and Acute Coronary Syndrome—There is Meat on the Bone. *Journal of clinical medicine*, 2019.8(2), 270.
  22. Barnett, O., Polyetayeva, K., Halkevych, M., Lutsiv, N., Hrytsak, R., Blazhivska, I., and Kumurzhi, S. Novel marker of myocardial remodeling ST2 and the influence of aldosterone antagonist in patients with heart failure caused by hypertension and ischemic heart disease. *Journal of Hypertension*, 2018.36, e163.
  23. Van Vark, L. C., Lesman-Leege, I., Baart, S. J., Postmus, D., Pinto, Y. M., Orsel, J. G., and Hillege, H. L. Prognostic value of serial ST2 measurements in patients with acute heart failure. *Journal of the American College of Cardiology*, 2017, 70(19), 2378-2388.
  24. Demyanets, S., Kaun, C., Pentz, R., Krychtiuk, K. A., Rauscher, S., Pfaffenberger, S., and Huber, K. Components of the interleukin-33/ST2 system are differentially expressed and regulated in human cardiac cells and in cells of the cardiac vasculature. *Journal of molecular and cellular cardiology*, 2013.60, 16-26.
  25. Vianello, E., Dozio, E., Tacchini, L., Frati, L., and Romanelli, M. M. C. ST2/IL-33 signaling in cardiac fibrosis. *The International Journal of Biochemistry & Cell Biology*, 2019.116, 105619.
  26. Caselli, C. Inflammation in cardiac disease: focus on Interleukin-33/ST2 pathway. *Inflammation and Cell Signaling*, 2014.
  27. Jafarinia, M., Firuzsalari, F. G., and Zaringol, M.

- Serum levels of interleukin (IL)-33 in patients with ischemic heart disease. *MOJ Immunol*, 2018,6(2), 29-32
28. Snider, J. V., and Jacobson, S. Interleukin-33 (IL-33) for the diagnosis and prognosis of cardiovascular disease. U.S. Patent Application 2011, No. 12/943,676.
  29. Jenkins, W. S., Roger, V. L., Jaffe, A. S., Weston, S. A., AbouEzzeddine, O. F., Jiang, R., ... and Enriquez-Sarano, M. Prognostic value of soluble ST2 after myocardial infarction: a community perspective. *The American journal of medicine*, 2017,130(9), 1112-e9-1112-e15.
  30. Parenica, J., Malaska, J., Jarkovsky, J., Lipkova, J., Dastych, M., Helanova, K., ... and Gal, R. Soluble ST2 levels in patients with cardiogenic and septic shock are not predictors of mortality. *Experimental & Clinical Cardiology*, 2012, 17(4), 205-209.
  31. Demyanets, S., Speidl, W. S., Tentzeris, I., Jarai, R., Katsaros, K. M., Farhan, S., ... and Wojta, J. Soluble ST2 and interleukin-33 levels in coronary artery disease: relation to disease activity and adverse outcome. *PLoS One*, 2014, 9(4), e95055.
  32. Segiet, O. A., Romuk, E., Nowalany-Kozielska, E., Wojciechowska, C., Piecuch, A., and Wojnicz, R. The concentration of interleukin-33 in heart failure with reduced ejection fraction. *Anatolian journal of cardiology*, 2019, 21(6), 305-313.
  33. Richards, A. M., Di Somma, S., and Mueller, T. ST2 in stable and unstable ischemic heart diseases. *The American journal of cardiology*, 2015,115(7), 48B-58B.
  34. Marino, R., Magrini, L., Orsini, F., Russo, V., Cardelli, P., Salerno, G., ... and NETWORK, G. Comparison between soluble ST2 and high-sensitivity troponin I in predicting short-term mortality for patients presenting to the emergency department with chest pain. *Annals of laboratory medicine*, 2017.37(2), 137-146.
  35. Liu, X., Hu, Y., Huang, W., Zhang, G., Cao, S., Yan, X., and Zheng, X. (2019). Soluble ST2 for prediction of clinical outcomes in patients with ST-segment elevation myocardial infarction receiving primary PCI. *International heart journal*, 2019.18-20.
  36. Wang, Y., and Wang, B. Research Progress of IL-33/ST2 Signaling Pathway in Cardiovascular Disease. 8th International Conference on Management, Education and Information . *Advances in Intelligent Systems Research*, 2018,163, 495-499. Atlantis Press.
  37. Ardhana, T., Aminuddin, M., and Nugraha, J. Relationship between N-Terminal pro-Brain Natriuretic Peptide (NT-proBNP) level and protein ST2 level in acute coronary syndrome patient. *Folia Medica Indonesiana*, 2013. 49(4), 202-207.
  38. Karimzadeh, S., Zamani, S., Amirzade-Fard, F., Ardekani, A. A., & Doroudchi, M. Correlation between IL-33 and sST2 levels in sera of patients with acute myocardial infarction. *Biomedical Research*, 2017,28 (16), 7027-7034.



# Brain Hydatidosis Surgical Outcome

Mohammed Z. Shaker<sup>1</sup>, Nashwan Y. Sallama<sup>1</sup>, Mohammed I. Ramadhan<sup>1</sup>

<sup>1</sup>Neurosurgeon, Department of Neurosurgery, Ibn-sina Teaching Hospital, Mosul, Iraq

## Abstract

**Background:** Brain Hydatidosis is one of common parasitic brain diseases accounted in Iraq. This is prospective study done in mosul teaching hospital in Iraq during 2007-2020.

**Material and Method:** All patient data had collected from the records of 19 patients admitted to Mosul center with hydatidosis, including clinical features and imaging investigation in addition to operative record .Follow up of all included patient was achieved.

**Results:** Ninteen patients were included, twelve male and seven female . Eighteen patients were of intracerebral hydatidosis while one was extradural. Eight patients in parietal lobe, five patients in frontoprietal lobe,,three patients in occipital lobe, two in cerebellum and one patient in frontal. Age ranged 3-45 years where sixteen patients were children. Three patients get multiple cysts while the other sixteen get solitary hydatid cyst. All patients were treated by craniotomy and total excision (delivery) of hydatid cyste(s) while rupture occurred on one case and albendazole had given for all of patients postoperativly. All patients except two get retune to normal neurological function while one still in deficit the other one died due to postoperative infection. No recurrence was seen.

**Conclusion:** Brain hydatidosis is still seen in our country and early surgery provide good treatment in addition to use of albendazole while mortality and morbidity are not uncommon postoperative events.

**Keywords:** *Hydatid cyst, Brain infestations, Iraq.*

## Introduction

hydatid disease is a chronic zoonotic helminthic infection caused by larval stage of the dog tapeworm called *Echinococcus granulosus*. Hydatidosis is endemic throughout Middle East<sup>1,2</sup>. This disease is usual in areas that cattle, sheep, and dogs are kept. Liver and lungs are common involved organs but in other organs of body such as bones, brain and heart may be found<sup>3,4,5</sup>. Human infestation may take one of the three forms: unilocular hydatid disease caused by *Echinococcus granulosus*, multilocular or alveolar disease caused by *Echinococcus multilocularis* and polycystic hydatid disease caused by *Echinococcus vogeli*. Members of the dog family are definitive hosts for these minute tapeworms. Eggs are passed in the stools and ingested by the intermediate hosts, which include sheep, cattle, pigs, rodents and other herbivorous animals. Humans, especially children are infected. Following the accidental ingestion of eggs from environment, the eggs hatch in the intestine and the embryo penetrate the intestinal wall and then enter

the blood stream. Although most hydatids develop in the liver, some disseminated to other sites. These may even reach the brain<sup>6</sup>. Larval stage of the cestode can involve the brain via the choroid plexus.<sup>7</sup> Cerebral hydatid cyst are usually localised within the watershed zone of the middle cerebral arteries, often in the parietal lobe.<sup>8,9</sup> Cerebral hydatid cysts are usually single, spherical and unilocular<sup>10,11</sup>

Its incidence is 1–2% of all cases with hydatid disease. Brain hydatidosis is an important differential diagnosis of intracranial cystic lesions in endemic regions, for example, the Middle-Eastern countries.

## Subjects and Method

Study method include that retrospectively reviewing the clinical features (neurological symptoms and signs), radiological manifestations (X-ray, computerized tomography (CT) scan or magnetic resonance imaging (MRI)) and surgical outcome of 19

patients with intracranial hydatid cysts whom received surgical treatment at the Neurosurgical Department of Ibn Sina hospital from January 2007 to January 2020. The patients records were retrospectively reviewed all the clinical, radiological data of all patients who were diagnosed as harboring an intracranial hydatid cyst during the period of study and subsequently underwent surgery at the Department of Neurosurgery, Ibn Sina hospital. Follow up of patients was done by clinical and radiological evaluation for a minimum period of 6 months up to 2 years .

Surgical therapy was adopted for all patients and Craniotomy with big osteoplastic flap and use of Dowling-Orlando’s technique for delivery of hydatid cyst was the only type of surgery for all patients. Medical thereapy: albendazol as chemotherapy for 28 days had been standard way of medical treatment after surgery.

### Results

The current study has included nineteen patients of them twelve male (63-%) and seven female (37%) .

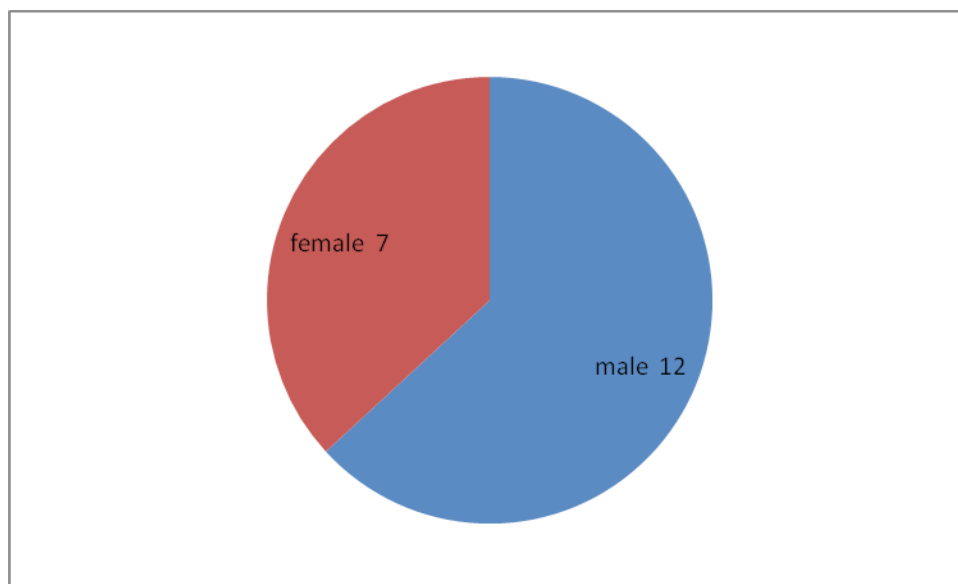


Figure (1): Sex distribution

The age distribution was 16 patients in childhood age (below 18 years) and three were adults.

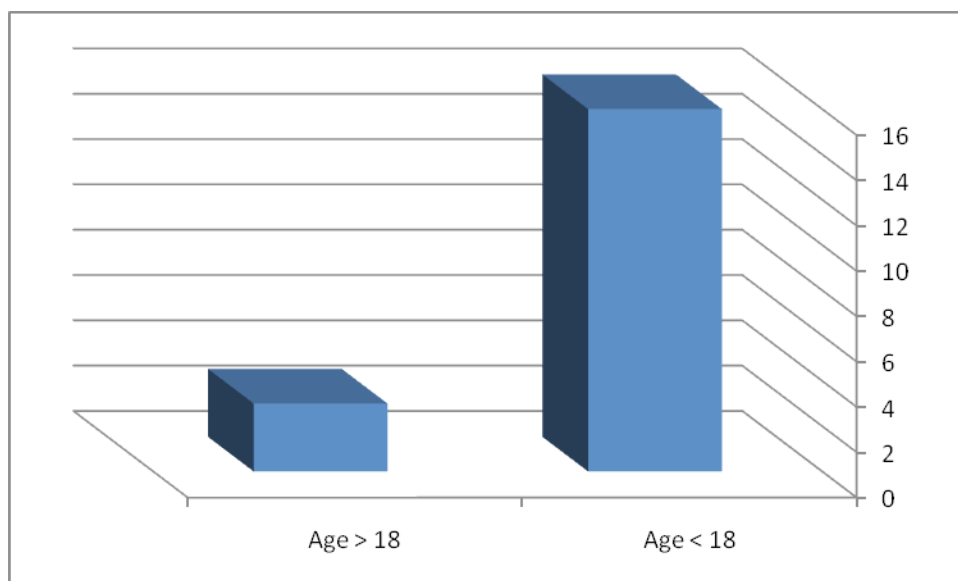


Figure (2): Age distribution

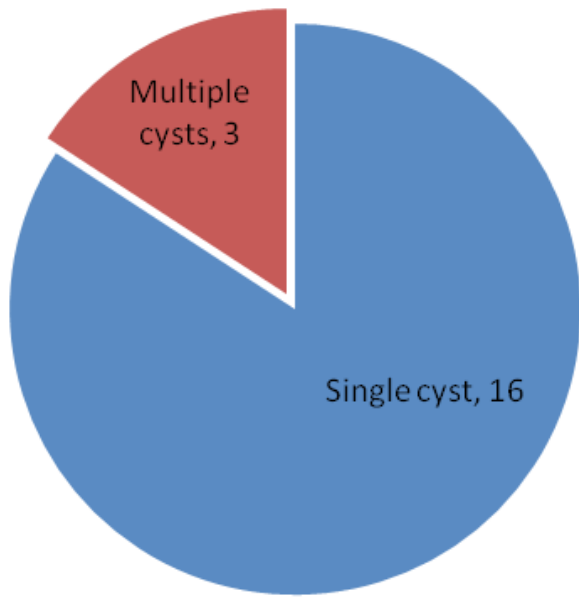
All patients in this study were from rural area except one,two adult patients were from one family. The clinical features at time of patients presentation was headache in 17 of cases, seizure in 4 cases, motor weakness in 17 cases, vomiting in 4 cases and altered level of consciousness in 5 cases. Behavior changes were in one patient .

While the clinical signs revealed papilledema in 12 cases, sixth cranial nerve pulsy in 3 cases .

**Table 1: Clinical presentation distributions**

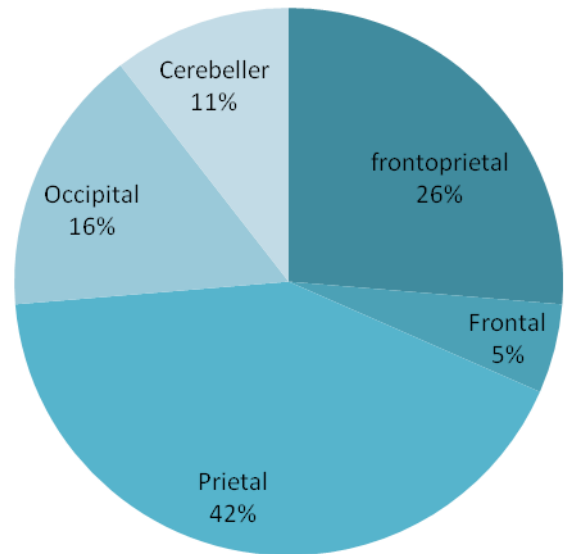
	Number of cases
Headache	17
Vomitting	4
Seizure	4
Motor weakness	17
Disturbe level of consciousness	5
Behavior changes	1
Papilledema	12
Sixth nerve pulsy	3

All patients had investigated by CT and MRI, with three patient harbor multiple cyst while the others diagnosed as single cerebral hydatidosis.



**Figure (3): Multiplicity of cyst distribution**

The anatomical distribution of cysts were eight patients in parietal lobe, five patients in frontoparietal lobe,,three patients in occipital lobe, two in cerebellum and one patient in frontal.



**Figure (4): Anatomical location distributions**

All patients were underwent craniotomy within 24-48 hours after establishment of diagnosis and successfully intact delivery of cyst(s) achieved in eighteen patients while rupture of multiple extradural cysts had occur .

All patients were kept in hospital 5-14 days and then discharge home.

**Discussion**

Echinococcosis (hydatid disease or hydatidosis), caused by the cestode *Echinococcus granulosus* is a widespread zoonotic illness and can involve brain in rare cases, They account for 1% to 5% of all intracranial masses in endemic areas<sup>12, 13</sup>The natural history of the cerebral hydatidosis is usually slow and presents late when they reach relatively large volume. There is no consensus on the growth rate of the hydatid cysts of the brain and has been variably reported between 1.5-10 cm/year<sup>14</sup>

The dominance paediatric involvement by hydatid cyst had proved in this series with the 86% of incidence who were less than 15 years age that stay one of the most agreed point in most of the published seriesas inIzci *et al* who reported a series of 17 patients with intracranial hydatid cysts and 13 (65%) of these patients were children adopting the patent ductus arteriosus or the direct contact with dogs or eating contaminated food and milk.<sup>15, 16,17</sup>

We founded in this study that pediatric cerebral hydatid disease involves all intracranial parts while cerebellum was immune in adult patients.Although

the paediatric predominance the male gender was predominant in paediatric group (3:1) while the reverse in adult group where female appeared to be more involved (2:1). The cerebral hydatid cyst can be single (primary) or multiple (secondary). In this series there were two multiple cysts cases in paediatric group and only one in adult, while all the cerebellar hydatid cases were of single type.

In the view of intracranial compartment distribution the supratentorial distribution of cysts were observed in all cases except two, with high prevalence for parietal lobe as it involved in 12 patients (80%) the same observation were reported for all four cases reported by Dharker et al<sup>18</sup> and three out of five cases of intracerebral hydatid cysts reported by Balasubramaniam et al<sup>19</sup> had parietal lobe involvement which reflect the distribution of middle cerebral artery supplement.

As any slowly growing brain space occupying mass the common presentations of patients in this series were symptoms and signs of raised intracranial pressure and/or pressure effect. The vast majority were present with headache (90%) and found to get papilloedema in 12 patients (63%) which can be explained by the large size of the cyst as there was no hydrocephalus in all patients. The same proved by Erashin et al<sup>20</sup> who observed that 18 out of 19 cases presented with raised intracranial pressure symptoms and signs, As the common site of cerebral hydatidosis was parietal, frontal and frontoparietal region (73%) in this series the common local pressure feature was motor weakness observed in 90% of patients.

The adoptive surgical procedure (Dowling-Orlando's technique) had proved to yield high success rate in the delivery of intact brain hydatid cyst which achieved in 95% of cases and hence the recurrence rate was very low compared with relatively significant recurrence in ruptured hydatid surgically treated by other procedures who showed 0.3–53%<sup>21</sup> while other writer had founded almost recurrence of all rupture cases as in El-Shamam et al.<sup>22</sup>

The adaptation of Dowling-Orlando's technique in this series with low rupture rate led to the absence of serious complication. Even the ruptured cysts had occurred in extradural case with good recovery. The potential for effective treatment is greater with intradural cysts, since they are often single and have thicker walls; then intact removal is more likely. measures should be

adopted to reduce the likelihood of intraoperative rupture because it is not only associated with the recurrence of the lesion, but also causes various types of allergic reactions and even anaphylactic shock<sup>23</sup>

There were no difference in the delivery of intracerebral single or multiple cysts as rupture occurred in the extradural cysts only which may attributed to more adherence between dura and cysts. The only one patient died after operation by two weeks from infection had occurred in 6 years age child harboring cerebellar single cyst, Most of all cases harbored giant cyste(s) with extension to the cortex and this made delivery of cyst more easy with less neural tissue injury. Adopting albendazole therapy for all patients after operation in doses for patients weighing more than 60 kg in a dose of 400 mg twice daily for 28 days. A dose of 15 mg/kg of body weight daily in 2 divided doses (not to exceed total daily dose of 800 mg) has been suggested for patients weighing less than 60 kg. There were no significant side effects observed from use of this drug among our patients

## Conclusions

The hydatid cyst still not uncommon in the middle east countries and should not be under estimated, Early diagnosis at time being is feasible in the availability of imaging techniques and the unique feature of cyst. Adopting Dowling-Orlando's technique in the surgical management of brain hydatidosis proved to yield excellent results with low mortality and morbidity rate. We advise for Albendazole therapy for 28 days after surgery.

**Conflict of Interest:** None

**Source of Findings:** None

**Ethical Clearance:** None

## References

1. Rostami Nejad M, Hoseinkhan N, Nazemalhosseinim E, Cheraghipour K, Abdinia E, Zali MR. An analysis of hydatid cyst surgeries in patients referred to hospitals in Khorram-Abad, Lorestan during 2002-06. *Iranian J Parasitol.* 2007;2(3):29-33.
2. Rokni MB. Echinococcosis/hydatidosis in Iran. *Iranian J Parasitol.* 2009; 4:1-16.
3. King CH. Cestodes (tapeworms). In: Mandell GL, Bennett JE, Dolin RE, eds. *Mandell, Douglas and*

- Bennett's principles and practice of infectious diseases. 6th ed. Philadelphia: Churchill Livingstone. 2005;3285-93.
4. Al-Bassam A, Hassab H, al-Olayet Y, Shadi M, al-Shami G, al-Rabeeah A, Jawad A. Hydatid disease of the liver in children. *Ann Trop Paediatr.* 1999; 19:191-6.5.
  5. Akhlaghi L, Massoud J, Housaini A. Observation on hydatid cyst infection in Kordestan Province (West of Iran) using epidemiological and seroepidemiological criteria. *Iranian J Publ Health.* 2005; 34:73-5.
  6. Fritsche TR, Selvarangan R. Medical parasitology. In: McPherson & Pincus: *Henry's Clinical Diagnosis and Management by Laboratory Method.* 21<sup>st</sup> edition. Philadelphia, PA : Elsevier 2007 : 1158.
  7. Aydin MD, Ozkan U, Altinors N. Quadruplets hydatid cysts in brain ventricles: a case report. *Clin Neurol Neurosurg* 2002; 104: 300 – 2.
  8. Menku A, Kurtsoy A, Tucer B, et al. Calcified cerebral hydatid cyst following head trauma: case report. *Turk Neurosurg* 2004; 14: 1 – 2, 36 – 40.
  9. Roquer J, Escudero D, Guelar A, et al. Calcified cerebral hydatid cyst in a patient with abdominal hydatidosis. *Med Clin (Barc)* 1985; 85: 458 – 60.
  10. Baysefer A, Erdogan E, Gonul E, et al. Primary multiple cerebral hydatid cysts: case report. *Surg Neurol* 1998; 41: 35 – 7.
  11. Ramsey PG, Plorde JJ. Cestode infestation. In: Ramsey PG, Plorde JJ, Fauci AS, Braunwald E, Isslbacher KJ, eds. *Harrison's Principles of Internal Medicine.* New York : McGraw-Hill 1987:825–9.
  12. Diren HB, Ozcanli H, Boluk M, Kilic C. Unilocular orbital, cerebral and intraventricular cyst: CT diagnosis. *Neuroradiology.* 1993;35:149–150.
  13. Chang KH, Cho SY, Hesselink JR et al. Parasitic diseases of the central nervous system. *Neuroimaging Clin North Am.* 1991;1:159–178.
  14. Seirra J, Oviedo J, Berthier M et al : Growth rate of secondary hydatid cysts of the brain. *J Neurosurg* 1985; 62 : 781-782.
  15. Dharker SR : Hydatid disease. In : *Text Book of Neurosurgery, Second edition.* Eds. Ramamurthi B, Tandon PN. Churchill Livingstone, New Delhi 1996; 535-544.
  16. Jimenez-Mejias ME, Castillo-Ojeda E, Cuello-Contreras JA et al : Cerebral hydatidosis. Analysis of a series of 23 cases. *Med Clin (barc)M* 1991; 97: 125-132.
  17. Izci Y, Tüzün Y, Seçer HI, Gönül E. Cerebral hydatid cysts: Technique and pitfalls of surgical management. *Neurosurg Focus.* 2008;24:E15.
  18. Dharker SR, Dharker RS, Vaishya ND et al., Cerebral hydatid cysts in central India. *Surg Neurol* 1977; 8 : 31-34.
  19. Balasubramaniam V, Ramanujam PB, Ramamurthi B et al : Hydatid disease of the nervous system. *Neurol India* 1970; 18: 92-95.
  20. Erashin Y, Mutluer S, Guzelbag E : Intracranial hydatid cysts in children. *Neurosurgery* 1993; 33: 219-224.
  21. Erşahin Y., Mutluer S., Güzelbag E. Intracranial hydatid cyst in children. *Neurosurgery* 1993; 33: 219-225
  22. El-Shamam O., Amer T., El-Atta M.A. Magnetic resonance imaging of simple and infected hydatid cysts of the brain. *Magn Reson Imaging* 2001; 19: 965-974
  23. Pamir M, Ozduman K, Elmaci I. Spinal hydatid disease. *Spinal Cord.* 2002; 40: 153-160.

# Evaluation the Role of Malondialdehyde in Occurrence and Development of Diabetic Retinopathy Patients

Marwa Riyadh Khalaf<sup>1</sup>, Mutaz Sabah Ahmeid<sup>2</sup>, Osamah Jihad Abdulqader<sup>3</sup> Hashim Abdulsattar Jabar<sup>4</sup>

<sup>1</sup>Student, Kirkuk Health Directorate, Kirkuk, <sup>2</sup>Assist. Prof., M.B.Ch.B, M.Sc, Ph.D in Clinical Biochemistry, College of Medicine, Tikrit University, <sup>3</sup>Prof., MBCHB. FIBMSophth. FICO, <sup>4</sup>Lec., B.Sc, M.Sc in Chemistry, Department of Biochemistry, College of Medicine, Tikrit University/B.Sc, M.Sc in Chemistry, Department of Biochemistry, College of Medicine, Tikrit University, Iraq

## Abstract

Case control study was carried out in Salah-Addin city in private ophthalmology clinic from 1st November of 2019 to End february 2020. The study included 90 individuals including sixty diabetic patients (30 who had retinopathy and 30 without retinopathy) and 30 healthy individuals to evaluate the level of Malondialdehyde (MDA) in diabetic patients with and without retinopathy and healthy controls. All patients were aged between (51-82) years, with a negative history of antioxidant supplementation consumption. Blood samples were collected from each patients and controls to evaluate the levels of malondialdehyde and HbA1c by using immunofluorescence technique. The study showed that majority of diabetic retinopathy (DR) patients were females and the highest mean of age was recorded in diabetic retinopathy patients (60.76±7.25 year) compared with diabetic without retinopathy patients (58.31±9.19 year). The study displayed that the highest mean of MDA was recorded in DR patients as compared with diabetic without retinopathy patients (390.37±108.68 vs 336.97±94.95 ng/ml), although the result was non-significant (P: > 0.05). The study showed that the highest mean of MDA was in DR patients (390.37±108.68 ng/ml) followed by diabetic without retinopathy patients (336.97±94.95 ng/ml) and the lowest mean was in healthy individuals (293.32±42.51 ng/ml), (P: < 0.05). The study showed that, HbA1c was elevated significantly (P<0.05) in diabetic retinopathy patients (9.26±1.54) compared with diabetic without retinopathy patients (7.84±1.02). The present study displayed that the highest mean of duration of DM was recorded in diabetic retinopathy patients (13.48±6.00) compared with Diabetic without retinopathy patients (6.34±2.78), the result was significant (P:<0.05). The study showed negative correlation between HbA1c and BMI in DR patients; and no correlation between HbA1c and BMI in DM patients without retinopathy, The study showed negative correlation between MDA and HbA1c in DR patients and no correlation in DM patients without retinopathy.

**Conclusion:** Long duration of DM and the old age were risk factors for DR, poor control of was more disposed to develop retinopathy and oxidative stress is still higher in diabetic patients with retinopathy than patients without retinopathy.

**Keywords:** Malondialdehyde; Diabetic retinopathy; Oxidative stress; HbA1c.

## Introduction

Diabetes mellitus (DM) is expected to affect around 550 million people all over the world according to global estimates of the prevalence of diabetes<sup>(1)</sup>. DM is characterized by constant hyperglycemia that damages various organs and manifests in macro vascular complications like premature atherosclerosis resulting in strokes, peripheral vascular disease, and myocardial infarctions and micro vascular complications such as

nephropathy, neuropathy, and retinopathy<sup>(2)</sup>. Diabetic retinopathy (DR) is the number one cause of blindness in people between 27 and 75 years of age. Prevalence of DR is around 25% and 90% at 5 and 20 years, respectively, from diagnosis; it is calculated that 191 million people will be diagnosed with this micro-vascular complication by the year 2030<sup>(3)</sup>. Through the last three decades, extensive scientific reports have shown ROS to play an important role in DM complications such as diabetic neuropathy,

nephropathy, and retinopathy due to alterations on the biomechanisms involved in the instauration and progression of micro-vascular complications<sup>(4)</sup>. These three micro-vascular complications share high glucose levels as a starting point; such condition is necessary, but may not be enough to initiate the damage present in the peripheral nervous system (neuropathy), kidneys (nephropathy), and retinas (retinopathy) of diabetic patients<sup>(5,6)</sup>. Hyperglycemic states favor the activation of alternative pathways leading to reactive oxygen species (ROS) formation and augmented concentrations locally and in the rest of the body even at the point of surpassing the antioxidant capacity, a state known as oxidative stress affecting retinal integrity<sup>(7,8)</sup>. The study aim of this work was to evaluate the level of Malondialdehyde (MDA) in diabetic patients with and without retinopathy and healthy controls.

**Patients and Method**

Case control study was carried out in Salah-Addin city, a private ophthalmology clinic from 1st November of 2019 to End february 2020. The study included 90 individuals including sixty diabetic patients (30 who had retinopathy and 30 without retinopathy) and 30 healthy individuals. The information about patients in this study was retrieved from patient’s itself. The diabetic

patients (with and without) retinopathy were diagnosed by analysis RBS and HbA1c and fundoscopic examination by the ophthalmologist. All patients were aged between (51-82) years, with a negative history of antioxidant supplementation consumption, and their weight were (64–120)kg, with BMI range (19.56 - 49.94) . The criteria of exclusion include non-diabetic and malignant disease . The results of the patients groups were compared with healthy individuals nearly comparable age and BMI. About five milliliters of blood were collected from the antecubital vein of patients and controls in plain tubes without any anticoagulant at room temperature for 10-15 minutes and allowed to clot. The tube then were centrifuged (3000 rpm) for 15min. The clear serum was pipetted into clear dry Eppendorf’s and stored at (-20°C) until used for the various investigations. The levels of malondialdehyde, HbA1c were measured by using immunofluorescence technique.

**Results**

The study displayed that the highest mean of MDA was recorded in DR patients as compared with Diabetic without retinopathy patients (390.37±108.68 vs 336.97±94.95 ng/ml), although the result was non-significant (P: > 0.05). as shown in the Table 1.

**Table 1: Level of MDA in diabetic patients (with and without retinopathy).**

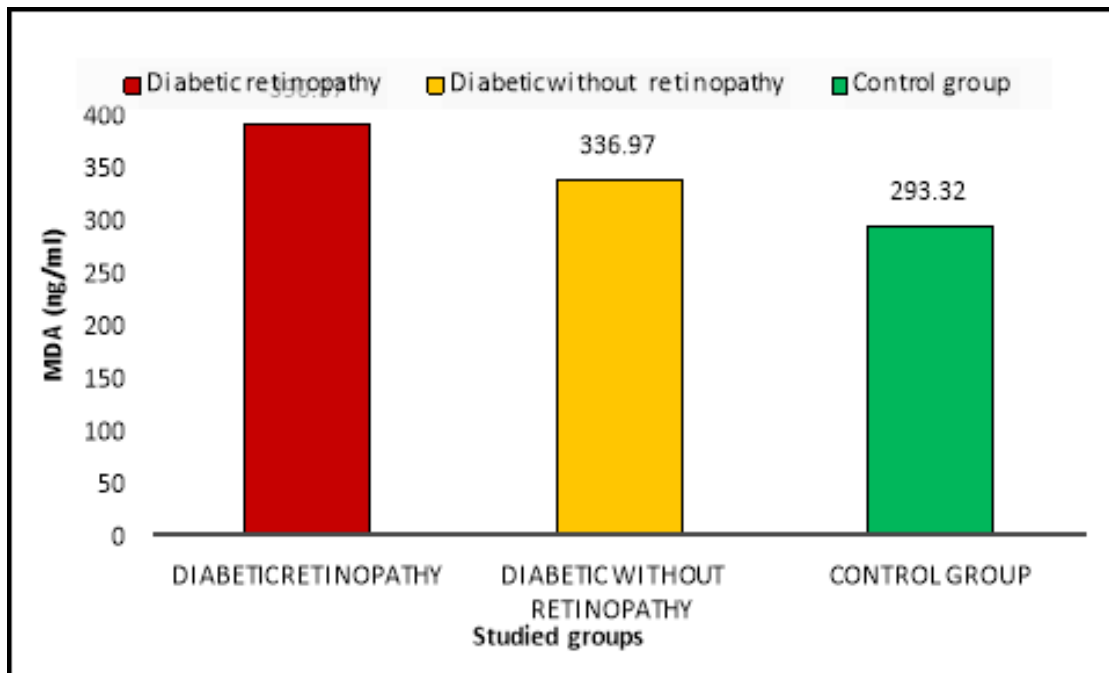
MDA(ng/ml)					
Group	Mean	SD	Max	Min	P value
Diabetic retinopathy	390.37	108.68	548.56	197.76	NS
Diabetic without retinopathy	336.97	94.95	113.36	94.95	

In the current study a significant difference between DR patients and healthy individuals regarding mean of MDA (390.37±108.68 vs 293.32±42.51 ng/ml), (P: < 0.05), as shown in the Table 2.

**Table 2: Level of MDA in DR patients and healthy individuals.**

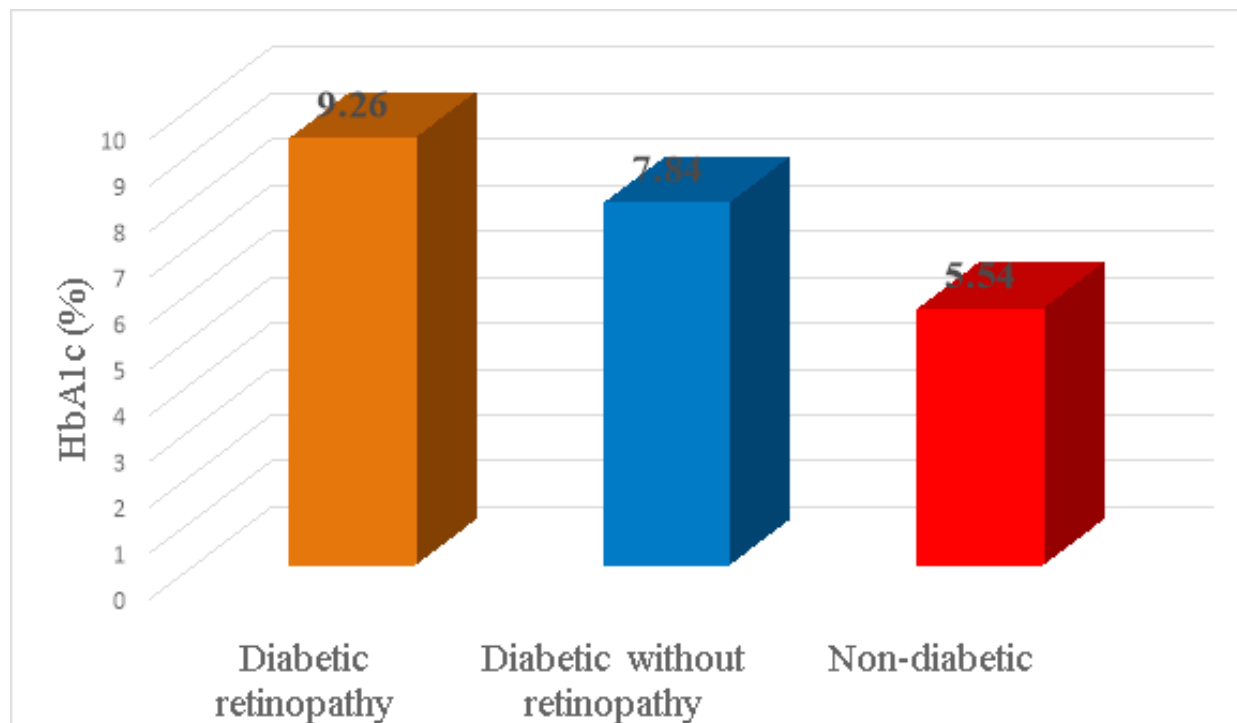
MDA(ng/ml)					
Group	Mean	SD	Max	Min	P value
Diabetic retinopathy	390.37	108.68	548.56	197.76	< 0.05
Healthy individuals	293.32	42.51	386.56	211.76	

The study showed that the highest mean of MDA was recorded in diabetic without retinopathy patients (336.97±94.95 ng/ml) as compared with healthy individuals (293.32±42.51 ng/ml), the result was significant (P: <0.05). Figure 1.



**Figure 1: Mean of malondialdehyde (MDA) in the studied groups**

The study showed that, HbA1c was elevated significantly ( $P<0.05$ ) in diabetic retinopathy patients ( $9.26\pm1.54$ ) compared with diabetic without retinopathy patients ( $7.84\pm1.02$ ), as shown in the Figure 2.



**Figure 2: Means of HbA1c levels in the studied groups**

The present study displayed that the highest mean of duration of DM was recorded in diabetic retinopathy patients ( $13.48\pm6.00$ ) compared with Diabetic without

retinopathy patients ( $6.34\pm2.78$ ), the result was significant ( $P:<0.05$ ). As shown in the Table 3.

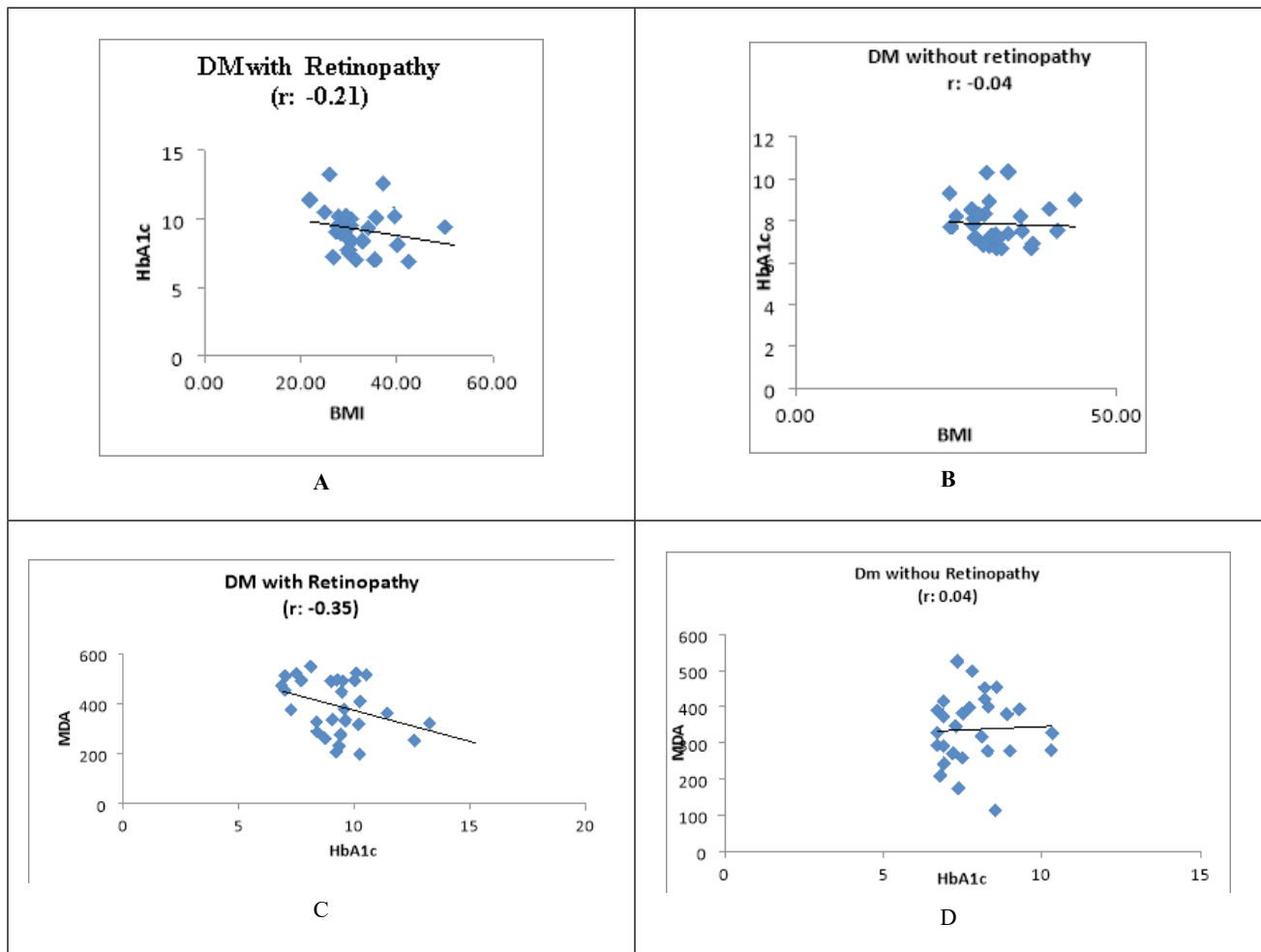


**Table 3: Mean of duration of DM in diabetic retinopathy patients and Diabetic without retinopathy patients.**

Duration of DM (year)					
Group	Mean	SD	Max	Min	P value
Diabetic retinopathy	13.48	6.00	30.00	5.00	< 0.05
Diabetic without retinopathy	6.34	2.78	10.00	0.80	

The study showed negative correlation between HbA1c and BMI in DR patients ( $r: -0.21$ ) and no correlation between HbA1c and BMI in DM patients without retinopathy ( $r: -0.04$ ), Figure 4 (A & B).

The study showed negative correlation between MDA and HbA1c in DR patients and no correlation in DM patients without retinopathy ( $r: -0.35$  and  $0.04$  respectively), Figure 4(B & C).



**Figure 4: Correlation between A- HbA1c and BMI in DR patients;B- HbA1c and BMI in DM patient without retinopathy;C- MDA and HbA1c in DR patients;D- MDA and HbA1c in DM patients without DR**

**Discussion**

The study showed that majority of diabetic retinopathy (DR) patients were females (23 of 29 (79.31%)) compared by 17 (58.62%) females of DM

group without retinopathy and 14(48.28%) of healthy individuals were females.

The study showed that the highest mean of age was recorded in diabetic retinopathy patients compared with

diabetic without retinopathy patients although the result was non-significant ( $P > 0.05$ ). The highest mean of age was recorded in diabetic retinopathy patients compared with healthy individuals, the result was significant ( $P < 0.05$ ). The study revealed that the highest mean of age was recorded in diabetic without retinopathy patients as compared with healthy individuals, although the result was non-significant ( $P > 0.05$ ).

This finding agrees with study done by Rajab<sup>(9)</sup>. The mean age was 50 years old ranging from 25-67 years, with 65% between the ages of 50-65 years old and the standard deviation was ( $\pm 10.95$ ) and the retinopathy rate was highest in the age group 50-59 years (37%). Also, Abebe *et al*<sup>(10)</sup> reported that Diabetic patients aged  $\geq 65$  years are less likely to have poor glycemic control compared to other age groups similar to another study done here in Gondar and in USA, which indicated that elderly people had better diabetes control. The retinopathies rate increased with age until the age of 70 years; however, the small number of people with diabetes in this age group limits our ability to interpret the finding. Some studies reported a significant association between DR and age. Aging, high blood glucose and high blood pressure cause microvascular destruction of blood vessels which increase with time of exposure so aging and duration of diabetes is main risk factors of diabetic retinopathy<sup>(11,12)</sup>.

On the other hand the current study disagrees with study done by Goyal *et al*<sup>(13)</sup> showed the mean age of patients with DR was significantly higher ( $P < 0.001$ ) in comparison to patients without DR.

Gender was not identified as a risk factor in our study, which agrees with a study conducted by Rajab<sup>(9)</sup> demonstrated that women had significantly higher rate of DR than men. Other studies have suggested insignificant differences in DR by sex, which disagrees with current study. Vinícius *et al*<sup>(14)</sup> reported that Mean age of group case was 59.5 years with a slight female predominance, however gender, age and were not associated with higher chances of DR. Also Tawfeeq indicated<sup>(8)</sup> that, there was no significant differences between the rate of males and females in this study ( $P > 0.5$ ) which was disagreed with our finding.

The study displayed that the highest mean of BMI was recorded in diabetic retinopathy patients compared with control group and diabetic without retinopathy patients, although the result was non-significant. In

agreement with current study's findings, Maghbooli *et al*<sup>(15)</sup> & Wang *et al*<sup>(16)</sup> demonstrated that insignificant association between BMI and DR. Also, Dipayan *et al*<sup>(17)</sup> reported that no significant relationship between DR and BMI.

Additionally, Zhou *et al*<sup>(18)</sup> demonstrated that elevated BMI did not increase the risk of DR. However, since being overweight and obesity are risk factors for multiple diseases, it is still imperative to maintain a healthy weight. Obesity has also been observed to have detrimental effects on multiple eye diseases such as glaucoma, late age-related maculopathy, and cataracts<sup>(19)</sup>.

BMI has been implicated both for positive and negative relation. Joel *et al*<sup>(20)</sup> & Rooney *et al*<sup>(21)</sup> showed that an inverse association between obesity and incident DR and also between BMI and DR. As well as, Zahra *et al*<sup>(22)</sup> & Jun *et al*<sup>(23)</sup> demonstrated that BMI had inverse relationship with DR, so Elevated BMI may confer a protective effect on DR through many ways. First, increased C-peptide levels were found in higher BMI individuals,<sup>[58]</sup> which could reduce the risk of DR. Moreover, a higher BMI may be a reflection of better glycemic control or shorter diabetes duration. Obese individuals were also more vulnerable to suffer from comorbid conditions; consequently, aggressive treatments have been taken, and reduced the development of DR<sup>(24)</sup>.

Meta-analysis of prospective cohort studies done Wei Zhuby *et al*<sup>(25)</sup> suggest that obesity was a risk factor for DR. A higher BMI may have adverse effects on DR. First, an elevated BMI is often correlated with hypertension and dyslipidemia, both of which are risk factors for DR. Additionally, hyperleptinemia in obese individuals may increase blood pressure and oxidative stress levels, which may partly be responsible for the development of DR. Moreover, higher vascular endothelial growth factor levels were observed in obese individuals, which has been shown to be involved in the pathogenesis of proliferative DR<sup>(26)</sup>.

In the current study, the highest mean of MDA were recorded among diabetic retinopathy patients compared with diabetic without retinopathy patients and control group. These findings were close to that reported Dharmveer *et al*<sup>(27)</sup> indicated a highly significantly increased MDA levels, in diabetic retinopathy patients with respect to controls. Also agreed with study done by

. Shaikh *et al*<sup>(28)</sup> indicated Serum MDA was significantly elevated in diabetic retinopathy patients compared with control group.

Additionally, Chatterjee *et al*<sup>(29)</sup>, Vlatka *et al*<sup>(30)</sup> and Manish *et al*<sup>(31)</sup> indicated a highly significantly increased MDA levels, in diabetic retinopathy patients with respect to diabetic without retinopathy patients, point towards a role of free radicals in causation of diabetic complications like retinopathy. Nair *et al*<sup>(32)</sup> & Al-Duais *et al*<sup>(33)</sup> revealed significantly higher MDA in diabetics compared to control and similarly in diabetic retinopathy compared to those without DR. Also, Asmat *et al*<sup>(34)</sup> & Dos Santos *et al*<sup>(35)</sup> reported that Oxidative stress play a vital role in the pathogenesis of diabetes, oxidative stress harmfully affects the insulin activity through several interacting pathways and generating ROS. These could deteriorate the islets  $\beta$ -cells of the pancreas resulting in the reduced release of insulin. In addition, Free radical formation by non-enzymatic glycation of proteins, glucose oxidation and increased lipid peroxidation leads to damage of enzymes, cellular injury machinery, changes in the cell membrane and increased insulin resistance which are risk for diabetes. Fonseca *et al*<sup>(36)</sup> MDA is a marker of lipid peroxidation which reacts with cell membrane phospholipids. The elevated level of MDA is found in different pathological diseases such as diabetes, cardiovascular diseases, renal disease, neurodegenerative disorders and cancer so that it is a good biomarker of oxidative stress and tissue damage. Hadeel *et al*<sup>(37)</sup> revealed significantly higher MDA in diabetics compared to control and similarly in diabetic retinopathy compared to those without DR, and MDA can use for the prognosis of DR, in addition, malondialdehyde may be independent predictor of diabetes and DR.

Chatziralli *et al*<sup>(38)</sup> and Manish *et al*<sup>(39)</sup> showed that, serum MDA has been found to be significantly associated with the severity of DR in patients with *type 2* insulin-dependent DM. Marcino *et al*<sup>(40)</sup> reported that increased MDA is associated with oxidative stress and poor antioxidant defense, which promotes the progression of DR to its proliferative form. María *et al*<sup>(41)</sup> reported that retinal microvascular complications are closely related to the severity of oxidative stress, as expressed as increased level of MDA among DR patients. Olvera *et al*<sup>(42)</sup> reported that the exact mechanism by which the oxidative stress contributes to diabetic complications remains unclear, but all biochemical alterations due to DM lead to anatomical and functional impairment in the

retinal microvascular network, such as changes in blood flow in the retina, disruption of the blood-retina-barrier and consequently capillary occlusion and ischemia.

The current study showed that, HbA1c was elevated significantly ( $P < 0.05$ ) in diabetic retinopathy patients compared with control group and diabetic without retinopathy patients. In agreement with the current results, study done by Dharmveer *et al*<sup>(27)</sup> showed that increased HbA1c levels in diabetic retinopathy patients as compared to control healthy group and the results were statistically significant. As well as, Namir *et al*<sup>(43)</sup> showed that significant increase of HbA1c in diabetic retinopathy patients as compared to control group.

Manish *et al*<sup>(39)</sup> showed that HbA1c significantly increase in diabetic retinopathy patients compared to diabetic without retinopathy patients. Also agree with study done by Ojoye *et al*<sup>(44)</sup> showed the mean value of HbA1c for Type 2 diabetics were significantly higher ( $p < 0.05$ ) when compared with that of the control group. Goyal *et al*<sup>(13)</sup> showed that the % of HbA1C measured in DR patients was significantly higher than non-DR patients evidencing the fact that long term poor control of blood sugar levels had adverse effect on retina ( $8.16 \pm 0.52$  vs.  $7.04 \pm 0.32$ ).

Additionally, Xing *et al*<sup>(45)</sup> revealed that HbA1c were higher in diabetic retinopathy than in diabetic non retinopathy patients and HbA1c were associated with increased risk of diabetic retinopathy. A longitudinal observation study in Southeast Sweden done by Maria *et al*<sup>(46)</sup> reported that Long-term weighted mean HbA1c, measured from diagnosis, is closely associated with the development of severe complications in type 1 diabetes. Keeping HbA1c below 7.6% (60 mmol/mol) as a treatment target seems to prevent proliferative retinopathy for up to 20 years. As well as, retrospective cohort study done by Ki-Ho *et al*<sup>(47)</sup> showed that the mean HbA1c levels was higher in the diabetic retinopathy progressors than in the diabetic retinopathy non-progressors. The mean HbA1c was a significant predictor for DR progression independent of the duration of diabetes. In agreement with the current study Bhasker *et al*<sup>(48)</sup> reported that the HbA1c was found to be higher in diabetics without retinopathy as compared to controls ( $p < 0.05$ ) and the highest value was seen in the mild NPDR group. Study done by Nam H *et al*<sup>(49)</sup> showed that HbA1c cutoff of (6.6 %) and (6.9 %) best detected the presence of any diabetic retinopathy and moderate/severer retinopathy, respectively. Also study

done by Khalid *et al* <sup>(50)</sup> showing that HbA1c was raised in patients having diabetic retinopathy ( $p < 0.001$ ) and patients who have uncontrolled diabetes (high HbA1c levels) have 66.61% chance of developing the diabetic retinopathy, so HbA1c is a good indicator of glycemic control as it can help diabetic individuals in deterrence of microvascular complications especially DR.

A study done by Lokesh *et al* <sup>(12)</sup> reported that lower frequency of DR in patients with lower HbA1c group and increase in frequency of DR as the HbA1c increases. As well as, A study done by Leske *et al* <sup>(51)</sup>, in Barbodose eye study, they found that every 1% increase in HbA1C from baseline was associated with a >2-fold risk of DR, up to 4 years of follow up which was correlating with the present study in telling the linear relationship of HbA1c levels with the development of DR.

The present study displayed that the highest mean of duration of DM was recorded in diabetic retinopathy patients (mean±SD) (13.48±6.00) compared with Diabetic without retinopathy patients (mean±SD) (6.34±2.78), the result was significant ( $P < 0.05$ ). These findings were close to that reported Goyal *et al* <sup>(13)</sup> showed that a significant difference was observed in the mean duration of diabetes ( $12 \pm 5$  vs.  $8 \pm 5$  years, ( $P < 0.05$ ). Additionally, study done by Yan Liu *et al* <sup>(11)</sup> showed that patients were getting less likely to suffer from DR every 10 years after 60 years of age, while no difference was found before age 60. Ojoye *et al* <sup>(44)</sup> reported that the increasing duration of the diabetes mellitus further depresses the antioxidative system. As the disease condition progresses, antioxidative parameters SOD and GPx shows significantly decreasing with increasing years of illness, with the decrease most evident in those affected for the period of 16-20 years. This could be the result of increased production of ROS and also increased glycation of the enzymes.

**Conflict of Interest:** None

**Source of Findings:** None

**Ethical Clearance:** None

### Reference

1. Ferreira JT, Alves M, Dias-Santos A, Costa L, Santos BO, Cunha JP, Papoila AL, Pinto LA. Retinal neurodegeneration in diabetic patients without diabetic retinopathy. *Investigative ophthalmology & visual science*. 2016 Nov 1;57(14):6455-60.
2. Lee CS, Lee AY, Baughman D, Sim D, Akelere T, Brand C, Crabb DP, Denniston AK, Downey L, Fitt A, Khan R. The United Kingdom diabetic retinopathy electronic medical record users group: report 3: baseline retinopathy and clinical features predict progression of diabetic retinopathy. *American journal of ophthalmology*. 2017 Aug 1;180:64-71.
3. Alabdulwahhab KM. Prevalence and risk factors of diabetic retinopathy in Saudi Diabetics in Majmaah City. *Australasian Medical Journal (Online)*. 2016 Dec 1;9(12):531.
4. Wright AD, Dodson PM. Medical management of diabetic retinopathy: fenofibrate and ACCORD Eye studies. *Eye*. 2011 Jul;25(7):843-9.
5. Park S, Kang HJ, Jeon JH, Kim MJ, Lee IK. Recent advances in the pathogenesis of microvascular complications in diabetes. *Archives of Pharmacal Research*. 2019 Mar;42(3):252-62.
6. Barrett EJ, Liu Z, Khamaisi M, King GL, Klein R, Klein BE, Hughes TM, Craft S, Freedman BI, Bowden DW, Vinik AI. Diabetic microvascular disease: an endocrine society scientific statement. *The Journal of Clinical Endocrinology & Metabolism*. 2017 Dec 1;102(12):4343-410.
7. Cecilia OM, José Alberto CG, José NP, Ernesto Germán CM, Ana Karen LC, Luis Miguel RP, Ricardo Raúl RR, Adolfo Daniel RC. Oxidative stress as the main target in diabetic retinopathy pathophysiology. *Journal of diabetes research*. 2019 Aug 14;2019.
8. Tawfeeq AS. Prevalence and risk factors of diabetic retinopathy among Iraqi patients with type 2 diabetes mellitus. *IRAQI JOURNAL OF COMMUNITY MEDICINE*. 2015;28(1):17-21.
9. Rajab AY. Frequency of diabetic retinopathy in Mosul. *Annals of the College of Medicine Mosul*. 2008;34(2):129-34.
10. Abebe SM, Berhane Y, Worku A, Alemu S, Mesfin N. Level of sustained glycemic control and associated factors among patients with diabetes mellitus in Ethiopia: a hospital-based cross-sectional study. *Diabetes Metab Syndr Obes*. 2015;8:65.
11. Liu Y, Yang J, Tao L, Lv H, Jiang X, Zhang M, Li X. Risk factors of diabetic retinopathy and sight-threatening diabetic retinopathy: a cross-sectional study of 13 473 patients with type 2 diabetes

- mellitus in mainland China. *BMJ open*. 2017 Sep 1;7(9).
12. Lokesh S, Shivaswamy S. Study of HbA1C levels in patients with type 2 diabetes mellitus in relation to diabetic retinopathy in Indian population. *International Journal of Advances in Medicine*. 2018 Nov;5(6):1397.
  13. Goyal M, Kamboj P, Behgal J, Rathee S and Lather T. Risk factors of diabetic retinopathy in patients with type 2 diabetes mellitus. *Diabetes Manag* (2017) 7(6), 408–411.
  14. Lima VC, Cavalieri GC, Lima MC, Nazario NO, Lima GC. Risk factors for diabetic retinopathy: a case–control study. *International journal of retina and vitreous*. 2016 Dec 1;2(1):21.
  15. Maghbooli Z, Pasalar P, Keshtkar A. Predictive factors of diabetic complications: a possible link between family history of diabetes and diabetic retinopathy. *J Diabetes Metab Disord* 2014;13:55.
  16. Wang J, Chen H, Zhang H, et al. The performance of a diabetic retinopathy risk score for screening for diabetic retinopathy in Chinese overweight/obese patients with type 2 diabetes mellitus. *Ann Med* 2014;46:417–23
  17. Sen D, Ghosh S, Roy D. Correlation of C-reactive protein and body mass index with diabetic retinopathy in Indian population. *Diabetes & Metabolic Syndrome: Clinical Research & Reviews*. 2014 Jan 1;9(1):28-9.
  18. Zhou Y, Zhang Y, Shi K, Wang C. Body mass index and risk of diabetic retinopathy: A meta-analysis and systematic review. *Medicine*. 2017 Jun;96(22).
  19. Ye J, Lou LX, He JJ, et al. Body mass index and risk of age-related cataract: a meta-analysis of prospective cohort studies. *PLoS One* 2014;9:e89923.
  20. Chan JC, Chee ML, Tan NY, Cheng CY, Wong TY, Sabanayagam C. Differential effect of body mass index on the incidence of diabetes and diabetic retinopathy in two Asian populations. *Nutrition & diabetes*. 2018 Mar 7;8(1):1-1.
  21. Rooney D, Lye WK, Tan G, et al. Body mass index and retinopathy in Asian populations with diabetes mellitus. *Acta Diabetol* 2015;52:73–80.
  22. Sarrafan-Chaharsoughi Z, Manaviat MR, Namiranian N, Yazdian-Anari P, Rahmanian M. Is there a relationship between body mass index and diabetic retinopathy in type II diabetic patients? A cross sectional study. *Journal of Diabetes & Metabolic Disorders*. 2018 Jun 1;17(1):63-9.
  23. Lu J, Hou X, Zhang L, Jiang F, Hu C, Bao Y, Jia W. Association between body mass index and diabetic retinopathy in Chinese patients with type 2 diabetes. *Acta diabetologica*. 2015 Aug 1;52(4):701-8
  24. Cai X, Han X, Zhang S, et al. Age at diagnosis and C-peptide level are associated with diabetic retinopathy in Chinese. *PLoS One* 2014;9: e91174.
  25. Zhu W, Wu Y, Meng YF, Xing Q, Tao JJ, Lu J. Association of obesity and risk of diabetic retinopathy in diabetes patients: A meta-analysis of prospective cohort studies. *Medicine*. 2018 Aug;97(32).
  26. Yau JW, Rogers SL, Kawasaki R, et al. Global prevalence and major risk factors of diabetic retinopathy. *Diabetes Care* 2012;35:556–64.
  27. Sharma D, Singh SP, Dwivedi S. Status of Oxidative Stress and Antioxidant in Diabetic Retinopathy of Type-2 Diabetic Subjects.
  28. Shaikh S, Memon A, Ata MA, Khoharo HK. Association of Serum Bilirubin, Serum Malondialdehyde and Glycemic Control with Retinopathy in Type 2 Diabetic Subjects. *International Journal of Diabetes and Endocrinology*. 2017 Mar 22;2(1):10.
  29. Chatterjee S, Chakraborti S. Can Serum MDA: SOD Ratio Predict Risk of Retinopathy in Type 2 Diabetes Mellitus?. *International Journal of Research and Review*. 2020;7(1):397-400.
  30. Brzović-Šarić V, Landeka I, Šarić B, Barberić M, Andrijašević L, Cerovski B, Oršolić N, Đikić D. Levels of selected oxidative stress markers in the vitreous and serum of diabetic retinopathy patients. *Molecular vision*. 2015;21:649.
  31. Verma MK, Singh SP, Alam R, Verma P. Comparative Study on MDA, SOD and HbA1c Levels in Patients of Type 2 Diabetes Mellitus with Retinopathy and Without Retinopathy. *International Journal of Pharmaceutical Sciences and Research*. 2016 Oct 1;7(10):4184.
  32. Nair A, Nair BJ. Comparative analysis of the oxidative stress and antioxidant status in type II diabetics and nondiabetics: a biochemical study. *J Oral Maxillofac Pathol*. 2017;21(3):394– 401.
  33. Al-Duais MA, Sakran MI, Shalaby KA, et al. Diagnostic value of serum adenosine deaminase in type II Saudi diabetic patients. *Adv Diabetes Endocrinol*. 2015;1(1):5.

34. Asmat U, Abad K, Ismail K. Diabetes mellitus and oxidative stress—a concise review. *Saudi Pharm J*. 2016;24(5):547–53.
35. Dos Santos JM, Tewari S, Mendes RH. The role of oxidative stress in the development of diabetes mellitus and its complications. *J Diabetes Res*. 2019;2019:4189813
36. Fonseca I. Malondialdehyde as a biomarker in kidney transplantation. *Biomarkers in disease: method, discoveries and applications*. *Biomark Kidney Dis*. 2015;1:1–25.
37. Shawki HA, Elzehery R, Shahin M, Abo-hashem EM, Youssef MM. Evaluation of some oxidative markers in diabetes and diabetic retinopathy. *Diabetology International*. 2020 Jun 27:1-0.
38. Chatziralli IP, Theodossiadis G, Dimitriadis P, Charalambidis M, Agorastos A, Migkos Z, Platogiannis N, Moschos MM, Theodossiadis P, Keryttopoulos P. The effect of vitamin E on oxidative stress indicated by serum malondialdehyde in insulin-dependent type 2 diabetes mellitus patients with retinopathy. *The open ophthalmology journal*. 2017;11:51.
39. Verma M, Alam R, Mobin M. Review on Malondialdehyde and Superoxide dismutase levels in patients of Type 2 Diabetes Mellitus with Retinopathy and without Retinopathy. *Int. J. Life Sci. Scienti. Res*. 2015 Nov;1(2):52-7.
40. Mancino R, Di Pierro D, Varesi C, Cerulli A, Feraco A, Cedrone C, PinazoDuran MD, Coletta M, Nucci C. Lipid peroxidation and total antioxidant capacity in vitreous, aqueous humor, and blood samples from patients with diabetic retinopathy. *Molecular vision*. 2011;17:1298.
41. Rodríguez ML, Pérez S, Mena-Mollá S, Desco MC, Ortega ÁL. Oxidative stress and microvascular alterations in diabetic retinopathy: future therapies. *Oxidative Medicine and Cellular Longevity*. 2019 Nov 11;2019.
42. Cecilia OM, José Alberto CG, José NP, Ernesto Germán CM, Ana Karen LC, Luis Miguel RP, Ricardo Raúl RR, Adolfo Daniel RC. Oxidative stress as the main target in diabetic retinopathy pathophysiology. *Journal of diabetes research*. 2019 Aug 14;2019.
43. Haddad NI, Nori E, Sana'a HA. The Effect of Type Two Diabetes Mellitus on Superoxide Dismutase (SOD) Activity and its Correlation with HbA1c in Iraqi Patients. no. 2016;4:7-15.
44. Briggs ON, Brown H, Elechi-amadi K, Ezeiruaku F, Nduka N. Superoxide dismutase and glutathione peroxidase levels in patients with long standing March 2016;5;(3):139-145.
45. Zhong X, Du Y, Lei Y, Liu N, Guo Y, Pan T. Effects of vitamin D receptor gene polymorphism and clinical characteristics on risk of diabetic retinopathy in Han Chinese type 2 diabetes patients. *Gene*. 2015 Jul 25;566(2):212-6.
46. Nordwall M, Abrahamsson M, Dhir M, Fredrikson M, Ludvigsson J, Arnqvist HJ. Impact of HbA1c, followed from onset of type 1 diabetes, on the development of severe retinopathy and nephropathy: the VISS Study (Vascular Diabetic Complications in Southeast Sweden). *Diabetes care*. 2015 Feb 1;38(2):308-15.
47. Song KH, Jeong JS, Kim MK, Kwon HS, Baek KH, Ko SH, Ahn YB. Discordance in risk factors for the progression of diabetic retinopathy and diabetic nephropathy in patients with type 2 diabetes mellitus. *Journal of diabetes investigation*. 2019 May;10(3):745-52.
48. Mukherjee B, Shankar S, Ahmed R, Singh K, Bhatia K. Association of glycosylated haemoglobin and serum apolipoproteins with diabetic retinopathy: An Indian overview. *Journal of clinical and diagnostic research: JCDR*. 2017 Sep;11(9):BC19.
49. Cho NH, Kim TH, Woo SJ, Park KH, Lim S, Cho YM, Park KS, Jang HC, Choi SH. Optimal HbA1c cutoff for detecting diabetic retinopathy. *Acta diabetologica*. 2013 Dec 1;50(6):837-42.
50. Alabdulwahhab KM. Relationship between Diabetic Retinopathy and HbA1c in Type 2 Diabetics, Kingdom of Saudi Arabia. *Journal of Research in Medical and Dental Science*. 2019 Sep;7(5):1-4.
51. Leske MC, Wu SY, Hennis A, Hyman L, Nemesure B, Yang L, et al, Barbados Eye Study Group. Hyperglycemia, blood pressure, and the 9-year incidence of diabetic retinopathy: the Barbados Eye Studies. *Ophthalmol*. 2005 May 1;112(5):799-805.

# Psoriasis Beyond Local Skin Disease

Amina Hamed Ahmed Alobaidi<sup>1</sup>, Abdulghani Mohamed Alsamarai<sup>2</sup>, Muhib Ahmed Salih<sup>3</sup>

<sup>1</sup>Assistant Professor, Department of Biochemistry, College of Veterinary Medicine, Kirkuk University Kirkuk,

<sup>2</sup>Professor, Department of Medicine, College of Medicine, Tikrit University, Tikrit., Iraq

## Abstract

**Background:** Psoriasis is a skin disease that was associated with metabolic and clinical changes which suggest that psoriasis is a systemic rather than local disease.

**Aim:** To illustrate whether psoriasis is local or systemic disease through analysis of some biomarkers.

**Materials and Method:** A 256 subjects with psoriasis and 221 sex and age matched controls were included in the study. Serum total cholesterol [TC], high density lipoprotein [HDL], Malondialdehyde [MDA], triglycerides [TG], and total antioxidant capacity [TCA] were determined using commercial kits.

**Results:** There were no significant differences between psoriasis and control groups in regards to mean age and gender distribution, however, there was a significant difference [ $p < 0.01$ ] in BMI. Additionally, TC, TG, LDL and HDL were significantly higher [ $P < 0.001$ ] in patients with psoriasis than in controls, while HDL was significantly lower in psoriasis than in controls. MDA mean serum level was significantly higher [ $P < 0.001$ ] lower while TCA value was significantly [ $P < 0.001$ ] lower in subjects with psoriasis as compared controls. Lipid profile rates and oxidation index were significantly higher in psoriasis than in controls, while the anti-oxidation index was significantly lower in psoriasis.

**Conclusion:** These study findings suggest that psoriasis may be a systemic disease rather than local skin disease.

**Keywords:** Psoriasis, Cholesterol, LDL, HDL, HDL, MDA, Total antioxidant capacity.

## Introduction

Psoriasis is a chronic inflammatory- immunologic disease with a prevalence of 2.3% in Iraqi population<sup>[1]</sup>, and variable global prevalence<sup>[2]</sup>. Although the disease is recognized as local skin disease in approximately 80% of cases, however, 20% of the affected individuals are with >10% body surface area is involved<sup>[3]</sup>. The disease is with obscure aetiology, however, immunological, genetic, infectious and environmental factors may play a

role in the development of psoriasis<sup>[4-6]</sup>. Previous studies indicated that psoriasis started as local skin disease and subsequently associated with systemic inflammatory-immunologic and metabolic changes<sup>[7, 8]</sup>. The systemic changes in patients with psoriasis were reported in studies conducted in Iraqi population<sup>[5,6,9,10]</sup> and worldwide<sup>[11-25]</sup>. The data presented in the above studies that are from different global communities indicated that psoriasis co-morbidities development are not confined to specific race, developing or developed communities. Previous studies conducted in Iraqi community included small study population, thus this study was conducted in a large-scale study population in comparison with controls.

---

### Correspondence Author:

**Amina Hamed Ahmed Alobaidi**

Assistant Professor, Department of Biochemistry,  
College of Veterinary Medicine, Kirkuk University  
Kirkuk

e-mail: aminahamed2006@gmail.com

## Materials and Method

**Study Population:** The present study included 256 subject with psoriasis attending Dermatology clinic

during the period from January 2012 to end of May 2014. A 221 subject, gender and age matched control were included in the study. The mean age of patients group was 34.8 ( $\pm 15.6$ ) years and that of control group was 34.5 ( $\pm 14.9$ ) year with none significant difference between the two groups. Additionally, the gender frequency rate was not with significant difference, Table 1. The study was approved by the ethical committee of Tikrit University College of Medicine and informed consent was taken from each subject included in the study. Subjects with diabetes, hypertension, cardiovascular disease, smoking, renal disease, liver disease, family history of hyperlipidaemia, hypothyroidism, connective tissue disease, and using lipid lowering drugs were excluded from enrolment in the study.

**Determination of total cholesterol:** Total cholesterol serum level was determined by an enzymatic colorimetric test kit [BioMaghreb, France] and the test was performed according to manufacturer instructions.

**Determination of high density lipoprotein:** High density lipoprotein serum level was determined by colorimetric test kit [LINEAR CHEMICALS S.L. Joaquim Costa 18 2<sup>a</sup> planta. 08390 Montgat, Barcelona, SPAIN] and the test was performed according to manufacturer instructions.

**Determination of triglycerides:** Triglycerides serum concentration was determined by enzymatic colorimetric test kit [Linear Chemicals, Spain].

**Determination of Malondialdehyde:** Malondialdehyde serum concentration was determined by measuring the thiobarbituric acid reactive substances as described by Janero [26].

**Determination of total antioxidant capacity:** The serum concentration of Total Antioxidant Capacity was determined according to method described previously by Kampa et al [27].

**Determination of very low density lipoprotein:** Very low density was calculated by division of triglycerides by 5.

**Determination of low density lipoprotein:** Serum LDL concentration was calculated by subtraction of HDL and VLDL from total cholesterol serum level.

**Statistical Analysis:** Variables values were presented as mean  $\pm$  standard deviation [SD]. Student t test was used to determine the significant differences

between the groups. P value of  $<0.05$  regarded as significant.

## Results

There was a significant higher difference [ $P<0.001$ ] in mean serum values of total cholesterol (TC), triglyceride (TG), low density lipoprotein (LDL) and non-high density lipoprotein (NHDL) in psoriatic subjects as compared to controls, Table 2. In contrast, high density lipoprotein (HDL) was significantly lower in psoriatic individuals than in controls, Table 2. Additionally, the lipid profile rates were significantly higher [ $P<0.001$ ] in psoriasis as compared to control group, Table 2. All rates mean values about 2 times higher in psoriasis than in controls.

Malondialdehyde as a marker of oxidative stress was significantly higher [ $P<0.001$ ] in psoriasis than in controls and thus the oxidation index was 3 times higher in psoriasis with a highly significant difference, Table 3. In contrast, total antioxidant capacity was significantly lower in psoriasis than in controls, with a much lower anti-oxidation index [ $P<0.001$ ] in psoriasis in comparison to controls, Table 4.

As shown in Table 5, there was a significant [ $P=0.041$  to  $<0.001$ ] differences in mean serum triglyceride, TAC, BMI, Age, and HDL between male and female psoriatic individuals.

Comparison of male psoriatic with male controls indicated a significant differences [ $P<0.001$ ] in all tested variables, Table 5. The same pattern was demonstrated when female psoriatic compared to female controls, with the exception of BMI, Table 6. Lipid profile, oxidation, and anti-oxidation rates were significantly different between psoriasis and controls.

## Discussion

The peroxidation biomarkers as this study indicated were significantly higher in psoriatic patients as compared to controls. Additionally, gender not significantly influenced the differences in peroxidation biomarkers as demonstrated by comparative analysis on different strata. There was a significant difference when male patients compared to male control; female patients compared to female control, however, there was no significant differences in comparison between the male psoriatic and female psoriatic. These findings were in consistent with that reported previously for different



geographical areas [5-25, 8], irrespective of race, gender, and age.

The antioxidant activity as measured by TAC, HDL, and antioxidant index calculation show a significantly low capacity in psoriatic patients than in control. This finding was agreed to that reported for Iraq and other geographical areas [5-25; 28,29,30], however, some studies not confirmed such changes [15,31-33]. The genetic predisposition may form the first step in the development of psoriasis, and environmental factors interference possibility may initiate disease specific pathogenicity and disease natural history [7].

In literature, the previous studies findings suggest that psoriasis is a multisystem chronic disease with multifactorial aetiology and associated with different comorbidities that were a result of inflammatory, immunologic and infectious sequences [8,32-34]. Although psoriasis was characterised by local skin lesions due to inflammatory and immunological responses, however, this study and the previously reported studies indicated that systemic changes were more than dermatologic one [34]. Sing et al [16], in a meta-analysis review reported that from 36 studies, only 1 show odd ratio of <1, and 35 studies with OR range from 1.09 to 6.09 and 21 studies with OR of >2 were demonstrated as association with metabolic syndrome.

Reich [7] 2011, in a review concluded the presence of similarities in pathogenesis of psoriasis and atherosclerosis and suggests that psoriasis is a systemic inflammatory disease. Psoriasis patients are with high prevalence of hypertension, diabetes, hyperlipidaemia, obesity, ischemic heart disease, rheumatoid arthritis and Crohn's disease [35, 36]. Davidovici et al [37] proposed a model that suggest a presence of shared genetic risk

factors between psoriasis and obesity and enhance comorbidities development.

Tampa et al [32] in a review concluded that stress was an important trigger for psoriasis, and many studies suggested the association between psoriasis and psychological stress [16,38-45]. However, the psychological stress mechanisms by which psoriasis induced or exacerbated was not completely understood [32]. Immunopsychological studies show that stress affects immune functions and hormones with subsequent events of in B lymphocytes, T lymphocytes, monocyte, cytokines and oxidative stress biomarkers [46-59]. In Iraqi population, 67% of psoriatic patients demonstrated high perceived stress scale as compared to non-psoriatic patients [60]

Cantrell et al [61] suggested that psoriasis was a systemic inflammatory disease depending on the recent studies that reported an association with cardiovascular diseases, metabolic syndrome, hypertension, psoriatic arthritis, dyslipidemia, and renal diseases [24,62-69]. Additionally, Sanz [70], concluded that psoriasis is a systemic diseases and this conclusion was attributed to the significant association between systemic disease and psoriasis as recent studies indicated. The comorbidities associated with psoriasis include psoriatic arthritis [71-74], crohn disease [75,76], and lymphoma [77-80]. Psoriasis treatment with systemic drugs modified the risk factors such as cardiovascular disease and arthritis risk reduction [62-86].

In conclusion, the present study findings indicated systemic oxidative stress in patients with psoriasis with reduction in antioxidant capacity. Collectively these findings and that of previous studies and ameliorations of biomarkers by systemic treatment suggest that psoriasis is a systemic disease.

**Table 1. Study population characteristics**

Variable	Psoriasis	Control	P value
Number	256	221	---
Male/female	137/119	113/108	>0.05
Mean age in year (SD)	34.8 (15.6)	34.5 (14.9)	>0.05
Mean BMI (SD)	26.7 (1.3)	25.4 (1.5)	<0.01

**Table 2. Mean of Lipid profile with rates in psoriatic patients compared to control**

Variable	Mean (SD)		t value	P value
	Psoriasis	Control		
Total cholesterol mg/dl	218.6 (15.6)	184.3 (27.6)	17.13	<0.001
Triglyceride mg/dl	174.2 (15.7)	123.7 (24.8)	26.51	<0.001
HDL mg/dl	40.6 (4.3)	55.2 (9.7)	20.84	<0.001
LDL mg/dl	143.5 (35.6)	104.2 (17.1)	15.12	<0.001
NHDL mg/dl	178 (37.9)	129.1 (18.5)	17.38	<0.001
Cholesterol/HDL	5.5 (1.4)	3.3 (0.2)	23.15	<0.001
LDL/HDL	3.6 (1.3)	1.9 (0.1)	19.38	<0.001
Triglyceride/HDL	4.4 (0.9)	2.2 (0.5)	32.28	<0.001
NHDL/HDL	4.5 (1.4)	2.4 (0.2)	22.10	<0.001

**Table 3. Malondialdehyde and total antioxidant capacity in psoriatic patients compared to control**

Variable	Mean (SD)		t value	P value
	Patients	Control		
Malondialdehyde $\mu\text{mol/l}$	4.6 (0.7)	2.3 (0.3)	45.3	<0.001
Total Antioxidant Capacity $\mu\text{mol/l}$	755 (121)	1045 (194)	19.8	<0.001
Oxidation Index	6.09 (1.2)	2.2 (0.8)	40.1	<0.001
Anti-oxidation Index	164.1 (17.3)	454.3 (59.7)	74.5	<0.001

**Table 4. Lipid profile, age, Malondialdehyde, Body Mass Index and Total Antioxidant Capacity in psoriasis according to gender**

Variable	Mean (SD)		t value	P value
	Male	Female		
Cholesterol	217.1 (35.7)	221 (32.8)	0.9	>0.05
Triglyceride	179 (15.4)	158 (7.2)	13.6	<0.001
HDL	40.3 (4.9)	41.6 (4.7)	2.1	0.031
LDL	142 (37.1)	145 (34.8)	0.7	>0.05
NHDL	177 (38.9)	179 (37.5)	0.4	>0.05
Age	34.1 (4.7)	35.7 (7.6)	2.1	0.041
BMI	27 (1.58)	26.4 (2.6)	2.3	0.024
Malondialdehyde	4.6 (1.1)	4.5 (0.51)	0.9	>0.05
Total Antioxidant Capacity	702 (83.6)	737 (132.8)	2.5	0.011

**Table 5. Lipid profile, age, Malondialdehyde, Body Mass Index and Total Antioxidant Capacity in psoriatic male compared with control male**

Variable	Mean (SD)		t value	P value
	Male psoriasis	Male control		
Cholesterol	217.1 (35.7)	185 (16.1)	8.7	<0.001
Triglyceride	179 (15.4)	128 (22.1)	21.2	<0.001
HDL	40.3 (4.9)	57 (2.1)	31.1	<0.001

Variable	Mean (SD)		t value	P value
	Male psoriasis	Male control		
LDL	142 (37.1)	104.7 (9.6)	10.0	<0.001
NHDL	177 (38.9)	129 (17.5)	12.0	<0.001
Age	34.1 (4.7)	31 (3.7)	5.5	<0.001
BMI	27 (1.58)	24.3 (1.5)	10.6	<0.001
Malondialdehyde	4.6 (1.1)	2.1 (0.37)	22.9	<0.001
Total Antioxidant Capacity	702 (83.6)	1046 (127.4)	25.2	<0.001

**Table 6. Lipid profile, age, Malondialdehyde, Body Mass Index and Total Antioxidant Capacity in psoriatic female compared with control female**

Variable	Mean (SD)		t value	P value
	Female psoriasis	Female control		
Cholesterol	221 (32.8)	182 (19.9)	10.3	<0.001
Triglyceride	158 (7.2)	120 (28.2)	13.4	<0.001
HDL	41.6 (4.7)	54 (3.7)	17.7	<0.001
LDL	145 (34.8)	104.6 (16.7)	11.0	<0.001
NHDL	179 (37.5)	128 (18.9)	12.6	<0.001
Age	35.7 (7.6)	32 (3.5)	4.5	<0.001
BMI	26.4 (2.6)	26 (2.5)	1.8	>0.05
Malondialdehyde	4.5 (0.51)	2.4 (0.38)	34.9	<0.001
Total Antioxidant Capacity	737 (132.8)	1044 (146.3)	16.5	<0.001

**Ethical Clearance:** None

**Source of Funding:** None

**Conflict of Interest:** None

### References

- Alsamarai AGM. Prevalence of skin diseases in Iraq. *Int J Derm* 2009;48(7):734-9.
- Torres T, Bettencourt N. Psoriasis: The visible killer. *Rev Port Cardiol* 2014;33(2):95-99.
- Gelfand JM, Feldman SR, Stern RS, Thomas J, Rolstad T, Margolis DJ. Determinants of quality of life in patients with psoriasis: a study from the US population. *J Am Acad Dermatol* 2004;51:704-8.
- Sun L, Zhang X. The immunological and genetic aspects in psoriasis. *Applied Informatics* 2014;1(3). <http://www.applied-informatics-j.com/content/1/1/3>
- Alobaidi AHA, Abid I, Alsamarai AGM. Psoriasis: Role of Tumor Necrosis Factor- $\alpha$ , Interleukin-18, C Reactive Protein, 2015, LAMBERT Academic Publishing. Germany.
- Alobaidi AHA, Jaber T, Alsamarai AGM. Psoriasis: Paraoxonase and Lipoprotein (a) Role. 2015, LAMBERT Academic Publishing.
- Reich K. The concept of psoriasis as a systemic inflammation: implications for disease management. *J EADV* 2012;26:3-11.
- Borska L, Kremlacek J, Andrys C, Krejsek J, Hamakova K, Borsky P, et al. Systemic inflammation, oxidative damage to nucleic acids, and metabolic syndrome in the pathogenesis of psoriasis. *Int J Mol Sci* 2017;18:2238.
- Alobaidi AHA. Biochemical changes in psoriasis: 1. Lipid profile, oxidant and antioxidant markers. *Middle East J Intern Med* 2010;2(3):27-34.
- Alobaidi AHA, Mothana Z, Najem WS, Alsamarai AGM. Adiponectin, IL-10, IL-23, and trace element serum levels in patients with psoriasis. *Am J Derm Vener* 2012;1(2):6-23.
- Coumbe AG, Pritzker MR, Duprez DA.

- Cardiovascular risk and psoriasis: beyond the traditional risk factors. *Am J Med* 2014;127:12-18.
12. Al Houssein RO, Al Sheikh A. Co- morbidities in psoriatic versus non-psoriatic patients. *J Health Spec* 2018;6:82-6.
  13. Ghafoor R, Rashid A, Anwar MI. Dyslipidemia and psoriasis: a case control study. *J Coll Phys Surg Pakis* 2015;25(5):324-7.
  14. Coimbra S, Santos-Silva A. Biomarkers of psoriasis severity and therapy monitoring. *World J Dermatol* 2014;3(2):15-27.
  15. Peluso I, Cavaliere A, Palmery M. Plasma total antioxidant capacity and peroxidation biomarkers in psoriasis. *J Biomed Sci* 2016;23:52.
  16. Singh S, Young P, Armstrong AW. An update on psoriasis and metabolic syndrome: a meta-analysis of observational studies. *PLOS ONE* 2017; 12(7):1-13.
  17. Milcic D, Vesic S, Marinkovic J, Jankovic J, Jankovic S, Milinkovic M, Cirkovic A. Prevalence of metabolic syndrome in patients with psoriasis: a hospital based cross-sectional study. *An Bras Dermatol* 2017;92(1):46-51.
  18. Gupta M, Chari S, Borkar M, Chandankhede M. Dyslipidemia and oxidative stress in patients with psoriasis. *Biomed Res* 2011;22(2):222-5.
  19. Rao SV, Kiran VR, Prakash VB. Lipid profile and its relationship to oxidant and antioxidant status in psoriatic arthritis. *IJBR* 2014;5(4):251-3.
  20. Saxena R, Suneja S, Saxena R, Sharma D, Lal AM. Systemic inflammation, oxidative stress and apolipoprotein B/A1 ratio in active psoriasis: bridging an apparent paradox. *Int J Res Dermatol* 2015;1(1):10-3.
  21. Gui XY, Yu XL, Jin HZ, Zuo YG, Wu C. Prevalence of metabolic syndrome in Chinese psoriasis patients: a hospital based cross-sectional study. *J Diabetes Investig* 2018;9(1):39-43.
  22. Devi N, Swain S, Padhy RK, Mahapatra S. Study of serum lipid profile and their relationships with oxidant-antioxidant system in patients with psoriasis. *Int J Current Med Appli Sci* 2015;7(2):120-4.
  23. Sandhya M, Arun KM, Doddamani BR, Satyanarayana U, Shurutu M. Circulatory markers of oxidative stress and dyslipidemia in male patients of chronic plaque psoriasis. *Int J Med Pub Health* 2015;5(3):208-12.
  24. Armstrong AW, Harskamp CT, Armstrong EJ. The association between psoriasis and hypertension: a systematic review and meta-analysis of observational studies. *J Hypertens* 2013;31:433-42.
  25. Yeung H, Takeshita J, Mehta NN, Kimmel SE, Ogdie A, Margolis DJ, et al. Psoriasis severity and the prevalence of major medical comorbidity: a population based study. *Jama Dermatol* 2013;149(10):1173-9.
  26. Janero D. Malodialdehyde and thiobarbituric acid reactivity as diagnostic indices of lipid peroxidation and peroxidative tissue injury. *Free Rad Biol Med* 1998;9:515-40.
  27. Kampa M, Nistikaki A, Tsaousis V, Maliaraki N, Notas G, Castanas E. A new automated method for the determination of TAC of human plasma based on crocin bleaching assay. *BMC Clin Pathol* 2002;2:3-21.
  28. Kural BV, Orem A, Cimsit G, Yandi YE, Calapoglu M. . Evaluation of the atherogenic tendency of lipids and lipoprotein content and their relationships with oxidant-antioxidant system in patients with psoriasis. *Clin Chem Acta* 2003;328:71-82.
  29. Rocha –Pereira P, Santos-Silva A, Rebelo I, Figueiredo A, Quintanilha A, Teixeira F. Dyslipidemia and oxidative stress in mild and severe psoriasis as a risk for cardiovascular disease. *Clin Chem Acta* 2001;303:33-9.
  30. Gavan N, Popa R, Orasan R, Mainbach H. Effect of percutaneous absorption of flucinolone acetonide on the activity of superoxide dismutase and total antioxidant status in patients with psoriasis. *Skin Pharmacol* 1997;10:178-82.
  31. Severin E, Nave B, Stander M, Ott R, Traupe H. Total antioxidant capacity is normal in sera from psoriasis patients despite elevated bilirubin, tachopheroland urate levels. *Dermatology* 1999;198:336-9.
  32. Tampa M, Sarba MI, Mitran MI, Mitran CI, Matie C, Georgescu SR. The pathophysiological mechanisms and the quest for biomarkers in psoriasis, a stress related skin disease. *Disease Markers* 2018;Article ID 5823684, 14 pages.
  33. Rodriguez-Cerdcirca C, Molaris-Vila A, Sanches-Blanco E, Sanchez –Blanco B. Study on certain biomarkers of inflammation in psoriasis through ‘ OMICS’ platforms. *Open Bioche J* 2014;8:21-34.

34. O' Daly JA. Psoriasis, a systemic disease beyond the skin, as evidenced by psoriatic arthritis and many comorbidities – clinical remission with a leishmania amastigotes vaccine, a serendipity finding. 2012, pp 1-56, InTech publishers. Croatia
35. Augustin M, Reich K, Glaeske G, Schaefer I, Radtke M. Co-morbidity and age-related prevalence of psoriasis: analysis of health insurance data in Germany. *Acta Derm Venereol* 2010; 90: 147–151.
36. Augustin M, Glaeske G, Radtke MA, Christophers E, Reich K, Schafer I. Epidemiology and comorbidity of psoriasis in children. *Br J Dermatol* 2010; 162: 633–636.
37. Davidovici BB, Sattar N, Jorg PC, Puig L, Emery P, Barker GN, et al. Psoriasis and systemic inflammatory diseases: potential mechanistic links between skin disease and co-morbid conditions. *J Invest Dermatol* 2010;130:1985-96.
38. Dalgard FJ, Gieler U, Tomas-Aragones L, Lien L, Poot F, Gemec GB, et al. The psychological burden of skin diseases: a cross-sectional multicenter study among dermatological out-patients in 13 European countries. *J Invest Dermatol* 2015;135(4): 984–91.
39. Kimball AB, Jacobson C, Weiss S, Vreeland MG, Wu Y. The psychosocial burden of psoriasis. *Am J Clin Dermatol* 2005; 6(6): 383–392.
40. Basavaraj KH, Navya MA, Rashmi A. Stress and quality of life in psoriasis: an update. *Inter J Derm* 2011; 50(7):783–792.
41. Wu JJ, Penfold RB, Primatesta P, Fox TK, Stewart C, Ready SP, et al., . The risk of depression, suicidal ideation and suicide attempt in patients with psoriasis, psoriatic arthritis or ankylosing spondylitis. *J Euro Acad Derm Venere* 2017; 31(7):1168–1175.
42. Kurd SK, Troxel AB, Crits-Christoph P, Gelfand JM. The risk of depression, anxiety and suicidality in patients with psoriasis: a population-based cohort study. *Arch Derm* 2010;146(8):891–895.
43. Ferreira BI, Abreu JL, Reis JP, Figueiredo AM. Psoriasis and associated psychiatric disorders: a systematic review on etiopathogenesis and clinical correlation. *J Clin Aesth Derm* 2016; 9(6):36–43.
44. Gupta MA, Schork NJ, Gupta AK, Kirkby S, Ellis CN. Suicidal ideation in psoriasis. *Inter J Derm* 1993; 32 (3): 188–190.
45. Egeberg A, Hansen PR, Gislason GH, Skov L, Mallbris L. Risk of self-harm and nonfatal suicide attempts, and completed suicide in patients with psoriasis: a population-based cohort study. *Br J Derm* 2016;175(3):493–500.
46. Moynihan J, Rieder E, Tausk F. Psychoneuroimmunology: the example of psoriasis. *Giornale Italiano di Dermatologia e Venereologia* 2010;145(2): 221–228.
47. Steptoe A, Hamer M, Chida Y. The effects of acute psychological stress on circulating inflammatory factors in humans: a review and meta-analysis. *Brain Behavior Imm* 2007; 21(7):901–912.
48. Maes M, Song C, Lin A, De Jongh R, Van Gastel A, Kenis G, et al. The effects of psychological stress on humans: increased production of pro-inflammatory cytokines and Th1-like response in stress-induced anxiety. *Cytokine* 1998;10(4): 313–318.
49. Reichenberg A, Yirmiya R, Schuld A, Kraus T, Haack M, Morag A, et al., . Cytokine associated emotional and cognitive disturbances in humans. *Arch Gen Psych* 2001;58(5):445–452.
50. Tyring S, Gottlieb A, Papp K, Gordon K, Leonardi C, Wang A, et al., . Etanercept and clinical outcomes, fatigue, and depression in psoriasis: double-blind placebo-controlled randomised phase III trial. *Lancet* 2006; 367(9504):29–35.
51. Miller AH, Maletic V, Raison CL. Inflammation and its discontents: the role of cytokines in the pathophysiology of major depression. *Biological Psychiatry* 2009;65(9):732–741.
52. Raison CL, Capuron L, Miller AH. Cytokines sing the blues: inflammation and the pathogenesis of depression. *Trends Immunology*, 2006; 27(1):24–31.
53. Buske-Kirschbaum A, Kern S, Ebrecht M, Hellhammer DH. Altered distribution of leukocyte subsets and cytokine production in response to acute psychosocial stress in patients with psoriasis vulgaris. *Brain Behavior Immunity* 2007; 21(1): 92–99.
54. Hall JM, Podawiltz A, Mummert DI, Jones H, Mummert ME. Psychological stress and the cutaneous immune response: roles of the HPA axis and the sympathetic nervous system in atopic dermatitis and psoriasis. *Derm Res Pract* 2012;VOL 2012, Article ID 403908, 11 pages, 2012.
55. Harvima IT, Viinamäki H, Naukkarinen A, Paukkonen K, Neittaanamaki H, Harvima RJ,

- et al.. Association of cutaneous mast cells and sensory nerves with psychic stress in psoriasis. *Psychotherapy Psychosomatics*, 1993;60(3): 168–176.
56. Evers AW, Verhoeven EW, Kraaimaat FW, de Jong EM, de Brouwer SJ, Schalkwijk J, et al. How stress gets under the skin: cortisol and stress reactivity in psoriasis. *Br J Derm* 2010; 163(5):986–91.
57. Connor CJ, Liu V, Fiedorowicz JG. Exploring the physiological link between psoriasis and mood disorders. *Derm Res Practice*, 2015; vol. 2015: Article ID 409637, 11 pages, 2015.
58. Cemil BC, Canpolat F, Yilmazer D, Eskioğlu F, Alper M. The association of PASI scores with CRH-R1 expression in patients with psoriasis. *Arch Dermatol Res* 2012; 304(2):127–132.
59. Vasiadi M, Therianou A, Alysandratos KD, Katsarou-Katsari A, Petrakopoulou T, Theoharides A. Serum neurotensin (NT) is increased in psoriasis and NT induces vascular endothelial growth factor release from human mast cells. *Br J Derm* 2012;166(6):1349–1352.
60. Alsamarai AGM, Association Between Stress and Skin Disease. *Middle East Journal of Internal Medicine* 2010; 3(1):12-19.
61. Cantrell W, Gorelick J, Kucera KJ, Freeman S. Systemic inflammation in psoriasis: a guide for dermatology care providers. *Pract Derm* 2018;7:38-45.
62. Takeshita J, Grewal S, Langan SM, Mehta NN, Ogdie A, Van AS, et al. Psoriasis and comorbid diseases: Epidemiology. *J Am Acad Dermatol*. 2017;76(3):377-390.
63. Chi CC, Wang J, Chen YF, Wang SH, Chen FL, Tung TH. Risk of incident chronic kidney disease and end-stage renal disease in patients with psoriasis: A nationwide population-based cohort study. *J Dermatol Sci*. 2015;78(3): 232-238.
64. Armstrong AW, Harskamp CT, Armstrong EJ. Psoriasis and metabolic syndrome: a systematic review and meta-analysis of observational studies. *J Am Acad Dermatol*. 2013;68(4):654-662.
65. Armstrong AW, Harskamp CT, Armstrong EJ. Psoriasis and the risk of diabetes mellitus: a systematic review and meta-analysis. *JAMA Dermatol*. 2013;149(1):84-91.
66. Armstrong EJ, Harskamp CT, Armstrong AW. Psoriasis and major adverse cardiovascular events: a systematic review and meta-analysis of observational studies. *J Am Heart Assoc*. 2013;2(2):e000062.
67. Ma C, Harskamp CT, Armstrong EJ, Armstrong AW. The association between psoriasis and dyslipidaemia: a systematic review. *Br J Dermatol*. 2013;168(3):486-495.
68. Abuabara K, Azfar RS, Shin DB, Neimann AL, Troxel AB, Gelfand JM. Cause-specific mortality in patients with severe psoriasis: a population-based cohort study in the U.K. *Br J Dermatol*. 2010;163(3):586-592.
69. Suzuki E, Mellins ED, Gershwin ME, Nestle FO, Adamopoulos IE. The IL-23/IL-17 axis in psoriatic arthritis. *Autoimmun Rev*. 2014;13(4-5):496-502.
70. Sanz LP. Psoriasis, a systemic disease? *Actas Dermosifiliogr* 2007;98:396-402.
71. Christophers E. Comorbidities in psoriasis. *J Eur Acad Dermatol Venereol*. 2006;20(s2):52-5.
72. Zachariae H, Zachariae R, Blomqvist K, Davidsson S, Molin L, Mork C, et al. Quality of life and prevalence of arthritis reported by 5, 795 members of the Nordic Psoriasis Associations. Data from the Nordic Quality of Life Study. *Acta Derm Venereol*. 2002;82:108-13.
73. Gisondi P, Girolomoni G, Sampogna F, Tabolli S, Abeni D. Prevalence of psoriatic arthritis and joint complaints in a large population of Italian patients hospitalised for psoriasis. *Eur J Dermatol*. 2005;15:279-83.
74. Gottlieb AB, Mease PJ, Mark Jackson J, Eisen D, Amy Xia H, Asare C, et al. Clinical characteristics of psoriatic arthritis and psoriasis in dermatologists' offices. *J Dermatolog Treat*. 2006;17:279-87.
75. Najarian DJ, Gottlieb AB. Connections between psoriasis and Crohn's disease. *J Am Acad Dermatol*. 2003;48: 805-21.
76. Mrowietz U, Elder JT, Barker J. The importance of disease associations and concomitant therapy for the long-term management of psoriasis patients. *Arch Dermatol Res*. 2006;298:309-19.
77. Hannuksela-Svahn A, Pukkala E, Laara E, Poikolainen K, Karvonen J. Psoriasis, its treatment, and cancer in a cohort of Finnish patients. *J Invest Dermatol*. 2000;114:587-90.

78. Margolis D, Bilker W, Hennessy S, Vittorio C, Santanna J, Strom BL. The risk of malignancy associated with psoriasis. *Arch Dermatol.* 2001;137:778-83.
79. Gelfand JM, Berlin J, Van Voorhees A, Margolis DJ. Lymphoma rates are low but increased in patients with psoriasis: results from a population-based cohort study in the United Kingdom. *Arch Dermatol.* 2003;139:1425-9.
80. Gelfand JM, Shin DB, Neimann AL, Wang X, Margolis DJ, Troxel AB. The risk of lymphoma in patients with psoriasis. *J Invest Dermatol.* 2006;126:2194-201.
81. Boehncke S, Salgo R, Garbaraviciene J, Ludwig RJ, Ackerman H, Badenhoop K, et al. Effective continuous systemic therapy of severe plaque-type psoriasis is accompanied by amelioration of biomarkers of cardiovascular risk: results of a prospective longitudinal observational study. *J Eur Acad Dermatol Venereol.* 2011;25(10):1187-1193.
82. Prodanovich S, Ma F, Taylor JR, Pezon C, Fasihi T, Kirsner RS. Methotrexate reduces incidence of vascular diseases in veterans with psoriasis or rheumatoid arthritis. *J Am Acad Dermatol.* 2005;52(2):262-267.
83. Young M, Aldredge L, Parker P. Psoriasis for the primary care practitioner. *J Am Assoc Nurse Pract.* 2017;29(3):157-178.
84. Wu JJ, Poon KY. Tumor necrosis factor inhibitor therapy and myocardial infarction risk in patients with psoriasis, psoriatic arthritis, or both. *J Drugs Dermatol.* 2014;13(8):932-934.
85. Campanati A, Ganzetti G, Di Sario A, Damiani A, Sandroni L, Rosa L, et al. The effect of etanercept on hepatic fibrosis risk in patients with non-alcoholic fatty liver disease, metabolic syndrome, and psoriasis. *J Gastroenterol.* 2013;48(7):839-846.
86. Alobaidi AHA, Alsamarai AGM. Adenosine deaminase, malondialdehyde, total antioxidant capacity and eosinophil cationic protein in patients with erythroderma. *J Invest Biochem* 2013;2(1):6-13.

# IL-6, IL-0, IFN Gamma and CRP in Newly Diagnosed COVID 19 Patients

Mazin Jabbar Kathim<sup>1</sup>; Tamara Amer Taha<sup>2</sup>, Suzan Saadi Hussain<sup>3</sup>, Nihad Khalawe Tektook<sup>4</sup>

<sup>1</sup>Department of Orthopaedic Surgery, Fallujah Technical Hospital, Inbar, <sup>2</sup>Lecturer, College of Basic Education, University of Diyala, <sup>3</sup>Prof., College of Science, Mustansiriyah University, <sup>4</sup>Assist. Prof. Middle Technical University, College of Medical and Health Technology, Medical Laboratory Techniques Dep., Baghdad-Iraq

## Abstract

The study was conducted in Baghdad for the period from July 1 to August 20 2020 on patients previously diagnosed with the emerging corona virus .. The study included 40 patients whose ages ranged from 20 to 80 years. The study also included taking 40 healthy people of the same age groups to detect interleukin 6 and 10 gamma interferon by using ELISA technique as well as measuring the level of the C-reactive protein. The study contained a withdrawal of five ml of venous blood from patients and patients and took all the necessary information from them such as gender, age, current living status, number of family members, as well as the history of infection and travel to countries affected by the virus to compare the two groups with regard to the immune response by measuring the variables above. The study showed that the highest mean level of IL-6 was found in newly diagnosed COVID-19 patients comparing with healthy control ( $60.76 \pm 8.46$  v.s.  $39.03 \pm 5.26$  pg/ml) ( $P < 0.01$ ). The study also demonstrated that the level of IL-10 was significantly elevated in newly diagnosed COVID-19 patients as compared with healthy control ( $38.18 \pm 4.57$  v.s.  $31.84 \pm 3.19$  pg/ml). The study established that the level of IFN-Gamma was significantly increased in patients with new infection of COVID-19 as compared with healthy control ( $27.27 \pm 7.18$  v.s.  $13.81 \pm 3.83$  pg/ml) ( $P < 0.01$ ). The study proven that the level of CRP was increased significantly in patients with new infection of COVID-19 as compared with healthy control ( $33.18 \pm 3.19$  v.s.  $3. \pm 1.81$  mg/dl) ( $P < 0.01$ ). The study concluded that, There was a highly significant relation of IL-6, IL-0, IFN gamma, and CRP with COVID-19 disease in the first week of infection

**Keyword:** COVID-19; SARS COV2; IL-6; IFN gamma; CRP.

## Introduction

The presence of a new virus belonging to the Coronavirus family was announced at the end of 2019 in Wuhan, China, and it was recently agreed to name it as Covid-19, SARS-Coronavirus2<sup>(1)</sup>. It was declared by the World Health Organization (WHO) as an epidemic that spread rapidly around the world and raised international

concern and raised the state of emergency in all countries that it entered due to its rapid spread and the lack of clarity of all signs of infection as it is a new virus that infects humans and is transmitted from animals and then transmitted between humans and humans<sup>(2)</sup>. The genetic sequence of the virus represents a 96% and 79.5% match for the bat coronavirus and SARS-CoV, respectively. Such as SARS-CoV and MERS-CoV. The previous evidence also showed that most patients have shown that the level of cytokines and immune proteins are among the most important causes of patients 'recovery first, and then it is possible that these cytokines will do the opposite in the deterioration of the disease by forming the so-called cytokines storm<sup>(3,4)</sup>. However, until this moment, there are scarce studies about what the virus is and the true immune role of the host's body towards the

---

### Corresponding Author:

**Nihad Khalawe Tektook**

Assist. Prof. Middle Technical University, College of Medical and Health Technology, Medical Laboratory Techniques Dep., Baghdad-Iraq  
e-mail: drnihadkhalawe@gmail.com



virus, especially as it was presented that the virus is new and information about its pathogenicity is not available in an accurate and clear way<sup>(5)</sup>. Studies indicate that the COVID-19 virus was more likely to affect adults of older ages and the elderly who have associated diseases such as diabetes, high weakness, heart and lung problems, and whose immunity is low due to the presence of those diseases that are characterized by low immunity<sup>(6, 7)</sup>. Especially since the virus is a virus with a new strain that has not yet been known about the true condition of the infected, the high rates of infection and the spread of disease among groups of society and the elderly in particular, and that the high levels of inflammatory cytokines among people with the good coronavirus and not many people know about the nature of the immune response for patients infected with the emerging coronavirus<sup>(8)</sup>. So the aim of the study was to estimate the level of IL-6, IL-0, IFN gamma and CRP in patients with COVID-19 infection.

## Material and Method

The study was conducted in Baghdad for the period from July 1 to August 20 2020 on patients previously diagnosed with the emerging corona virus .. The study included 40 patients whose ages ranged from 20 to 80 years. The study also included taking 40 healthy people of the same age groups to detect interleukin 6 and 10 gamma interferon by using ELISA technique (Koma biotech, ELISA, USA).as well as measuring the level of the C-reactive protein. The study contained a withdrawal of five ml of venous blood from patients and patients and took all the necessary information from them such as gender, age, current living status, number of family members, as well as the history of infection and travel to countries affected by the virus to compare the two groups with regard to the immune response by measuring the variables above.

**Findings:** As shown in Table 1. There was no significant difference between studied cases and the control group regarding patient age.

**Table 1: Clinical characteristics of studied women**

Parameters (Mean±SD)	Pregnant women	Control group
No.	40	40
Age (yeas)	52.1±6.7	50.6±5.6
Sex	35 male, 15 female	33 male, 17 female
Mean 24 h SBP, mm Hg	128.7±11.5 *	110.8±7.4
Mean 24 h DBP, mm Hg	83.5±6.9*	69.4±8.3
Maximal SBP, mm Hg	167±24.1*	119.0±10.2
Maximal DBP, mm Hg	109.1±22.7*	74.7±13.3

The study showed that the highest mean level of IL-6was found in newly diagnosed COVID-19 patients comparing with healthy control (60.76±8.46v.s.39.03±5.26 pg/ml) (P:<0.01).

**Table 2: Levels of IL-6 in newly diagnosed COVID-19 patients and the control group**

Group	Mean (pg/ml)	SD	P value
COVID-19 patients	60.76	8.46	<0.05
Healthy group	39.03	5.26	

The study also demonstrated that the level of IL-10 was significantly elevated in newly diagnosed COVID-19 patients as compared with healthy control (38.18±4.57 v.s.31.84±3.19 pg/ml) (P:<0.01), Table 3.

**Table 3: Levels of IL-10 in newly diagnosed COVID-19 patients and the control group**

Group	IL-10 Mean (pg/ml)	SD	P value
COVID-19 patients	38.18	4.57	<0.05
Healthy group	31.84	3.19	

The study established that the level of IFN-Gamma was significantly increased in patients with new infection of COVID-19 as compared with healthy control (27.27±7.18 v.s. 13.81±3.83 pg/ml) (P:<0.01), Table 4.

**Table 4: Levels of IFN-Gamma in newly diagnosed COVID-19 patients and the control group**

Group	IFN-Gamma Mean (pg/ml)	SD	P value
COVID-19 patients	27.27	7.18	<0.05
Healthy group	13.81	3.83	

The study proven that the level of CRP was increased significantly in patients with new infection of COVID-19 as compared with healthy control (33.18±3.19 v.s. 3.1±1.81 mg/dl) (P:<0.01), Table 5.

**Table 4: Levels of CRP in newly diagnosed COVID-19 patients and the control group**

Group	CRP Mean (mg/dl)	SD	P value
COVID-19 patients	33.18	3.19	<0.05
Healthy group	4.17	1.81	

**Table 5: Correlation of CRP with each parameter in the study**

Parameter	R value
IL-6	0.7
IL-10	0.52
IFN-Gamma	0.49

### Discussion

In this study, levels of IL-6, IL-0, IFN gamma, and CRP were increased in subjects with coronavirus, and I mean Yen, who was newly diagnosed with the virus by nasopharyngeal swab examination and polymerase chain reaction method. It should be noted that the observed increase in the levels of g variables. Several very recent global responses indicate that IFN $\gamma$  and IL-6 F levels are positively associated with an increased infection with the Covid 19 virus that causes acute respiratory syndrome (9). Other studies suggest that an excess of these cytokines and other inflammatory agents may cause the body to create a so-called cytokine storm (10, 11). While this virus multiplies in the cells of the upper respiratory system and then descends gradually until it reaches the internal lung tissues, the increase in the secretions of cytokines above may lead to acute respiratory distress

syndrome associated with the new corona virus as a result of bulimia and acute reproduction. From a virus with induction of conventional antiviral immunity and with a crisis associated with a possible peak phase of T cell responses. However, it is not clear whether immune hyperactivity or failure to resolve the inflammatory response due to persistent viral replication or immune dysregulation underlies severe disease (12). Several recent responses undertaken to determine the role of immunity and the immune response to Covid-19 indicate that interleukin-6 and CRP are elevated in patients with COVID-19, particularly those with comorbidities such as diabetes and chest and vascular pain (13-16). Other studies have also indicated two settings induced by viral infection and epithelial cell proliferation in the airway in high levels of viral-associated acid inflammation with associated vascular leakage, as seen in SARS-CoV53 patients. Prostatitis is a highly inflammatory form of programmed cell death that is commonly observed with cytokine viruses 54. This is a potential trigger for a subsequent inflammatory response (17, 18). It is worth noting that another study conducted in advance during the past few months reported that the highest levels of serum inflammatory cytokines, interleukin-6 and CRP were in patients diagnosed with severe Covid-19 compared to individuals with mild disease, similar to the

results of our study that confirmed this, which stated that There was a significant positive correlation of CRP with all cytokines that were taken in the current study (19). Some scientists believe that the rise of these pathogens, in addition to other factors that have not been taken into account, may play a vital role in the fluctuation of autoimmunity first, then the original immunity in patients infected with the new coronavirus, Covid 19 (20). Although there was no direct evidence that cytokines and inflammatory chemicals were involved in lung disease during COVID-19, changes in laboratory parameters, including elevated blood cytokines, chemokine levels, and increased CRP in affected patients, were associated with disease severity and adverse outcomes(21).

### Conclusions

Levels of IL-6, IL-0, IFN gamma, and CRP were elevated significantly in patients with COVID-19 disease in the first week of infection

**Conflict of Interest:** None

**Source of Findings:** None

**Ethical Clearance:** None

### References

- Prompetchara E, Ketloy C, Palaga T. Immune responses in COVID-19 and potential vaccines: Lessons learned from SARS and MERS epidemic. *Asian Pac J Allergy Immunol.* 2020 Mar 1;38(1):1-9.
- Giamarellos-Bourboulis EJ, Netea MG, Rovina N, Akinosoglou K, Antoniadou A, Antonakos N, Damoraki G, Gkavogianni T, Adami ME, Katsaounou P, Ntaganou M. Complex immune dysregulation in COVID-19 patients with severe respiratory failure. *Cell host & microbe.* 2020 Apr 21.
- Weitz JS, Beckett SJ, Coenen AR, Demory D, Dominguez-Mirazo M, Dushoff J, Leung CY, Li G, Măgălie A, Park SW, Rodriguez-Gonzalez R. Modeling shield immunity to reduce COVID-19 epidemic spread. *Nature medicine.* 2020 May 7:1-6.
- Azkur AK, Akdis M, Azkur D, Sokolowska M, van de Veen W, Brügggen MC, O'Mahony L, Gao Y, Nadeau K, Akdis CA. Immune response to SARS-CoV-2 and mechanisms of immunopathological changes in COVID-19. *Allergy.* 2020 Jul; 75(7):1564-81.
- Yang Y, Lu Q, Liu M, et al. Epidemiological and clinical features of the 2019 novel coronavirus outbreak in China. 2020. 2020.02.10.20021675.
- Wong CK, Lam CW, Wu AK, et al. Plasma inflammatory cytokines and chemokines in severe acute respiratory syndrome. *Clin Exp Immunol* 2004; 136:95–103.
- Mahallawi WH, Khabour OF, Zhang Q, Makhdom HM, Suliman BA. MERS-CoV infection in humans is associated with a pro-inflammatory Th1 and Th17 cytokine profile. *Cytokine* 2018; 104:8–13.
- National Health Commission of the Peoples Republic of China. The Fifth Revised Trial Version of the Novel Coronavirus Pneumonia Diagnosis and Treatment Guidance. Available at: <http://www.nhc.gov.cn/yzygj/s7652m/202002/41c3142b38b84ec4a748e60773c9d4f.shtml>.
- Google Scholar
- Luo Y, Xie Y, Zhang W, et al. Combination of lymphocyte number and function in evaluating host immunity. *Aging (Albany NY)* 2019; 11:12685–707.
- Hou H, Zhou Y, Yu J, et al. Establishment of the reference intervals of lymphocyte function in healthy adults based on IFN- $\gamma$  secretion assay upon phorbol-12-myristate-13-acetate/ionomycin stimulation. *Front Immunol* 2018; 9:172.
- Wang D, Hu B, Hu C, et al. Clinical characteristics of 138 hospitalized patients with 2019 novel coronavirus-infected pneumonia in Wuhan, China. *JAMA* 2020. doi:10.1001/jama.2020.1585
- Curbelo J, Luquero Bueno S, Galván-Román JM, et al. Inflammation biomarkers in blood as mortality predictors in community-acquired pneumonia admitted patients: importance of comparison with neutrophil count percentage or neutrophil-lymphocyte ratio. *PLoS One* 2017; 12:e0173947.
- Liu X, Shen Y, Wang H, Ge Q, Fei A, Pan S. Prognostic significance of neutrophil-to-lymphocyte ratio in patients with sepsis: a prospective observational study. *Mediators Inflamm* 2016; 2016:8191254.
- Berhane M, Melku M, Amsalu A, Enawgaw B, Getaneh Z, Asrie F. The role of neutrophil to lymphocyte count ratio in the differential diagnosis of pulmonary tuberculosis and bacterial community-acquired pneumonia: a cross-sectional

- study at Ayder and Mekelle Hospitals, Ethiopia. *Clin Lab* 2019; 65.
16. Min CK, Cheon S, Ha NY, et al. Comparative and kinetic analysis of viral shedding and immunological responses in MERS patients representing a broad spectrum of disease severity. *Sci Rep* 2016; 6:25359.
  17. Channappanavar R, Perlman S. Pathogenic human coronavirus infections: causes and consequences of cytokine storm and immunopathology. *Semin Immunopathol* 2017; 39:529–39.
  18. Shaw AC, Goldstein DR, Montgomery RR. Age-dependent dysregulation of innate immunity. *Nat Rev Immunol* 2013; 13:875–87.
  19. Moro-García MA, Alonso-Arias R, López-Larrea C. When aging reaches CD4+ T-cells: phenotypic and functional changes. *Front Immunol* 2013; 4:107.
  20. Sakaguchi S, Miyara M, Costantino CM, Hafler DA. FOXP3+ regulatory T cells in the human immune system. *Nat Rev Immunol* 2010; 10:490–500.
  21. Sakaguchi S. Regulatory T cells: key controllers of immunologic self-tolerance. *Cell* 2000; 101:455–8.

# The Value of Measurement of Bilirubin in Pleural Fluid in the Differentiation between Exudative and Transudative Pleural Effusion

Bint Alhuda A. Jaber<sup>1</sup>, Khalid Abd Alstar Hussein<sup>2</sup>, Zahrah Salih<sup>3</sup>

<sup>1</sup>M.B.CH.B. Respiratory/Ibn Alnafes Cardiovascular Teaching Hospital, <sup>2</sup>MSc. Cardiology. MBCHB Cardiologist/Ibn Alnafes Cardiovascular Teaching Hospital, <sup>3</sup>M.B.CH.B Anesthesiologist

## Abstract

**Background:** The pleural effusion is a common clinical problem which can be exudative or transudative in nature due to variety of causes. Measurement of biochemical markers in the pleural fluid is an important measure to distinguish exudative from transudative effusion.

**Aim of the Study:** Is to determine the value of pleural fluid to serum bilirubin ratio to differentiate between transudative and exudative pleural effusion.

**Patients and Method:** Thirty-five patients enrolled in this study, they admitted to medical ward in Baghdad teaching hospital and submitted to clinical, radiological, ultrasonographic examination proved to have pleural effusion from December 2018 to July 2019. Samples of blood and pleural fluid aspirated in the medical ward, analyzed after 30-60 minute of aspiration. The sample of some cases were analyzed in private laboratories. Serum protein, total serum bilirubin and other investigation according to the condition of the patient like blood urea, serum creatinine, liver function test, sputum of AFB. Pleural fluid analyzed from protein, total bilirubin, cell count, differential and cytology. Pleural biopsy was done to patients suspected to have malignant or tuberculous effusion and grouped at the end of their hospitalization into exudative and transudative effusion according to specific etiology, clinical examination, radiological finding, and then measure the pleural fluid to serum protein ratio, pleural fluid to serum bilirubin for each patient. We depended on pleural fluid to serum protein ratio to compare with pleural fluid to serum bilirubin ratio for differentiation between exudative and transudative pleural fluid.

**Results:** Twenty two patients with exudative effusion and thirteen patients were having transudate according to pleural fluid to serum protein (Light's criteria). P-value= 0.002, Fisher. Exact test= 0.001. Twenty three patients with exudative effusion and twelve patients with transudative effusion according to pleural fluid to serum bilirubin ratio. P value= 0.37, Fisher. Exact test = 0.45. Pf/s ratio can increase the sensitivity and specificity of Light's criteria.

**Conclusions:** Pleural fluid to serum bilirubin ratio can't replace Light's criteria in differentiation between exudates and transudate pleural effusion. Pf/s bilirubin ratio is a reliable test can easily perform but not common use in our hospital because of its costly and not familiar use in our laboratories.

**Keywords:** Bilirubin; Pleural fluid; exudative; Transudative pleural effusion.

## Introduction

The pleural lining is a serious membrane covering the lung parenchyma, chest wall, diaphragm, and mediastinum. The pleural membrane covering the surface of the lung is known as visceral pleura, whereas the parietal pleura cover the remaining mentioned

structures. In between the visceral and parietal pleura is the pleural space, a potential space that contain a thin layer of fluid (approximately 0.15 ml/kg/pleural space) usually around 10 ml in each pleural space. The parietal pleura secrete approximately 2400 ml of fluid daily, which is reabsorbed by the visceral pleura<sup>(1)</sup>.A

pleural effusion is present when there is an excess quantity of fluid in the pleural space<sup>(2)</sup>. Pleural fluid accumulates when pleural fluid formation exceeds pleural fluid absorption; fluid enters the pleural space from the capillaries in the parietal pleura and is removed via lymphatic situated in the visceral pleura. Fluid can also enter the pleural space from the interstitial space of the lung via the visceral pleura or from the peritoneal cavity via small holes in the diaphragm. The lymphatics have the capacity to absorb 20 times more fluid than is normally formed. Accordingly pleural effusion may develop when there is excess pleural fluid or peritoneal fluid or when there is decreased fluid removal by the lymphatics<sup>(1)</sup>. The distinction between a transudative and exudative pleural fluid is an important step in the diagnosis of the cause of the pleural effusion by using various parameters, like Light's criteria (1972) p/f is exudate if one or more of the following criteria are met<sup>(3,4)</sup>. (Pleural fluid protein/serum protein > 0.5, Pleural fluid LDH/serum LDH > 0.6, Pleural fluid LDH > two-third of upper limit of normal serum LDH) A pleural fluid to serum bilirubin ratio of more than 0.6 was suggested as an alternative to Light's criteria for distinguish exudates from transudate pleural fluid. Dyspnea is the most common symptom associated with pleural effusion, it related more to distortion of the diaphragm chest wall during respiration than to hypoxemia. In many patients drainage of pleural fluid alleviate symptoms despite limited improvement in gas exchange. Chest symptoms of pleural effusion include mild, non productive cough or chest pain. Other symptoms may suggest the etiology of pleural effusion e.g. more severe cough or production of purulent sputum suggest an underlying pneumonia or endobronchial lesion<sup>(5)</sup>. Constant chest wall pain may reflect chest wall invasion by bronchogenic carcinoma or malignant mesothelioma. Pleuritic chest pain suggests either pulmonary embolism or an inflammatory pleural process. Systemic toxicity evidence by fever, weight loss and inanition suggest empyema<sup>(6)</sup>. **PHYSICAL EXAMINATION:** Restriction in the chest expansion of one side or both sides, Trachea and apex beat may be displaced away from the effusion if it is large, Movement of affected side may be reduced, Percussion note is stony dull, Vocal fremitus and resonance are reduced, Breath sounds are reduced. Initial testing focuses on confirming that a pleural effusion is present. A chest x-ray study is the typical starting point. In the upright anteroposterior view, a small effusion may show up as blunting of the costophrenic angle. Larger effusions show a meniscus sign at the air fluid border. Lateral decubitus views

help estimate the size of the effusion<sup>(7)</sup>. Ultrasound can detect as little as 5 to 50 ml of fluid. It is also helpful in locating pockets of fluid and guiding thoracentesis for small effusions. Computed tomography, which is very sensitive, can differentiate pleural fluid from pleural thickening and focal masses<sup>(7)</sup>. Thoracentesis allows evaluation of any undiagnosed pleural effusion. Note that not all effusions require diagnostic thoracentesis. If the cause is apparent from the clinical presentation (e.g. CHF), observation may be appropriate<sup>(5)</sup>. In general, parapneumonic effusions require thoracentesis to confirm diagnosis and assess the need for chest tube placement.

### **Patients and Method**

Thirty-five patients enrolled in this study were admitted to medical ward of Baghdad teaching hospital and submitted to clinical examination and investigation, proved to have pleural effusion in the period from December 2018 to July 2019. Samples of blood and pleural fluid that were aspirate in the medical ward, analyzed after 30-60 minute of aspiration. Some of the cases analysis of their samples done in private laboratories. Serum analysis for protein concentration, total bilirubin and other investigation according to the condition of the patient like blood urea, serum creatinine, liver function, sputum for AFB and cytology. Pleural fluid analyzed for protein, total bilirubin, cell count, differential and cytology. Then calculate the pleural fluid to serum bilirubin for each patient and compare with pleural fluid to serum protein which measured also for each patient. The procedure for measuring protein in pleural fluid is called Zeilfa Biurate method, by taking 1.4 ml distal water mix with 0.1 fluid and 2.5 ml biurate, wait for 10 minute at room temperature then read the result by spectrophotometer at 540mm. The method for determination of bilirubin concentration in plasma (serum) which is the same use for measurement of total bilirubin in pleural fluid are divided into the method using:-Diazo reagent & DPD (dichlorobenzenediazonium salt) & Bilirubin oxidase & Direct spectrophotometric determination of bilirubin. The procedure which use in this research is the first one was Van den Berg's reaction with diazobenzenesulfonic acid from 1913. Method have been developed for the determination of total bilirubin (conjugate and unconjugated) or conjugated bilirubin alone. The proportion of unconjugated bilirubin is calculated as difference between total and conjugated bilirubin should previously be separated from albumin by use of an accelerator (methanol, sodium acetate

diphylline, sodium benzoate-sodium acetate-caffeine or detergent, e.g. Brij35) those conjugated bilirubin reacts directly in the reaction of diazotization. Bilirubin diazotization is generally performed by use of mixture of sulfanilic acid and sodium nitrite, however, diazonium salts of 2,5-dichlorophenyl or 2,4-dichloroaniline have recently also been introduced. The determination of bilirubin concentration by use of these method based on the formation of azobilirubin, which acts as an indicator. Is pink in acidic or neutral medium, and blue-green in alkaline medium.

**Statistical Analysis:** Chi square were used to study the variations in the ratio of pf/s protein ratio of different diseases and pf/s bilirubin ratio of different diseases. Also using F. E.t. F-test was used to study the variations of total serum protein, pleural fluid protein, total serum bilirubin and pleural fluid bilirubin.

**Results**

**Table (1): Classification of pleural effusion according to causes.**

Diagnosis	No . of patients	Percentage
Pulmonary TB	11	31.42%
Bronchogenic carcinoma	6	17.14%
Pulmonary Metastasis	5	14.28%
Pneumonia	2	5.71%
Undiagnosed		
HF	3	8.57%
RF	6	17.14%
Total	35	100%

Table (1) shows the number of patients with pleural effusion and the causes of their pleural effusion. The number of patient with tuberculous pleural effusion were

11 (31.43%), while those with bronchogenic carcinoma were six patients (17.14%), patients with pulmonary metastasis were five patients (14.28%) of patients with RF were 6 (17.14%) while those patients with heart failure were 3 (8.57%) and those cases undiagnosed were 3 (8.57%).

**Table (2): Distribution of cases according to the age**

Age (Year)	Number of patients	Percentage
10 - 19	2	5.71%
20 – 29	6	17.14%
30 – 39	3	8.57%
40 – 49	5	14.28%
50 – 59	4	11.42%
60 – 69	10	28.57%
70 - 79	5	14.28%

**Table (3): Classification of pl –effusion into exudate & transudate by f/s Bilirubin ratio .**

Type of fluid	Value of pf/s B.R	No .of patients	Percentage
Exudate	≥0.6	23	65.71%
Transudate	< 0.6	12	34.28%
<b>Total</b>		<b>35 Case</b>	

**Table 4: Classification of pl –effusion into exudates & transudate by F/s Protein ratio .**

Type of fluid	Value of pf/s pro.R	No .of patients	Percentage
Exudate	≥0.5	22	62.28%
Transudate	< 0.5	13	37.71%
<b>Total</b>		<b>35 Case</b>	

**Table (5): Distribution of diseases according to ratio of protein in pleural fluid to total serum protein**

Diseases	Ratio			
	≥0.5		<0.5	
	No.	%	No.	%
Pulmonary TB	9	81.8	2	18.2
Lung CA	5	83.3	1	
Heart failure	0	0.0	3	100.0
Secondary metastasis	5	100.0	0	0.0
Undiagnosed	1	50.0	1	50.0
Chronic renal failure	0	0.0	6	100.0

Diseases	Ratio			
	≥0.5		<0.5	
	No.	%	No.	%
Pneumonia	1	50.0	1	50.0
Total	21	60.0	14	40.0

$\chi^2=20.5$ , d.f=6, p=0.002, Fisher's Exact test=0.001

**Table (6): Distribution of diseases according to pleural fluid to total serum bilirubin ratio.**

Diseases	≥0.6		<0.6	
	No.	%	No.	%
Pulmonary TB	6	54.5	5	45.5
CA. lung	3	50.0	3	50.0
Heart failure	3	100.0	0	0.0
Secondary metastasis	4	80.0	1	20.0
Undiagnosed	1	50.0	1	50.0
Chronic renal failure	2	33.3	4	66.7
Pneumonia	2	100.0	0	0.0
<b>Total</b>	<b>21</b>	<b>60.0</b>	<b>14</b>	<b>40.0</b>

$\chi^2=6.4$ , d.f=6, p=0.37, Fisher's exact test=0.45.

Table (1) shows the patients' distribution number according to age which shows that the most common group ranged from (60 - 69) were 10 (28.57%), the second group ranged from (20 - 29) were 6 (17.14%) while those group range between (40 - 49) were 5 (14.28%) equal to those group ranged between (70 - 79) were 5 (14.28%) and the least number those group (10-19) were 2 (5.71%). To determine whether these cases in my research have exudates pleural effusion or transudate is 0.6 fluid to serum bilirubin ratio as show in table (3). There are 23 (65.71%) patients with exudative type their f/s ratio of Bilirubin is equal to or more than 0.6 while those with transudative type are 12 (34.28%) patients their f/s ratio less than 0.6 Table (4) show the cut off point for f/s protein ratio is 0.5. The number of patients whom their f/s equal/or more than 0.5 are exudative pleural effusion Their number are 22 (62.28%) while those with transudative type have f/s ratio less than 0.5 their number are 13 (37.71%).

Table (5) shows the distribution of diseases according to ratio of protein in Pleural fluid to total serum protein, Those patient with pulmonary TB occupied We larger number there are nine patients (81.8%) with a ratio more than or equal 0.5 and two patients (18.2%) with

a ratio less than 0.5. In bronchogenic Carcinoma only one case misdiagnosed with transudate pleural effusion. p.value = 0.002. Fisher's Exact test = 0.001 Table (6) show the distribution of diseases according to level of bilirubin In pleural fluid to total serum bilirubin only six patients of pulmonary tuberculosis catch that have exudative pleural effusion and five of them diagnosed wrongly had transudate pleural effusion when depend on Pf/s bilirubin ratio.also for bronchogenic carcinoma I catch three patients with exudative pleural effusion While other diagnosed wrongly with transudate pleural effusion. p.value = 0.37, fisher's exact test = 0.45 If the p-value or F. E. T less than 0.05 were consider as significant.

### Discussion

The use of several chemical tests to separates transudates from exudates is recommended as a useful first step in determining the cause of pleural effusion. In 1972 Light et al used pleural and serum levels of proteins and LDH to establish criteria for segregation transudates from exudates with a sensitivity and specificity both near 100 percent (19, 20, 21) this high diagnostic accuracy together with a relatively low cost made the criteria of Light et al the gold standard for initial categorization of



pleural effusions. Recently, however, several prospective studies (22, 23) were unable to reproduce the excellent results obtained by Light *et al.*, as show in this study pf/s bilirubin, Bilirubin of molecular Weight of 584 behaves similar to high molecules weight protein with respect to its concentration distribution between serum and pleural fluid (24), Such behavior may be attributed to structural and electrical properties of bilirubin, but it seems that it can not be based sound biochemical reasoning other than the plausible mechanism of protein binding.

This characteristic may explain why the bilirubin and protein ratios concentration in exudative effusion is higher than transudate which reflect serum level in circumstances that increase permeability of pleural membrane, but the biochemical analysis of bilirubin affect by light, duration between taking the sample and analysis When the duration is long or when the sample expose to light, there is more chance for wrong result so when sample of pleural fluid of patient send to be analyzed outside the hospital should protected from light and kept with preserve material (anticoagulant). Also other drawback of this method that there 's no specific method in determination of bilirubin in pleural fluid although there' s different in consistency between serum and pleural fluid. In this research the Pf/s bilirubin ratio was not sufficient alone to differentiate between exudates and transudate pleural fluid in comparison with Pf/s protein ratio (light's criteria). Some vale 200 sensitivity of the test and other give low Sensitivity of the test for e.g. the sensitivity of pulmonary tuberculosis effusion is 94% bronehonic carcinoma as 92% and for parapneumonic effusion is 58%.

Also by stastical analysis using p -value & Fisher's Exact test show no significant result according to Pf/s bilirubin ratio but it give Significant result with Pf/s protein ratio. There is similar study done in clinical biochemistry department in William Harvey hospital using multiple biochemical parameters for differentiation between exudates and transudate pleural fluid. The recommendation of this study shows that the bilirubin is not useful <sup>(8)</sup>. Other Study done in department of chest disease, Cumhuriyet university medical School, Sivas Turkey show that can use different biochemical parameter like measure Pleural fluid and serum levels of albumin, protein, LDH, cholesterol and bilirubin of 381 patient with pleural effusion<sup>(25)</sup>. Also there's thesis prepared by Dr. Hashim Mahdi for degree of fellowship of Iraqi board of medical specialist in internal medicine.

These two studies give result reverse to my study that Pf/s bilirubin play a role in distinguish between exudates and transudate and it can increase the sensitivity and Specificity of Light's criteria. Note; there is no facility in the hospital lab. for other biochemical test like LDH, cholesterol, ADA also PH of fluid and because of limited material that use for measure concentration of bilirubin in serum or in fluid, the head master of biochemical department accept one case per week of my research to measure the bilirubin in fluid that's why I deal with limited number of patient and the of my research need large group of patients to asses and reach to good result.

## Conclusions

Pleural fluid to serum bilirubin ratio can't replace Light's criteria in differentiation between exudates and transudate pleural effusion. Pf/s bilirubin ratio is a reliable test can easily perform but not common use in our hospital because of its costly and not familial use in our laboratories.

**Conflict of Interest:** None

**Source of Findings:** None

**Ethical Clearance:** None

## References

1. Richard W. Light, Kasper DL, Fauci *et al.* Disorder of the pleura in Harrison's principles of internal Medicine 2003, 1565.
2. Washington manual pulmonary medicine subspecialty consult, the 1<sup>st</sup> edition 23 160, 161.
3. Bartolome R. Celli, Slovis BS, Bigham KL *et al.* Diseases of pleura in Cecil textbook of medicine, 21 ed. vol. 1, 2000: 457- 460.
4. Heffner JE, Brown LK, Barbari CA. Diagnostic value of tests that discriminate between exudative and transudative pleural effusion chest 1997, 11 970 – 980.
5. Heffner JE Brown LK, Barbieri C Deleo JM: Pleural fluid chemical analysis in parapneumonic effusions. *Mea-analysis AM J Respir Crit Care Med* 1995 Jun; 151 (6): 1700 – 8.
6. Kumar & Clark: clinical medicine GE 2006, 14.: 86, 894.
7. Lawrence M. tierney J *et al*, Current medical diagnosis and treatment 45<sup>th</sup>, 2006, p 302.

# Serum Leptin Level and Thyroid Hormone in Type 2 Diabetes Patients

Hamza Mustaffa Khuder<sup>1</sup>, Khudair Abbas Khudair<sup>2</sup>, Ammar Lateef Hussein<sup>3</sup>

<sup>1</sup>Student, Bachelor of Medical Lab Science, Collage of Technology, Kirkuk, <sup>2</sup>Ass. Prof. Tikrit Medical College, Community Medicine, <sup>3</sup>Ass. Prof. Tikrit Medical College, Community Medicine

## Abstract

**Background:** Diabetes is a complex, chronic illness requiring continuous medical care with multi-factorial risk-reduction strategies beyond glycemic control. Ongoing diabetes self-management education and support are critical to preventing acute complications and reducing the risk of long term complications<sup>(1)</sup>. Diabetes mellitus occurs when there are raised levels of glucose in a person's blood because their body cannot produce any or enough of the hormone insulin, or cannot effectively use the insulin it produces. The causes of type 2 diabetes are not completely understood but there is a strong link with overweight and obesity, and increasing age, as well as with ethnicity and family history. **Aim:** This study intended to assess and study correlation between serum levels of leptin and thyroid hormones in diabetic and obese patients. **Subject and Method:** a case control study was conducted at the center of diabetes management and research between 1<sup>st</sup> of December 2019 to the 15<sup>th</sup> of May 2020. A fasting blood sample was taken from all participants for measurement of biochemical parameters. The information regarding the problem and demographic characteristics was obtained directly from the participants by interviewing them, using a prepared questionnaire. The weight and the height were using a medical scale machine. The body mass index was calculated according to its equation. **Results:** Results of the present study show that leptin hormone was significantly high in serum of type 2 diabetic patients group compared with overweight and obese group ( $P < 0.000$ ). A significant positive correlation with serum leptin and body mass index. Results also show that TSH hormone ( $P < 0.01$ ), and FBS were significantly high ( $P < 0.000$ ), while T3 and T4 decrease significant ( $P < 0.05$ ) in type 2 diabetic patients group and compared with control groups.

**Keywords:** Type 2 diabetes mellitus, Leptin, thyroid hormone.

## Introduction

With the increasing incidence of obesity and type 2 diabetes mellitus in the Iraq and abroad, We should focused on the molecules and pathways that regulate metabolic homeostasis with the hope of identifying a pharmacological target to limit obesity and diabetes, and/or its pathophysiological consequences. Diabetes is a major health issue that has reached alarming levels: today, nearly half a billion people are living with diabetes worldwide<sup>(1)</sup>. It is one of the major health priority of the 21st century <sup>(2)</sup>causing 1.5 million deaths in 2012<sup>(3)</sup> and 4.2 million deaths resulting from diabetes and its complications in 2019 <sup>(2)</sup>. Diabetes can be classified into the following general categories: Type 1 diabetes (due to autoimmune b-cell destruction, usually leading to absolute insulin deficiency), Type 2 diabetes (due to

a progressive loss of adequate b-cell insulin secretion frequently on the background of insulin resistance) and Gestational diabetes mellitus<sup>(4)</sup>. Type 2 diabetes is most commonly seen in older adults, but is increasingly seen in children and younger adults owing to rising levels of obesity, physical inactivity and inappropriate diet<sup>(5,6)</sup>. In another word, a consequence of social trends toward higher energy intake and reduced energy expenditure<sup>(4,7)</sup>. Obesity is a rapidly growing health problem, conferring substantial excess risk for morbidity and mortality, especially from type 2 diabetes and atherosclerotic cardiovascular disease (CVD)<sup>(8)</sup>. Studies on both humans and animal models have demonstrated close associations between obesity and a state of low-grade, chronic inflammation characterized by macrophage infiltration in adipose tissue and increased circulating

concentrations of pro-inflammatory molecules, including acute-phase proteins, cytokines, adipokines (like leptin), and chemokines<sup>(9)</sup>. Leptin is a cytokine-like (16kDa) polypeptide produced by the adipocyte that controls food intake, leading to the suppression of appetite<sup>(10)</sup>, energy expenditure, and, hence, body weight through the activation of hypothalamic receptors<sup>(11)</sup>. Women have higher leptin concentrations than men. But after menopause a significant reduction in the amount of circulating leptin occurs<sup>(12)</sup>. Such sexual differences can be explained by the difference in fat mass, body fat distribution, and sex hormones<sup>(13)</sup>. Mean concentration in women is 12.7 mg/L while it is 4.6 mg/L in men<sup>(14)</sup>. Leptin has been found increased in subjects with hyperinsulinemia and type 2 diabetes, and showed a positive association with triglycerides, systolic and diastolic blood pressure<sup>(15)</sup>. Within the endocrine system, leptin regulates the circadian rhythms of the gonadotropic, thyrotrophic and adrenal axes. It also plays key roles in the regulation of glucose homeostasis and insulin sensitivity, independent of actions on food intake, energy expenditure or body weight<sup>(16,17)</sup>. Also the hypothalamic \_thyroidal axis is regulated by leptin. This provides an important interface between adiposity, regulated by leptin and metabolic rate, regulated by thyroid hormone<sup>(18)</sup>. Thyroid hormones play a very important role in controlling the body's metabolism, the rate at which the body uses energy, by stimulating diverse metabolic activities in most tissue, leading to an increase in basal metabolic rate. One consequence of this activity is to increase body heat production<sup>(19)</sup>. So thyroid hormones with leptin might be involved in the adaptive thermogenesis<sup>(20)</sup>.

**Subjects and Method:** A case control study was conducted at the center of diabetes management and research between 1<sup>st</sup> of December 2019 to the 15<sup>th</sup> of May 2020. The study include 100 subjects, divided into three groups: group 1: included 20 (11 male and 9 female) apparently healthy individuals whose body mass index (BMI) below 25 kg/m<sup>2</sup>, age range 30-60 years, group 2: included 20 (8 male and 12 female) healthy individuals whose BMI equal or above to 25 kg/m<sup>2</sup>, age range 32-60 years, and group 3: included 60 (28 male and 32 female) newly diagnosed diabetic patients whose BMI equal or above to 25 kg/m<sup>2</sup>, age range 35-66 years. From all participants, a fasting blood sample was taken for measurement of fasting plasma glucose (FPG), glycated hemoglobin (HbA1c), lipid profile, serum leptin, thyroid hormones, thyroid stimulating hormone (TSH) and fasting insulin. Insulin resistance (IR), BMI and atherogenic index (AI) were calculated according to special equations.

**Statistical Analysis:** The data obtained in the current study was analyzed using statistical package for social science (SPSS) program version 26. Different descriptive statistical method were used to summarize and tabulate the data. ANOVA test were used to compare the mean difference of all parameters between the three groups. Duncan test were used to determine the non-homogenous group if the result of ANOVA test was significant. Furthermore independent 2 samples student t-test were used to compare the difference between each 2 groups.

## Results:

### Demographic and clinical characteristics of all participants in this study shown in table 1:

**Table (1): Demographic and clinical characteristics of the participants.**

Characteristics	Group 1 (no. = 20)	Group 2 (no. = 20)	Group 3 (no. = 60)
Age Range (Mean± SD)	30-60(44.0±8.3)	32-60(45.0±7.0)	35-66(47.5 ±7.4)
Male no. (%)	11 (55)	8 (40)	28 (46.6)
Female no. (%)	9 (45)	12 (60)	32 (53.3)
M : F ratio	1.22 : 1	1 : 1.5	1 : 1.14
Family history: Present no. (%)	11 (55)	13 (65)	33 (55)
Family history: Absent no. (%)	9 (45)	7 (35)	27 (45)
BMI Range (mean± SD)	20.1-24.8 (22.4±1.7)	25.8-48.0 (34.2±5.3)	26- 50 (32.9± 6.3)

Different biochemical parameters in the studied groups are presented as mean  $\pm$  SD in table (2):

**Table (2): Biochemical parameters in the studied groups**

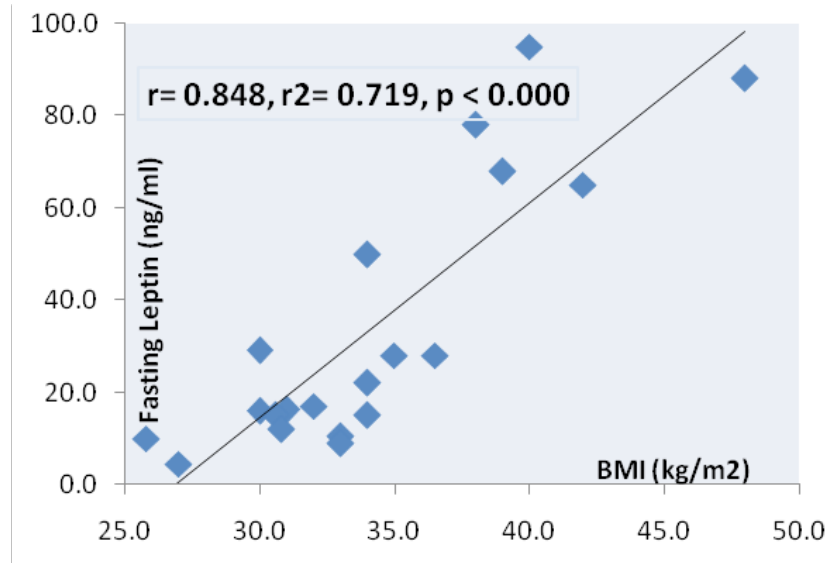
Biochemical parameters	Group 1	Group 2	Group 3	p-value
	Mean $\pm$ SD			
FBG	96.4 $\pm$ 12.0	97.2 $\pm$ 14.5	209 $\pm$ 53.1 <sup>bc</sup>	< 0.0001
HbA1c	4.9 $\pm$ 0.3	5.3 $\pm$ 0.4	8.97 $\pm$ 1.76 <sup>bc</sup>	< 0.0001
Fasting S. Insulin	6.5 $\pm$ 2.3	13.2 $\pm$ 9.0	14.2 $\pm$ 9.2	0.001
HOMA-IR	1.51 $\pm$ 0.51	3.23 $\pm$ 2.55 <sup>a</sup>	7.11 $\pm$ 4.14 <sup>bc</sup>	< 0.0001
Fasting S. Leptin	2.9 $\pm$ 1.2	33.8 $\pm$ 29.0 <sup>a</sup>	20.6 $\pm$ 12.5 <sup>b</sup>	< 0.0001
T-cholesterol	164.0 $\pm$ 25.7	179.7 $\pm$ 44.7	187.1 $\pm$ 42.6 <sup>b</sup>	0.05
HDL- cholesterol	49.8 $\pm$ 9.0	41.2 $\pm$ 10.9 <sup>a</sup>	35.7 $\pm$ 8.9 <sup>bc</sup>	< 0.0001
LDL- cholesterol	93.6 $\pm$ 24.5	106.4 $\pm$ 36.6	117.1 $\pm$ 37.0 <sup>b</sup>	< 0.05
Triglyceride	103.4 $\pm$ 52.5	148.1 $\pm$ 66.4 <sup>a</sup>	171.1 $\pm$ 59.6 <sup>b</sup>	< 0.0001
A.I.	3.4 $\pm$ 1.0	4.2 $\pm$ 1.2	5.6 $\pm$ 2.3 <sup>b</sup>	< 0.0001
TSH	2.31 $\pm$ 0.99	4.51 $\pm$ 2.55	7.1 $\pm$ 5.0 <sup>bc</sup>	0.01
f T4	1.09 $\pm$ 0.28	1.2 $\pm$ 0.35	1.54 $\pm$ 0.71 <sup>b</sup>	0.05
f T3	1.31 $\pm$ 0.59	1.67 $\pm$ 0.73	2.09 $\pm$ 0.82 <sup>b</sup>	0.04

<sup>a</sup> = significant difference between group 2 and group 1; <sup>b</sup> = significant difference between group 3 and group 1; <sup>c</sup> = significant difference between group 3 and group 2

There is a significant positive correlation between serum leptin and BMI was found indicating that the increase in the BMI is associated with increase in serum leptin level in group 2 . table (3), fig.(1).

**Table (3): Correlation between s. leptin level, glycemic control, thyroid hormone and other metabolic parameters in group 2.**

Characteristics	Serum Leptin		
	r	r <sup>2</sup>	p
Age	0.360	0.129	0.119
BMI	0.848*	0.719	0.000
FPG	0.189	0.036	0.424
HbA1c	- 0.399	0.159	0.081
Fasting S. Insulin	- 0.059	0.003	0.805
HOMA-IR	- 0.052	0.003	0.827
TC	0.122	0.015	0.609
HDL	- 0.038	0.001	0.873
LDL	0.141	0.020	0.552
TG	0.141	0.020	0.552
AI	0.161	0.026	0.498
TSH	0.385	0.148	0.094
f T4	- 0.528**	0.279	0.017
f T3	- 0.489**	0.239	0.01



\*Correlation is significant at the 0.01 level (2-tailed), \*\* Correlation is significant at the 0.05 level (2-tailed)

**Figure(1): Correlation between serum leptin level BMI in group 2.**

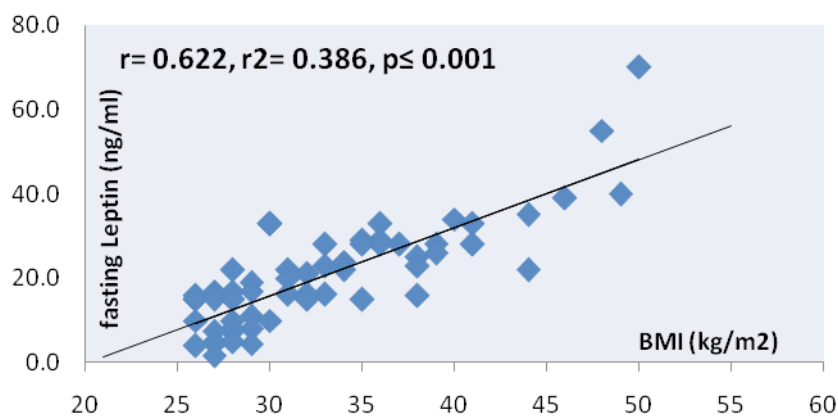
There is a significant positive correlation between serum leptin and BMI was found indicating that the increase in the BMI is associated with increase in serum leptin level and there was a significant negative

correlation between serum leptin level and glycemic control (FBG and HbA1c) which indicating that an increase in FBG and HbA1c is associated with decrease in serum leptin level table (4), fig.(2).

**Table (4): Correlation between serum leptin level, glycemic control, thyroid hormone and other metabolic parameters in group 3.**

Characteristics	Serum Leptin		
	R	r <sup>2</sup>	p
Age	0.002	0.000	0.990
BMI	0.687*	0.471	0.001
FPG	- 0.241	0.058	0.044
HbA1c	- 0.245	0.060	0.039
Fasting S. Insulin	0.839 *	0.705	0.000
HOMA-IR	0.709 *	0.503	0.000
TC	0.053	0.003	0.687
HDL	- 0.061	0.004	0.644
LDL	0.088	0.008	0.504
TG	- 0.038	0.001	0.774
AI	0.071	0.005	0.592
TSH	0.089	0.008	0.499
f T4	- 0.051	0.003	0.697
f T3	- 0.049	0.002	0.512

\*Correlation is significant at the 0.01 level (2-tailed)



**Figure (2): Correlation between serum leptin level BMI in group 3.**

## Discussion

The present study provides a wide view on biochemical features in blood of type 2 diabetic patients and non diabetic obese. Serum leptin determination and its correlation with other biochemical parameters were targeted in those groups. The mean age of type 2 diabetic patients who were participated in our study was ( $47.5 \pm 7.4$ ) years coincides with the fact that type 2 diabetes mellitus usually develops after age 40 years<sup>(21)</sup>.

In our study it was found that mean serum leptin level was higher in obese ( $33.8 \pm 29.0$ ) and diabetic groups ( $20.6 \pm 12.5$ ) than non-obese group ( $2.9 \pm 1.2$ ) and correlates positively and strongly with BMI ( $p < 0.001$ ) in the three groups which is an important index of obesity. This finding was agreed with a study conducted in Baghdad, Iraq 2009, which compared a two groups, obese and non obese participants, and showed a positive correlation between leptin and BMI ( $P < 0.01$ )<sup>(22)</sup>. However, lower levels of leptin were observed in diabetes in study done to investigate the hormone resistance in diabetes and obesity<sup>(23)</sup>. This implies that the role of leptin in type 2 diabetes is controversial and still needs further investigation.

The mean HbA1c of 8.97 % observed in T2DM patients and there was a significant difference in HbA1c levels between the non diabetic groups and the diabetic group both had ( $p$  value  $< 0.000$ ). However we could not find, a significant difference in HbA1c levels between non diabetic groups, the obese and non obese patients, although it was obviously lower in the non obese patients implying a better glycemic status in such patients. This results similar to the result of case control study conducted in Iraq 2008<sup>(24)</sup>.

A highly significant difference in insulin resistance (HOMA) was observed in diabetic group as compared to non obese group, which was expected because of the increased level of fasting plasma glucose and high level of serum insulin in diabetic patients, and there was a highly significant difference in insulin resistance (HOMA) was observed in obese group as compared to non obese group which was expected due to high level of serum insulin in obese group which indicate the presence of insulin resistance in this group. The result show a significant difference in insulin resistance ( $p$ -value  $< 0.05$ ) between diabetic and obese group.

The results of serum lipid profile in our study show that, cholesterol, triglycerides and LDL-C levels were significantly increased in diabetic patients and obese controls when compared to non obese controls whereas HDL-C level was significantly decreased in diabetics. Our study revealed no significant correlation between leptin and Total cholesterol, HDL-c, LDL-c, triglycerides and atherogenic index in all studied groups. These findings are in agreement with Assal et al.<sup>(25)</sup> and Al-Shoumer et al.<sup>(26)</sup>, who showed no significant correlation between leptin and the lipid profile in diabetic patients, obese non diabetic and non obese non diabetic groups.

Obesity as a cause of insulin resistance may play a role in thyroid dysfunction. There is evidence that low free T4 is associated with insulin resistance<sup>(27)</sup>. Solanki et al.<sup>(28)</sup> reported significant correlation between BMI and TSH in healthy adults and BMI was negatively associated with serum fT4 but had no association with serum fT3. There is a positive association between TSH and obesity (BMI) which is similar to the result shown in Chinese study<sup>(29)</sup> where they explain these result as

an alterations in thyroid hormones activity or as a result of an alteration in the regulation of the hypothalamic-pituitary-thyroid axis, and our results agreed with a study conducted in Saudi 2017<sup>(30)</sup>. In this study, the comparison of thyroid function between diabetic and the non obese group show a highly significant differences in TSH and fT4 (p value < 0.01) and a (p value < 0.05) for fT3. There is also a highly significant differences in TSH between obese and diabetic groups. These result agreed with a case control study conducted in the Diabetes and Endocrine Center at Al-Husain Teaching Hospital, AL-Muthanna, Iraq 2015<sup>(31)</sup>. Our results show a positive correlation between the level of leptin and TSH in both diabetic and obese group while showing a negative correlation in non obese group and it is reverse for both fT3 and fT4.

We conclude that there was increase in the BMI is associated with increase in serum leptin level. Patients with type 2 diabetes had significantly lower serum leptin compared with healthy subjects of the same BMI. Healthy subjects complaining from obesity are at a high risk of developing diabetes in the future concluded from the facts that their HbA1c and IR was significantly higher compared with thin healthy control and highly significant difference in fasting serum insulin level. TSH show high level and a low levels of thyroid hormones in diabetic and obese participant compare with that of non obese group, i.e. TSH levels correlate with insulin resistance in obese patients.

**Author's Contributions:** Both authors played a key role in carrying out the study to conductive outcome. All authors were involved in the study design,data analysis,data collection,implementation of research and in the critical revision the final approval of manuscript.

**Conflict of Interest:** the authors declare that there are no conflict of interest.

**Source of Findings:** Self

**Ethical Clearance:** nil

### References

1. Guariguata L, Whiting D, Weil C, Unwin N. The International Diabetes Federation Diabetes Atlas methodology for estimating global and national prevalence of diabetes in adults. *Diabetes Res Clin Pract.* 2011 Dec;94(3):322–32.
2. International Diabetes Federation. *IDF Diabetes Atlas*, 9<sup>th</sup> edition. Brussels; 2019.
3. World Health Organization (WHO). *Global Report on Diabetes*. World Health Organization, Geneva (Switzerland). 2016.
4. American Diabetes Association. 2. Classification and diagnosis of diabetes: Standards of Medical Care in Diabetes-2020. *Diabetes Care.* 2020;43(Suppl. 1):S14–S31
5. Gregg EW, Li Y, Wang J, Burrows NR, Ali MK, Rolka D, et al. Changes in diabetes-related complications in the United States, 1990-2010. *N Engl J Med.* 2014 Apr 17;370(16):1514– 23.
6. International Diabetes Federation. *IDF Clinical practice recommendations for managing Type 2 diabetes in primary care*. Brussels; 2019.
7. Zimmet P, Alberti KG, Shaw J. Global and societal implications of the diabetes epidemic. *Nature.* 2001;414:782-7.
8. Meigs JB, Wilson PW, Fox CS, Vasan RS, Nathan DM, Sullivan LM, et al. Body Mass Index, Metabolic Syndrome, and Risk of Type 2 Diabetes or Cardiovascular Disease. *J Clin Endocrinol Metab.* 2006; 91: 2906–2912.
9. Tataranni PA, Ortega E. A burning question: does an adipokine induced activation of the immune system mediate the effect of over nutrition on type 2 diabetes? *Diabetes.* 2005;54:917–27.
10. Mechanick JI, Zhao S, Garvey WT. Leptin, An Adipokine With Central Importance in the Global Obesity Problem. *Glob Heart.* 2017 Dec 13.
11. Brennan AM, Mantzoros CS. Drug Insight: The Role of Leptin in Human Physiology and Pathophysiology-Emerging Clinical Applications. *Nat Clin Pract Endocrinol Metab.* 2006; 2: 318-27.
12. Muller TD, Focker M, Holtkamp K, Herpertz-Dahlmann B, Hebebrand J. Leptin-mediated neuroendocrine alterations in anorexia nervosa: somatic and behavioral implications. *Child and adolescent psychiatric clinics of North America.* 2009;18(1):117–29.
13. Oleshchuk O, Loi H. Leptin resistance and type 2 diabetes. *International Journal of Medicine and Medical Research.* 2017; 3(1),15–21.
14. Efstratiadis, G.; Nikolaidou, C. and Vergoulas, G. Leptin as cardiovascular risk factor. *Hippokratia.* 2007;11: 163-170.
15. Uslu, S.; Kebapci, N.; Kara, M.; Bal, C. Relationship

- between adipocytokines and cardiovascular risk factors in patients with type 2 diabetes mellitus. *Exp Ther Med.* 2012; 4:113–120.
16. Brennan AM, Mantzoros CS. Drug Insight: The Role of Leptin in Human Physiology and Pathophysiology-Emerging Clinical Applications. *Nat Clin Pract Endocrinol Metab.* 2006; 2: 318-27.
  17. Berglund ED, Vianna CR, Donato J Jr, Kim MH, Chuang JC, Lee CE, et al. Direct leptin action on POMC neurons regulates glucose homeostasis and hepatic insulin sensitivity in mice. *J Clin Invest.* 2012;122:1000-9.
  18. Kim, M.S.; Small, G.J.; Stanley, S.A.; Morgan, D.G.; Seal, L.J.; Kong, W.M. et al. The central melanocortin system affects the hypothalamo-pituitary thyroid axis and may mediate the effect of Leptin. *J Clin Invest.* 2000;105: 1005-1011.
  19. Choksi, N.Y.; Jahnka, G.D.; Hilaire, C.S. and Shelby, M. 2003. Role of Thyroid Hormones in human and Laboratory Animal Reproductive Health. *Dev. Reprod. Toxicol. B.D.R. Stipanuk, M.H.* 2000. *Biochemical and Physiological Aspects of human nutrition.* Saunders, Philadelphia.pp:763-775.68: 479-491.
  20. Zimmermann- Belsing T, Brabant G, Holst JJ, Rasmussen U. Circulating Leptin and thyroid dysfunction. *Eur J Endocrinol.*2003; 149:257-27.
  21. Olokoba AB, Obateru OA, Olokoba LB. Type 2 diabetes mellitus: a review of current trends. *Oman Med J.* 2012; 27 (4): 269-273.
  22. Turki KM, Alosami MH, Abdul-Qahar ZH. The effect of obesity on serum leptin and lipid profile. *The iraqi postgraduate medical journal* vol.1, no. 1, 2009
  23. Flier JS. Hormone resistance in diabetes and obesity: insulin, leptin, and FGF21. *Yale J Biol Med.* 2012; 85 (3): 405-414.
  24. Al –shamma ZA, Al-yassin HD, Hashim HM. Resistin, Insulin resistance and BMI in type 2 diabetes mellitus and healthy subjects. *J Fac Med Baghdad* Vol. 50, No. 3, 2008.
  25. Assal HS, Fath-Alla M, Elsherbny A. Serum leptin and adiponectin in obese diabetic and non diabetic. *J. Med.Sci.*2007.7(5):865-869.
  26. Al-Shoumer KA, Al-Asousi AA, Doi SA, Vasanthy BA. Serum leptin and its relationship with metabolic variables in Arabs with type 2 diabetes mellitus. *Ann. Saudi Med.*2008; 28:367-70.
  27. Deetman PE, Bakker SJ, Kwakernaak AJ, Navis G, Dullaart RP. The relationship of the anti-oxidant bilirubin with free thyroxine is modified by insulin resistance in euthyroid subjects. *PLoS One.* 2014;9(3):e90886.
  28. Solanki A, Bansal S, Jindal S, Saxena V, Shukla US. Relationship of serum thyroid stimulating hormone with body mass index in healthy adults. *Indian J Endocrinol Metab.* 2013;17(Suppl 1):S167-169.
  29. Lin SY, Wang YY, Liu PH, Lai WA, Sheu WH. Lower serum free thyroxine levels are associated with metabolic syndrome in a Chinese population. *Metabolism* 2005; 54:1524-28.
  30. Al-Musa HM. Impact of Obesity on Serum Levels of Thyroid Hormones among Euthyroid Saudi Adults. *Hindawi Journal of thyroid Research* Volume 2017, Article ID 5739806, 5 pages
  31. Alzubaidy GH, Mousa TA. Relationship Between Leptin and Thyroid Hormones In Type 2 Diabetes Mellitus Patients. *Journal of Babylon University, Pure and Applied Sciences.* 2015; 2(23).



# Comparison between Using Bupivacaine 0.5% and Bupivacaine with Sodium Bicarbonate 8.4 % in Thoracic Epidural Anesthesia for Laparoscopic Cholecystectomy

Ayman G. Saeed<sup>1</sup>, Khaled Ali Khaleel<sup>2</sup>, Mohammed Asi Jabbar<sup>3</sup>

<sup>1</sup>Senior Anesthesiologist, M.B.CH. B, FICMS, Salah Adine Teaching Hospital, Department of Anesthesia, Intensive Care and Pain Management, <sup>2</sup>Senior Anesthesiologist, M.B.CH. B, DA, FICMS, Al-Kindy Teaching Hospital, Department of Anesthesia, Intensive Care and Pain Management, <sup>3</sup>D.A./C.A.B.A.L Subspeciality Supervisor of Fellowship of Regional Anesthesia, Department of Anesthesia, Al-Shaheed Ghazi Al-Harriri Hospital, Baghdad, Iraq

## Abstract

**Background:** Thoracic epidural anesthesia for LC is a satisfactory alternative technique in selected cases, therefore aim of current study was compare the deference between using of bupivacaine 0.5% at one and bupivacaine 0.5%. With sodium Bicarbonate 8.4 %. The differences we deal with there are onset of action. Duration of action, Potency, and the occurrence of complications. We report the sex, Age and smoking to see we these factors can affecting the study ornot.

**Patients and Method:** The sample contain 2 groups of patient each group involved 20 patent with deferent age and sex. Group A receive Bupivacaine 0.5% 12ml alone for thoracic epidural anesthesia at level of T6 for laparoscopic. Cholecystectomy while ingroup B, we give Bupivacaine 0.5% 12ml with sodium bicarbonate 8.4 % 5ml (420mg) for the same operation at the same level of injection. In both groups we put the epidural catheter for addition of more dose of Bupivacaine and the mixture if the action of drug is finish and for the postoperative pain management after the operation.

**Keywords:** *Bupivacaine; sodium bicarbonate; thoracic epidural anesthesia; laparoscopic cholecystectomy.*

## Introduction

Traditionally laparoscopic choli cystectomy is done under general anesthesia, but recently there is a growing interest to get it conducted under central neuraxial blockade<sup>(1,2)</sup>. We conducted a clinical study comprising bupivacaine 0.5% alone or a combination of bupivacaine and sodium bicarbonate (420 mg/5ml of 8.4% sol) in thoracic epidural anesthesia for laparoscopic

cholecystectomy (LC) the aim is to see whether there is deference in onset of actin, Potency, Duration of action and occurrence of any complication during procedure.

Epidural anesthesia was considered safe for laparoscopic cholecystectomy without associated respiratory depression as the respiratory control mechanism remains intact to allow the patients to adjust their minute ventilation. Moreover, the respiratory changes are less evident in awaken patients under regional anesthesia and patients maintain an unchanged end tidal carbon dioxide<sup>(3)</sup>.

The benefit of TEA not only for patient with respiratory diseases but also for management of postoperative pain where we can connect the epidural catheter with patient control analgesia (PCA)<sup>(4)</sup>.

---

## Corresponding Author:

**Ayman G. Saeed**

Senior Anesthesiologist, M.B.CH. B, FICMS, Salah Adine Teaching Hospital, Department of Anesthesia, Intensive Care and Pain Management  
e-mail: dr.aymanghani@gmail.com

## Patients and Method

The epidural anesthesia can be done by two methods as traditional or classic method and by Ultrasonography.

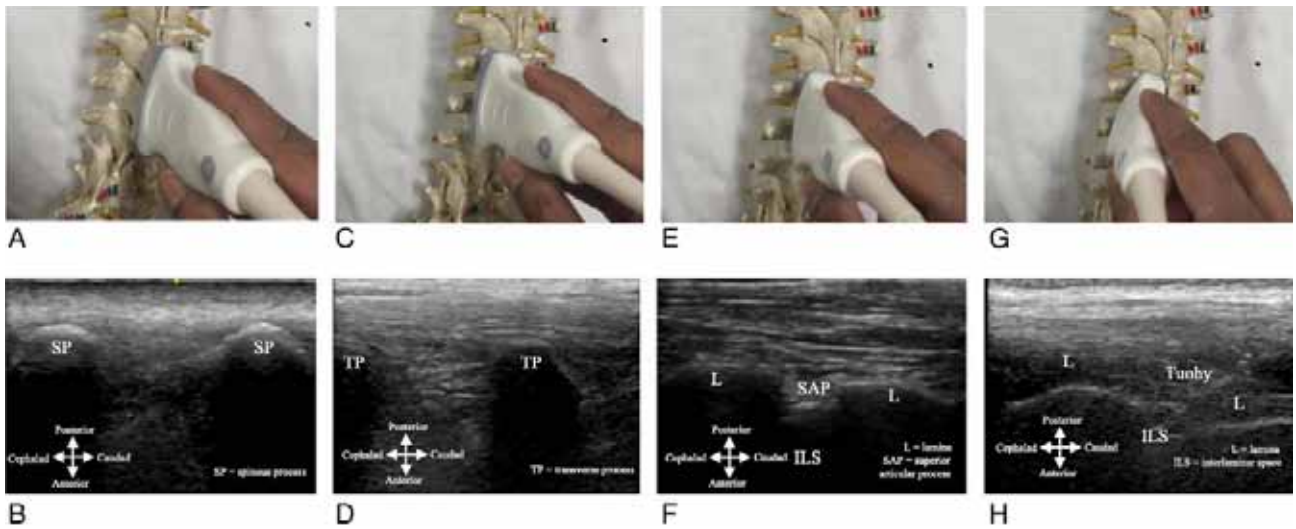
### A. Traditional method

**Preparations:** An epidural must be performed in a work area that is equipped for airway management and resuscitation. Facilities for monitoring blood pressure and heart rate must be available. It is advisable to obtain informed consent prior to performing an epidural in the same way as before any other invasive procedure. Laboratory assessments are necessary like fasting blood sugar, blood urea and creatinine, coagulopathy (PT, PTT, BT, INR), also history of anticoagulant therapy. ECG and chest x-ray should be done as routine tests. I.v. line should be inserted before procedure with loading of circulation with 500ml crystalloid fluid.

**Procedure:** Patient put in sitting or lateral position. Good sterilization of the site of injection; we anesthetized the site of injection by 3ml bupivacaine or xylocaine with syringe 18g needle. After 2min., we introduce the tuohy needle gently till we reach the ligamentum flavum where we feel a resistance. At this point, we should apply the loss of resistance technique either by air or by saline in syringe. Once the loss of resistance is felt, the advance of tuohy needle should be stopped. Then the epidural catheter can be inserted in appropriate distance while the tuohy needle removed gently. Then the catheter fixed properly. After that the anesthesia can be begun by pushing of anesthetic agent. We start with testing dose (3ml) and waiting for 3min. and monitor the patient for any signs or symptoms of allergy from the anesthetic agent can be given.

**Epidural anesthesia by ultrasound guide:** All the preparations and laboratory tests are the same including the positioning and sterilization of the patient. Here, the insertion of the tuohy needle will be done under the direct vision of the ultrasonography which makes the procedure easier, safe and less time consuming. Ultrasound imaging was completed using a GE LOGIQe 9L linear probe, 8

to 10 MHz. After the determining of the thoracic level using the technique of locating the 12th rib and tracking cephalad, the probe was placed in the longitudinal plane on the midline of the patient's back to visualize the thoracic spinous processes. As is our standard of care, the T8-T9 interspace was most commonly chosen for placement of the thoracic epidural. Although discretion was allowed for variations in surgical incision site and technique. Once the appropriate interspace was localized, a para-median sagittal transverse process view was obtained by moving the probe 2cm lateral to visualize the corresponding transverse processes. Which appear as successive hyperechoic domes. Maintaining the Para-median sagittal orientation, the probe was moved 1cm medial for the articular process view. Where the superior articular process of the inferior vertebrae could be seen. The paramedian sagittal oblique view was obtained by turning the cephalad and of the probe medially with a concurrent medial tilt until the superior or articular process of the targeted interlaminar space could no longer be visualized. Further tilting motions of the probe were made to optimize the gap between the laminae which represent to note that with our probe and technique the epidural space was not visualized. This is a critical point especially at a depth greater than 4 cm. Once the targeted interlaminar space was identified the intended needle entry site at the skin was infiltrated with 2% lidocaine. A 17 gauge tuohy needle was inserted from the caudal end of the probe and advanced under real time ultrasound assistance using an in-plane approach to the interlaminar space until the tip of the tuohy needle was safely directed to the distance of the previously visualized superior articular process of the inferior lamina. No attempt was made to deliberately contact the lamina with the needle. Once the tuohy was visually localized in the previously mentioned position. The needle was advanced until the epidural space was identified with LOR to air because the needle tip could not be visualized at all times under ultrasound at these depths. The epidural catheter was advanced such that 4cm remained in the epidural space.



**Figure 1:** For the spinous process view of the thoracic spine, the US probe should be orientated longitudinally along the midline of the thoracic spine (A) so that successive spinous processes can be seen on US (B). For the paramedian sagittal transverse process view, the US probe is moved 2 to 3 cm lateral from the spinous process (C). Successive hyperechoic domes with fingerlike shadowing or “trident sign” represent the transverse processes (D). For the paramedian sagittal articular process view, the probe is moved 1 cm medially (E). The superior articular process of the inferior vertebra can be seen along with the corresponding laminae (F). The paramedian sagittal oblique view can be obtained by turning the cephalad end of the probe medially with a slight medial tilt (G) to optimize the view of the interlaminar space seen in (H), where the Tuohy needle is advanced under direct visualization

**Results**

**Table 1: Statistical measures for both groups of patients.**

Groups	Measurements	Potency	Onset	Duration
A (Marcaine 0.5% alone)	P value	0.0359	-	-
	STD	0.0743	00:03:30	00:29:46
	Mean	0.3133	00:18:00	03:08:28
B (Marcaine 0.5% with Sodium bicarbonate 8.4%)	P value	0.0359	-	-
	STD	0.0743	00:03:55	00:45:49
	Mean	0.2467	00:17:51	02:47:36

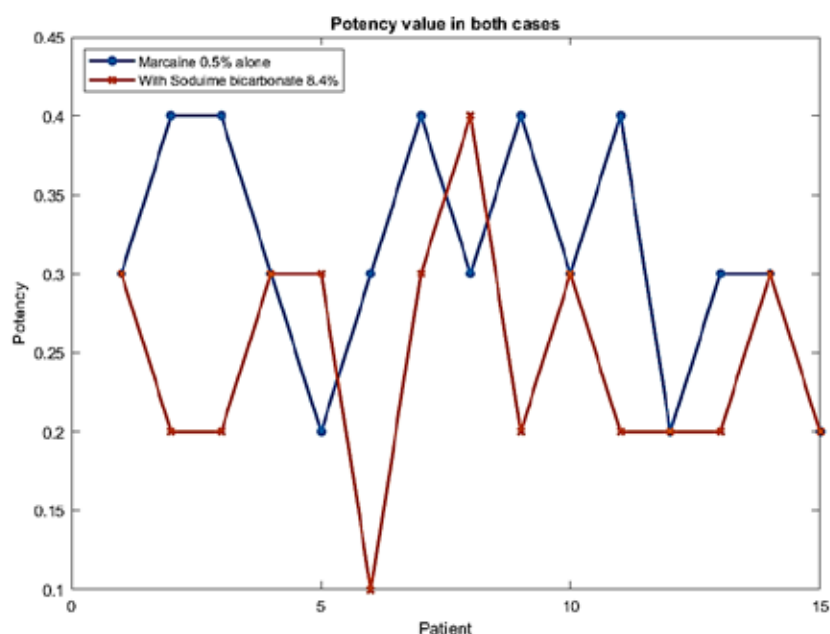
**Table 2: Group (A) data of patients that were studied with Marcaine 0.5% alone.**

Case	Time	Effect Time	Potency	End time	Duration	Complications	Sex	Age	Smoking
1	11:03:00 AM	11:18:00 AM	0.30	2:49:00 PM	3:31:00 AM	N	F	32	N
2	10:10:00 AM	10:31:00 AM	0.40	1:52:00 PM	3:21:00 AM	N	F	62	N
3	10:42:00 AM	11:02:00 AM	0.40	2:33:00 PM	3:31:00 AM	N	M	50	Y
4	9:56:00 AM	10:15:00 AM	0.30	1:13:00 PM	2:58:00 AM	N	F	66	N
5	8:30:00 AM	8:41:00 AM	0.20	12:13:00 PM	3:32:00 AM	N	F	61	N
6	11:10:00 AM	11:30:00 AM	0.30	2:36:00 PM	3:06:00 AM	N	M	41	Y
7	10:36:00 AM	10:55:00 AM	0.40	1:32:00 PM	2:37:00 AM	N	M	48	N
8	9:32:00 AM	9:46:00 AM	0.30	12:13:00 PM	2:27:00 AM	N	F	38	N

Case	Time	Effect Time	Potency	End time	Duration	Complications	Sex	Age	Smoking
9	1:30:00 PM	1:44:00 PM	0.40	4:03:00 PM	2:19:00 AM	N	F	68	Y
10	10:13:00 AM	10:31:00 AM	0.30	1:09:00 PM	2:38:00 AM	N	F	62	N
11	9:33:00 AM	9:56:00 AM	0.40	12:32:00 PM	2:36:00 AM	N	F	49	N
12	11:11:00 AM	11:25:00 AM	0.20	3:02:00 PM	3:37:00 AM	N	M	70	Y
13	12:10:00 PM	12:31:00 PM	0.30	4:10:00 PM	3:39:00 AM	N	M	52	Y
14	10:02:00 AM	10:22:00 AM	0.30	1:58:00 PM	3:36:00 AM	N	M	64	Y
15	12:10:00 PM	12:31:00 PM	0.20	4:10:00 PM	3:39:00 AM	N	F	68	N

**Table 3: Group (B) data of patients that were studied with Marcaine 0.5% and Sodium bicarbonate 8.4%.**

Case	Time	Effect Time	Potency	End time	Duration	Complications	Sex	Age	Smoking
1	11:12:00 AM	11:22:00 AM	0.30	2:10:00 PM	2:48:00 AM	N	F	66	N
2	10:13:00 AM	10:26:00 AM	0.20	1:55:00 PM	3:29:00 AM	N	F	55	N
3	11:02:00 AM	11:25:00 AM	0.20	1:50:00 PM	2:25:00 AM	N	M	61	Y
4	9:10:00 AM	9:23:00 AM	0.30	12:40:00 PM	3:17:00 AM	N	M	72	Y
5	9:35:00 AM	9:56:00 AM	0.30	12:31:00 PM	2:35:00 AM	N	M	62	N
6	10:05:00 AM	10:25:00 AM	0.10	12:50:00 PM	2:25:00 AM	N	F	66	N
7	11:11:00 AM	11:31:00 AM	0.30	2:01:00 PM	2:30:00 AM	N	F	32	N
8	9:45:00 AM	10:03:00 AM	0.40	12:12:00 PM	2:09:00 AM	N	M	39	Y
9	10:20:00 AM	10:33:00 AM	0.20	1:22:00 PM	2:49:00 AM	N	F	46	Y
10	9:09:00 AM	9:31:00 AM	0.30	1:02:00 PM	3:31:00 AM	N	F	58	N
11	11:32:00 AM	11:48:00 AM	0.20	1:55:00 PM	2:07:00 AM	N	M	40	Y
12	10:31:00 AM	10:50:00 AM	0.20	2:10:00 PM	3:20:00 AM	N	M	49	Y
13	9:09:00 AM	9:29:00 AM	0.20	2:11:00 PM	4:42:00 AM	N	F	48	N
14	11:32:00 AM	11:51:00 AM	0.30	1:32:00 PM	1:41:00 AM	N	F	65	N
15	10:31:00 AM	10:52:00 AM	0.20	12:58:00 PM	2:06:00 AM	N	M	62	Y



**Fig 1: The amount of Potency that was used in both groups**

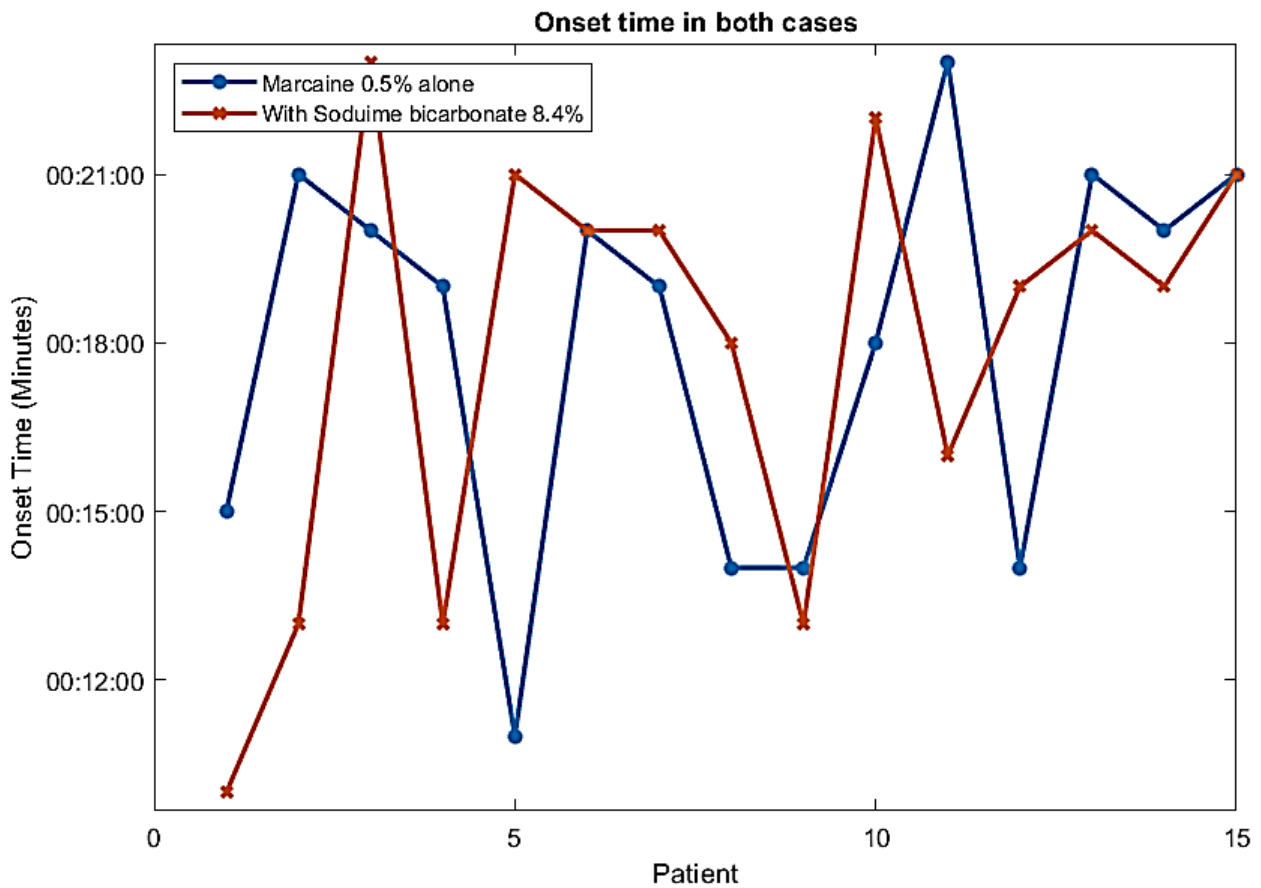


Fig 2: The Onset time in both groups

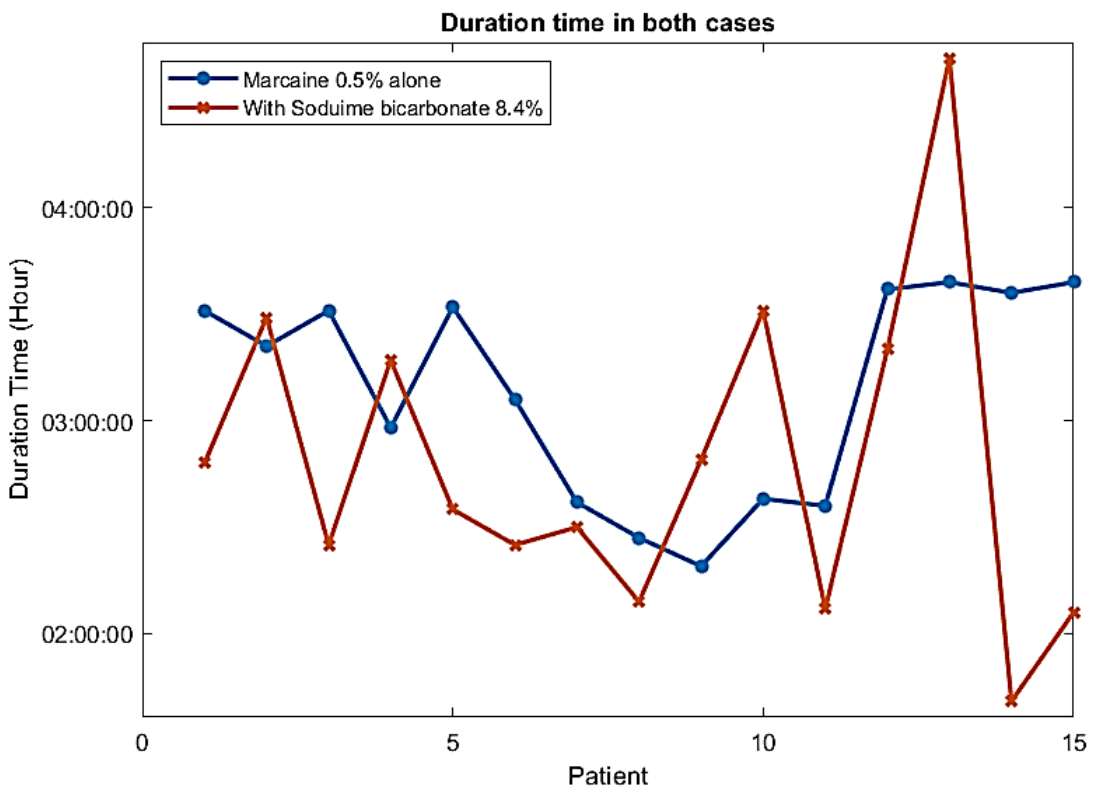
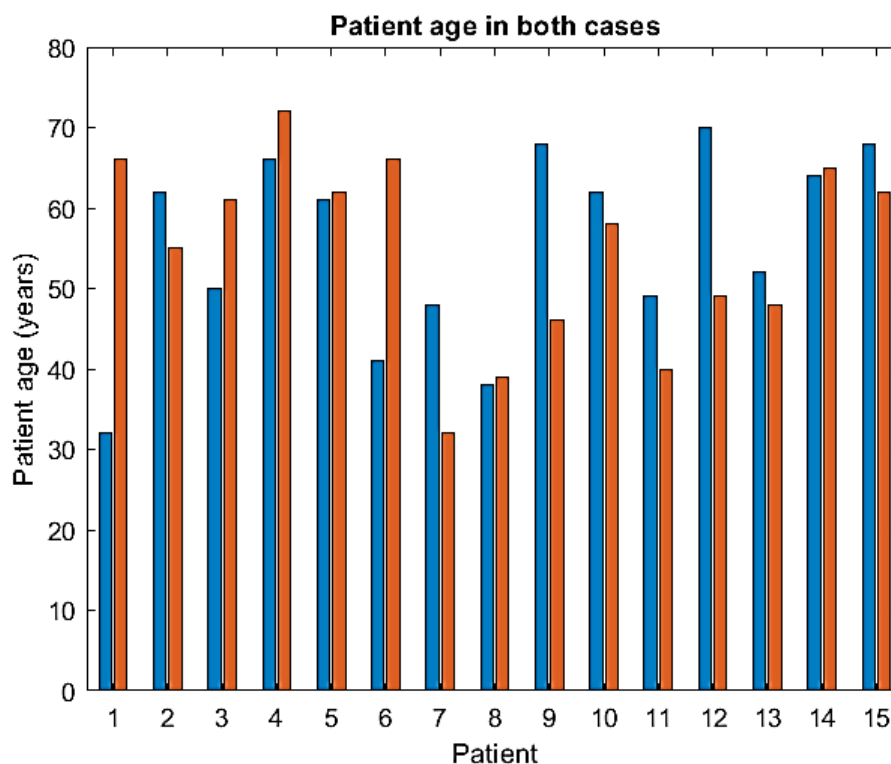


Fig 3: The Duration time in both groups



**Fig 4: The Patient Age in both groups**

## Discussion

In this study, we take two groups of patients with different ages and sex contain 20 patients for each group. We did thoracic epidural anesthesia with ultrasound guide at T6 level for Laparoscopic cholecystectomy in group A we used Marcaine 0.5 % 12 ml only while in group B we used Marcaine 0.5 % 12 ml plus sodium bicarbonate 8.4 % 5 ml. we compare 2 groups for the onset of anesthesia, Duration of action, Potency of anesthesia and occurrence of complications. In fact, For all patient we used thoracic epidural anesthesia at T6 level as anesthesia during operation and analgesia for postoperative pain. We didn't add general anesthesia for any patient but we used the adjuvant drugs for decrease the anxiety of patients like fentanyl 1 50 mg plus midazolam 3 mg i.v. All the operations are lasting 40 min to 1.10 hr. for the surgical procedure. Ghodki *et al.* gave intrathecal clonidine besides bupivacaine in spinal anesthesia for LC which provided prolonged postoperative analgesia and sedation besides relief of shoulder pain<sup>(5)</sup> whilst Rademaker *et al.* used continuous thoracic epidural for LC and found that metabolic endocrine response was attenuated and postoperative pain was also less<sup>(6)</sup>.

## Conclusion

During this study, we find that there was no difference in onset of anesthesia potency of anesthesia and duration of action of agent between group A and B. in fact there was a very little shortness in onset of anesthesia which is not significant. In addition to that, no complications are reported during this study in both groups.

**Conflict of Interest:** None

**Source of Findings:** None

**Ethical Clearance:** from hospitals and patients

## References

1. Malti Agrawal, A. P. Verma, and L. S. Kang., Thoracic epidural anesthesia for laparoscopic cholecystectomy using either bupivacaine or a mixture of bupivacaine and clonidine: A comparative clinical study, *Anesth Essays Res.* 2013 Jan-Apr; 7(1): 44–48.
2. Etta OE, Edubio MN. Awake thoracic epidural anaesthesia for laparotomy: a safer alternative to

- general anaesthesia in asthmatic patients. *IBOM Med J.* 2014;7:6–10.
3. Raju NP, Sivasashanmugam T, Ravishankar M. Respiratory changes during spinal anesthesia for gynecological laparoscopic surgery. *J Anaesth Clin Pharmacol.* 2010;26:475–9.
  4. Blomberg S, Emanuelsson H, Kvist H, Lamm C, Ponten J, Waagstein F, Ricksten S-E: Effects of thoracic epidural anesthesia on coronary arteries and arterioles in patients with coronary artery disease. *ANESTHESIOLOGY* 73:840-847, 1990.
  5. Ghodki PS, Sardesai SP, Thombre SK. Evaluation of the effect of intrathecal clonidine to decrease shoulder tip pain in laparoscopy under spinal anaesthesia. *Indian J Anaesth.* 2010;54:231-4. [PMC free article] [PubMed] [Google Scholar]
  6. Rademaker BM, Ringers J, Odoom JA, de Wit LT, Kalkman CJ, Oosting J. Pulmonary function and stress response after laparoscopic cholecystectomy: Comparison with subcostal incision and influence of thoracic epidural analgesia. *AnesthAnalg.* 1992;75:381–[PubMed] [Google Scholar]

# Prevalence of Direct Peer Bullying among Primary Schools' Children in Holly Karbala Center

Ali Abdulrazzaq<sup>1</sup>, Noor Fadhil Abass<sup>2</sup>, Shaima' Nasir Mohammed<sup>3</sup>

<sup>1</sup>*Pediatrics Specialist, Iraqi Board in Pediatrics, Karbala Pediatric Teaching Hospital, Karbala Health Directorate,* <sup>2</sup>*Arabic Board in Family Medicine Al-Najaf Health Directorate,* <sup>3</sup>*Psychiatry Specialist, Iraqi Board in Psychiatry Al-Husain Medical City-Karbala Health Directorate*

## Abstract

**Background:** Bullying among schoolchildren is certainly a very old phenomenon. The fact that some children are frequently and systematically harassed and attacked by other children has been described in literary works, and many adults have personal experience of it from their own school days.

**Subjects and Method:** This cross-sectional study carried out on randomly selected 450 elementary schools' students in 5th and 6th classes 222 males, 228 females in holly Karbala city, province in academic year 2015 - 2016. Data were collected by using a standardized questionnaire.

**Result:** Overall prevalence rate of peer bullying was 33.8% and the prevalence of victims was 25.3%. Results of current study show that there is statistical significant association between bullying and gender, the bullying is more common in males students 38.7% than female 28.89%, while 19.8 % males, 30.7% females were victims of this behavior, this difference is statically significant also the study revealed that bullying was prevalent in poor families.

**Conclusion:** Peerbullying is highly prevalent in primary schools in holly Karbala city, Iraq, compared to many countries, there were positive association between bullying and male students,poverty, low school achievement.

**Keywords:** *Peer bullying; old phenomenon; primary schools' children; Karbala center.*

## Introduction

Bullying among schoolchildren is certainly a very old phenomenon. The fact that some children are frequently and systematically harassed and attacked by other children has been described in literary works, and many adults have personal experience of it from their own school days<sup>(1)</sup>.

Evidence suggests that bullying has acute consequences that range from suicide, murder and absenteeism at school to medical conditions such as fits, faints, vomiting, headaches and long-term psychological problems such as anxiety, depression, loneliness and hysteria<sup>(2)</sup>.

Given that bullying in schools is a prevalent and concerning issue, there has been an apparent increase in bullying studies at the national and international levels<sup>(3)</sup>.

The accurate assessment of bullying provides an opportunity to examine the dimensions of the construct, seriousness of the bullying in schools, and utilization of precise intervention strategies based on that information<sup>(4)</sup>.

Bullying is one type of violence that threatens a youth's well-being in schools and neighborhoods<sup>(5)</sup>. Bullying may inflict harm or distress on the targeted youth (including physical, psychological, social, or educational harm<sup>(6)</sup>). A young person can be a perpetrator, a victim, or both (also known as "bully/victim")<sup>(7)</sup>.

Youth who bully others are at increased risk for substance use, academic problems, and violence later in adolescence and adulthood<sup>(8)</sup>.

Compared to youth who only bully, or who are only victims, bully-victims suffer the most serious



consequences and are at greater risk for both mental health and behavior problems<sup>(9)</sup>.

**Objectives:** To measure prevalence of bullying among samples of students in primary schools in fifth and sixth class levels and to evaluate the relationship between direct bullying and different variables (gender, grade level, socioeconomic status, parental status, ...).

Research on bullying was began in Europe in 1970 lead by Dan Olweus, Norwegian researcher began to study this matter<sup>(10)</sup>.

Meaning there is imbalance of power between perpetrators (bullies) and victims.

(\$ subjects and merods)<sup>(12 & 13)</sup>.

### Subjects and Method

This study was carried out in the Holly Karbala city Centre, in which there are 177 elementary schools this is school - based cross - sectional study. duration continued from mid of January 2016 to the end of July 2016, the work of data collection took 4 days during the week. Out of (177)primary school in Karbala city, 16 primery school have been selected by simple random sampling method using computer available in planning department in Karbala Director of Education From these 16 primary schools, the students of the 5th and 6th classes have been selected . Out of these classes study sample have been selected by using systemic sampling method student. The total number in 5th and 6th classes in these schools which is C 2162), the sample size is 450.

**Questionnaire:** A structured questionnaire was prepared by researcher that was adopted from a questionnaire of Dan - Olweus standardized questionnaire

developed as a part of bullying survey for students in 2006<sup>(14)</sup> zce's go (Cronbach alpha interior consistency of bully scale 0.88 and for victimization scale 0.87 for this questionnaire).

The questionnaire translated to Arabic by an expert with minor modification . the questionnaire was designed to measure several aspects of bullying behavior in last 2 months .

Several sub scales were used in the questionnaire: 1. It contain 27 items about direct bullying (physical, verbal), victims. 2. Questions about gender, class level, order of birth. 3. Questions about academic level (average, below average, good) using grade point average as indicator of academic achievement. Most of primary, middle, high school in Iraq grade out of 100 percent with a passing 50 percent so the grade point average is out of 100 as described below<sup>(15)</sup>.

Grade percentage: excellent 90 –100;very good 80 –89;good 70 – 79;acceptable 50 – 59;weak 0 – 40

**Score Instruction:** Never occur = 0;Once or twice = 1;Two or three times in a month = 2;One time in a week = 4;Six items about victimization from 12 – 17;Three items for physical victimization 19, 21, 22;Two items for verbal victimization 20,23;Statistical analysis was carried out using SPSS version 22.

### Results

A total of 450 primary school students were enrolled in this study, of them 230 (51.1%) of 5th class and the remaining 220 (48.9%) of the 6th class moreover, males were 222 (49.3%) while females were 228 (50.7%). Other characteristics of the studied group are shown in (Table 1).

**Table 1. Frequency distribution of students according to socio-demographic characteristics (N = 450)**

Variable		Frequency	%
Class level	5th	230	51.1%
	6th	220	48.90%
Gender	Male	222	49.30%
	Female	228	50.70%
Order of birth	First	109	24.20%
	Second	122	27.1%
	Third or more	219	48.7%

Variable		Frequency	%
Student's father status	Alive	422	93.80%
	Dead	28	6.20%
Student's parents live together	Yes	395	87.8%
	No	55	12.20%
Family income	Not enough	292	64.90%
	Enough	158	35.1%
Student's school performance	Good	152	33.8%
	Acceptable	224	49.8%
	Weak	74	16.4%
Father encourage this behavior	Yes	206	45.8%
	No	244	54.2%
Mother encourage this behavior	Yes	195	43.3%
	No	255	56.7%

**Table 2. Frequency distribution of the types of bullying**

Bullying type	Frequency	%
Verbal Bullying only	69	45.4
Physical Bullying only	45	29.6
Both types	38	25.0
Total	152	100.0

**Table 3. Frequency distribution of the types of victim**

Victim type	Frequency	%
Verbal	56	49.1
Physical	35	30.7
Both types	23	20.2
Total	114	100.0

**Table 4: Results of the Binomial logistic regression analysis for significantly associated variables with bullying**

	B	S.E	P.value	Odds ratio (OR)	95% C.I. for OR	
					Lower	Upper
Gender	0.398	0.24	0.03	1.48	1.12	2.36
Orders	0.26	0.27	0.34	1.30	0.76	2.23
Student's parents live together	-2.72	0.50	0.00	0.07	0.02	0.17
Family income not enough	0.52	0.24	0.002	1.68	1.05	2.68
Student's school performance good	-1.17	0.19	0.00	0.31	0.21	0.46
Constant	5.444	0.946	0.00	231.403		

**Note:** Variable(s) entered on step 1: Gender, Child order,, Student's parents live together, Family income, Student's school performance

**Table 5: Results of the Binomial logistic regression analysis for significantly associated variables with victimizations**

Variable	B	S.E	P.value	Odds ratio (OR)	95% C.I. for OR	
					Lower	Upper
Gender	0.55	0.28	0.047	1.73	1.01	2.98
Student's Father status (alive)	-2.36	0.53	< 0.001	0.09	0.03	0.27
Student's parents live together (yes)	-3.41	0.48	< 0.001	0.03	0.01	0.09
Student's school performance	-2.31	0.27	< 0.001	0.10	0.06	0.17
Constant	12.87	1.34	0			

## Discussion

In this analysis of 450 elementary school students the results of study demonstrated that 33.8% of elementary level students reported that they were bullied another students and 25.3% of students were victims during the last two months . It is lower than the study in north Africa countries in 2008 found that 60 % of students in Egypt and one third of students in Libya, morocco, and Tunisia reported having been bullied(11) . This rate is considerably higher when compare to other studies in other contraries, for instance in Canada in 2010 an average of 26000 were surveyed the percentage was 12 % of students reported being bullies once or times in last two months and percentage of victims was 22 %<sup>(16)</sup>.

In another study in Turkey in 2009 the ratio estimated of victimization was 15 - 20 % and percentage of bullies was 22%<sup>(17)</sup>. In this study according to the comparisons made between gender variables, it was understood that the male students bullying behaviour“ bullies” were higher than in the female students . Females were found to be exposed to be victims more than males . This finding is consistence with other studies carried out in different countries<sup>(18 & 19)</sup>.

Even in some culture environments, male students' aggressive behaviour are appreciated by society and this finding agree with other study. This variable was significantly associated with being a victim status; was being a female students.[20]

In current study, there were insignificantly associated with bullying, may be the students were nearly had the same age . so, there was no relationship between bullying and order of birth . While in some studies the order of birth play role in developing bullies children <sup>(21)</sup>.

Students who saw themselves as members of low

socioeconomic families tended to exhibit more bullying behavior than those with high socioeconomic class families . Bullying was significantly associated with not enough family income. This finding is similar to the finding of other studies .based up on various research findings, the present study claimed that, if their needs for love, care, respect and social interaction are not met, students from low socioeconomic class families tend to develop more bullying attitudes in order to attract attention and to prove their identity<sup>(22)</sup>.

The other significant factor associated with bullying was student's school performance, where it had been significantly found that bullying was inversely associated with the student performance, the lower proportion of bullying was reported among the students with good school performance, (19.1%), followed by those with acceptable level, (32.1%) while the higher proportion was reported among those with weak performance, (P< 0.001). The students with weak school performance were more likely to be victims than other students.

This assesses the educational harm experienced as a result of being bullied during a specified time period. Educational harm is defined as decreases in academic performance (e.g., lower grades), diminished school engagement (e.g., poor attendance or dropping out of school), missed educational opportunities (e.g., the youth is scared to go to tutoring program or class), negative perceptions of school or other educational activities (e.g., the youth is afraid to go to school, hates school, or does not trust adults in the school), or decreased participation in school-sponsored extracurricular activities such as band, team sports, theatre, and school clubs.

The school yard was the most frequent site for bullying to occur, followed by class room, this result is like other study<sup>(15)</sup>.

This could be explained that the bullies can do their aggressive behavior freely, where there are no teachers or other adults that may stop them. Father encourage this behavior and mother encourage this behavior were insignificantly associated with bullying, these variables, ( $P>0.05$ ), Students of parents who live together were less likely to be bullies compared to those of separated parents, 29.6% vs. 63.6%, respectively, ( $P< 0.001$ ). student whose father was dead, student whose father not live together, are likely to be victims.

### Conclusions

1. Peer bullying is highly prevalent in primary schools in Holly Karbala city/Iraq compared to other countries and it lower than north Africa countries.
2. Peer bullying was higher in males than females' students and Peer victimization was higher in females' students than males' students. So, Peer bullying and victimization were significantly high among students from families with low socioeconomic class and separated parents and student whose father was dead, student whose parents not live together, exhibition to be victims. And not enough family income was the more predictor factor for bullying.

**Conflict of Interest:** None

**Source of Findings:** Self-findings.

**Ethical Clearance:** None

### References

1. Olweus D. bullying at school: basic facts and effects of school based intervention program. Journal of the American Academy of Children and Adolescent psychiatry, 2009. 35(7):1171-90 .
2. Stockdale MS, Hangadumbo S, Duys D, Larson K, Sarvela PD. Rural elementary students', parents', and teachers' perceptions of bullying. American Journal of Health Behavior. 2002 Jul 1;26(4):266-77.
3. Bandyopadhyay S, Cornell DG, Konold TR. Validity of three school climate scales to assess bullying, aggressive attitudes, and help seeking. School Psychology Review. 2009 Sep 1;38(3):338.
4. Cole J, Cornell D, Sheras P. Identification of school bullies by survey method. Professional School Counseling. 2006 Apr 1;9(4):305-13.
5. Rigby K. A meta-evaluation of method and approaches to reducing bullying in pre-schools and early primary school in Australia. Attorney-General's Department; 2002 Jun.
6. Gladden RM, Vivolo-Kantor AM, Hamburger ME, Lumpkin CD. Bullying surveillance among youths: Uniform definitions for public health and recommended data elements.
7. Conn K. TK and JC: Guidance for Schools Dealing with Bullying and Cyberbullying. NEULJ. 2013;5:77. Bully WD. Date modified: May 2013.
8. Farrington D, Baldry A. Individual risk factors for school bullying. Journal of aggression, conflict and peace research. 2010 Jan 29;2(1):4-16.
9. Carrera MV, DePalma R, Lameiras M. Toward a more comprehensive understanding of bullying in school settings. Educational Psychology Review. 2011/1 Dec 1;23(4):479-99.
10. Olweus O. Bullying at school. What we know and what we can do. Oxford: Blackwell, 1993
11. Abdirahman H, Fleming LC, Jacobsen KH. Parental involvement and bullying among middle-school students in North Africa. Eastern Mediterranean Health Journal. 2013 Mar 1;19(3):227.
12. Bowes L, Arseneault L, Maughan B, Taylor A, Caspi A, Moffitt TE. School, neighborhood, and family factors are associated with children's bullying involvement: A nationally representative longitudinal study. Journal of the American Academy of Child & Adolescent Psychiatry. 2009 May 31;48(5):545-53.
13. Idsoe T, Dyregrov A, Idsoe EC. Bullying and PTSD symptoms. Journal of abnormal child psychology. 2012 Aug 1;40(6):901-11.
14. Jones L, Doces M, Swearer S, Collier A. Implementing bullying prevention programs :- schools : A how to guid Berkaman center Research publication 2012 Apr 16
15. Republic of Iraq ministry of higher education and scientific research [www.classbase.com/countries/Iraqgrading-system](http://www.classbase.com/countries/Iraqgrading-system)
16. By numbers rates and risk factors for bullying . a brief examination of Canadian bully statistics : march 2013:EFC (the evangelical fellow ship of Canada).
17. Kartal H. The ratio of bullying and victimization among Turkish elementary school students and its

- relationship to gender and grade level. *J Soc Sci.* 2009 Dec; 20(2):109-19.
18. Carney J. Perceptions of bullying and associated trauma during adolescence. *U Professional School Counseling.* 2008 Feb 1;11(3):179-88.
  19. Unicef fact sheet, stop violence in school, the scope and impacts of bullying .
  20. Berger KS. Update on bullying at school: Science forgotten?. *Developmental review.* 2007 Mar 31;27(1):90-126
  21. Sahin M Observation of peer bullying in Turkish primary schools according to different variables . *CJES (Cypriot Journal of Educational Sciences),* 2010,5: 258-70.
  22. Jansen PW, Verlinden M, Dommissie-van Berkel A, Mieloo C, van der Ende J, Veenstra R, Verhulst FC, Jansen W, Tiemeier H. Prevalence of bullying and victimization among children in early elementary school: Do family and school neighbourhood socioeconomic status matter?. *BMC Public Health.* 2012 Jul 2;12(1):1.

# Types of Cancer Prevalence in Al Muthanna Province for Two Years' Duration (2018-2019)

Sarah Ali Abed<sup>1</sup>, Rana Dakhil Nafea<sup>2</sup>, Suha Suhiel Hussein<sup>3</sup>,  
Dergham Majeed Hameed<sup>4</sup>, Ihab Abbas Taher<sup>5</sup>

<sup>1</sup>Assistant Prof., Collage of Medicine, Department of Pathology, M.B.Ch.B., F.I.C.M.S. (Path.), AL-Muthanna University, Iraq, <sup>2</sup>Lecturer, Collage of Medicine, Department of Surgery, M.B.CH.B.-C.A.B.O-ICO (Ophthal), AL-Muthanna University, Iraq, <sup>3</sup>M.Sc., Pathologist in Surgical Pathology Department, AL-Muthanna Health Director, MOH, Iraq, <sup>4</sup>Prof. in Nursing, Dean of Collage of Nursing, AL-Muthanna University, Iraq, <sup>5</sup>Lecturer, MSC., Department of Organic Chemistry and Biochemistry, AL-Muthanna University, Iraq

## Abstract

**Objective:** The aim of study to find out the prevalence of cancer in Al muthanna province, the most common type of cancer, the danger age group, gender and the site of malignancy in the body.

**Methodology:** The study sample about (100) case was taken from cancer patients from laboratory unit in Al Hussein teaching hospital from July 2018 to September 2019. The study design was a quantitative descriptive design. The data collection taken by the researchers was self report dichotomous, the method of self report was conducted as on type of data collections by using phrases occur or not occur in all types of cancer.

**Result and Conclusion:** Indicated that the age between (51-61) years was have more percentage of 29.5, female affected by cancer more than male and rural area affected by cancer is more than urban.

**Recommendation:** Further research do about cancer prevalence and the risk factor in the most common area in province.

**Keywords:** Cancer, types, histopathology, prevalence, Al muthana.

## Introduction

Cancer is one of the most leading causes of morbidity and mortality in worldwide, it's also the second cause of death in the world, and was responsible for 8.8 million deaths in 2015. The most common organ affected by cancers include: Breast, lung, Liver, Colorectal, and Stomach. nearly 1 in 6 deaths is due to cancer. Approximately 70% of deaths from cancer occur commonly in low- and middle-income countries and Around one third of deaths from cancer are due to

behavioral and dietary risks as low fruit and vegetable intake, lack of physical activity, tobacco use, and alcohol use. Between 30–50% of cancers may be prevented by decrease risk factors and implementing existing evidence-based prevention strategies. The cancer burden can also reduced by early detection of cancer in the body and management of patients who have cancer. Many cancers have a high chance of cure if diagnosed in early stage of disease and treated adequately.<sup>[1]</sup>

In Iraq according to the Ministry of Health statistics in 2016 cancer is always considered a significant health problem and the second leading cause of death. The total number of cases of cancer during 2015 was 25,269 and male to female ratio 0.8:1. The most affected age group was 70 +years, and the incidence increased with age.

The top ten cancer are breast (19.1%), bronchus & lung (8.1%), leukemia (6.3%), brain & other central

---

### Corresponding Author:

**Sarah Ali Abed**

Assistant Prof., Collage of Medicine, Department of Pathology, M.B.Ch.B., F.I.C.M.S. (Path.), AL-Muthanna University, Iraq  
e-mail: saraaliabed80@gmail.com

nervous system (CNS) (6.1%), colorectal (5.7%), urinary bladder (5.1%), Non-Hodgkin lymphomas (4.3%), thyroid gland (3.8%), skin (3.2%), and stomach (3.2%). The highest incidence of cancer in males was bronchus & lung cancer (6.7/100,000 males population), while in females was breast cancer (25.8/100,000 females population). The incidence of breast, bronchus & lung, brain & other CNS, colorectal, thyroid gland, and stomach cancer increased for the last 5 years (2011-2015). But the incidence of leukemia, lymphoma, and urinary bladder cancer decreased for the last 5 years (2011- 2015). While the incidence of skin cancer not change.<sup>[2]</sup>

Muthana province have cancer case by 11.9% of the area of Iraq.<sup>[3]</sup> So it must be assess for prevalence of cancer and most receiving a significant attention in Iraq as a major health problem both in terms of incidence and mortality<sup>[4,5,6]</sup>.

The colorectal cancer is the third common cancer affect male in the world and second leading death in western world, it account 9.4% in male and 10.1% in female.<sup>[7]</sup>

### Materials and Method

Purposive (non probability) sample was taken from cancer patients from laboratory unit in al Hussein teaching hospital from July 2018 to September 2019 . the study design was a quantitative descriptive design. (100) patient have cancer in different types.

The data collection taken by the researchers was self report dichomitus, the method of self report was concenter as on type of data collections by using phrases occur or not occur in all types of cancer .

Four questions contain the following : Age, Gender, Address and type of cancer take from patient have histopathological investigations by having malignant diseases .

### Result and Discussion

**Table (1) Distribution of the Study Samples by Socio- Demographic Characteristics**

Items	Sub-groups	Study group Total = 95	
		Frequency	Percentage
Age/Years	21-30	6	6.3
	31-40	18	18.9
	41-50	19	20.0
	51-60	28	29.5
	61-70	13	13.7
	71>=	11	11.6
	<b>Mean = 52.63</b>	<b>Standard deviation = ± 14.23</b>	
Gender	Male	36	37.9
	Female	59	62.1
Residency	Urban	36	37.9
	Rural	59	62.1

Table (1): show that variable age group was affect by cancer and the age between 51- 60 were mostly affected, this finding is identical to cancer research in UK, About 9 in 10 cancer case in UK are in age 50 or over and this is true for most types of cancer .this due to cell damage over time that can some time lead to cancer, Also this study identical with study approved by the cancer .net

editorial board in 2019 that greatest risk age was 60 or older about 60% of people who have cancer . Also Mary C. et al say that cancer consider an age –related disease because the incidence of most cancer increase with age.<sup>[8]</sup>

Also this table show that the female more affected by cancer than male mainly by breast cancer this result is

identical to study done in USA in which they show that Breast cancer is the most common cancer in American women, But every woman should know about the risks

for breast cancer and what they can do to help lower their risk.<sup>[9,10,11]</sup>

**Table (2) Distribution of the Study Samples by type of cancer**

Items	Sub-groups	Study group Total = 95	
		Frequency	Percentage
Cancer type	Breast cancer	40	42.1
	Prostate	7	7.4
	Brain	3	3.2
	rectum	2	2.1
	Kidney	4	4.2
	Lung	6	6.3
	Thyroid	5	5.3
	Nose	1	1.1
	Larynx	2	2.1
	Bone	4	4.2
	Ovary	2	2.1
	Skin	1	1.1
	Urinary bladder	4	4.2
	Blood	1	1.1
	Uterus	4	4.2
	Pancreas	1	1.1
	Lymph node	2	2.1
	Colon	4	4.2
	Stomach	1	1.1
Gall bladder	1	1.1	
Total	95	100	

Table (2): Show that breast cancer is more common type in Al-Muthanna government this result was identical to The American Cancer Society result that find **Women at high risk for breast cancer** is due to their family history, a genetic mutation, or other risk factors .

The American Cancer Society recommends the following for women at average risk for breast cancer: **Women ages 40 to 44** should have the choice to start yearly breast cancer screening with a mammogram (x-ray of the breast) if they wish to do so. **Women age 45 to 54** should get a mammogram every year. **Women 55 and older** can switch to a mammogram every 2 years, or can continue yearly screening.

Screening should continue as long as a woman is in good health and is expected to live at least 10 more years.<sup>[12,13]</sup>

There are also increase of frequency of prostate cancer in male in Al-Muthana government .this identical to study done by Husain HY, Al-Alwacahi SF that shows Prostate cancer is the second most frequent malignancy (after lung cancer) in men worldwide, counting 1,276,106 new cases and causing 358,989 deaths (3.8% of all deaths caused by cancer in men) in 2018<sup>[14,15]</sup>. The incidence and mortality of prostate cancer worldwide correlate with increasing age, they shows that Diet and physical activity play an important role in prostate cancer development



and progression. Dietary factors are mainly associated with the observed worldwide and ethnic differences in the incidence rates of prostate cancer.<sup>[16,17,18,19,20]</sup> The total number of cases of cancer during 2015 was 25,269 and male to female ratio 0.8:1. The most affected age group was 70 +years, and the incidence increased with age bronchus & lung (8.1%), thyroid gland (3.8%), colorectal (5.7%), while in females was breast cancer (25.8/100,000 females population). The incidence of

breast, bronchus & lung, brain & other CNS, colorectal, thyroid gland, and stomach cancer increased for the last 5 years (2011-2015).this is correlate to this study while in the study done by Environmental Statistics in Iraq Report 2009 the incidence of leukemia, lymphoma, and urinary bladder cancer decreased for the last 5 years (2011- 2015) this is also identical to this study done in Al –Mothana government .

**Table (3): The association and correlation between type of cancer and Socio- Demographic Characteristics:**

Items	Sub-groups	Type of cancer																				
		Breast cancer	Prostate	brain	rectum	Kidney	lung	thyroid	Nose	larynx	bone	ovary	skin	Urinary bladder bladder	blood	uterus	pancreas	Lymph node	colon	stomach	Gall bladder	total
Age/Years	21-30	0	0	1	0	0	0	1	0	1	0	0	0	2	0	0	0	0	1	0	0	6
	31-40	0	1	0	0	1	1	1	1	0	2	0	0	1	0	0	0	0	0	0	1	18
	41-50	7	2	1	0	0	4	3	0	0	0	1	0	0	0	0	1	0	0	0	19	
	51-60	18	0	0	2	2	0	0	0	0	1	0	0	0	0	2	0	1	2	0	0	28
	61-70	3	2	1	0	1	1	0	0	0	0	0	0	1	1	1	0	0	1	1	0	13
	71>=	3	2	0	0	0	0	0	0	1	1	1	1	0	0	1	1	0	0	0	0	11
	<b>Total</b>	<b>40</b>	<b>7</b>	<b>3</b>	<b>2</b>	<b>4</b>	<b>6</b>	<b>5</b>	<b>1</b>	<b>2</b>	<b>4</b>	<b>2</b>	<b>1</b>	<b>4</b>	<b>1</b>	<b>4</b>	<b>1</b>	<b>2</b>	<b>4</b>	<b>1</b>	<b>1</b>	<b>95</b>
<b>Chi-square = 126.477 df= 95 p. value= 0.017 significance= significant correlation= 0.031</b>																						
Gender	Male	39	1	0	1	1	2	2	0	2	1	2	1	2	0	4	0	0	1	0	0	59
	Female	1	6	3	1	3	4	3	1	0	3	0	0	2	1	0	1	2	3	1	1	36
	<b>Total</b>	<b>40</b>	<b>7</b>	<b>3</b>	<b>2</b>	<b>4</b>	<b>6</b>	<b>5</b>	<b>1</b>	<b>2</b>	<b>4</b>	<b>2</b>	<b>1</b>	<b>4</b>	<b>1</b>	<b>4</b>	<b>1</b>	<b>2</b>	<b>4</b>	<b>1</b>	<b>1</b>	<b>95</b>
<b>Chi-square = 60.517df= 19 p. value= 0.0000 significance= significant correlation= 0.371</b>																						
Residency	Urban	16	3	1	0	1	2	1	0	0	2	1	0	1	1	3	0	2	2	0	0	36
	Rural	24	4	2	2	3	4	4	1	2	2	1	1	3	0	1	1	0	2	1	1	59
	<b>Total</b>	<b>40</b>	<b>7</b>	<b>3</b>	<b>2</b>	<b>4</b>	<b>6</b>	<b>5</b>	<b>1</b>	<b>2</b>	<b>4</b>	<b>2</b>	<b>1</b>	<b>4</b>	<b>1</b>	<b>4</b>	<b>1</b>	<b>2</b>	<b>4</b>	<b>1</b>	<b>1</b>	<b>95</b>
<b>Chi-square = 14.845df= 19 p. value= 0.732 significance= non-significant correlation= -0.052</b>																						

Table (3): show that significant association between age and type of cancer the common age group was between (51-60) which is breast cancer . this study identical to study done by the National Cancer Institute (NCI) which found that Breast cancer is most common cancer affect females over the age of 50 years so doctors most often diagnose breast cancer in females aged 55-64 years. The NCI Based on data from 2012-2016 saw

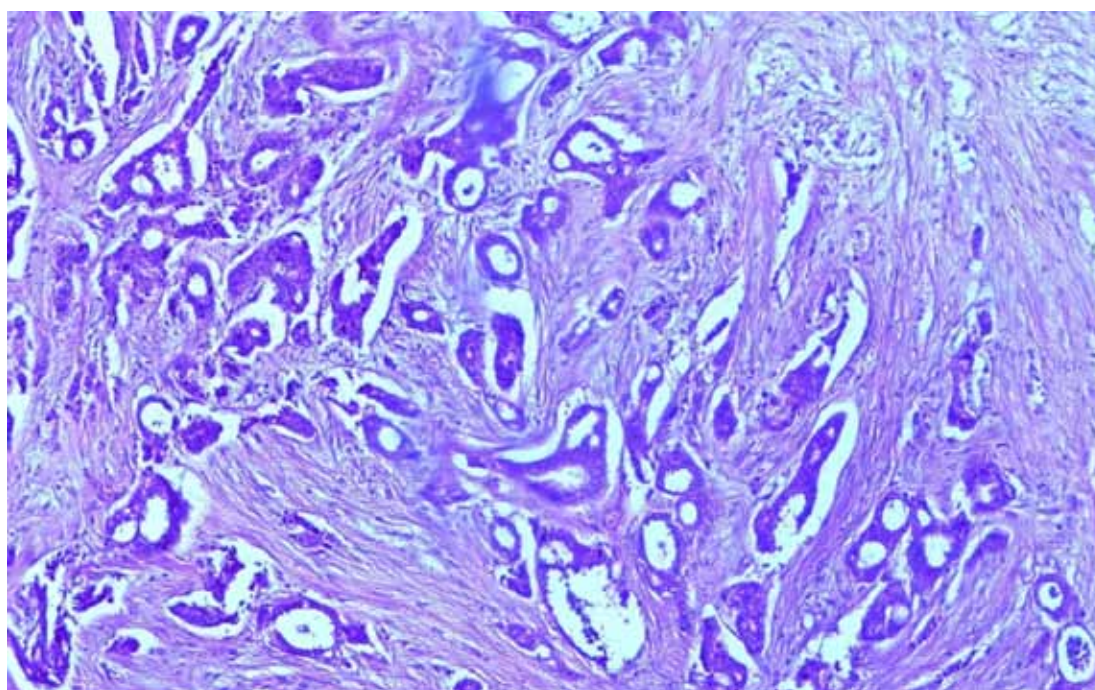
that the median age of diagnosis in females with breast cancer was 62 years old. The NCI also report that of the 437,722 females that doctors diagnosed breast cancer in between 2012 and 2016:

- 1.9% were aged 20–34 years
- 8.4% were aged 35–44 years
- 20.1% were aged 44–55 years

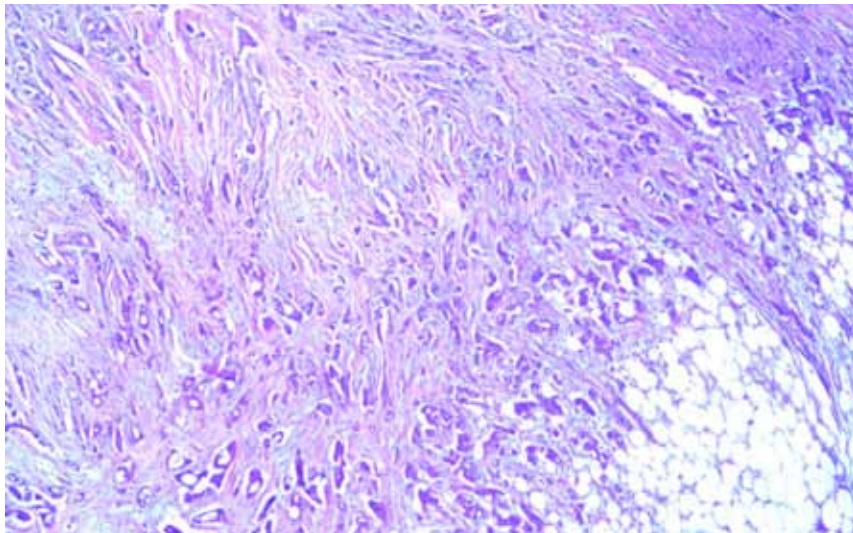
- 25.6% were aged 55–64 years
- 24.8% were aged 65–74 years
- 13.7% were aged 75–84 years
- 5.6% were aged 84 years+
- Medically reviewed by Yamini Ranchod, PhD, MS on July 3, 2019 — Written by Lana Burgess.<sup>[21]</sup>

This table show that there is significant association between age and gender,cancer is more affect female than male, from total 95 case was taken in AL-Hussein teaching hospital, about 59 female was affect by cancer this study is identical to study done by Moynihan C. that show female is more affect than male .<sup>[22]</sup> Also there is no significant association between the site of case affected by cancer and the type of cancer . there is increase incidence of cancer in rural area than in urban area this study identical to study done by Meilleur A et.al in which. there is increase chance of having cancer in rural area,and The urban decline in incidence rate was greater than in rural populations (10.2% vs. 4.8%, respectively). Rural cancer disparities included higher rates of tobacco-associated, HPV-associated, lung and bronchus, cervical, and colorectal cancers across most population groups. Furthermore, HPV-associated cancer incidence rates increased in rural areas (APC = 0.724,  $P < 0.05$ ), and decrease of preventive screening modalities for (e.g., colorectal and cervical cancers) were higher in

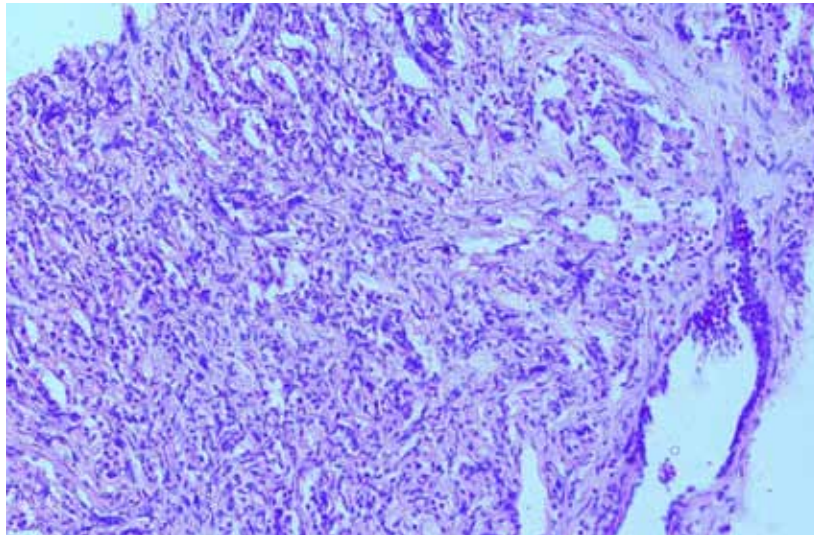
rural compared with urban For many rural populations, cancer mortality is not decreasing; it is steady and, in some cases, rising. Several studies have documented persistently elevated cancer incidence and mortality in rural communities compared with urban areas<sup>[23-26]</sup>. also found, In 2010 to 2012, the highest rates of poverty and uninsured status in the nation were found in small rural counties and in large inner cities<sup>[27]</sup>. Also study done by Foutz J, Artiga S, Garfield R. 2017,large rural populations did not expand Medicaid, leaving millions of people still without health insurance<sup>[28]</sup>. Furthermore, there are documented barriers to health care access in rural communities. Many rural residents live in health care provider–shortage areas, may have fewer choices in care, and may need to travel long distances just to see a primary care physician. And rural area have lower rates of cancer screening, experience and lower quality cancer care <sup>[23-24]</sup>. Furthermore, numerous studies have identified higher rates of cancer-risk behaviors among rural residents, which can contribute to the elevated incidence rates of cancer . Higher rates of tobacco use and obesity in rural populations are consistently reported<sup>[29-33]</sup>. In addition, human papillomavirus (HPV) vaccination rates are lagging in rural areas, with lower rates associated with increasing rurality<sup>[34]</sup>.Also it was seen that renal disease is the most common causing of malignancy in the kidney<sup>[35]</sup>.



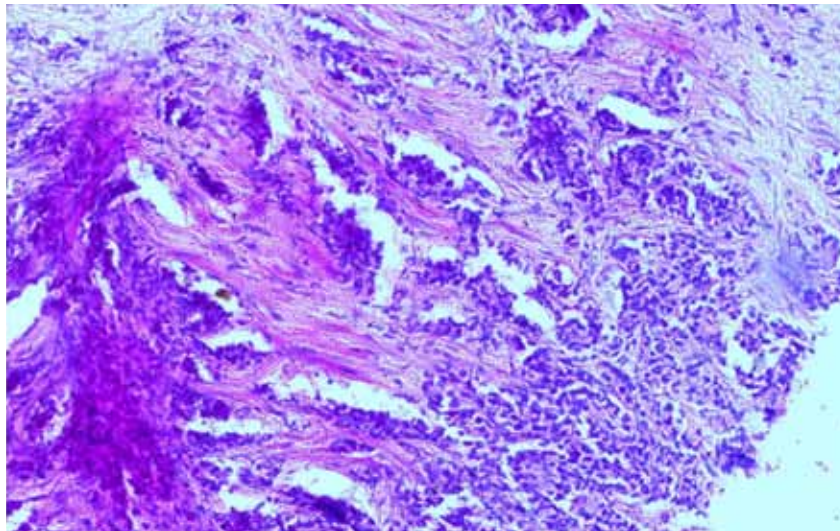
**Figure (1): Invasive Ductal Carcinoma with H & E stain {40X} .**



**Figure (2): Invasive Ductal Carcinoma with H & E stain {40X}.**



**Figure (3): Prostatic Carcinoma with H & E stain {40X}.**



**Figure (4): Prostatic Carcinoma with H & E stain {40X} .**

### Conclusion

1. Early Finding of cancer can help in rapid treatment and decrease the death rate between women so if breast cancer early diagnosed specially when it's very small, that not spread, might be easier to treat and can help to prevent deaths from the cancer.
2. Getting regular screening tests is the most reliable way to find cancer like breast cancer so it should be screened with MRI along with a mammogram.
3. Talk with a health care provider about risk for cancer and the best screening plan for it.

### Recommendation:

1. Regular self -examination of female to the breast and the province must do educational program to the way for breast examination .
2. Improve personal habit like regular exercise, decrease fatty diet and eating more vegetable and fruit .
3. Give up smoking.
4. Regular check up to detect any abnormal growth in the body. **Women ages 40 to 44** should have the choice to start yearly breast cancer screening with a mammogram (x-ray of the breast) if they wish to do so. **Women age 45 to 54** should get a mammogram every year. **Women 55 and older** can switch to a mammogram every 2 years, or can continue yearly screening.
5. Further research do about cancer prevalence and the risk factor in the most common area in province .

**Ethical Clearance:** The Research Ethical Committee at scientific research by ethical approval of both environmental and health and higher education and scientific research ministries in Iraq

**Conflict of Interest:** The authors declare that they have no conflict of interest.

**Funding:** Self-funding

### References

1. GBD 2015 Risk Factors Collaborators. Global, regional, and national comparative risk assessment of 79 behavioral, environmental and occupational, and metabolic risks or clusters of risks, 1990-2015 a systematic analysis for the Global Burden of Disease Study 2015. *Lancet*. 2016 Oct; 388 (10053):1659-1724.
2. Iraqi Cancer Board Annual Report Iraqi Cancer Registry. Minister of Health Doctor Adela Hmood Hussein Head Iraqi Cancer Boardp1-6Minister of Health Doctor Adela, 2015.
3. MINISTRY OF HEALTH IRAQI CANCER REGISTRY 2009: IRAQI CANCER BOARD IRAQI CANCER REGISTRY CENTER Tele: (+) 9641 – 4150292 Iraqi\_cancerboard@yahoo.com BAGHDAD – IRAQ 2012 .
4. Husain HY, Al-Alwacahi SF. Incidence rates, pattern and time trends of registered cancer in Iraq (1991-2008): Population and hospital based registry. *Open Access Libr J* 2014;1:1-6. Available from: <http://www.oalib.com/journal>. [Last accessed on 2014 Apr 15].
5. Hussain A, Habib OS. Incidence of cancer in Basrah Results of a household survey *Asian Pac J Cancer Prev* 2015;16:163.
6. Mohsin AA, Al-Elwe WM, Hasan JG, Al-Haroon SS, et al. Experience and outcome of population-based cancer registration in Basrah-Southern Iraq in 2005-2008. *Asian Pac J Cancer Prev* 2010;11:1151-4.
7. Suheil S.,Clinicopathological study of colonic polyps by application of P53 & KI67 .2014:1-2.
8. Mary C. White, ScD, Dawn M. Holman, MPH, Jennifer E. Boehm, MPH, Lucy A. Peipins, PhD, Melissa Grossman, MPH, and S. Jane Henley, MSPH Age and Cancer Risk A Potentially Modifiable Relationship; *Am J Prev Med*. 2014 Mar; 46(3 0 1): S7–15.
9. Centers for Disease Control and Prevention (CDC). Cancer and women. Accessed At <https://www.cdc.gov/cancer/dcpc/resources/features/womenandcancer/index.htm> on May 6, 2019.
10. Jemal A, Ward EM, Johnson CJ, Cronin KA, Ma J, Ryerson AB, Mariotto A, Lake AJ, Wilson R, Sherman RL, Anderson RN, Henley SJ, Kohler BA, Penberthy L, Feuer EJ, Weir HK. Annual Report to the Nation on the Status of Cancer, 1975-2014, Featuring Survival. *J Natl Cancer Institute*. 2017; 109(9): 1-19.
11. Smith RA, Andrews KS, Brooks D, Fedewa SA, Manassaram-Baptiste D, Saslow D, Wender RC. Cancer screening in the United States, 2019: A review of current American Cancer Society guidelines and current issues in cancer screening.

- CA: *Cancer J Clin.* 2019; 69(3): 184-210. Last Medical Review: August 1, 2019 Last Revised: August 1, 2019
12. American Cancer Society medical information is copyrighted material. For reprint requests, please see our Content Usage Policy. American Cancer Society (ACS). *Cancer Facts & Figures 2019*. Atlanta, Ga: American Cancer Society; 2019. Accessed at <https://www.cancer.org/research/cancer-facts-statistics/all-cancer-facts-figures/cancer-facts-figures-2019.html> on May 6, 2019.
  13. Centers for Disease Control and Prevention (CDC). *Cancer and women*. Accessed at <https://www.cdc.gov/cancer/dcpc/resources/features/womenandcancer/index.htm> on May 6, 2019.
  14. Bray F, Ferlay J, Soerjomataram I, Siegel RL, Torre LA, Jemal A. *Global cancer statistics 2018: GLOBOCAN estimates of incidence and mortality worldwide for 36 cancers in 185 countries*. *CA Cancer J Clin.* 2018;68(6):394- 424. 2.
  15. Ferlay J EM, Lam F, Colombet M, Mery L, Pineros M, Znaor A, Soerjomataram I, et al. *Global cancer observatory: cancer today*. Lyon, France: International Agency for Research on Cancer. Available from: <https://gco.iarc.fr/today>, Accessed 02 February 2019.
  16. Chan JM, Gann PH, Giovannucci EL. *Role of diet in prostate cancer development and progression*. *J Clin Oncol.* 2005;23(32):8152-8160. doi: 10.1200/JCO.2005.03.1492. [PubMed] [CrossRef] [Google Scholar]
  17. Giovannucci E, Rimm EB, Colditz GA, Stampfer MJ, Ascherio A, Chute CG, Willett WC. *A prospective study of dietary fat and risk of prostate cancer*. *J Natl Cancer Inst.* 1993;85(19):1571-1579. doi: 10.1093/jnci/85.19.1571.
  18. Kolonel LN, Nomura AM, Cooney RV. *Dietary fat and prostate cancer: current status*. *J Natl Cancer Inst.* 1999;91(5):414-428. doi: 10.1093/jnci/91.5.414.
  19. Platz EA, Leitzmann MF, Michaud DS, Willett WC, Giovannucci E. *Interrelation of energy intake, body size, and physical activity with prostate cancer in a large prospective cohort study*. *Cancer Res.* 2003;63(23):8542-8548.
  20. Willis MS, Wians FH. *The role of nutrition in preventing prostate cancer: a review of the proposed mechanism of action of various dietary substances*. *Clin Chim Acta.* 2003;330(1-2):57-83. doi: 10.1016/S0009-8981(03)00048-2. The risk of breast cancer in different age groups Juha Peltonen Content may be subject to copyright.
  21. by Yamini Ranchod, PhD, MS on July 3, 2019— Written by Lana Burgess
  22. Moynihan C. *Men, women, gender and cancer*. *Eur J Cancer Care (Engl).* 2002 Sep;11(3):166-72.
  23. Milleur A, Subramanian SV, Plascak JJ, Fisher JL, Paskett ED, Lamont EB. *Rural residence and cancer outcomes in the United States: issues and challenges*. *Cancer Epidemiol Biomarkers Prev* 2013;22:1657–67.
  24. Chow CJ, Al-faie WB, Abraham A, Markin A, Zhong W, Rothenberger DA, et al. *Does patient rurality predict quality colon cancer care? A population-based study*. *Dis Colon Rectum* 2015;58:415–22.
  25. Kinney AY, Harrell J, Slattery M, Martin C, Sandler RS. *Rural-urban differences in colon cancer risk in blacks and whites: the North Carolina Colon Cancer Study*. *J Rural Health* 2006;22:124–30.
  26. Singh GK, Williams SD, Siahpush M, Mulhollen A. *Socioeconomic, rural-urban, and racial inequalities in US cancer mortality. Part I. All cancers and lung cancer and part II-colorectal, prostate, breast, and cervical cancers*. *J Cancer Epidemiol* 2011;2011:107497.
  27. National Center for Health Statistics. *Health US, 2015: with special feature on racial and ethnic health disparities*. Hyattsville, MD: National Center for Health Statistics; 2016.
  28. Foutz J, Artiga S, Garfield R. *The role of medicaid in rural America; 2017*. Available from: <http://kff.org/medicaid/issue-brief/the-role-of-medicaid-in-rural-america/>.
  29. Roberts ME, Doogan NJ, Kurti AN, Redner R, Gaalema DE, Stanton CA, et al. *Rural tobacco use across the United States: how rural and urban areas differ, broken down by census regions and divisions*. *Health Place* 2016;39:153–9.
  30. Doescher MP, Jackson JE, Jerant A, Gary Hart L. *Prevalence and trends in smoking: a national rural study*. *J Rural Health* 2006;22:112–8.
  31. Doogan NJ, Roberts ME, Wewers ME, Stanton CA, Keith DR, Gaalema DE, et al. *A growing geographic disparity: rural and urban cigarette smoking trends in the United States*. *Prev Med.*

- 2017 Mar 16. Available from: <https://www.ncbi.nlm.nih.gov/pubmed/28315761>.
32. Chang JT, Levy DT, Meza R. Trends and factors related to smokeless tobacco use in the United States. *Nicotine Tob Res* 2016;18:1740–8.
  33. Befort CA, Nazir N, Perri MG. Prevalence of obesity among adults from rural and urban areas of the United States: findings from NHANES (2005-2008). *J Rural Health* 2012;28:392–7.
  34. Henry KA, Stroup AM, Warner EL, Kepka D. Geographic factors and human papillomavirus (HPV) vaccination initiation among adolescent girls in the United States. *Cancer Epidemiol Biomarkers Prev* 2016;25:309–17.
  35. Hameed, AL-Ftlawy Dergham. Effectiveness of an educational program upon provided nurses knowledge about complication in peritoneal dialysis unite, unpublished doctoral dissertation, Baghdad University (2006):129-3.

# Histomorphometric and Histochemical Finding of the Proventricular and Ventricular Stomach between the African Grey Parrot (*Psittacus erithacus*) and Black Francolin (*francolinus*) in South Iraq

Eyhab R.M. Al-Samawy<sup>1</sup>, Shaima Khazaal Waad<sup>2</sup>,  
Wissam Sajid Hashim Al-Uboody<sup>3</sup>, Mustafa Salah Hasan<sup>4</sup>

<sup>1</sup>Assist. Prof., Department of Anatomy & Histology, College of Medicine, Al- Muthanaa University, <sup>2</sup>Assist. Prof., Department of Anatomy & Histology, College of Vet. Med., Al- Muthanaa University, <sup>3</sup>Assist. Prof., Department of Physiology, College of Medicine, Al- Muthanaa University, <sup>4</sup>Assist. Prof., Department of Internal and Preventive Medicine, Col. of Vet. Med.4

## Abstract

The study was done on sixteen specimens including: eight Parrot and eight francolins of both sexes. The current study aims to discover the structures of proventriculi and ventriculi belonging to these birds specifically their histologic and histochemical textures. The anatomical studies revealed that stomach of both birds consists of: proventriculi & ventriculi. Histological exam was showed that the wall of proventriculus of the Parrot and francolin composed of four layers including: mucosa, submucosa, muscularis and serosa. The epithelia of proventriculi and ventriculus were simple columnar cells for each bird.

The obtained means of thickness of layers of proventriculus and ventriculus appear different between male and female of both birds.

For histochemical studies there were some different reaction of PAS- stain which were detailed in the results.

**Keywords:** Francolin, Parrot, proventriculus, ventriculus, histochemistry.

## Introduction

Birds fall into about 8948 species and they are allocate din about 27 orders. Each order contains vast varying number of species. Passeriformes is considered the largest one as it possess about 5243 species. As containing one species only, Struthioniformes is considered the smallest. Francolin belongs to the order Anseriformes which possess five species<sup>(1)</sup>. Black francolin belongs to Phasianidae family of pheasants

and in the order Galliformes, the gallinaceous birds and it is called *Francolinus francolinus*. Considering it as a native bird to Asia, it was referred to as black partridge<sup>(2)</sup>. The structure of the bird stomach was studied by different researchers including<sup>(3)</sup> in pigeon<sup>(4)</sup> in Japanese quail, <sup>(5)</sup> in red-capped cardinal, and<sup>(6)</sup> in partridge. Due to lack of information about the histological and histochemical structures of the stomach in francolin and Parrot, this study was accomplished to reveal it in both genders. The stomach of the birds is considered the most important part of the digestive system and it possess two parts; the proventriculus and ventriculus or what is called gizzard. The latter contains the grit or gravel which has an importance with the aid of the muscles in facilitating the grinding up the food. To fulfil their requirements of energy, birds have a high rate of metabolism and they consume large quantities of food<sup>(7)</sup>.

---

### Corresponding Author:

**Eyhab R.M. Al-Samawy**

Department of Anatomy, Histology & Embryology,  
College of Medicine, Al Muthanaa University, Al-  
Muthanaa/Iraq

e-mail: ehyabrazzaq3@gmail.com

## Materials and Method

**Bird's Collection:** Eight Parrot (*Psittacus erithacus*) and eight black francolin (*francolinus*) both sex were collected to perform the ongoing study. Birds were fetched from local markets at Al-Muthanaa and Al-Basra provinces.

**Morphological Study:** sodium pentobarbitone (140 mg/kg) was injected i.v. to make birds euthanized before accomplishing dissection<sup>(8)</sup>. After that, they were dissected by the use of a board for dissecting. Coelomic viscera were viewed by making an incision in the mid – line. By using a digital camera, stomach was photographed. A well illustrating figures were depended to exert the locations of these organs and their relationship. Debris and blood were washed out by the use of normal saline. Stomach was eviscerated by pressure to expel its content and then additional normal saline washing was carried out.

**Histological Processing:** neutral buffered formalin 10% was used to fix the specimens. Dehydration of the specimens was done by the use of ascending ethanol series to pass them in as a period of two hours each depending the concentrations (70, 80, 90, 95 and 100). Specimens were embedded in paraffin wax and then cleared with xylene till two hours. The prepared blocks were being sectioned on thickness of 6 µm and the below stains were used to perform staining: eosin – hematoxylin Mayer's routine stain was applied to identify general characteristics, while collagen and smooth muscles were stained with the stain of Masson trichrome.

**Histochemical Processing:** Bouin's solution was used to fix the specimens. Olympus microscope was used to exam and photograph the sections. PAS – alcian combined blue was used to determine the neutral mucin. Epithelial linings basement membranes of were illustrated by the use of PAS<sup>(9)</sup>.

## Results/Discussion

**Morphological Finding:** Figure (1) reveals that the stomach of parrot and francolin included like other birds proventriculus and ventriculus. Of these birds are domestic fowl<sup>(10)</sup>, partridge<sup>(11)</sup>, and Japanese quail. In contrast to that<sup>(12)</sup> has reported that there are three parts included in the stomach those are; proventriculus, ventriculus and in addition to pylorus. Cranially to the esophagus and caudally to the gizzard, the proventriculus of the birds of our study situates as it is clear in (figure

1). Similar to the site in other birds like ostrich as was mentioned by<sup>(13)</sup> and<sup>(14)</sup>, the proventriculus was veiled partially by hepatic left lobe. Figure (1) also reveals the ventriculus of francolin takes a form of spindle and there is an amount of adipose tissue surround it. In other side, ventriculus of parrot appeared ovoid and muscular of a lesser size and there is a thick adipose tissue surround it. Might be due to the nature of food stuff of birds, the shape besides the size of the ventriculus could be differ as considering it as the muscular stomach part. In a line with other species like red –winged tinamou<sup>(6)</sup> and pigeon<sup>(14)</sup>, the parrot ventriculus shape comes spherical as it I appear in (figure 1).

### Histological Finding:

**Proventriculus:** Four layers were seen in the francolin proventriculus wall. These layers were mucosa, submucosa, muscularis and serosa layers as it is clear in figures 2, 4, and 5.<sup>(15)</sup> and<sup>(16)</sup> have reported the same structures of proventriculus in *Struthiocamelus* and *Numidameleagris* respectively. Figure 2 reveals that mucosa of francolin consists of folds that are branched and longitudinal and lined with an epithelium that is simple columnar in nature. Infiltrated with lymphocytes and blood vessels, a loose connective tissue was the structure belongs to the lamina propria as it is obvious in figures (2, 3, and 6). Also it was seen that there is a simple mucous tubular gland possessed within the lamina propria as it is obvious in figures (2, 4, and 5). The mean of thickness of this tunic was 2332 mm in male francolin, whereas in the female was higher up to 2521 mm.

In the parrot, the proventriculus characterized by folded mucosa with the presence of surface invaginations of regular intervals (Fig. 2,3). Similar to that in francolin, the lining epithelium was simple columnar and the lamina propria possessed simple tubular mucosal glands lined with the same epithelial lining, invested in loose connective tissue rich with blood vessels. The mean of thickness of this tunic was 1258 mm in male parrot, whereas in the female was higher up to 1431 mm.

The presence of simple columnar epithelial lining of the mucosa in the studied birds were similar to mucosal lining of the most avian species<sup>(17)</sup>, guinea fowl<sup>(16)</sup> and pigeon<sup>(14)</sup>. Coming in line with what was reported by<sup>(18)</sup> and<sup>(19)</sup>, the francolin's and parrot's mucosal glands were lined with simple cuboidal epithelium. Figures 2, 4, and 5 reveal that most thickness of the organ is occupied by



submucosa. What is being called proventriculus glands, were seen forming it.

The current findings of proventriculus glands were not in line with those of <sup>(20)</sup> and <sup>(21)</sup> who reported the lack of submucosal glands in the proventriculi belonging to chicks. Other findings relating to francolin were not in line with what reported by <sup>(22)</sup> and <sup>(23)</sup> who made their studies in aves and gray parrot where the submucosa contains tubular glands of proventriculus which are surrounded by a fibrous tissue and they are round in shape found in dense connective tissue while the findings of the researchers above have mentioned the glands to be pearl in shape lined up with columnar epithelium.

The mean of thickness of this tunic was 9860  $\mu\text{m}$  and 9910  $\mu\text{m}$  in male and female francolin, respectively. Whereas, in parrot the mean of thickness of this tunic was 13256  $\mu\text{m}$  (in male) and 13588  $\mu\text{m}$  (in female). The increased size of this tunic occupied most of the real area of the proventriculus wall containing numerous deep proventricular glands. This finding was disagreed with <sup>(25)</sup> in the jungle fowl who mentioned that the tunica submucosa was very thin in the proventricular wall or poorly developed in birds.

The mean diameter mean of these glands were 4355  $\mu\text{m}$  in male francolin, whereas in the female was higher up to 4990  $\mu\text{m}$ . The mean of diameters of the submucosal glands were 3922  $\mu\text{m}$  and 3260  $\mu\text{m}$  in the male and female parrot, respectively.

The thickness mean of this tunic was 920  $\mu\text{m}$  in male francolin, whereas in the female was higher up to 1120 $\mu\text{m}$  and compared with parrot the mean of this tunic was 1120  $\mu\text{m}$  and 1130  $\mu\text{m}$  in male and female, respectively. Structures like adipose tissue, nerves, and blood vessels were the feature of serosa that was built up with loose connective tissue (Fig. 2,4,5). These findings were also observed by <sup>(12)</sup> in Japanese quail and <sup>(18)</sup> in Coot bird (*Fulica atra*). The mean of thickness of this tunic was 140  $\mu\text{m}$  and 160 $\mu\text{m}$  in the male and female francolin, respectively. While the thickness mean of this tunic was 170  $\mu\text{m}$  in male and female parrot.

**The ventriculus (Gizzard):** Figures (7, and 8) show the structure of this organ. Like other avian species, the structures of this organ was similar to those like red-capped cardinal and guinea fowl <sup>(5)</sup> and <sup>(16)</sup> respectively. The simple columnar cells lined the ventriculus in studied birds. Similar observations were recorded in other species for instance partridge <sup>(11)</sup>, Red

jungle fowl <sup>(25)</sup> and in the Blue and Yellow macaws <sup>(27)</sup>. This epithelium thrown into long folds in parrot (Fig. 7, 8) but not in francolin when they were parallel each to other and revealed between their bases the gastric pits which constitute more than the half of the mucosal thickness (Fig. 7). Mean of diameters belonging to these glands was 560.1  $\mu\text{m}$  in the male francolin, while in the female was higher up to 722.3 $\mu\text{m}$ . The means of glands diameters were 344  $\mu\text{m}$  and 321  $\mu\text{m}$  in male and female parrots, respectively.

Muscularis mucosa appeared as circularly arranged smooth muscle bundles interrupted by the presence of mucosal glands in the lamina propria in francolin (Fig. 8), but in parrot appeared thinner layer of circularly arranged smooth muscle fibers separating the mucosa from the underlying submucosa. (Fig. 7).

The mean thickness of this tunic was 1910  $\mu\text{m}$  and to 2100  $\mu\text{m}$  in male and female francolin, whereas in the female, it was higher up to 2100  $\mu\text{m}$ . In the parrot, the mean thickness of the mucosa was 2320  $\mu\text{m}$  and 2540  $\mu\text{m}$  in male and female, respectively.

Figures. 8, 9, and 10 reveal that the submucosa belonging to ventriculus is built up of vast dense connective tissue which is enriched with nerves and blood vessels. The mean of thickness of this tunic was 1280  $\mu\text{m}$  in male francolin, whereas in the female was higher up to 1410  $\mu\text{m}$ . But the thickness was higher in parrot in which the mean thickness of this tunica was 1820  $\mu\text{m}$  and 1580  $\mu\text{m}$  in male and female, respectively.

The above outcome agreed with those observed in the Red-Capped Cardinal (*Paroaria gularis gularis*)<sup>(8)</sup>, in most avian<sup>(29)</sup> and in Rock dove (*Columba livia*)<sup>(30)</sup>.

In the parrot, muscularis extera was formed by two thin layers of smooth muscle fibers. There were fine collagenous fibers distributed between the bundles of these smooth muscles (Fig. 7, and 9).

Three layers of muscles fibers existence in francolin were in line with the findings of<sup>(31)</sup> in the *Uroloncha domestica*<sup>(22)</sup> in the *Fulica armillata* (granivorous species) and<sup>(18)</sup> in the ventriculus of the red jungle fowl which is one of the seeds, fruits and insects eaters bird.

While the two layers of muscles fibers existence in the ventriculus of parrot was similar to the findings of<sup>(24),(25)</sup> and<sup>(32)</sup> in the organs belonging to red-capped cardinal, Coot bird and most avian species, respectively.

The thickness of this tunica was 11910µm 11840 µm in male and female francolin, respectively, but it was thinner in the parrotventriculus in which the mean thickness was 4410 µm and 4330 µm in male and female. The thickness of this layer in the ventriculus may concerned with mechanical grinding capability of the birds to the ingested food.

The microscopic examination of the serosa layer revealed similar structure of this tunic in the ventriculus of francolin and parrot. For instance, Ostrich<sup>(33)</sup>, and turkey<sup>(34)</sup> the structures also were seen. The mean of thickness of this tunic was 160 µm in both sex of francolin and 120 µm in both sexes of parrot.

**Histochemical Findings:** The stomach birds such as (proventriculus and ventriculus) were well studied histochemically by applying three stains: PAS, PAS-AB (pH 2.5) and PAS-AB (pH 1.0). These staining techniques were conducted to view the presence or absence of neutral mucins, acidic mucins and sulfated mucin respectively.

**Proventriculus:** The lamina propria extended between the gastric mucosal glands were moderately reacted with same stain. These findings were akin to those observed by<sup>(32)</sup> in the black-winged kite glandular stomach. The connective tissue and wall of blood vessels of submucosa and serosa give activist reaction with PAS and smooth muscle fiber in muscularis showed poor staining with PAS (Fig.6). Whereas,<sup>(16)</sup> has reported variant findings in guinea fowl proventriculus in which the submucosal glandular epithelium showed depressing reaction for mucins post staining with the PAS.

The strong PAS-positive reaction which observed in the francolin glandular stomach mucosa was noticed parrot mucous glands (Fig. 6) and such reaction was similarly documented in previous investigations such as<sup>(35)</sup> and<sup>(36)</sup>. Positive reaction toward PAS by the mucosal folds of the glandular stomach may have a

protective role in avoiding the effect of hydrochloric acid on the mucous membrane of the proventriculus<sup>(34)</sup>. Conversely to these findings in francolin and parrot, (Fig. 3, and 6).

The tunica muscularis showed mild reaction with the same stain, while the interspersed collagen fibers showed a moderate reaction in parrot, and francolin (Fig.3, and 6). The epithelium of the mucosal folds secreted acidic sulfated and neutral mucins which were well stained with the combined PAS-AB (pH 1) stain (Fig. 3, and 6). These findings agreed with<sup>(38)</sup> observations in the proventriculus lining of the domestic duck in which mucosal folds surface lining cells bestowed red and blue colors with the both parts of this combined stain, respectively.

By using combined PAS-AB (pH 1) on the sections of the proventriculus wall to differentiate the sulfated from non sulfated acidic mucins, positive materials were detected in the lumina of the mucosal glands, lining cells of the surface and the secretory duct of the submucosal glands. The reaction indicated the presence of sulfated and neutral mucopolysaccharides in the francolin and parrot proventricular surface epithelial cells (Fig. 3,6). The current responses of this combined stains were similar to the previous records of<sup>(40)</sup> in the francolin proventriculus glands which showed PAS positive reaction due to the presence of both acidic and neutral polysaccharides. However, strong reaction was observed in Alcian blue part of the stain in this bird.

**The ventriculus (Gizzard):** The wall prepared sections of the ventriculus that were stained by PAS-AB (pH 1) revealed positively blue and red colors in the epithelium and gastric glands of the mucosal layer in the studied birds because of the presence of the sulfated and neutral mucopolysaccharides, respectively.

The cuticle covering stained with PAS in francolin whereas, negatively did with that of parrot.

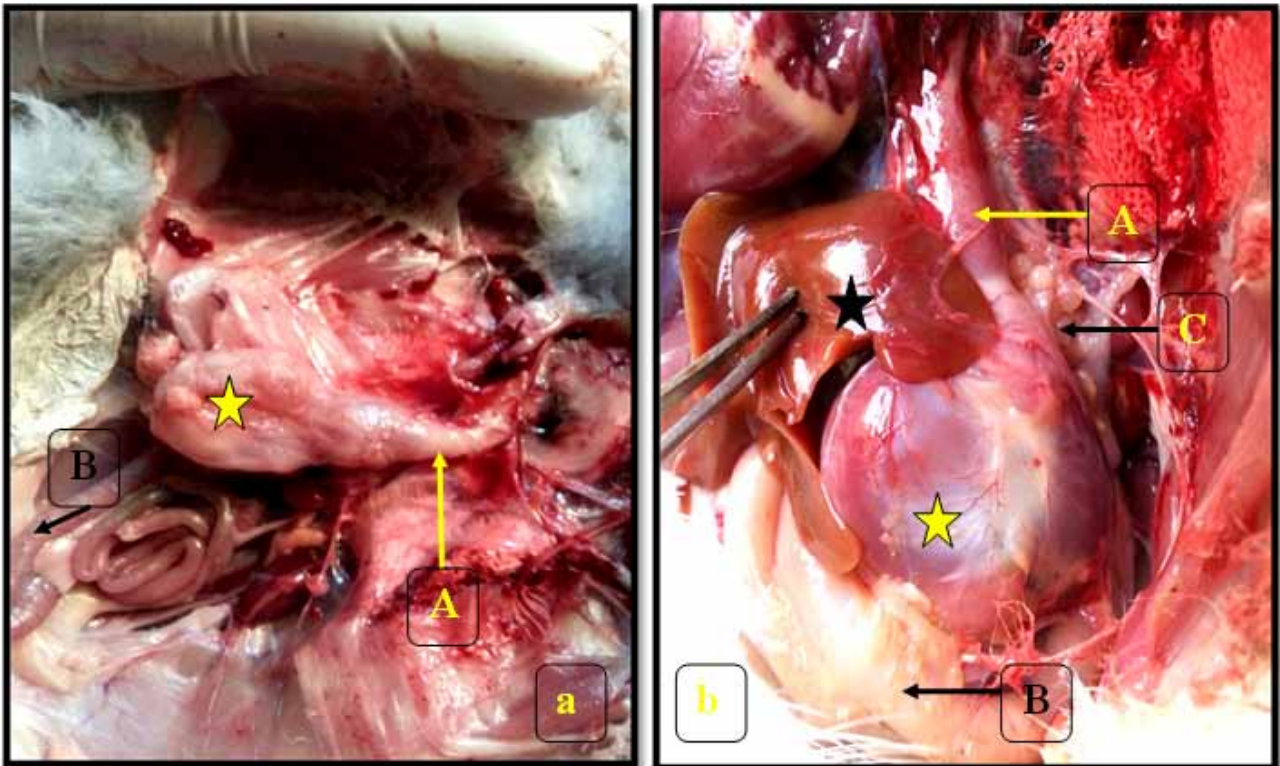


Fig. 1 . Visceral of abdomen showed: proventriculus (A), Ventricular (yellow star), Duodenum (B), Ovary (C), Liver (black star). parrot (a) and Francolin (b).

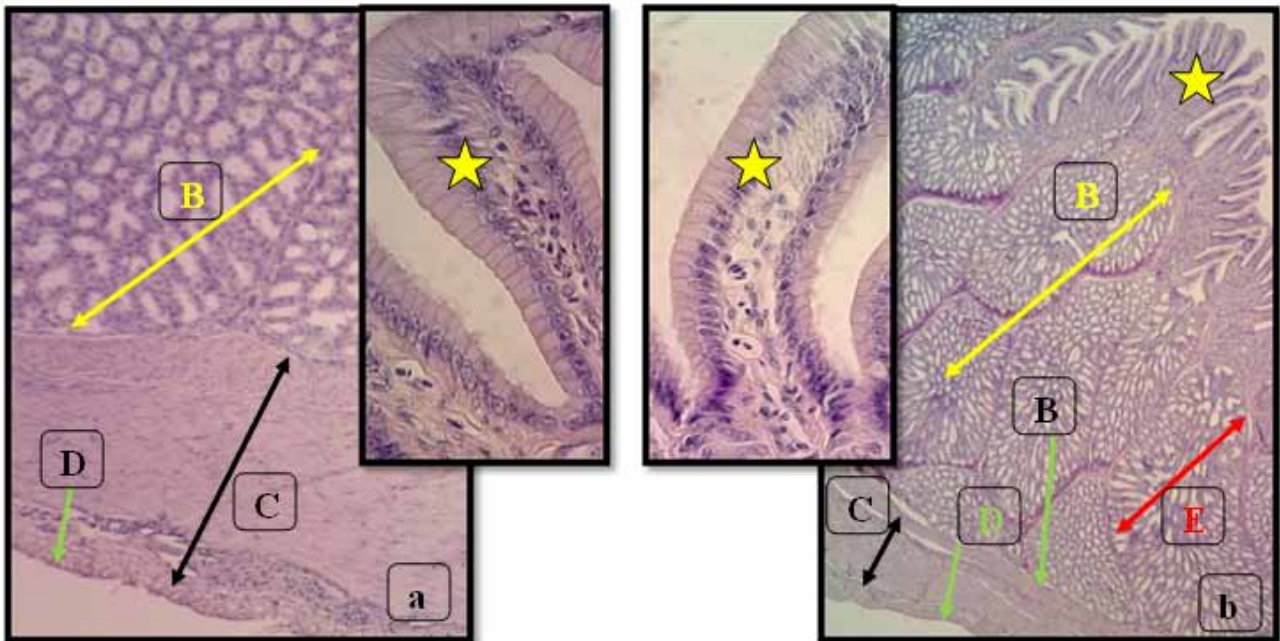
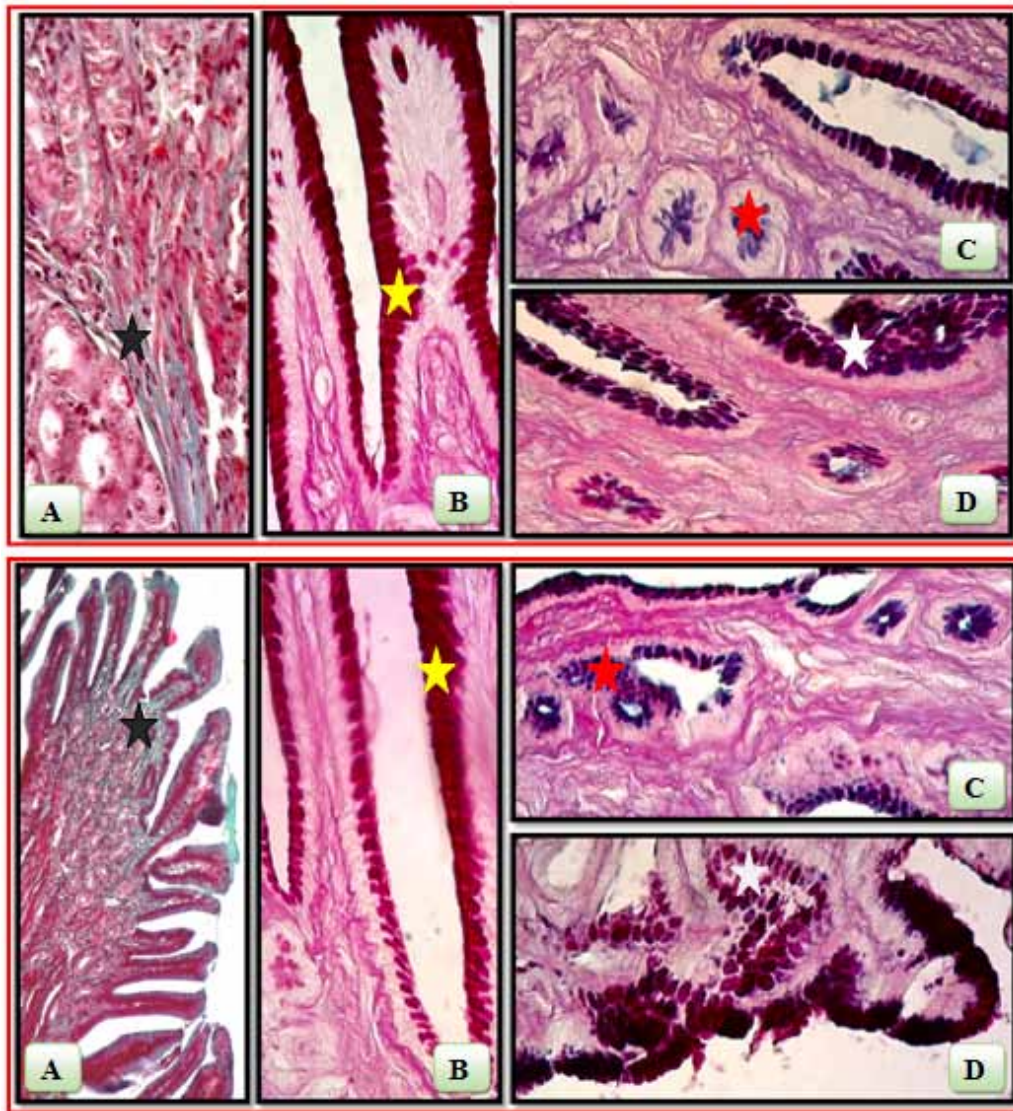
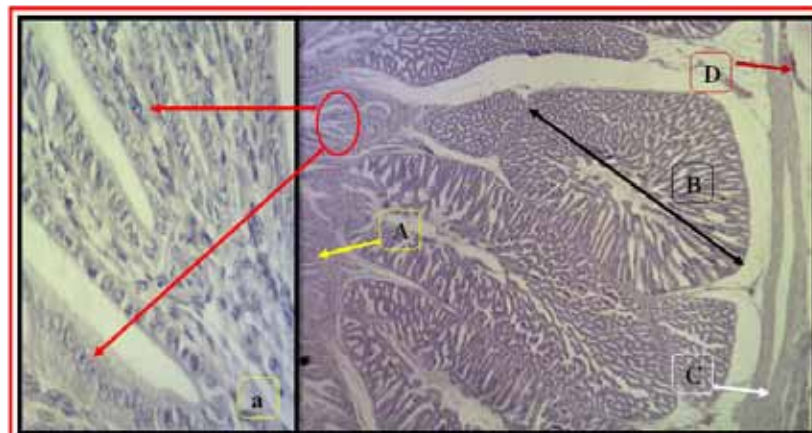


Fig. 2. Showed the proventriculus wall of parrot showed mucosa (yellow star), Submucosa (B), Muscularis (C), serosa (D) and proventricular gland (E), (yellow star) showed epithelial cells in mucosa. (a) Male X400, (b) Female X100 H & E stain.



**Fig. 3.** Showed the proventriculus wall of parrot Upper panel in male and Lower panel in female showed : Connective tissue (Black star) (A), Neutral mucin (Yellow star) (B), Neutral and sulfate mucin (Red star) (C) and Neutral and acid mucin (White star) (D). Masson's Trichrome (A), PAS (B), PAS+AB =pH 0.1 (C) and PAS+AB= 2.5 (D). X400



**Fig. 4.** Showed the proventriculus wall of male Francolin showed: mucosa (A), Submucosa (B), Muscularis (C), serosa (D), (a) showed epithelial cells in mucosa. H & E 400X

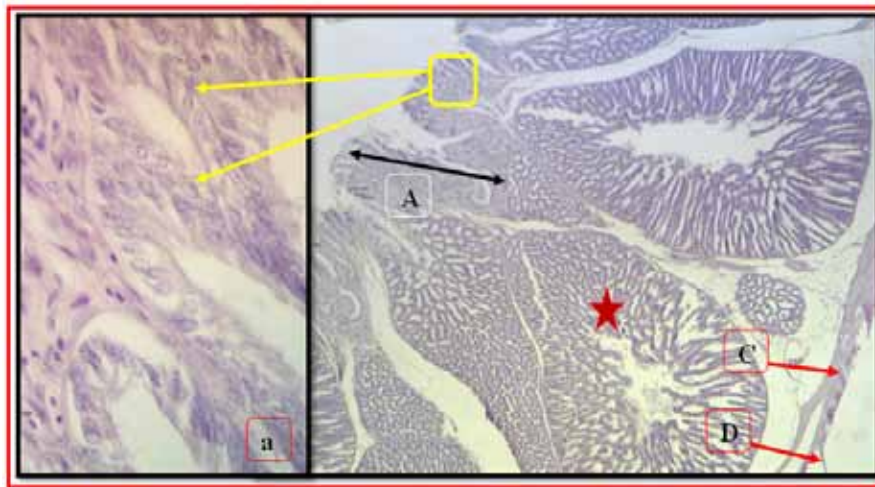


Fig. 5. Showed the proventriculus wall of female Francolin showed: mucosa (A), Submucosa (glands) (Red star), Muscularis (C), serosa (D), (a) showed epithelial cells in mucosa. H & E 400X

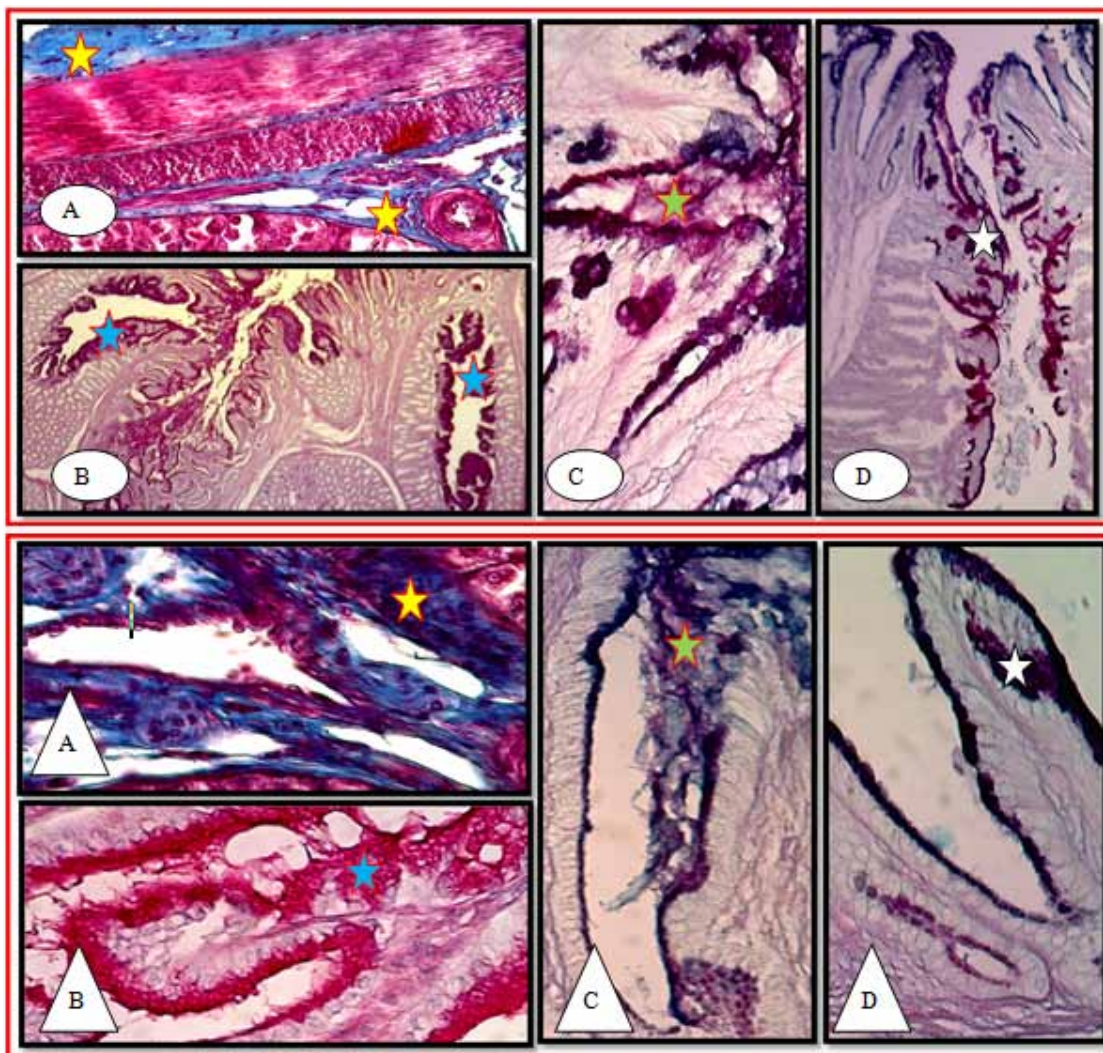


Figure (6). Francolin Proventriculus wall Upper panel in male and Lower panel in female showed : Connective tissue (Yellow star) (A), Neutral mucin (Blue star) (B), Neutral and sulfate mucin (Green star) (C) and Neutral and acid mucin (White star) (D). Masson's Trichrome (A), PAS (B), PAS+AB =pH 0.1 (C) and PAS+AB= 2.5 (D). X400

**Ethical Clearance:** The Research Ethical Committee at scientific research by ethical approval of both environmental and health and higher education and scientific research ministries in Iraq

**Conflict of Interest:** The authors declare that they have no conflict of interest.

**Funding:** Self-funding

## References

1. King AS, McLelland J. Birds, their structure and function. Bailliere Tindall, 1 St. Annes Road; 1984.
2. Bashir A.. Iraqi Birds. Alribat Press, Baghdad, Iraq, 1960.
3. Al-Saffar FJ. Histomorphological and histochemical study of stomach of domestic pigeon (*Columba livia domestica*). Iraqi Journal of Veterinary Medicine. 2016 Jun 5;40(1):89-96.
4. Ahmed YA, Kamel G, Ahmad AA. Histomorphological studies on the stomach of the Japanese quail. Asian Journal of Poultry Science. 2011;5(2):56-67.
5. Catroxo MH, Lima MA, Cappellaro CE. Histological aspects of the stomach (Proventriculus and gizzard) of the red-capped cardinal (*Paroaria gularis gularis*, Linnaeus, 1766). Revista chilena de anatomía. 1997;15(1):19-27.
6. Rossi JR, Baraldi-Artoni SM, Oliveira D, Cruz CD, Franzo VS, Sagula A. Morphology of glandular stomach (*Ventriculus glandularis*) and muscular stomach (*Ventriculus muscularis*) of the partridge *Rhynchotus rufescens*. *Ciência Rural*. 2005 Dec;35(6):1319-24.
7. Rebecca K. The digestive system of birds. 2002, 2(1):23-26.
8. Mitchell MA, Smith MW. The effects of genetic selection for increased growth rate on mucosal and muscle weights in the different regions of the small intestine of the domestic fowl (*Gallus domesticus*). *Comparative Biochemistry and Physiology Part A: Physiology*. 1991 Jan 1;99(1-2):251-8.
9. Bancroft JD, Gamble M, editors. Theory and practice of histological techniques. Elsevier health sciences; 2008.
10. Akester AR. Structure of the glandular layer and koilin membrane in the gizzard of the adult domestic fowl (*Gallus gallus domesticus*). *Journal of anatomy*. 1986 Aug;147:1
11. Rossi JR, Baraldi-Artoni SM, Oliveira D, Cruz CD, Franzo VS, Sagula A. Morphology of glandular stomach (*Ventriculus glandularis*) and muscular stomach (*Ventriculus muscularis*) of the partridge *Rhynchotus rufescens*. *Ciência Rural*. 2005 Dec; 35(6):1319-24.
12. Ahmed YA, Kamel G, Ahmad AA. Histomorphological studies on the stomach of the Japanese quail. *Asian Journal of Poultry Science*. 2011;5(2):56-67.
13. Hodges RD. The histology of the fowl. Academic Press.; 1974, pp. 35–88.
14. Al-Saffar FJ. Histomorphological and histochemical study of stomach of domestic pigeon (*Columba livia domestica*). *Iraqi Journal of Veterinary Medicine*. 2016 Jun 5;40(1):89-96.
15. Cooper RG and Mahroze K M. Histology and physiology of the gastrointestinal tract and growth curves of the ostrich (*Struthio camelus*). *Anim. Sci. J.*, 2004, 75: 491-498.
16. Selvan PS, Ushakumary S, Ramesh G. Studies on the histochemistry of the proventriculus and gizzard of post-hatch guinea fowl (*Numida meleagris*). *International Journal of Poultry Science*. 2008;7(11):1112-6.
17. Dellmann HD, Brown EM. Textbook of veterinary histology. Lea & Febiger.; 1976.
18. Batah AL, Selman HA. Histological study for stomach (proventriculus and gizzard) of coot bird *Fulica atra*. *Diyala Journal of Agricultural Sciences*. 2012;4(1):9-16.
19. Zaher M, El-Ghareeb AW, Hamdi H, AbuAmod F. Anatomical, histological and histochemical adaptations of the avian alimentary canal to their food habits: I-Coturnix coturnix. *Life Sci. J*. 2012 Jan 1;9(3):253-75.
20. Bradley OC, Grahame T. The structure of the fowl. 1960. pp 11.
21. King AS, McLelland J. Outlines of avian anatomy. Bailliere Tindall.; 1975. pp: 33-39.
22. Espinola LV and Galliussi EA. Estudio anatómico-histológico del tracto digestivo de *Fulica armillata* (Vellot, 1817) Aves (Gruiformes, Rallidae). *Iheringia Sér. Zool.*, 1990, 70: 93-108.
23. Rocha SO. Aspectos morfológicos (histológicos) do tubo digestivo da coruja-buraqueira *Speotyto*

- cunicularia, (Molina, 1782), São Paulo.1991, 73pp.
24. Catroxo MH, Lima MA, Cappellaro CE. Histological aspects of the stomach (Proventriculus and gizzard) of the red-capped cardinal (*Paroaria gularis gularis*, Linnaeus, 1766). *Revista chilena de anatomía*. 1997;15(1):19-27.
  25. Kadhim KK, Zuki AB, Noordin MM, Babjee SM, Zamri-Saad M. Activities of amylase, trypsin and chymotrypsin of pancreas and small intestinal contents in the red jungle fowl and broiler breed. *African Journal of Biotechnology*. 2011;10(1):108-15.
  26. Denbow DM. Gastrointestinal anatomy and physiology. In *Sturkie's avian physiology 2015* Jan 1 (pp. 337-366). Academic Press.
  27. Rodrigues MN, Abreu JA, Tivane C, Wagner PG, Campos DB, Guerra RR, Rici RE, Miglino MA. Microscopical study of the digestive tract of Blue and Yellow macaws. *Current microscopy contributions to advances in science and technology* (A. Méndez-Vilas, Ed.). 2012:414-21.
  28. Bailey TA, MENSAH-BROWN EP, Samour JH, Naldo J, Lawrence P, Garner A. Comparative morphology of the alimentary tract and its glandular derivatives of captive bustards. *Journal of Anatomy*. 1997 Oct;191(3):387-98.
  29. Banks WJ. *Applied Veterinary Histology*. Mosby-Year Book. Inc. St. Louis.(3rd). 1993:469-70.
  30. Albideri AW, Haba MK, Kadum MJ. Histological study of gastrointestinal tract in Squacco heron *Ardeola ralloides* and Rock dove *Columba livia*. Al-Kufa University. *Journal of Biology*. 2011;2(3):99-108.
  31. IMAI M, SHIBATA T, MORIGUCHI K, YAMAMOTO M, HAYAMA H. Proventricular glands in fowl. *Okajimas folia anatomica Japonica*. 1991;68(2-3):155-60.
  32. Hamdi H, El-Ghareeb AW, Zaher M, AbuAmod F. Anatomical, histological and histochemical adaptations of the avian alimentary canal to their food habits: II-*Elanus caeruleus*. *Int. J. Sci. & Engineering Research*. 2013 Oct;4(10):1355-64.
  33. Bezuidenhout AJ, Van Aswegen G. A light microscopic and immunocytochemical study of the gastro-intestinal tract of the ostrich (*Struthio camelus* L.). *Onderstepoort J. Veter. Rese.*, 1990, vol. 57(1): 37-48.
  34. El-Zoghby IA. Histological and histochemical studies on the digestive tract of the turkeys at different ages (Doctoral dissertation, PhD Thesis, Benha University, Egypt).2000,pp 23.
  35. El-Banhawy M, Mohallal ME, Rahmy TR, Moawad TI. A comparative histochemical study on the proventriculus and ileum of two birds with different feeding habits. *Journal of the Egyptian German Society Zoology*. 1993;11:155-74.
  36. Hamdi H, El-Ghareeb AW, Zaher M, AbuAmod F. Anatomical, histological and histochemical adaptations of the avian alimentary canal to their food habits: II-*Elanus caeruleus*. *Int. J. Sci. & Engineering Research*. 2013 Oct;4(10):1355-64.
  37. Mogil'naia GM. Histochemical characteristics of the epitheliocytes of the avian glandular stomach. *Arkhiv anatomii, gistologii i embriologii*. 1983 Jun;84(6):62.
  38. Prasad RV, Kakade K. Histology and histochemistry of proventriculus of domestic duck (*Anas platyrhynchos* Linnaeus). *Mysore Journal of Agricultural Sciences*. 1990;25(4):506-11.
  39. Shyla P, Ommer PA, Lucy P. Structure and post-natal development of the proventriculus in the duck. *Ind. J. Poultry. Sci*. 1992;27:10-4.
  40. de Lima MA, da Silva Sasso W. Histochemical detection of glycoproteins in the gastric epithelia of *Columba livia*. *Acta Histochemica*. 1985 Jan 1;76(2):145-IN1.

# Salivary Sialic Acid Level and Oral Health Statues in Sample of Iraqi Children

Lamia I. Sood<sup>1</sup>, Ameena Ryhan Diajil<sup>2</sup>

<sup>1</sup>Assist. Prof., Department of Pop, College of Dentistry, University of Al-Anbar,

<sup>2</sup>Assist. Prof. Department of Oral Diagnosis, Oral Medicine, College of Dentistry, University of Baghdad

## Abstract

**Background:** Saliva is the 1<sup>st</sup> defense fluid with sialic acid is a significant salivary biomarker. It is an acidic sugar with a nine-carbon backbone, able to mediate a wide variety of patho- physiological processes. the study aims at estimate salivary sialic acid in Iraqi children sample and also find out their association with oral health status.

**Method:** Unstimulated salivary samples were collected from 100 healthy child, aged 6-13 years for 5-minutes, between 9:00 - 11:00 A.M. gingival index(GI) and Plaque index were measured . According to WHO criteria,the dentition status was examined by dmfs, dmft,DMFS and DMFT. Also, flow rate and the level of salivary sialic acid were estimated.

**Results:** In the present study,a positive correlation coefficient is recorded between the salivary flow rate and age and statistically reach the level of significance. Sialic acid concentration increased with age, but did not reach the level of significant.

A male gender showed increase salivary sialic acid level by 0.2 U/L compared to female, but fail to reach the significance

GI and DMFs showed a positive association with sialic acid level ( $R=0.036, R= 0.0053$ ),but it's not reach the significant. While sialic acid level observed that a significant weak inverse liner correlation with other variables like DMFS and PI, ( $R=- 0.082, R=-0.066$ )

The outcomes were exposed to t-test and Pearson's correlation coefficient, Plaque index, GI, flow rate and the dental caries status were significantly positive correlated with the sialic acid levels in saliva.

**Conclusion:** The salivary factors evaluated in this study may prove to be useful measures for gingival inflammation in children and allow pediatric dentists to target preventive measures appropriately.

**Keywords:** Oral health status, Salivary sialic acid, flow rate, dentition statues, children, Iraq.

## Introduction

Sialic acid found in fluid and body tissue,it's are group of monosaccharide that normally occurs at end of sugar chains and its attached to soluble proteins and the surface of cell <sup>(1)</sup>. The level of Sialic acid takes part in various physiological functions, such as cell-to-cell interactions, cell migration, and proliferation<sup>(2)</sup>. S.A interfere between the pathogenic microorganism and host and the important function to regulate the innate immunity.<sup>(3)</sup>

Terminal sialic acid removed, either by enzyme of virulent bacteria (*neuraminidase*) or by inherited disorder *endogenous neuraminidase* of host from sialylated glycoprotein, its could fuse onto the developing plaque surface, playing a role in plaque formation leading to the decimation of host tissue<sup>(4)</sup>. It has been reported that SA is associated with several acute phase proteins that associated with periodontitis<sup>(5)</sup>.

Till date, there is next to no information with respect to synchronous examination and measured of salivary SA level of children and oral health status.



The current investigation was along these lines attempted with a point, to not just evaluate the level of SA in saliva of children and also find out their association with oral health status.

**Material and Method**

Unstimulated salivary samples were collected from 100 healthy child, aged 6-13 years for 5-minutes, between 9:00 - 11:00 A.M. a special forma “structured questionnaire” that was conveyed in Arabic language and sent to the student family.

**This forma consisted of two parts:**

**1<sup>st</sup> Part:** Demography of primary school student

**2<sup>nd</sup> Part:** Clinical oral examination which was measured by PI, GI and CI according WHO criteria.

Ethics committee of the present study was approved by collage of dentistry, university of Baghdad

Exclusion criteria were, children having limitation in opening of the mouth, children with orthodontic appliances, children with any systemic disease and who had taken drug (antibiotics) in the last month

After oral examination, unstimulated whole saliva samples from each child are collected at least one hour after breakfast between 9-11 A.M, After the collection

and disappearance of salivary froth. Salivary volume is estimated with a measuring sterile test tubes under the standard conditions over 5 minutes. And the rate of secretion was expressed as millilitres per minutes (ml/min)<sup>(6)</sup>.

The sialic acid level measured by Using EnzyChrom™ Sialic Acid Assay Kit (USA), The kit utilizes an enzyme coupled reaction in which free sialic acid is oxidized resulting in development of the OxiRed probe to give fluorescence Ex/Em = 535/587 nm and absorbance OD = 570 nm. The sialic acid kit measures in the linear range of 0.1 - 10 nmol with a detection sensitivity ~ 1 Mm concentration

**Statistical Analysis:** The data were analysis statically by using SPSS version 19.0. Descriptive analysis, analysis of variance, student T-test, linear correlation and multiple linear regression model were used in this present study. The analysis is expected to be p< 0.05 as the limit of significance

**Results**

One-hundred student are involved in the present study with an age ranging from 6- 13 years old, males represent 46% while 54 % were females.

The primary school student distributed in to 4 group : 6-7, 8-9, 10-11 and 12-13 years old

**Table 1: Salivary sialic acid mean**

	Salivary Sialic Acid					
	Range	Mean	SD	SE	N	P
<b>Oral hygiene status(PI index)</b>						
- Mild range from (0.1 -1)	(56.7-58.2)	57.5	1.1	.8	2	0.14[NS]
- Moderate range from (1.1- 2)	(54.9-72.4)	62.4	4.9	.6	59	
- Severe range from(2.1- 3)	(55-69.5)	61.1	4.1	.6	45	
<b>Gingival index</b>						
- Mild (0.1 -1)	(54.9-72.4)	61.5	4.8	.8	36	0.65[NS]
- Moderate (1.1-2)	(55.1-72.2)	61.9	4.5	.5	70	
<b>Age group (years)</b>						
6-7	(56-72.2)	62.4	4.9	1.0	23	0.81[NS]
8-9	(55.1-72.4)	61.7	4.7	.8	35	
10-11	(55-70.8)	61.8	4.5	.8	33	
12-13	(54.9-69.5)	60.9	4.4	1.1	15	

	Salivary Sialic Acid					
	Range	Mean	SD	SE	N	P
<b>Flow rate - categories</b>						
1st (lowest) tertile (<= 1.00)	(55.1-70.2)	62.0	4.2	.6	50	0.63[NS]
2nd (average) tertile (1.01 - 2.00)	(56-72.4)	62.3	4.9	1.0	27	
3th (highest) tertile (2.01+)	(54.9-72.2)	61.2	5.0	1.0	26	
<b>DMFs-categories</b>						
First (lowest) tertile (<= 2)	(54.9-71.6)	61.1	4.3	.7	38	0.47[NS]
Second (average) tertile (3 - 7)	(55.1-72.4)	62.4	5.0	.8	36	
Third (highest) tertile (8+)	(55.1-72.2)	61.7	4.5	.8	33	
<b>DMFS-categories</b>						
First (lowest) tertile (0)	(55.1-72.4)	62.0	4.9	.6	60	0.43[NS]
Second (average) tertile (1)	(56-72.2)	62.9	5.1	1.5	11	
Third (highest) tertile (2+)	(54.9-70.8)	61.1	3.9	.6	36	

As seen in table (1), the unstimulated salivary flow rate ranged from 2.00 ml/min for the highest rate and 0.04 ml/min for the lowest mean rate.

Salivary flow-rate mean for males range from 0.16-0.1 ml/minute as well as female range from 0.01-1.2 ml/minute. In addition to that, salivary flow rate mean of the female

0.322 ml/min is obviously lower than the male 0.431 ml/min, however, the mean difference were unable to reach the level of significance.

Table(2)shows the correlation between sialic acid and study parameters.

A positive strong correlation recorded between flow rate in children and dental age (r = 0.400).

On other hand .there was a statistically a significant correlation between the salivary S.A and GI(p=0.04).

It is obviously noted from table (2) that children suffered from mild gingivitis recorded with lower salivary S.A mean 61.5 u\l compared to those with moderate gingivitis 61.9 u\l and the differences between the numerical value are non-significant when tested statistically

**Table 2: Linear correlation coefficient between salivary sialic acid and oral paramater**

	Sialic acid level (saliva)
Salivary flow rate	R = - 0.104 p= 0.3 [NS]
PI	R = - 0.066 p = 0.5 [NS]
GI	R = 0.036 p = 0.71 [NS]
CI	R = 0 p< 0.001
DMFs	R = 0.053 p = 0.59 [NS]
Ms	R = 0.016 p = 0.87 S]
Fs	R = 0.013 p = 0.89 [NS]
Ds	R = 0.057 p = 0.56 S]
DMFS	R = - 0.082 p = 0.4 [NS]
MS	R = - 0.122 p = 0.21 S]
FS	R = - 0.197 p = 0.042
DS	R = - 0.015 p = 0.88 S]
Age	R = - 0.066 p = 0.5 [NS]

Caries experience presented by DMFS (Decayed-Missing-Filled- Surfaces),

Table (1) shows the distribution of the data according to the severity of DMFS in to lowest, average and highest.

Statistically, a significant inverse correlation between the DMFS and salivary sialic acid  $R = -0.082$  ( $P < 0.001$ )

Children of high salivary S.A mean had higher DMFS in second (average) 62.9 u/l and its decreased to reach 62.0 u/l at the first (lowest) DMFS and 61.1 u/l at the third (highest) DMFS, but there was non-significant difference between salivary S.A and DMFS,  $p > 0.001$

As seen in figure (1), the mean sialic acid level was lowest (69.9 u/l) in age group range from 12-13 years, and increase to reach the maximum S.A mean 62.4 at age group range from 6-7 years .but the difference did not reach the level of significant. For each one year increase in age, the S.A level expected to increase by average of -0.117 unit.

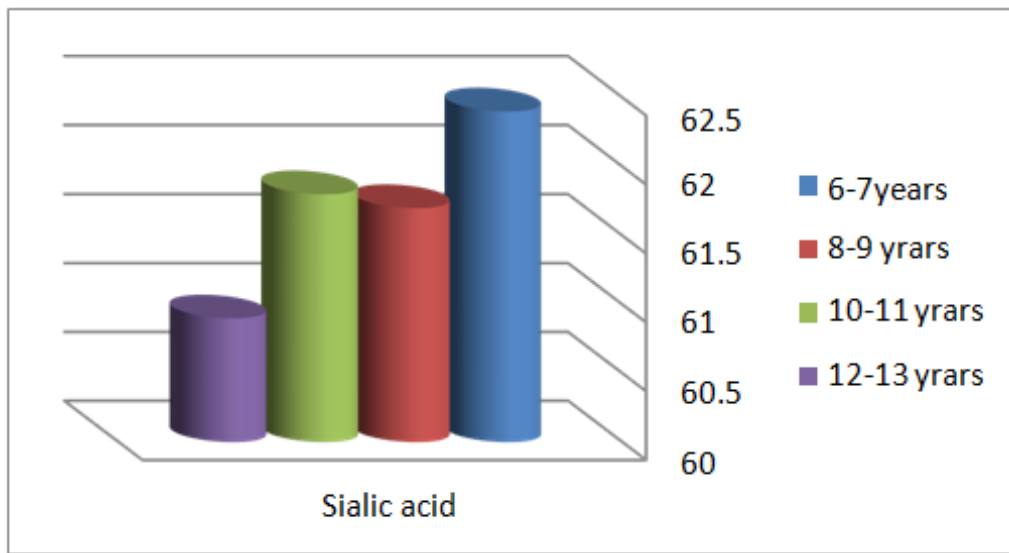


Figure (1): Salivary sialic acid level and age group.

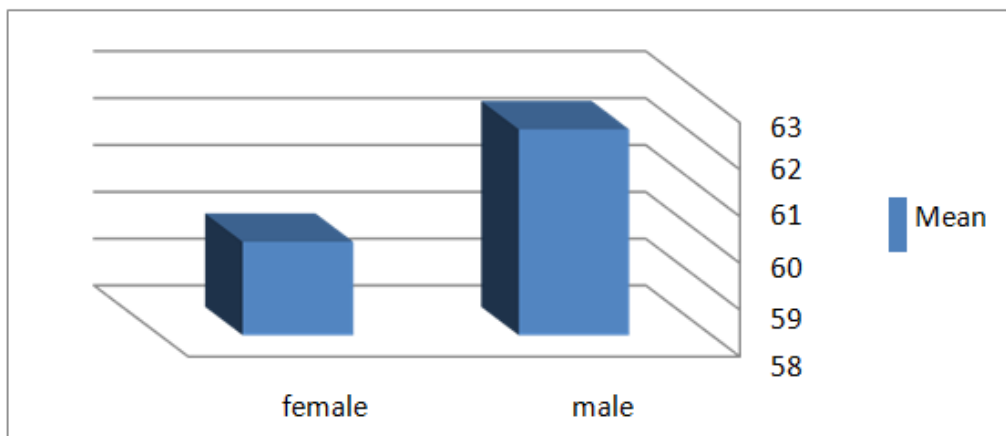


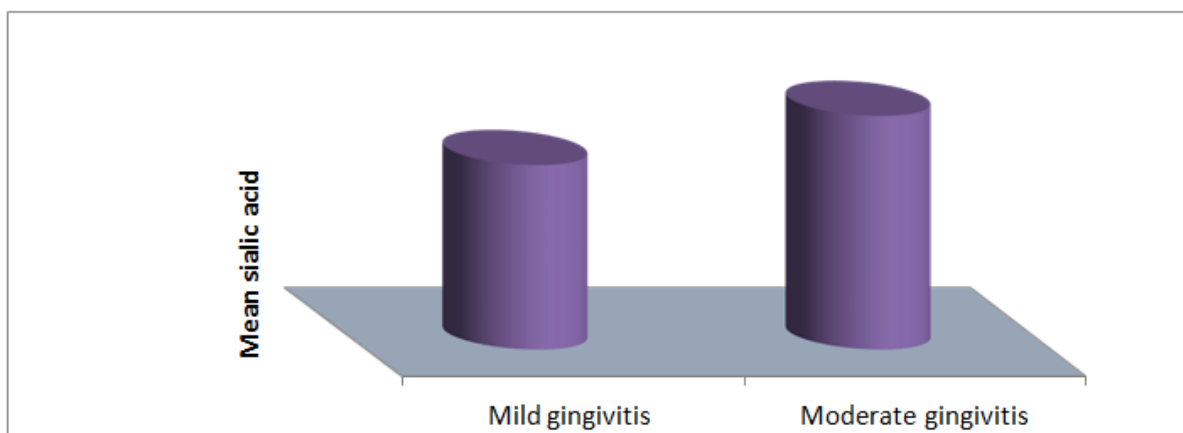
Figure (2): Gender and salivary sialic acid

When comparing salivary S.A mean of the two group, it's found that females are shown to be lower but statistically non-significant as compared to male ( $p > 0.001$ ) as in figure (2).

Table (1) shows the plaque index classified into mild, moderate and severe index

The majority the student were with moderate pl mean score (62.4), followed with severe (61.1) and just 57.5 of mild score .

Although, mean sialic acid level was higher in student with moderate PI index, statistically failed to reach the level of significant differences between different group of plaque indices.



**Figure (3): severity of GI in relation to salivary sialic acid mean**

Figure (3), shows the GI distributed in to mild and sever gingivitis, with the majority of the student within moderate gingivitis

A multiple linear regression model was performed to evaluate both independent and the net association of the explanatory variables of sialic acid. These variables include: age,gender, salivary flow rate,PLI, GI,, decayed primary and permanent teeth surfaces of the participants.

As shown in table (3), the regression analysis showed that being a male is expected to increase the level of salivary sialic acid by a mean of 0.2 U/L compared to female after adjusting for the possible confounder effect of the other explanatory variables involved in this regression model. However, the effect of gender was unable to reach the statistical significance may be due to a small s sample size.

**Table 3: Multiple linear regression model of salivary Sialic acid with other variables.**

	Partial egression oefficient	P	Standardized regression coefficient
Constant.	62.2	< 0.001	
Plaque index.	-0.3	0.82 Non-ificant	- 0.025
Gingival index.	2.2	0.56 Non-ificant	0.065
Salivary flow rate.	-0.25	0.57 Non-ificant	- 0.063
DS.	-0.02	0.8 Non-ificant	-0.026
Ds.	-0.04	0.9 Non-ificant	-0.016
Age (years).	-0.117	0.7 Non-ificant	-0.051
Male gender compared to females	0.2	0.85 Non-ificant	0.021

$R^2 = 0.032$ ,  $P(\text{Model}) = 0.96[\text{NS}]$

As shown in table 3, the regression model trying to explain the changes in salivary sialic acid was not significant statistically and failed to detect any important or statistically significant association for any of the tested explanatory variables with the outcome variable.

Gingival index and DMFs were positively correlation with sialic acid ( $r=0.036$ ,  $r=0.053$  (respectively, however fail to reach significance.

### Discussion

In present study, SA levels was estimated in salivary samples of primary school students, however, up to our knowledge, no previous studies were found to measure the level of salivary sialic acid in Iraqi children.

The was a negative relation between the age and SA, which agrees with Kuyatt and Baum<sup>(7)</sup> who found

a significant age related decrease in sialic acid level<sup>(7)</sup>. The older age group in this study (12-13 years) showed higher percent with teeth missing; that had a negative correlation with sialic acid level. This may be explained by negative correlation between free sialic acid and age in relation to missing teeth with less bacterial infection compared with lower percent of teeth missing.

Also, this agrees with Närhi et al<sup>(8)</sup>, who mentioned that defense mechanism factors which were derived from gingival crevicular fluid were diminished in the absence of teeth<sup>8</sup>.

Relation between salivary sialic acid, Plaque and gingival index

The results found a positive correlation between the salivary SA and gingivitis in children. This result is with a line of the result obtained by pervious studies performed by Jawazaly et al<sup>(9)</sup>. They discovered a significant relationship between gingivitis and

salivary SA<sup>(9)</sup>. In periodontal diseases, The increase in SA level may be result from raise in sialidase action<sup>(10)</sup>.

Salivary Sialic acid are clearly increase to the individuals with gingival disease, its plays very important role in immunesystem .statistically a significant relationship between the salivary S.A and gingival condition ..

Considering, caries which is a multifactorial in aetiology, increase in caries activity (severity) may be explain by compination of several factores including bacteria, diet

,time and host and oral hygiene .thus, the physiology, composition and flow rate of saliva is the important parameter affecting dental caries susceptibility and altering oral health statues.

The greater part of the proteins in the saliva its glycoprotein, S.A is one of the important structure of salivary glycoprotein that participating in the plaque and acquired pellicle formation in the oral cavity as well as improving bacterial aggregation<sup>(12)</sup>.

Salivary sialic acid level would influenced by oral infections<sup>(13,14)</sup>. more recently, it has need been accounted that salivary sialic acid level increase with salivary oxidative anxiety<sup>(15)</sup>.

**Ethical Clearance:** The Research Ethical Committee at scientific research by ethical approval of

both environmental and health and higher education and scientific research ministries in Iraq

**Conflict of Interest:** The authors declare that they have no conflict of interest.

**Funding:** Self-funding

## Reference

1. Wang B, Brand-Miller J. The role and potential of sialic acid in human nutrition. *Eur J Clin Nutr*, 2003;57:1351-69.
2. Schauer R : Sialic acids and their role as biological masks. *Trends Biochem Sci* 1985; 10:357-60
3. Severi E, Hood DW, Thomas GH, Sialic acid utilization by bacteria pathogens,. *microbiology*, 2007;153(9);2817-22
4. Critchley P, Wood JM, Saxton CA, Leach SA . The Polymerisation of Dietary ars by Dental Plaque. *Caries Res*.1967; 1 : 112 – 29.
5. Ide M, McPartin D, Coward PY, Crook M, Lumb P, Wilson RF. Effect of tment of chronic periodontitis on levels of serum markers of acute phase ammatory and vascular responses .*J Clin Periodontol*. 2003; 30 : 334 – 40.
6. Tenovuo J, Lagerlof F. Saliva in: Thyistrup A, Fejerskov Text book of clinical ology. 2nd ed. openhagen: Munksgaard; 1996.
7. Brian L Kuyatt and Bruce J Baum. Characteristic of submandibular glands from ng and aged rats. *J Den Res* 1981; 60(5): 936-941
8. Närhi O T, Tenovuo J, Ainamo A, Vija P. Antimicrobial factors, sialic acid, and en concentration in whole saliva of the elderly. *Eur J Oral sci* 2007; 102(2): 120-
9. Jawzaly JI, Hasan HG, Ahmed B M. Relationships of salivary sialic acid and its tion in periodontitis with demographic properties and medical history. *rnational Journal of Dental Research & Development (IJDRD)* 2013;3(2):17–26.
10. Shetty PK, Pattabiraman TN. Salivary glycoproteins as indicators of oral ases. *Indian J Clin Biochem*. 2004;19:97–101.
11. Selwitz RH, Ismail AI, Pitts NB. Dental caries. *Lancet* 2007; 369: 51-59.
12. Rudney JD. Does variability in salivary protein concentrations influence oral robial ecology and oral health? *Crit Rev Oral Biol Med* 1995; 6: 343-367.

13. Eggers Lura H. An investigation into the relation between the sialic acid of va and dental caries. *Arch Oral Biol* 1961; 4: 141-146.
14. Shinohara M, Ohura K, Ogata K, Inoue H, Miyata T, Yoshioka M. The tionship between the sialic acid concentrations in the serum and whole saliva in with naturally occurring gingivitis. *Jpn J Pharmacol* 1994; 64: 61-63.
15. Cavas L, Arpinar P, Yurdakoc K. Possible interactions between antioxidant ymes and free sialic acids in saliva: a preliminary study on elite judoists. *Int J rts Med* 2005; 26: 832-835.

# Hypolipidemic and Antioxidant Efficacy of Apigenin in Hydrogen Peroxide induced Oxidative Stress in Adult Male Rats

Mohammed I. Al-Rawi<sup>1</sup>, Aous Kahtan Almzaian<sup>1</sup>, Kahtan A. Almzaian<sup>2</sup>

<sup>1</sup>Lecturer, <sup>2</sup>Prof., Physiology & Pharmacology Department, College of Medicine, Iraqi Center for Cancer and Medical Genetic Research Mustansiriyah University Medical Lab. Tech. Department, Dijlah University College

## Abstract

This study was conducted to assess the role of apigenin extracted from parsley seeds either in glycosidic (aqueous extract) or aglycone forms (organic solvent extract), comparing to butylated hydroxyl toluene (BHT) in serum lipid profile and brain tissue peroxidation in H<sub>2</sub>O<sub>2</sub> induced oxidative stress adult male rats.

The yield of crude flavonoids from parsley seeds was found to be approximately 2.65% and thin layer chromatography techniques confirmed that apigenin is the main flavonoid with RF similar to that of the standard apigenin.

Experimentally induction of oxidative stress in male rats by 0.75% H<sub>2</sub>O<sub>2</sub> in drinking water for eight weeks showed a significant alterations in normal serum lipid profile manifested by significant elevation ( $p < 0.05$ ) in total cholesterol, Triacycle glycerol (TAG), Low density lipoprotein-Cholestrol (LDL-C) and Very low density lipoprotein-Cholestrol (VLDL-C) and a significant decrease in High density lipoprotein-Cholestrol (HDL-C) as compared to the control and BHT treated groups. On the other hand, daily oral administration of apigenin in a dose of 150 mg/Kg B.W. to H<sub>2</sub>O<sub>2</sub> treated groups were caused a significant correction of the lipid profile parameters.

Examination of brain tissues of H<sub>2</sub>O<sub>2</sub> and apigenin concurrent H<sub>2</sub>O<sub>2</sub> treated rats showed a significant decrease ( $p < 0.05$ ) in brain tissue malondialdehyde (MDA) and significant elevation in catalase and cholinesterase activities in apigenin and BHT treated groups comparing with H<sub>2</sub>O<sub>2</sub> treated and control groups.

**Keywords:** Hypolipidemic, Antioxidant, Apigenin, Hydrogen Peroxide,, Oxidative Stress, Rats.

## Introduction

Recent attention has been given to the influence of dietary factors on health and mental well-being<sup>(1)</sup>. There are convincing evidences that the oxidative stress and reactive oxygen species (ROS) play an important role in the etiology and/or progression of a number of human diseases<sup>(2)</sup>. It is known that oxidative stress is associated with many diseases including neurodegenerative disorders.

Many factors contribute to the degeneration of neural cells, leading to functional deterioration of neural cells, leading to functional deterioration of neurons and neurodegenerative disorders. Hence, because of their high metabolic activities and low antioxidant

defense capacities, neural cells in brain are more vulnerable to oxidative stress<sup>(3)</sup>. In addition, hydrogen peroxide is produced in  $\beta$ -amyloid (A $\beta$ ) aggregation, dopamine oxidation, and brain ischemia/reperfusion, AB aggregation is known to cause oxidative damage in neurons, including protein and lipid oxidation and DNA damage<sup>(4)</sup>.

The main class of natural antioxidants is exerting cardioprotective, chemopreventive, and neuroprotective effects. The biological activities of flavonoids have been attributed to their antioxidant, anti-inflammatory, anticancer, neuroprotective and signaling properties<sup>(1,5)</sup>. A clear understanding of the mechanisms of action, as either antioxidants or signaling molecules, is crucial for the application of flavonoids as interventions in

neurodegeneration and as brain foods<sup>(6)</sup>. Some flavonoids (like apigenin) can also traverse the blood-brain barrier; hence they are promising candidates for intervention in neurodegeneration and as constituents in brain foods<sup>(7)</sup>.

Apigenin (4, 5, 7 - trihydroxyflavone) is a dietary flavonoid commonly found in many fruits and vegetables<sup>(8)</sup>. It has been found that apigenin inhibits tumor growth and angiogenesis agent induced by different cancer cells<sup>(9)</sup>.

However, the role of apigenin as antioxidant and in neuroprotection is not so clear therefor, this study was conducted in order to investigate the following:

1. Extraction of apigenin from parsley seeds and conformation of the structural components using (TLC) in comparison with standard apigenin.
2. Assessment the role of apigenin as either Glycoside and/or Aglycone in serum lipid profile and brain lipid peroxidation in oxidative stress male rats.

## Materials and Method

Parsley seeds were obtained from commercial sources (Baghdad) and the vouchers specimen of the plant were deposited to be identified and authenticated at the National Herbarium of Iraq botany directorate in Abu-Ghraib under scientific name *petrselinumsativum* belongs to the family umbilifera. After cleaning and milling crushed seed was kept in dark and dry place.

The method of Harborne<sup>(10)</sup> modified by Al-Kawary<sup>(11)</sup> was used for the extraction of apigenin in aglycone form, while the method of Ikhan<sup>(12)</sup> was used for apigenin extraction in Glycoside form.

Thin layer chromatography on Silica gel type G aluminum plates (20 x 20 cm) at a thickness of 0.25 mm supplied from Fluka Company was used for the identification of apigenin either in Aglycone or Glycosidic form. Toluene: ethyl-acetate: acetic acid (36:12:5) was used as mobile phase<sup>(13)</sup> and UV detector to explore the spots on 254nm.

Fifty adult male Albino Wister rats weights (250-300) gm, 10-12 weeks of age were randomly divided into five groups; Group (c), Rats of this group were allowed to ad libitum supply of drinking water and served as a negative control group. Group (T1), rats were allowed to 0.75% H<sub>2</sub>O<sub>2</sub> in drinking water and served as a positive control group. Group (T2) rats, were allowed to 0.75% H<sub>2</sub>O<sub>2</sub> plus daily oral administration of BHT, 25 mg/kg

B.W.<sup>(14)</sup>, using gavage needle. Group (T3) rats were allowed to 0.75% H<sub>2</sub>O<sub>2</sub> + 150 mg/kg B.W of apigenin in glycosidic form. Group (T4) rats were allowed to 0.75% H<sub>2</sub>O<sub>2</sub> + 150 mg/kg B.W of apigenin as Aglycone.

Blood and brain tissue samples were collected after four and eight weeks of experimental period, five animals from each group were sacrificed for blood and brain tissue analysis, immediately after blood collection, each animal was killed and the head was separated and quickly preserved in liquid nitrogen until analysis.

Serum samples were used for the measurement of total cholesterol according to<sup>(15)</sup> using Randox assay kit. Triacylglycerol using Biomerieux kit<sup>(16)</sup>. High density lipoprotein (HDL-C) measured enzymatically using linear enzymatic Kit (Linear chemicals, Barcelona, Spain).

Serum low density lipoprotein cholesterol (LDL-C) and VLDL-C were calculated according to<sup>(17)</sup>.

Brain tissue samples were used for the measurement of cholinesterase activity according to<sup>(18)</sup>, catalase activity according to<sup>(19)</sup> and malondialdehyde concentration<sup>(20)</sup>.

Statistical analysis of data was performed of two way analysis of variance (ANOVA) using significant level of (p<0.05). Specific group differences were determined using least significant difference (LSD) as described by<sup>(21)</sup>.

## Results and Discussion

Parsley dry seed contains approximately 2.65% flavonoids (apigenin). The RF values of extracted apigenin in glycosidic form was 0.477, similar RF values under the same experimental conditions was recorded by<sup>(13)</sup>, while the corresponding values for apigenin in aglycone form was 0.554. The higher RF values in aglycone form may attribute to the remove of sugar moiety from the molecule.

Oral administration of 0.75% H<sub>2</sub>O<sub>2</sub> to male rats caused a case of hypercholesterolemia and hypertriacylglyceridemia manifested by a significant p<0.05 elevation in TC, LDL-C, TAG (table 1, 2, 3, 4) and reduction in HDL-C (table 5), and this may reflect the potent oxidative effectiveness of H<sub>2</sub>O<sub>2</sub> which caused an oxidative damage by free radical generation (superoxide anion, hydroxyl radical), led to a subsequent complication and the development of oxidative stress<sup>(22)</sup>.



Administration of 0.75% H<sub>2</sub>O<sub>2</sub> caused a significant increase in the circulating total cholesterol, LDL-C, VLDL-C and also in the ratio of TC: HDL-C and LDL-C: HDL-C. HDL-C inhibits the uptake of LDL-C by the arterial wall and facilitates the transport of cholesterol from peripheral tissue to the liver where they are catabolized. Then a decrease in plasma HDL-C leads to an elevation of LDL-C<sup>(23)</sup>. Besides, increment of TAG level in animals received H<sub>2</sub>O<sub>2</sub> in the present study may be due to an increase in serum VLDL-C level which acts as a carrier for the TAG<sup>(24)</sup>.

Anyway, hydrogen peroxide (0.75%) used in this study may be considered as exogenous stress factor in the production of ROS which media the damage of the cell structure including nucleic acid, proteins and lipids which lead to a consequent alteration in lipid profile and an elevation in total cholesterol<sup>(25, 26)</sup>.

Moreover, the relationship between serum cortisol, adrenaline and lipid profile under different stress conditions have been documented by a number of workers<sup>(26, 27)</sup>.

Adrenocorticotrophic hormone (ACTH) stimulates the synthesis of adrenaline and cortisol precursors, and the role of these stress hormones in the production of more energy in the form of metabolic fuels, fatty acids and glucose is well documented these substances require the liver to produce and secrete more LDL, which is the main carrier of cholesterol in the blood and finally elevated cholesterol level<sup>(28, 29)</sup>. In this regard, the hypothesis postulated by<sup>(30)</sup> that oxidation stress brought about by the combination of excess liver iron and copper deficiency should be also considered since oxidative stress have a considerable role in hemolysis of RBC because of the depletion of antioxidant and particularly glutathione which play a major role in the protection of red blood cell membrane. The high iron level may increase both free radical formation and hyperlipidemia.

The hypolipidemic effect of flavonoid, (apigenin) may be attributed to the fact that cells respond to phytochemical through direct interaction with receptors or enzymes involved in signal transaction, or through modifying gene expressions<sup>(31, 32)</sup>.

So, apigenin may limit cholesterol biosynthesis by inhibiting 3-hydroxy -3-methylglutaryl-CoA reductase (HMG-CoA reductase) or by enhancing the phosphorylation of HMG-CoA reductase indirectly thus minimize endogenous cholesterol production, and

reduces apo B secretion in hepatocytes<sup>(33, 34)</sup> or, binding to cytoplasmic steroid receptor due to hydrophobicity of their aglycone portion. Moreover, flavonoids (apigenin) may intercalate between the DNA segments, leading to transcription of gene involved in lowering blood cholesterol<sup>(34, 35)</sup>.

**Oxidative status of brain tissues:** Malondialdehyde (MDA) concentration, catalase and cholinesterase activity of brain tissue were considered in this study as a biomarker of H<sub>2</sub>O<sub>2</sub> induced oxidative stress.

A significant (p<0.05) elevation in MDA was observed in H<sub>2</sub>O<sub>2</sub> treated group after four and eight weeks of the treatment. Increase of MDA level may be due to an increase in free radicals production more than the ability of scavenging system, hence, elevated FRs cause a gradual cell injury by lipoxygenase enzyme which oxidized unsaturated fatty acids and subsequent production of excess MDA<sup>(36, 37)</sup>.

Free radicals may also induce injury by induction of gene expression regulated by nuclear transcription factor and jun-NH<sub>2</sub>-terminal kinase (JNK) a stress protein leading to cellular damage<sup>(38, 39)</sup>.

After 4 and 8 weeks of treatment with BHT and apigenin (150 mg/kg B.W. as Glycoside or aglycone) no significant differences in MDA concentration in the brain tissue was recorded among the antioxidant treated groups. Improving the oxidative stress H<sub>2</sub>O<sub>2</sub> treated groups was confirmed the scavenging and potent LPO inhibition capability of the apigenin and BHT. Apigenin may considered a part in indirect inhibition of nuclear transcription factor B, resulting in a decrease in the formation of, adhesion molecules, chemokines, pro-inflammatory cytokines, TNF, IL6 and IL8, as well as, binding to DNA strand<sup>(40)</sup>.

Brain tissue catalase activity (Ku/100gm wet tissue) in H<sub>2</sub>O<sub>2</sub> treated group, there was a significant decrease (p<0.05) during the experimental period, while no significant alterations was recorded in apigenin and BHT treated groups. Excessive H<sub>2</sub>O<sub>2</sub> production with diminution of antioxidant enzyme and subsequent reaction of H<sub>2</sub>O<sub>2</sub> with reduced iron to produce hydroxyl radical via Fenton reaction<sup>(41)</sup> has been postulated to cause elevation in ROS with depletion of antioxidant<sup>(42)</sup>.

Besides, oxidative stress in the brain is associated with increased calcium ion concentration and increased mitochondrial demand leading to an increase in the

formation of ROS and RNS by disturbing respiratory chain and activation of series of enzyme like nitric oxide synthase and xanthine oxidase which stimulate ROS formation and antioxidant enzymes depletion <sup>(1)</sup>.

On the other hand, the significant role of apigenin in ameliorating of antioxidant status may be attributed to its capability in inhibiting the activity of xanthine oxidase<sup>(43)</sup>, lipoxygenase and cyclooxygenase enzymes<sup>(44)</sup>.

Moreover, Hydrogen peroxide treated group also showed a significant decrease in brain tissue cholinesterase activity and this may be attributed to the role of H<sub>2</sub>O<sub>2</sub> in the oxidation of the Trp<sub>432</sub>, Trp<sub>435</sub> and Met 436 residues in the active site of the enzyme resulting in conformational changes and loss of the physiological function<sup>(45)</sup>.

However the result of this study confirmed that apigenin has no neuroprotective effect within the concentration of H<sub>2</sub>O<sub>2</sub> used because acetylcholinestrerase activity is H<sub>2</sub>O<sub>2</sub> concentration dependent and inhibited at high H<sub>2</sub>O<sub>2</sub> concentration (10<sup>-3</sup> M) and activated at low concentration (10<sup>-6</sup> M) <sup>(45)</sup> as well the dose of apigenin

used may not effective to reactivate the enzyme, although the possible mechanisms underlying the neuroprotection of flavonoids against H<sub>2</sub>O<sub>2</sub> induced oxidative damage in PC<sub>12</sub> cells was recorded by <sup>(1)</sup>.



➔ Standard apigenin,  
➔ Parsley seed extracted apigenin (Glycoside)  
➔ Parsley seed extracted apigenin (Aglycone)

**Figure 1: TLC plte (silica gel),**

**Table 1: Serum total cholesterol (TC) concentration (mmol/L) of rats exposed to oxidative stress via 0.75% hydrogen peroxide in drinking water at the periods zero, four and eight weeks in different groups of the experiment**

Groups \ Weeks	0	4 weeks	8 weeks
C	2.468±0.194 Aa	2.461±0.194 Aa	2.478±0.194 Ba
T1	2.468±0.194 Aa	2.566±0.205 Aab	2.94±0.172 Aa
T2	2.468±0.194 Aa	1.932±0.094 Bb	1.704±0.094 Cb
T3	2.468±0.194 Aa	1.853±0.088 Bb	1.756±0.066 Cb
T4	2.468±0.194 Aa	1.955±0.172 Bb	1.985±0.144 Cb

L. S. D. = 0.394

**Table 2: Serum low density lipoprotein-Cholesterol (LDL-C) concentration (mmol/L) of rats exposed to oxidative stress via 0.75% hydrogen peroxide in drinking water at the periods zero, four and eight weeks in different groups of the experiment.**

Groups \ Weeks	0	4 weeks	8 weeks
C	1.191±0.033 Aa	1.194±0.033 Ba	1.197±0.033 Ba
T1	1.191±0.033 Ac	1.279±0.044 Ab	1.686±0.027 Aa
T2	1.191±0.033 Aa	0.72±0.022 Cb	0.45±0.022 Dc
T3	1.191±0.033 Aa	0.527±0.022 Db	0.501±0.022 Dc
T4	1.191±0.033 Aa	0.699±0.022 Cb	0.764±0.016 Cb

L.S.D.= 0.077

**Table 3: Serum very low density lipoprotein-Cholesterol (VLDL-C) concentration (mmol/L) of rats exposed to oxidative stress via 0.75% hydrogen peroxide in drinking water at the periods zero, four and eight weeks in different groups of the experiment.**

Groups \ Weeks	0	4 weeks	8 weeks
C	0.580±0.011 Aa	0.583±0.011 ABa	0.489±0.011 Ba
T1	0.580±0.011 Ab	0.629±0.022 Aab	0.664±0.027 Aa
T2	0.580±0.011 Aa	0.629±0.022 Bab	0.471±0.016 Cb
T3	0.580±0.011 Aa	0.561±0.022 Ba	0.526±0.027 BCab
T4	0.580±0.011 Aa	0.551±0.027 Bab	0.505±0.016 Cb

L.S.D.= 0.066

**Table 4: Serum triacylglycerol (TAG) concentration (mmol/L) of rats exposed to oxidative stress via 0.75% hydrogen peroxide in drinking water at the periods zero, four and eight weeks in different groups of the experiment.**

Groups \ Weeks	0	4 weeks	8 weeks
C	2.904±0.005 Ab	2.911±0.005 ABa	2.909±0.005 Bb
T1	2.904±0.005 Ab	3.148±0.116 Aab	3.324±0.133 Aa
T2	2.904±0.005 Aa	2.603±0.022 Cb	2.36±0.161 Cbc
T3	2.904±0.005 Aa	2.81±0.105 Ba	2.635±0.161 BCab
T4	2.904±0.005 Aa	2.76±0.105 BCab	2.528±0.88 Cb

L.S.D.= 0.288

**Table 5: Serum high density lipoprotein-Cholesterol (HDL-C) concentration (mmol/L) of rats exposed to oxidative stress via 0.75% hydrogen peroxide in drinking water at the periods zero, four and eight weeks in different groups of the experiment.**

Groups \ Weeks	0	4 weeks	8 weeks
C	0.692±0.038 Aa	0.689±0.038 Aa	0.682±0.038 ABa
T1	0.692±0.038 Aa	0.657±0.027 Aa	0.578±0.027 Bb
T2	0.692±0.038 Aa	2.691±0.022 Aa	0.782±0.011 Aa
T3	0.692±0.038 Aa	0.728±0.044 Aa	0.764±0.161 Aa
T4	0.692±0.038 Aa	0.704±0.038 Aa	0.715±0.061 Aa

L.S.D.= 0.111

**Ethical Clearance:** The Research Ethical Committee at scientific research by ethical approval of both environmental and health and higher education and scientific research ministries in Iraq

**Conflict of Interest:** The authors declare that they have no conflict of interest.

**Funding:** Self-funding

### References

- Hwang SL, Shih PH, Yen GC. Neuroprotective effects of citrus flavonoids. *Journal of Agricultural and Food chemistry*. 2012 Feb 1;60(4):877-85.
- Dalle-Donne I, Scaloni A, Giustarini D, Cavarra E, Tell G, Lungarella G, Colombo R, Rossi R, Milzani A. Proteins as biomarkers of oxidative/nitrosative stress in diseases: the contribution of redox proteomics. *Mass spectrometry reviews*. 2005 Jan;24(1):55-99.
- Hamilton ML, Van Remmen H, Drake JA, Yang H, Guo ZM, Kewitt K, Walter CA, Richardson A. Does oxidative damage to DNA increase with age?. *Proceedings of the National Academy of Sciences*. 2001 Aug 28;98(18):10469-74.
- Oikawa S, Hirokawa I, Tada-Oikawa S, Furukawa A, Nishiura K, Kawanishi S. Mechanism for manganese enhancement of dopamine-induced oxidative DNA damage and neuronal cell death. *Free Radical Biology and Medicine*. 2006 Sep 1;41(5):748-56.
- Khudiar KK, Almzaian AK, Almzaian KA. Hypolipidemic Effect of Apigenin Extracted From Parsley (*Petroselinum sativum* L.) Leaves In Cadmium Chloride Treated Rats (Part II). *Journal of Kerbala for Agricultural Sciences*. 2019 Jul 15;4(5):125-39..
- Rendeiro C, Rhodes JS, Spencer JP. The mechanisms of action of flavonoids in the brain: direct versus indirect effects. *Neurochemistry international*. 2015 Oct 1;89:126-39..
- Gómez-Pinilla F. Brain foods: the effects of nutrients on brain function. *Nature reviews neuroscience*. 2008 Jul;9(7):568-78.
- He J, Xu Q, Wang M, Li C, Qian X, Shi Z, Liu LZ, Jiang BH. Oral administration of apigenin inhibits metastasis through AKT/P70S6K1/MMP-9 pathway in orthotopic ovarian tumor model. *International journal of molecular sciences*. 2012 Jun;13(6):7271-82..
- AlolLH, Al-MzaianKA, HusseinSM. The promising anticancer efficacy of parsley seeds flavonoid (apigenin) in induced mammary adenocarcinoma (AMN3) mice. *Journal of Physiological and Biomedical Sciences*. 2012;25(1):5-12..
- Harborne AJ. *Phytochemical method a guide to modern techniques of plant analysis*. springer science & business media; 1998 Apr 30.
- Al-Kawary TA. Extraction of some flavonoids compound from leaves of sider trees (*Zizyphws spin Christi*) and its use as antioxidants and chelating of

- metals in sunflower oil (Doctoral dissertation, Ph. D. Thesis, College of Agriculture. University of Baghdad).
12. Ikhan R. Natural products, Academic press. London, 1969, PP. 260-270.
  13. Medić-Šarić M, Jasprica I, Smolčić-Bubalo A, Mornar A. Optimization of chromatographic conditions in thin layer chromatography of flavonoids and phenolic acids. *Croatica chemica acta*. 2004 May 31;77(1-2):361-6..
  14. Powell CJ, Connelly JC, Jones SM, Grasso P, Bridges JW. Hepatic responses to the administration of high doses of BHT to the rat: their relevance to hepatocarcinogenicity. *Food and Chemical Toxicology*. 1986 Oct 1;24(10-11):1131-43.
  15. Ellefson RD, Caraway WT. Lipids and lipoproteins. In *Fundamentals of clinical chemistry 1976* (pp. 474-542). WB Saunders Philadelphia.
  16. Toro G, Ackermann PG. *Practical clinical chemistry* little Brown Company. Boston. P. 1975;354.
  17. Friedwalds WT, Levy RI, Wite, M. and Fredrickson, DS (1972) Estimation of the concentration of low density lipoprotein cholesterol in plasma without the use of preparative ultra centrifuge. *Clin. Chem.*;18:499-502..
  18. Mandali GC, Patel PR, Dhami AJ, Raval SK. Calving pattern and periparturient disorders in buffaloes of Gujarat in relation to season and meteorological factors. *Indian Journal of Veterinary Medicine*. 2002;22(1):15-20..
  19. Goth L. A simple method for determination of serum catalase activity and revision of reference range. *Clinica chimica acta*. 1991 Feb 15;196(2-3):143-51..
  20. Egan H, Kirk RS, Sawyer R. *Pearson's chemical analysis of food*. Bulter and Tanner Ltd. 1981, P.537.
  21. Snedecor GW, Cochran WC. *Statistical method* 6th ed The Iowa State University Press Ames Iowa USA, 1973, 238-248.
  22. Nasrat AH. Study the effect of dietary Diosgenin Extracted from fenugreek (*trignella foenum graecum*) seeds with trivalent chromium on lipid metabolism of males Japanese quail, Ph.D. thesis. University of Baghdad-Iraq, 2005.
  23. Sheela Sasikumar C, Devi S. Effect of 'Abana' Pretreatment on Isoproterenol-induced Hyperlipidemia in Rats. *Indian Journal of Pharmaceutical Sciences*. 2001;63(2):101-4.
  24. Criqui MH, Golomb BA. Epidemiologic aspects of lipid abnormalities. *The American journal of medicine*. 1998 Jul 6;105(1):48S-57S..
  25. Qureshi GA, Baig S, Sarwar M, Parvez SH. Neurotoxicity, oxidative stress and cerebrovascular disorders. *Neurotoxicology (Park Forest South)*. 2004;25(1-2):121-38..
  26. Odia OJ, Ofori S, Maduka O. Palm oil and the heart: a review. *World journal of cardiology*. 2015 Mar 26;7(3):144.
  27. Hanson MD, Chen E. Daily stress, cortisol, and sleep: the moderating role of childhood psychosocial environments. *Health Psychology*. 2010 Jul;29(4):394..
  28. Steptoe A, Brydon L. Associations between acute lipid stress responses and fasting lipid levels 3 years later. *Health Psychology*. 2005 Nov;24(6):601..
  29. Austin AW, Kushnick MR, Knutson MJ, McGlynn ML, Patterson SM. Resting plasma lipids and cardiovascular reactivity to acute psychological stress. *Journal of Psychophysiology*. 2015;29(3):99..
  30. Fields M, Lewis CG. Hepatic iron overload may contribute to hypertriglyceridemia and hypercholesterolemia in copper-deficient rats. *Metabolism*. 1997 Apr 1;46(4):377-81..
  31. Williams RJ, Spencer JP, Rice-Evans C. Flavonoids: antioxidants or signalling molecules?. *Free radical biology and medicine*. 2004 Apr 1;36(7):838-49..
  32. Khanavi M, Saghari Z, Mohammadirad A, Khademi R, HAJI AA, Abdollahi M. Comparison of antioxidant activity and total phenols of some date varieties. *Daru*. 2009, 17: 104-107.
  33. Thakur NK, Hayashi T, Sumi D, Kano H, Tsunekawa T, Iguchi A. HMG-CoA reductase inhibitor stabilizes rabbit atheroma by increasing basal NO and decreasing superoxide. *American Journal of Physiology-Heart and Circulatory Physiology*. 2001 Jul 1;281(1):H75-83..
  34. Liang H, Sonogo S, Gyengesi E, Rangel A, Niedermayer G, Karl T, Muench G. Anti-inflammatory and neuroprotective effect of apigenin: studies in the GFAP-IL6 mouse model of chronic neuroinflammation. *Free Radical Biology and Medicine*. 2017 Jul 1;108:S10.

35. Mahini H. The effect of quercetin and exercise on atherosclerosis and lipid modulation (Doctoral dissertation, University of Massachusetts Lowell), 2001; 74(4), 408- 425.
36. Sambath Kumar R. Hepatoprotective and in vivo antioxidant effects of *Careya arborea* against carbon tetrachloride induced liver damage in rats. *Int J Mol Med Adv Sci.* 2005;1:418-24..
37. Sambath Kumar R. Hepatoprotective and in vivo antioxidant effects of *Careya arborea* against carbon tetrachloride induced liver damage in rats. *Int J Mol Med Adv Sci.* 2005;1:418-24..
38. Lund AK, Peterson SL, Timmins GS, Walker MK. Endothelin-1–Mediated increase in reactive oxygen species and NADPH oxidase activity in hearts of aryl hydrocarbon receptor (AhR) null mice. *Toxicological Sciences.* 2005 Nov 1;88(1):265-73..
39. Waris G, Ahsan H. Reactive oxygen species: role in the development of cancer and various chronic conditions. *Journal of carcinogenesis.* 2006;5:14..
40. Manna SK, Sah NK, Newman RA, Cisneros A, Aggarwal BB. Oleandrin suppresses activation of nuclear transcription factor- $\kappa$ B, activator protein-1, and c-Jun NH<sub>2</sub>-terminal kinase. *Cancer research.* 2000 Jul 15;60(14):3838-47..
41. Gattermann N. Iron overload in myelodysplastic syndromes (MDS). *International Journal of Hematology.* 2018 Jan 1;107(1):55-63..
42. Hussein MA, Farghaly HS. Protective effects of *Jasonia montana* against lipid peroxidation in liver and kidney of iron-overloaded rats. *Australian Journal of Basic and Applied Sciences.* 2010;4(7):2004-12..
43. Bickford PC, Gould T, Briederick L, Chadman K, Pollock A, Young D, Shukitt-Hale B, Joseph J. Antioxidant-rich diets improve cerebellar physiology and motor learning in aged rats. *Brain research.* 2000 Jun 2;866(1-2):211-7..
44. Erba D, Riso P, Criscuoli F, Testolin G. Malondialdehyde production in Jurkat T cells subjected to oxidative stress. *Nutrition.* 2003 Jun 1;19(6):545-8..
45. Schallreuter KU, Elwary SM, Gibbons NC, Rokos H, Wood JM. Activation/deactivation of acetylcholinesterase by H<sub>2</sub>O<sub>2</sub>: more evidence for oxidative stress in vitiligo. *Biochemical and Biophysical Research Communications.* 2004 Mar 5;315(2):502-8.

# Detection of *Propionibacterium* in Samples by Metagenomic Analysis that Collected from Patients Suffering Acne Vulgaris in Babylon Province

Rabab J H AL-Hasseny<sup>1</sup>, Lamees A. Abdul-Lateef<sup>2</sup>, Hussein Abbas AL-Sultany<sup>3</sup>

<sup>1</sup>Assist. Lect., Microbiology/College of Food Science, AL-QasimGreen University, Iraq, <sup>2</sup>Prof., Department of Microbiology, College of Medicine, University of Babylon, Iraq, <sup>3</sup>Prof., Venereology and Dermatology, College of Medicine, University of Babylon, Iraq

## Abstract

By the metagenomic analysis detected the microorganisms in acne disease. The Taxonomic assignment of the sequences determined classified them into diverse microorganisms. In present study the microorganisms were bacteria (95.29%), eukaryote (4.23%), viruses (0.29%), archaea (0.04%), other sequences(0.15%) and unclassified sequences (0.00)these results determined for PA1. similarly, the PA2 was contains bacteria (96.52%), eukaryote (3.15%), viruses (0.18%), archaea (0.05%), other sequences(0.08%) and unclassified sequences (0.00). The identified and taxonomic of the bacteria that apparent high presenting 95.29% and 96.52% for each PA1and PA2 respectively. According this results taxonomic of bacteria to genus present to detected the important genus was infection acne. The PA1 sample was similarity with PA2. The genus bacteria for (PA1 and PA2) were *Corynebacterium* (34.67%, 40.32%), *Propionibacterium* (32.23%, 24.04%), *Staphylococcus* (24.54%, 24.18%), *Malassezia* (1.13%, 0.86%), *Bacillus* (0.92%, 1.99%), *Pseudomonas* (0.54%, 1.17%), *Escherichia* (0.36%, 0.52%), *Acinetobacter* (0.33%, 0.58%), unclassified (0.32%, 0.20%), *Stenotrophomonas* (0.31%, 0.51%), *Meiothermus* (0.30%, 0.36%) and *Enterococcus*(0.17%, 0.45%) whereas the PA2 have 0.18% of *Streptococcus* but the PA1 not appearance *Streptococcus*.

**Keywords:** Babylon Province, *Propionibacterium acnes*, the metagenomic analysis, acne vulgaris.

## Introduction

*Propionibacterium acnes* is a nonspore-forming, gram-positive, anaerobic, pleomorphic rod whose end products of fermentation include propionic acid<sup>(1)</sup>. *P. acnes* considered an opportunistic pathogen, causing a range of infections as well as being associated with a number of inflammatory conditions. It is primarily recognized for its role in acne vulgaris where it is thought to contribute to the inflammatory phase of the condition<sup>(2)</sup>.

*Propionibacterium acnes*, which are a normal inhabitant of the skin, produce fatty acids that inhibit the growth of fungi on the skin<sup>(3)</sup>. However, when it becomes trapped inside the hair follicle, it may grow and cause inflammation and acne infection<sup>(4)</sup>.

Metagenomic functional analysis revealed that same of chemical pollutant that effected the structure and function of microbial community<sup>(5)</sup>. Metagenomic

analysis was applied to illustrate the metabolic potential of microbial consortium for the degradation of polluted soil, and this could provide additional information of function conducted by un-culturing bacteria<sup>(6)</sup>. The field of metagenomic developed as a consequence of the diversity that prokaryotic diversity was much greater than previously realized and that the prokaryotic population.<sup>(7)</sup>

The classification method of metagenomics sequencing data can be divided into two categories according to different sample data processed method: one is based on the sequence of marker genes such as 16SrRNA (marker gene metagenomic) and other is based on whole-genome sequencing fragment (shotgun-sequences metagenomic)<sup>(8)</sup>.

## Materials and Method

**Samples Collection:** 2 samples (Name these two samples PA1 & PA2) from two patients were subjected

for sampling which include both skin sites (comedown) for the sampling was forehead from both sexes and the age of patient was 17 and 18 years. These patients were diagnosed by dermatology physician, according to the signs and symptoms,, in addition to be having risk factors that were determined by the information about patients . In this study, patients with recent usage of local antibiotic treatment and usage cosmetic material were excluded from sampling.

**DNA Extraction for Gram positive Bacteria:** DNA extraction was carried out according to the genomic DNA purification kitsupplemented by manufactured company (Gene aid, UK).

**Whole Genome Sequencing (WGS) and Analysis:** 2 samples of DNA isolated from patients with acne were selected for whole metagenome sequencing based on the next-generation sequencing technique. After extraction of Genomic DNA, the extracted DNA subjected to quantification by Nano Drop instrument to estimate the DNA concentration according to manufacturing's instructions. In addition, the condition of the DNA was assessed by gel electrophoresis method to evaluate the presence or absence of DNA in the sample, where 1µl of DNA loaded to 1% agarose gel and run at 160V for 30min. Following this step, only successful samples

were submitted to MacroGen company (Korea) for whole metagenome sequencing (Paired-ends) using the Illumina NovaSeq 6000 platform. The resulted raw reads were processed by further bioinformatics tools.

The raw data were analyzed by several bioinformatics tools. All bioinformatic approaches which used to analyze the study sequences were depend on either using command-line tools and bioinformatics softwires on open-source operating system, Linux (Version: Ubuntu 18.04.3 LTS, Canonical Ltd., UK), Windows-based program (CLC Genomics Workbench version 20.0.3) or using web-based servers such as the Galaxy platform (<https://galaxyproject.org>)<sup>(9)</sup>. Before WGS analysis, the raw data undergo quality control by FastQC (Version, 0.11.5)<sup>(10)</sup> to evaluate quality of reads and calculating the basic statistics (such as total number of bases, reads and GC content). After quality control, raw reads were subjected to preprocessing steps to reduce biases in analysis by trimming out bases of low quality, adapter sequences, the Poly-G tail and human DNA. Trimmomatic (version 0.36) tools<sup>(11)</sup> and CLC Mapper (CLC Genomics Workbench version 20.0.3). The filtered raw data have undergone for further processing steps summarized with its tools and references in Table (1).

**Table (1): The Bioinformatics tools or programs which used for analyze the filtered raw data**

Processing type	Tool/Programs	Ref.
Assembly	CLC <i>de novo</i> assembly	(12)
Visualizing the <i>de novo</i> assembly	Bandage (v0.8.1)	(13)
Ordering contigs	Mauve (v2.4.0)	(14)
Taxonomy classification	MG-RAST version 4.0.3	(15)
Visualizing annotated Taxonomy	Krona	(16)
Manipulation of the SAM/BAM files	SAMTools	(17)

## Results and Discussion

By the metagenomic analysis detected the microorganisms in acne disease. The Taxonomic assignment of the sequences determined classified them into diverse microorganisms. In present study the microorganisms were bacteria (95.29%), eukaryote (4.23%), viruses (0.29%), archaea (0.04%), other

sequences(0.15%) and unclassified sequences (0.00) these results determined for PA1. similarly, the PA2 was contains bacteria (96.52%), eukaryote (3.15%), viruses (0.18%), archaea (0.05%), other sequences(0.08%) and unclassified sequences (0.00) depended on the Pie chart in Figure (1) and (2).



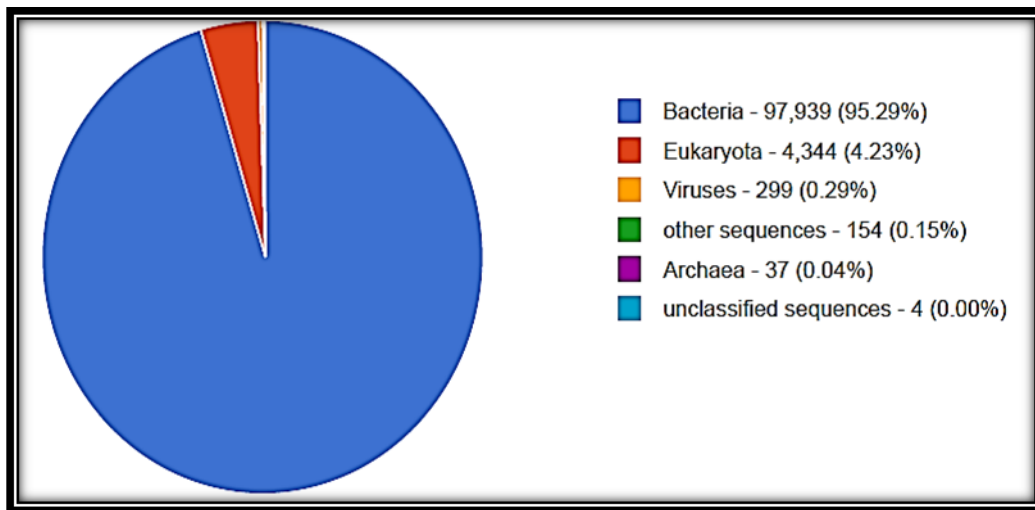


Figure (1): Pie chart represents the distribution of domain taxa of PA1.

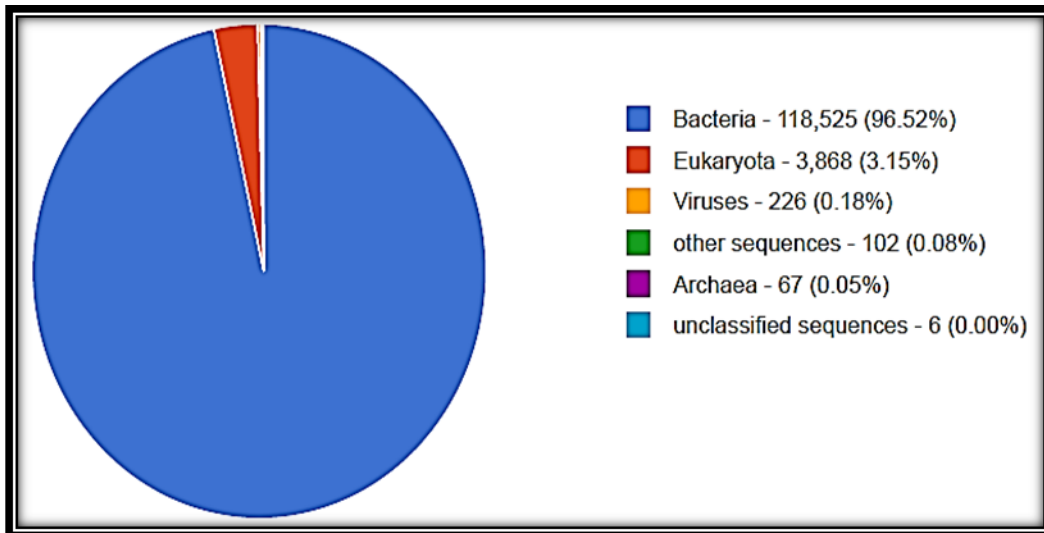


Figure (2): Pie chart represents the distribution of domain taxa of PA2.

The bacteria in the above results was higher than other microorganisms in two samples. It was 95.29% and 96.52% for each PA1 and PA2 respectively. These results detected the bacteria is a major source in acne diseases compared with other microorganisms additionally several studies identified bacteria in acne vulgarism. So many factors increasing the bacteria in acne lesions may be the bacteria have multi-virulence factors, generation time, resistant to inhibitors growth that secreted by skin and other factors.

Correlated the results with <sup>(18)</sup> The surface of the skin is cooler than the core body temperature and is slightly acidic, and squames are continuously shed from the skin surface as a result of terminal differentiation.

The results agree with <sup>(19)</sup> they documented The microbiome includes bacteria, fungi, viruses, parasites, and micro-eukaryotes which play significant role in dermatological disorders.

The metagenomic analysis as important part of this study was to identify and taxonomic of the bacteria that appear high presenting 95.29% and 96.52% for each PA1 and PA2 respectively. According to these results taxonomic of bacteria to genus present to detect the important genus was infection acne. The PA1 sample was similar to PA2. The genus bacteria for (PA1 and PA2) were *Corynebacterium* (34.67%, 40.32%), *Propionibacterium* (32.23%, 24.04%), *Staphylococcus* (24.54%, 24.18%), *Malassezia* (1.13%, 0.86%), *Bacillus*

(0.92%, 1.99%), *Pseudomonas* (0.54%, 1.17%), *Escherichia* (0.36%, 0.52%), *Acinetobacter* (0.33%, 0.58%), unclassified (0.32%, 0.20%), *Stenotrophomonas* (0.31%, 0.51%), *Meiothermus* (0.30%, 0.36%) and

*Enterococcus*(0.17%, 0.45%) whereas the PA2 have 0.18% of *Streptococcus* but the PA1 not appearance *Streptococcus* such as according to the pie charts in below in the Figures (3) and (4).

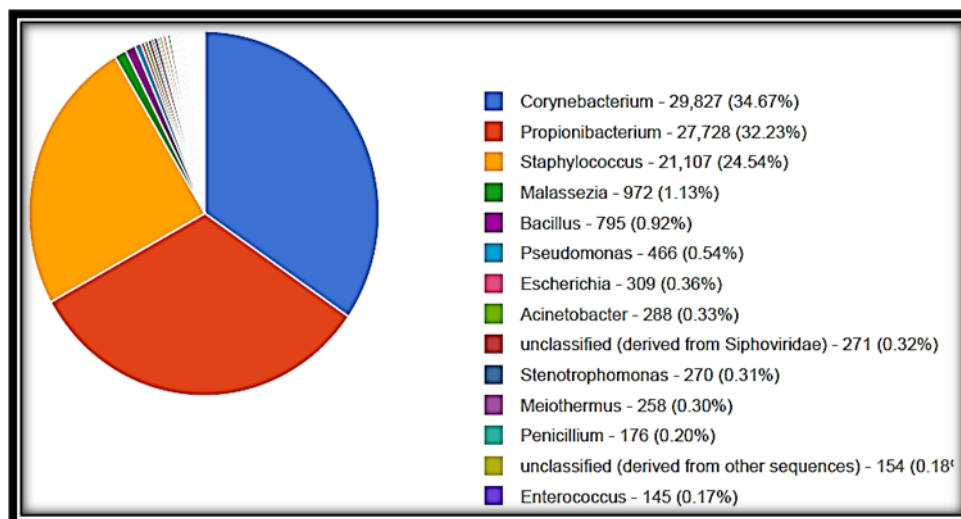
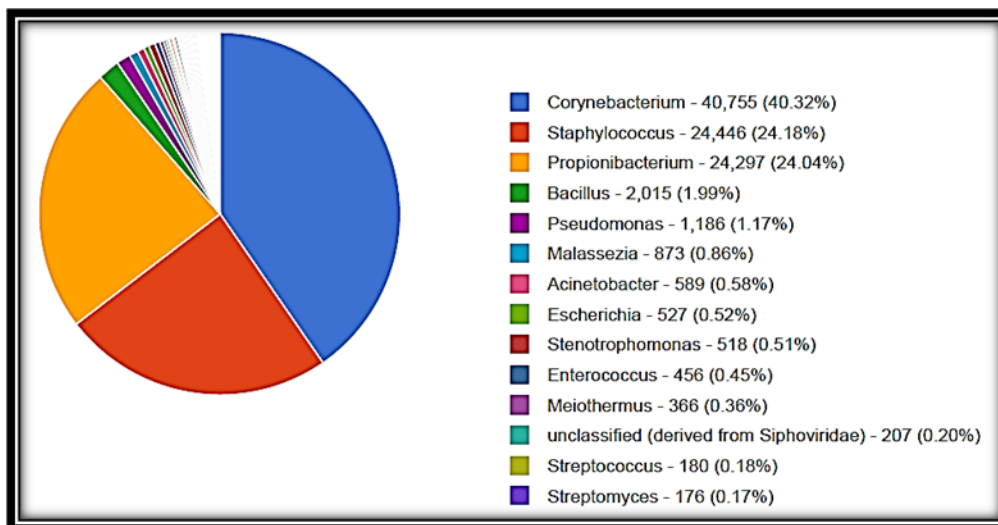


Figure (3) Pie chart represents the distribution of genus taxa of PA1.



Figure(4) Pie chart represents the distribution of genus taxa of PA2.

The results showed that PA1 and PA2 were similarity in three major bacteria included *Corynebacterium*, *Propionibacterium*, *Staphylococcus* whereas the two samples were significant difference of percentages for the other bacteria. It mainly consists of sebaceous areas, moist areas, dry areas, and sites containing varied densities of hair follicles, skin folds, and skin thicknesses. Sebaceous glands being relatively anoxic support the growth of facultative anaerobes such as acne

causing *Propionibacteriumacnes*, which contain lipase-encoding genes that degrade skin lipids of sebum as revealed by full genome sequencing<sup>(20)</sup>.

The primary microbe associated with development of acne is *Propionibacterium acnes*, also a prominent member of the commensal skin microbiota. Topical and systemic antibacterial drugs have long been used to treat acne, with the efficacy commonly attributed to decreased *P. acnes* colonization and/or activity<sup>(21)</sup>.

**Ethical Clearance:** The Research Ethical Committee at scientific research by ethical approval of both environmental and health and higher education and scientific research ministries in Iraq

**Conflict of Interest:** The authors declare that they have no conflict of interest.

**Funding:** Self-funding

## References

1. Grice EA, Segre JA. The skin microbiome. *Nature reviews microbiology*. 2011 Apr;9(4):244-53..
2. Leyden JJ. The evolving role of *Propionibacterium acnes* in acne. In *Seminars in cutaneous medicine and surgery* 2001 Sep (Vol. 20, No. 3, pp. 139-143).
3. Johnson BA, Nunley JR. Topical therapy for acne vulgaris: How do you choose the best drug for each patient?. *Postgraduate Medicine*. 2000 Jan 1;107(3):69-80.
4. McLaughlin J., Steven W., Alison M. L., Anthony J. B., Emma B. and Andrew M.(2019). *Propionibacterium acnes* and *Acne Vulgaris*: New Insights from the Integration of Population Genetic, Multi-Omic, Biochemical and Host-Microbe Studies. *Microorganisms* 7(128);1-29
5. Lee YB, Byun EJ, Kim HS. Potential role of the microbiome in acne: a comprehensive review. *Journal of clinical medicine*. 2019 Jul;8(7):987.
6. Zhang Y, Ertl HC. The effect of adjuvanting cancer vaccines with herpes simplex virus glycoprotein D on melanoma-driven CD8+ T cell exhaustion. *The Journal of Immunology*. 2014 Aug 15;193(4):1836-46.
7. Steele HL, Streit WR. Metagenomics: advances in ecology and biotechnology. *FEMS microbiology letters*. 2005 Jun 1;247(2):105-11.
8. McDowell A, Gao A, Barnard E, Fink C, Murray PI, Dowson CG, Nagy I, Lambert PA, Patrick S. A novel multilocus sequence typing scheme for the opportunistic pathogen *Propionibacterium acnes* and characterization of type I cell surface-associated antigens. *Microbiology*. 2011 Jul 1;157(7):1990-2003.
9. Lomholt HB, Kilian M. Population genetic analysis of *Propionibacterium acnes* identifies a subpopulation and epidemic clones associated with acne. *PloS one*. 2010 Aug 19;5(8):e12277.
10. Andrews S. FastQC: a quality control tool for high throughput sequence data. 2010.
11. Bolger AM, Lohse M, Usadel B. Trimmomatic: a flexible trimmer for Illumina sequence data. *Bioinformatics*. 2014 Aug 1;30(15):2114-20.
12. CLC Genomics Workbench version 20.0.3
13. Wick RR, Schultz MB, Zobel J, Holt KE. Bandage: interactive visualization of de novo genome assemblies. *Bioinformatics*. 2015 Oct 15;31(20):3350-2..
14. Darling AE, Mau B, Perna NT. progressiveMauve: multiple genome alignment with gene gain, loss and rearrangement. *PloS one*. 2010 Jun 25;5(6):e11147.
15. Meyer F, Paarmann D, D'Souza M, Olson R, Glass EM, Kubal M, Paczian T, Rodriguez A, Stevens R, Wilke A, Wilkening J. The metagenomics RAST server—a public resource for the automatic phylogenetic and functional analysis of metagenomes. *BMC bioinformatics*. 2008 Dec;9(1):1-8.
16. Ondov BD, Bergman NH, Phillippy AM. Interactive metagenomic visualization in a Web browser. *BMC bioinformatics*. 2011 Dec 1;12(1):385.
17. Li H, Handsaker B, Wysoker A, Fennell T, Ruan J, Homer N, Marth G, Abecasis G, Durbin R. The sequence alignment/map format and SAMtools. *Bioinformatics*. 2009 Aug 15;25(16):2078-9..
18. Fuchs E, Raghavan S. Getting under the skin of epidermal morphogenesis. *Nature Reviews Genetics*. 2002 Mar;3(3):199-209..
19. Mathieu A, Delmont TO, Vogel TM, Robe P, Nalin R, Simonet P. Life on human surfaces: skin metagenomics. *PloS one*. 2013 Jun 12;8(6):e65288.
20. Liu J, Yan R, Zhong Q, Ngo S, Bangayan NJ, Nguyen L, Lui T, Liu M, Erfe MC, Craft N, Tomida S. The diversity and host interactions of *Propionibacterium acnes* bacteriophages on human skin. *The ISME journal*. 2015 Sep;9(9):2078-93..
21. Tan HH. Antibacterial therapy for acne. *American journal of clinical dermatology*. 2003 May 1;4(5):307-14..

# Expression Levels of Efflux Pump *mexR* and *norA* Genes in Multi-Drug Resistant in Some Bacteria by Using Quantitative RT-PCR Under Stress of Effect Efflux Pump Inhibitors

Baidaa Adel Ibrahim<sup>1</sup>, Mayadaa Abdullah Shehan<sup>2</sup>

<sup>1</sup>Post Graduate Student, University of Anbar, College of Sciences, Department of Biology, Iraq,

<sup>2</sup>Assist. Prof. Dr. University of Anbar, College of Sciences, Department of Biology, Iraq

## Abstract

The study was suggested because of the major role of multidrug-resistant *Pseudomonas aeruginosa* and *Staphylococcus aureus* in a wide range of clinical infections besides increasing a high resistance against the commonly used difference antibiotic. The efflux pumps have a vital role in multidrug resistance for extruding many toxic materials and antibiotics. This study aimed to measure the expression level of efflux pump genes in MDR *Pseudomonas aeruginosa* and *Staphylococcus aureus* using RT-qPCR technique. In this study, one hundred clinical isolates of MDR *P. aeruginosa* and *S. aureus* isolated from wounds were examined, then 20 isolates selected based on their ability as MDR and were exposed to different concentrations of Ethidium Bromide (Cartwheel method) to determine the presence of efflux pumps activity. Efflux pump genes *mexR*, and *norA* were screened by PCR. The results demonstrated the presence of *mexR* and *norA* genes in all MDR isolates. RT-qPCR assay was used for investigating the efflux pump genes expression. The difference in gene expression between active and nonactive efflux pumps was determined when exposed to the antibiotics and efflux pump inhibitors.

**Keywords:** Efflux pump inhibitors, *mexR* gene, *norA* gene, gene expression, RT-qPCR.

## Introductions

The multidrug resistance is becoming a dangerous problem in the treatment of resistant bacterial infections. The MDR, by definition, is the capacity of pathogens to resist lethal doses of drugs, various in their mode of action and structure, which would be effective in the removal of susceptible isolates of pathogens<sup>(1)</sup>. Among infections caused by Gram-negative rods, *P. aeruginosa* bacteria are the most serious and opportunistic pathogens that cause a high rate of mortality and morbidity in most hospitalized patients<sup>(2)</sup>. Recently, these bacterium infections are caused one of the main problems in hospitals and that are relevant to high rates of mortality, ranging from 18% to 61%<sup>(3)</sup>.

*Staphylococcus aureus* pathogen remains one of the more serious bacterial pathogens in the public health field because of its high virulence, and also able to cause multiple diseases varying from complicated skin and skin structure infections (cSSSI) to life-threatening situations, like pneumonia, endocarditis and toxic shock

syndrome<sup>(4)</sup>. Efflux pumps have revealed as specific key drivers for antimicrobial in both Gram-negative and Gram-positive bacteria, EP also is vital in other different physiological processes like stress-adaptations, pathogenicity, virulence factors, and transportation of necessary nutrients<sup>(5)</sup>. The MDR efflux systems are found in whole bacterial species. These pumps are proteins, which are the capacity of transporting substrate materials with different sizes and properties from the inside cell to the extracellular area of the bacterial cell<sup>(6)</sup>. Efflux pumps are classified into five families; the resistance nodulation cell division (RND) families, major facilitator subfamily (MFS), small multidrug regulator (SMR), energy-dependent ATP-driven pumps are the ATP-binding cassette (ABC) family and the multidrug and toxic compound extrusion (MATE)<sup>(7)</sup>. *mexR* is a regulatory gene of MexAB-OprM operon and was located upstream of the *mexAB-oprM* operon, also encoding a repressor protein of MarR family, and MexR protein was endowed with oxidation-sensing mechanism which regulates virulence and antibiotic resistance in *P.*

*aeruginosa*(8). The Efflux pump *norA* is a member of MFS family. Which is a chromosomally encoded protein with 12 transmembrane-spanning segments, also is a proton motive force (PMF) dependent multidrug efflux pump in *Staphylococcus aureus*. *norA* is a 388 amino acid protein and reveals to release a diversity of structurally unrelated drugs, like fluoroquinolones, ceftriaxone, benzalkonium chloride, tetra phenyl phosphonium bromide, ethidium bromide, and acriflavine(7).

## Materials and Method

### Bacterial Isolates and Identification:

One hundred isolates of *Pseudomonas aeruginosa* and *Staphylococcus aureus* isolated from wounds. All bacterial isolates were identified based on morphological characteristics on culture media and biochemical tests (9). Additionally, the diagnosis of all isolates was carried out by the Vitek-2 compact system (Biomérieux, France) using GNR-ID and GPC-ID card(10).

### Estimation of Efflux pump activity by Cartwheel

**method:** The cartwheel method was described by (11) to determine the presence or absence of efflux activity within bacterial selected isolates according to the multidrug-resistant pattern. Twenty selected isolates activated on 5ml of (TSB) and incubated at 37°C for 18h. Tryptic soy agar plates containing (EtBr) at concentrations of 0 to

2.5 mg/L, and kept away from light. Bacterial cultures were streaked on EtBr-TSA plates. After chosen a proper concentration, cultures were swabbed on EtBr-TSA plates starting from the center of the plate and spreading towards the edges. Agar plates were incubated overnight at 37 °C and then examined under U.V transilluminator.

**Genomic DNA Extraction:** The extraction of DNA was carried out for Twenty *Pseudomonas* and *Staphylococcus* isolates using DNA Mini kit extraction depending on the instruction of the manufacturing company (Promega, USA).

**Detection of the efflux pump genes by Conventional PCR:** Uniplex PCR technique was performed to amplify efflux pump genes (*mexR* and *norA*) of *Pseudomonas aeruginosa* and *Staphylococcus aureus* respectively. The stock solution of primer was prepared from Lyophilized primers (macrogen, Korea). The specific primers used in this study are listed in Table (1). A typical PCR mixture contained 12.5µl master mix (*Taq* polymerase, MgCl<sub>2</sub>, PCR buffer and dNTPs), 1µl each of forward and reverse primers, 4µl of DNA and 6.5µl of free water adjusted to a total volume of 25. After centrifuged, the mixture transferred to a thermal cycler to start reaction according to the steps of the suitable program for each gene.

**Table (1): Sequences of primers that use for conventional PCR.**

Gene		Sequences (5'-3')	Amplicon size (bp)	Reference
<i>norA</i>	F	TGGCCACAATTTTTCGGTAT	182	This study
	R	CACCAATCCCTGGTCCTAAA		
<i>mexR</i>	F	GATTCACGGGGACCTTATCA	162	This study
	R	CGAAGAAGGCAGGCAAATA		

### Total RNA extraction and Synthesis of cDNA:

Total RNA was extracted using TRIzol Reagent RNA Isolation kit (Wizbio, Korea) following the manufacturer recommendations.

By using RT Premix cDNA synthesis protocol (Bioneer, Korea): 15 µl of RNA template and 5 µl Rnase free water were added to the RT PE mix tube. The tube was placed in a thermal cycler programmed. cDNA was performed according to the following procedure; annealing step for 10 min at 37°C, cDNA synthesis for 1 hr at 42°C, heat inactivation for 5 min at 95°C.

### Quantitative Real-time PCR (RT-qPCR) assay:

Transcription of *mexR* and *norA* genes were determined in the 4 MDR *P. aeruginosa* and 4 MDR *S. aureus* isolates. The amplification reaction of the fragment of mRNA was performed with the following master amplification reaction in 10µl of qPCR Mix, 1X, specific primers Table (2); (1µl of forward primers and 1µl of reverse primers), 5µl of cDNA synthesis and 3µl of Nuclease-free Water. Thermocycler Program was used for quantitative RT-PCR as follows: Initial denaturation for 60 sec at 95°C, denaturation for 15 sec at 95°C, annealing/extension for 30 sec at 60°C, the fluorescence

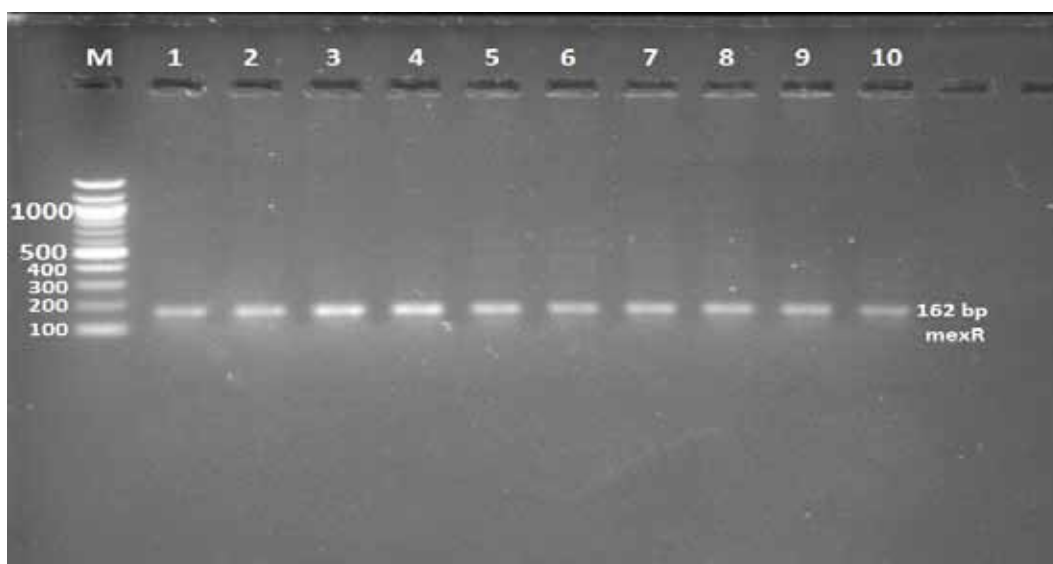
readings were taken after each cycle following the extension step. Then it was followed by a melting curve analysis of 60–95 °C.

A gene *gyrB* housekeeping gene was used as a reference gene. The  $\Delta\Delta Ct$  method was used for

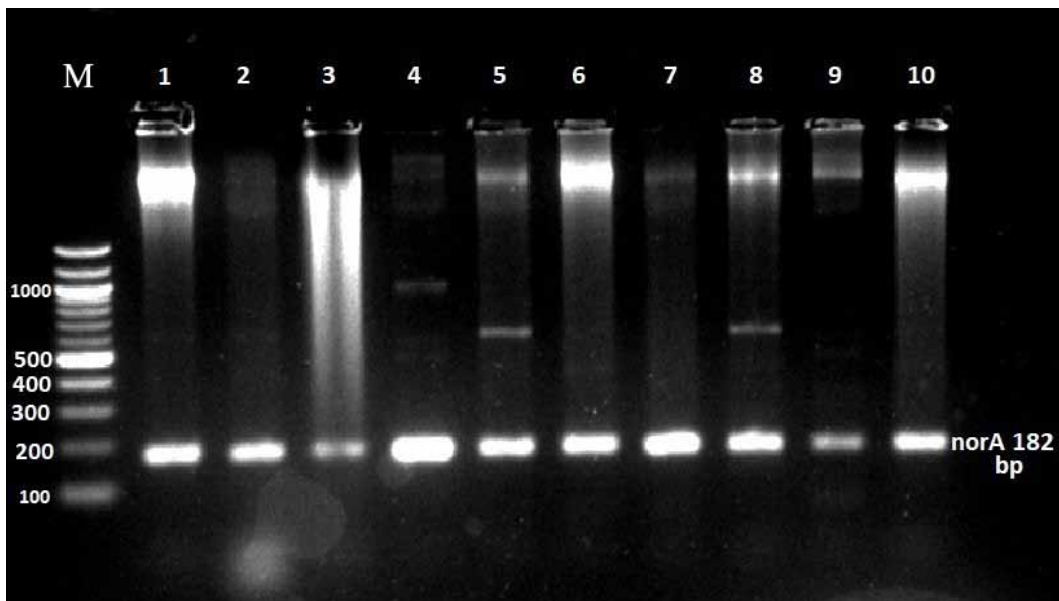
measuring the gene expression. The normalized target amount in the sample was equal to  $2^{-\Delta\Delta Ct}$  and also this value can be used to compare expression levels in the samples(12).

**Table(2): Sequences of primers that use to gene expression**

Target gene		Primer sequence	Product (bp)	Reference
Gyr Bgene ( <i>mexR</i> )	F	GGCGTGGGTGTGGAAGTC	187	This study
	R	TGGTGGCGATCTTGAACTTCTT		
Gyr Bgene ( <i>norA</i> )	F	CCAGGTAAATTAGCCGATTGC	121	This study
	R	AAATCGCCTGCGTTCTAGAG		
norA	F	TGGCCACAATTTTTCGGTAT	182	This study
	R	CACCAATCCCTGGTCCTAAA		
mexR	F	GATTCACGGGGACCTTATCA	162	This study
	R	CGAAGAAGGCAGGCAAATA		



**Figure (1): Agarose gel (2%) electrophoresis of PCR products formexR gene (162bp). Lane M: 100bp DNA ladder; lanes 1-10 represent bands of Multidrug resistance *P. aeruginosa* isolates. (75-80V/cm<sup>2</sup> for 2 hr).**



**Figure (2):** Agarose gel electrophoresis (2%) of PCR products (75-80V/cm<sup>2</sup> for 2 hr) for the efflux pump gene *norA* (182bp). Lane M: 100bp DNA ladder; lanes 1-10: Multidrug resistance *S. aureus* isolates.

## Results and Discussion

### Efflux pump activity by cartwheel method:

The detection of efflux pumps by using different concentration of TSA-EtBr agar plates ranging (0 to 2.5 mg/L), each plate with specific concentration cultured with 20 isolates of *P. aeruginosa* and *S. aureus* in the form of a cartwheel, after incubation period the result recorded under UV light detects the presence or absence of fluorescence in the mass of bacterial growth, the result identified twenty isolates were grown with higher efflux activity (at concentration 2mg/L). These results were agreed with(13).

**Determination of efflux pump genes (*mexR*, *norA*) by PCR:** The extracted samples in this experiment have been used to detect the presence of genes encoding efflux pumps and investigation of the genes in bacterial isolates uniplex PCR technique for each DNA. The PCR assay included 20 isolates for the determination of the efflux pump *mexR* and *norA* genes. The PCR products have been confirmed by analysis of the bands on gel electrophoresis. A study by (14) in Egypt, revealed that *mexR* gene was detected in 16 isolates. *mexR* was an important regulatory gene of MexAB-OprM operon, this gene was located upstream of the *mexAB-oprM* operon(15).

Also, the results of the PCR technique for chromosomal efflux pump gene *norA* was observed

in isolates of MDR *S. aureus*. In Iraq, a study by(7), out of a total of 96 multidrug-resistant isolates of *S. aureus*, the number of isolates that carried the gene *norA* were 77 isolates (80.21%).

**The expression of chromosomal efflux pump genes by RT-qPCR:** The major role of this step was to determine the gene expression levels of the chromosomal efflux pump genes in clinical isolates. The presence gene *mexR* and *norA* in bacterial isolates, and compare the gene expression in the presence and the absence of the antibiotics to prove the role of efflux pump genes in the resistance of *P. aeruginosa* and *S. aureus*, also to compare the gene expression in the presence of the inhibitors to restore the sensitivity of MDR efflux pumps to the antibiotics against which they were developed.

The calculation of gene expression fold change was made using relative quantification(16). For the active efflux pump, the fold of gene expression of *mexR* gene for the three groups (treatments) in addition to untreated group ranged from 1 to 7.86, for an untreated group the fold of *mexR* gene was 1.0. While for the nonactive efflux, the fold of gene expression of *mexR* gene was ranged from 1 to 3.70, also for the untreated group the fold was 1.0. The result of the gentamicin group fold of *mexR* gene (active efflux) was (7.86) and this result was higher (3.70) than the fold of *mexR* gene of (non-active efflux). The PAβN group fold of *mexR* gene (active) was

0.64 and this result was higher (0.47) than the fold of (nonactive). The Phenothiazine group fold of *mexR* gene (active) the result was 1.16 and this result was higher (0.80) than the fold of (nonactive). The results of *mexR* efflux pump gene expression are revealed in table (3).

In this study, when the results of gene expression of fold for antibiotics and synthetic products were compared; it was found that the gene expression was significantly higher when the antibiotics used. Briefly, the gene expression was significantly higher in the gentamicin group than synthetic products, despite the variations in the expression levels of the gene in the gentamicin group, exposure to antibiotics induced the expression of *mexR* gene in the isolates of *P. aeruginosa* studied. Exposure to synthetic products was leading to a decrease in the expression of *mexR* gene in the isolates, except phenothiazine was increased the expression of *mexR* gene in isolates that possess active efflux. The results of gene expression indicated the important role of *mexR* gene in the resistance of gentamicin antibiotics. RND pumps contribute most significantly to antibiotic resistance: MexAB-OprM, MexCD-OprJ, MexEF-OprN, and MexXY-OprM, MexB transports  $\beta$ -lactams;  $\beta$ -lactamase inhibitors and carbapenems (notimipenem), aminoglycosides, fluoroquinolones, tetracyclines, dyes, and several homoserine lactones involved in (QS)(17).

**Table (3): Fold of *mexR* expression Depending on  $2^{-\Delta C_t}$  Method**

Groups	Isolate	Fold of gene expression
Gentamicin	C+D	3.70
	A+B	7.86
PABN	C+D	0.47
	A+B	0.64
Pheno	C+D	0.80
	A+B	1.16
Untreated (Control)	C+D	1
	A+B	1

The mechanism of MexR regulated antibiotic resistance is due to the formation of intermonomer disulfide bonds in MexR dimer that leads to its dissociation from promoter DNA, also derepression of the *mexAB-oprM* drug efflux operon, and increased antibiotic resistance of pathogene. PA $\beta$ N inhibitor was broadly active against MexAB-OprM, MexEF-OprN, MexCD-OprJ, and MexXY-OprMin(18).

Quantitative RT-PCR assay analyzed the mRNA expression of *norA* and compared its expression with isolates without treatment (control), isolates were exposed to azithromycin antibiotic, and also were exposed to synthetic inhibitors. The result of gene expression was shown in table (4). The fold of gene expression of the *norA* gene for active efflux in the isolates of *S. aureus* studied was (4.61), this result was higher than the fold of nonactive efflux *norA* gene (2.14). The fold of gene expression in isolates exposure to azithromycin was higher than isolates untreated group (control). The fold of gene expression of PA $\beta$ N was 0.73 for active efflux and for nonactive efflux the fold was 0.40, also in isolates that exposures to Phenothiazine fold was 0.87 for active efflux, while for (nonactive) the fold was 0.84 and this results of synthetic products was less than the fold of isolates without treatment group. These results showed that the synthetic products decreased chromosomal efflux pump *norA* gene expression. On the other hand, the above results demonstrate the significant gene expression in isolates exposed to antibiotics.

MDR efflux pump of *S. aureus* is possessed high resistance to antibiotics, including resistance to  $\beta$ -lactams, aminoglycosides, macrolides, lincosamides, fluoroquinolones, chloramphenicol, sulfonamides, streptomycin, and tetracycline(19). Thioridazine, Phe-Arg $\beta$ -naphthylamide (PA $\beta$ N), or the arylpiperazine NMP are some of the compounds categorized were used as efflux pump inhibitors(20).

**Table (4) Fold of *NorA* expression Depending on  $2^{-\Delta C_t}$  Method**

Groups	Isolate	Fold of gene expression
Azithromycin	C+D	2.14
	A+B	4.61
PABN	C+D	0.40
	A+B	0.73
Pheno	C+D	0.84
	A+B	0.87
Untreated (Control)	C+D	1.0
	A+B	1.0

## Conclusions

Our study confirmed the important role of efflux pumps in high-level resistance of *Pseudomonas aeruginosa* and *Staphylococcus aureus* isolates, hence the intrinsic resistance to antibiotics of some isolates may



return to their efflux systems. Phe-Arg  $\beta$ -naphthylamide (PA $\beta$ N) potentiated antibiotic activity through inhibiting *mexR* efflux pump in *P. aeruginosa* and *norA* efflux pump in *S. aureus*.

**Ethical Clearance:** The Research Ethical Committee at scientific research by ethical approval of both environmental and health and higher education and scientific research ministries in Iraq

**Conflict of Interest:** The authors declare that they have no conflict of interest.

**Funding:** Self-funding

### References

- Spengler G, Kincses A, Gajdacs M, Amaral L. New roads leading to old destinations: efflux pumps as targets to reverse multidrug resistance in bacteria. *Molecules*. 2017;22(3):468.
- Bhasin S, Shukla AN, Shrivastava S. Observation on *Pseudomonas aeruginosa* in Kshipra River with Relation to Anthropogenic Activities. *Orig Res Artic*. 2015;4:672–84.
- Moghaddam MM, Abolhassani F, Babavalian H, Mirnejad R, Barjini KA, Amani J. Comparison of in vitro antibacterial activities of two cationic peptides CM15 and CM11 against five pathogenic bacteria: *Pseudomonas aeruginosa*, *Staphylococcus aureus*, *Vibrio cholerae*, *Acinetobacter baumannii*, and *Escherichia coli*. *Probiotics Antimicrob Proteins*. 2012;4(2):133–9.
- Khan SA. Molecular Characterization of Fluoroquinolone Resistance of Methicillin – Resistant Clinical *Staphylococcus aureus* Isolates from Rawalpindi, Pakistan. *Med Res Arch*. 2015;2(2):1–14.
- Shriram V, Khare T, Bhagwat R, Shukla R, Kumar V. Inhibiting bacterial drug efflux pumps via phytotherapeutics to combat threatening antimicrobial resistance. *Front Microbiol*. 2018;9(DEC):1–18.
- Blair JMA, Piddock LJ V. How to measure export via bacterial multidrug resistance efflux pumps. *MBio*. 2016;7(4):e00840-16.
- Shamkhi GJ, Saadedin SMK, Jassim KA. Detection the Prevalence of Some Chromosomal Efflux Pump Genes in Methicillin Resistant *Staphylococcus aureus* Isolated from Iraqi Patients. *Iraqi J Biotechnol*. 2019;18(3).
- Suresh M, Nithya N, Jayasree PR, Vimal KP, Manish Kumar PR. Mutational analyses of regulatory genes, *mexR*, *nalC*, *nalD* and *mexZ* of *mexAB-oprM* and *mexXY* operons, in efflux pump hyperexpressing multidrug-resistant clinical isolates of *Pseudomonas aeruginosa*. *World J Microbiol Biotechnol* [Internet]. 2018;34(6):0. Available from: <http://dx.doi.org/10.1007/s11274-018-2465-0>.
- MacFaddin JF. *Biochemical Tests for Identification of Medical Bacteria*, Williams and Wilkins. Philadelphia, PA. 2000;113.
- Harjanti DW, Ciptaningtyas R, Wahyono F, Setiatin ET. Isolation and identification of bacterial pathogen from mastitis milk in Central Java Indonesia. In: *IOP Conference Series: Earth and Environmental Science*. IOP Publishing; 2018. p. 12076.
- Martins M, Viveiros M, Couto I, Costa SS, Pacheco T, Fanning S, et al. Identification of efflux pump-mediated multidrug-resistant bacteria by the ethidium bromide-agar cartwheel method. *In Vivo (Brooklyn)*. 2011;25(2):171–8.
- Schmittgen TD, Livak KJ. Analyzing real-time PCR data by the comparative C T method. *Nat Protoc*. 2008;3(6):1101.
- Saber N, Kandala NJ. The inhibitory effect of fluphenazinedecanoate and caffeine on *Staphylococcus aureus* efflux pumps. *Cur Res Micro Biotech*. 2018;2108(6):2.
- Osman MES, El-Hendawy HH, El-All SMA, Hassan AM, Mahmoud DE. Correlation between resistance of *Pseudomonas aeruginosa* to benzalkonium chloride and expression of efflux pump genes. *J Appl Pharm Sci*. 2018;8(12):44–52.
- Evans K, Adewoye L, Poole K. *MexR* Repressor of the *mexAB-oprM* Multidrug Efflux Operon of *Pseudomonas aeruginosa*: Identification of *MexR* Binding Sites in the *mexA-mexR* Intergenic Region. *J Bacteriol*. 2001;183(3):807–12.
- Schmittgen TD, Livak KJ. Analyzing real-time PCR data by the comparative C T method. *Nat Protoc*. 2008;3(6):1101.
- Dreier J, Ruggerone P. Interaction of antibacterial compounds with RND efflux pumps in *Pseudomonas aeruginosa*. *Front Microbiol*. 2015;6:660.

18. Askoura M, Mattawa W, Abujamel T, Taher I. Efflux pump inhibitors (EPIs) as new antimicrobial agents against *Pseudomonas aeruginosa*. *Libyan J Med*. 2011;6(1):5870.
19. Schindler BD, Jacinto P, Kaatz GW. Inhibition of drug efflux pumps in *Staphylococcus aureus*: current status of potentiating existing antibiotics. *Future Microbiol*. 2013;8(4):491–507.
20. Kvist M, Hancock V, Klemm P. Inactivation of efflux pumps abolishes bacterial biofilm formation. *Appl Environ Microbiol*. 2008;74(23):7376–82.

# Distinguish between Two Species of *streptococcus* by *sk* gene

Rawaa Kh. Mohammed<sup>1</sup>, Harith K. Buinya<sup>2</sup>

<sup>1</sup>M.Sc. Student, <sup>2</sup>Assist. Prof., Department of Biology/College of Education for Pure Sciences/  
University of Anbar/Anbar-IRAQ

## Abstract

This study aims at the possibility of using the *sk* gene encoding the Streptokinase protein to differentiate between the different species belonging to the genus *Streptococcus* which can produce this protein., 12 bacterial isolates belonging to the genus *Streptococcus* were obtained, and by using the caseinolytic assay test, all the studied isolates gave a positive result with different clear zone diameters around the wells. DNA was then extracted from the isolated bacteria and used as a template for the amplification of the *sk* gene using specific primers for the gene. The 1300 bp was amplified as PCR product comparing them with the DNA ladder. The target gene was obtained from of *S. pyogenes* and *S. dysgalactiae subsp. equisimilis*. . The result was confirmed by identifying the gene sequences and comparing it with the database in NCBI, which showed a similarity of more than 98% and the percentage of similarity between the genes of the different species was more than 99%. The *sk* gene for both species were digested with *BtgZI* and *MboII* restriction enzymes. The results of the agarose gel electrophoresis showed that the gene belonging to the *S. pyogenes* possesses restriction sites for *BtgZI* restriction enzymes that differ in location from that of the *S. dysgalactiae subsp. equisimilis*. Where the bundles appeared in different locations, which means that the location and number of restriction sites differ between the two types, and this feature can be used to differentiate between them.

**Keywords:** *Sk* gene, Streptokinase, *Streptococcus*.

## Introduction

In view of the many changes occurring in the patterns of life, whether social or economic in general, in the world, an increase in the rates of many coronary heart diseases, caused by blood clotting in the arteries of the heart, which sometimes leads to death, has been observed. It leads to the stopping of blood circulation, in the physiological state, fibrin and platelets are used for clotting to prevent blood loss during injuries in a process called blood clotting<sup>[1]</sup>. Because of the high economic cost of tissue plasminogen activators, it was necessary to using the low expensive and more available, and since there are some bacterial species also have the ability to produce proteins play role as a plasminogen activators like Streptokinase and Staphylokinase<sup>[2]</sup>. The pathogenic bacteria differ in seriousness Infecting humans and animals according to the virulence factors they produce, so work has been made to convert the most dangerous virulence factors to humans and animals into effective compounds that can be used in the treatment of many diseases through the use of genetic engineering techniques<sup>[3]</sup>. An important virulence factor in causing

hemolysis, which is secreted by some bacterial species, is the streptokinase protein (SK) produced by some types of hemolytic streptococci of the genus *Streptococcus*, as it has been used as a treatment in dissolving blood clots as in cases of myocardial infarction since 1959 and in the treatment of Peripheral arterialocclusive since 1974 and is now widely used in many countries of the world<sup>[4]</sup>.

The streptokinase protein encodes for the *sk* gene, which has a size of 1.3 k bp<sup>[5]</sup>. it was first isolated in 1933 from a *Streptococcus* broth culture and named Streptococcal fibrinolysin<sup>[6]</sup>. The term Streptokinase was used for the first time in 1945, and the amino acid sequence was fully determined by Jackson and Tang<sup>[7]</sup>. It is an extracellular protein secreted by hemolytic streptococcus bacteria (GAS), (GCS) and (GGS). It is a single-chain protein consisting of 414 amino acids with a molecular mass of 47 kDa that has the ability to bind to plasminogen and form a streptokinase - plasminogen complex. This complex turns plasminogen into active plasmin that breaks down fibrin, which is the main protein for blood clots<sup>[8]</sup>. SK is not in itself a plasminogen activator, but rather binds to free-circulating

plasminogen or with plasmin to form a complex that can convert another plasminogen into a plasmin<sup>[9]</sup>.

The aim of the study was to differentiate the different types of Streptococcus bacteria using the *sk* gene.

## Materials and Method

**Samples Collection:** Bacterial isolates were collected from the laboratories of Al-Amiriya General Hospital (Al-Anbar) and the educational laboratories in the City of Medicine (Baghdad), from various pathological conditions (Table 1). The isolated diagnosis by Biochemical test<sup>[10,11]</sup> and confirmed with the Vitek-2 Compact.

**Table (1) Types and numbers of bacteria isolated and belonging to the genus Streptococcus.**

No. of isolates	Isolates	
1	Streptococcus pneumoniae	1
2	Streptococcus agalactiae	2
5	Streptococcus mutans	3
1	Streptococcus suis	4
2	Streptococcus pyogenes	5
1	S.dysgalactiae subsp. equisimilis.	6

### The ability of bacteria to produce Streptokinase:

To find out the ability of bacteria to produce streptokinase, a caseinolytic assay test was used. Broth culture of 18 hr. isolates was prepared. 1 mL of bacterial culture was taken from each culture and placed in a 1.5 ml Eppendorf tube. The cells were sonicated with an ultrasound machine and a portion of the shattered culture was used in caseinolytic assay. Mix 36 ml of buffer solution (mM Tris- HCL/150 mM NaCl) with 400 mg of agarose and after dissolving by heat add 2 ml of skim milk with 1 ml of blood plasma. It was mixed well and was poured into a petri dish. Well of 5 mm was made in the plate and 50 microliters were loaded from each sonicated culture in the well and incubated for 18 hours at 37 °C. the clear zone around the wells was measured<sup>[12]</sup>.

**Chromosomal DNA extraction:** DNA was extracted from various types of *Streptococcus* bacteria by (Genomic DNA extraction kit) from Geneaid Company. Process was done according to the instructions of the provider. Electrophoresis was carried out using a 1% agarose gel, where the samples were carried over with a voltage difference of 100 millivolts for an hour, and

the DNA was investigated by exposing it to a UV-transilluminator with a wavelength of 256 nanometers.

**Gene amplification and Purification:** The *sk* gene was amplified by Polymerase Chain Reaction (PCR) using DNA isolated from bacterial isolates using specific primers for *sk* gene (Forward: GGGA TTCCATATGATTGCTGGACCTGAG). (Reverse: CCGGAATTCTTATTTGTCTTTAGG)<sup>[13]</sup>.

The PCR device was programmed according to the steps taken by Bustin, 2004, after which an electrophoresis was performed using agarose gel at a concentration of 1.2% to read the products of the PCR reaction. Then, Purification was done using Gel/PCR DNA Fragments Extraction Kit. To purify the polymerase chain reaction products of the *sk* gene, the purification process was done according to the instructions of the provider.

**Gene Sequencing:** The PCR product were sequenced in Macrogen company (South Korea) using a Genetic Analyzer to obtain the gene sequences. The data were analyzed by Mega 7 software and compared with Ref. sequences which published in NCBI.

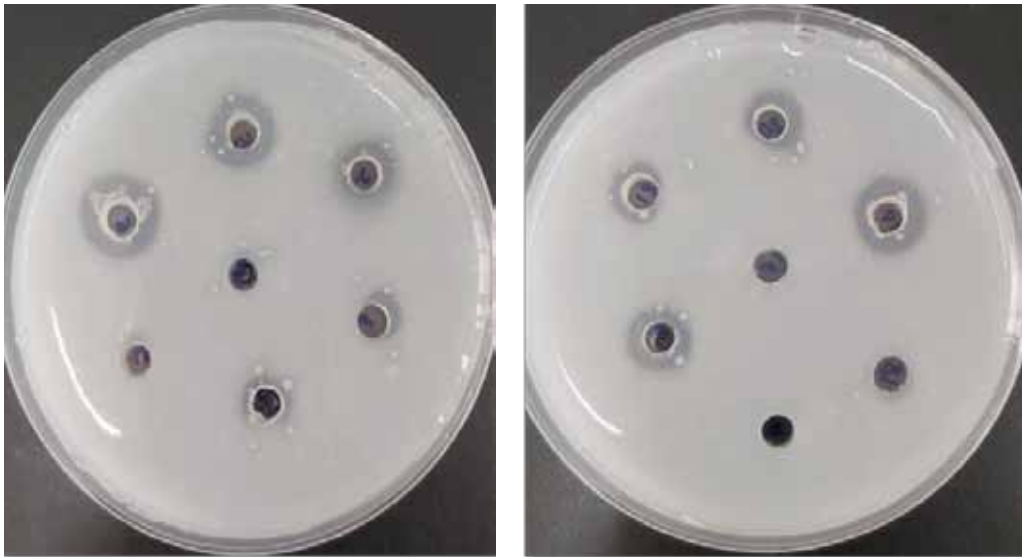
**Restriction Enzyme:** The restriction enzymes (*BtgZI* and *MboII*) were procured from NEBI (USA) and used according to the instructions of the supplying company.

## Results and Discussion:

**Caseinolytic assay test:** Table (2) and Figure (1) show the results of the caseinolytic assay for Streptokinase activity after 18 h incubation at 37°C.

**Table (2) Dimensions of dissolution in caseinolytic assay test for isolated bacteria**

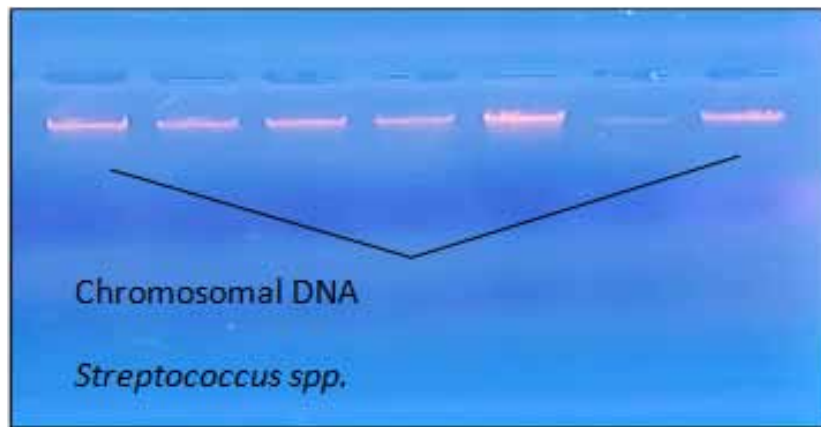
	Isolate	Diameter of zone
1	Streptococcus pneumoniae	6mm
2	Streptococcus agalactiae	10mm
2	Streptococcus agalactiae	12mm
4	Streptococcus mutans	11mm
5	Streptococcus mutans	14mm
6	Streptococcus mutans	15mm
7	Streptococcus mutans	9mm
8	Streptococcus mutans	12mm
9	Streptococcus suis	15mm
10	Streptococcus pyogenes	5mm
11	Streptococcus pyogenes	6mm
12	S.dysgalactiae subsp.equisimilis	9mm



**Figure (1): The result of caseinolytic assay and transparent area formation around the wells.**

**Chromosomal DNA extraction:** The agarose gel electrophoresis at a concentration of (1%) showed the emergence of a single band representing the chromosomal

DNA of the different species of the *Streptococcus* genus, which was detected using ultraviolet radiation and an ethidium bromide stain (Figure 2).



**Figure (2): Agarose Gel Electrophoresis (1%, 100 V/cm/60 min.) for Chromosomal DNA extracted from different species of *Streptococcus* bacteria.**

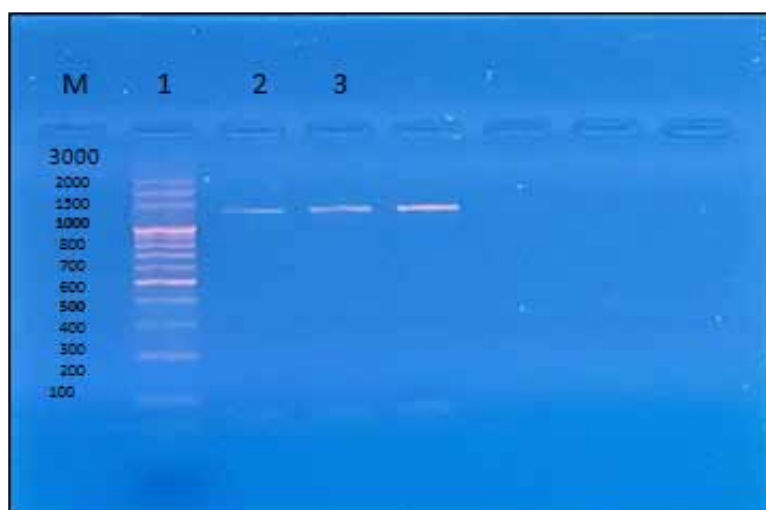
**Gene amplification and purification:** The results showed that the target gene was obtained from three isolates: *Streptococcus pyogenes*, *Streptococcus pyogenes* and *S.dysgalactiae subsp.equisimilis*. As for the other isolates, the reaction was carried out more than once, but the target fragment of the gene was not obtained even though the isolates gave a positive result in the caseinolytic assay test. The reason for not obtaining the *sk* gene from the rest of the bacterial isolates may be attributed to the fact that the isolates may not possess

the gene because they are not affiliated with the blood-analyzing bacterial strains of the Lancefield groups A, C, G.

Since the isolates in which the gene was isolated belong to the aforementioned bacterial strains and are of type A, C, and G, then this study is identical to previous studies, as all of them confirmed that all hemolysis bacterial strains belonging to the mentioned types contain the gene encoding to produce Streptokinase<sup>[15],[16],[17]</sup>.

Then, the process of purification of the polymerase chain reaction products of the *sk* gene was carried out using a Gel/PCR DNA Fragments Extraction Kit and

electrophoresis on a 1.2% agarose gel for one hour and detected under ultraviolet irradiation and the ethidium bromide, the following result showed in figure (3).



**Figure (3):** Gel Electrophoresis (1.2%, 100 v/cm/60 min) for PCR products for the Streptokinase encoded *sk* gene after gene purification using a Gel extraction kit. M: 100 bp DNA marker 1 : *S. pyogenes* 2 : *S. pyogenes* 3 : *S. dysgalactiae subsp. equisimilis*

***sk* gene sequences:** The PCR products were sent to Macrogen in South Korea, to determine the nitrogen base sequences of the DNA fragment of 1300 bp by the Sanger and Coulson method, or called the chain termination method. The results obtained from the company were then matched with the database at the National Center for Biotechnology Information (NCBI). The similarity between *sk* gene and their counterparts in NCBI were more than 98% for both species.

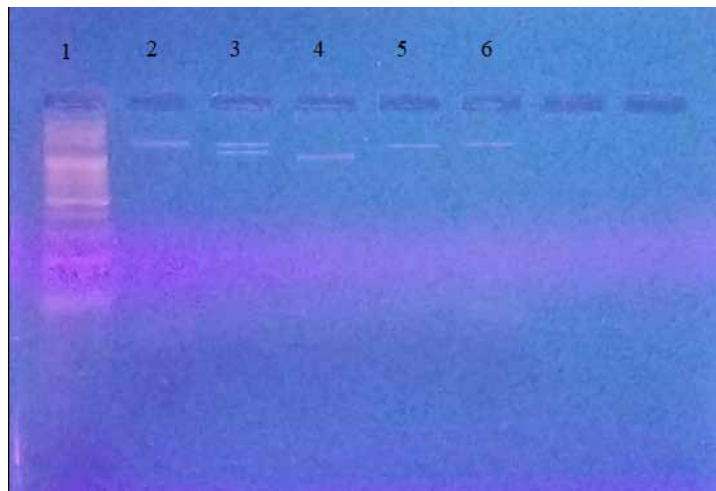
A comparison was also performed between the *sk* gene sequences of *S. pyogenes* and *S. dysgalactiae subsp. equisimilis* using the Mega 7 program, and the result was almost 99%.

**Restriction Enzyme:** The result of electrophoresis of the *sk* gene of *S. pyogenes* and *S. dysgalactiae subsp. equisimilis*. After treatment with the Restriction enzyme *BtgZI*, there was a difference in the position of the bundles on the agarose at a concentration of 1.5%. . This gives an indication that the location of the *BtgZI* Restriction enzyme sensitive sequence in the gene belonging to the *S. pyogenes* is in a different location on the gene map than the location of the sensitive sequence for the same enzyme for the gene belonging to *S. dysgalactiae subsp.*

*equisimilis*. The size of the DNA fragment removed from the gene in the *S. dysgalactiae subsp. equisimilis* was larger than the size of the fragment of DNA that was removed from the gene of *S. pyogenes* after being treated with the restriction enzyme Figure (4).

When the *sk* gene was treated with the *MboII* restriction enzyme for both types, there was no apparent difference in the size of the gene after treatment, and this may be due to the fact that the electrophoresis on the agarose gel does not give clear separation of the bundles of DNA segments with a difference of less than 50 bp<sup>[18]</sup>. Therefore, the use of vertical electrophoresis with SDS gel is better to separate DNA fragments whose size difference is less than 50 base pairs.

By reviewing the studies on the *sk* gene, we did not find any study indicating the possibility of differentiating the different types of the *Streptococcus* by treating the *sk* gene with restriction enzymes despite the presence of susceptible sites for many restriction enzymes in the gene sequences recorded in NCBI. Through our current study, it became possible to distinguish between the different species belonging to the genus *Streptococcus* through the *sk* gene after treatment with restriction enzymes.



**Figure (4) Agarose Gel Electrophoresis (1.5%, 100 v/cm, 60 min.) forsk gene restricted byBtgZI and MboII Restriction Enzymes at a concentration.**

**1-100 bp DNA Ladder 2- The sk gene is not treated with restriction enzymes 3-skgene for *S. pyogenes* treated with BtgZI4- skgene for *S. dysgalactiae* subsp. *equisimilis* with BtgZI5- skgene for *S. pyogenes* with MboII6- skgene for *S. dysgalactiae* subsp. *equisimilis* with MboII .**

### Conclusions

The results of the detection of the *sk* gene in beta-hemolytic bacterial isolates belonging to types A, C, and G are consistent with the results that all hemolysis bacterial strains of the aforementioned species contain the gene encoding the production of Streptokinase. Also, all of the studied Streptococcus isolates gave a positive result of the caseinolytic assay test, and this may give an indication of the presence of proteins having similar activity to that of Streptokinase. It was also found that the sequences of the *sk* gene were identical to what was published in the NCBI database at a rate of more than 98%, and at the same time, the sequences of the same gene belonging to two different species had a difference of less than 0.5%. The *sk* gene contains sensitive sites for many restriction enzymes, through which it was possible to distinguish between the different strains of the Streptococcus genus through the *sk* gene after treatment with the *BtgZI* restriction enzyme.

**Ethical Clearance:** The Research Ethical Committee at scientific research by ethical approval of both environmental and health and higher education and scientific research ministries in Iraq

**Conflict of Interest:** The authors declare that they have no conflict of interest.

**Funding:** Self-funding

### Reference

1. Bhardwaj S, Angayarkanni J. Streptokinase production from Streptococcus dysgalactiae subsp. equisimilis SK-6 in the presence of surfactants, growth factors and trace elements. 3 Biotech. 2015 Apr 1;5(2):187-93..
2. Roohvand Farzin. Streptokinase for Treatment of Thrombotic Disorders: The end or the end of the beginning. Iranian Biomedical Journal, 2018, 22(3), 140.
3. Keramati Malihe, Aslani Mohammad Mehdi, Roohvand Farzin. In silico design and in vitro validation of a novel PCR-RFLP assay for determination of phylogenetic clusters of streptokinase gene alleles in streptococci groups. Microbial Pathogenesis, 2020, 139: 103862.
4. Baruah Dev B. et al. Plasminogen activators: a comparison. Vascular pharmacology, 2006, 44.1: 1-9.
5. Malke Horst, Ferretti Joseph J. Streptokinase: cloning, expression, and excretion by Escherichia coli. Proceedings of the National Academy of Sciences, 1984, 81.11: 3557-3561.
6. Tillet William S and Garner RL. The fibrinolytic activity of hemolytic streptococci. The Journal of Experimental Medicine, 1933, 58.4: 485-502.

7. Jackson Kenneth W, Tang Jordan. Complete amino acid sequence of streptokinase and its homology with serine proteases. *Biochemistry*, 1982, 21.26: 6620-6625.
8. Wang Zihui, Yu Xinge, LI Yang V. Zinc chelation promotes streptokinase-induced thrombolysis in vitro. *International Journal of Physiology, Pathophysiology and Pharmacology*, 2017, 9.5: 137.
9. Abed Hayder H, Alwasiti Estabraq Ar, Tawfeeq Amir T. Streptokinase Loading Fabrication Magnetic Nanoparticle Supported With Tannic Acid As A Modified Thrombolytic Agent. *Annals of Tropical Medicine and Health*, 2019, 22: 34-47.
10. Benson HJ. Antimicrobial sensitivity testing: the Kirby-Bauer method. *Microbiological Applications. Laboratory Manual in General Microbiology*, 7th ed. McGraw-Hill, Boston, Massachusetts, 1998, 139-141.
11. McFadden JF. *Biochemical Tests for Identification of Medical Bacteria*, Williams and Wilkins. Philadelphia, PA, 2000, 113.
12. Remmert LeMar F, COHEN Philip P. Partial purification and properties of a proteolytic enzyme of human serum. *Journal of Biological Chemistry*, 1949, 181.1: 431-448.
13. Buniya Harith K, Murugan Vadivel, Thangadurai Chinnathambi. Cloning and expression of hybrid streptokinase towards clot-specific activity. *Journal of Microbiological Method*, 2014, 98: 84-88.
14. Bustin, S A. (Ed.). *AZ of quantitative PCR*. La Jolla, CA: International University Line, 2004, 439-492 .
15. Kazemi Faegheh et al. Computational simulations assessment of mutations impact on streptokinase (SK) from group G streptococci with enhanced activity—insights into the functional roles of structural dynamics flexibility of SK and stabilization of SK–µplasmin catalytic complex. *Journal of Biomolecular Structure and Dynamics*, 2019, 37.8: 1944-1955.
16. Turner Claire E, Bubba Laura, Efstratiou, Androulla. *Pathogenicity Factors in Group C and G Streptococci. Gram-Positive Pathogens*, 2019, 264-274.
17. Keramati Malihe, ASLANI Mohammad Mehdi, Roohvand Farzin. In silico design and in vitro validation of a novel PCR-RFLP assay for determination of phylogenetic clusters of streptokinase gene alleles in streptococci groups. *Microbial Pathogenesis*, 2020, 139: 103862.
18. Green Michael R, Sambrook Joseph. *Analysis of DNA by agarose gel electrophoresis. Cold Spring Harbor Protocols*, 2019, 2019.1: pdb. top100388.



# Impact of Vitamin D Elements in Insulin Sensitivity in Type 2 Diabetes Mellitus (DM2)

Wafaa Raji Alfatlawi<sup>1</sup>, Zainab Majid Ali<sup>2</sup>, Muhammed Abdul-Gabar Aldabagh<sup>3</sup>

<sup>1</sup>Assist Prof., <sup>2</sup>M.Sc. Student, University of Technology, Baghdad, Iraq, Applied Science Department, Applied Chemistry Science, <sup>3</sup>Assist Prof., Al-Nahrain University, Baghdad, Iraq, College of Medicine, Medical Research Unit

## Abstract

Numerous non-skeletal diseases have been reported to be associated with vitamin D status including type2 diabetes mellitus (T2DM). Different studies provide evidence that vitamin D status as well as other elements such as vitamin D binding protein (DBP) and vitamin D receptor (VDR) may play substantial role in glucose tolerance. Present study was designed to investigate the role of vitamin D status and their elements in insulin resistance or sensitivity in T2DM patients Current study includes 84 participants of both gender (56 patients and 28 as control). Clinical samples were collected from clinically proved DM2 patients. Serum levels of insulin, FBS, VD, VDR, and DBP were measured of each subjects. Using of Homeostasis Model Assessment Insulin resistance (HOMA-IR), T2DM patients were sub grouped to insulin resistance (IR) and insulin sensitivity (IS) groups. Relations among studied factors, FBS showed significant positive and negative relation with HOMA-IR and VD3 respectively, furthermore HOMA-IR revealed significant positive relation with DBP and VDR. Also, DBP revealed significant positive relation with each of VDR and HOMA-IR. On the other hand, VD3 levels showed significant and non-significant elevation in IS group compared to C and IR group respectively, while DBP revealed significant and non-significant dropping in IS group compared to C and IR groups respectively. Levels of VDR in IS group showed significant dropping compared to C and IR groups respectively. Our study concludes that VD3 alone or with its elements play substantial role in regulation of blood sugar levels particularly related to insulin sensitivity.

**Keywords:** T2DM, Vitamin D elements, HOMA-IR.

## Introduction

Diabetes mellitus is a chronic disorder that affects several populations among the whole world and it is regarded as a widespread health problem<sup>[1]</sup>. Diabetes also affects individuals of different ages and health status, as it affects the rich and poor, men and women, as well as adults and children, and it is a disease that has sufficient capacity to destroy the body<sup>[2]</sup>. Also, diabetes is caused by an imbalance of hormones such as insulin and glucagon, which are the hormones responsible for regulating the level of glucose in the blood in order to stabilize the level of glucose<sup>[3]</sup>.

Since there is scientific evidence on the relationship between the deficiency of VD3 levels and diabetes, people at risk of diabetes should be examined for low VD3 levels to improve their health in the long run, as

vitamin D deficiency is linked to high blood glucose, insulin resistance, high blood pressure, and heart disease<sup>[4]</sup>.

Deficiency of vitamin D was found to have the principal role among insulin resistance. Hence, there may be a risk of developing diabetes. Many studies have explained that vitamin D deficiency plays a role in insulin deficiency, and it is closely linked to an inherited polymorphism, including the protein associated with vitamin D (vitamin D binding protein (VDBP), the vitamin D receptor (VDR), and the alpha-hydroxylase gene vitamin D1. All of these measures work to balance glucose in addition to mediating insulin sensitivity. There is an evidence explores the relation between VD3 case and insulin resistance, but further discoveries are required. From those evidences, it is clear that VD3 plays an important role in the molecular processes of

synthesis, secretion as well as the peripheral sensitivity of insulin [5].

The pathophysiology of T2DM development, which plays the role of insulin resistance in muscle and liver cells, can be mentioned here, which means weak insulin signal given to cells, resulting in decrease in the glucose uptake and increase in the output of hepatic glucose, accompanied by failure of beta cells in the pancreas for producing enough insulin in order to maintain normal levels of glucose in blood and to prevent releasing of adipose fatty acids [6].

VDR are expressed by the pancreatic cells, human skeletal muscle as well as adipose tissue that are the main elements of peripheral insulin sensitivity[7].

The present study was designed for investigating the effects of vitamin D elements as VDR and V BDP in insulin sensitivity in development of type 2 diabetic patients.

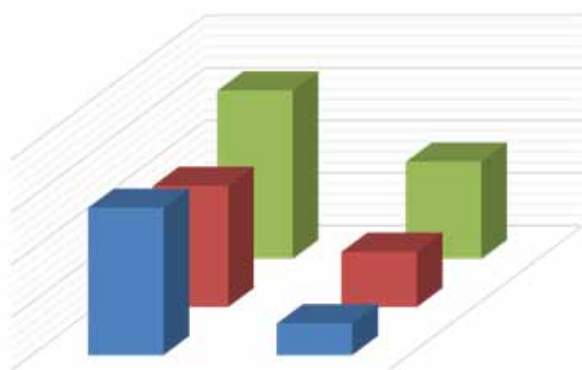
## Materials and Method

In this study, 84 participants of both gender (56 patients and 28 as control). Clinical samples were collected from patients who were clinically proved with T2DM. From patients and control subjects, in fasting state by venipuncture, using a 5ml syringe between 8 to 9 A.M, 3 ml of blood were obtained and dispensed in a plain tubes and left for hour to clot at room temperature (22°C). Then, it was centrifuged at 3000 rpm for 10 minutes to collect serum . The serum was divided in to aliquots in eppendorff tube for measuring the (VD3, VDR, VDBP, FBS, and Insulin). Estimation of serum levels of vitamin D3, VDR, DBP, and insulin was done using the commercial ELISA kit of Sun long/China, in addition to measuring of serum levels of fasting blood sugar (FBS) using Biolab Glucose kit.

Statistical analysis was done using SPSS (Statistical Packages for Social Sciences- version16).

**Table (1) Patients and control classified according to HOMA model**

Factor	C M±SD	IS M±SD	IR M±SD	P-value		
				C:IS	C:IR	IS:IR
HOMA-IR	1.231±0.409	2.058±0.527	3.65±1.229	0.000	0.000	0.000
Insulin (mU/L)	5.576±1.849	4.594±0.936	6.391±2.046	0.020	0.072	0.000
FBS (mg/dl)	89.308±8.957	184.72±42.415	234.076±54.922	0.000	0.000	0.000



**Figure (1) Patients and control classified according to HOMA-IR model.**

## Results and Discussion

Table (2) and Fig (2) show the mean of VD3 in studied group. There was highly significant difference between C and IS patient group (20.118±9.371), (28.481±7.909), p-value (0.004) respectively . While there was non significant difference between C and IR patient group (20.118±9.371), (25.666±10.416), p-value (0.07), also there was non significant difference between IS and IR patient group (28.481±7.909), (25.666±10.416), p-value (0.361) respectively.

**Table (2) Show the mean VD3 in studies group:**

Factor	C M±SD	IS M±SD	IR M±SD	P value		
				C: IS	C: IR	IS: IR
VD3	20.118±9.371	28.481±7.909	25.666±10.416	0.004	0.075	0.361
DBP	0.47±0.255	0.394±0.14	0.582±0.226	0.152	0.050	0.001
VDR	2.082±0.975	1.644±0.394	1.905±0.772	0.026	0.979	0.024
FBS	89.308±8.957	184.72±42.415	234.076±54.922	0.000	0.000	0.000
HOMA-IR	1.231±0.409	2.058±0.527	3.65±1.229	0.000	0.000	0.000
INSULIN	5.576±1.849	4.594±0.936	6.391±2.046	0.020	0.072	0.000

Insulin sensitivity and insulin resistance are two aspects of the same coin, meaning that decrease the body sensitivity to insulin means presence of insulin resistance. Whereas insulin resistance is harmful to the body health, insulin sensitivity is advantageous<sup>[5]</sup>. Vitamin D deficiency can be the reason for imbalance of glucose and also can play a role in insulin resistance as well as the.

T2DM pathogenesis, via its impacts on both  $\beta$ -cell function and insulin sensitivity. It was found that vitamin D deficiency could affect insulin resistance throughout different mechanisms involving the increase in related pro-inflammatory cytokines as well as acute phase reactants. So, correction of VD3 levels help in regulation of insulin secretion from the pancreatic beta cells<sup>[8]</sup>. This results disagree with the results of Tee garden & Donkin<sup>[9]</sup> who found that serum concentration of VD3 status, has been related with improved glucose homeostasis and increased insulin sensitivity. The supposed effect of VD3 on insulin sensitivity might be via increasing the muscle mass that could enhance the insulin sensitivity within whole body.

Nag pal et al.<sup>[10]</sup> has revealed that VD3 supplementation could possibly affect the peripheral insulin sensitivity.

Numerous studies have revealed the effect of VD3 supplementation on glucose homeostasis. It was revealed that insulin resistance appeared to be diminished in patients with T2DM who had received VD3. Gagnon et al.<sup>[11]</sup> showed an improvement in insulin sensitivity by increasing the concentration of 25 (OH)D in serum.

In the present study, a significant negative correlation was found between VD3 and fasting blood sugar (FBS) as (p-value = 0.041) indicating that VD3

deficiency is significantly correlated to increasing the fasting blood glucose levels which helps in predicting T2DM. The findings of this study agree with the findings by Mackawy & Badawi, have detected a significant negative correlation between vitamin D levels and FPG (p-value=0.036), insulin levels and HOMA-IR (pvalue=0.563)<sup>[12]</sup>.

Table (2) and Fig (2) show the mean of VDBP in studied group . There was non significant difference between C and IS patient group (0.47±0.255), (0.394±0.14),p-value (0.152) respectively . AS well as there was significant difference between C and IR patient group (0.47±0.255), (0.582±0.226),p-value (0.050), also there was highly significant difference between IS and IR patient group (0.394±0.14), (0.582±0.226), p-value (0.001).

Identification of VDBP levels in serum is valuable in understanding the diabetic state<sup>[13]</sup>. Fawzy & Beladi<sup>[14]</sup> have studied the correlation between circulating VD3, DBP, and VDR expression and the diabetic nephropathy severity in a group of Saudi population with T2DM. It was found that serum levels of VDBP were significantly increased in the whole patient groups.

Ashraf et al.<sup>[15]</sup> have conducted a study to investigate relations between the total, free, as well as the bioavailable 25(OH) D and vitamin DBP in addition to evaluating the correlations of vitamin VDBP with insulin resistance indicators. From that study, it was suggested that concentrations of VDBP were controlled by total 25(OH)D levels for maintaining suitable concentrations of bioavailable 25(OH)D. Also, there was an inverse correlation between VDBP concentrations and insulin resistance.

Table (2) and Fig (2) show the mean of VDR in

studied group . There was significant difference between C and IS patient group (2.082±0.975), (1.644±0.394), p-value (0.026) respectively . On the other hand there was non significant difference between C and IR patient

group (2.082±0.975), (1.905±0.772), p-value (0.979), While there was significant difference between IS and IR patient group (1.644±0.394), (1.905±0.772), p-value (0.024) respectively.

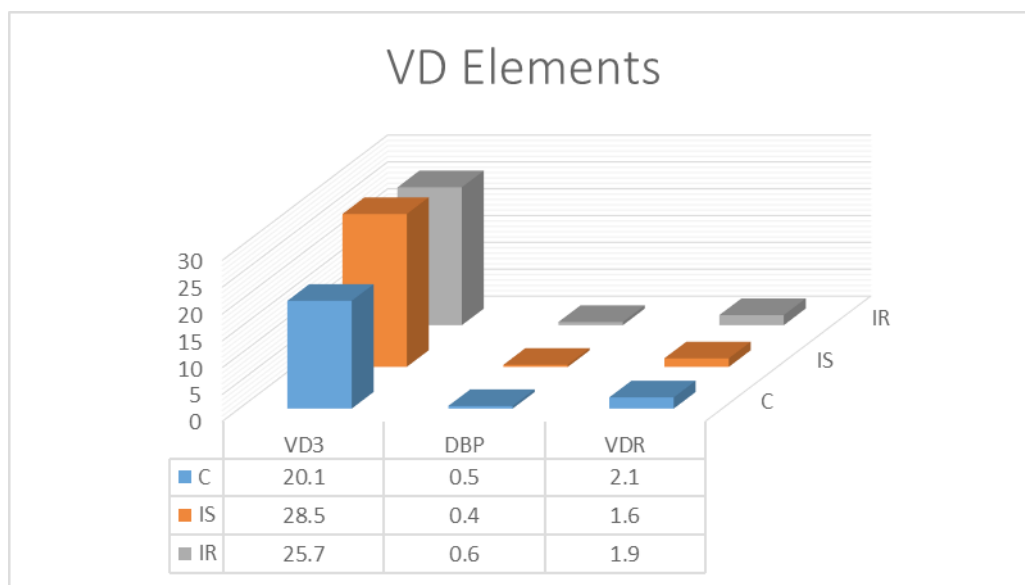


Figure (2) VD3 in studies group

Similarly, there was statistically significant differences between the means of HOMA-IR according to C group, IS group, and IR group = (1.231±0.409, 2.058±0.527, and 3.65±1.229, respectively) and p-value for all = (0.000).

The assesses of HOMA-IR as well as fasting insulin were found to be reduced with high levels of 25(OH) D<sup>[16]</sup>. The findings of this study have revealed a negative correlation between HOMA-IR and VD 3, although it was non-significant (p-value= 0.563). The findings of the current study agree with chun et al <sup>[17]</sup> who has conducted a study on Chinese people with T2DM, and he found a negative correlation of IR and the related biomarkers with 25(OH)D status. Similarly, an inverse

correlation of IR with 25(OH)D concentration has been detected for values of 25(OH)D between (16-36) ng/mL<sup>[17]</sup>.

**Correlation between parameters:** There was positive non significant correlation between VD3 with VDBP (p-value=0.318),also there was positive non significant correlation between VD3 with VDR (p-value=0.432),Also there was negative significant correlation between VD3 with FBS (p-value=0.036), Aswell as negative non significant correlation between VD3 with HOMA-IR(p-value=0.563), On the other hand there was positive non significant correlation between VD3 with insulin (p-value=0.276).

Table (3) Correlation between vitamin D3 and different parameters:

Item		VD3	DBP	VDR	FBS	HOMA-IR	Insulin
VD3	Pearson Correlation	1	.108	.085	-.223*	-.062-	.117
	Sig. (2-tailed)		.318	.432	.036	.563	.276
	N	88	88	88	88	88	88
DBP	Pearson Correlation	.108	1	.771**	-.027-	.424**	.743**
	Sig. (2-tailed)	.318		.000	.801	.000	.000
	N	88	88	88	88	88	88

Item		VD3	DBP	VDR	FBS	HOMA-IR	Insulin
VDR	Pearson Correlation	.085	.771**	1	-.088-	.368**	.737**
	Sig. (2-tailed)	.432	.000		.415	.000	.000
	N	88	88	88	88	88	88
FBS	Pearson Correlation	-.223*	-.027-	-.088-	1	.722**	-.049-
	Sig. (2-tailed)	.036	.801	.415		.000	.648
	N	88	88	88	88	88	88
HOMA-IR	Pearson Correlation	-.062-	.424**	.368**	.722**	1	.598**
	Sig. (2-tailed)	.563	.000	.000	.000		.000
	N	88	88	88	88	88	88
Insulin	Pearson Correlation	.117	.743**	.737**	-.049	.598**	1
	Sig. (2-tailed)	.276	.000	.000	.648	.000	
	N	88	88	88	88	88	88

## Conclusion

From this study, it is concluded that, there is a relation between VD3 either alone or with its elements as VDBP and VDR, play a significant role in regulation of blood sugar levels particularly related to insulin sensitivity.

**Ethical Clearance:** The Research Ethical Committee at scientific research by ethical approval of both environmental and health and higher education and scientific research ministries in Iraq

**Conflict of Interest:** The authors declare that they have no conflict of interest.

**Funding:** Self-funding

## Reference

- Dilaveris P, Antoniou CK, Manolakou P, Tsiamis E, Gatzoulis K, Tousoulis D. Biomarkers associated with atrial fibrosis and remodeling. *Current Medicinal Chemistry*. 2019 Feb 1;26(5):780-802.
- Bastaki A. Diabetes mellitus and its treatment. *International journal of Diabetes and Metabolism*. 2005 Jan 1;13(3):111.
- Lotfy M, Adeghate J, Kalasz H, Singh J, Adeghate E. Chronic complications of diabetes mellitus: a mini review. *Current diabetes reviews*. 2017 Feb 1;13(1):3-10.
- Asif M. The prevention and control the type-2 diabetes by changing lifestyle and dietary pattern. *Journal of education and health promotion*. 2014;3.
- Nakashima A, Yokoyama K, Yokoo T, Urashima M. Role of vitamin D in diabetes mellitus and chronic kidney disease. *World journal of diabetes*. 2016 Mar 10;7(5):89.
- Espes D, Martinell M, Carlsson PO. Increased circulating betatrophin concentrations in patients with type 2 diabetes. *International journal of endocrinology*. 2014 Oct;2014.
- Szymczak-Pajor I, Śliwińska A. Analysis of association between vitamin D deficiency and insulin resistance. *Nutrients*. 2019 Apr;11(4):794.
- Gorska-Ciebiada M, Ciebiada M. Association of hsCRP and vitamin D levels with mild cognitive impairment in elderly type 2 diabetic patients. *Experimental Gerontology*. 2020 Mar 17:110926.
- Teegarden D, Donkin SS. Vitamin D: emerging new roles in insulin sensitivity. *Nutrition research reviews*. 2009 Jun;22(1):82-92.
- Nagpal J, Pande JN, Bhartia A. A double-blind, randomized, placebo-controlled trial of the short-term effect of vitamin D3 supplementation on insulin sensitivity in apparently healthy, middle-aged, centrally obese men. *Diabetic Medicine*. 2009 Jan;26(1):19-27.
- Gagnon C, Daly RM, Carpentier A, Lu ZX, Shore-Lorenti C, Sikaris K, Jean S, Ebeling PR. Effects of combined calcium and vitamin D supplementation on insulin secretion, insulin sensitivity and  $\beta$ -cell function in multi-ethnic vitamin D-deficient adults at risk for type 2 diabetes: a pilot randomized, placebo-controlled trial. *PloS one*. 2014 Oct 9;9(10):e109607.

12. Mackawy AM, Badawi ME. Association of vitamin D and vitamin D receptor gene polymorphisms with chronic inflammation, insulin resistance and metabolic syndrome components in type 2 diabetic Egyptian patients. *Meta gene*. 2014 Dec 1;2:540-56.
13. Wang Y, Shi H, Jiang S, Zhao J. Changes in serum and urine vitamin D binding protein concentrations in type 2 diabetes. *Chinese Journal of Endocrinology and Metabolism*. 2015 Jan 1(7):592-5.
14. Fawzy MS, Beladi FI. Association of Circulating Vitamin D, VDBP, and Vitamin D Receptor Expression with Severity of Diabetic Nephropathy in a Group of Saudi Type 2 Diabetes Mellitus Patients. *Clinical laboratory*. 2018 Oct 1;64(10):1623.
15. Ashraf AP, Huisingh C, Alvarez JA, Wang X, Gower BA. Insulin resistance indices are inversely associated with vitamin D binding protein concentrations. *The Journal of Clinical Endocrinology & Metabolism*. 2014 Jan 1; 99(1):178-83.
16. Fawzy MS, Abu AlSel BT. Assessment of vitamin D-binding protein and early prediction of nephropathy in type 2 saudi diabetic patients. *Journal of diabetes research*. 2018 Apr 3;2018.
17. Chun RF. New perspectives on the vitamin D binding protein. *Cell biochemistry and function*. 2012 Aug;30(6):445-56.

# Angina and Sudden Fatal (Arrhythmia) Cardiac Disorders that affect People with the Presence of Risk Factors that Show a Change in the Electrical Conductivity of the ECG

Salah Abd-Al Kader Omran

Assist. Prof., M.Phil. Med. Cardiologist, Al-Muthanna University, College of Medicine, Iraq

## Abstract

The work was from realistic academic applied practice for research in the General Teaching Hospital/ Specialized Center for Chronic Diseases and Diabetes Mellitus on a group of patients in the city of Samawah-Iraq for the period (2019-2020). The total number of patients is (1250) patients divided (500 young men of both sexes) (and women are 350 patients after 50 years old) (and men 400 patients after 50 years) the research focused on heart disorders) arrhythmia) That threaten human life, especially in a middle-income country, and the detection and strengthening of medical capabilities and reduce deaths and the occurrence of sudden death, the work was focused on arrhythmia, And to the different heart diseases that help their emergence, to the real causes that arise from them (exocardil and endocardil) and to the calculation of the formula that calculate the pulse, respiration, oxygenation, cardiac output, blood pressure and the number of arrhythmia (heart disorders) per minute, hour or day, in addition to laboratory and radiological analyzes, Physical examination and the formation of a scientific formula, and we have adopted three important strategies in our work.. Cases decreased arrhythmia By controlling basic heart disease, the primary treatment is the major disease that causes it arrhythmia According to its cardiac or extra cardiac origin, the mortality rate decreased, in emergency cases and resuscitation (I.C.U) because of AF, in general and critical cases, the cost of treatment and health for the patient and for the state has decreased and the types arrhythmia, It was completed according to the program and the used treatment protocols.

**Keywords:** *Arrhythmia, Angina pastors, ECG, Factor risk, Echocardiography.*

## Introduction

### Introduction

The main objective is the early control of cardiovascular diseases, especially the Arrhythmia, and their types that cause sudden cardiac death (SCD) before and after angina pectoris and the chronic diseases that accompany them and which contribute greatly to the development of the Arrhythmia and irregular heartbeat that affects young people and the elderly without discrimination, and we contribute to the calculation and equation of cardiac changes and finding ways Therapeutic treatment for preventing and treating heart disorders.

Due to the rise in cardiovascular diseases that cause the death of many people, especially in the country of Iraq, the focus and work was on the most basic problems

as a result of the violent conflict of life, pollution, wars, their remnants, and the various risk factors surrounding the place, where a third of men and a quarter of women die of ischemia heart disease and their stroke <sup>[1]</sup> A group of signs appear that shows lack of access to the necessary amount of oxygen to the heart muscle crossing it, and they constitute a clinical syndrome, not a disease<sup>[6]</sup>. It may occur when there is an imbalance between the delivery and required oxygen supply to the heart muscle. Coronary stenosis and sclerosis are the most common cause of angina pectoris .. and associated cardiac disorders (Arrhythmia): Arrhythmias are a disturbance in the electrical rhythm of the heart. Arrhythmia is often a manifestation of structural heart disease, <sup>[2,3]</sup> but it may also occur in the normal heart context. Symptoms are more likely to occur if the arrhythmia is associated with the maximum heart rate.<sup>[5]</sup> An arrhythmia can cause palpitations, dizziness, fainting, chest tightness,

or shortness of breath, and it can lead to heart failure or even sudden death.) Which forms the focus and the bulk of our research Knowing the real causes of death, the concrete results, the pathological anatomy, and the correct direction for doctors to study the cases by using the method to reduce them before and after the angina when it occurs, or the various chronic diseases that cause sudden cardiac arrest, therefore treatment and prevention strategies [22] have been returned to undergo strict evaluation based on the rule, evidence and evidence in clinical work And academically, it is useful to immediately recognize and protect people before most people are affected by various causes and from the transition of coronary artery disease and other diseases to an advanced stage, Before noticing the patients who have symptoms, but some of the people do not have a complaint, but the risk factors are present and they are ready for infection in addition to their family history, and the patients who show symptoms and periodically review the hospital and they have a file we have under control all according to the degree of severity, our main goal Protecting the patient from sudden heart attacks that do not distinguish between the young and the elderly,<sup>[4,8]</sup> especially after cardiac conditions that cause systolic arrest, ventricular arrhythmia, tremors, mechanical heart loss, and insufficient blood flow to the heart. We approved early clinical diagnosis, in addition to laboratory and radiographic, ECG,<sup>[9,10]</sup> Eco-cardiograph, cardiac –Angiography coronary, Halter, treadmill test ., cardiac stress test, cardiac catheterization PCI (Angioplasty) and ICD (pacemaker –implantable cardiac defibrillator) . And in cases that require immediate resuscitation, because the patient is exposed to unconsciousness and pulse, breathing may take some time to stop completely after cardiac arrest.

Physical death is unless immediate treatment is provided to him<sup>[11]</sup> The cause of sudden cardiac death (SCD) is usually the development of catastrophic heart disorders. AF (atrial fibrillation) And the most dangerous VF (ventricular fibrillation) And all the Arrhythmia in which lack of follow-up, initial medical advice, and coronary artery patients are the most common due to the risk factors surrounding the patient (high blood pressure, lifestyle, dietary behavior, increased cholesterol and triglycerides, atherosclerosis and diabetes mellitus, stases, Obesity and medications) The angina is stable or unstable, which develops myocardial infarction (MI) damage into the heart (necrosis) (STEMI, NSTMI),<sup>[12]</sup> That is why we were very interested in arithmetic, because it is one of the most common causes of death, Among the most famous of them are the arrhythmic according to the division of the pulse (Tachycardia, Bradycardia) and its various forms, but people may not feel symptoms, That lead sudden cardiac death (SCD) About 80% (VF) The patient may lose consciousness and die, But there are many types of Arrhythmia, The disease may not feel symptoms Just Heart palpitations, And pulse upon palpation pose line, Of different ages, but the most common in the elderly, VF, AF and those who highlighted the risk disorder .<sup>[17,21]</sup> And on the high importance of studying future cases in outpatient clinics and emergency .. We find that most of the people who have Arrhythmia 25% are treated with a digitalis medicine that comes to them by Arrhythmia-who are subjected to general anesthesia 50 % Are exposed to Arrhythmia, and 80% to patients after Acute Myocardial Infarction.<sup>[14]</sup> And neurological conditions that acute as coronary artery spasm (prinzmetal s” angina (vasospastic), in addition to anti-depressant drugs, and congenital malformations of the heart,<sup>[7,15]</sup> but the most famous and most severe cases

**Table (1): Of the most famous and most reasons that lead Arrhythmia**

No.	The main reason	Results
1.	Heart attack (myocardial infarction)	Part of the heart gets to him damage .
2.	Change in heart structure	Change in the shape of the heart valves, cardiac enlargement, cardiac aneurysm .
3.	Coronary artery disease	Coronary artery stenosis or blockage.
4.	Smoking and stress	Be the cause of the Arrhythmia .
5.	Drinking too much alcohol or caffeine	Possible reason Arrhythmia .
6.	Drug abuse and electrolytes imbalance	Possible change in electrolyte balance .
7.	Certain medication (such as digitalis)	Some medicines like, digitalis, anti-depressant, Erythromycin, clarithromycin, pentamidine, moxifloxacin, levofloxacin.
8.	Overactive thyroid gland (hyperthyroidism) or Hypo secretory (hypothyroidism)	Some patients have an overactive thyroid gland (tachycardia) or hypothyroidism (Bradycardia)



A heart rate of more than 100/minute is called a tachycardia and a heart rate of less than 60/minute is called a bradycardia . [16,19] But not all tachycardia or bradycardia means that he has a problem, for example, during exercise, stress and muscle exertion, There are doctors who differed in the division Arrhythmia ..But the most common and the most famous are types Arrhythmia, It is the University of Oxford, and we will only talk about the most famous, most frequent and their effects on the heart in the research:[18,20]

## Materials and Method

The work was done based on the data and what were caused by heart disease disorders, the academic clinical work was done in the Teaching Hospital/and the Specialized Center for Chronic Diseases and Diabetes in the city of Samawah - Iraq for the period (2019-2020) to collect the largest number of patients and the disease history of different ages (Young men of both sexes 500), women 350 patients after the age of 50 years (and men 400 patients after the age of 50 years) randomly from different segments of society 1250 patients The main goal was to reduce and maintain early angina pectoris and accompanying cardiac disorders And to protect against sudden cardiac arrest, the act was to prevent angina pectoris and malignant heart disorders) rhythm, Rate) that develop without the patient's awareness. - Therefore, the formula was calculated :

The rate of Arrhythmia = number of Arrhythmia in (ECG) x Time (minute, hour, day)

And the calculation of the quantity and times and their type come in the form of repeated or continuous shifts and how many are the number, if there are more than 10 per hour it is considered a disease condition (Extrasystoles, any type of Arrhythmia or persistent) is determined with its quality, It means normal breathing per minute from 12 to 16, i.e. the number of breaths per minute x 4 beats. To help us to determine the quality of breathing and pulse, and calculate the

Volume of blood per minute= =[Heart rate x stroke volume] 70 x 70 mL = 4,900 blood volumes per minute

To know the insufficiency of cardiac impulse, And the cardiac cycle (major and minor) - the cardiac cycle is one major cycle Systemic But the blood is divided into (To nourish: the carotid brain cycle, Pulmonary cycle, clinic ileum cycle, Liver Portal Circulation (portal), The blood circulation cycle in the body in the case of sports

activity where there are sensors to increase blood, or in the case of sexual intercourse blood collects in the pelvis for an erection Therefore, in normal cases we do not feel the work of these devices inside the body, except in abnormal cases that appear and the patient feels gases and stomach pain .. The pulse is fast or slow, depending on the state of sleep. Jogging, resting, being a difference in the pulse that links there are causes Extracardial and the reasons for Endocardial are important in the application of the arrhythmia rate formula :

(AR) = [ECG algorithm (Pulse-Oxygen) + Chronic Disease + Recurrence status + Factor Risk + Completion + Treatment].

In addition to laboratory analysis, radiological, Echo-study, treadmill test, Halter, Stress test, ECG, diagnostic and therapeutic cardiac catheters, catheters Ablation, pacemaker, ECG, Effort test, physical Exemption, DC-shock (electric), Atherosclerosis (Retiring automaticity TO (SA--NOD), Carotid Massage, Valsalva manoeuvre (vagal), Bp, Pharmacology Test (Using atropine 0.5 diluted with water intravenously to see the extent of the increase in the pulse in the case of the block and the decrease in the heart rate), **1) strategy-** The early system of prevention and treatment, the dimensions of risk factors and the true cause of arrhythmia, **2) strategy-** The patient is included in the periodic program of Intensive Cardiac program (I.C.P) making a check-up every 3 months, **3) Strategy-** The most effective treatment chosen is the most effective depending on the calculation of the dose: Initial dose, therapeutic dose, maintenance dose, lethal dose, And the safe dose that does not cause side effects to the patient, we used medicines : For stomach, colon (GIT) and constipation: PPI Omprazole 20 mg. Colon Spasmen tablets, for Anti-constipation Laxdale tablets, lactulose syrup, Enema, Anti-fungal, anti-inflammatory of the urinary tract, anti-inflammatory pulmonary, and antihypertensive and heart medications group: ACE, Angiotensin II receptor (ARB<sub>s</sub>), Ca<sub>2</sub><sup>+</sup> Channel Blockers, diuretic, sotalol tablet, (Amidaron 200mg Pills limited time 2 days off holiday in weak), Antioxidants, denxit (Antidepressant), Isosorbide dinitrate, Isosorbide mononitrat 20, 10, 5mg, propafenone, flecanide, aspirin, Plavix, Warfarin, Heparin, thrombolytic Acetylates in Resuscitation, Anti-libedemia statin, vibrate, Mg supplement tablet, Omega 3 tab, Vit B<sub>12</sub>, Diabetes medications (metformin tab 500mg, diaonl tab 5mg, Ameral tab 1-6 mg, insulin soluble, mixture, lente), Digoxin 0.25, hydrocortisone, anti-allergic drug, fluid

I.V, Glucagon Vial for hypoglycemia, Feroplex (Iron), And by using studied scientific strategies, treatment and correct orientation of the lifestyle, calculation and application of formula that focus on the arrhythmia, And its origin, the true cause, and the early prevention prematurely, which helped a lot to curb the arrhythmia disease in the reduction of heart disorders and through careful follow-up of patients, **Especially young people** of both sexes. And knowing the real reason for the inheritance and their arrival to a state of stability : 65% arising from a nervous source, cramps and constipation, especially irritable bowel, gas, and gastrointestinal disorders, hypo –hyper thyroidism, Thyroid gland 6.2%, discomfort, adequate sleep, mental state, hope, stress, anxiety, high temperature, and food regulation 36.3%, anemia 4.1%, polycythemia 3.2%, Incorrect use of drugs 6.1%, I.H.D. 0.8%, Myocarditis 0.001%, pericarditis 0.002, Cardiomyopathy 0.002, Myocarditis 0.002 >> Diseases of the heart valves 6.2%, rheumatic heart disease 2.1%, pericarditis 0.002%, Congenital heart disease 0.02%, heart failure 0.0001, pulmonary embolism 0.001, Hypertension 11%, Tachyarrhythmia 3%, bradyarrhythmia 4.1%, Atrial fibrillation(AF) 0.7%, ventricle fibrillation 0.0001%, Extrasystoles (ectopic) 3.4%, prolong Q-T 0.6% . heart block 2.3%, .wolf Parkinson syndrome 0.02%, DC shock VT 1.2% Atrial flutter 0.0.01% . pacemaker (ICD Implantable cardiac defibrillator) 0.2%, Catheter ablation therapy 0.6%, As for the majority of **women after 50 years** of age, they are more prone to heart disease and pressure: - Anemia 7.2%, pressure BP 13.3%, diabetes 12.4%, ischemia heart disease 9.1%, stomach and intestinal disorders 7.1%, chronic diseases 12%, Tachyarrhythmia 4%, bradyarrhythmia 2.5.%, prolong Q-T 1.2%, Atrial fibrillation(AF) 4.7%, wolf Parkinson syndrome 0.01%, ventricle fibrillation 0.03%, Exstrasystoles (ectopic) 9.4%, STEMI 3.1%, NSTEMI 4%, ventricle tachycardia

5.3%, Atrial tachycardia 4.3%, Atrial breadycardia 2.1%, Aheart block 3.3%, Stroke 0.3%, Cardiac catheterization PCI 6.2%, DC cardioversion 0.8%, Catheter ablation therapy 5.1%, Arterial flutter 1.7%, Cardiomyopathy 0.4%, Diseases of the heart valves 6.2%, rheumatic heart disease 0.7%, pericarditis 0.4%, Congenital heart disease 0.3%, heart failure 1.7%, pulmonary embolism 0.02%, - As for **men after 50 years**, they are more likely to suffer from stress and more care for them as a result of the health and economic conditions that have negatively affected them. More attention is needed, the most prominent of which are: anemia 1.6%, polycythemia 0.4%, ischemia 12.2%, pressure 12.1%, diabetes 15.2%, pacemaker (ICD) 1%, Catheter ablation 1.2%, DC cardioversion, Arterial fibrillation (AF) 3.1%, Ventricle tachycardia 5, 4%, Arterial tachycardia 4.1%, Arterial breadycardia 2%, Ventricle Fibrillation 0.6%, Extrasystoles 6.2%, prolong Q-T 0.8% Heart Block 2.1% heart block 2.1%, L.V desfecation 9.2%, tachycardia 6.2%, bradycardia 0.6%, wolf Parkinson syndrome 0.001%, Arial flutter 2.6%, STEMI 4.2%, NSTEMI 6.1%, Cardiac catheterization PCI: 3%, catheter ablation 2.1%, Myocarditis 0.01%, Cardiomyopathy 1.3%, Diseases of the heart valves 3.2%, rheumatic heart disease 1.2%, pericarditis 0.2%, Congenital heart disease 0.3%, heart failure 7.1%, pulmonary embolism 0.0.1%, Hypertension 12.2%, Therefore, the work was as a key and an indicator of the dimensions of the risk factors and the real cause of the Arrhythmia, the calculation of the recombinant rates and the programs. (ICP) Intensive Care Program with the initial stability, And the early treatment plan for heart disease and the accompanying chronic diseases. As for patients who complain of heart valve diseases(transplantation), open-heart operations, congenital anomalies that need surgery, they are referred to heart surgery to stabilize their health condition.

**Table (2): Clinical coronary disease and pathology**

No	Clinical problem	Pathology
1.	Stable angina	Ischemia due to fixed athermanous stenosis of one or more coronary arteries
2.	Unstable angina	Ischemia caused by dynamic obstruction of a coronary artery due to plaque rupture with superimposed thrombosis and spasm .
3.	Myocardial infarction (MI)	Myocardial necrosis caused by acute occlusion of a coronary artery due to plaque rupture and thrombosis.
4.	Heart failure	Myocardial dysfunction due to infarction or ischaemia
5.	Arrhythmia	Altered conduction due to ischaemia or infarction
6.	Sudden death	Ventricular arrhythmia, a systole or massive myocardial infarction

## Discussion

The medical thinking stemmed from the analysis of laboratory and radiological data, method of examination, diagnosis, analysis of patients' cases, respiratory rate per minute, pulse and heart rate quality, blood analysis and electrocardiogram (ECG), Radiology, and all the necessary medical analyzes and supplies linked to the scientific references, the World Health Organization, international societies, and the approved work protocols were ready, present and organized in stages. We have adopted the creation of real equations that combine Information to help and develop a new technique surrounding fatal heart disorders, coronary artery disease, heart structure and curative solutions from their origin and to know the main cause of them. We worked with three early system strategies with the dimensions of risk factors and searched for real external causes such as chest infections, gastrointestinal disorders, hepatic, strokes, and inside the heart. Abnormalities or after myocardial infarction and myocardial emergence in dealing with them, their rate of occurrence, complete disease history and program Cardiac condenser and includes all supplies and diagnostic tests that help and stop the occurrence of germination and avoid it, And the patient's submission to the treatment plan and his response to it, and calculating the dose Initial dose, therapeutic dose, maintenance dose, The recurrence of the arrhythmia cases was of great importance to learn and review all measures to protect the patient and according to the cases that require transplantation pacemaker Or work catheter ablation Or open heart operations (CABH) By giving the appropriate medical decision . I am sure to take into account the patient's psychological and social condition and their family obligations. Among the most prominent arrhythmia at risk are: VF, AF, heart block, and Wolff-Parkinson-White syndrome, Extrasystoles to the many irregular and established origins arrhythmia AF, VF, Explained to us, it is determined on the ECG or ECG in the ablation catheter process that works by scanning the heart and determining the focus that causes the problem and ironing it and ending it with a thermal laser with a Keynes device to curb arrhythmia As for the majority of young people, it originated outside the heart, causes psychological states, and anomalies arrhythmia It was a clear and accurate indication for us to avoid it. As for women, they are the most different disorders of nervous origin, gastrointestinal disorders, colon and gynecological diseases, atherosclerosis, pressure, and coronary artery diseases. And chronic diseases associated with an increase or decrease in the thyroid

gland. As for men, they are more prone to stress, work, nervous and muscle spasms, coronary artery diseases, and chronic diseases that negatively affect their lives. Inform the impact on emergence arrhythmia Therefore, the evaluation was useful in developing scientific and applied capabilities .

## Results

We rely on results, data, and practical extrapolation of patients and disease cases that were dealt with and collecting the most prominent information that was a useful and beneficial indicator for patients :

**Young people** And knowing the real reason for the inheritance and their arrival to a state of stability : 65% arising from a nervous source, cramps and constipation, especially irritable bowel, gas, and gastrointestinal disorders, hypo –hyper thyroidism, Thyroid gland 6.2%, discomfort, adequate sleep, mental state, hope, stress, anxiety, high temperature, and food regulation 36.3%, anemia 4.1%, polycythemia 3.2%, Incorrect use of drugs 6.1%, I.H.D. 0.8%, Myocarditis 0.001%, pericarditis 0.002, Cardiomyopathy 0.002, Myocarditis 0.002 >> Diseases of the heart valves 6.2%, rheumatic heart disease 2.1%,pericarditis 0.02%, Congenital heart disease 0.02%, heart failure 0.0001, pulmonary embolism 0.001, Hypertension 11%, Tachyarrhythmia 5%, bradyarrhythmia 2.1%, Atrial fibrillation(AF) 0.7%, ventricle fibrillation 0.0001%, Exstrasystoles (ectopic) 3.4%,prolong Q-T 0.6% . heart block 2.3%, .wolf Parkinson syndrome 0.02%, DC shock VT 1.2% Atrial flutter 0.01% . pacemaker (ICD Implantable .

**Women after 50 years of age:** They are more prone to heart disease and pressure: Anemia 7.2%, pressure BP 13.3%, diabetes 12.4%, ischemia heart disease 9.1%, stomach and intestinal disorders 7.1%, chronic diseases 12%, Tachyarrhythmia 4%, bradyarrhythmia 2.5.%, prolong Q-T 1.2%, Atrial fibrillation(AF) 4.7%, venticwolf Parkinson syndrome 0.01%,ventricle fibrillation 0.03%, Exstrasystoles (ectopic) 9.4%, STEMI 3.1%,NSTEMI 4%,ventricle tachycardia 5.3%, Atrial tachycardia 4.3%, Atrial breadycardia 2.1%, Aheart block 3.3%, Stroke 0.3%, Cardiac catheterization PCI 6.2%, DC cardioversion 0.8%,Catheter ablation therapy 5.1%, Arterial flutter 1.7%, Cardiomyopathy 0.4%, Diseases of the heart valves 6.2%, rheumatic heart disease 0.7%, pericarditis s0.4%, Congenital heart disease 0.3%, heart failure 1.7%, pulmonary embolism 0.02%.

**Men after 50 years:** They are more likely to suffer from stress and more care for them as a result of the health and economic conditions that have negatively affected them. More attention is needed, the most prominent of which are: anemia 1.6%, polycythemia 0.4%, ischemia 12.2%, pressure 12.1%, diabetes 15.2%, pacemaker (ICD) 1%, Catheter ablation 1.2%, DC cardioversion, Arterial fibrillation (AF) 3.1%, Ventricle tachycardia 5.4%, Arterial tachycardia 4.1%, Arterial bradycardia 2%, Ventricle Fibrillation 0.6%, Extrasystoles 6.2%, prolong Q-T 0.8% Heart Block 2.1% heart block 2.1%, L.V desfacation 9.2%, tachycardia 6.2%, bradycardia 0.6%, wolf Parkinson syndrome 0.001%, Arial flutter 2.6%, STEMI 4.2%, NSTEMI 6.1%, Cardiac catheterization PCI: 3%, catheter ablation 2.1%,

Myocarditis 0.01%, Cardiomyopathy 1.3%, Diseases of the heart valves 3.2%, rheumatic heart disease 1.2%, pericarditis 0.2%, Congenital heart disease 0.3%, heart failure 7.1%, pulmonary embolism 0.0.1%, Hypertension 12.2%, Therefore, the work was as a key and an indicator of the dimensions of the risk factors and the real cause of the Arrhythmia, the calculation of the recombinant rates and the programs ..(ICP) Intensive Care Program with the initial stability, And the early treatment plan for heart disease and the accompanying chronic diseases .. As for patients who complain of heart valve diseases(transplantation), open-heart operations, congenital anomalies that need surgery, they are referred to heart surgery to stabilize their health condition .

**Table (3): Results of the most prominent disease cases arrhythmia (cardiac disorders) according to data and practical extrapolation (ECG)**

No.	Arrhythmia	Youth - % (20-50) year	Women after 50 years-%	Men after 50 years- %
1.	Sinus Arrhythmia	3%	4%	6.2%
2.	Sinus Bradycardia	2.1%	2.5%	1.7%
3.	Sinus Tachycardia	5 %	3%	6.2%
4.	Atrial tachyarrhythmia's	2.3%	4.3%	4.1%
5.	Atrial bradycardia	2.1%	2.1%	2%
6.	Atrial flutter	0.01%	1.7%	2.6%
7.	Atrial fibrillation	0.7%	4.7%	3.1%
8.	Ventricle fibrillation	0.001%	0.03%	0.6%
9.	Ventricle tachycardia	4.1%	5.3%	5.4%
10.	Excresystol (ectopic)	3.4%	9.4%	6.2%
11.	Long Q -T Syndrome	0.6%	1.2%	0.8%
12.	Heart block	2.3%	3.3%	2.1%
13.	Wolff-Parkinson-White Syndrome	0.01%	0.01%	0.001%
14.	STEMI	0.001%	3.1%	4.2%
15.	NSTEMI	0.003%	4%	6.1%

**Table (4): Summary of treatment Anti-arrhythmic drug According to classification (Sigh Vaughan William) (Oxford university)**

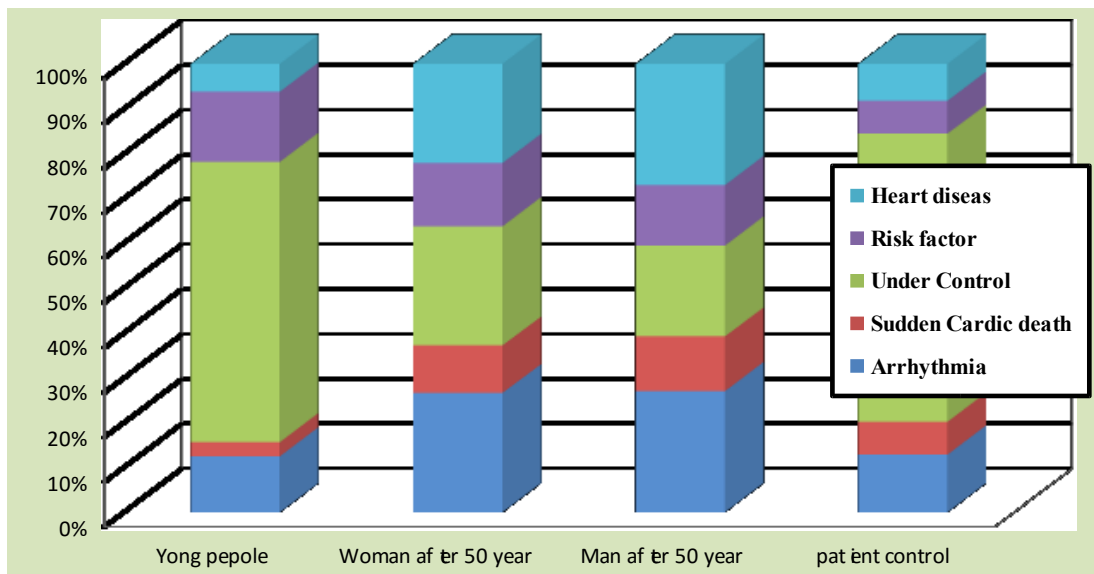
Class/Ion Affected	Agents	Physiologic Effect	Result on Electrophysiologic Parameters	Clinical Utility
<b>Class I (Na<sup>+</sup> channel blockers)</b>				
IA (intermediate)	Disopyramide Quinidine Procainamide	↓ Conduction velocity ↑ Refractory period	↑ QRS complex and ↑ QT interval	Atrial and ventricular arrhythmias
IB (fast)	Lidocaine Mexiletine	↓ Conduction velocity ↓ Refractory period	↓ QT interval	Ventricular arrhythmias
IC (slow)	⊗ Flecainide Propafenone	↓↓↓ Conduction velocity ∅ Refractory period	↑ QRS complex	Supraventricular arrhythmias and ventricular arrhythmias
<b>Class II (β-Blockers)</b>	Metoprolol Esmolol Atenolol	↓ Conduction velocity ↑ Refractory period	↓ HR and ↑ PR interval	Atrial and ventricular arrhythmias
<b>Class III (K<sup>+</sup> channel blockers)</b>	Amiodarone Dronedarone Sotalol Dofetilide Ibutilide	∅ Conduction velocity ↑↑↑ Refractory period	↑ QT interval	Atrial and ventricular arrhythmias
<b>Class IV (Ca<sup>2+</sup> channel blockers)</b>	Diltiazem verapamil	↓ Conduction velocity ↑ Refractory period	↓ HR and ↑ PR interval	Atrial and ventricular arrhythmias

**Conclusion**

The new scientific effort contributes to the development of work by treating patients safely, especially due to what our countries suffer according to

the available capabilities to reduce heart disease and the essence of Arrhythmia Which was our main topic, which causes angina pectoris and when it leaves side effects on human health, work is limited to patients, causes outside and inside the heart.

**((Statistical graph of patients))**



**Ethical Clearance:** The Research Ethical Committee at scientific research by ethical approval of both environmental and health and higher education and scientific research ministries in Iraq

**Conflict of Interest:** The authors declare that they have no conflict of interest.

**Funding:** Self-funding

## References

1. Harvey RA, Clark M, Finkel R, Rey J, Whalen K. Lippincott's illustrated reviews: Pharmacology. Philadelphia; 2012.
2. Lilly LS, Braunwald E. Braunwald's heart disease: a textbook of cardiovascular medicine. Elsevier Health Sciences; 2012.
3. Calkins H, Kuck KH, Cappato R, Brugada J, Camm AJ, Chen SA, Crijns HJ, Damiano Jr RJ, Davies DW, DiMarco J, Edgerton J. 2012 HRS/EHRA/ECAS expert consensus statement on catheter and surgical ablation of atrial fibrillation: recommendations for patient selection, procedural techniques, patient management and follow-up, definitions, endpoints, and research trial design: a report of the Heart Rhythm Society (HRS) Task Force on Catheter and Surgical Ablation of Atrial Fibrillation. Developed in partnership with the European Heart Rhythm Association (EHRA), a registered branch of the European Society of Cardiology (ESC) and .... *Europace*. 2012 Apr 1;14(4):528-606.
4. Loscalzo J. Harrison's Cardiovascular Medicine 2/E. McGraw-Hill Education; 2013.
5. Katzung BG. Basic and clinical pharmacology. Mc Graw Hill; 2012.
6. Walker BR, Colledge NR. Davidson's principles and practice of medicine e-book. Elsevier Health Sciences; 2013 Dec 6.
7. Lip GY. Cardiac arrhythmias: a clinical approach. Mosby Incorporated; 2003.
8. Ritter JM, Lewis LD, Mant TG. A Textbook of Clinical Pharmacology: Edited by James M. Ritter, Lionel D. Lewis, Timothy GK Mant. Arnold; 1999.
9. Solomon SD, Wu J, Gillam LD. Essential Echocardiography: A Companion to Braunwald's Heart Disease E-Book. Elsevier Health Sciences; 2017 Nov 4.
10. Olgin JE. Specific arrhythmias: diagnosis and treatment. *Heart disease. A textbook of cardiovascular medicine*. 2001:815-89.
11. Field JM, Kudenchuk PJ, O'Connor R, VandenHoek T. The textbook of emergency cardiovascular care and CPR. Lippincott Williams & Wilkins; 2012 Nov 7.
12. Page RL, Joglar JA, Caldwell MA, Calkins H, Conti JB, Deal BJ, Estes NM, Field ME, Goldberger ZD, Hammill SC, Indik JH. 2015 ACC/AHA/HRS guideline for the management of adult patients with supraventricular tachycardia: a report of the American College of Cardiology/American Heart Association Task Force on Clinical Practice Guidelines and the Heart Rhythm Society. *Journal of the American College of Cardiology*. 2016 Apr 5;67(13):e27-115.
13. Members WC, Kusumoto FM, Schoenfeld MH, Barrett C, Edgerton JR, Ellenbogen KA, Gold MR, Goldschlager NF, Hamilton RM, Joglar JA, Kim RJ. 2018 ACC/AHA/HRS guideline on the evaluation and management of patients with bradycardia and cardiac conduction delay: a report of the American College of Cardiology/American Heart Association Task Force on Clinical Practice Guidelines and the Heart Rhythm Society. *Heart rhythm*. 2019 Sep;16(9):e128-226.
14. Muntner P, Carey RM, Gidding S, Jones DW, Taler SJ, Wright JT, Whelton PK. Potential US population impact of the 2017 ACC/AHA high blood pressure guideline. *Journal of the American College of Cardiology*. 2018 Jan 8;71(2):109-18.
15. Hawley CE, Roefaro J, Forman DE, Orkaby AR. Statins for primary prevention in those aged 70 years and older: a critical review of recent cholesterol guidelines. *Drugs & aging*. 2019 Aug 1:1-3.
16. Somers VK, White DP, Amin R, Abraham WT, Costa F, Culebras A, Daniels S, Floras JS, Hunt CE, Olson LJ, Pickering TG. Sleep apnea and cardiovascular disease: An American heart association/American college of cardiology foundation scientific statement from the American heart association council for high blood pressure research professional education committee, council on clinical cardiology, stroke council, and council on cardiovascular nursing in collaboration with the national heart, lung, and blood institute national center on sleep disorders research (national institutes

- of health). *Circulation*. 2008 Sep 2;118(10):1080-111.
17. Maron DJ, Hochman JS, Reynolds HR, Bangalore S, O'Brien SM, Boden WE, Chaitman BR, Senior R, López-Sendón J, Alexander KP, Lopes RD. Initial invasive or conservative strategy for stable coronary disease. *New England Journal of Medicine*. 2020 Apr 9;382(15):1395-407.
  18. Capodanno D, Huber K, Mehran R, Lip GY, Faxon DP, Granger CB, Vranckx P, Lopes RD, Montalescot G, Cannon CP, Ten Berg J. Management of antithrombotic therapy in atrial fibrillation patients undergoing PCI: JACC state-of-the-art review. *Journal of the American College of Cardiology*. 2019 Jul 9;74(1):83-99.
  19. Hancock EW, Deal BJ, Mirvis DM, Okin P, Kligfield P, Gettes LS. AHA/ACCF/HRS Recommendations for the Standardization and Interpretation of the Electrocardiogram: Part V: electrocardiogram changes associated with cardiac chamber hypertrophy a scientific statement from the American Heart Association Electrocardiography and Arrhythmias Committee, Council on Clinical Cardiology; the American College of Cardiology Foundation; and the Heart Rhythm Society Endorsed by the International Society for Computerized Electrocardiology. *Journal of the American College of Cardiology*. 2009 Mar 17;53(11):992-1002.
  20. Kligfield P, Gettes LS, Bailey JJ, Childers R, Deal BJ, Hancock EW, Van Herpen G, Kors JA, Macfarlane P, Mirvis DM, Pahlm O. Recommendations for the standardization and interpretation of the electrocardiogram: part I: the electrocardiogram and its technology a scientific statement from the American Heart Association Electrocardiography and Arrhythmias Committee, Council on Clinical Cardiology; the American College of Cardiology Foundation; and the Heart Rhythm Society endorsed by the International Society for Computerized Electrocardiology. *Journal of the American College of Cardiology*. 2007 Mar 13;49(10):1109-27.
  21. Driscoll A, Smith K. Cardiovascular alterations and management. *Critical Care Nursing*. 2019 Jun 21:276.
  22. Frenkel O, Riguzzi C, Nagdev A. Identification of high-risk patients with acute coronary syndrome using point-of-care echocardiography in the ED. *The American journal of emergency medicine*. 2014 Jun 1;32(6):670-2.

# Effectiveness of an Educational Program on Nurses' Knowledge about Communicable Diseases Control in Al-Nassiriyah City Hospitals

Talal Mohammed Yousef<sup>1</sup>, Wissam Jabbar Qassim<sup>2</sup>, Zahid Jassim Mohammed<sup>3</sup>

<sup>1</sup>M.Sc. Student, University of Baghdad, College of Nursing, Community Health Nursing Department, Iraq, <sup>2</sup>Assist. Professor PhD, University of Baghdad, College of Nursing, Community Health Nursing Department, Iraq, <sup>3</sup>Assist. Professor Basic science Department, College of Nursing, University of Baghdad, Baghdad City, Iraq

## Abstract

Communicable diseases are an illness that is transmitted from a person, animal, or inanimate source to another person either directly, with the assistance of a vector or by other means. Communicable diseases are a major cause of mortality and morbidity in emergencies, and particularly in complex emergencies, where collapsing health services and disease control programs. They are the basic level of infectious pathogens control precautions which are to be used, as a minimum, in the care of all patients. A quasi-experimental design (descriptive study) used to guide this study; it was applied by use of pretest-posttest approach for two groups of samples (study and control) Non- probability (purposive) sample of (80) nurses who are working in Al-Nasiriyah city hospitals.

The findings of the current study revealed that there are highly statistically significant differences in posttest. The study concludes that there is poor and low level of knowledge assessment among the participants toward communicable diseases control at the pre-test in the both group. The results show after the implementation of educational program high level of nurses' knowledge for (post-test I and post-test II) for the study group regarding communicable diseases control. The study concludes there were no significant association between nurses' knowledge and their socio demographic characteristics includes: age; gender; level of education and years of experience. The study recommends of the providing an educational and training program periodically for nurses in order to enhancement the level of their knowledge regarding communicable diseases control.

**Keywords:** *Effectiveness of an educational program, nurses' knowledge, communicable diseases control.*

## Introduction

Communicable diseases are an illness that is transmitted from a person; animal or inanimate source to another person either directly, with the assistance of a vector or by other means. Communicable diseases cover a wider range than the person to person transmission of communicable diseases<sup>[1]</sup>.

In the fall of 2002, the WHO program on communicable diseases in complex emergencies coordinated the compilation of the communicable disease profile for Iraq. This profile highlighted the most prevalent risks for public health and included a communicable disease toolkit, including rapid health assessment forms, morbidity and mortality surveillance

forms, case definition for priority diseases, and guidelines for case-management and outbreak control <sup>[2]</sup>.

Communicable diseases are a major cause of mortality and morbidity in emergencies, and particularly in complex emergencies, where collapsing health services and disease control programs, poor access to health care, malnutrition, interrupted supplies and logistics, and poor coordination among the various agencies providing health care often coexist. The main causes of morbidity and mortality in emergencies conditions are diarrheal diseases, acute respiratory infections, and measles in areas where it is endemic, malaria. Other communicable diseases, such as epidemic meningococcal disease, Tuberculosis, relapsing fever, and Typhus, have also



caused large epidemics among emergency-affected populations<sup>[3]</sup>.

World Health Organization (2012), an annual report which stated that the importance of communicable diseases control has increased in recent years due to increased travel, trade, migration and emergence of new infections. In addition to the chronic challenges of weak health systems, inadequate commitment and financing for communicable diseases control have resulted in delay to achievement of regional targets. Several countries are facing political instability, social unrest, ongoing conflict and insecurity, all of which have an impact on control of communicable diseases. In this section, we address four thematic areas: poliomyelitis eradication; HIV, TB, hepatitis B,C, malaria and tropical diseases; immunization and vaccines <sup>[4]</sup>.

Hospital acquired infection (HAIs) can be defined as an infection acquired in hospital by a patient who was admitted for a reason other than that infection. An infection are occurring in a patient, in a hospital or other health care facility in whom the infection was not present or incubating at the time of admission. This includes infections acquired in the hospital but appearing after discharge, and also occupational infections among staff of the facility <sup>[5]</sup>.

Nurses are health care professionals whose duty it is to protect patients from acquiring infections while hospitalised or while in a health care set up. By maintaining an infection free environment, the patient's recovery will be promoted and high-quality nursing care will be delivered. Nurses spend most of their time with patients. Therefore, they should have a good level of understanding of the knowledge on prevention and control measures about communicable diseases in health care setups <sup>[6]</sup>.

For example the tuberculosis (TB) is a public health priority in Iraq. The country is among the seven of the countries of the region with a high burden of TB, and accounts for 3% of the total number of cases. There are an estimated 20 000 TB patients in Iraq. Estimated deaths due to TB are more than 4000 annually. Iraq reported that there are about 8,664 new cases of tuberculosis in 2012 and a prevalence of 73 cases per 100,000 populations. Within Iraq, 180 new cases of multidrug-resistant tuberculosis were confirmed <sup>[7]</sup>.

## Method of the Study

A quasi-experimental design (descriptive study) used to guide this study. It was applied by use of pre-posttest approach for two groups of samples (case and control) to determine the effectiveness of an educational program on nurses' knowledge about communicable diseases control during period from 15<sup>th</sup> October 2019 to 20<sup>th</sup> August 2020.

Non- probability (purposive) sample of (80) nurses who are work -ing in isolation department of Al-Nasiriyah city hospitals (Al-Hussein Teaching Hospital, Bent Al-Huda Teaching Hospital and Al-Habbobi Teaching Hospital). The sample consists (80) nurses divided into two groups: (40) nurses as study group, which exposed to the health educational program and (40) nurses as control group who not exposed to the health educational program.

**Study Instrument:** The tool for the study, including four parts, first concerned with the nurse's demographic characteristics like nurses' age, gender, level of education, and marital status. The second part includes a series of MCQ questions covering nurses' knowledge about communicable diseases. The test consists of a list of (20) questions and consists of choices. Third is concerned with data related to the nurses' knowledge toward method of communicable diseases control, which are consist of (15) questions. The fourth part is concerned with data related to the nurses' knowledge toward standard precautions which are consist of (20) questions.

The content validity of the program and the study instruments are determined by the panel of (13) experts, which have more than (7) years' experience in their field to investigate the content of the educational program and the questionnaire about communicable disease control.

**Rating and Scoring:** The level of knowledge was scored by rating (2) for the correct answer and (1) for the incorrect one, therefore, knowledge rating explained by the following intervals L=Low level (1-1.33), M=Moderate level (1.34-1.67), H=High level (1.68-2). Data of the study were ordered according to three levels of scale (High, Moderate, and Low) early stated which were scored as (2 and 1) for each level respectively. It is classified as scores of response according to the following:

L=Low level (1-1.33)

M=Moderate level (1.34-1.67)

H=High level (1.68-2)

**The Statistical Data Analysis:** Data are analyzed through using the program of Statistical Package of Social Sciences (SPSS, Version 21). The following statistical data analysis approaches are used in order to analyze and assess the results of the study.

## Results and Discussion

**Socio-demographic characteristics of the present study:** The table (1) represents the socio-demographic characteristics of the present study (study and control group). It shows the majority of the study and control sample at the middle age ranged (25 - 29) years. For study group are accounted for (24) nurses with represented of percentage (45%), while for control group represent of percentage (60%).

The study findings agree with study in Nigeria that indicated about knowledge and application of infectious diseases control measures among primary care workers in Nigeria. It revealed that most participants (34.2%) of health care workers were age group (25-34)<sup>[8]</sup>.

This is due to the large number of recent employees in the field of health, as the Ministry of Health is working to employ thousands of nurses' graduates annually from specialized institutes and colleges in the health field, so most ages are from this age group.

In regarding for gender, the table shows that the majority of participants were female for both groups (control and study). Which were represented of percentage (57.5%) of all.

The study findings agree with study done in in Nigeria indicated that about knowledge and application of infectious diseases control measures. It revealed that most study sample were female which represented (76.2%).<sup>[9]</sup>.

Concerning the level of education, the present study shows that (19) of participants, nurses in study group were graduated from nursing institute and represented (47%). While for control group, also the most were graduated from nursing institute about (24) nurses with percentage (60%).

The findings supported study in South Africa of for Nurses' knowledge of tuberculosis, HIV, and integrated HIV/TB, which revealed that (54%) of participants nurses had diploma qualification<sup>[10]</sup>.

Regarding to the marital status, results of study show that the majority of control and study sample (75%) were married. This results agree with study by

The study findings are similar with study of Yousef in 2019 to implementing the educational program regarding nurses' knowledge about infection control measures and results revealed that majority (68.75%) were married<sup>[11]</sup>.

Related to the training session, the study findings show that the majority of nurses in study group were (85%), while for control were (77.5) have not participated in a formal educational program about communicable diseases control. Lack of access and interest in the training courses leads to poor skills development of nursing staff regarding the communicable diseases control.

The study findings agree with study of Al-Ghamdi in (2011) that show (57.8%) of health care workers did not participated in training course about communicable diseases control. These findings reported that the poor nurses' knowledge related to lack of interest and motivation in participating in training course about communicable diseases control<sup>[12]</sup>.

Concerning the years of experience, the study findings reveals that majority of participants for both group (control and study) have (6-10) years in their experience with percentage (45%) for control group and (37.5%) for study group.

The present results agree with study of Hamid in (2010) who conduct a study to assess Knowledge of infectious diseases and the practice of universal precautions amongst health-care workers in a tertiary hospital in Malaysia. They found the (79%) of participants have experience in range of (5-9) years<sup>[13]</sup>.

Table(2) shows that distribution of knowledge scores general information on (communicable diseases, method of control, and standard precautions) and indicated was that high level of knowledge related to study group.

Table (3) shows all three posttest nurses' knowledge scores general information on (communicable diseases,

method of control, and standard precautions) to be significantly higher between the study group and control group.

The study findings supported by study done in Egypt were noted that the effect of educational program for knowledge of nurses for study group at a posttest [14].

Another study support the present study results, which reported the effect of educational program on nurses' compliance with Universal precautions of infection control and noted high significant differences between study and control group [15].

Before the implementation of the educational program, a pre-test was carried out on study group and results show the level of nurses' knowledge regarding three domains of communicable diseases control was poor.

These results agree with study done in Saudi Arabia. Saudi was reported that nurses had poor knowledge about communicable diseases control [11].

Also, the result is consistent with that findings obtained by Phetlhu in (2018) which revealed that the most nurses have poor knowledge concerning communicable diseases [9].

**Association between socio-demographic characteristics and nurses' knowledge:** Results of tables (4) showed that there is no statistical significant association between nurses' knowledge and their gender at (pre-test, post-test I and posttest II tests) of educational program follow up ( $p > 0.05$ ), and also there are no differences between mean of knowledge.

The study findings agree with study soudiarab was stated that no significant association between genders of nurses concerning communicable diseases contro [11]

Table (4) shows that there is no statistical significant association between nurses' age and their knowledge regarding communicable diseases control.

The findings supported by study of Phetlhu in (2018) who state that there is no is no statistical significant association between nurses' age and their knowledge at ( $p \leq 0.05$  value) [9].

Additionally, to another study conducted in egypt which noted that there is no significant relationship between nurses' age and their knowledge toward standard precautions and infection control [15].

Table (4) regarding the level of education, it shows there is no signification association between the educational level and nurses' knowledge concerning communicable diseases control.

Results agree with Batranin(2018) conduct a study on nurses' knowledge about standard precautions and reveals that there is no singnificat association between educational level and knowledge [16]

Table (4) according to results of this table, there is no significant between experience for nurses' work and their knowledge concerning communicable diseases control ( $p > 0.05$ ).

Results agree with study by Hamid in (2010) about Knowledge of infectious diseases and the practice of universal precautions amongst health-care workers. It noted that no relation between years of experience of health-care workers and their knowledge [12].

Additionally, study in Ninavah Governorate was showed that there ere no significant statistical differences in post – test scores between nurses' knowledge with regard to their years of employment [17].

**Table (1): Distribution of The Study Sample by Socio- Demographic for Study and Control Group**

Var.	Groups	Control		Study	
		Freq.	%	Freq.	%
Age Groups	20-24	1	2.5	2	5.0
	25-29	24	60.0	18	45
	30-34	15	37.5	18	45
	35-39	0	0	2	5
Gender	Male	17	42.5	17	42.5
	Female	23	57.5	23	57.5

Marital status	Married	30	75	30	75
	Single	10	25	10	25
Educational level	Nursing secondary school	11	27.5	13	32.5
	Nursing institute	24	60	19	47.5
	Nursing college	5	12.5	8	20
Participating in Training	Yes	9	22.5	6	15
	No	31	77.5	43	85
Years of experience	5 and less	15	37.5	13	32.5
	6-10	18	45	15	37.5
	11-16	7	17.5	12	30
Total		40	100	40	100

Freq = frequency, % = percentages

**Table (2) distribution of knowledge levels between the pre and post-test related to study group. (N= 40)**

Domains	Periods	Total Mean	SD	Levels
Nurses' knowledge about communicable diseases	Pre	1.1388	0.0964	Moderate
	Post I	1.9763	0.0357	High
	Post II	2.00	0.000	High
Nurses' knowledge about ways to communicable diseases control	Pre	1.1133	0.0882	Low
	Post I	1.9900	0.0241	High
	Post II	2.00	0.000	High
Nurses' Knowledge about Standard Precautions	Pre	1.1150	0.0622	Low
	Post I	1.9888	0.0211	High
	Post II	1.9962	0.0133	High
OVER ALL	Pre	1.1231	0.0616	Low
	Post I	1.9686	0.0174	High
	Post II	1.9978	0.0036	High

SD= standard deviation, L=low level (1-1.33), M=moderate level (1.34-1.67), H=high level (1.68-2).

**Table (3) Comparison of Knowledge Scores between the Study and Control Groups at Posttest. (N= 40)**

Domains	Group	Total Mean	SD	t	P	d.f.
Nurses' knowledge about communicable diseases	Post control	1.158	0.078	57.37	0.00	78
	Post study	1.976	0.036			
Nurses' knowledge about ways to communicable diseases control	Post control	1.157	0.112	46.32	0.00	78
	Post study	1.990	0.024			
Nurses' Knowledge about Standard Precautions	Post control	1.139	0.102	51.81	0.00	78
	Post study	0.989	0.021			
Over all	Post control	1.152	0.058	86.14	0.00	78
	Post study	1.969	0.017			

**Table (4): Association between socio-demographic characteristics group and Knowledge fort the study group at Post -Test**

Variable	Groups	Freq.	%	F value	P value	Sig.
Gender	Male	17	42.5	-0.087	0.931	N.S
	Female	23	57.5			
Age Groups	20-24	2	5.0%	0.271	0.846	N.S
	25-29	18	45.0%			
	30-34	18	45			
	35-39	2	5			
Educational level	Total	40	100	1.179	0.319	N.S
	Nursing secondary school	13	32.5			
	Nursing institute	19	47.5			
	Nursing college	8	20			
Years of experience	5 and less	13	32.5	0.025	0.975	N.S
	6-10	15	37.5			
	11-16	12	30			
<b>Total</b>		<b>40</b>	<b>100</b>			

Frequency, F = Fisher test, %= Percentage, P .value, NS: Non Significant at P > 0.05

**Ethical Clearance:** The Research Ethical Committee at scientific research by ethical approval of both environmental and health and higher education and scientific research ministries in Iraq

**Conflict of Interest:** The authors declare that they have no conflict of interest.

**Funding:** Self-funding

### Reference

1. Webber R, editor. Communicable disease epidemiology and control: a global perspective. Cabi; 2009.
2. Wilson K, Fidler DP, McDougall CW, Lazar H. Establishing public health security in a postwar Iraq: constitutional obstacles and lessons for other federalizing states. *Journal of Health Politics, Policy and Law*. 2009 Jun 1;34(3):381-99.
3. Jafari N, Shahsanai A, Memarzadeh M, Loghmani A. Prevention of communicable diseases after disaster: A review. *Journal of research in medical sciences: the official journal of Isfahan University of Medical Sciences*. 2011 Jul;16(7):956.
4. World Health Organization. Communicable diseases. Annual report by World Health Organization. 2012.
5. Monegro AF, Muppidi V, Regunath H. Hospital acquired infections. *Stat Pearls [Internet]*. 2020 Aug 11.
6. Chitimwango PC. Knowledge, attitudes and practices of nurses in infection prevention and control within a tertiary hospital in Zambia (Doctoral dissertation, Stellenbosch: Stellenbosch University).
7. World Health Organization. Global tuberculosis report 2013. World Health Organization; 2013.
8. Aigbiremolen AO, Duru CB, Awunor NS, Abejegah C, Abah SO, Asogun AD, Eguavoen OL. Knowledge and application of infectious diseases control measures among Primary Care workers in Nigeria: the Lassa fever example. *International Journal of Basic, Applied and Innovative Research*. 2012;1(4):122-9.
9. Phetlhu DR, Bimerew M, Marie-Modeste RR, Naidoo M, Igumbor J. Nurses' knowledge of tuberculosis, HIV, and integrated HIV/TB care policies in rural Western Cape, South Africa. *Journal of the Association of Nurses in AIDS Care*. 2018 Nov 1;29(6):876-86.
10. Yousef YE, Elashir UM, Mahmoud SR, Maghraby

- N. The effect of nursing educational program on knowledge and practice of nurses regarding infection control measures for children under hemodialysis. *Egyptian Nursing Journal*. 2019 Jan 1;16(1):1.
11. Al-Ghamdi AS, Kabbash IA. Awareness of healthcare workers regarding preventive measures of communicable diseases among Hajj pilgrims at the entry point in Western Saudi Arabia. *Saudi Med J*. 2011 Nov 1;32(11):1161-7.
12. Hamid MZ, Aziz NA, Anita AR, Norlijah O. Knowledge of blood-borne infectious diseases and the practice of universal precautions amongst health-care workers in a tertiary hospital in Malaysia. *Southeast Asian journal of tropical medicine and public health*. 2010 Sep 1;41(5):1192.
13. Galal YS, Labib JR, Abouelhamd WA. Impact of an infection-control program on nurses' knowledge and attitude in pediatric intensive care units at Cairo University hospitals. *The Journal Of The Egyptian Public Health Association*. 2014 Apr 1;89(1):22-8.
14. Fayed NM, Hanan T, Elbahnasawy TH, Omar KT. Effect of Instructional program on nurses compliance with Universal precautions of infection control. *International Journal of Novel Research in Healthcare and Nursing*. 2016;3(1):81-92.
15. Gawad A. Assessment of knowledge about standard precautions and nosocomial infection among nurses working in hospitals of Sana'a city, Yemen. *International Journal of Caring Sciences*. 2017 Jan 1;10(1).
16. Batran A, Ayed A, Salameh B, Ayoub M, Fafous A. Are standard precautions for hospital-acquired infection among nurses in public sector satisfactory?. *Archives of Medicine and Health Sciences*. 2018 Jul 1;6(2):223.
17. Wahab MM, Taha TH. The Effect of an Educational Program on Nurses' Knowledge about Hepatitis B Virus (HBV) in Ninawah Governorate Hospitals. *Mosul Journal of Nursing*. 2016;4(2):81-7.

# Evaluation Follicular Fluid Cytokines in Patients with Risk Factor for Development of Ovarian Hyper Stimulation Syndrome

Alaa K. Hameed<sup>1</sup>, Alaa S. AL-Atabbi<sup>2</sup>, Muna K. Mahmood<sup>3</sup>

<sup>1</sup>Masters Degree Student, College of Medicine, University of Kerbala, Kerbala, Iraq, <sup>2</sup>Ass. Prof. College of Medicine, University of Kerbala, Kerbala, Iraq, <sup>3</sup>Ass. Prof. College of Medicine, University of Kerbala, Kerbala, Iraq

## Abstract

**Aim of Study:** Study the level of IL17 and IL23 in the follicular fluid and their relation with hyper stimulation syndrome.

**Materials/Method:** Eighty five who include (85 subject divided into 2 groups, control group whom included infertile female with male factor infertility (55) and case group whom infertility due to poly cystic ovarian syndrome (30) attended IVF centre.

Samples collected were follicular fluid, the follicular fluid has been collected in Eppendorf tube then stored at -20c to be used for ELISA test to determine concentration of IL 23 and IL 17 in follicular fluid. The results were analyzed using the IBM SPSS analytic software.

**Results:** the mean of interleukin (IL17) 96.11, Standard deviation 78.46 in the patients group. While the mean of interleukin (IL 17) for control 6.15, Standard deviation 14.33. There was a significant difference between polycystic and male factor infertility. P value < 0.005 both of them groups Poly cystic and male factor.

**Conclusions:** High concentration of follicular fluid IL -17 is positively associated with e disease of poly cystic ovary (POCS).

**Keywords:** PCOS, IL17, IL23, fertility.

## Introduction

IVF stands for in vitro fertilization. It's one of the more widely known types of assisted reproductive technology (ART). IVF works by using a combination of medicines and surgical procedures to help sperm fertilize an egg. Where fertilization takes place outside the body. It's suitable for people with a wide range of fertility issues and is one of the most commonly used

and successful treatments available for many people<sup>(1)</sup>. There are many types of fertility treatments available, ranging from simple interventions such as medication to help a woman ovulate through to more complicated procedures like IVF<sup>(2)</sup>.

Ovarian hyperstimulation syndrome (OHSS) is considered the most serious complication of ovulation induction. It can vary from being a mild illness to a severe, life-threatening disease requiring hospitalization. OHSS can occur as soon as a few days after receiving HCG ('early OHSS') or later ('late OHSS'). Multiple pregnancy has been shown to be associated with a higher risk of late OHSS<sup>(3)</sup>.

The incidence of severe OHSS has been reported to vary from 0.7 to 1.7% per initiated cycle<sup>(4-7)</sup>. Some

---

### Corresponding Author:

Alaa S. AL-Atabbi

Ass. Prof. College of Medicine, University of Kerbala, Kerbala, Iraq

e-mail: alatabbi486@gmail.com

case reports<sup>(8, 9)</sup>, studies<sup>(5, 10)</sup>, and reviews<sup>(11)</sup> describe some serious aspects of OHSS, such as thromboembolic events, pulmonary manifestations, and death, but the magnitude of the risk is unclear.

While there is robust evidence supporting the efficacy and safety of ART, it is important to be aware of the risks, the most serious of which is ovarian hyperstimulation syndrome (OHSS). OHSS is a rare, iatrogenic complication of controlled ovarian stimulation (COS). Severe OHSS occurs in approximately 1.4% of all cycles<sup>(12)</sup>.

There are a number of well-established primary risk factors for the development of OHSS, including young age, polycystic ovary syndrome (PCOS) – characterized by ultrasound and the ratio of luteinizing hormone (LH) to follicle stimulating hormone (FSH) – and a history of an elevated response to gonadotropins, i.e. prior hyper-response/OHSS<sup>(13, 14)</sup>.

The polycystic ovary syndrome (PCOS) is the most common endocrine disorder of women in reproductive age which influences outcome and potential risks involved with controlled ovarian stimulation for artificial reproductive techniques (ART)<sup>(15)</sup>. It causes chronic oligo- or anovulation and often leads to infertility.

PCOS is mentioned as a common endocrinopathy in women who are at reproductive age and it is associated with metabolic disorder and reproductive dysfunction<sup>(16,17)</sup>.

Ovarian dysfunction continues to be the main feature which makes this syndrome the major cause of an ovulatory associated with infertility<sup>(18)</sup>. Most say 5%-10% of reproductive-age women are affected<sup>(19, 20)</sup> but some say 6.6%-8%<sup>(21)</sup> and some others say PCOS is a disorder affecting up to 6%-10% of women in reproductive age<sup>(22)</sup>.

This syndrome can be defined by specific clinical and bio-chemical criteria, and also using ultrasonography<sup>(23)</sup>.

Environmental status and factors, such as obesity, appear to exacerbate the underlying genetic predisposition. PCOS is characterized by increased levels of circulating androgen, polycystic ovarian morphology (PCOM), arrested follicle development, and an ovulatory infertility<sup>(24)</sup>.

Controlled ovarian hyperstimulation (COS) with gonadotropins for artificial reproductive techniques

(ART) leads to a higher risk of ovarian hyperstimulation syndrome (OHSS) for patients affected by PCOS, because of a higher sensibility and exaggerated response to gonadotropins<sup>(26)</sup>.

The Th17/IL-23 immune axis plays an important role in immuno-pathogenesis of some reproductive abnormalities such as polycystic ovary syndrome (PCOS) and endometriosis<sup>(27)</sup>. IL-23, a member of the IL-12 cytokine family, is a heterodimeric cytokine which is composed of the IL-12 p40 subunit and a novel p19 subunit. IL-23 is mainly secreted by activated macrophages and dendritic cells<sup>(28)</sup>.

The significant higher levels of IL-6 and IL-10 and lower concentrations of IL-23 in FF from patients with PCOS indicated an important immunological microenvironment defect in the ovarian follicles<sup>(29)</sup>. The high level of IL-23 in the FF of women with endometriosis illustrated inappropriate oocyte quality in these subjects<sup>(30)</sup>.

IL-23 amplifies and stabilizes the proliferation of IL-17 secreting CD4<sup>+</sup> memory T cells which produce IL-17, a pro-inflammatory cytokine that stimulates the production of other pro-inflammatory cytokines and chemokines such as IL-1, IL-6, tumour necrosis factor- $\alpha$  and nitric oxide responsible for inflammation<sup>(31)</sup>.

Also, the significantly higher IL-17 in the FF of women with endometriosis and PCOS is associated with immunological changes which may finally lead to infertility<sup>(32)</sup>.

Some past examination exhibited that IL-10 was raised yet IL-23 was evoked in PCOS ladies which reflex sustain the neighbourhood enactment of Th17/Th1 cells by discharging a lot of IL-22, and IFN- $\gamma$ -driven inflammation<sup>(33)</sup>.

This study was aimed to investigate the concentration of level interleukin 17 and interleukin 23 and development of PCOS.

## Materials and Method

A case control study was conducted in AL – Sader teaching medical city in Najef, AL Kadhimiya Teaching hospital, Umm AL Banin fertility centre and Nahrain University Higher institute in Baghdad to diagnose infertility and assist in childbearing randomly selected included a 85 patients, Who attended to consultant clinic for in Vitro Fertilization intracytoplasmic sperm



injection in the period between November 2019 to March 2020 under the supervision of fertility and in vitro fertilization specialists were included in this study.

Eighty five who include (85 subject divided into 2 groups, control group whom included infertile female with male factor infertility (55) and case group whom infertility due to poly cystic ovarian syndrome (30) attended IVF centre.

Samples collected were follicular fluid, Oocyte Pick up was done by a gynaecologist. Follicular fluid sample were collected by Needle size 16 Gauge from ovary from 90 patients and their healthy controls and put in tube then, allowed to separate by centrifugation 3000 rpm for 5 minute. The follicular fluid has been collected in Eppendorf tube then stored at -20c to be used for ELISA test to determine concentration of IL 23 and IL 17 in follicular fluid.

**Results**

Table (1) shows that total of 85 groups: 30 patients groups which compared with control groups male factor (N=55). For both studied groups, age ranging from (25-

45) polycystic and from male factor (32-42). The mean ages (mean+SD) were 28.97±4.88 for poly cystic, 29.41±5.59 for male factor.

Body mass index in poly cystic ovary group (mean ±SD) were 26.58±2.52, minimum 22.66, maximum 34.05. While control groups male factor (mean± SD) were 26.32±3.46, minimum 10.82 maximum 32.83

Infertility duration for polycystic ovary groups (mean± SD) were 8.20±2.28, minimum 6, maximum 11. While for control male factor groups (mean± SD) were 7.79±2.99, minimum 3, and maximum 13.

Right ovary follicle for poly cystic ovary groups (mean± SD) were 6.6±3.7, minimum 1, maximum 15. While for control male factor groups (mean± SD) were 6.1±3.6, minimum 1, maximum 17.

Left ovary follicle for polycystic ovary groups (mean± SD) were 6.10±3.39, minimum 1, and maximum 13. While for control male factor groups (mean± SD) were 5.47± 2.97, minimum 0.00, and maximum 13. The zero score with mean 00±0. P value is (>0.05) Non signification.

**Table (1): Patient’s Demographic characteristics.**

	Polycystic ovary				Male factor (control)			
	Mean	SD	Min	Max	Mean	SD	Min	Max
Age P=0.708 NS	28.97	4.88	20.00	39.00	29.41	5.59	18.00	41.00
BMI P=0.721 NS	26.58	2.52	22.66	34.05	26.32	3.46	10.82	32.83
Infertility duration P=0.783 NS	8.20	2.28	6.00	11.00	7.79	2.99	3.00	13.00
Rt ovary follicle P=0.531 NS	6.6	3.7	1.0	15.0	6.1	3.6	1.0	17.0
Lt ovary follicle P=0.381 NS	6.10	3.39	1.00	13.00	5.47	2.97	0.00	13.00

Student’s t-test was used.  
NS: No significant difference (P > 0.05).

In table 2, a total of 85 groups: 30 patients poly cystic ovary group which compared with control group male factor 55. No significant correlation was found with

any of the variables mentioned in the table and either of the studied groups.

**Table (2): Demographic characteristics of the studied groups.**

		Polycystic ovary		Male factor (control)	
		Count	%	Count	%
Medical history P=0.751 NS	No	23	76.7%	43	79.6%
	Yes	7	23.3%	11	20.4%

		Polycystic ovary		Male factor (control)	
		Count	%	Count	%
Infertility P=0.939 NS	Primary	23	76.7%	41	75.9%
	Secondary	7	23.3%	13	24.1%
	Yes	0	0.0%	0	0.0%
Miscarriage P=0.390 NS	0	27	90.0%	51	94.4%
	1.00	2	6.7%	3	5.6%
	2.00	1	3.3%	0	0.0%
History fertilization failure P=0.531 NS	No	27	90.0%	46	85.2%
	Yes	3	10.0%	8	14.8%

## Discussion

Patients were asked about their medical history which included any past taken un-prescribed medications, psychological traumas, family history and any other causes of PCOS. There was no significant correlation found between the patients of PCOS and controls in regards to their medical history. Data collected from literature disagrees with our results in this regard, as a study by<sup>(41)</sup> found that there was a difference in prevalence of PCOS between urban and rural areas as a result of different effects of environmental or risk factors on the occurrence of the disease including the psychological trauma and physical activity. Another study by<sup>(42)</sup> had found an influence of the family history, physical activity and stress on the occurrence of PCOS patients in comparison to controls.

A study found that the uptake of hormonal un-prescribed medication had an effect on vitamin D deficiency which in turns is a risk factor for PCOS. Another study found that the hormonal changes are a significant risk factor for PCOS patients<sup>(43)</sup>. Primary and secondary infertility were both found insignificant when correlated with PCOS patients and controls<sup>(44)</sup>. Primary infertility was defined as failure to become pregnant after at least one year of unprotected intercourse, while secondary infertility refers to women who have been pregnant at least once but failed to conceive after at least one year of unprotected intercourse<sup>(45)</sup>. A study by<sup>(46)</sup> found a significant correlation between primary and secondary infertility between patients and control groups. The same conclusions were made by<sup>(45)</sup> as a significant correlation was found between primary and secondary PCOS patients and their control group. also no significant relation was found by this study upon

comparison of the number of miscarriages in PCOS patients and controls. In this study sample over 90% of both groups had no miscarriages, this could explain the difference between our results and those of other studies. The risk of miscarriage in PCOS patients is increased and amounts to 30–50%, which means that for these women, it is three times as high as for healthy women<sup>(47)</sup>. The results of prospective, randomized trials suggest that the miscarriage instances in PCOS patients occur only in 15–25% of cases, which is a percentage comparable with the frequency of miscarriage in the general population<sup>(48, 49)</sup>. Unlike this study,<sup>(50, 51)</sup> had both found a significant correlation between patients and controls in regards to miscarriages. Polycystic ovarian syndrome (PCOS) induces anovulation in women of reproductive age, and is one of the pathological factors involved in the failure of in vitro fertilization (IVF). Indeed, PCOS women are characterized by poor quality oocytes<sup>(52)</sup>.

A valuable indicator of OHSS risk is estradiol serum level. It is recommended that E2 serum levels be determined during ovarian stimulation.<sup>(55)</sup> have investigated the estradiol serum level in PCOS patient and the predisposition of PCOS to OHSS and its relation to Triggering ovulation with gonadotropin-releasing hormone agonist in in vitro fertilization patients with PCOS. Several studies on the PCOS models of rats have effectively used estradiol in the induction of PCOS in rats proving the significance of the correlation between estradiol and PCOS<sup>(56, 57)</sup>. These results contradicts this study findings. A study by<sup>(58)</sup> have matched the characteristics of women with PCOS with their controls and found that estradiol serum level was found in a higher levels in women with PCOS than their controls. Study by<sup>(59)</sup> used multiple logistic regression and showed

that the number of oocytes retrieved, peak estradiol level, number of follicles at oocyte collection, and ovarian morphology (patient group) were all significantly correlated with regard to the patient developing severe OHSS on univariate analysis. Also, the number of follicles, oocytes retrieved and peak estradiol levels were all significantly increased in women with PCO and PCOS. There is a significant predictive association between  $E_2$  levels measured on stimulation day 3 and 5 and both ovarian hyper-response and extreme-response in IVF. However, the clinical value of stimulated  $E_2$  levels for the prediction of hyper-response is low because of the modest sensitivity and the high false positive rate. For the prediction of extreme-response the clinical value of stimulated  $E_2$  levels is moderate<sup>(60)</sup>.

On the contrary to our results, the studies done by (Tsikouras et al, 2015 and Ibanez et al, 2017) revealed a significant increase in the hormonal profile LH, LH/FSH, Testosterone and Progesterone compared to the control group. In women undergoing in vitro fertilization (IVF),<sup>(61)</sup> reported a negative association between FSH and AMH serum levels, concluding that the AMH level is highly predictive of the FSH level and can be used as an independent indicator of ovarian reserve. Recently,<sup>(62)</sup> also reported that intrafollicular AMH levels negatively correlated with FSH in follicles of normoandrogenic ovulatory women undergoing IVF, concluding that intrafollicular AMH levels reflect follicle sensitivity to FSH. In study by<sup>(63)</sup>, we noted increased serum AMH levels in women with polycystic ovary syndrome (PCOS). Moreover, AMH levels were negatively correlated to body mass index (BMI) and were independently predicted by the levels of luteinizing hormone (LH) and testosterone and by BMI. We concluded that increased LH levels might be an independent link between PCOS-associated disorders of ovulation and increased serum AMH concentrations.

In conditions of increased LH and normal to low FSH levels (such as in PCOS), the AMH serum levels are increased and tend to be associated with serum LH levels; whereas in conditions of increased FSH levels (such as in premature ovarian failure), AMH serum levels are decreased and tend to be associated with serum FSH levels<sup>(64)</sup>. A neuro endocrine characteristic believed to be of PCOS is steadily rapid LH (GnRH) pulsatility, which favours pituitary synthesis of LH over that of FSH and contributes to the increased LH concentrations and thereby altered LH: FSH ratios typical of PCOS. Insufficient FSH levels contribute to impaired follicular

development, while increased LH levels enhance ovarian androgen production<sup>(65)</sup>. A study found there was a persistent increase in LH level was noted among PCOS group starting from level of 5.04 $\mu$ U/ml and reaching up to level of 22.06 $\mu$ U/ml. Accordingly, LH: FSH ratio also showed a steady increase from 1 to 5.5 in these groups. There were no groups identified on the basis of LH: FSH ratios in the control as their LH: FSH ratios were within the same range<sup>(66)</sup>.

## Conclusion

High concentration of follicular fluid IL -17 is positively associated with the disease of polycystic ovary (PCOS).

**Compliance with Ethical Standards:** The authors declare that they have no conflict of interest.

The author declare that research involved human participants and consent was obtained.

This research was funded by the authors. The Research Ethical Committee at scientific research by ethical approval of both environmental and health and higher education and scientific research ministries in Iraq.

**Conflict of Interest:** The authors declare that they have no conflict of interest.

**Funding:** Self-funding

## References

1. Human Fertilisation and Embryology Authority. In vitro fertilisation (IVF) 2020. Available from: <https://www.hfea.gov.uk/treatments/explore-all-treatments/in-vitro-fertilisation-ivf/>.
2. Victorian Assisted Reproductive Treatment Authority. Types of assisted reproductive treatment 2020. Available from: <https://www.varta.org.au/information-support/assisted-reproductive-treatment/types-assisted-reproductive-treatment>
3. Mathur RS, Akande AV, Keay SD, Hunt LP, Jenkins JM. Distinction between early and late ovarian hyperstimulation syndrome. *Fertility and sterility*. 2000;73(5):901-7.
4. Bergh T, Lundkvist Ö. Clinical complications during in-vitro fertilization treatment. *Human Reproduction*. 1992;7(5):625-6.
5. Serour GI, Aboulghar M, Mansour R, Sattar MA,

- Amin Y, Aboulghar H. Complications of medically assisted conception in 3,500 cycles. *Fertility and Sterility*. 1998;70(4):638-42.
6. Westergaard HB, Johansen AMT, Erb K, Andersen AN. Danish National IVF Registry 1994 and 1995. Treatment, pregnancy outcome and complications during pregnancy. *Acta obstetrica et gynecologica Scandinavica*. 2000;79(5):384-9.
  7. Nygren K. Assisted reproductive technology in Europe, 2002. Results generated from European registers by ESHRE. *Human Reproduction*. 2006;21(7):1680-97.
  8. Cluroe AD, Synek BJ. A fatal case of ovarian hyperstimulation syndrome with cerebral infarction. *Pathology*. 1995;27(4):344-6.
  9. Koo E-J, Rha J-H, Lee B-I, Kim M-O, Ha C-K. A case of cerebral infarct in combined antiphospholipid antibody and ovarian hyperstimulation syndrome. *Journal of Korean medical science*. 2002;17(4):574.
  10. Abramov Y, Elchalal U, Schenker JG. Pulmonary manifestations of severe ovarian hyperstimulation syndrome: a multicenter study. *Fertility and sterility*. 1999;71(4):645-51.
  11. De Sutter P. *Miscellaneous risks and complications. Assisted Reproductive Technologies: Quality and Safety* Taylor & Francis, London, UK. 2004:247-55.
  12. Klemetti R, Sevón T, Gissler M, Hemminki E. Complications of IVF and ovulation induction. *Human Reproduction*. 2005;20(12):3293-300.
  13. Humaidan P, Quartarolo J, Papanikolaou EG. Preventing ovarian hyperstimulation syndrome: guidance for the clinician. *Fertility and sterility*. 2010;94(2):389-400.
  14. Delvigne A, Rozenberg S. Epidemiology and prevention of ovarian hyperstimulation syndrome (OHSS): a review. *Human reproduction update*. 2002;8(6):559-77.
  15. Fischer D, Reisenbüchler C, Rösner S, Haussmann J, Wimberger P, Goeckenjan M. Avoiding OHSS: Controlled Ovarian Low-Dose Stimulation in Women with PCOS. *GeburtshilfeFrauenheilkd*. 2016;76(6):718-26.
  16. Agapova SE, Cameo T, Sopher AB, Oberfield SE, editors. *Diagnosis and challenges of polycystic ovary syndrome in adolescence. Seminars in reproductive medicine*; 2014: NIH Public Access.
  17. Spritzer PM. Polycystic ovary syndrome: reviewing diagnosis and management of metabolic disturbances. *ArquivosBrasileiros de Endocrinologia & Metabologia*. 2014;58(2):182-7.
  18. Mohammad MB, Seghinsara AM. Polycystic ovary syndrome (PCOS), diagnostic criteria, and AMH. *Asian Pacific journal of cancer prevention: APJCP*. 2017;18(1):17.
  19. Dumont A, Robin G, Catteau-Jonard S, Dewailly D. Role of Anti-Müllerian Hormone in pathophysiology, diagnosis and treatment of Polycystic Ovary Syndrome: a review. *Reproductive Biology and Endocrinology*. 2015;13(1):137.
  20. Azziz R, Woods KS, Reyna R, Key TJ, Knochenhauer ES, Yildiz BO. The prevalence and features of the polycystic ovary syndrome in an unselected population. *The Journal of Clinical Endocrinology & Metabolism*. 2004;89(6):2745-9.
  21. March WA, Moore VM, Willson KJ, Phillips DI, Norman RJ, Davies MJ. The prevalence of polycystic ovary syndrome in a community sample assessed under contrasting diagnostic criteria. *Human reproduction*. 2010;25(2):544-51.
  22. Rackow BW. Polycystic ovary syndrome in adolescents. *Current Opinion in Obstetrics and Gynecology*. 2012;24(5):281-7.
  23. Escobar-Morreale HF. Polycystic ovary syndrome: definition, aetiology, diagnosis and treatment. *Nature Reviews Endocrinology*. 2018;14(5):270.
  24. Azziz R, Carmina E, Chen Z, Dunaif A, Laven JS, Legro RS, et al. Polycystic ovary syndrome. *Nature reviews Disease primers*. 2016;2(1):1-18.
  25. Tsikouras P, Spyros L, Manav B, Zervoudis S, Poiana C, Nikolaos T, et al. Features of polycystic ovary syndrome in adolescence. *Journal of medicine and life*. 2015;8(3):291.
  26. Cupisti S. *Komplikation bei Ovulationsinduktion. Das ovarielle Überstimulationssyndrom. Geburtshilfe Frauenheilkd*. 2012;72(09):798-801.
  27. Karakose M, Demircan K, Tural E, Demirci T, Arslan M, Sahin M, et al. Clinical significance of ADAMTS1, ADAMTS5, ADAMTS9 aggrecanases and IL-17A, IL-23, IL-33 cytokines in polycystic ovary syndrome. *Journal of endocrinological investigation*. 2016;39(11):1269-75.
  28. Manti S, Leonardi S, Panasiti I, Arrigo T, Salpietro C, Cuppari C. Serum IL-10, IL-17 and IL-23 levels as “bioumoral bridges” between dyslipidemia and

- atopy. *Cytokine*. 2017;99:43-9.
29. Zhang T, Tian F, Huo R, Tang A, Zeng Y, Duan YG. Detection of dendritic cells and related cytokines in follicular fluid of patients with polycystic ovary syndrome. *American journal of reproductive immunology*. 2017;78(3):e12717.
  30. Sarapik A, Velthut A, Haller-Kikkatalo K, Faure GC, Béné M-C, de Carvalho Bittencourt M, et al. Follicular proinflammatory cytokines and chemokines as markers of IVF success. *Clinical and Developmental Immunology*. 2012;2012.
  31. Gaffen SL, Jain R, Garg AV, Cua DJ. IL-23-IL-17 immune axis: discovery, mechanistic understanding, and clinical testing. *Nature reviews Immunology*. 2014;14(9):585.
  32. Sabbaghi M, Aram R, Roustaei H, Fadavi Islam M, Daneshvar M, Castaño AR, et al. IL-17A concentration of seminal plasma and follicular fluid in infertile men and women with various clinical diagnoses. *Immunological investigations*. 2014;43(7):617-26.
  33. Abdullah Z, Masood Q, Hassan I, Kirmani O. Hormonal profile and polycystic ovaries in women with acne vulgaris. *Indian Journal of Dermatology, Venereology, and Leprology*. 2013;79(3):422.
  34. Humaidan P, Quartarolo J, Papanikolaou EG. Preventing ovarian hyperstimulation syndrome: guidance for the clinician. *Fertility and sterility*. 2010;94(2):389-400.
  35. Humaidan P, Polyzos NP, Alsbjerg B, Erb K, Mikkelsen AL, Elbaek HO, et al. GnRH $\alpha$  trigger and individualized luteal phase hCG support according to ovarian response to stimulation: two prospective randomized controlled multi-centre studies in IVF patients. *Human reproduction (Oxford, England)*. 2013;28(9):2511-21.
  36. Krishna D, Dhoble S, Praneesh G, Rathore S, Upadhaya A, Rao K. Gonadotropin-releasing hormone agonist trigger is a better alternative than human chorionic gonadotropin in PCOS undergoing IVF cycles for an OHSS Free Clinic: A Randomized control trial. *J Hum Reprod Sci*. 2016;9(3):164-72.
  37. Nastri CO, Teixeira DM, Moroni RM, Leitão VM, Martins WP. Ovarian hyperstimulation syndrome: pathophysiology, staging, prediction and prevention. *Ultrasound in obstetrics & gynecology : the official journal of the International Society of Ultrasound in Obstetrics and Gynecology*. 2015;45(4):377-93.
  38. Hsu M-I. Changes in the PCOS phenotype with age. *Steroids*. 2013;78(8):761-6.
  39. Haakova L, Cibula D, Rezabek K, Hill M, Fanta M, Zivny J. Pregnancy outcome in women with PCOS and in controls matched by age and weight. *Human Reproduction*. 2003;18(7):1438-41.
  40. Mellembakken JR, Berga SL, Kilen M, Tanbo TG, Åbyholm T, Fedorcsák P. Sustained fertility from 22 to 41 years of age in women with polycystic ovarian syndrome. *Human Reproduction*. 2011;26(9):2499-504.
  41. Vidya Bharathi R, Swetha S, Neerajaa J, Varsha Madhavica J, Janani DM, Rekha SN, et al. An epidemiological survey: Effect of predisposing factors for PCOS in Indian urban and rural population. *Middle East Fertility Society Journal*. 2017;22(4):313-6.
  42. Shan B, Cai J-h, Yang S-Y, Li Z-R. Risk factors of polycystic ovarian syndrome among Li People. *Asian Pacific Journal of Tropical Medicine*. 2015;8(7):590-3.
  43. Li HWR, Brereton RE, Anderson RA, Wallace AM, Ho CK. Vitamin D deficiency is common and associated with metabolic risk factors in patients with polycystic ovary syndrome. *Metabolism*. 2011;60(10):1475-81.
  44. Zhang J, Liu XF, Liu Y, Xu LZ, Zhou LL, Tang LL, et al. Environmental risk factors for women with polycystic ovary syndrome in china: a population-based case-control study. *J Biol Regul Homeost Agents*. 2014;28(2):203-11.
  45. Dilbaz B, Cınar M, Ozkaya E, Tonyalı NV, Dilbaz S. Health related quality of life among different PCOS phenotypes of infertile women. *J Turk Ger Gynecol Assoc*. 2012;13(4):247-52.
  46. Greil AL, Shreffler KM, Schmidt L, McQuillan J. Variation in distress among women with infertility: evidence from a population-based sample. *Human reproduction (Oxford, England)*. 2011;26(8):2101-12.
  47. Homburg R. Pregnancy complications in PCOS. *Best Practice & Research Clinical Endocrinology & Metabolism*. 2006;20(2):281-92.
  48. Legro RS, Barnhart HX, Schlaff WD, Carr BR, Diamond MP, Carson SA, et al. Clomiphene, metformin, or both for infertility in the polycystic

- ovary syndrome. *New England Journal of Medicine*. 2007;356(6):551-66.
49. Giudice LC. Endometrium in PCOS: implantation and predisposition to endocrine CA. *Best practice & research Clinical endocrinology & metabolism*. 2006;20(2):235-44.
  50. Patel SM, Nestler JE. Fertility in polycystic ovary syndrome. *Endocrinology and Metabolism Clinics*. 2006;35(1):137-55.
  51. Tian L, Shen H, Lu Q, Norman RJ, Wang J. Insulin resistance increases the risk of spontaneous abortion after assisted reproduction technology treatment. *The Journal of Clinical Endocrinology & Metabolism*. 2007;92(4):1430-3.
  52. Pacchiarotti A, Carlomagno G, Antonini G, Pacchiarotti A. Effect of myo-inositol and melatonin versus myo-inositol, in a randomized controlled trial, for improving in vitro fertilization of patients with polycystic ovarian syndrome. *Gynecological Endocrinology*. 2016;32(1):69-73.
  53. Lesoine B, Regidor P-A. Prospective randomized study on the influence of myoinositol in PCOS women undergoing IVF in the improvement of oocyte quality, fertilization rate, and embryo quality. *International journal of endocrinology*. 2016;2016.
  54. Amato G, Conte M, Mazziotti G, Lalli E, Vitolo G, Tucker AT, et al. Serum and follicular fluid cytokines in polycystic ovary syndrome during stimulated cycles. *Obstetrics & Gynecology*. 2003;101(6):1177-82.
  55. Manzanares MA, Gómez-Palomares JL, Ricciarelli E, Hernández ER. Triggering ovulation with gonadotropin-releasing hormone agonist in in vitro fertilization patients with polycystic ovaries does not cause ovarian hyperstimulation syndrome despite very high estradiol levels. *Fertility and sterility*. 2010;93(4):1215-9.
  56. Miri M, Jashni HK, Alipour F. Effect of exercise intensity on weight changes and sexual hormones (androstenedione and free testosterone) in female rats with estradiol valerate-induced PCOS. *Journal of ovarian research*. 2014;7(1):37.
  57. Dikmen A, Ergenoglu AM, Yeniel AO, Dilsiz OY, Ercan G, Yilmaz H. Evaluation of glycemic and oxidative/antioxidative status in the estradiol valerate-induced PCOS model of rats. *European Journal of Obstetrics & Gynecology and Reproductive Biology*. 2012;160(1):55-9.
  58. Mannerås-Holm L, Leonhardt H, Kullberg J, Jennische E, Odén A, Holm G, et al. Adipose Tissue Has Aberrant Morphology and Function in PCOS: Enlarged Adipocytes and Low Serum Adiponectin, But Not Circulating Sex Steroids, Are Strongly Associated with Insulin Resistance. *The Journal of Clinical Endocrinology & Metabolism*. 2011;96(2):E304-E11.
  59. Swanton A, Storey L, McVeigh E, Child T. IVF outcome in women with PCOS, PCO and normal ovarian morphology. *European Journal of Obstetrics & Gynecology and Reproductive Biology*. 2010;149(1):68-71.
  60. Hendriks DJ, Klinkert ER, Bancsi LFJMM, Looman CWN, Habbema JDF, te Velde ER, et al. Use of Stimulated Serum Estradiol Measurements for the Prediction of Hyperresponse to Ovarian Stimulation in in Vitro Fertilization (IVF). *Journal of Assisted Reproduction and Genetics*. 2004;21(3):65-72.
  61. Singer T, Barad DH, Weghofer A, Gleicher N. Correlation of antimüllerian hormone and baseline follicle-stimulating hormone levels. *Fertility and sterility*. 2009;91(6):2616-9.
  62. Dumesic DA, Lesnick TG, Stassart JP, Ball GD, Wong A, Abbott DH. Intrafollicular antimüllerian hormone levels predict follicle responsiveness to follicle-stimulating hormone (FSH) in normoandrogenic ovulatory women undergoing gonadotropin releasing-hormone analog/recombinant human FSH therapy for in vitro fertilization and embryo transfer. *Fertility and sterility*. 2009;92(1):217-21.
  63. Piouka A, Farmakiotis D, Katsikis I, Macut D, Gerou S, Panidis D. Anti-Müllerian hormone levels reflect severity of PCOS but are negatively influenced by obesity: relationship with increased luteinizing hormone levels. *American Journal of Physiology-Endocrinology And Metabolism*. 2009;296(2):E238-E43.
  64. Georgopoulos NA, Saltamavros AD, Decavalas G, Piouka A, Katsikis I, Panidis D. Serum AMH, FSH, and LH levels in PCOS. *Fertility and sterility*. 2010;93(3):e13.
  65. Blank S, McCartney C, Marshall J. The origins and sequelae of abnormal neuroendocrine function in polycystic ovary syndrome. *Human reproduction update*. 2006;12(4):351-61.

66. Malini NA, Roy George K. Evaluation of different ranges of LH:FSH ratios in polycystic ovarian syndrome (PCOS) – Clinical based case control study. *General and Comparative Endocrinology*. 2018;260:51-7.
67. Szosland K, Pawłowicz P, Lewiński A. Prolactin secretion in polycystic ovary syndrome (PCOS). *Neuroendocrinology Letters*. 2015;36(1).
68. Su H-W, Chen C-M, Chou S-Y, Liang S-j, Hsu C-S, Hsu M-i. Polycystic ovary syndrome or hyperprolactinaemia: a study of mild hyperprolactinaemia. *Gynecological Endocrinology*. 2011;27(1):55-62.
69. Schroeder A, Tauchert S, Ortmann O, Diedrich K, Weiss J. Differential responds of prolactin secretion to hyperglycaemia and hypoglycaemia in healthy women and in women with polycystic ovary syndrome. *Fertility and sterility*. 2004;82:S297-S8.
70. GarberJR, CobinRH, GharibH, HennesseyJV, Klein I, Mechanick JI, et al. Clinical practice guidelines for hypothyroidism in adults: cosponsored by the American Association of Clinical Endocrinologists and the American Thyroid Association. *Thyroid*. 2012;22(12):1200-35.
71. Janssen OE, Mehlmauer N, Hahn S, Offner AH, Gartner R. High prevalence of autoimmune thyroiditis in patients with polycystic ovary syndrome. *European journal of endocrinology*. 2004;150(3):363-70.
72. Muderris II, Boztosun A, Oner G, Bayram F. Effect of thyroid hormone replacement therapy on ovarian volume and androgen hormones in patients with untreated primary hypothyroidism. *Annals of Saudi medicine*. 2011;31(2):145-51.
73. Ghosh S, Kabir SN, Pakrashi A, Chatterjee S, Chakravarty B. Subclinical hypothyroidism: a determinant of polycystic ovary syndrome. *Hormone Research in Paediatrics*. 1993;39(1-2):61-6.
74. MOTAMEDZADEH, L., MOHAMMADI, M. M., HADINEDOUSHAN, H., FARASHAHI YAZD, E. & FESAHAAT, F. 2019. Association of IL-17 and IL-23 follicular fluid concentrations and gene expression profile in cumulus cells from infertile women at risk for ovarian hyperstimulation syndrome. *Human Fertility*, 1-7.
75. Nouri K, Tempfer CB, Lenart C, Windischbauer L, Walch K, et al. (2014) Predictive factors for recovery time in patients suffering from severe OHSS. *Reprod Biol Endocrinol* 12: 59-7827-12-59.

# Methicillin-Resistance *Staphylococcus Aureus* (MRSA) in Hospitals: The Unwanted Guest

Nadhim N. Tahir<sup>1</sup>, Saad S. Hamim<sup>2</sup>

*1M.Sc, Department of Pathological Analysis-College of Science-Thi-Qar University and Work in Ministry of Health-Thi-Qar Health Directorate, 2Professor, Department of Pathological Analysis-College of Science-Thi-Qar University*

## Abstract

**Background:** Methicillin-resistant *Staphylococcus aureus* (MRSA) is one of the most frequent causes of Nosocomial infections around the world.

**Aims:** This study aimed to detect some diagnostic genes and some virulence factor genes for MRSA isolates.

**Method:** During the period of from August to December 2019, 46 MRSA were isolated from different clinical samples such as Urinary Tract Infections (UTIs), Wounds infection's, Diabetics foot patients, Burn patients and Otitis media in Al- Hussain Teaching Hospital in Thi-qar province, Iraq. All MRSA isolates were subjected to conventional Polymerase Chain Reaction to detect 16SrRNA and *mecA* genes and some virulence factors genes *hla* and *tst-1* genes. Six PCR product were selected and subjected to partial DNA sequencing for the 16SrRNA gene to follow up their possible relationship between them and what recorded globally in Genbank.

**Results:** The results revealed that all isolates 46(100%) have 16SrRNA, *mecA*, and *hla* genes, While only 23 isolated (50%) have *tst-1* gene. The six PCR product of 16SrRNA was registered in Genbank under official accession numbers of (MT605393.1, MT605385.1, MT605394.1, MT605386.1, MT605387.1, and MT605388.1). The phylogenetic tree that was constructed by MEGA10 software showed that there were different molecular relationships among the local *Staph. aureus* isolates with analogous ones around the world.

**Keywords:** MRSA; Gene sequencing, Phylogenetic tree, Diagnostic genes, Virulence factors.

## Introduction

One of the main public health problem worldwide, especially in developing countries Nosocomial infections (NIs) [1]. As these infections can occur through hospital admission, they cause long stay, incapacity, and economic load. Commonly prevalent infections include central line-associated bloodstream infections, catheter-associated urinary tract infections, surgical site infections and ventilator-associated pneumonia. There are several pathogens cause nosocomial infections, these pathogens include bacteria, viruses, fungal and parasites [2]. Methicillin-resistant *Staphylococcus aureus* (MRSA) is one of the most common reasons of hospital- and community-associated infections. The ability of this bacteria to resist to the entire class of

$\beta$ -lactam antibiotics, such as methicillin and penicillin, therefore makes MRSA infections difficult to treat [3]. For instance, when the starter of penicillin to the market for the treatment of hospitalized patients, the resistant strains to the penicillin rapidly appeared [4]. Presently, MRSA strains account for various of Staphylococcal infections and increasing reports of MRSA strains in the worldwide [5].

## Material and Method

**Samples Collection:** A total of 46 MRSA were isolated from patients of both gender of different ages who suffered from symptom-based Urinary Tract Infections (UTIs), Wounds infection's, Diabetics feet patients, Burn patients and Otitis media. A patients took



care and medication at AL-Hussain Teaching Hospital in AL-Nasiriya City, Southern Iraq from August to December 2019.

**Isolation and identification of *Staphylococcus aureus*:** The collected specimens were inoculated onto blood agar, mannitol salt agar, and MacConkey agar according to standard method. *Staph. aureus* was identified depending on the morphological features (colony size, shape, color, hemolysis, translucency, edge, elevation, and texture) on culture media<sup>[6]</sup>. The biochemical tests were used include Catalase, Coagulase, Oxidase and Novobiocin<sup>[7]</sup>. The diagnostic of bacteria

were confirmed by API system and Vitek2 compact (biomerieux, France).

**Molecular Detection of *Staph. aureus*:** 1. Genomic DNA was extracted from MRSA isolates by using Genomic DNA Mini Bacteria Kit (Anatolia/Turkey). 2. All MRSA isolates were subjected to the detection of 16SrRNA, *mecA*, *hla*, and *tst-1* genes by conventional PCR technique using specific primers pairs for every gene (Table 1). The amplification genes were put into the thermo cycler (ABM Canada) and the right PCR cycling program parameters conditions were adjusted according to each primer.

**Table 1: Specific primers of *Staph. aureus*.**

Gene	Primer sequences (5° - 3°)		Product size (bp)
16SrRNA	F	AGAGTTTGATCCTGGCTCAG	1500
	R	GGTTACCTTGTTACGACTT	
<i>mecA</i>	F	TGAGTTGAACCTGGTGAAGTT	855
	R	TGGTATGTGGAAGTTAGATTGG	
<i>tst-1</i>	F	ACCCCTGTTCCCTTATCATC	326
	R	TTTTCAGTATTTGTATCGCC	
<i>hla</i>	F	GAAAACACGTATAGTCAGCTCAGTAAC	951
	R	GTCATTTCTTCTTTTCCCAATCG	

**Sequencing Analysis:** The PCR product of six MRSA isolated from different infected sites were subjected to partial sequencing of 16SrRNA gene and blasted in NCBI against standard strains of *Staph. aureus*. The samples sequences which assigned primarily as (NSTQ1, NSTQ2, NSTQ3, NSTQ4, NSTQ5, and NSTQ6). A phylogenetic tree for genes sequence was constructed by using (MEGA10) software<sup>[8]</sup>.

**Results**

**Detection of 16SrRNA and *mecA* genes:** All MRSA isolates (n=46) were diagnosed by conventional PCR technique through the amplification of 16SrRNA and *mecA* genes to confirm that the verified isolates are *Staph. aureus* and MRSA, respectively. The results showed that all isolates were positive for both the targeted genes. the size of products were approximately

1500 bp for 16SrRNA gene and approximately 855 bp for *mecA* gene.

**Detection of virulence genes:** Two of virulence genes of MRSA were detected through the amplification of *hla* and *tst-1* genes. The results revealed that all isolates 46(100%) had *hla* gene and only 23 isolated (50%) had *tst-1* gene a with a product sizes of approximately 951 bp and 326 bp, respectively (Fig.1, 2).

**Phylogenetic analysis:** The six selected MRSA strain granted the official Genbank accession numbers of MT605393.1, MT605385.1, MT605394.1, MT605386.1, MT605387.1 and MT605388.1. The phylogenetic tree that was constructed by MEGA10 software showed that there were different molecular relationships among the local *Staph. aureus* isolates with analogous ones around the world (Fig. 3).

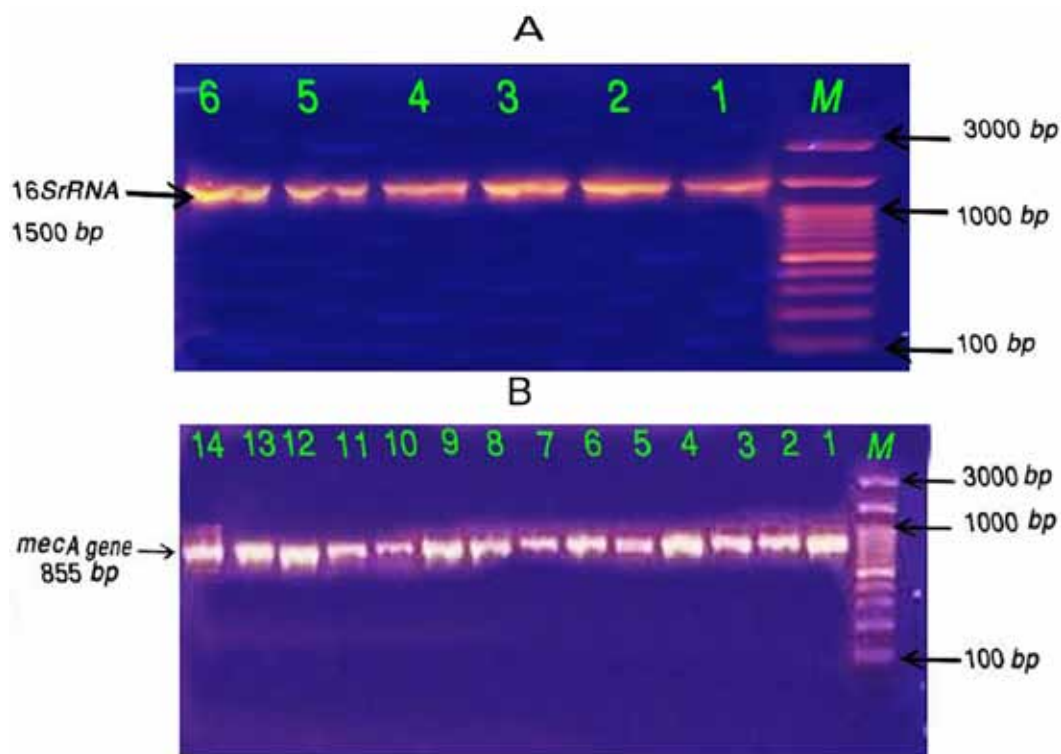


Figure 1 A: Agarose gel electrophoresis of 16SrRNA gene. M:3000 bp ladder; Lane [1-6] were positive with a product size of approximately 1500 bp. B: Agarose gel electrophoresis of *mecA* gene. M:3000 bp ladder; Lane [1-14] were positive with a product size of approximately 855 bp.

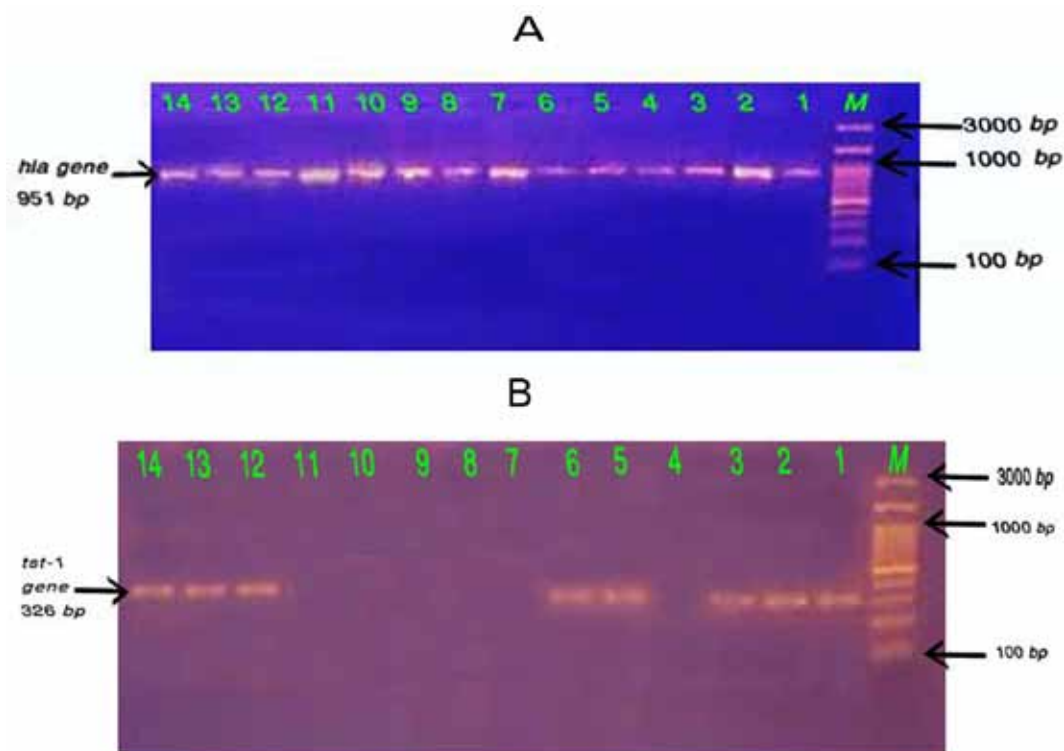
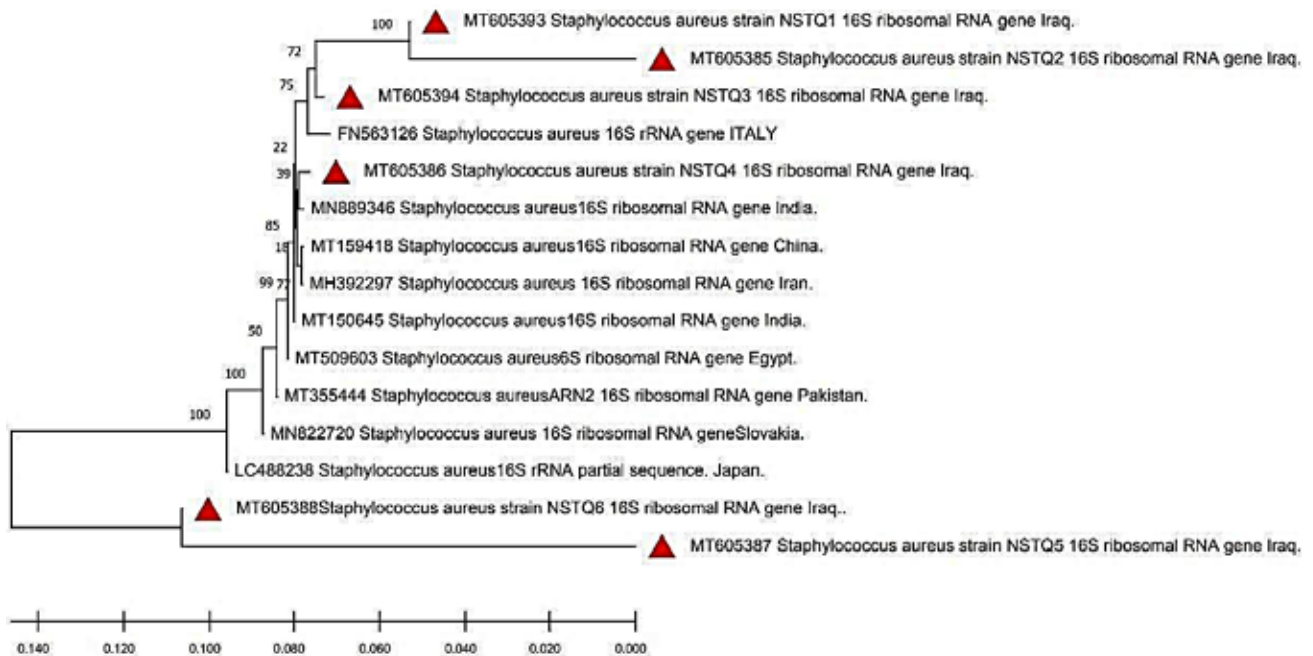


Figure 2 A: Agarose gel electrophoresis of *hla* gene. M:3000 bp ladder; Lane [1-14] were positive with a product size of approximately 951 bp. B: Agarose gel electrophoresis of *tst-1* gene. M:3000 bp ladder; Lane [1,2,3,5,6,12,13 and 14] were positive; Lane (4,7,8,9,10,11) were negative, the a product size of approximately 326 bp.



**Figure 3: Phylogenetic tree analysis based on the (16sRNA) gene partial sequence that used for genetic relationship analysis of local *Staph. aureus*.**

## Discussion

Nosocomial infections, is an infection established at some point in hospital care which develops no longer present or incubating at the time of admission, the infections which arise further than 48 hours after admission are also taken into consideration nosocomial [9]. All MRSA isolates were diagnosed by PCR technique through the amplification of 16SrRNA and *mecA* genes to confirm that the verified isolates are *Staph. aureus* and MRSA, respectively. These results agreed completely with previous local studies like [10,11,12]. The drug resistance of MRSA is mainly because that the gene encoding regulates the expression of Penicillin Binding Protein (PBP2a), which is encoded by *mecA* gene, and arisen on the surface, which lies on the *Staphylococcus* gene cassette of SCC *mec*. Thus, the detection of *mecA* gene can be used to confirm diagnosis of MRSA isolates [13]. Other studies inside and outside Iraq revealed variable MRSA occurrence with a rates of 15% and 77.33%, respectively [14,15]. Different MRSA isolation among studies may be explained by the differences of samples or the different PCR assays. The current study tried to amplify *tst-1* and *hla* genes as a virulence genes in MRSA isolates. All isolates of MRSA have *hla* gene which agreed with the local study of [16] who noted highly frequency of *hla* gene 70(82.35%) between MRSA isolated from burn patients.

Other worldwide studies were closely compatible to the present results such as what performed in Uganda and united states whom recorded (100%) frequency of *hla* gene in MRSA isolates [17,18]. While, in Iran [19] results were incompatible with the current results who noted that frequency of *hla* gene was (51.8%). The highly frequent of *hla* gene maybe because that the most of *Staph. aureus* isolated from human have usually a *hla*, since the human platelets and monocytes are more subtle to the alpha toxin [20]. The current study revealed that a half of MRSA isolates contain *tst-1* gene, which seems not supported with other similar local studies in Iraq who showed a variable frequency of *tst-1* gene among MRSA isolates from clinical samples with 30% and 84%, respectively [21,22]. A closely related results to the present results were recorded in Iran who noted that frequency of *tst-1* gene was (51.4%) among MRSA isolates from intensive care units patients [23]. The relatively high rate of *tst-1* positive *Staph. aureus* isolates coupled with the low incidence of TSS strongly suggests that sufficient *tst-1* expression causes disease only under the appropriate environmental and/or genetic regulation control. Since the virulence of microbe may be dependent on the amount of toxins production [24]. Sequencing technique is one of the modern advanced development technique in molecular biology. In this way mutation and genetic relationship can be detected between bacterial isolates

rapidly<sup>[25]</sup>. The DNA sequencing analysis results for 16SrRNA *Staph. aureus* gene isolates were genetically identical by 99% with those found in the gene bank. Six isolates are shown for the 16SrRNA gene genetically far from the genes taken from the gene bank because they appeared in the out-group. The phylogenetic tree showed that there were different molecular relationships among the local *Staph. aureus* isolates with analogous ones around the world (Fig. 4).

### Conclusions

Methicillin-resistance *Staphylococcus aureus* (MRSA) were increased and become more prevalent, the molecular assay and gene sequencing were a significant tools in pathogenesis and evolutionary relationships of nosocomial infections.

**Ethical Clearance:** The Research Ethical Committee at scientific research by ethical approval of both environmental and health and higher education and scientific research ministries in Iraq

**Conflict of Interest:** The authors declare that they have no conflict of interest.

**Funding:** Self-funding

### References

1. Abdel-Wahab F, Ghoneim M, Khashaba M, El-Gilany AH & Abdel-Hady D. Nosocomial infection surveillance in an Egyptian neonatal intensive care uni. *J Hosp Infect.* 2013; 83(3):196–9.
2. Khan HA, Baig FK & Mehboob R. Nosocomial infections: Epidemiology, prevention, control and surveillance. *Asian Pac J Trop Biomed.* 2017;7(5):478–82.
3. Otto M. MRSA virulence and spread. *Cell Microbiol.* 2012;14(10):1513–21.
4. Rapp RP. Overview of resistant gram-positive pathogens in the surgical patient. *Surg Infect (Larchmt).* 2000; 1(1):39–47.
5. Dibah S, Arzanlou M, Jannati E & Shapouri R. Prevalence and antimicrobial resistance pattern of methicillin resistant *Staphylococcus aureus* (MRSA) strains isolated from clinical specimens in Ardabil, Iran. *Iran J Microbiol.* 2014; 6(3):163-168.
6. MacFaddin JF. *Biochemical Tests for Identification of Medical Bacteria*, Williams and Wilkins. Philadelphia, PA. 2000;113.
7. Harley, J.P. & Prescott, L.M. *Laboratory Exercises in Microbiology*. 7th ed. McGraw-Hill Higher Education. New York. 2007.
8. Kumar S, Stecher G, Li M, Knyaz C, Tamura K. & MEGA X: Molecular evolutionary genetics analysis across computing platforms. *Mol Biol Evol.* 2018; 35(6):1547–9.
9. Parthasarathy S, Saminathan, Milton AAP, Priya GB, Aravind M, Jeeva K, & Agarwal RK. Nosocomial infections and their surveillance in veterinary hospitals. *Adv Anim Vet Sci.* 2015; 3(2s):1–24.
10. Ibed, A. N., & Hamim, S. S. Molecular detection of methicillin-resistant *Staphylococcus aureus* isolated from burns infection in Al-nasiriyah city. *World Journal of Pharmaceutical Sciences*, (2014); 2: 950-954
11. Degaim, Z. D., Shani, W. S. & Hamim, S. S. Virulence factors of Methicillin Resistant *Staphylococcus aureus* (MRSA) isolated from burn patients. *IntJ Curr Microbiol App Sci.*2015; 4(7):898–906.
12. Abbas, A. A. & Hamim, S. S. Serological and Molecular detection of *Staphylococcus aureus* isolated from UTI patients. *University of Thi-Qar Journal*,(2019); 14(3): 64–79.
13. Chen, X., Wu, Z., Zhou, Y., Zhu, J., Li, K., Shao, H., & Wei, L. Molecular and virulence characteristics of methicillin-resistant *Staphylococcus aureus* in burn patients. *Front Lab Med.* 2017; 1(1):43–7.
14. Motamedi H, Abadi SSR, Moosavian SM & Torabi M. The Association of Panton-valentine leukocidin and *mecA* genes in methicillin-resistant *Staphylococcus aureus* isolates from patients referred to educational hospitals in Ahvaz, Iran. *Jundishapur J Microbiol.* 2015; 8(8):e22021.
- 15 Hamim, S. S. Molecular characterization of *mecA* gene in Methicillin-Resistant *Staphylococcus aureus*. *University of Thi-Qar Journal of Science*, 2016; 6(1): 25-29.
16. Degaim, Z. D., Shani, W. S., & Hamim, S. S. Immunization model of Rats treated with two antigens from MRSA bacteria isolated from burn patients. *European Journal of Biology and Medical Science Research*, (2016);4(1): 26-36.
17. Kateete, D. P., Namazzi, S., Okee, M., Okeng, A., Baluku, H., Musisi, N. L., Katabazi, F. A., Joloba, M. L., Ssentongo, R., & Najjuka, F. C. High

- prevalence of methicillin resistant *Staphylococcus aureus* in the surgical units of Mulago hospital in Kampala, Uganda. *BMC Res Notes*. 2011; 4(1):1–5.
18. Shukla, S. K., Karow, M. E., Brady, J. M., Stemper, M. E., Kislow, J., Moore, N., Wroblewski, K., Chyou, P.-H., Warshauer, D. M., & Reed, K. D. Virulence genes and genotypic associations in nasal carriage, community-associated methicillin-susceptible and methicillin-resistant USA400 *Staphylococcus aureus* isolates. *J Clin Microbiol*. 2010; 48(10):3582–92.
  19. Motallebi M, Jabalameli F, Asadollahi K, Taherikalani M & Emaneini M. Spreading of genes encoding enterotoxins, haemolysins, adhesin and biofilm among methicillin resistant *Staphylococcus aureus* strains with *Staphylococcal cassette chromosome mec* type IIIA isolated from burn patients. *Microb Pathog*. 2016; 97:34–37.
  20. Berube BJ & Wardenburg JB. *Staphylococcus aureus*  $\alpha$ -toxin: nearly a century of intrigue. *Toxins (Basel)*. 2013; 5(6):1140–66.
  21. Abed SM, Raof WM, Assie AHA, Al-Jaafari ENI & Hadi YA. Multiplex PCR for Detection of Exfoliative Toxins, and Toxic Shock Syndrome Toxin 1 Genes in MRSA Strains of Clinical *Staphylococcus aureus* Isolates. *Tikrit J Pure Sci*. 2018; 21(3):39–44.
  22. Sultan FB, Abed S & Ali L. Prevalence of *Staphylococcus aureus* toxins genes in clinical and food isolates in Iraq. 2019; 11(2):636–42.
  23. Eftekhari F, Rezaee R, Azad M, Azimi H, Goudarzi H & Goudarzi M. Distribution of adhesion and toxin genes in *Staphylococcus aureus* strains recovered from hospitalized patients admitted to the ICU. *Arch Pediatr Infect Dis*. 2017; 5(1):e39349.
  24. Bronner S, Monteil H & Prévost G. Regulation of virulence determinants in *Staphylococcus aureus*: complexity and applications. *FEMS Microbiol Rev*. 2004; 28(2):183–200.
  25. Tamura K, Stecher G, Peterson D, Filipski A & Kumar S. MEGA6: molecular evolutionary genetics analysis version 6.0. *Mol Biol Evol*. 2013; 30(12):2725–9.

# Assessment of Health Workers Knowledge toward Occupational Health and Safety Program in Alkut City's Primary Health Care Centers

Duaa Malik Dhahir<sup>1</sup>, Naji Yasser Al Mayahi<sup>2</sup>

<sup>1</sup>M.Sc. Student, Nursing College, University of Babylon,

<sup>2</sup>Assistant professor Community Health Nursing, Nursing College, University of Babylon

## Abstract

Health care workers are always exposed to physical, chemical, psychological and biological agents that affect their health. Regular information is serious for setting priorities necessary to enhance providers, health and safety, which healthcare facilities like other high danger workplaces are categorized by a high level of exposure to hazards agents, which significant danger toward health of workers.

A descriptive cross sectional study is carried out throughout (1/September/2019 to 1/September/2020) in order to assess the Health Workers Toward "Occupational Health and safety program" and to find out the relationships between knowledge's of health workers toward occupational safety and health program and their socio-demographic.

The study findings indicate that there is a significance relation among health worker's knowledge about occupational health and safety program with their level of educational and their age. As well as findings show that there is a highly significance relation between knowledge about occupation health and safety program with the training of course that health workers participated in.

The study concludes that health workers Age, level education, training course, monthly income, and Number of years of Employment Have a great effect on occupational health and safety program.

The study recommends Encourage health care workers to attend continuing education activities in the form of workshops, conferences, training programs, refreshing courses and review update related to "occupational health and safety program" and ministry of Iraqi health could improve the infections protective processes as "head cap, closed shoes, gloves, and frequent medical examination for communicable diseases" as hepatitis.

**Keywords:** *Assessment, health care workers, Occupational Health and Safety Program.*

## Introduction

Occupational safety and health (OSH) is a very important issue that must be taken into consideration in any working environment. For the avoidance of accidents, OSH rules and regulation should be implemented. Occupational health and safety is a specialty covering several specialized areas with a wide scope. In the broadest context, it should seek to: encourage and preserve the greatest level of physical, emotional and social wellbeing of staff in all professions; avoid working environments that could adversely impact employee safety and wellbeing; In recent years, major

changes have taken place in workplace health and safety systems intended to prevent and monitor worries [1].

Occupational health is characterized as a multidisciplinary activity, as per the World Health Organization (WHO), aimed at: • the preservation and protection of workers' health, the prevention and management of occupational hazards and injuries, and the removal of occupational causes and conditions that are hazardous to occupational health and safety. Creation and promotion of safe and stable jobs, workplace conditions and organizations at jobs. Improving the physical, emotional and social well-being of staff and

encouraging the growth and preservation of their ability to work, as well as personal and social development at work. Facilitating employees to live economically and socially prosperous lives and to make a meaningful contribution to their sustainable growth [2].

About 100 million workers in many countries are subject to some form of workplace health threats, such as carcinogenic agents, instances of pulmonary or other physical illness, physical agents, noise, crowding, or stress-related work-related stresses. Chronic respiratory disease, cancer, degenerative disease in a variety of critical organ systems, birth defects, and genetic changes may be associated with exposure to harmful contaminants or physical hazards. It is predicted that these exposures will “result in 100,000 Americans dying from occupationally associated diseases each year, and an additional 400,000 cases of occupationally related diseases”[3].

In addition to, Occupational hazards cause multiple forms of injury or disability. The loss of human resources, which can lead to reduced productive and service capacity and in some serious situations, may result in the death of the workers. Thus, leading to the loss of competent staff. Also, in developing countries, poor professional performance of health care providers may undermine the quality of health care institutions, particularly among nurses. Hospitals have many unique hazards that may possibly affect the health of workers. Risk exposure throughout the hospital unit is highly variable. Exposure to chemicals can occur from disinfectants, sterilizers, cleaning compounds, anesthetic gas, mercury, and hazardous drugs. Biological hazards include viruses that cause hepatitis B, C, HIV, TB (MRSA), methicillin-resistant staphylococcus aureus and latex sensitivity[4].

Psychosocial, physical, biological, chemical and ergonomic variables may be grouped as health-related hazards related to health professionals. 29 physical types, 25 chemical types, 24 biological varieties, ten and 6 types of ergonomic and psycho-social potential hazards have been identified by “the American National Institute for Occupational Safety and Health (NIOSH)”[5].

Ever since people started working, workplace safety and health have been a matter of concern. Occupational disorders affect the entire organ system, including “respiratory diseases, musculoskeletal injuries, traumatic injuries, cardio-vascular diseases caused by work, hearing loss triggered by noise, dermatological problems, and psychiatric diseases”. Exposures to workplaces also

contain airborne toxins, ionizing radiation, ultraviolet and visible light, and the workplace can also be a vector of a wide variety of infectious diseases, including HBV, tuberculosis (TB), influenza and AIDS (hepatitis B virus)[6].

## Methodology

A descriptive cross sectional study is carried out throughout (1/September/2019 to 1/September/2020) in order to assess the Health Workers Toward “Occupational Health and safety program” and to find out the relationships between knowledge’s of health workers toward occupational safety and health program and their socio-demographic. The study population included health workers who are working in Al-Kut City’s primary health centers.

The reliability of the question instrument which is determined by a pilot study and the validity is accomplished by a panel of (12) experts. The total items which are comprised in the question are (25 item). These items are distributed in three parts which comprise Occupational Health hazards experienced by Nurses. This part consists of (general information, about Knowledge items regarding definition, types, common hazards of Occupational Health and Safety) which included (6) items, Occupational health control measures which included (9) items, and Preventive Measures for Occupational Health Hazards. Which included (10) items. The data collected on an individual base, the questionnaire was filled by health workers themselves under the researcher supervision and each self-report takes between (25-30) minutes. The results analysis are investigated through SPSS, which descriptive and inferential statistical data analysis approach that comprises, “frequency, percentage, mean, standard deviation; t- test, Chi-Square, and ANOVA test”.

## Results and Discussion

**Table (1):** The characteristics of participants showed 150 nurses; the majority of them was male. These findings go along with study that conducted by Umar and code (2017) who found that most of participant were male.

Concerning Age, the most age 20 – 30 year was. This finding in the same line with study that carried out by Awan and others (2017) who found that the most sample their age between 26-30 years. Regarding marital status, highest the percentage of married couples were in marital status. These findings consistent with

Hamad and Qassim (2019) study who stated that most of sample were Married [4].

Concerning the educational level, the results are showed that higher percent was of high school nursing. These results incongruent with study that carried out by Hamad and Qassim (2019) who reported that higher percentage of study sample were Bachelor's degree. Regarding the Monthly income of nurses, the results of current study depicts that higher percent of participant was Satisfied . These finding go along with study that conducted by Hamad and Qassim (2019) who stated that monthly income about most of sample was about 601.000-900.000 Iraqi Dinar [ID]) and this consider satisfied [4].

Regarding the Resident area, the finding revealed that majority of them in Rural area. This results not in the same line with study that carried out by Jouda (2006) to explore the extent of the ergonomically hazards among the employees of the Ministry of health in the Gaza Strip, who found that Cities represent the large portion of total sample. While on other hand go along with study that carried out by Nabiland others (2018) who found that majority of total sample belonged to rural these finding consistent with results of study under hand [7,8].

**Table (2):** The table shows preventive measures for occupational health hazards, higher percentage of participant their answer was right, while the mean of scores indicates to (1.597) the mean considers as moderate level.

The table(2) shows the overall occupational health hazards experienced by nurses, most of them their answer was right, while the mean of scores indicates to (1.511) the mean considers as moderate level. The total score mean of the knowledge of health care workers is 51.1%, which is considered as moderate knowledge levels. These results of study under hand at the same line with a study that carried out by Saqer (2014) who found that total mean of score was moderate level. This finding may be due the insufficient given that of adequate "training courses concerning dealing with risks through the work. The lack of continues follow up from the organizations of health and safety" in the health work situation that lead to create a chief problem and expose the health care workers to such dangers [11].

Presents the items occupational and safety program, according to questionnaire; the findings indicate that mean scores are displayed to moderate level among

all items. The finding of present study not in the same line with results of study that carried out by Abiodun and others (2018) he found when assess perception a knowledge of healthcare providers of job hazards in their work situation, also recognize their safety practices and them attitudes towards protecting themselves from hazards, who found that more than half of the respondents have good knowledge of occupational hazards [12].

**Table (3):** Revealed that there is no statistical significant relation among subdomain's of questionnaire study and gender. at  $p = \text{or} \leq 0.05$ , these findings go along with Abiodun and others (2018) who found there non association between gender and knowledge about occupational health hazards [12].

While that there is a significant association with subdomain's of questionnaire study and age at  $p \leq 0.05$ . these findings inconsistent with study that carried out by Ahmed (2019) who found that non-significant association among age with general knowledge on professional health and safety measures in originations health [13].

**Table (4):** Revealed that there is relationship among subdomain's of questionnaire study, Level of education .These findings consistent with study that carried out by Aluko and others (2016) who reported that there was, there is relation between the knowledge level and level of educational. Most of the respondents had at least high nursing school, that explains why the level of knowledge of occupational hazard is high and influenced by educational level. where it concluded that the level of education influences the health and safety issues [14]. Concerning training course, that there is relationship among subdomains of questionnaire study at  $p \leq 0.05$ .

The results were displayed that there is no statistical significance "association" between subdomain's of questionnaire study and marital status. at  $p \leq 0.05$ . These findings congruent with study that conducted by Sabita and others (2018) who reported that no association among marital status with level of knowledge on occupational health hazards at  $p\text{-value} 0.45$  [15].

There is a significant association with subdomain's of questionnaire study and Income monthly at  $p \leq 0.05$  this finding contrast with study that carried out by Alqam (2013) who reported that there are no significance difference at the level ( $p = 0.05$ ) in the means of job hazards knowledge and perception, "Performance" Information, Safety measures, and satisfaction domain, according to monthly income [16].



**Table 1 Distribution general information of sample**

Variables	Group	F.	%
Age	20 – 30 year	88	58.7
	31- 40 year	40	26.7
	41 – 50 year	20	13.3
	51 – 60year	2	1.3
Gender	Male	51	34
	Female	99	66
Marital Status	Married	92	61.3
	Single	55	36.7
	Divorced	3	2.0
	Widowed	0	0.0
	Separated	0	0.0
Educational Level	High school nursing	75	50%
	Nursing Institute	67	45%
	College of Nursing	8	5%
Monthly income	Enough	54	36.
	Satisfied	74	49.3
	Not Satisfied	22	14.7
Resident	Urban	8	5.3
	Rural	142	94.7
Years of employment	0-5 year	83	55.3
	6-10year	40	26.7
	11-15 year	13	8.7
	16-20year	5	3.3
	21and more	9	6
Training course	No	88	58.7
	Yes	62	41.3

**Table 2: Assessment of the occupational and safety program among nurses (N=150)**

Variables	Response	Percentage	Mean	Assessment
Control measures	Error	37.4	1.651	M
	Right	62.6		
Preventive Measures	Error	40.3	1.597	M
	Right	59.7		
Occupational Health hazards	Error	48.9	1.51	M
	Right	51.1		
Overall occupational and safety program assessment	Error	41.1	1.59	M
	Right	59.9		

M: moderate ..... low =1-166, moderate= 167-233, high 234-3

**Table 3. The Association between Subdomain of occupational and safety program and socio-demographic of nurses by chi-square**

Socio-demographic	Subdomain	p. Values
Gender	Occupational Health hazards	0.96
	Control measures	0.19
	Preventive Measures	0.013
Age	Occupational Health hazards	0.246
	Control measures	0.018
	Preventive Measures	0.133

**Table 4. The Association between Subdomain of occupational and safety program and socio-demographic of nurses by chi-square**

Socio- Demographic	Subdomain	p. Values
Level of education	Occupational Health hazards	0.001
	Control measures	0.001
	PreventiveMeasures	0.001
Training course	Occupational Health hazards	0.001
	Control measures	0.001
	PreventiveMeasures	0.001

**Ethical Clearance:** The Research Ethical Committee at scientific research by ethical approval of both environmental and health and higher education and scientific research ministries in Iraq

**Conflict of Interest:** The authors declare that they have no conflict of interest.

**Funding:** Self-funding

### Reference

- Topal S. Occupational injuries and occupational safety and health regulations in three industries in North Cyprus, opportunities for improvement identified (Doctoral dissertation, Eastern Mediterranean University (EMU)-Doğu Akdeniz Üniversitesi (DAÜ)).
- Manuel M, Daphnie L, D’cunha S and Suresh S. A study to assess the awareness regarding occupational health hazards among the employees in the laundry department of a selected hospital. Muller J Med Sci Res, 2015 6(1),pp.40-44.
- Takala J. Global estimates of fatal occupational accidents. Epidemiology. 1999 Sep 1:640-6.
- Hamad ZJ, Qassim WJ. Effectiveness of an Educational Program in Enhancing Nurses’ Knowledge about Occupational Health Hazards. Iraqi National Journal of Nursing Specialties. 2019;32(2):11-8.
- Meydanlıoğlu A. Health and safety of health care workers. JBHS2013;2(3):192–199.
- Al-Qaisi M, Qasim AA. Backache as one of occupational hazards and diseases among 900 dentists in Baghdad city. Journal of baghdad college of dentistry. 2010;22(2):99-103.
- Jouda, A.J.M. Occupational Hazards Among Governmental Healthcare Workers In the Gaza Strip: Ergonomics(published thesis in School of Public Health, Deanship of Graduate Studies Al-Quds University. 2006 .
- Nabil NM, Sorour AS, Ahmed FM. Occupational Health Hazards among Faculty of Nursing Students in Zagazig University. Zagazig Nursing Journal. 2018 Jan 1;14(1):133-47.
- Awan A, Afzal M, Majeed I, Waqas A, Gilani SA. Assessment of knowledge, attitude and practices regarding occupational hazards among Nurses at Nawaz Sharif Social Security Hospital

- Lahore Pakistan. Saudi Journal of Medical and Pharmaceutical Sciences. 2017;3(6):622-30.
10. El-Bahnasawy MM, Mohammad AE, Ragab IF, Morsy TA. A Training Program for Nursing Staff on Health Hazards of Chemical Insecticides Exposure in a Practical Field. Journal of the Egyptian Society of Parasitology. 2015 Aug 1;45(2):291-308.
  11. Saqer AM. Assessment of Health and Safety Risk among Health Care Providers in European Gaza Hospital. Assessment of Health and Safety Risk among Health Care Providers in European Gaza Hospital. 2014.
  12. Abiodun OP, Aturaka SO, Oladapo O, Nwofe J, Abiola A, Olushola O, Teniola O. Assessment of the Knowledge, Attitudes and Perception of Potential Occupational Hazards by Automobile Workers in Makurdi, Benue State, Nigeria. American Journal of Health Research. 2018 Mar 15;6(2):37-43.
  13. Ahmed SA. Assessment of Occupational Health and Safety Measures' Knowledge and Experienced Types of Hazards among Nursing Staff in Rania Hospital. Erbil Journal of Nursing and Midwifery. 2019 Nov 30;2(2):85-92.
  14. Aluko OO, Adebayo AE, Adebisi TF, Ewegbemi MK, Abidoye AT, Popoola BF. Knowledge, attitudes and perceptions of occupational hazards and safety practices in Nigerian healthcare workers. BMC research notes. 2016 Dec;9(1):71.
  15. Sabita K, Mandira S, Bharati S, Sulata K. Knowledge and Preventive Practice of Occupational Health Hazards among Nurses in different Teaching Hospitals.
  16. Alqam TI. Occupational hazards among laboratory workers in Palestinian governmental hospitals in the West Bank.

# A Comparative Study of Arch Width, Overjet and Overbite between Bilateral Congenital Missing Lateral Incisor and Normal Class I Occlusion

Zena Hekmat Altaee<sup>1</sup>, Laith Hamood Aswad AL-Salmany<sup>2</sup>, Maha Mishaal Turki<sup>3</sup>

<sup>1</sup>Ass. Prof., <sup>2</sup>Assist. Lect., Department of Orthodontics, College of Dentistry, University of Anbar, Iraq,

<sup>3</sup>Assist., Department of Prosthodontics, College of Dentistry, University of Anbar, Iraq

## Abstract

Permanent lateral incisors have been considered as major missing teeth in the mouth. The main aim of the present study is to conduct a comparative study of maxillary and mandibular arch widths, overjet and overbite for a sample with missing lateral incisors and normal class I occlusion.

The sample of the study comprises sixty pairs of study models of both genders, which were separated into two groups. The first group consisted of thirty casts of bilateral congenital missing lateral incisors, while the second group consisted of thirty casts of the class I occlusion. The intercanine width, interpremolar width, intermolar width, overjet and overbite were measured for the sixty samples.

The results of this study demonstrate a significant reduction in maxillary and mandibular arch width in bilateral missing lateral Incisors as compared with normal class I group. The results also revealed a significant reduction in overjet and overbite in bilateral missing lateral incisors as compared with normal class I group. A significant difference was also reported between the two groups based on gender difference in the maxillary arch width. Conversely, non-significant difference was found in the mandibular arch width. The present study also shows non-significant difference based on gender difference in overjet and overbite in the two groups.

**Keywords:** *Congenital missing teeth, lateral incisors, Arch width, class I.*

## Introduction

The missing lateral incisors has been considered as major congenital dental anomaly<sup>(1,2,3)</sup>. Missing teeth results in disturbances in developing occlusions, masticator verbal dysfunctions, and it affects aesthetics as well. Thus, a considerable number of associated consultants is required to cure such cases<sup>(4)</sup>. However, missing teeth etiology remains indefinite and requires more research. Nevertheless, it seems that a congenital missing tooth is thought to be strongly controlled by genes, and is associated with various syndromes<sup>(4)</sup>. It is commonly believed that upper lateral side incisors (excluding the third molar) are the most reported cases of missing teeth with incidence 5%<sup>(5-6)</sup>.

Furthermore, the orthodontic treatments of patients experiencing bi-or unilateral congenitally missing lateral incisors has been considered as one of the challenges

affecting the treatment plan. The two main alternates, the orthodontic close the space or open the space regarding the prosthetic replacements, might be comprising functions, periodontal health, as well as aesthetics<sup>(7)</sup>.

Arch width discrepancy is an important diagnostic aid, which can expect the treatment outcomes of an orthodontic cases<sup>(8)</sup>. It is important for orthodontist to have information of the normal growth, dentition development, arch dimensions, and any variations from the normal<sup>(9)</sup>.

The present study focuses on the study of maxillary and mandibular arch width, overjet and overbite of patients with bilateral missing lateral incisors and normal class I occlusion in both genders to identify differences in these two types of groups.

## Materials and Method

In the present study, sixty patients were chosen either from a private orthodontic clinic, or from Orthodontic Department, Faculty of Dentistry, University of Anbar. Patients must be between (15-35) years of age, and their age mean was  $26.3 \pm 0.3$  years.

Care was taken to exclude the patients who have previous orthodontic treatment history, cleft lip and palate, serial extraction as well as history regarding the extraction of permanent teeth.

All the radiographs have been estimated on the dental viewer through one author to the patient. Furthermore, a tooth has been considered as congenitally missing lateral incisors in case no trace on radiograph is found. Treatment records were also checked to verify if the missing tooth was extracted or not. Impressions were taken by Alginate impression material and were poured by orthodontic plaster. All information about the patients ex. name, age, gender and radiograph were collected and attached to the records made for all patients.

Then the study sample was divided into two groups. The first group consisted of thirty pairs of patients with bilateral congenitally missing lateral incisors equally divided between the genders (fifteen males and fifteen females), and the second group consisted of thirty pairs of patients with class I occlusion based on a class I skeletal relationship without any abnormality to be the control group of this study. These were also divided equally between the genders (fifteen females and fifteen males).

**Measuring Technique:** Measurements were made on the upper and lower study model by a single examiner using electronic digital caliper with sharpened tips which records up to 0.01 mm. The dental arch width was recorded by measuring intercanine width, interpremolar width, intermolar width, overjet and overbite.

The reference points for the measurements were marked by using the sharp-pointed pencil to create the exact landmark points. The reference points that were used as landmarks are presented as follows and as shown in (figure 1):

1. Intercanine width: The distance between the cusp tips of the maxillary right permanent canines and left permanent canines.
2. Interpremolar width: The distance between the first premolar of the left side to the right side at the distal end of its occlusal groove.
3. Intermolar width: The distance between the maxillary first permanent molars of the left side to the same of the right side at the central fossae on the occlusal surface.
4. Over jet: The extent of horizontal overlap of the maxillary central incisor over the mandibular central incisor.
5. Over bite: The extent of vertical overlap of the maxillary central incisors over the mandibular central incisors.

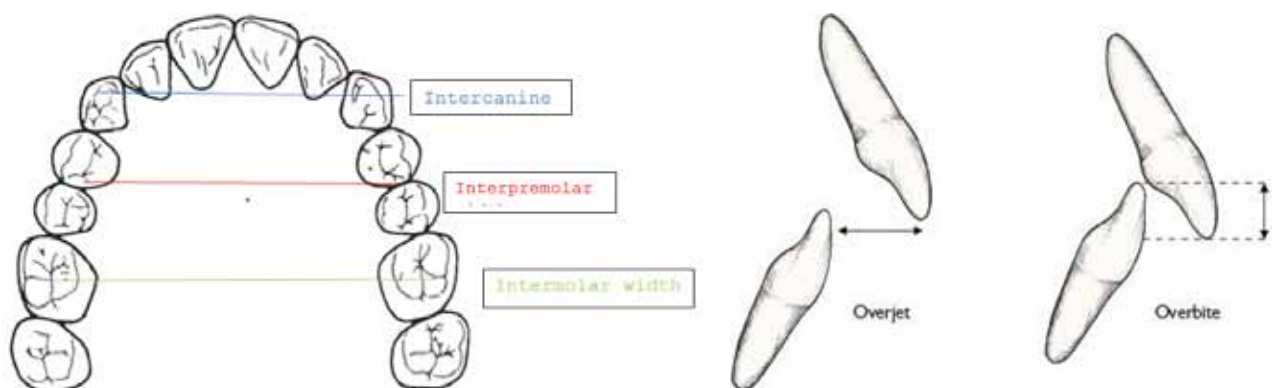


Figure 1: The landmarks used in this study

**Statistical Analysis:** The data were collected then statistically analyzed using SPSS software version 25 to calculate means and standard deviations of quantitatively

collected data. The difference between the two means was identified using (t) test. The significance among means was calculated at  $P < 0.05$  critical level.

**Reliability Test:** The distance of twenty pairs of study models were measured randomly. After three weeks, the measurements were repeat to determine the reliability of the measurement by using intraclass correlation coefficient test, which showed excellent reliability (> 0.90).

**Results**

The chronological age range of the sample was (15-35) years. Table (1) displayed the results including the comparison of arch widths between bilateral congenital missing lateral incisors (BCMLI) with Class I normal occlusion in maxillary arch. The results indicated a significant difference between maxillary arch widths in both groups (p<0.05).

The comparison of arch widths between bilateral congenital missing lateral incisors (BCMLA) with Class I normal occlusion in mandibular arch is shown in the Table (2).

There was a significant difference in mandibular arch widths in both groups (p<0.05); however, intermolar distance shows non-significant difference (p > 0.05).

As shown in Table (3), there is highly significant reduction in overjet and overbite (≤ 0.001) in the bilateral congenital missing lateral incisors (BCMLA) when compare with normal class I occlusion.

Based on the results tabulated in (4), there was a significant variance between male and female in two groups (p < 0.05) in terms of the intercanine width, interpremolar width and intermolar width in the maxillary arch.

Conversely, non-significant difference p>0.05 in terms of intercanine width, interpremolar width and intermolar width in mandibular arch was revealed.

Table (4) demonstrates non-significant differences (p>0.05) according to gender in overjet and the overbite in the two groups.

**Table (1) Illustrates the results of comparing arch widths between bilateral congenital missing lateral incisors (CMLA) and Class I normal occlusion in maxillary arch**

Variable		BCMLA	Class I	P. value
Intercanine Width	Mean	26.32	30.11	0.001**
	S.D.	0.8	1.32	
Interpremolar Width	Mean	33.7	36.5	0.045*
	S.D.	1.6	1.32	
Intermolar Width	Mean	42.47	47.81	0.037*
	S.D.	1.8	1.26	

\*Significant at P < 0.05., \*\*Highly significant at P ≤ 0.001

**Table (2) Shows the comparison of arch widths between bilateral congenital missing lateral incisors (CMLA) with Class I normal occlusion in mandibular arch.**

Variable		BCMLA	Class I	P. value
Intercanine Width	Mean	23.14	27.89	0.035*
	S.D.	1.32	0.71	
Interpremolar Width	Mean	31.6	32.4	0.028*
	S.D.	0.78	0.91	
Intermolar Width	Mean	40.87	43.2	0.069
	S.D.	1.24	0.79	

\*Significant at P < 0.05.

**Table (3) Shows the comparison of overjet and overbite between bilateral congenital missing lateral incisors (BCMLA) with Class I normal occlusion.**

Variable		BCMLA	Class I	P. value
Overjet	Mean	1.98	3.1	0.001*
	S.D.	0.81	0.68	
Overbite	Mean	0.89	2.11	0.001*
	S.D.	0.56	0.81	

\*Highly Significant at ≤ 0.001.

**Table (4) Reports gender effect results on bilateral congenital missing lateral incisors (BCMLA) with Class I normal occlusion.**

Variable	BCMLA		P. value	Class I		P. value
	Female Mean SD	Male Mean SD		Female Mean SD	Male Mean SD	
Max. Intercanine	28.54	30.12	0.034*	31.76	32.8	0.025*
Width	1.98	0.67		1.92	2.12	

Max. Interpremolar	34.14	36.7	0.00**	35.8	38.1	0.01*
Width	1.87	1.67		1.97	2.65	
Max. Intermolar	41.1	43.1	0.04*	44.5	48.12	0.001**
Width	0.87	1.54		1.78	2.34	
Man.Intercanine	22.46	24.34	0.082	26.5	28.45	0.091
Width	0.32	0.76		1.32	0.65	
Man.Interpremolar	30.8	31.78	0.067	32.1	32.98	0.075
Width	0.87	0.43		0.67	1.34	
Man.Intermolar	40.1	41.12	0.092	43.23	44.1	0.086
Width	1.29	1.98		0.89	1.51	
Overjet	1.67	2.1	0.072	3.65	3.53	0.065
Width	0.67	0.32		0.75	1.02	
Overbite	1.94	0.86	0.065	3.12	2.96	0.078
Width	0.78	1.25		1.34	1.82	

\*Significant at  $P < 0.05$ ., \*\*Highly significant at  $P \leq 0.001$ .

## Discussion

The congenital missing teeth occur due to disturbance during the initial stage of tooth formation and proliferation. Missing one tooth or more is considered one of the most common developmental anomalies. Moreover, the most common missing type is the bilateral missing lateral incisors<sup>(10)</sup>.

A significant reduction in the arch width between bilateral congenital missing lateral incisors and normal class I occlusion in the maxillary arch was revealed in this study. This could be due to the decrease in the number of the teeth, which in turn causes a reduction in the width of the maxillary arch<sup>(11,12,13)</sup>.

In the mandibular arch, there was a significant reduction in the intercanine and interpremolar width, but non-significant reduction in the intermolar width was reported the cause of that the missing of the lateral incisors leads to make the canine erupted more mesially than the normal occlusion. This in turn leads to more deficiency of the width of intercanine and interpremolar width<sup>(14)</sup>.

There was a significant reduction in overjet and overbite in bilateral congenital missing lateral incisors compared to normal class I occlusion. This result agrees with that obtained in <sup>(15,16)</sup>, who found that the missing of lateral incisors leads to retroclination of the upper and lower incisor, and thus results in an increase in

interincisal angle and more uprighting incisors appearing in the missing lateral incisors patients.

The maxillary arch was significantly greater in males than females in the two groups. This finding is also in agreement with<sup>(14,15,17,18,19)</sup>. This could be due to smaller and smoother bony ridge, the alveolar process of female, or due to weakness of musculature in female<sup>(20)</sup>. This result is not in line with the results obtained by<sup>(21,22)</sup>, who found non-significant differences between males and females. This inconsistency could be due to using different landmarks, different sample size, age group, ethnic group and procedures.

The majority of the dental arch widths in mandibular arch revealed non-significant difference between males and females. This agrees with<sup>(23,24)</sup>, but disagrees with<sup>(18,19,20)</sup>. The difference might be due to racial factor or the difference in the analyzing technique employed.

This study shows non-significant differences based on gender difference in overjet and overbite in the two groups. This result agrees with<sup>(24,25,26)</sup>; yet, it disagrees with<sup>(27,28)</sup>.

The present study is important to the orthodontist to decide the most appropriate treatment plane to adopt in treating patients with bilateral congenital missing lateral incisors by open or closed the space with maintaining good esthetic to the patient by providing a correct arch width, overjet and overbite.<sup>(29)</sup>

## Conclusions

The results indicated a significant reduction in arch width in maxillary and mandibular arch in bilateral missing lateral Incisors when compared with normal class I occlusion group.

There was a significant reduction in overjet and overbite in bilateral missing lateral Incisors as compared with normal class I group.

There was a significant variation between males and females in the two groups in the maxillary arch width. However, non-significant differences were reported in the mandibular arch width.

This study showed non-significant differences based on the gender difference in the overjet and overbite in the two groups.

**Ethical Clearance:** The Research Ethical Committee at scientific research by ethical approval of both environmental and health and higher education and scientific research ministries in Iraq

**Conflict of Interest:** The authors declare that they have no conflict of interest.

**Funding:** Self-funding

## Reference

1. Chu CS, Cheung SL, Smales RJ. Management of congenitally missing maxillary lateral incisors. *General Dentistry*. 1998 May 1;46(3):268-74.
2. Ramazanzadeh BA, Ahrari F, Hajian S. Evaluation of tooth size in patients with congenitally-missing teeth. *Journal of dental research, dental clinics, dental prospects*. 2013;7(1):36.
3. Willhite C, Bellerino M, Eubank J. Treatment of congenitally missing lateral incisors with resin-bonded fixed partial dentures. *Quintessence Dent Technol*. 2002;25:63-72.
4. Neville BW, Damm DD, Allen CM and Bouquot JE. *Oral & Maxillofacial Pathology*. 3<sup>rd</sup> ed., Philadelphia: WB Saunder. P. 2009;70-79.
5. Muller TP, Hill IN, Petersen AC, Blayney JR. A survey of congenitally missing permanent teeth. *The Journal of the American Dental Association*. 1970 Jul 1;81(1):101-7.
6. Graber T.: *Orthodontics. Current principle and techniques*. 2nd ed. 1994 Mosby St, louis Mosby.
7. Robertsson S, Mohlin B. The congenitally missing upper lateral incisor. A retrospective study of orthodontic space closure versus restorative treatment. *The European Journal of Orthodontics*. 2000 Dec 1;22(6):697-710.
8. Patel D, Mehta F, Patel N, Mehta N, Trivedi I, Mehta A. Evaluation of arch width among class I normal occlusion, class II division 1, class II division 2, and class III malocclusion in indian population. *Contemporary clinical dentistry*. 2015 Sep;6(Suppl 1):S202.
9. Mahmood AD. A Comparative study of tooth size and dental arch dimensions between Iraqi Arabs and Kurds with class I normal occlusion. *Al-Rafidain Dental Journal*. 2012 Nov 1;12(1):71-9.
10. Proffit WR, Fields HW, Sarver DM. *Contemporary orthodontics*.(5th edn.) St. Louis: Mosby. 2007.
11. Lavelle CL, Moore WJ. The incidence of agenesis and polygenesis in the primate dentition. *American Journal of Physical Anthropology*. 1973 May;38(3):671-9.
12. Herzog C, Konstantonis D, Konstantoni N, Eliades T. Arch-width changes in extraction vs nonextraction treatments in matched Class I borderline malocclusions. *American Journal of Orthodontics and Dentofacial Orthopedics*. 2017 Apr 1;151(4):735-43.
13. Guroo K, Mushtaq M. Comparison of arch width changes in maxilla using two different types of closing loops *International Journal of Applied Dental Sciences* 2020; 6(3): 77-80.
14. Omar H, Alhajrasi M, Felemban N, Hassan A. Dental arch dimensions, form and tooth size ratio among a Saudi sample. *Saudi Medical Journal*. 2018 Jan;39(1):86.
15. Øgaard B, Krogstad O. Craniofacial structure and soft tissue profile in patients with severe hypodontia. *American Journal of Orthodontics and Dentofacial Orthopedics*. 1995 Nov 1;108(5):472-7.
16. Sarnäs KV, Rune B. The facial profile in advanced hypodontia: a mixed longitudinal study of 141 children. *The European Journal of Orthodontics*. 1983 May 1;5(2):133-43.
17. Hashim HA, Al-Ghamdi S. Tooth width and arch dimensions in normal and malocclusion samples: an odontometric study. *J Contemp Dent Pract*. 2005 May 15;6(2):36-51.
18. Prasad M, Kannampallil ST, Talapaneni AK,



- George SA, Shetty SK. Evaluation of arch width variations among different skeletal patterns in South Indian population. *Journal of natural science, biology, and medicine*. 2013 Jan;4(1):94.
19. Golwalkar SA, Msitry KM. An evaluation of dental crowding in relation to the mesiodistal crown widths and arch dimensions. *Journal of Indian Orthodontic Society*. 2008 Jun; 42(2):22-9.
  20. Genecov JS, Sinclair PM, Dechow PC. Development of the nose and soft tissue profile. *The Angle Orthodontist*. 1990 Sep;60(3):191-8.
  21. Raberin M, Laumon B, Martin JL, Brunner F. Dimensions and form of dental arches in subjects with normal occlusions. *American journal of orthodontics and dentofacial orthopedics*. 1993 Jul 1;104(1):67-72.
  22. Lavelle CL, Foster TD. A cross-sectional study into age changes of the human dental arch. *Archives of oral biology*. 1969 Jan 1;14(1):71-86.
  23. Mahmood AD. A Comparative study of tooth size and dental arch dimensions between Iraqi Arabs and Kurds with class I normal occlusion. *Al-Rafidain Dental Journal*. 2012 Nov 1;12(1):71-9.
  24. Alhuwaizi AF, Al-Mulla AA, A-Alousi, WS. The Overbite of Iraqi Teenagers (A National survey) *Iraqi.Orthod J* 2005; 1: 1.
  25. Cons NC, Mruthyunjaya YC, Pollard ST. Distribution of occlusal traits in a sample of 1337 children aged 15--18 residing in upstate New York. *International dental journal*. 1978 Jun;28(2):154-64.
  26. Ciuffolo F, Manzoli L, D'Attilio M, Tecco S, Muratore F, Festa F, Romano F. Prevalence and distribution by gender of occlusal characteristics in a sample of Italian secondary school students: a cross-sectional study. *The European Journal of Orthodontics*. 2005 Dec 1;27(6):601-6.
  27. Agha N, Al-Dawoody A. A Comparative Study of Curve of Spee and Arch Circumference Between Class I Normal Occlusion and Class II Division 1 Malocclusion. *Al-Rafidain Dental Journal*. 2010 Sep 1;10(2):341-7.
  28. Cocconi R, Rapa S. Unilateral agenesis of the maxillary lateral incisor: space closure versus space preservation in growing patients. *In Seminars in Orthodontics* 2020 Feb 21. WB Saunders.

# Application of Fractional Co2 Laser Modification of PEEK in Dental Implants, *In vivo* Study

Nahida Zahir Kamil<sup>1</sup>, Basima Mohammed Ali Hussein<sup>2</sup>

<sup>1</sup>M.Sc. Student, <sup>2</sup>Assist. Prof., University of Baghdad, Institute of Laser for Postgraduate Study

## Abstract

This study aimed to Modify the PEEK surface using Fractional CO<sub>2</sub> laser in different range of parameters to change the surface topography regarding roughness and wettability to enhance osseointegration. A PEEK block (Ceramill PEEK 98X20 N -JUVORA dental innovations, UK) was used to prepare substrate. By CAD-CAM system, PEEK was cut into discs (2 mm thickness and 10 mm diameter). the discs were smoothed by silicon carbide paper of 500 grit and a rotation motion, polishing machine at 200 rpm for one minute used to polish the discs, finally cleaned with ethanol alcohol using ultrasonic cleaner. Different parameters were tested to study their effects on PEEK surface; therefore, several trails were done using Fractional CO<sub>2</sub> laser device. Surfaces of the irradiated PEEK discs were examined microscopically at different magnification power. Then SEM was used. Then, PEEK samples were scanned by (EDS). Range of powers were used (2, 4, 6, 8, 10, 12) W The distance between spots was 0.2mm and 0.2 ms pulse duration to ensure maximum coverage of laser effect. The energy range was (4 - 25) which was n't enough to produce any effect. To test the effect of pulse duration different values were also studied starting from 0.2ms then increase the pulse duration. 0.4,0.6,0.8 ms to increase the energy per pulse accordingly. Starting from short pulse duration up to 0.6ms there was no effect even when the power increased. At 0.8 ms pulse duration, the effect was recognized on the specimen surface. The collected data of previous trials direct the operator to reduce pulse duration to have best criteria, including surface roughness, wettability, without carbonization or cracks.

**Conclusions:** Successful modification of PEEK surface can be done with fractional CO<sub>2</sub> laser. Laser parameters as power, pulse duration, distance between spots and number of scans are key factors induced different range of effect considering material's properties.

**Keywords:** PEEK, Laser, SE, implants, Co<sub>2</sub>.

## Introduction

Dental implants serve as artificial roots for the fixation of dental prostheses. By restoring the masticatory function through dental implants, the quality of life and nutritional status of the affected patients can be markedly improved. Osseointegrated dental implant was described as structural and functional connection between living bone and the implant's surface, under light microscope<sup>(1)</sup>. In spite of well evidence-based implants made from titanium and titanium alloy,, it was observed that their usage can be associated with a variety of disadvantages, such as its light transmission lack, titanium can affect esthetic results. In cases of high smile line this can cause a darkness in neck of the periimplant soft tissue with thin gingival biotype or/and recession of gingivae surrounding a titanium implant . Also,

hypersensitivity to titanium and other problem could occur because of the gradient difference in the titanium implant's elastic moduli and the bone surrounding it<sup>(2)</sup>. As a substitution to titanium, implants made from ceramics were suggested Dental implants made from zirconia, were biocompatible, tooth like-color, and low plaque affinity, which appeared to be a better convenient substitution to titanium . But, because of higher elastic modulus of zirconia than the bone, might result in higher peaks stress in comparison to titanium. Other biocompatible material closer in modulus of elasticity of bone, is polyetheretherketone (PEEK). PEEK is a thermoplastic polymer with a high-performance capable of replacing components of metallic implant in the field of orthopedics. With such findings encouraged the suggestions for PEEK to be substitution for titanium as

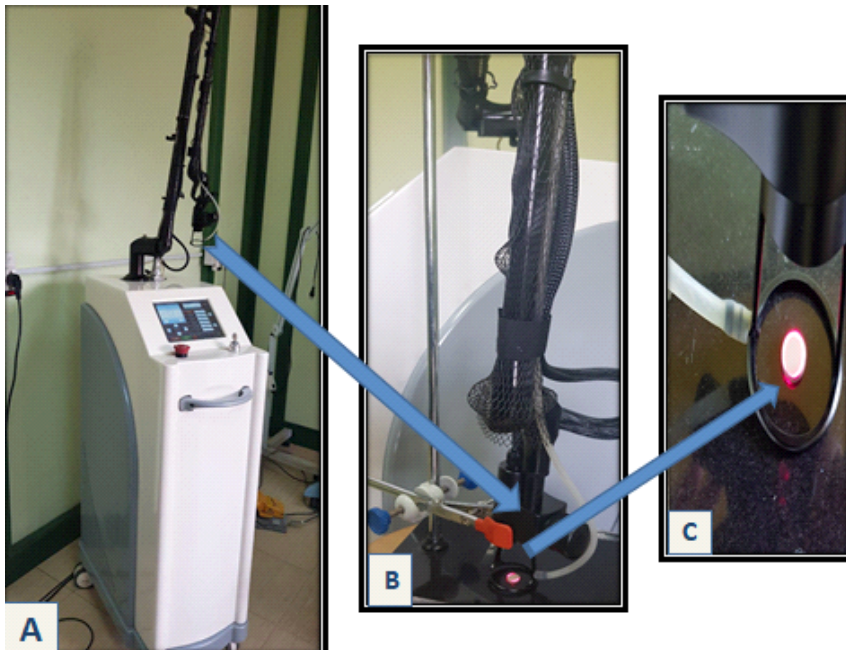
dental endosseous implants' material<sup>(3)</sup>. However the radiolucency and the good wear resistance of PEEK are advantageous for many orthopedic applications also it can be imaged by X-ray, CT scan, or MRI without any distortion in comparison to the conventional titanium (Ti). In spite of these superior properties, PEEK is still classified as bioinert because of its much decreased reaction with the surrounding tissue, which restricts its potential applications. For overcoming this problem, many methods have been suggested which can broadly be divided into two main categories: incorporation of bioactive materials and surface treatment techniques such as laser surface modification<sup>(1)</sup>. Laser treatments are used because of the resolution is high, speed of operating is high, and the bulk properties of implant will not be changed by the laser. That's why, lasers were introduced to improve implant. The CO<sub>2</sub> laser of wavelength 10600 nm with an advanced technique referred to as a fractional CO<sub>2</sub> laser, it delivers the energy in parallel vertical columns of multiple microscopic thermal spots called microscopic treatment zones (MTZs), while the distance between spots remains intact and untreated<sup>(4)</sup>.

**Aims of the Study:** Modification of PEEK surface using Fractional CO<sub>2</sub> laser in different range of parameters to change the surface topography regarding roughness and wettability to enhance osseointegration.

## Materials and Method

**Sample Preparation:** PEEK block (Ceramill PEEK 98X20 N -JUVORA dental innovations, UK) was used to prepare substrate. By CAD- CAM system, PEEK was cut into discs (2 mm thickness and 10 mm diameter). To have a uniform smooth surface for standardization, the discs were smoothed by silicon carbide paper of 500 grit and a rotation motion, polishing machine at 200 rpm for one minute used to polish the discs, finally cleaned with ethanol alcohol using ultrasonic cleaner.

**Laser Irradiation:** Laser irradiation was done at Institute of Laser for post graduate studies/University of Baghdad considering all safety requirements. Different parameters were tested to study their effects on PEEK surface; therefore several trials were done using Fractional CO<sub>2</sub> laser device Figure (1).



**Figure (1): (A) fractional CO<sub>2</sub> device. (B) Articulating arm of laser device (C) PEEK disc ready for laser irradiation**

During irradiation, the arm of the laser device was fixed using laboratory clamp and PEEK specimen was set on a stage at fixed distance between the beam source and the specimen surface in----cm.

**Light Microscope:** Surfaces of the irradiated PEEK discs were examined microscopically at (4,10, 20 and 40X) magnification powers using light microscope (BX51/OLYMPUS).

**Scanning electron microscope (SEM):** Laser irradiated samples were scanned by SEM (Oxford instruments, UK) to see the difference on the surface topography.

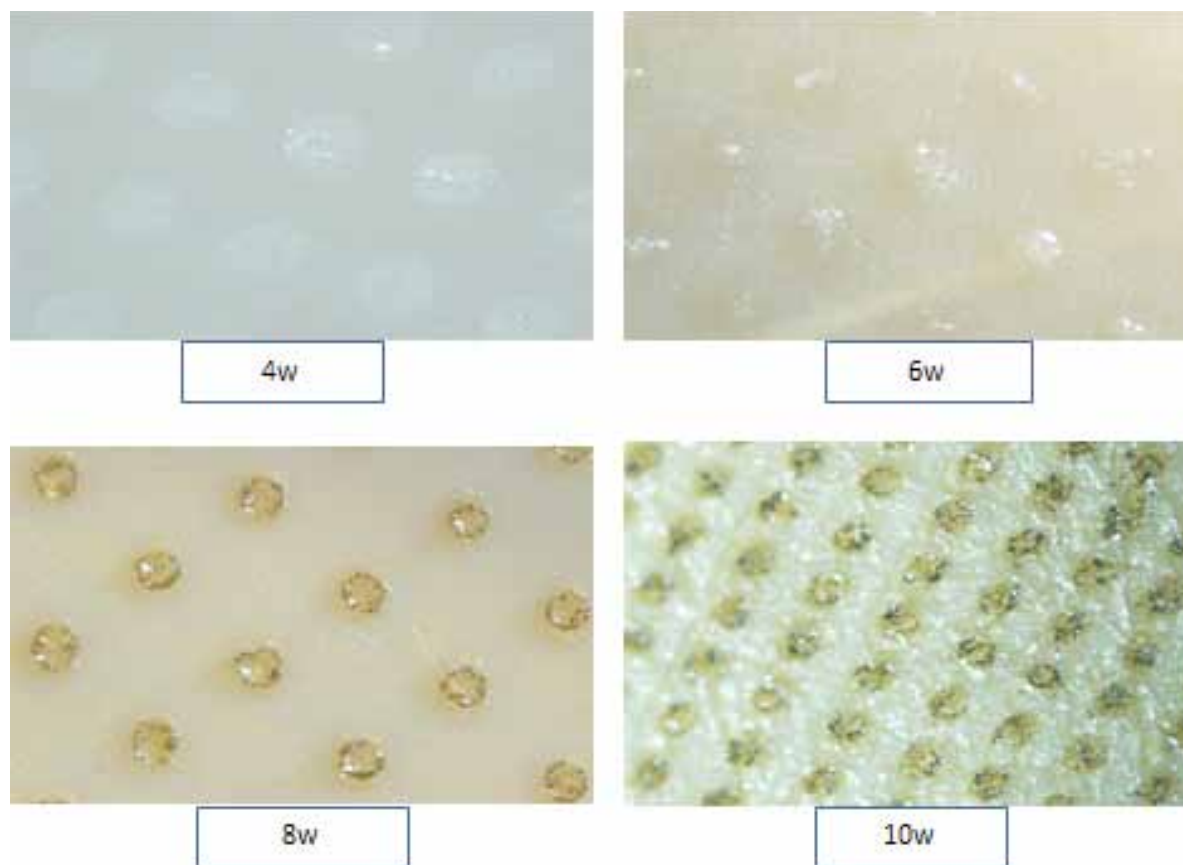
**Atomic force microscope (AFM):** Surface roughness was assessed by atomic force microscope (AFM) for the irradiated and non-irradiated samples.

**Energy-dispersive X-ray spectroscopy (EDS):** PEEK samples were scanned by (EDS) (Oxford instruments, UK) for surface analysis and to calculate the percentage of elements formed on the surface of the irradiated and non-irradiated samples.

**Contact Angle:** Wettability test was conducted using contact angle measuring device (Creating Nano Technologies Inc., Taiwan). The specimen was placed on adjustable table and micropipette dropper was used to dispense a drop of normal saline in 6.89 micro liter volume. The distance between the dropper tip and specimen surface was 4 mm.

## Results

1. Range of powers were used (2, 4, 6, 8, 10, 12) W. The distance between spots was 0.2mm and 0.2 ms pulse duration to ensure maximum coverage of laser effect. The energy range was (4 - 25) which was n't enough to produce any effect.
2. To test the effect of pulse duration different values were also studied starting from 0.2ms then increase the pulse duration. 0.4,0.6,0.8 ms to increase the energy per pulse accordingly. Starting from short pulse duration up to 0.6ms there was no effect even when the power increased. At 0.8 ms pulse duration, the effect was recognized on the specimen surface.
3. Considering the result from previous trials an attempts were carried out regarding distance between spots,duration and scans. Then decision was made to increase the distance (0.2, 0.4, 0.6mm,...) to reduce heat accumulation, And as shown in figure (2) different powers were tested with 0.4mm distance and 1ms duration which produce deferent effects with sign of carbonization in most trails.



**Figure (2): Light microscope image of PEEK specimen treated with 0.4mm distance, 1ms duration and 1 scan. (10 X).**

4. The collected data of previous trials direct the operator to reduce pulse duration to have best criteria, including surface roughness, wettability, without carbonization or cracks. The effect for specimens irradiated under 6W power shows interaction without carbonization, this also confirmed with SEM. Increased power (W) does not improve the result, in fact carbonization was clearly appeared with SEM.

### Discussion

Numerous method have been used to modify the surface wettability, such as Fractional CO2 laser treatment because laser treatment can be used to target specific areas with higher precision, restriction manual movement of the hand piece during operation and the pattern which can be achieved is homogenous<sup>(5)</sup>.

Wettability results agreed with<sup>(6)</sup> who concluded that the contact angle analysis showed a reduction in water contact angle with increasing laser power intensity, and the derived surface free energy increased accordingly . Different method of surface modification enhance wettability this is agree with<sup>(7)</sup>.

For surface physical properties of dental implant materials, the surface with a certain degree of roughness is essential for the formation of bone implant interface<sup>(8,9)</sup>. In many ways, laser has been considered a new tool to process material surfaces because of its high efficiency and accuracy.

First of all, the rough surface is beneficial for the adsorption of organism protein and mineral. Second, the adhesion, migration, proliferation, differentiation, protein synthesis, and mineralization of osteoblasts on the materials surface were also promoted because of the increase in surface roughness<sup>(10,11)</sup>. In addition, the increase in surface roughness can expand the contact area between implant materials and bone and make the formation of locking effect at the bone implant interface. Finally, the bonding strength of the bone implant interface can be improved by forming rough surfaces<sup>(12,13)</sup>.

Conclusions:- Successful modification of PEEK surface can be done with fractional CO2 laser. Laser parameters as power, pulse duration, distance between spots and number of scans are key factors induced different range of effect considering material's properties.

**Ethical Clearance:** The Research Ethical Committee at scientific research by ethical approval of both environmental and health and higher education and scientific research ministries in Iraq.

**Conflict of Interest:** The authors declare that they have no conflict of interest.

**Funding:** Self-funding

### References

1. Turkyilmaz I, Company AM, McGlumphy EA. Should edentulous patients be constrained to removable complete dentures? The use of dental implants to improve the quality of life for edentulous patients. *Gerodontology*. 2010 Mar;27(1):3-10.
2. Simek Vega Goncalves TM, Heitor Campos C, Matheus Rodrigues Garcia RC. Effects of implant-based prostheses on mastication, nutritional intake, and oral health-related quality of life in partially edentulous patients: a paired clinical trial. *International Journal of Oral & Maxillofacial Implants*. 2015 Mar 1;30(2).
3. Atsumi M, Park SH, Wang HL. Method used to assess implant stability: current status. *International Journal of Oral & Maxillofacial Implants*. 2007 Sep 1;22(5).
4. Brånemark PI, Breine U, Adell R, Hansson BO, Lindström J, Ohlsson Å. Intra-osseous anchorage of dental prostheses: I. Experimental studies. *Scandinavian journal of plastic and reconstructive surgery*. 1969 Jan 1;3(2):81-100.
5. Shapira L, Klinger A, Tadir A, Wilensky A, Halabi A. Effect of a niobium-containing titanium alloy on osteoblast behavior in culture. *Clinical Oral Implants Research*. 2009 Jun;20(6):578-82.
6. Velasco-Ortega E, Jos A, Cameán AM, Pato-Mourelo J, Segura-Egea JJ. In vitro evaluation of cytotoxicity and genotoxicity of a commercial titanium alloy for dental implantology. *Mutation Research/Genetic Toxicology and Environmental Mutagenesis*. 2010 Sep 30;702(1):17-23.
7. Andreiotelli M, Wenz HJ, Kohal RJ. Are ceramic implants a viable alternative to titanium implants? A systematic literature review. *Clinical oral implants research*. 2009 Sep;20:32-47.
8. Egusa H, Ko N, Shimazu T, Yatani H. Suspected association of an allergic reaction with titanium

- dental implants: a clinical report. *The Journal of prosthetic dentistry*. 2008 Nov 1;100(5):344-7.
9. Muller K, Valentine-Thon E. Hypersensitivity to titanium: clinical and laboratory evidence. *Neuroendocrinology Letters*. 2006 Dec 1;27(1):31-5.
  10. Sicilia A, Cuesta S, Coma G, Arregui I, Guisasola C, Ruiz E, Maestro A. Titanium allergy in dental implant patients: a clinical study on 1500 consecutive patients. *Clinical oral implants research*. 2008 Aug;19(8):823-35.
  11. Thomas P, Bandl WD, Maier S, Summer B, Przybilla B. Hypersensitivity to titanium osteosynthesis with impaired fracture healing, eczema, and T-cell hyperresponsiveness in vitro: case report and review of the literature. *Contact dermatitis*. 2006 Oct;55(4):199-202.
  12. Moon SM, Ingalhalikar A, Highsmith JM, Vaccaro AR. Biomechanical rigidity of an all-polyetheretherketone anterior thoracolumbar spinal reconstruction construct: an in vitro corpectomy model. *The Spine Journal*. 2009 Apr 1;9(4):330-5.
  13. Yildirim M, Fischer H, Marx R, Edelhoff D. In vivo fracture resistance of implant-supported all-ceramic restorations. *The Journal of prosthetic dentistry*. 2003 Oct 1;90(4):325-31.

# Study of Verbal Bullying in Early Adolescents (Case Study of Pallangga 5 Junior High School and Sungguminasa 3 Junior High School)

Muh. Asrul Taufiq Arifuddin<sup>1</sup>, Suriah<sup>2</sup>, Sudirman Nasir<sup>2</sup>,  
Muhammad Syafar<sup>2</sup>, Lalu Muhammad Saleh<sup>2</sup>, Nurhaedar Jafar<sup>2</sup>

<sup>1</sup>Master Degree of Public Health Student, Faculty of Public Health, Hasanuddin University,

<sup>2</sup>Lecturers of Faculty of Public Health, Hasanuddin University

## Abstract

Bullying can take many forms, one of which is verbal bullying in the form of reproach, slander, cruel criticism, personal or racial insults. This study aims to examine the incidence of verbal bullying that occurs in early adolescents at Pallangga 5 Junior High School and Sungguminasa 3 Junior High School, Gowa Regency. This research uses a qualitative case study approach. Data was obtained through Focus Group Discussion (FGD), in-depth interviews with 59 informants and document review. Content analysis is used to identify topics or categories in the data. The results showed that the forms of verbal bullying varied, ranging from harassing, threatening, using verbal abuse by making fun of parents and the name of the victim. Therefore, schools should intensify the activities of the ambassador team so that verbal bullying can be minimized and teachers need to add insight into verbal bullying.

**Keywords:** Study, Verbal Bullying, Early Adolescence.

## Introduction

Research on bullying began more than 40 years ago<sup>1</sup>. Bullying is aggressive behavior that is unwanted by other adolescents who are not siblings that involves a recurring imbalance of perceived power that causes physical, psychological, social or educational<sup>2,3</sup>, both between the victim and the perpetrator. Bullying is characterized by physical, social, or verbal abuse affecting large numbers of school children worldwide<sup>4</sup>. Bullying at school is an act of repeated aggression and is deliberately directed at students who have little position or power<sup>5</sup>. Therefore, learning in schools must be conducive, safe, and comfortable and away from actions that endanger students. The central government, local governments, and other state institutions are obliged

to guarantee a sense of security for themselves and the souls of students in their growth and development<sup>6</sup>.

The bullying that is rife in schools can be done by teachers to students, students to other students and a group of students to other students. UNICEF reports that in 2015 violence against children occurred widely in Indonesia, 50% of children were bullied at school. Meanwhile, WHO data for September 2016, 12% of children in the world experienced sexual violence in the past year, even 37% of WHO member countries implemented interventions to prevent incidents of sexual violence on a larger scale. Meanwhile, the Indonesian Child Protection Commission (KPAI) released the results of monitoring cases of violations of children's rights in the education sector during 2019 which showed that acts of bullying or bullying of children against teachers increased drastically. From January to April 2019, bullying was dominated by bullying in the form of physical violence, psychological violence, and sexual violence. In addition, KPAI recorded 12 cases of psychological violence and bullying and 4 cases of children bullying their teachers. The majority of cases

---

### Corresponding Author:

**Muh. Asrul Taufiq Arifuddin**

Master Degree of Public Health Student, Faculty of Public Health, Hasanuddin University,  
e-mail: muhasrultaufiq097@gmail.com

occurred at the primary school level, reaching 25 cases or 67% of the total cases.<sup>8</sup>

Bullying can take many forms, including physical, verbal and mental. Bullying [9] ranges from verbal assaults (eg name calls, threats), physical behavior (eg hitting, kicking, damaging the victim's property), and social aggression (eg social exclusion, spreading rumors) to the latest forms of attack via the Internet and new technology (cyber bullying). This bullying behavior often occurs in school environments such as toilets, canteens and parks. In the context of this research, the researcher discusses verbal bullying. This type of bullying is very easy to find and occurs everywhere, such as acts of cursing, ridiculing, gossiping, making fun of and dwarfing, whether in the context of being intentional or not, joking or serious. This type of bullying can occur both in the family environment, in association, and even worse in the educational environment.

Observations on February 6, 2020 show that researchers obtained information from two State Junior High Schools in Gowa Regency who often engage in verbal bullying. From 2017 to 2019, in the case study at Pallangga 5 Junior High School there was verbal bullying of 4-5 people per class for at least one week. The trigger is a trivial thing, for example a student's pen is picked up by a classmate who is so angry that they keep laughing at each other's names. Meanwhile, at Sungguminasa 3 Junior High School, there are about 30 victims of bullying every year. Ironically, the perpetrators and victims come from people who are weak, easy to control and don't want to fight back. On January 27, 2020, an interview with a psychologist and consultant at the Integrated Service for Women's Empowerment and Child Protection, South Sulawesi Province obtained information on whether the training materials were designed with UNICEF support.

As a result, to form student facilitators, use the u-report platform to evaluate the school situation in cyberspace based on social media to conduct anonymous polls. In this way, at Pallangga 5 Junior High School and Sungguminasa 3 Junior High School, 74% of students were found to be bullied, an average of 4 to 5 times a week. Types of bullying include being hit, blackmailed, teased, chatting, and being bullied online. The learning facilitator works with students to change negative behavior into positive behavior, helping students develop their own exercise based on problems at school. Activities that can be carried out include making posters,

editing work plans for tackling bullying in schools, and modeling positive behavior.

The form of verbal bullying that occurs is adjusted to the conditions of the language and the habits of the local community, for example calling the names of their parents in a mocking tone to saying obscene words and hinting at their friends, for example sundala children (illegitimate children), ka'bulamma, asu '(dogs). The words are considered normal and come spontaneously from the mouth of the bully. Verbal bullying includes humor and ridicule, name calling, shouting, verbal rejection, negative predictions, negative comparisons, humiliation, cursing and swearing, and threats to children. Verbal bullying uses endless cursing and ridicule the victim, usually judged by his physical inadequacy, as well as denouncing his stupidity and hobbies, ethnicity, religion, and overall physique.<sup>11</sup>

Although verbal bullying does not cause physical harm, it does have a negative impact on the victim's psychological side and poor social adjustment. Psychologically, for example, excessive anxiety, constant fear, depression, suicidal thoughts and symptoms of post traumatic stress disorder. Meanwhile, the victim also had difficulties in adapting to the social environment, for example wanting to move to another school or leaving that school, having disrupted academic performance or often deliberately not attending school. Another characteristic of victims of verbal bullying is a relatively low level of self-confidence which is caused by continuous insults, threats and inappropriate words to the victim or the perpetrator does not want to acknowledge the victim's physical and non-physical strengths, causing fear, loss of self-confidence and the ability to act. In addition, embedding with ugly titles, fat, dwarf the victim by gossiping or vilifying. Another impact is that children's development is socially and emotionally stunted where children can grow up with low self-esteem and low self-concept.

When they grow up, they are more likely to continue to be victims of verbal bullying, or to turn into verbal bullies. They also have a higher tendency to behave aggressively and to engage in delinquency and self-destructive behavior, such as drug use, alcohol abuse to attempted suicide. Victims of verbal bullying can also grow up to become personal with various kinds of psychological disorders, such as anxiety disorders, depression and emotional instability.



It often happens that students who are victims of bullying tend to be shunned and isolated so that victims of bullying tend to carry out negative coping strategies such as truancy, violating school regulations, and being individual, and falling into promiscuity as a form of escape to problems that the victim of bullying cannot yet solve. In addition, the public's misperception of bullying which is considered normal will unconsciously cause negative views on children who are victims, including being gloomy, lazy to study, skipping school more often, and being ignored and ostracized by the surrounding environment.

This is of course a serious concern from various parties, but on the other hand, teachers or parents tend to understand or add negative labels or attributes to the victims of bullying. Therefore, the school has made efforts and actions so that verbal bullying does not happen again in the form of advice and lectures both on Friday worship, during flag ceremonies, every lesson hour is empty and every time learning starts even makes posters containing verbal bullying stops.

Based on the empirical facts above, the problem of verbal bullying is interesting to study in the context of research. Remembering verbal bullying will have a negative impact on early adolescence. Early adolescents according to Erickson<sup>12</sup> are adolescents whose age criteria are 13-15 years old in girls and 15-17 years old in boys. According to WHO<sup>13</sup>, the age limit for adolescents is 12 to 24 years.<sup>14</sup> Adolescents in these early days are still amazed at the changes that take place in their own bodies and the impulses that accompany them. They develop new thoughts, are quickly attracted to the opposite sex, and are easily sexually aroused. Excessive sensitivity coupled with reduced control (self-control) over the ego makes early adolescence difficult for adults to understand. This is in line with the theory of Low Self-Control<sup>15</sup> which assumes that one of the causes of criminal behavior is low self-control and even associates the phenomenon of bullying with social criminal behavior and considers it a serious problem in relation to student safety in schools and threats to academic achievement. In addition, students who are raised in a family environment and authoritarian parents can also cause children to behave deviantly.

Based on the description above, education today can run well without any form of violence, so that a peaceful atmosphere is created and learning can take place well. Therefore, the authors would like to carry

out a study entitled "Study of Verbal Bullying in Early Adolescents (Case Studies at SMP Negeri 1 Pallangga and SMP Negeri 3 Sungguminasa)." This study aims to examine the incidence of verbal bullying that occurs in early adolescents in SMP Negeri 5 Pallangga and SMP Negeri 3 Sungguminasa, Gowa Regency.

## Materials and Method

This research design uses a case study approach to understand the problem of verbal bullying in depth and identify cases of verbal bullying that are rich in information. The research was conducted at Pallangga 5 Junior High School and Sungguminasa 3 Junior High School, Gowa Regency, South Sulawesi Province. Research informants were selected by purposive sampling based on predetermined criteria with complete elaboration in order to obtain maximum results. The data collection technique used secondary data from the Integrated Service for Women Empowerment and Child Protection, South Sulawesi Province, while the primary data was obtained from observations, Focus Group Discussions (FGD), in-depth interviews, and document review. Data analysis uses content analysis or content analysis which is interpreted and presented in the form of a narrative, matrix and schema.

## Results and Discussion

The researcher will descriptively describe the form of verbal bullying by quoting the results of in-depth interviews and FGDs from a number of informants who have been determined. Various opinions of informants regarding the forms of verbal bullying that occurred at Pallangga 5 Junior High School and Sungguminasa 3 Junior High School, Gowa Regency. Forms of verbal bullying that have occurred in both schools are ridicule, seniority behavior between seniors and juniors, thuggery, and bullying that students often face. Something that is more serious is done by students who are bullies in the form of threats to their friends when they are not given, which results in humiliation of the physical form of the body.

*Forms of verbal bullying can be ridicule, physical actions taken by students. Say, there are seniors and juniors where seniors are salt, big and so on. It can put pressure on the juniors. Actions like this are often done by others when interacting. Also thuggery because of the presence of seniors and juniors in it, there can be bullying that students often face. Both students from within the school and alumni who have finished and still*

*have interaction with the school. Say they are already in high school but they still want to create old habits by blocking them outside the school environment such as doing bullying and so on.*

**(JA, 58 Years, 25 June 2020, 09.00 AM)**

*Triggered by trivial things such as being dwarfed/ mocked by calling the victim as his parent, being insulted because of his dwarf physical form, and so on. The forms of cases of verbal bullying that have occurred are mocking his friend, insulting his friend's physical form, threatening if the perpetrator asks for pocket money from his friend and is not given him.*

**(FM, 50 Years, 17 June 2020, 10.00 AM)**

It was revealed that the form of verbal bullying that was carried out by students was in the form of taunts, physical actions that were part of the seniority system that still prevailed at school and continued to build communication with students who were inside the school by creating old habits from school time by blocking them outside the school environment such as bullying, and so on so that it leads to threats and humiliation of the physical form of their friends that students often face. In the FGD, the student perpetrator said that he often made fun of and changed his friend's name to the name of his parents, gave bad words and even insulted, ordered him to and fro and hid his friends' belongings. The counseling teacher and homeroom teacher revealed that mocking and insulting the physical form of friends, calling parents' names, bullying and threatening friends when their wishes were not fulfilled, which was often done by the perpetrator, was revealed in the results of the interview below:

*Forms of verbal bullying that have occurred include mocking his friend, insulting his friend's physical form, threatening if the perpetrator asks for pocket money from his friend when he is not given him.*

**(HA, 41 Years, 26 June 2020, 10.00 AM)**

*For example, at school, students call their friends not their names but the names of their parents. For example, his name Aswan is called Dg. Beta because his parents are named Dg. Beta or physically he was ordered to go shopping. So, children are forced to do not because of desire but because of fear. Or something is being interrogated by a friend.*

**(TA, 44 Years, 17 June 2020, 13.00 PM)**

*Harass or threaten his friend to submit with harsh verbal such as "puppy or" sundala "(illegitimate*

*child)". (MI, 36 years old, 27 June 2020, 10.30 AM)*

*Yes, that was mocking his friend with words about his physical condition like if he is black, he is called black, if he is "frizzy" maybe he is called "frizzy", maybe so. (HL, 57 Years, 18 June 2020, 10.00 AM)*

*There are those who say, there are those who behave or act that makes other people uncomfortable with the behavior they do.*

**(SP, 50 years old, 18 June 2020, 12.00 PM)**

The interview excerpt above, shows that the form of verbal bullying that occurs at school is mocking, insulting the physical form of the body, threatening friends if they are not given what they want, harassing or threatening friends to submit by using harsh words such as puppies or harasses haram), calling parents' names, nicknames that are made fun of, mentioning inappropriate words. Meanwhile, students who were victims of verbal bullying said that their parents' names were made fun of and called the victims not their names. In the FGD, the perpetrator student admitted that he often made fun of his friend by calling him not a friend, not his real name, calling the names of parents to the names of animals. Thus, it can be concluded that the form of verbal bullying that occurs refers to the act of expressing certain words or verbal words from the offender to offend his friend as a victim of verbal bullying.

This was also conveyed by the parents of the perpetrator students in the FGD who admitted that their children often made fun of, mocked, ridiculed, alienated their friends, and used verbal abuse between their children and victims. For parents of victim students based on the results of in-depth interviews with researchers about the form of verbal bullying experienced by their children, they are described separately and briefly as follows:

*The forms of verbal bullying that children have experienced are being said by their friends instead of their names and making fun of their peers.*

**(HS, 33 Years, 20 July 2020, 14.00 PM)**

*Forms of verbal bullying that have been experienced by children are the behavior of mocking children at school and outside of school.*

**(KE, 38 Years, 29 July 2020, 14.00 PM)**

According to the parents of the victim, the form of verbal bullying that has been experienced by the child is the behavior of being ridiculed by friends at school and

outside of school until the child gets ridicule treatment and even the child is called not his real name. In the FGD, the parents of the victims of the students expressed the same thing if their children often got ridiculed by calling them not their names, sometimes with the names of their parents which resulted in ridicule.

Based on the results of the interviews and the results of the FGD, it was found that the forms of verbal bullying that were carried out by the students varied, from making fun of, threatening and insulting the physical form of friends to the form of bullying that was often faced by victim students when the perpetrator's wishes were not fulfilled. This is due to the existence of peers who are one of the factors that influence verbal bullying at school. Peers are one of the biggest factors in someone engaging in verbal bullying. When a child has entered adolescence, he is no longer dependent on family, but tries to find support from his peers [16]. About 20-25% of teenagers are directly involved in bullying as perpetrators, victims, or both. Large-scale studies conducted in Western countries show 4-9% of adolescents frequently engage in bullying and 9-25% of school-age children in bullying.

The cause of verbal bullying in the form of direct contact is because it often annoys others by deliberately making fun of parents' nicknames and talking dirty to others. This finding is in line with the results of the study that direct verbal contact is part of the talk of violence directly to someone. For example spreading gossip, criticizing or teasing, cursing, giving nicknames, and so on<sup>17</sup>. Forms of verbal bullying behavior shown by the perpetrator to the victim can be in the form of mocking, insulting, and offensive remarks<sup>18</sup>. Storey has the view that verbal bullying includes mocking, yelling, making fun of and insulting<sup>19</sup>. Verbal bullying is a form of bullying behavior that can be captured through auditory envy. Forms of verbal bullying include: calling, yelling, scolding, insulting, humiliating in public, accusing, shouting, spreading gossip, and slandering.

Bullying behavior in schools is a pattern of negative behavior that is repeated and aims negatively. This behavior leads directly from one child to another because of an imbalance in power that aims to bully the weaker child. Bullying behavior in schools with the form of direct verbal contact, namely behavior that is in the form of talking directly to someone, forms of behavior that often occur such as talking dirty and mocking by carrying the name of the parents<sup>20-28</sup>.

## Conclusions and Suggestions

The results of the study concluded that the forms of verbal bullying that occurred varied, ranging from harassing, threatening friends, using harsh words, calling parents' names and nicknames which were made fun of. Therefore, schools should intensify the activities of the ambassador team so that verbal bullying can be minimized and teachers need to add insight into verbal bullying.

**Ethical Clearance:** Obtained from Faculty of Public Health Ethical committee.

**Source of Funding:** Self

**Conflict of Interest:** None

## References

1. Menesini, E. & Salmivalli, C., bullying in schools: the state of knowledge and effective interventions. *Psychology, Health & Medicine*, 22:sup1, 240-253. <https://doi.org/10.1080/13548506.2017.1279740>. [Diakses 15 Maret 2020], 2017.
2. Carretero, C. M. dan Cervello, E., 2019. Teaching styles in physical education: a new approach to predicting resilience and bullying. *International Journal of Environmental Research and Public Health*. 2019; Spain: Department of Sport Sciences, Sport Research Center, Miguel Hernández University.
3. Mucheraha, W, Fincha, H, Whitea, T, & Thomas, K., The relationship of school climate, teacher defending and friendson students' perceptions of bullying in high school. *Journal of Adolescence*. Elsevier Ltd: Department of Educational Psychology, Ball State University, Muncie, 2018. IN 47306, USA.
4. Cho, S. & Lee, J. M. Explaining physical, verbal, and social bullying among bullies, victims of bullying, and bully-victims: Assessing the integrated approach between social control and lifestyles-routine activities theories [Online]. *Children and Youth Services Review*; 2018.; doi:10.1016/j.chilyouth. 2018.06.018. [Diakses 24 Februari 2020].
5. Skubic, D. Verbal abuse in kindergarten and primary school. *Ars & Humanitas*, 2018; 12(1), 104-123. <https://doi.org/10.4312/ars.12.1.104-123>

6. Info Datin. Kekerasanterhadapanakdanremaja. Jakarta: Pusat Data danInformasi Kementerian Kesehatan Republik Indonesia. 2018.
7. Maradewa, R., Catatan KPAI di Hardiknas: kasusanakbully guru meningkatdrastis. [online]. <https://www.kpai.go.id/berita/catatan-kpai-di-hardiknas-kasus-anak-bully-guru-meningkatdrastis>. [Diakses 15 Maret 2020].2019.
8. Maradewa, R., Catatan KPAI di Hardiknas: kasusanakbully guru meningkatdrastis. [online]. <https://www.kpai.go.id/berita/catatan-kpai-di-hardiknas-kasus-anak-bully-guru-meningkatdrastis>. [Diakses 15 Maret 2020].2019.
9. Monks, F.J., Knoers, A.M. P. & Haditono, S.R. Psikologi Perkembangan Pengantardalamberbagaibagiannya. Yogyakarta: Gadjah Mada University Press. 2006.
10. Marks, D. F. The health psychology reader. London: Sage. 2002
11. Suciartini, N. N. A. dan Sumartini, N. P. U., Verbal bullyingdalam media sosial. Jurnal Pendidikan Bahasa Indonesia. PBSI 2018.; Vol.6 No.2, Juli-Desember 2018. Sekolah Tinggi Manajemendan Ilmu Komputer (STMIK) STIKOM Bali.
12. Thalib, S.B. Psikologipendidikanberbasisanalisisempirisaplikatif. Jakarta: Kencana Media Group..2010.
13. Widyastuti, Y., et., al. Kesehatanreproduksi. Yogyakarta: Fitrimaya. 2009
14. Sarwono, S. Psikologiremaja. Jakarta: PT. Raja Grafindo. 2011.
15. Moon, B., Hwang, H.W., & McLuskey, J. D. Causes of school bullying: Empirical test of a general theory of crime, differential association theory, and general strain theory. *Crime & Delinquency*, 2008.; 57(6), 849-877. Diunduhdari<http://journals.sagepub.com/doi/pdf/10.1177/0011128708315740>.
16. Goodwin, D., Strategies to deal with bullying. North Richmond, NSW: Kidsreach Inc. 2009.
17. Wiyani, N. A., Save our children from school bullying. Yogyakarta: Ar-Ruzz Media.2013.
18. Dewi, Putu Yulia Angga. Perilaku school bullying padasiswasekolahdasar. *Edukas I: Jurnal Pendidikan Dasar* ISSN 2721-3935., 2020.; Vol. 1, No. 1, Maret 2020, pp. 39-48. Sekolah Tinggi Agama Hindu Negeri MPU KuturanSingaraja, Indonesia.
19. Hertinjung, W.S. Bentuk-bentukperilaku bullying di sekolahdasar menggunakanskalabentukbullying. *Jurnal Prosiding Seminar Nasional Parenting* Vol 2013.; (3): 450-458
20. Putri, H., Nauli, F., Novayelinda, R. Faktor-faktor yang berhubungandenganperilaku bullying padaremaja. *JOM* ., 2015.; Vol 2 No 2. Program Studi Ilmu Keperawatan Universitas Riau.
21. Masni, Saifuddin Sirajuddin, Syaharuddin and AminuddinSyam., Influence of a red palm oil emulsion on the level of retinol in the plasma of primary school childre., *Pakistan Journal of Nutrition* | vol: 15., issue: 5. 2016-01-01
22. RosmalaNur and Anwar Mallongi, Impact of Violence on Health Reproduction Among Wives in Donggala. *Pakistan Journal of Nutrition*, 2016.; 15: 980-988. DOI:10.3923/pjn.2016.980.988
23. Muhammad Awal, Ridwan Amiruddin, Sukri Palutturi and Anwar Mallongi, Relationships Between Lifestyle Models with Stroke Occurrence in South Sulawesi, Indonesia. *Asian Journal of Epidemiology*, 2017;10: 83-88
24. Mallongi, A., Daud, A., Ishak, H., La Ane, R., Birawida, A.B., Ibrahim, E., Selomo, M., Rahman, S.A. Clean water treatment technology with an up-flow slow sand filtration system from a well water source in the tallo district of Makassar. *Journal of Environmental Science and Technology*, 2017; Volume 10, Issue 1, Pages 44-48
25. Masriadi, Azis, R., Sumantri, E., Mallongi, A., Effectiveness of non pharmacologic therapy through surveillance approach to blood pressure degradation in primary hypertension patients, Indonesia., *Indian Journal of Public Health Research and Development*. Volume 9, Issue 4, April 2018, Pages 249-255
26. Palutturi, S., Rutherford, S., Davey, P., Chu, C., Professional challenges to strengthen partnerships in the implementation of healthy cities in Indonesia: A case study of Makassar, *Research Journal of Medical Sciences*., Volume 8, Issue 4, 17 August 2014, Pages 126-132.
27. Mallongi, A., Stang, Syamsuar, Natsir, M.F., Astuti, R.D.P., Rauf, A.U., Rachmat, M., Muhith, A., Potential ecological risks of mercury contamination along communities area in tonasa cement industry Pangkep, Indonesia. *Enfermeriaclinica*, Volume 30, 1 June 2020, Pages 119-122

28. Muhith A, Winarti E, Perdana SSI, Haryuni S, Rahayu KIN, Mallongi A. Internal Locus of Control as a Driving Factor of Early Detaction Behavior of Servical Cancer by Inspection Visual of Acetic Acid Method. Open Access Maced J Med Sci. 2020Apr 20; 8(E):113-116. <https://doi.org/10.3889/oamjms.2020.43>

# The Effect of Massage Therapy Method, Therapy Duration and Injuries on the Reduction of Pain in Knee Injuries

Arif Setiawan<sup>1</sup>, Soegiyanto<sup>2</sup>, Tri Rustiadi<sup>2</sup>, Rumini<sup>2</sup>

<sup>1</sup>Doctoral Student, Post Graduate Dept., Universitas Negeri Semarang, Indonesia,

<sup>2</sup>Lecture, Post Graduate Dept., Universitas Negeri Semarang, Indonesia

## Abstract

The aim of the study was to explain the effect of effriction and frirage massage therapy, with a therapy duration of 10 minutes and 15 minutes in helping to reduce movement pain around the injured joint, the injured joint was the ACL ligament which was injured for 1 month and 2 months but pain in the surrounding muscles. ACL at the time of massage therapy was still felt by injured patients. This study was an experiment by providing 2 types of therapy, namely effriction and frirage therapy. Each therapy is a combination of two massage method to get maximum results in reducing pain during flexion and extension of the thigh muscles. With a factorial design with a sample size of 64 people with the criteria to be the sample, namely purposive sampling with injury for 1 month and 2 months. Physical assessment test instruments for pain with an analog visual scale are used to map changes and decreases in pain before treatment and after therapy and changes in range of motion in the knee to support the healing process assisted by these therapeutic method during the effriction massage therapy intervention. Subjective reporting on the level and function of pain is also documented. The results of the study for the homogeneity test mean that the data are homogeneous, and there is a significant difference between the 1 month and 2 month injuries. It was obtained that for massage therapy with an effriction treatment, the duration of the injury was 1 month with a duration of 10 minutes of therapy, which experienced a significant reduction in pain by 0.047 and for effriction therapy with a duration of 15 minutes, it had a significance of 0.049 so that for effriction therapy the duration of the injury was 1 month and for frirage therapy the duration of the injury was 1 month. months with 15 minutes of therapy in this group alone experienced a significant reduction. So that for 1 month there was no interaction between the independent variables and the dependent variable for the duration of 2 months there was an interaction because many factors influenced the reduction of pain and must be described in other studies. Effriction massage therapy is determined as a complementary therapy that is effective in helping to reduce pain relief in knee injuries, especially for 1 month injuries with a duration of 10 minutes and 15 minutes and frirage can significantly reduce pain in the injury duration of 1 month with a therapy duration of 15 minutes, and the type for this therapy there was a non-significant reduction in injury duration of 2 months.

**Keywords:** *Massage Therapy, Therapy Duration, Injuries, Reduction of Pain.*

## Introduction

Sports activities and strenuous physical exercise with high intensity and tiring can cause problems for athletes and sportsmen. One of the problems that occurs

is sports injuries, which result in not being able to train and do activities anymore<sup>1</sup>. Sports injuries are all kinds of injuries that arise, either during training or during a match or afterwards. An injury is a damage to the structure or function of the body due to force or physical pressure from outside or from within which causes pain resulting from an accident or sport. Based on the time the injury occurs, it can be classified into two, namely traumatic injury and overuse injuries. Traumatic injury is a serious injury that just happened suddenly such as dislocation, fracture, sprain, strain and can break the tendon. Whereas

---

### Corresponding Author:

**Arif Setiawan**

Doctoral Student, Post Graduate Dept., Universitas Negeri Semarang, Indonesia

e-mail: aguspurwanto.prof@gmail.com

overuse injuries are caused due to repetitive movements that are too fast and a lot of movement, this overuse injury is often experienced by athletes, starting from the existence of a slightly excessive force repeatedly for a long time<sup>2</sup>. Indicators of injury are marked by the body with signs of inflammation such as: 1) heat (increased body temperature), 2) dolor (pain), 3) rubor (red skin), 4) tumor (swelling), and 5) function leissa (can no longer be used due to tissue damage to muscles, tendons, ligaments, joints, and bones due to excessive movement activity or accidents).<sup>3</sup>

Various kinds of efforts are made to deal with injuries, for example, medical actions that involve medical SOPs, supported by drugs, in addition to medical actions there are also non-medical actions that use various therapeutic method taking into account the level of injury suffered by sports injury sufferers. The therapeutic method used in this study is massage therapy method. Massage is derived from the Arabic word “mash” which means “to press gently” or the Greek word “massien” which means “to massage” or “to knead”. Furthermore, massage is also known as massage science or lulut science. In providing massage treatment that aims to help the injury recovery process depends on the accuracy of handling the injury experienced. The factors that determine the accuracy of treatment are the type or method of therapy, the duration of treatment and the duration of the injury<sup>3</sup>. Massage not only knows the types, techniques and physiological benefits of massage that can be used to increase flexibility and performance but also massage is used for the process of muscle recovery and injury rehabilitation for sports injury sufferers. Therefore, it is necessary to strive for proper and fast handling so that sports injury sufferers can recover optimally so that sports injury sufferers can take part in every exercise or competition<sup>4</sup>.

There are only a few techniques used to provide massage treatment to injuries. In general the techniques used are efflurage, friction, petrissage, tapotement, vibration techniques with a treatment duration of more than 15 minutes to reduce post-exercise pain<sup>5</sup>. Whereas for injury recovery, the technique used is a combination of existing techniques, namely the Swedish massage technique on the grounds that when providing treatment at least 2 combined techniques, effriction and frirage techniques are selected with a duration of 10 minutes and 15 minutes on the grounds that they can provide time efficiency in treatment. and directly to the part directly related to the injury suffered.

The use of the effriction therapy method was chosen because this technique is a combination of efflurage and friction in the implementation of the treatment, there is massaging with the palm of the hand, there is a speed and massage pressure in the area of the quadriceps muscle and the surface hamstring muscles being treated. While the frirage therapy method is a combination of frikcion and efflurage, but the dominant treatment is pressing with the thumb and there is no excessive pressure or speed in massaging the surface of the treated area. The frirage therapy method is a combination of massage techniques or manipulations of friction and effleurage techniques which are carried out simultaneously in doing massage<sup>4</sup>. The hope of massage therapy which is carried out with the duration of treatment time so that sports injury sufferers do not return to the same injury in the near future<sup>6</sup>. owever, there are other factors that influence, namely the duration of the injury and the type of injury.

The duration of the injury and the duration of the injury affect the recovery process, because injuries that do not heal quickly are caused by mishandling due to unprofessional handling or therapy in the case of injuries. The intended professionals are those who understand the development of the massage world and are competent in handling injuries, so that the duration of the injury must be known so that the treatment is not wrong. With the acute period passed and not yet treated by the therapist based on field data that the researcher did for one year in the research clinic, the injury usually lasted about 1 month. Whereas in the range of 2 months and above, the injury has usually been treated but has not changed and even there has been mishandling. Another factor that follows is the type of injury, Injuries are the most frequent namely injury to the knee joint. Injury to the knee joint involves damage to the anterior cruciate ligament (ACL)<sup>6</sup>. The number of athletes who are injured is 150,000 each year from male and female athletes in basketball and football. It is related to the injury to athletes who go to the Multispecialty Sports Clinic from 19 sports. There were 12,681 sports injury sufferers who suffered leg and ankle injuries. Due to the athlete’s injury, the opportunity to participate in the championship is lost by 20% - 35%. Based on field data that the researchers conducted from January to December 2018 at the Sports Injury Massage Research Clinic, the total number of injuries was 1,506 from various injury variations. In one year there were 481 sports injury sufferers who suffered knee injuries, if the percentage of knee injuries in one year was 31, 93%.

The knee has the largest percentage of injuries, reaching 22.5% because it has multiple functions, namely as a driving and weight bearing, so that the possibility of injury is even greater. Therefore, it can be concluded that the most common injuries suffered by sports injury sufferers are knee injuries<sup>7</sup>. If someone has a knee injury, they will experience great pain. According to the International Association for the Study of Pain (IASP) pain is an unpleasant sensory and emotional experience due to damage or threat of damage to tissues Pain is the most common patient complaint and anxiety due to pain will serve as a warning to clinicians. Pain is a perceptual and sensual phenomenon and it is important for the body to be protected from injury so that humans can survive. Pain is very disturbing and troublesome for more people than any disease<sup>8</sup>.

The high prevalence of pain proves that pain is still neglected. Management of lax pain has adverse consequences. This can cause pain in the muscles and interfere with movement activities, because the pain that is focused on in this discussion is pain due to sports injuries. Pain can also cause various psychosocial effects including depression, anxiety, delirium, post-traumatic stress disorder, and disorientation. Sports injury sufferers will feel pain need adequate therapy to relieve pain, because the pain not handled properly can aggravate the physical and mental condition of the sports injury sufferer. Any pain that arises will make the body respond to the painful stimuli, which in turn will affect the activity and organ systems of the sufferer. One of the ways to treat pain is massage therapy. Pain in the knee that often occurs includes injury to the anterior cruciate ligament (ACL) which is the most common knee injury in sports (Arovah, 2010)<sup>8</sup>. Knee ligament injuries can cause sudden pain, swelling of the knee, a crackling sound from the injured knee, loose knee joints, and pain every time you lift weights. The recovery period depends on the severity of the injury and the treatment given. The characteristics of knee injuries are athletes feeling pain in the injured area, edema of the muscles or ligaments around the joints and decreased joint movement activity Research data carried out for one year in 2018 can be concluded that the subjects of this study were sports injury sufferers who had chronic knee injuries with injury duration of 1 month and 2 months who were given a combination of effriction and frirage massage therapy with a duration of time. 10 minutes and 15 minutes. As an indicator of using pain reduction in knee injuries<sup>9</sup>.

Based on the formulation of the problem that has

been described above, the researcher will analyze several objectives as follows:

1. The effect of massage therapy method effriction duration of 10 minutes with injury duration of 1 month on pain reduction?
2. The effect of massage effriction therapy method with duration of 15 minutes with 1 month on pain reduction?Effect of massage therapy method effriction duration of 10 minutes with injury of 2 months on pain reduction?
3. The effect of massage therapy method effriction duration of 15 minutes with injury for 2 months on pain reduction?
4. The effect of frirage massage therapy method of duration of 10 minutes of injury to 1 month on pain reduction?
5. The effect of frirage massage therapy method with duration of 15 minutes of injury to 1 month on pain reduction?
6. The effect of the frirage massage therapy method, the duration of 10 minutes, the injury to 2 months, on the reduction of pain?
7. The effect of frirage massage therapy method with duration of 15 minutes injury 2 months on pain reduction?
8. How does the interaction between the 10 minutes effriction massage therapy method and the Frirage massage therapy for 10 injuries 1 month reduce pain?
9. How does the interaction of 15 minutes effriction massage therapy method with frirage massage therapy 15 for 1 month injury to reduce pain?
10. How does the interaction between the 10 minutes effriction massage therapy method and the Frirage massage therapy 10 minutes injury 2 months to reduce pain?
11. How does the interaction of 15 minutes effriction massage therapy method with frirage massage therapy 15 for 2 months injury to decrease pain?

## **Method**

This study consists of three variables, namely the independent variable, the attribute variable and the dependent variable. There are 2 manipulated independent variables, namely: 1) effriction massage therapy



method, 2) frirage massage therapy, attribute variables are therapy duration and injury duration consisting of: 1) duration of therapy with 10 minutes and 15 minutes 2) duration of injury 1 month and 2 months. While the dependent variable is a decrease in pain. The relationship between independent and dependent variables in quasi-experimental research like this is called experimental design with factorials, namely the research structure that investigates three kinds of independent variables, whether each of these variables affects the dependent variable. Effriction massage therapy method and frirage massage therapy method, therapy duration of 10 and 15 minutes, and duration of injury 1 and 2 months. Meanwhile, the dependent variable is a decrease in pain. This study used a quasi-experimental method with a factorial design. Therefore, the design in this study is a factorial experimental design in block design because the experimental units in the relative block are homogeneous and the many experimental units in a block are the same as the many treatments being studied.

The population is limited as a number of residents or individuals who at least have one characteristic in common. In quantitative research, population is defined as an area of generalization consisting of objects or subjects that have certain quantities and characteristics determined by the researcher with the aim of obtaining and then drawing conclusions<sup>9</sup>. The population in this study amounted to 200. Of these who have the same characteristics, the characteristics of the population are as follows: 1) chronic knee injury, 2) male gender, 3) knee injury 1 and 2 months, 4) causes of injury from sports, and 5) age range 18-30 years. The sample is part of the number and characteristics of the population. The sampling technique uses purposive screening. This study is a sample study that only examines a part of the population. The sample used in this study were injury patients who had chronic knee injuries and those who were accompanied by pain total 40.

There are three variables in this study, namely the independent variable that is manipulated, the attribute variable and the dependent variable. To avoid differences in the interpretation of terms on the variables contained in this study, it is necessary to convey or put forward the operational definition as follows:

1. There are 2 manipulated independent variables, namely: 1) effriction massage therapy is a massage method with a combination of efflurage and friction manipulation that uses the entire palm and fingers, 2)

frirage massage therapy is a combination of massage method with friction and efflurage manipulation using the thumb only.

2. The attribute variables were duration of therapy and duration of injury which consisted of: 1) duration of therapy with 10 minutes and 15 minutes 2) duration of injury 1 month and 2 months.
3. The dependent variable is decreased pain

Research instruments are tools or facilities used by researchers to collect data so that research implementation is easier and research results are better, in the sense that research is more careful, research is more complete and research is more systematic so that data processing is more accurate<sup>10</sup>. The instrument used was the VAS (visual analog scale) to measure pain. The data collected in this study were data on the results of the effriction massage therapy method with a therapy duration of 10 and 15 minutes and an injury duration of 1 and 2 months, the frirage massage therapy method with a therapy duration of 10 and 15 minutes and an injury duration of 1 and 2 months on the measurement of pain in the injury. knee that can be generalized or applied to other samples in the population studied, it is necessary to talk about various things that can affect the results of yaotu's research: in the presence of: 1) internal validity and 2) external validity<sup>11</sup>. internal validity relating to the validity of the conclusions drawn about the cause and effect of the relationship between the independent and dependent variables. Meanwhile, external validity, which refers to the validity of the cause – effect relationship generalized to others, the setting, the validity to solve problems, and further action<sup>11</sup>.

**In this study, the following requirements were tested:** Normality test with Kolmogorov Smirnov. The data found were VAS measurement data, the Kolmogorov Smirnov normality test was performed ( $p > 0.05$ ) and the results were normally distributed data. Homogeneity Test, the data found were VAS measurement data on the quad dricep muscle and hamstring muscle. The homogeneity test was performed using the Levene test ( $p > 0.05$ ) and the results were homogeneous data variants. ANOVA test and LSD test, ANOVA test ( $p < 0.05$ ) to determine whether there is an effect of massage therapy treatment effriction, efflurage on reducing pain in knee injuries. After the research data was collected, the data was processed using the parametric ANOVA test at a significance level of 0.5%, through the SPSS program<sup>12</sup>.

Internal validity shows that the test differences on the dependent variable are the result of manipulation of each independent variable that is different in each group, while external validity is where the results can be generalized or applied to groups and environments that are not experimental treatment, in this study the validity of the design. internal, among others: 1) The effect of the physical condition of the sample who suffered an injury, namely not experiencing pain other than the injury suffered, 2) The effect of physical maturity, is to select a sample of the same gender from a similar age range, so that it is expected to have the same characteristics, in the sense that it has the same maturity, 3) The effect of time, the time of research is controlled in such a way as to avoid the existence of various forms of intervention that make injuries the higher the level of injury suffered by the sample, 4) The effect of natural conditions, is to adjust the serving time, 5) Slow Treatment for each group so that the conditions are at the same level, but the time is arranged in such a way that there is no significant difference, the treatment is carried out with the intervention of the type of massage, duration of injury and duration of therapy, 6) Effect of tests, control of the test by giving time the same breaks at the final data collection, no experimental treatment at the time of performing the test<sup>13</sup>.

The results of this experiment were generalized from the population, the sampling in this study was carried out purposively, carried out by considering that the subjects had gone through screening, with the level of injury being adjusted to the level of injury taken and the level of stress that was equal, so that it was considered to be of a similar level to be sampled in the experiment. this. Sampling is done by providing a pain test to determine the level of injury suffered. The pain test used is a visual analog scale or a numeric rating scale to determine the group in Control of Ecological Validity<sup>14</sup>.

#### **The ecological validity in this study are:**

1. All treatments given must be predicted so that the implementation of this experiment can be generalized and used in another time.
2. The main relation, interaction relation and combination relation which is manipulated with the treatment effect can still be used at the same time, so that the treatment in this experiment. Sensitivity to the initial test is controlled in such a way as not to treat the initial test.
3. Trial of the implementation of teaching method and assessment of instruments carefully, so that the implementation of research for each group and the results of the assessment can be controlled properly.
4. Sensitivity to the test is controlled by not giving treatment to the implementation of the test.
5. Control of the dependent variable measurement, by controlling the test
6. Psychological influence in the implementation of experimental treatment

## **Result and Discussion**

**Data Description:** The data that will be described by the researcher are data obtained from the field in the form of injury duration, therapy duration and pain reduction. The sample in this study amounted to 64 people who were divided into 8 groups. Data described in the form of injury duration were obtained from interviews with patients, meaning that the duration of the injury was from the time of incident to the arrival of clinical therapy for sports injury massage. Furthermore, decreased pain perception experienced by patients during therapy and post therapy.<sup>15</sup>

**Duration of Therapy and Injury:** The duration of injury experienced by athletes who suffered an injury in this study was grouped into 2 groups, in general, the duration of the injury was 1 month and the duration of the injury was 2 months. The therapy used was Effriction massage therapy, the duration of therapy was 10 minutes and 15 minutes of treatment and the sample requirements were injury for 1 month and injury for 2 months, with a sample of 64 people who were selected according to the verification sheet. From the raw data obtained, it can be described as follows:

**Table 1: Descriptive Statistics based on mean and standard deviation**

Descriptive Statistics					
Dependent Variable: PN					
J_T	Durasicedera	Durasi Terapi	Mean	Std. Deviation	N
Effriction	1month	10 minutes	6,0000	1,41421	8
		15minutes	4,8750	,35355	8
		Total	5,4375	1,15289	16
	2month	10 minutes	2,1250	,99103	8
		15minutes	3,1250	1,12599	8
		Total	2,6250	1,14746	16
	Total	10 minutes	4,0625	2,32289	16
		15minutes	4,0000	1,21106	16
		Total	4,0313	1,82252	32
Frirage	1month	10 minutes	5,2500	1,28174	8
		15minutes	4,1250	,83452	8
		Total	4,6875	1,19548	16
	2month	10 minutes	5,7500	1,16496	8
		15minutes	4,6250	1,06066	8
		Total	5,1875	1,22304	16
	Total	10 minutes	5,5000	1,21106	16
		15minutes	4,3750	,95743	16
		Total	4,9375	1,21649	32
Total	1month	10 minutes	5,6250	1,36015	16
		15minutes	4,5000	,73030	16
		Total	5,0625	1,21649	32
	2month	10 minutes	3,9375	2,14379	16
		15minutes	3,8750	1,31022	16
		Total	3,9063	1,74798	32
	Total	10 minutes	4,7813	1,96312	32
		15minutes	4,1875	1,09065	32
		Total	4,4844	1,60349	64

The calculation of the normality test is carried out with the aim of knowing whether the research data is normally distributed or not. The results of data normality calculations obtained with a value of  $p > 0.05$ , the data is normally distributed. All test indicators are sig values  $0.282 \geq 5\%$ , so  $H_0$  is accepted, thus the research data is homogeneous.

**Effect of Effriction Therapy with 10 Minutes of Therapy Duration with 1 Month of Injury on Pain:** Data analysis was performed to examine the effect of

type of therapy, duration of therapy and duration of injury on reduction of pain levels in patients with knee injuries. In this section, the type of therapy used is effriction therapy with a therapy duration of 10 minutes and an injury duration of 1 month with a selected sample of 8 people. Statistical analysis shows that the t test results above show that the significance is 0.047. The test results are known to be smaller than 0.05 ( $0.047 < 0.05$ ) so that the hypothesis is accepted, meaning that there is a significant effect of massage effriction therapy with a

therapy duration of 10 minutes and an injury duration of 1 month on pain perception in knee injuries.

**Effect of Effriction Therapy with a Therapy Duration of 15 Minutes and an Injury Duration of 1 Month on Pain:** Data analysis was performed to examine the effect of type of therapy, duration of therapy and duration of injury on reduction of pain levels in patients with knee injuries. In this section, the type of therapy used is effriction therapy with a therapy duration of 15 minutes and an injury duration of 1 month with a selected sample of 8 people. Statistical analysis shows that the t test results above show that the significance is 0.049. The test results are known to be smaller than 0.05 ( $0.047 < 0.05$ ) so that the hypothesis is accepted, meaning that there is a significant effect of massage effriction therapy with a therapy duration of 15 minutes and an injury duration of 1 month on pain perception in knee injuries.

**Effect of Effriction Therapy with a Therapy Duration of 10 Minutes and an Injury Duration of 2 Months on Pain:** Data analysis was performed to examine the effect of type of therapy, duration of therapy and duration of injury on reduction of pain levels in patients with knee injuries. In this section, the type of therapy used is effriction therapy with a therapy duration of 10 minutes and an injury duration of 2 months with a selected sample of 8 people, statistical analysis obtained 0.056. The test result is known to be greater than 0.05 ( $0.056 > 0.05$ ) so that the hypothesis is rejected, meaning that there is no significant effect of massage effriction therapy, 10 minutes duration and 2 months of injury duration on reducing pain in knee injuries.

**Effect of Effriction Therapy with a duration of 15 minutes of therapy with an injury duration of 2 months on pain:** Data analysis was performed to examine the effect of type of therapy, duration of therapy and duration of injury on reduction of pain levels in patients with knee injuries. In this section, the type of therapy used is effriction therapy with a therapy duration of 15 minutes and an injury duration of 2 months with a selected sample of 8 people. Statistical analysis shows that the t test results above show that the significance is 0.063. The test results are known to be greater than 0.05 ( $0.063 > 0.05$ ) so that the hypothesis is rejected, meaning that there is no significant effect of massage effriction therapy, 15 minutes duration and 2 months of injury duration on reducing pain in knee injuries.

**Effect of frirage therapy with a therapy duration of 10 minutes and an injury duration of 1 month on pain:** Data analysis was performed to examine the effect of type of therapy, duration of therapy and duration of injury on reduction of pain levels in patients with knee injuries. In this section, the type of therapy used is Frirage therapy with a therapy duration of 10 minutes and an injury duration of 1 month with a selected sample of 8 people. Statistical analysis showed that the t test results above showed that the significance was obtained 0.061. The test result is known to be greater than 0.061 ( $0.061 > 0.05$ ) so that the hypothesis is rejected, meaning that there is no significant effect of frirage massage therapy, 10 minutes duration and 1 month injury duration on reducing pain in knee injuries.

**Effect of frirage therapy with a therapy duration of 15 minutes with an injury duration of 1 month on pain:** Data analysis was performed to examine the effect of type of therapy, duration of therapy and duration of injury on reduction of pain levels in patients with knee injuries. In this section, the type of therapy used is Frirage therapy with a therapy duration of 10 minutes and an injury duration of 1 month with a selected sample of 8 people. Statistical analysis shows that the t test results above show that the significance is 0.050. The test result is known to be greater than 0.050 ( $0.061 > 0.05$ ) so that the hypothesis is accepted, meaning that there is a significant effect of frirage massage therapy, 15 minutes duration and 1 month injury duration on reducing pain in knee injuries.

**Effect of frirage therapy with a therapy duration of 10 minutes with a duration of injury of 2 months on pain:** Data analysis was performed to examine the effect of type of therapy, duration of therapy and duration of injury on reduction of pain levels in patients with knee injuries. In this section, the type of therapy used is Frirage therapy with a therapy duration of 10 minutes and an injury duration of 2 months with a selected sample of 8 people. Statistical analysis showed that the t test results above showed that the significance was obtained 0.063. The test results are known to be greater than 0.063 ( $0.063 > 0.05$ ) so that the hypothesis is rejected, meaning that there is no significant effect of frirage massage therapy, 10 minutes duration and 2 months of injury duration on reducing pain in knee injuries.

**Effect of frirage therapy with a therapy duration of 15 minutes with a duration of injury of 2 months**

**on pain:** Data analysis was performed to examine the effect of type of therapy, duration of therapy and duration of injury on reduction of pain levels in patients with knee injuries. In this section, the type of therapy used is Frirage therapy with a therapy duration of 15 minutes and an injury duration of 2 months with a selected sample of 8 people. Statistical analysis showed that the results of the t test above showed that the significance was obtained 0.063. The test results are known to be greater than 0.063 ( $0.063 > 0.05$ ) so that the hypothesis is rejected, meaning that there is no significant effect of frirage massage therapy, 15 minutes of therapy duration and 2 months of injury duration on reducing pain in knee injuries. Significance values that appear are important values and it can be concluded that the effect of all independent variables on the type of massage, duration of therapy and duration of injury on pain reduction. The duration of therapy simultaneously affects the dependent variable (pain reduction). If Significance (Sig.)  $< 0.05$  (Alfa) = Significant. Based on the table. The significance (Sig.) Of the Corrected Model shows 0,000 means that the model is valid. The value of changes in the dependent variable without the need to be influenced by the existence of an independent variable, meaning that without the influence of the independent variable, the dependent variable can change in value. If Significance (Sig.)  $< 0.05$  (Alfa) = Significant. Based on the Significance Table (Sig.) Of the Intercept, it shows 0.000, which means that the Intercept is significant. The error value of the model, the smaller the model the better. The value of multiple determination of all independent variables with the dependent. R Squared shows 0.553 which is close to 1, meaning strong influence.

### Conclusion

The results of the study for the homogeneity test mean that the data are homogeneous, and there is a significant difference between 1 month and 2 months of injury. It was obtained that for massage therapy with an effriction treatment, the duration of the injury was 1 month with a duration of 10 minutes of therapy, which experienced a significant reduction in pain by 0.047 and for effriction therapy with a duration of 15 minutes, it had a significance of 0.049 so that for effriction therapy the duration of the injury was 1 month and for frirage therapy the duration of the injury was 1 month. months with 15 minutes of therapy in this group alone experienced a significant reduction. So that for 1 month there was no interaction between the independent variables and the dependent variable for the duration of

2 months there was an interaction because many factors influenced the reduction of pain and must be described in other studies. Effriction massage therapy is determined as a complementary therapy that is effective in helping to reduce pain relief in knee injuries, especially for 1 month injuries with a duration of 10 minutes and 15 minutes and frirage can significantly reduce pain in the injury duration of 1 month with a therapy duration of 15 minutes, and the type for this therapy there was a non-significant reduction in injury duration of 2 months.

**Conflict of Interest:** None to declare

**Source of Funding:** Self

**Ethical Clearance:** Institutional Ethics Committee clearance obtained.

### References

1. A. Rahim.. Masase Olahraga. Jakarta: Pustaka Merdeka.
2. Ardinata, D. (2014). Multidimensional Nyeri. *Jurnal Keperawatan Rufaidah Sumatera Utara*, 1988.2(May), 77–81.
3. Arovah, dr. N. I. Dasar-dasar fisioterapi pada cedera olahraga (1st ed.). Yogyakarta.2010
4. Bahrudin, M. . Patofisiologi nyeri. *Symposium Nyeri*, 2017.13(1), 11–29.
5. Bambang, A. S. G. dan P. . Terapi Massage Frirage, Penatalaksanaan Cedera pada Anggota Tubuh Bawah (1st ad). Yogyakarta: Klinik Terapi Fisik UNY.2012
6. Becker, J. . Terapi Pijat Memijat Diri Sendiri Guna Memperoleh Kesehatan Fisik dan Psikis. *Terjemahan Agus Supriyadi*. 2005. Jakarta: PT. Prestasi Pustakarya.
7. G. La. Cava. . Pengobatan dan Olahraga Bunga Rampai. Semarang Dhara Prize: 1995.1 st ad.
8. Gorrison, S. .. Dasar-dasar Terapi dan Rehabilitasi Fisik. 2001.Jakarta: Hipokrates.
9. Guyton, A.C., Hall, J. E. . Buku ajar fisiologi kedokteran.2006. (11 st). Jakarta.
10. Hardianto Wibowo.. Cedera Olahraga. Jakarta:1995. 1st ad.
11. Harker, J., Reid, K. J., Bekkering, G. E., Kellen, E., Bala, M. M., Riemsma, R., ... Kleijnen, J. . Epidemiology of chronic pain in Denmark and Sweden. 2012.Pain Research and Treatment. <https://doi.org/10.1155/2012/371248>

12. International Association for the Study of Pain.. IASP Terminology - IASP. 1994 Retrieved from <http://www.iasp-pain.org/terminology?navItemNumber=576#Pain>
13. Mangaku G, S.T. Buku ajar Ilmu Anestesia dan Reanimasi.2010 Jakarta barat.
14. Nugroho, B.S., Laksmi, R., Jurusan, A., Keshatan, P., Fik, R., Abstrak, U. N. Y., ... Priyonoadi, B. Tingkat Pengetahuan Atlet Tentang Cedera Ankle Dan, 2009. 23–38.
15. Perry, P. buku ajar fundamental keperawatan. The Journal of adolescent health : official publication of the Society for Adolescent Medicine 2005. (Vol. 39). <https://doi.org/10.1021/cb100008p>
16. Setiawan, A. Sport injury. (Hermawan, Ed.) (1st ed.). Semarang: Andi Offset. 2010

# Familial Phenotype of Waardenburg Syndrome in One Family: A Case Series

Eka Savitri<sup>1</sup>, Indra Irawan<sup>1</sup>, Habibah S. Muhiddin<sup>1</sup>, Fadly<sup>1</sup>

<sup>1</sup>Lecturers of Department of Otorhinolaryngology, Faculty of Medicine Universitas Hasanuddin, Makassar

## Abstract

Waardenburg syndrome is an accumulation of some genetic conditions which leads to sensorineural hearing loss (SNHL) and depigmentation of hair, skin, and eyes. The cause of sensorineural hearing loss in children can be congenital or hereditary, characterized by sensorineural deafness, associated with pigment disorders and tissue defects. Based on the accompanying symptoms, Waardenburg syndrome is divided into 4 types, where the most often ones are type 1 and 2. Clinical symptoms including dystopia canthorum, pigment disorders (white crest, abnormalities of eyebrow, eyelashes, body hair and iris heterochromia), sensorineural deafness, protruding nose and depigmented hair at young age. Based on physical and additional examinations performed on five patients, all results showed major and minor symptoms of Waardenburg syndrome accompanied by dystopia canthorum, therefore classified as Waardenburg type 1.

**Conclusion:** All patients are classified as type 1 Waardenburg syndrome which were inherited in the form of autosomal dominant.

**Keywords:** SNHL, Waardenburg syndrome, dystopia canthorum, autosomal dominant.

## Introduction

Deafness is one of the problems in children that will affect speech, social, cognitive and academic development. Deafness can be caused by congenital or acquired abnormalities.<sup>(1)</sup> In developed countries, the rate of congenital deafness ranges from 0.1 to 0.3% of live births, whereas the number in Indonesia is about 0.1% based on a survey conducted by the health department in 7 provinces from 1994 to 1996. Congenital deafness in Indonesia is estimated to be around 214,100, considering the number of total population is 214,100,000 million. This number will increase every year with an increase in population due to the high birth rate, 0.22% from the previous one.<sup>(2)</sup> Congenital deafness occurs in a baby due to factors that affect pregnancy and delivery processes. Congenital deafness can be genetic (hereditary) and non

genetic. Non genetic congenital deafness is determined by the mother's condition during pregnancy and delivery processes.<sup>(3)</sup>

Waardenburg syndrome is one of congenital hereditary deafness, firstly discovered by an ophthalmologist from the Netherlands named Petrus Johannes Waardenburg in 1947. He initially found some symptoms of canthorum dystopia, different eye pigment colors (heterochromia) and deafness.<sup>(1,4)</sup> In 1951, after identifying other patients with the same symptoms, Waardenburg classified patients with these symptoms into Waardenburg type I syndrome. In 1971, Arias further defined Waardenburg type II syndrome.<sup>(5)</sup> Then in 1981, Shah and other researchers discovered infants with Hirschprung's disease and white forelock which is classified as Waardenburg type IV syndrome. Then in 1983, Klein discovered patients with type I symptoms accompanied by abnormalities of arm hypoplasia and arthrogryposis on the hands and wrists, which were then classified as Waardenburg type III syndrome.<sup>(6)</sup>

Waardenburg syndrome is an accumulation of some genetic conditions which leads to sensorineural hearing loss (SNHL) and depigmentation of hair, skin, and eyes.

---

## Corresponding Author:

**Eka Savitri**

Lecturers of Department of Otorhinolaryngology,  
Faculty of Medicine Universitas Hasanuddin, Makassar  
e-mail: ekasapan@yahoo.com

Although most people with Waardenburg syndrome have normal hearing, waardenburg syndrome can also cause moderate to very severe hearing loss which can occur in one or both ears and can occur from birth. Someone with this condition often has very pale blue eyes or even different eye color one to another, in some cases one eye is blue while the opposite eye is brown. Sometimes one eye even has two different colors. Typical hair coloring such as white hair or hair that turns into premature gray is another common sign of waardenburg syndrome.<sup>(7,8)</sup>

The most common characteristic of waardenburg syndrome is iris color differentiation between the two eyes: one eye usually has brown iris and the opposite eye is blue. Sometimes color differences are found in one eye, or in some cases both eyes are bright blue. Since deafness often arises as a symptom of this syndrome, hearing examination and treatment, such as the use of hearing aids and the selection of schools suitable for child development, should be a concern.<sup>(7,8)</sup>

**Case Report:** An examination was conducted on a family with some family members who had a lineage of waardenburg syndrome where the phenotype of waardenburg syndrome was present in the last 3 generation. There were no recorded inbreeding in the family and there were no marriages of family members with other people known to suffer from waardenburg syndrome.

**Case 1:** A 16-year-old girl (Ms.F) is suspected of having hearing loss since she was a baby, for she did not respond when called and could not speak at all. Her eyes are blue since birth, and there were family members having the same abnormalities which were her sister and a parents. No abnormalities were found in the prenatal, perinatal and postnatal history. Motor developments were good according to her age.

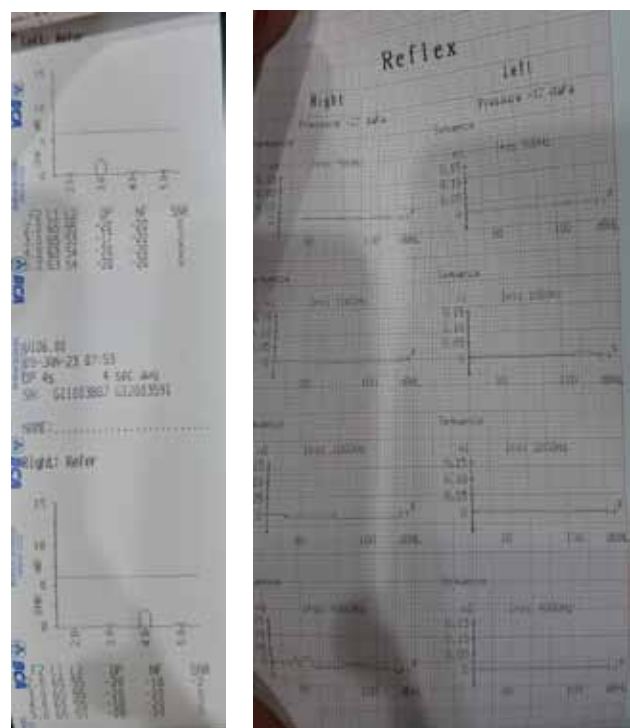
Physical examination of the ear, nose, oropharynx and neck revealed no abnormalities, while the examination on maxillofacial region showed abnormalities of iris pigments in the form of complete iris heterochromia, canthorumdystopia, and alanas hypoplasia. Musculoskeletal and gastrointestinal were normal.

Audiological examination revealed total deaf audiogram, with type A/type A tympanogram, and no acoustic reflexes in both ears. OAE examination referred to both ears, concluded as abnormality in left/right outer cochlear hair cells.

**Case 2:** A 38-year-old woman (Mrs. H) was suspected of having hearing loss since she was a baby, for she did not respond when called and could not speak at all. Her eyes are blue since birth, and there was a history of hair pigment changes (whitening) before the age of 30, along with familial history of the same abnormality. Her son also has blue eyes yet without any hearing loss.

Examination of the ear, nose, oropharynx and neck showed no abnormalities, whereas examination of the maxillofacial region showed irregular pigment abnormalities in the form of complete heterochromia of the iris, canthorumdystopia ( $W \text{ index} > 1.95$ ), premature gray hair and broad nasal root. Musculoskeletal and gastrointestinal tract are within normal limits.

The result of the audiology examination showed total deafness, with type A/type A tympanogram, and no acoustic reflexes in both ears. OAE examination showed refer to both ears, concluded as abnormality in left/right outer cochlear hair cells.



**Picture 1. The result of OAE and reflexes examination in Mrs.H**

**Case 3:** A boy (M) aged 1 year 10 months has unilateral blue eye from birth, with no abnormalities in the prenatal, perinatal and postnatal periods. His mother does not have a history of serious illness during pregnancy. The patient is a child of a mother suffering

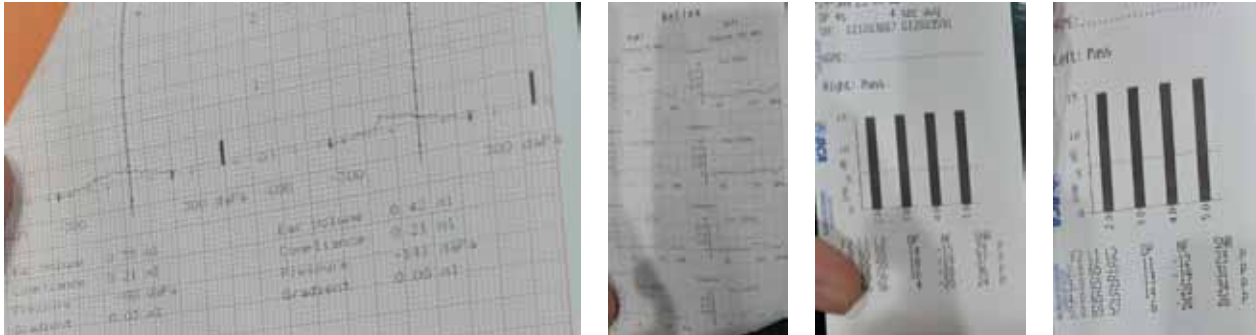


from type 1 waardenberg syndrome and a father who is deaf. There is no history of seizures.

Physical examination of the ear, nose, oropharynx and neck did not show any abnormalities, while examination of the maxillofacial region showed pigment abnormalities in the form of partial heterochromia, dystopia canthorum, synophrys and alanasihypoplasia. Musculoskeletal and gastrointestinal tract are within

normal limits.

The result of the tympanometry examination are type A/type Atympanogram, and the acoustic reflexes in both ears are within normal limits. OAE examination revealed a pass in both ears, so it was concluded that there was no disruption of the right/left outer cochlear hair cells.



Picture 2. The result of tympanometry and OAE in boy M

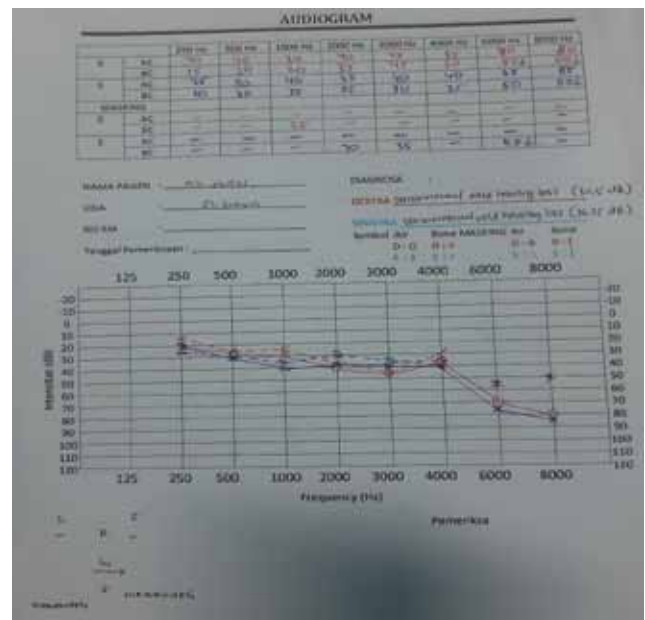


Picture 3. Heterochromia in Mrs.M

**Case 4:** A 52-year-old woman (Mrs. M) has blue eyes since birth, and there is a history of changes in hair pigment (whitening) before the age of 30. There is a family history of the same abnormality. The patient has a boy who has blue eyes yet without hearing loss.

Examination of the ear, nose, oropharynx and neck showed no abnormalities, whereas examination of the maxillofacial region showed pigment abnormalities in the form of complete heterochromia of the iris, canthorumdystopia ( $W \text{ index} > 1.95$ ), premature gray hair

and broad nasal root. Musculoskeletal and gastrointestinal tract are within normal limits. Audiometry examination showed mild sensorineural hearing loss.



Picture 4. The result of audiometry in Mrs. M

**Case 5:** A 45-year-old woman (Mrs. R) has a history of changes in hair pigment (turning white) before the age of 30, without blue eyes. There is a family history of the same disorder. The patient had a boy who had blue eyes

without hearing loss, and one girl who had blue eyes accompanied by severe sensorineural hearing loss from birth.

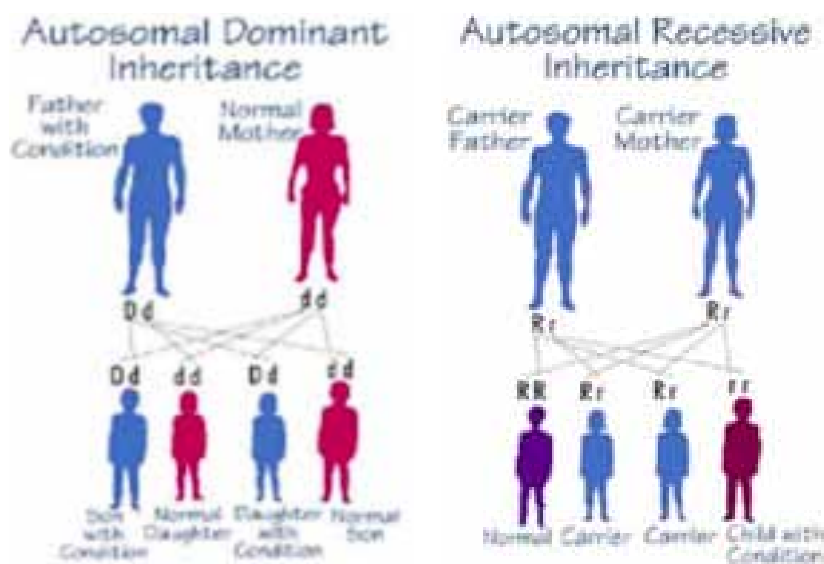


Picture 5. Heterochromia in Mrs.F

Examination of the ear, nose, oropharynx and neck showed no abnormalities, whereas examination of the maxillofacial region showed pigment abnormalities in the form of complete heterochromia of the iris, canthorumdystopia (W index > 1.95), premature gray hair and broad nasal root. Musculoskeletal and gastrointestinal tract are within normal limits. Audiometry examination showed moderate sensorineural hearing loss.

Waardenburg syndrome is an autosomal dominant inherited disorder with the most frequent manifestations of congenital sensorineural deafness and disorders of hair and skin pigmentation.<sup>(1,2)</sup>

Waardenburg syndrome types 1, 2 and 3 are inherited autosomal dominant, whereas type 4 is inherited autosomal recessive.<sup>(8)</sup>



Picture 6. The flow of inherited dominant and recessive autosomal<sup>(13)</sup>

Waardenburg type 1 is characterized by the presence of non-progressive congenital sensorineural deafness, dystopia canthorum, white forelock, and several minor abnormalities such as congenital leukoderma. Waardenburg type 2 and type 3 are characterized by the presence of dystopia canthorum and musculoskeletal abnormalities in the upper extremities (aplasia of the ribs, carpal bone abnormalities, cystic formation of sacrum bones, amyoplasia, joint stiffness and bilateral syndactyly). Furthermore, Waardenburg type 4 syndrome is characterized by iris heterochromia, sensorineural

hearing loss and is accompanied by Hirschprung’s disease.<sup>(3,4)</sup>

Table 1. Classification of clinical manifestation in Waardenburg syndrome<sup>(13)</sup>

Type	Clinical manifestation
I	Dystopia canthorum W > 1.95
II	No dystopia
III (Klein waardenburg)	Hypoplasia of extremity muscles such as elbow and fingers
IV (Shah- waardenburg)	Hirschprung’s disease

Waardenburg syndrome is an auditory-pigmentary disorder with a basic cause of hearing loss is the need for melanocytes in the cystic vascular cyst of the unexplained, for example in the case of albinism where hearing remains normal, but there is no melanocytes that cause the vascular stria to become thin, there is no growth of endocochlear, and the development of Reissner membrane is collapsed which leads to the damage of the organ of Corti. All melanocytes, except for the retina, originate from embryonic neural crest. The absence of melanocytes can be caused by failure of differentiation in the neural crest, failure of melanoblast to migrate, or failure of late differentiation or persist in the end place of melanoblast which can be caused by mutations in the genes that regulate it (PAX3, MITF, SOX10, and EDNRB).<sup>(11)</sup>

The Waardenburg Consortium in 1992 established diagnostic criteria for Waardenburg type 1 syndrome, where patients must have at least 2 major symptoms

or 1 major symptom with 2 minor symptoms. Major symptoms include congenital sensorineural hearing loss; iris pigment disorders that can be in the form of complete heterochromic iris (both eyes are of different color), partial or segmental heterochromia (there are pigmented blue or brown segments in one eye or both eyes), hypoplastic blue eyes (bright blue eyes in both eyes), hair hypopigmentation in the form of white forelock, dystopia canthorum (w index > 1.95), with abnormalities also found in siblings. Furthermore, minor symptoms include congenital leukoderma (hypopigmentation areas can be found in several places), synophrys (thick eyebrows that meet medially); wide or high nasal base; hypoplasia of alar nasi, premature graying hair (especially scalp hair, before the age of 30 years). On the other hand, symptoms for type 2 Waardenburg syndrome by Lui et al include the presence of 2 major symptoms, with the exception of dystopia canthorum and including premature graying.<sup>(1,2,4)</sup>

**Table 2. Diagnostic criteria of Waardenberg syndrome<sup>(12)</sup>**

Major criteria	Minor criteria
<ul style="list-style-type: none"> <li>• Congenital sensorineural hearing loss</li> <li>• White forelock, hair hypopigmentation</li> <li>• Pigmentation abnormality of the iris                             <ul style="list-style-type: none"> <li>– Complete heterochromia (irides of different color)</li> <li>– Partial/segmental heterochromia (two different colors in same iris, typically brown and blue)</li> <li>– Hypoplastic blue irides, or brilliant blue irides</li> </ul> </li> <li>• Dystopia canthorum, W index &gt;1.95</li> <li>• Affected first-degree relative</li> </ul>	<ul style="list-style-type: none"> <li>• Skin hypopigmentation (congenital leukoderma)</li> <li>• Synophrys/medial eyebrow flare</li> <li>• Broad/high nasal root, prominent columella</li> <li>• Hypoplastic alar nasi</li> <li>• Premature gray hair (before age 30 years)</li> </ul>

Clinical abnormalities in Waardenburg type 1 can vary even if found in one family. The most common abnormality is sensorineural deafness which is congenital, unilateral or bilateral, and not progressive, with a very severe degree (>100 dB). In the eyes can also be found differences in color, generally one eye is blue and one eye is brown.<sup>(12,13)</sup>

Dystopia canthorum is determined from the W Index calculated based on the distance between the medial canthus (a), lateral canthus (c), and the distance between pupils (b) in millimeters, with the following formula. The diagnosis is established if the W index is more than 1.95.<sup>(3)</sup>

Congenital sensorineural deafness is a manifestation that often accompanies Waardenburg syndrome. Therefore, audiology examination has a very important role. Audiology screening can be performed on infants and children whose parents or families have a history of Waardenburg syndrome, although there are no clinical manifestations.

Congenital deafness causes problems with individual and social development of individuals. The use of hearing aids is one of the options that can be used as early as possible, to prevent the development of speech, language, mental, and intellectual development, so that patients are expected to live a normal life.

There are 2 methods recommended for use in the examination of hearing loss in newborns, namely Otoacoustic Emission (OAE) and Auditory Brainstem Responses (ABR)/Brainstem Evoked Response Audiometry (BERA), which is usually done in a hospital in a state of calm sleep babies. Both are fast and easy to do, not invasive, inexpensive, and quite sensitive in detecting hearing loss.<sup>10</sup>

In the first case, the patient was diagnosed as type 1 Waardenburg syndrome because of the bluish iris color and very severe neural sensory deafness, accompanied by dystopia canthorum. Furthermore, patient in the second case was also diagnosed as Waardenburg type 1 syndrome due to bluish iris color and severe sensorineural deafness, and accompanied by dystopia canthorum. For the third case, the patient was diagnosed as Waardenburg type 1 syndrome because of a unilateral grayish iris color without hearing loss, accompanied by dystopia canthorum.

In the fourth case, the patient was diagnosed as Waardenburg type 1 syndrome due to a bluish iris color and moderate degree of sensorineural deafness, accompanied by dystopia canthorum. Subsequently, the fifth case was diagnosed as Waardenburg type 1 syndrome due to unilateral gray iris color without hearing loss, accompanied by dystopia canthorum. All patients examined did not show any musculoskeletal and gastrointestinal abnormalities.

Management in patients with Waardenburg syndrome should be done as early as possible by using hearing aids (ABD) and auditory verbal therapy (AVT). In reported cases, treatment is aimed at deafness and correcting anatomical abnormalities through surgical procedures.

Deafness must be detected immediately and get treatment as early as possible. Genetic counseling can be done and attention is directed towards providing information about clinical manifestations that will emerge and the likelihood that a child will suffer from this syndrome from parents who have suffered from Waardenburg syndrome, so that disorders that must be treated immediately can be of concern to parents and family.<sup>(7,9)</sup>

Consultation with a geneticist is important, because people with type 1 and 2 Waardenburg generally have a 50% risk to inherit the syndrome to their baby during pregnancy. Consultation and examination by an

ophthalmologist is needed to evaluate the visual and visual field and other abnormalities in the eye field. In general, people with Waardenburg syndrome have vision within normal limits. A dermatologist's consultation is done if there are abnormalities in the skin to rule out other diseases or malignancies. Evaluations by pediatricians are carried out for growth and development examinations, while surgeon evaluations are performed if there are abnormalities in other organs such as Hirschsprung's disease.<sup>(1,5)</sup>

Congenital deafness causes problems of individual and social development. Early detection and treatment offers hope in individual development. The use of hearing aids is one of the options that needs to be given as early as possible to prevent impaired speech, language, mental and intellectual development so that patients are expected to be able to live a normal life.<sup>(10)</sup>

In the field of otorhinolaryngology, the management of Waardenburg syndrome is aimed at hearing screening, evaluation of sensorineural deafness for hearing instrumentation, and when possible using cochlear implants. Other treatment is speech therapy so that people with Waardenburg syndrome can communicate.<sup>15</sup>

Early diagnosis and improvement of hearing defects are important for the psychological development of children with this congenital abnormality and also to help reduce feelings of isolation.<sup>(2)</sup> Management of hearing loss depends on the severity of the hearing loss. Cochlear implants are still the main choice for rehabilitation of hearing function in children with severe to severe sensorineural hearing loss. In patients with Waardenburg syndrome, the normal level of intelligence is normal and the hearing loss that occurs is sensoryneural, so that the use of cochlear implants can provide good results if accompanied by an intensive rehabilitation program.<sup>(14)</sup> The process of hearing rehabilitation in sensoryneural hearing loss provides a good prognosis, so that the implant Kolka is recommended for people with Waardenburg syndrome if there are no anatomical abnormalities in the inner ear, including cochlear hypoplasia, internal acoustic canal, absence of posterior semicircular canals and malformations in the other two semicircular canals.<sup>(14)</sup> Cochlear implants provide direct stimulation to the cochlear nerve fibers. Cochlear implants are indicated in both adults and children with very severe hearing loss who do not benefit from the use of conventional hearing aids. Prognosis of hearing, language development and sociability in young

children (deafness) is not only dependent on the optimal amplification of hearing aids or cochlear implants, but also depends on the type of rehabilitation education that the patient receives. There are various types of education that can be used as a rehabilitation process for patients with hearing loss. In education based on auditory-verbal communication, patients learn to use sound instructions optimally by practicing understanding languages and pronouncing language correctly. In oral communication, patients learn to hear and speak with the help of lip readings. In the type of total communication rehabilitation, a combination of oral language and sign language is taught to maximize communication skills.<sup>(14)</sup>

Management of hearing loss includes prevention, education, and psychological assessment. Prevention is done by avoiding predisposing factors such as marriage between sufferers of congenital deafness and marriage between families. Screening should start as early as possible, ideally all children aged 6-9 months have a definite hearing function, and then immediately after entering school at the age of 5-6 years. Very important at the educational stage is the rehabilitation of early training in deaf children, namely by using hearing aids (ABD) to utilize the remaining hearing function. Installation of ABD devices in children with severe or very severe deafness must begin as early as possible. This is done so that the development of speech and education is not too late. Cochlear implant considerations as indicated. In addition, speech therapy is also needed to correct speech disorders caused by congenital deafness. Home training includes early training that depends on the sufferer's parents. If it can be detected and treated early and well, then people with Waardenburg can live normally in the community.<sup>(15)</sup>

Family counseling is a very important component, because in case 2 it can be seen that the sufferer is married to a fellow deaf, and there is a family history of Waardenburg syndrome. If the patient is still planning to have a child, then an explanation is given that there is a tendency for his child to suffer from Waardenburg syndrome. After the child is born, hearing screening must be done as a first step. In the third case, the sufferer lives with his mother and father who are also deaf and speech impaired, so that both of them need counseling that their children need word learning by involving other family members who are not hearing impaired and talk impaired, or can also with the help of informatics media.<sup>(15)</sup>

## Conclusion

Waardenburg syndrome is an autosomal dominant inherited disorder, with the most frequent manifestations of congenital sensorineural deafness and disorders of hair and skin pigmentation. Waardenburg syndrome is classified into 4 types, namely Waardenburg syndrome type 1, type 2, Klein-Waardenburg or type 3, and Waardenburg-Shah or type 4. Genetic mutations are suspected as a cause of Waardenburg syndrome. Interactions between the PAX3, MITF, SNAIL2 and SOX10 genes cause manifestations of deafness and pigmentation disorders. The five patients who were reported as belonging to type 1 waardenburg syndrome, based on the phenotype of each patient who was inherited autosomal dominant. Treatment is aimed at deafness and repairing anatomic abnormalities through surgery. Deafness must be detected immediately and get treatment as early as possible. Genetic counseling can be done, and attention is paid to providing information about clinical manifestations that will emerge and the possibility of a child suffering from this syndrome from parents who have suffered from Waardenburg syndrome, so that disorders that must be treated immediately can be of concern to parents and family.

**Ethical Clearance:** Taken from Medical faculty ethical committee.

**Source of Funding:** Self

**Conflict of Interest:** Nil

## References

1. Johnson R, Greinwald J. Genetic hearing loss. In: Bailey BJ, Johnson JT, Newland SD, eds. Head and neck surgery, 4th ed. Churchill Livingstone: Williams & Warwick; 2006. p.1303-15
2. Soetjipto D. Tulikongenital. Komnas PGPKT 2007. Available from: <http://www.ketuliaan.com>. Accessed December 2, 2011
3. Purnami N. Deteksidanintervensidini. Dalam : Mulyarja, Soedjak S, Kentjono WA, et al, eds. Otitis media danpermasalahannyasertakemajuanimplantasi koklea. Surabaya: PKB V THT-KL; 2006. p.97-105
4. Deborah LC, Hilary LR. Pediatric audiology. In: Bailey BJ, Johnson JT, Newland SD, eds. Head and neck surgery, 4th ed. Churchill Livingstone: Williams & Warwick; 2006. p.1277-88

5. Schwartz AR. Genetics of Waardenburg. 2010. Available from: <http://emedicine.medscape.com> . Accessed Februari 5, 2020
6. Reardon W. Newly emerging concepts in syndromology relevant to audiology and otolaryngology practice. In: Martini A, Stephens D, Read AP, eds. Genes, hearing, and deafness. Philadelphia: InformaUk Ltd; 2007. p.49-51
7. Khanal et al. Waardenburg Syndrome: A Report of Two Familial Case Series. *Optometry & Visual Performance J.* 2011; 25
8. Renatha, A dan Ekorini,H. Sindrom Waardenburgdalam satukeluarga. *Jurnal THT-KL. Universitas Airlangga. Surabaya.* 2012 : 1-2.
9. Swanepoel D, Ebrahim S. Auditory steady-state response and auditory brainstem response thresholds in children. *Eur Arch Otorhinolaryngol* 2009;266:213-9. [PubMed] [Google Scholar]
10. Higler AB. BOIES Fundamentals of Otolaryngology. 6 ed. Jakarta: EGC; 1997.
11. Huang et al. Pediatric Sensorineural Hearing Loss, Part 2: Syndromic and Acquired Causes. *AJNR Am J Neuroradiol.* 2011;2.
12. Saputra, AndiDwi and W. Suardana. Sindrom Waardenburg. *CDK Journal.* 2011 (38): 420-2.
13. Andrew P Read and Valerie E Newton. Waardenburg syndrome. *J Med Genet* 1997;34:656-665.
14. Farrer LA, Grundfast KM, Amos J, et al. Waardenburg syndrome (WS) type I is caused by defects at multiple loci, one of which is near ALPP on chromosome 2: first report of the WS consortium. *Am J Hum Genet* 1992; 50(5): 902-13
15. Suwento R, Hamadi F. Sindroma Waardenburg. *Otorhinolaryngologica Indonesiana* 2001; 31: 17-8

# Test Instrument Model Talk Athletes for Martial Branch Sports of Tarung Derajat

Ipang Setiawan<sup>1</sup>, Soegiyanto<sup>2</sup>, Mugiyo Hartono<sup>2</sup>, Tri Rustiadi<sup>2</sup>

<sup>1</sup>Doctoral Student, Post Graduate Dept., Universitas Negeri Semarang, Indonesia,

<sup>2</sup>Lecture, Post Graduate Dept., Universitas Negeri Semarang, Indonesia

## Abstract

The general psychological perspective that has been applied occurs after the formation of a good physical condition will be balanced with mental formation, in research and in this level of Tarung Derajat, a psychological perspective will be developed at the beginning in finding athletes' talents with indicators that are determined according to the characteristics of the sparring sport, so that the series conducted is a process of identifying potential athletes to identify talented athletes who have the best abilities according to the character of the degree fighting sport. Based on the results of discussions with several expert qualifiers, the criteria in accordance with the character of the degree fighting sport are achievement, competitive, managing pressure, self-efficacy, fear failure control, stress management, emotion, empathy, power, aggressiveness, the results of the psychological test are converted in percentage to fall into the category of very potential, potential, sufficient potential, less potential, not potential. Norms in category making are taken from athletes from Central Java province with the highest achievement at the national level who win at PON which is the highest level followed by degree Tarung Derajat. The method used is to modify the SPQ20 psychological test to be simple but not eliminate the main criteria in the test as agreed by the expert. The research sample used was athletes who were in the Semarang City regional task force with total sampling technique in order to get a picture of the potential of the athletes. The results of the study obtained data, namely the achievement component of 68%, competitive 66%, managing pressure 62.9%, self-efficacy 67, 78%, 63.73% fear failure control, 63.83% stress management, 65.56% emotion, 70.33% empathy, 54.40% power, 67.73% aggressiveness. Athletes in Satlak have the potential as Talented athlete candidates are 50 athletes or 64% from a psychological perspective. Based on the psychological perspective of the degree fighting athletes who will participate in potential training with an empathy character of 70%, the other components will follow the development with physical and technical criteria.

**Keyword:** *Psychological perspective, potential athlete, Tarung Derajat.*

## Introduction

Performance sports are one of the pillars of sports development as regulated in the Sports System Law. Achievement sports are sports that foster and develop sports in a planned, tiered, and sustainable manner

through competitions to achieve achievement with the support of sports science and technology<sup>1</sup>.

Sport talent identification is an effort that is carried out systematically to identify someone who has the potential in sports, so that it is estimated that someone will be successful in training and can reach peak performance. The process of identifying gifted athletes should be of concern to each sport, because the main objective of conducting talent scouting is to identify and select potential athletes who have the highest abilities in a particular sport<sup>2</sup>. The goal of talent scouting is also used to predict a high degree of likelihood of whether an athlete will be able to and successfully complete a

---

### Corresponding Author:

**Ipang Setiawan**

Doctoral Student, Post Graduate Dept., Universitas Negeri Semarang, Indonesia

e-mail: aguspurwanto.prof@gmail.com

training program in a selected sport in order to measure with certainty in carrying out the next stage of training<sup>3</sup>.

Based on the above theories, the researcher tries to connect with the research problem to be raised by making observations in the field. The results of preliminary observations made by researchers in February 2019 at Pengprov Tarung Derajat Central Java, Jalan Guntur, No.3, Gajahmungkur District, Semarang City, obtained data that in the Tarung Derajat sport there is no standard test instrument in scouting talent athletes. potential athletes in Tarung Derajat, because in this physical test the instruments are used in general and are not consistent in every test implementation. In a focus group discussion (FGD) in July 2019, the speakers consisting of the main coach, Central Java coach, administrators, central administrators and administrators of Central Java said that the martial arts sport of fighting degrees does not have standard guidelines to measure the ability of athletes. And he also conveyed that there is a need for standard guidelines that must be possessed by a degree fighter<sup>4</sup>.

Tarung Derajat sports talent scouting has simply been developed but is still not done intensively and specifically. The needs of components (such as biomotor, anthropometric, and psychological) in each athlete in various sports are different to increase their performance<sup>5</sup>. For example, in the sport of weightlifting, the dominance of the biomotor components needed is muscle strength, explosive power and balance. In addition, martial arts sports that require speed, reaction time, coordination and power, such as judo. In another article, fencing requires a talent scouting instrument consisting of a kinesthetic perception test, eye-hand coordination test, upper limb strength test, lower limb strength test, agility test and endurance test<sup>6</sup>. Whereas in Tarung the degree of dominance needed is muscle endurance, muscle strength, muscle explosiveness, agility, speed, besides that, although the required components are the same, the minimum requirement (passing grade) norms in each component in each sport are also different<sup>7</sup>

In another journal, Tarung Derajat self-exercise requires a contribution from the movement of the feet, hands and head that is carried out whether the lower body members (lower extremity) or upper limbs (upper extremities), by paying attention to elements, namely endurance, strength, speed, accuracy, courage and resilience<sup>8</sup>. According to the results of observations

and focus group discussions in August 2019, in the anthropometric element of degree fighting martial arts, the mastery of fighting techniques is supported by body structures, such as height, weight, leg length and arm length. The resource person also said that the body structure possessed by an athlete affects every movement in fighting. Athletes who have a good body structure will be able to move well, on the other hand athletes who have a poor body structure will find it difficult to move well in sports martial arts Tarung Derajat. The development of psychological aspects such as the development of intelligence, personality, motivation, behavior, attitudes, feelings, emotions, aspirations also affects the performance of Tarung Derajat athletes. The development of body structure, physical abilities, and psychologically gifted athletes together function in the maximum performance of Grade Fighting athletes.

The diversity of components in each sport is a discussion that needs to be addressed by sports experts, so that there can be no mistakes in determining potential athletes who have the talent to improve sports performance in Indonesia, including relatively new sports such as the Tarung Derajat sport. is an original Indonesian martial arts sport so that it is able to develop and excel in the international arena. In addition, based on the observation that the lack of literature on the sport of Tarung Derajat is also an obstacle experienced in determining potential athletes in increasing achievement, it also impacts on the lack of knowledge of athletes and coaches' knowledge of Tarung Derajat sports development. The lack of literature, research results, articles, journals and books about Tarung Derajat also affects the development of Tarung Derajat to be recognized by the public both nationally and internationally<sup>9</sup>.

The final result of this research is in the form of a guide book for scouting the talents of Tarung Derajat athletes which contains items of psychological, anthropometric and biomotor test instruments, as well as test procedures, scoring guidelines for measurement results, interpretation of scoring results with standardized standardized assessment norms for athletes in the Tarung Derajat sport. . The instrument model for scouting the talents of Tarung Derajat athletes was developed with several assumptions, namely:

1. This research is the first step in developing a model of a talent scouting test instrument in the Tarung Derajat sport, because it is not yet available and the sport is relatively new.



2. To assist Tarung Derajat sports coaches and coaches in recruiting or selecting talented athletes by using a science and technology approach so as to obtain the right data or information.

The purpose of this research is expected to produce a product in the form of a talent scouting test model for the Tarung Derajat sport. Specifically, this research aims to:

1. Develop a model of the Tarung Derajat athlete scouting test instrument model.
2. Analyze the assessment of the talent scouting test which consists of the following stages: 1) determine the criteria for a good test, 2) analyze sports, 3) see the literature, 4) determine the test items, 5) complete the test instructions, 6) discuss with experts, 7) trials, 8) determine validity, reliability, and objectivity, 9) compile test norms, and 10) compile test guidelines to identify talented athletes in the Tarung Derajat sport.
3. Predicting the model of the Tarung Derajat sports talent scouting test instrument.

### Method

Research on the instrument model of the talent scouting test for Tarung Derajat athletes produces a product in the form of a selection guide for Tarung Derajat athletes in the form of scoring results from anthropometric measurements (weight, height, arm length, leg length, sitting and standing height), biomotor (strength, endurance, speed, power, agility and flexibility) and psychological tests, as well as the norms for assessing the potential of a Talented Talent athlete<sup>11</sup>. The scoring norm is the standard value or the lowest score that a Tarung Derajat athlete must have. Psychological measurements are analyzed with the dominant factors of psychological conditions that must be possessed by talented Tarung Derajat athletes when going to and are competing, then anthropometric measurements are analyzed with anthropometric dominant factors which include height, weight, body mass index (BMI), thickness of body fat, and pressure. blood owned by Tarung Derajat athletes, while biomotor measurements were analyzed with the dominant factors of physical condition ability and motor skills possessed by Tarung Derajat athletes<sup>12</sup>.

In accordance with the research objectives that have been formulated, the design used in this study is research

and development. This research and development design follows the path developed which is based on a 4-D model consisting of of the 4 development stages namely Define, Design, Develop, and Disseminate. The basis for consideration of the type of research and development is used because to create a standardized and standardized model of the talent scouting test instrument in the Fighting Degree sport. Research and development designs were also chosen because they were oriented towards product novelty, not only emphasizing the test items, but also regarding test norms, procedures and processes, the content of which was in accordance with the characteristics in the field, so that products could be used easily, clearly, practically, safely., and is useful and effective to assist coaches in finding superior seeds in the Tarung Derajat sport<sup>13</sup>.

The research and development procedure in this study is in accordance with the flow namely the 4-D development model (Four D Models). The development flow consists of 4 main stages of development, namely Define, Design, Develop, and Disseminate, or adapted into the 4-P model, namely definition, design, development, and distribution. The application of the main steps in the study is not only tracing the original version but according to the characteristics of the subject and the place of origin of the examinee. In addition, the model to be followed will be adjusted to the needs of development in the field. In the define stage, it is carried out with an initial analysis, namely a needs analysis in the field, at this stage a Focus Group Discussion (FGD) is carried out with experts, practitioners and coaches with a focus on the problem of achievement in the Tarung Derajat sport with the main problem of analyzing the problem of scouting talent in the branch. Tarung Derajat sports, analysis of the needs for superior seeds of Tarung Derajat athletes and concept analysis and formulating the goals of making the Tarung Derajat sports talent scouting test instrument. At this stage the analysis refers to literature study, factual observations, and analysis of dominance factors from branch achievement Tarung Derajat sport<sup>14</sup>.

At the design stage, the preparation of instruments was carried out, analysis of the dominance of biomotor and anthropometrics in the Tarung Derajat sport, analysis of test items, analysis of test norms, selection of test procedure format and initial product design. Furthermore, the development stage in this study includes consultation on the initial product design to the supervisor, the stage of expert assessment and validation,

testing the product model of the Tarung Derajat talent scouting test instrument, and testing its effectiveness. The last stage, namely disseminate, is the stage of using the Tarung Derajat sports talent scouting test instrument model that has been developed on a broader scale in Tarung Derajat in Indonesia<sup>15</sup>.

The data sources in this study consisted of primary data and secondary data. Primary data were obtained from the analysis process of biomotor, anthropometric and psychological tests, input from several experts related to products and observations of the results of measuring the athlete's ability in both aspects while secondary data was obtained from data collection in the form of data analysis and documentation studies. The subjects of research and development of the Tarung Derajat sports talent scouting test instrument were 150 Tarung Derajat athletes registered in Central Java, totaling 150 people aged 10-14 years. The instrument in this study used theoretical instruments consisting of psychological tests and practical instruments consisting of anthropometric measurements and biomotor tests. Practical instruments use supporting media in the form of scales, meters, tape, cones, whistles, large and small bags, stopwatches, cameras and notebooks. All of these research instruments contain research focus and indicators to analyze the biomotor and anthropometric ability factors that seem to be contained in the problem formulation in this research<sup>16</sup>.

To obtain primary data in this study, 2 types of data collection techniques were used, namely: 1) Biomotor and anthropometric measurement tests for Tarung Derajat athletes, psychological tests, 2) direct observations, and 3) FGD (Focus Group Discussion). Data collection techniques in FGD were conducted. as an expert assessment of the Tarung Derajat athlete scouting test instrument model using a Likert scale questionnaire sheet instrument with assessment indicators, namely 1) content substance factors (whether or not appropriate to the characteristics of Tarung Derajat athletes, and 2) implementation factors (convenience, safety, clarity, practicality, effectiveness and benefits)<sup>17</sup>.

Respondents in this study to validate the product model of the talent scouting test instrument for Tarung Derajat athletes consisted of Dr. Taufik Hidayah M.Kes, Drs. Sri Haryono M.Or and Donny Wirayudha M.Pd., P.hD, and Main Trainers of Central Universities Drs. H. Heru Hermawan, Central Java Tarung Derajat Expert, Drs. R. Arif Agung Wiranata S.H. and the main

trainer of Tarung Derajat Central Java, Madi Sudrajat S.H. Checking the validity of the research data was carried out by previously preparing the test items based on predetermined indicators for test development. The preparation of the test items is accompanied by the preparation of a standard test implementation or procedure and how to evaluate it. Followed by an expert judgment on the indicators and item arrangement of the Tarung Derajat athlete scouting test instrument, each variable based on standard test implementation procedures.

At the design stage, the preparation of instruments was carried out, analysis of the dominance of biomotor and anthropometrics in the Tarung Derajat sport, analysis of test items, analysis of test norms, selection of test procedure format and initial product design. Furthermore, the development stage in this study includes consultation on the initial product design to the supervisor, the stage of expert assessment and validation, testing the product model of the Tarung Derajat talent scouting test instrument, and testing its effectiveness. The last stage, namely disseminate, is the stage of using the Tarung Derajat sports talent scouting test instrument model that has been developed on a broader scale in Tarung Derajat in Indonesia<sup>18</sup>.

The data sources in this study consisted of primary data and secondary data. Primary data were obtained from the analysis process of biomotor, anthropometric and psychological tests, input from several experts related to products and observations of the results of measuring the athlete's ability in both aspects. while secondary data was obtained from data collection in the form of data analysis and documentation studies. The subjects of research and development of the Tarung Derajat sports talent scouting test instrument were 150 Tarung Derajat athletes registered in Central Java, totaling 150 people aged 10-14 years. The instrument in this study used theoretical instruments consisting of psychological tests and practical instruments consisting of anthropometric measurements and biomotor tests. Practical instruments use supporting media in the form of scales, meters, tape, cones, whistles, large and small bags, stopwatches, cameras and notebooks. All of these research instruments contain research focus and indicators to analyze the biomotor and anthropometric ability factors that seem to be contained in the problem formulation in this research<sup>19</sup>.

To obtain primary data in this study, 2 types of

data collection techniques were used, namely: 1) Biomotor and anthropometric measurement tests for Tarung Derajat athletes, psychological tests, 2) direct observations, and 3) FGD (Focus Group Discussion). Data collection techniques in FGD were conducted. as an expert assessment of the Tarung Derajat athlete scouting test instrument model using a Likert scale questionnaire sheet instrument with assessment indicators, namely 1) content substance factors (whether or not appropriate to the characteristics of Tarung Derajat athletes, and 2) implementation factors (convenience, safety, clarity, practicality, effectiveness and benefits)<sup>20</sup>.

Respondents in this study to validate the product model of the talent scouting test instrument for Tarung Derajat athletes consisted of Dr. Taufik Hidayah M.Kes, Drs. Sri Haryono M.Or and Donny Wirayudha M.Pd., P.hD, and Main Trainers of Central Universities Drs. H. Heru Hermawan, Central Java Tarung Derajat Expert, Drs. R. Arif Agung Wiranata S.H. and the main trainer of Tarung Derajat Central Java, Madi Sudrajat S.H. Checking the validity of the research data was carried out by previously preparing the test items based on predetermined indicators for test development. The preparation of the test items is accompanied by the preparation of a standard test implementation or procedure and how to evaluate it. Followed by an expert judgment on the indicators and item arrangement of the Tarung Derajat athlete scouting test instrument, each variable based on standard test implementation procedures.

## Results and Discussion

Various studies on talent scouting in martial arts have been widely conducted. Researchers have conducted several searches on the research that has been carried out that have relevance to the theme raised by the researcher. This is done, among others, so that researchers have a critical understanding and provide information on the differences and linkages of research being carried out by researchers. Young judo athletes consider criteria such as physical condition and body coordination in each of their technical skills so that the determination of training levels can be chosen appropriately according to the abilities possessed by individuals<sup>21</sup>. Selection tests must be carried out through a sports training organization. Children's sports talents must pay attention to differences in test items that must be carried out such as tests of technical skills, motor skills and morphological characteristics in a set of sports choices<sup>22</sup>. The physical

test model which is valid and reliable for breeding and coaching prospective badminton athletes consists of 7 forms of physical tests, namely: (1) sit and reach test; (2) speed test (sprint 30 m); (3) leg muscle power test (vertical jump); (4) agility test (running 4 corners); (5) arm muscle power test (throwing a 2 kg medicine ball); (6) reaction test (step test); (7) endurance test (running distance of 600 meters). Reliability test results obtained (a) flexibility test (sit and reach) 0.743; (b) speed test (30 m run) 0.844; (c) leg muscle power test (vertical jump) 0.663; (d) agility test (running 4 corners) 0.848; (e) arm muscle power test (throwing ball) 0.943; (f) reaction test (step test) 0.987; (g) endurance test (600 m running) 0.861. The test is feasible to use in Indonesia because it meets valid, reliable, and objective requirements. (b) The criteria for athletes based on the physical test model are athletes who have a very good average total score. The test model prepared is in accordance with the characteristics of child growth and development based on discussions with expert judgment. The test is able to classify athletes according to their potential. Potential athletes are grouped based on the established test norms. Abbott (2007). In scouting talent, psychological factors in athletes are also very important because they relate to the way an athlete behaves when and will compete in the arena. The surrounding environmental conditions will have a big effect on his appearance when competing.<sup>23</sup>

Based on the explanation of the literature review above, it can be concluded that the psychological, anthropometric, and biomotor conditions in the scouting of athletic talent are the dominant elements that must be a requirement to be identified. Each sport has a predominance of different psychological, anthropometric, and biomotor components to support high-achieving athletes, therefore the procedure for testing and measuring talent scouting must be carried out systematically and according to the needs needed to identify individual talents. Before making a test, things that must be considered are (1) reference criteria for norms and measurements that must be used and (2) must have good test criteria. The test in question is a test that meets the requirements of validity, reliability, objectivity, discrimination, and reliability.

Tarung Derajat sport is an art of rapid reaction self-provess that learns and trains techniques, tactics and strategies for movement, hands, fists and other body parts practically and effectively in defense and attack training patterns and forms, with the ability of muscles, brain and conscience in order to master a self-defense that contains

5 (five) elements of a unique movement force, namely: strength, speed, accuracy, courage and tenacity<sup>24</sup>. The Tarung Derajat martial arts sport was initiated on July 18, 1972 which is a work created by an Indonesian son, Guru Haji Achmad Dradjat, who has the nickname AA BOXER. This sport was born as a self-contained martial art that has its own flow and forum, is not affiliated with other sects and other martial arts organizations, both those existing in Indonesia and those outside the State of Indonesia and it is also emphasized that the Tarung Derajo sport does not adopt and is not a combination of other martial arts and does not appear by itself, but has a historical origin and a personal source of life that comes from the greatness and majesty of God Almighty as the only essential element and is very influential in shaping "Human identity. as well as the identity of something else "according to His will. Attending Tarung Derajat since it has become a demand as a learning process in the demands of training at the community level, the Central College or operation in the Training Unit (Satlat) must have an outline of learning as the core basis of demands pock ulum. As the core curriculum of Tarung Derajat, a systematic training material has been arranged in stages (kurata) starting from curve I to curve VII and level<sup>25</sup>.

#### **Competition Rules in the Tarung Derajat Sports**

**Branch:** In a competition, each sport has its own rules so that the match can run well or the term in sports is called fair play. In the Tarung Derajat sport itself, the rules that apply are for every technique used in the match, because the technical rules are enforced so as not to get out of the rules in the Tarung Derajat sport. Some of the techniques that are regulated, namely in the hand technique, all strokes learned in Tarung Derajat may be used, including 1) a quick hit, 2) a circle strike, 3) a fist hit and 4) a jolt. Another hand technique that is allowed is the hand drop technique.

Whereas the foot technique is used in two functions, namely kicks and drops (to withstand the opponent's attack). The kicks allowed to be used in combat are 1) inner and outer ring kicks, 2) side kicks, 3) back kicks, 4) front hook kicks, 5) back hook kicks and 6) back curling kicks. All kicks can be used with the jumping technique. The target application of the attack starting from the waist (belt) and above will be scored with the target direction of the front and sides of the body or head. The parts that are prohibited from being attacked are 1) around the groin, 2) behind the head and 3) behind the body. The imposition of targets outside the above provisions will receive a reduction in value and even be

expelled from the battle arena and declared defeated.

#### **Biomotor Dominant Factors in Tarung Derajat**

**Sports:** There are 7 aspects of physical or biomotor conditions that are dominant in Tarung Derajat sports, namely 1) abdominal muscle endurance, 2) abdominal muscle strength, 3) agility, 4) arm muscle endurance, 5) muscle explosiveness and 6) speed, and 7) flexibility. Based on the results of the research that has been done, it is concluded that male abdominal muscle strength is 60% in good category with 10 athletes, an average of 52.6 in moderate category. The strength of the abdominal muscles for women was 100% in the moderate category with 5 athletes, the average was 42.6 in the moderate category. 50% of male togok flexibility with enough category with 10 athletes, an average of 14.45 categories is sufficient. Female togok flexibility is 60% less category with 5 athletes, average 14.48 category less<sup>26</sup>.

Male arm muscle endurance was 60% in good category with 10 athletes, with an average of 54.5 in good category. Female arm muscle endurance was 100% good category with 5 athletes, with an average of 58.4 good category. The endurance of male abdominal muscles is 70% very good category with 10 athletes, an average of 60.7 categories is very good. The endurance of women's abdominal muscles is 100% very good category with 5 athletes, an average of 55.6 very good categories. The male speed of 60% was in the good category with 10 athletes, an average of 4.37 seconds in the moderate category. 80% women's speed is in the very good category with 5 athletes, an average of 4.46 seconds is very good category. Agility of men was 40% in very good category and 40% in good category with 10 athletes, an average of 12.34 seconds in good category. Agility of women 60% very good category with 5 athletes, an average of 12.79 seconds in good category. Male VO2 Max was 60% in moderate category with 10 athletes, the average was 53.61 in moderate category. Female VO2 Max test was 60% in good category with 10 athletes, an average of 51.59 in good category.

Tarung Derajat is an aggressive and dynamic martial art in the forms of punching, kicking, blocking, and avoiding movements. Physical conditions greatly affect the performance of athletes when competing, where Tarung Derajat is a full body contact martial arts sport in which every athlete requires maximum physical condition. These seven aspects are the dominant biomotor components that every Tarung Derajat athlete must have. The role of abdominal muscle strength is very important

in every movement in the Tarung Derajat competition, including in the movement of the fight when making punches and kicks where the strength of the abdominal muscles plays a role in maintaining body balance and as a support for other limbs, because when hitting and kicking the body must be in a balanced condition. In a Tarung degree, flexibility is a combination of punch and kick movements, where flexibility of the legs will be very affective in kicking maximally. In the Tarung Derajat competition, good endurance ability of the arm muscles is also needed to carry out the hitting motion for a long time. By having good muscle endurance ability, the hitting movement will be stable in fighting and will be maximized<sup>27</sup>

Other elements of the dominant biomtoric component are also found in the endurance of the abdominal muscles. The movements in Tarung Derajat combat are dynamic movements, in which the punching and kicking movements must be combined. Therefore, the body must have a level of endurance and balance for a long time when fighting, and it will support the body to be more balanced and keep the body standing firmly. In addition, in the Tarung Derajat sport, it must have good speed, because a fighter who has good speed will be able to make punches and kicks with high speed towards the opponent and will also make it easier to make fighting steps. So that speed is the main physical component in the physical condition of Tarung Derajat. Furthermore, in Tarung Derajat, the ability to move is a priority, one of which is the ability in agility, because in fighting, movements are always combined both hitting and kicking with continuous flow. By having good agility, the ability to move in a fight is also more optimal and varied. Finally, VO2Max is also an important asset for Tarung Derajat, because a good VO2Max is also one of the main basic assets for a fighter to do long activities without causing fatigue which means in other words aerobic endurance (endurance aerobic). In a Tarung Derajat match there are 3 rounds in each round for 3 minutes (3 x 3 minutes), requiring the fighter to always be in good endurance.

**Punching Techniques in Fighting Degrees When Competing:** The effectiveness of a hit is a compound of strength (stomp), speed (burst), and accuracy (point of aim). The last two movements, pulling the arm and returning to the alert position, are carried out to carry out a follow-up attack or anticipate the opponent's movement. As mentioned above, since the accuracy of the hit is determined by the "arm shot," the line formed

from the base of the arm and fist must be firmly aimed at the point of target. for example the target point on the face is the point between the eyes, eyes, nose, chin, ears and neck. The shape of the existing target point is adjusted to the hit point. The tip of the fist that has an elongated contact point is suitable for use for similar target points, for example in the eyes, nose, temples, ears and jaws to reach the target point on the face which is relatively difficult, it requires good and correct practice.

## Conclusion

Physical conditions greatly affect the performance of athletes when competing, where Tarung Derajat is a full body contact martial arts sport in which every athlete requires maximum physical condition. These seven aspects are the dominant biomotor components that every Tarung Derajat athlete must have. The role of abdominal muscle strength is very important in every movement in the Tarung Derajat competition, including in the movement of the fight when making punches and kicks where the strength of the abdominal muscles plays a role in maintaining body balance and as a support for other limbs, because when hitting and kicking the body must be in a balanced condition. In a Tarung degree, flexibility is a combination of punch and kick movements, where flexibility of the legs will be very affective in kicking maximally. In the Tarung Derajat competition, good endurance ability of the arm muscles is also needed to carry out the hitting motion for a long time. By having a good muscle endurance ability, the hitting movement will be stable in fighting will be maximized. Another dominant biomoral component is also found in the endurance of the abdominal muscles, the movements in Tarung Derajat combat are dynamic movements, where the hitting motion and kicking must be combined. Therefore, the body must have a level of endurance and balance for a long time when fighting, and it will support the body to be more balanced and keep the body standing firmly. In addition, in the Tarung Derajat sport, it must have good speed, because a fighter who has good speed will be able to make punches and kicks with high speed towards the opponent and will also make it easier to make fighting steps. So that speed is the main physical component in the physical condition of Tarung Derajat. Furthermore, in Tarung Derajat, the ability to move is a priority, one of which is the ability in agility, because in fighting, movements are always combined both hitting and kicking with continuous flow. The model of the talent scouting instrument model for Tarung Derajat athletes has limitations in development

such as the subject for which the data is taken is only in the province of Central Java, therefore it needs to be developed with a wider sample nationally. The limitations of the development of the Tarung Derajat athlete scouting test instrument model only cover the psychological, anthropometric and biomotor areas, not to the aspects of measuring basic techniques and strategies to compete in athletes or the broader scope of talent scouting.

**Conflict of Interest:** None to declare

**Source of Funding:** Self

**Ethical Clearance:** Institutional Ethics Committee clearance obtained.

### References

- Abbott, A., Button, C., Pepping, G. J., & Collins, D. "Unnatural Selection: Talent Identification And Development In Sport". *Nonlinear Dynamics, Psychology, And Life Sciences*. 2005.9(1): 61-88.
- Abbott, A., & Collins, D. "Eliminating The Dichotomy Between Theory and Practice in Talent Identification and Development: Considering The Role of Psychology". *Journal of Sports Sciences*. 2004.22(5): 395-408.
- Anggraeni, Y. 2013. "Kontribusi IQ (intelligent quotient) dan EQ (emotional quotient) Terhadap Prestasi Atlet Pelatda Pencaksilat Pada PONke-XVIII Tahun 2012". *Jurnal Phederal Penjas*, 1(1): 1-23.
- Anshel, M.H., & Lidor, R. "Talent Detection Programs in Sport: The Questionable Use of Psychological Measures". *Journal of Sport Behavior*. 2012.35(3): 239-266.
- Australian Sports Commission, Sports Search. National Sports Information. Canberra, Australia. 2005.
- Baker, J., Cobley, S., & Schorer, J. "Talent Identification and Development in Sport: International Perspectives". *International Journal of Sports Science & Coaching*. 2012. .7(1): 177-180.
- Baker, J., Horton, S., Robertson-Wilson, J., & Wall, M. "Nurturing Sport Expertise: Factors Influencing The Development Of Elite Athlete". *Journal Of Sports Science & Medicine*. 2003.2(1):1-9.
- Baumgartner, T.A. *Measurement for Evaluation and Physical Education & Exercise Science*. New York: The McGraw-Hill Companies Inc.2007.
- Bompa, O.T. *Periodization Theory and Methodology of Training*. 2009. Jakarta: UNJ.
- Bompa, T.O. *Theory and Methodology of Training*. Dubuque, Kendal/Hunt:1990. Pub.Company.
- Bompa, T.O. *Theory and Methodology of Training; the Key to Athletic Training*. Champaign: Human Kinetics.1994.
- Bramantha, H. "Identifikasi Bakat Olahraga dengan Menggunakan Metode Sport Search Pada Siswa Putra Kelas V SDN 3 Mangaran Kabupaten Situbondo". *CERMIN: Jurnal Penelitian*. 2018. 1(2): 30-35.
- Brilin, A.S.S.E.W. & Iskandar, H. "Pengukuran Anthropometri Terhadap Status Kondisi Fisik Mahasiswa PJKR UNTAD". *Tadulako Journal Sport Sciences and Physical Education*. 7(2): 87-100.
- Burgess, D.J & Naughton, G.A. "Talent Development in Adolescent Team Sport. A Review". *International Journal of Sport Physiology and Performance*. 2010. 5(2): 103-116.
- Collings, D.G., & Mellahi, K. "Strategic Talent Management: A Review and Research Agenda". *Human Resource Management Review*. 2009.19(4): 304-313.
- Dewi, P.C.P. "Analisis Komponen Biomotorik Pada Olahraga Permainan Woodball". *Jurnal Pendidikan Kesehatan Rekreasi*. 2016.1(2):81-87.
- Direktorat Jenderal Olahraga. *Pemanduan Bakat*. Jakarta: Ditjen Olahraga. 2003.
- Drajat, A. 2000. *Tarung Derajat, Mortal Ghada*. Bandung.
- Effendi, H. "Peran Psikologi Olahraga dalam Meningkatkan Prestasi Atlet". *Nusantara: Jurnal Ilmu Pengetahuan Sosial*. 2016. .1(1): 23-30.
- Fenanlampir, A., & Faruq, M.M. *Tes dan Pengukuran dalam Olahraga*. Yogyakarta: CV. Andi Offset.
- Gonçalves, C. E., Rama, L. M., & Figueiredo, A. B. "Talent Identification and Specialization in Sport: An Overview of Some Unanswered Questions". *International Journal of Sports Physiology and Performance*. 20127(4): 390-393.
- Green, B.C. "Building Sport Programs to Optimize Athlete Recruitment, Retention, and Transition:

- Toward a Normative Theory of Sport Development. *Journal of Sport Management*. 2005. 19(3): 233-253.
23. Hambali., Syamsulrizal., & Ifwandi.. “Komponen Mendasar Kondisi Fisik Atlet Tarung Derajat Kota Banda Aceh”. *Jurnal Ilmiah Pendidikan Jasmani, Kesehatan dan Rekreasi*. 2015.1 (2): 121-132.
  24. Harre, D..*Principles of Sports Training*. 1982. Berlin: Sportverlag.
  25. Iqroni, D. “Model Tes Keterampilan Dasardan Kondisi Fisik Untuk Mengidentifikasi Bakat Calon Atlet Bolabasket. *Cerdas Sifa Pendidikan*. 2015.1(1): 55-67.
  26. Ismaryati. 2006. *Tes dan Pengukuran Olahraga*. Surakarta: UNS Press.
  27. Jess, M., Dewar, K. & Fraser, G. “Basic Moves, Developing a Foundation for Lifelong Physical Activity. *The British Journal of Teaching Physical Education*. 2004. .35(2): 23-27.

# The Effect of Health Services, Supervisory and Team Orientation, Personnel Development and Tolerance of Error on Job Satisfaction Head of Health Centre in South Sulawesi Province

Wardiah Hamzah<sup>1,2</sup>, Suryanto<sup>3</sup>, Oedojo<sup>4</sup>, Sukri Palutturi<sup>5</sup>, Nasruddin Syam<sup>2</sup>

<sup>1</sup>Doctoral Student in the Public Health Doctoral Program, Faculty of Public Health, Airlangga University, Surabaya, Indonesia, <sup>2</sup>Lecturer in the Faculty of Public Health, Universitas Muslim Indonesia, Makassar, Indonesia, <sup>3</sup>Lecturer in the Faculty of Psikology, Airlangga University, Surabaya, Indonesia, <sup>4</sup>Lecturer in the Faculty of Public Health, Airlangga University, Surabaya, Indonesia, <sup>5</sup>Lecturer in the Faculty of Public Health, Hasanuddin University, Makassar, Indonesia

## Abstract

**Introduction:** The Head of the Health Centre in carrying out his duties as the leader of the Health Centre has a health services, supervisory and team orientation, personnel development and tolerance of error that supports Health Centre employees in providing maximum health services so as to create job satisfaction within the Health Centre Head.

**Method:** Survey research with cross sectional study design conducted in a period of 3 months in the province of South Sulawesi. Samples were taken based on proportional random sampling with a total of 164 samples from 458 Health Centre heads in South Sulawesi. Data were collected by filling out the health services, supervisory and team orientation, personnel development and tolerance of error and job satisfaction.

**Results:** Health services have a significant effect on job satisfaction of the head of the Health Centre ( $p = 0.004$ ). Likewise, supervisory and team orientation significantly affected job satisfaction ( $p = 0.000$ ). Personal development also significantly affects job satisfaction ( $p = 0.001$ ). The tolerance of error significantly affects the job satisfaction of the head of the Health Centre in South Sulawesi ( $p=0.044$ ).

**Conclusion:** There is a significant influence on Health services, Supervisory and team orientation, Personal development and Tolerance of error toward job satisfaction at the head of the Health Centre.

**Keywords:** *Job satisfaction, health services, supervisory and team orientation, personnel development and tolerance of error.*

## Introduction

The quality of health services is measured by the criteria of organizational performance and the

performance of health workers. So that the quality of Health Centre services can be guaranteed, the minister of health issues Ministry of Health No. 46 of 2015 concerning Health Centre accreditation. Health Centre accreditation aims to foster improvement in the quality of performance through continuous improvement of the management system, service delivery system and programs and the application of risk management<sup>1</sup>.

Health Centre that have been accredited in 2017 in Indonesia were 4,223 (42.98%) Health Centre from

---

### Corresponding Author:

#### Suryanto

Lecturer in the Faculty of Psikology, Airlangga University, Surabaya, Indonesia  
e-mail: suryanto@psikologi.unair.ac.id



9,825 Health Centre, while in South Sulawesi Province there were 271 (60.08%) Health Centre that had been accredited from 451 Health Centre in 2017<sup>2</sup>. One standard assessment instrument in Health Centre accreditation is Health Centre leadership and management, where quality improvement is a task that must be carried out by Health Centre leaders. The Head of the Health Centre functions as a manager who carries out managerial functions ranging from planning, organizing, implementing activities, monitoring to evaluating all activities at the Health Centre<sup>3</sup>.

The status of Health Centre accreditation describes the level of Health Centre performance and the Health Centre head as the Health Centre leader. Research Bakan, *et al.*, (2014)<sup>4</sup>, that job satisfaction has a positive effect on work performance and commitment. The higher the job satisfaction of a person, the more the performance results. This study is further strengthened by the findings of Inuwa, M<sup>5</sup>, finding a positive and significant relationship between job satisfaction and performance

Job satisfaction is the extent to which individuals feel positive or negative about their work. It is an emotional response to one's duties, as well as the physical and social conditions of the workplace. In concept, job satisfaction also shows the extent to which expectations in one's psychological contract are fulfilled<sup>6</sup>. Therefore, job satisfaction is the final attitude or feeling that the head of the Health Centre has towards the job as the head of the Health Centre .

Supervision and guidance efforts that are still lacking by the head of the Health Centre and the career development efforts of Health Centre employees, which are relevant to supportive leadership practices. Supportive leadership practice is a leadership style that focuses on the concerns, needs and welfare of employees<sup>7</sup>. Where employees can work well so that organizational goals can be met. Supportive leadership practice is directly related to job satisfaction,<sup>7,8,9,10</sup>. This shows that high supportive leadership practices will increase jobs satisfaction of the head of the Health Centre which will have a high performance impact. Supportive leadership practices consisting of Supervisory and team orientation, Personal development and Tolerance of error.

## Materials and Method

This is a survey research with cross sectional study design model that was carried out in 24 districts/cities in South Sulawesi Province. The population of this study were all active Health Centre heads working in South Sulawesi Province when the study was conducted. The total population was 458 people. Samples for each district/city were taken based on proportional random sampling with a sample size comprised 164 samples based.

This study uses 3 independent variables namely (1) Health services, (2) Supervisory and team orientation, (3) personnel development (4) tolerance of error . The dependent variables of the study, is job satisfaction which consist of several (indicators, namely: job security, recognition, social environment and adequacy of authority).

## Results

### Characteristics of Respondents:

**Table 1. Characteristics of Respondents**

Characteristics		Category	n	%
Health Centre	Category of Puskeesmas	Urban	53	32,3
		Rural	72	43,9
		Remote	32	19,5
		Very Remote	7	4,3
	Status of akreditasi	Non Akreditasi	14	8,5
		Dasar	50	30,5
		Madya	86	52,4
		Utama	13	7,9
Paripurna		1	0,6	

Characteristics		Category	n	%
Head of Health Centre	Age	30 – 39 years	33	20,1
		40 – 49 years	82	50,0
		≥ 50 years	49	29,9
	Gender	Male	86	52,4
		Famale	78	47,6
	Education Level	Diplome	5	3,0
		Bahelor	101	61,6
		Magister	58	35,4
	Work period	≤ 10 years	31	18,9
		11 – 20 years	58	35,4
		21 – 30 years	64	39,0
		≥ 31 years	11	6,7

**Statistical Analysis Results:** Liner regression test is used to analyze the effect of Health services, Supportive Leadership Practices, Supervisory and team orientation

and Organizational emphasis on personnel development on Job Satisfaction. The results are as follows:

**a. Simulant Test (F Test)**

**Table 2. Statistical Analysis Result (F Test)**

Model	Sum of Squares	df	Mean Square	F	Sig
Regression	2433.135	3	811.045	20.700	0.000
Residual	6268.816	160	39.180		
Total	8701.951	163			

**b. Partial Test (T Test):**

**Table 3. Statistical Analysis Result (T test)**

Model	Unstandardized Coefficients		Standardized Coefficients	t	Sig.
	B	Std. Error	Beta		
(Constant)	59.656	2.759		21.625	0.000
Heath Services	0.045	0.063	0,245	3.445	0,004
Supervisory and Team Orientation	0.361	0.073	0.394	4.933	0.000
Personel development	0.420	0.126	0.281	3.339	0.001
Tolerance of Error	-0.620	0.306	-0.160	-2.031	0.044

**Discussion**

**Health Centre Characteristics:** The most Health Centre category was in the rural category at 43.9% and the least was in the very remote category at 4.3%. This shows that the category of Health Centre in South Sulawesi is mostly distributed in rural areas and a small proportion of the category of Health Centre in very remote areas.

The highest Health Centre accreditation status was in the madya category as much as 52.4%, while

for the Paripurna category it was 0.6% which was the lowest distribution for the Health Centre accreditation status. Based on this, it can be concluded that the Health Centre accreditation status needs to be upgraded to the Paripurna category.

**Responden Characteristics:** The age of the head of the Health Centre was mostly in the age group of 40-49 years at 50.0%, 52.4% were male and Bahelor education level of 61.6%. The working period of the head of the Health Centre is at most in the 21-30 year category.

**Influence** Health services, Supervisory and team orientation, Personal development and Tolerance of error **toward Job Satisfaction**

- a. Health services:** Health services in this study are the extent to which the head of the Health Centre does the planning in improving health services at the Health Centre . The results of the study found that there was an effect of health services on the job satisfaction of the head of the health center (0.004).

The head of the Health Centre provides input and makes improvements to the program planning that has been made by the person in charge of the program. The programs/activities in the Health Centre are based on Permenkes No. 43 of 2016 regarding the minimum service standards in the health sector which consist of individual health efforts and community health efforts. To improve public health status, each Health Centre has one development health effort, but sometimes the district/city health office wants all development health efforts to be carried out at the Health Centre .

- b. Supervisory and Team Orientation:** Supervisory and team orientation in this study is the extent to which the Head of Health Centre supervises team performance including freedom of work, task supervision and team collaboration. The results showed that there was a significant effect of supervisory and team orientation on job satisfaction ( $p = 0,000$ )

Supervisory and team orientation such as task supervision affects job satisfaction, Health Centre heads are satisfied with their work in terms of supervising every task of Health Centre employees. The supervisory function carried out by the head of the Health Centre starts from planning activities, implementing activities to evaluating activities. The supervision of the head of the Health Centre on the activities in the Health Centre is that all activities do not fall outside the goal of the Health Centre as the spearhead of health services in the community.

According to Roades & Eisenberger (2002)<sup>13</sup>, supervisory support refers to the behavior of supervisors in helping employees to demonstrate their skills, knowledge and attitudes. In this case, the supervision carried out by the head of the Health Centre on the work behavior of Health Centre employees encourages employees to demonstrate their skills and knowledge in providing health

services. Without supervision, employees tend to lose focus at work. Thus, Health Centre staff need supervision from the head of the Health Centre, so that they can provide maximum health services.

- c. Personnel Development:** Personnel development is the extent to which the Head of the Health Centre helps Health Centre employees develop their talents and abilities, including education, training and seminars. The results showed that there was a significant influence of personnel development on job satisfaction ( $p = 0.001$ )

Personnel development also affects the job satisfaction of the head of the Health Centre <sup>14</sup>, in the form of including Health Centre employees in seminars that support their competence. The head of the Health Centre is satisfied, if he can include Health Centre staff in seminars that help improve their abilities, in implementing health services at the Health Centre . Training can help Health Centre employees improve their skills and knowledge. In addition, local government regulations in several districts/cities require Health Centre employees to attend training with a frequency of one training each year, for the development of employee competencies.

The Head of the Health Centre in proposing Health Centre staff to take part in training based on an analysis of personnel needs, by looking at the competence of existing personnel. The head of the Health Centre proposes to the district/city health office, then the proposal will be followed up based on the availability of the budget. In addition to the training proposal from the head of the Health Centre, the district/city health office can directly appoint Health Centre staff who will take part in the training based on an analysis of the needs for personnel at the district/city level.

- d. Tolerance of Error:** Tolerance of error is the extent to which the Head of the Health Centre tolerates employees who make mistakes, including work errors, giving rewards and verbal warnings. The results of the linear regression test showed that there was a significant influence between tolerance of error on job satisfaction ( $p = 0.044$ ).

Rewards are given in the form of praise and support for the results achieved by Health Centre employees. The head of the Health Centre sends outstanding Health Centre employees by participating in the

selection of outstanding health staff at the district/city or provincial level, which is carried out annually by the district health office or the provincial health office.

Giving warnings to Health Centre employees who commit violations is carried out in stages, starting from an oral warning to a written warning. If the Health Centre staff does not respond to a written warning up to three times, the head of the Health Centre will delegate the problem to the district/city health office.

### Conclusion

Health services, Supervisory and team orientation, Personal development and Tolerance of error have a direct effect on the job satisfaction of the head of the Health Centre in South Sulawesi Province. Thus, it is recommended that the head of the Health Centre prioritize supportive leadership practices, particularly the interests and needs of Health Centre staff in encouraging career development through education, training and seminars. It is recommended to the head of the Health Centre in implementing supportive leadership practices, especially the tolerance of error variable to be wiser in giving warnings, while still paying attention to applicable regulations.

**Conflict of Interest:** There is no conflict interest for all author.

**Source of Funding:** This research funded by the authors themselves. No other financial support received

**Ethical Clearance:** All procedures performed in studies involving human participants were in accordance with the ethical standards of the Health Research Ethics Committee Universitas Muslim Indonesia and Ibnu Sina Hospital, number:185/A.1/KEPK-UMI/VIII/2019.

### References

1. Permenkes, RI. No 46 Tahun 2015. Akreditasi.
2. Kemenkes. Profil kesehatan Indonesia tahun 2018: Kementerian Kesehatan RI; 2019.
3. Rahana, Adila., Hargono, Rachmat. The Role of Health Centre in The Implementation of PHBS at SLB Alpa Kumara Wardana II. *Jurnal Promkes: The Indonesian Journal of Health Promotion and Health Education*. 2018; 6(1):59-69.
4. Bakan, Ismail., Buyukbese, Tuba., Ersahan, Burcu., Sezer, Buket. Effects of job satisfaction on job performance and occupational commitment. *International Journal of Management & Information Technology*. 2014;9(1):1472-80.
5. Inuwa, Mohammed. Job satisfaction and employee performance: An empirical approach. *The Millennium University Journal*. 2016;1(1):90-103.
6. Shermerhorn, Hunt. Osborn, (1991) *Managing Organizational Behavior*. John Wiley & Sons. Inc.
7. House, Robert J., Rizzo, John R. Role conflict and ambiguity as critical variables in a model of organizational behavior. *Organizational behavior and human performance*. 1972;7(3):467-505.
8. Newton, Cameron., Maierhofer, Naomi, editors. *Supportive leadership and well-being: the role of team-based value congruence. Past reflections, future directions: proceedings of the 40th Annual Conference of the Australian Psychological Society*; 2005: Australian Psychological Society.
9. Shin, Yuhjung., Oh, Won-Kyung., Sim, Chang-Hyun Sim., Lee, Jee-Young. A multilevel study of supportive leadership and individual work outcomes: The mediating roles of team cooperation, job satisfaction, and team commitment. *Journal of Applied Business Research (JABR)*. 2016;32(1):55-70.
10. Maurya, Mahesh Kumar., Agarwal, Manisha. Relationship between supportive leadership, mental health status and job satisfaction of civil police constables. *Journal of the Indian Academy of Applied Psychology*. 2015;41(3):103.
11. Luthans, Fred., Baack, Donald., Taylor, Lew. *Organizational commitment: Analysis of antecedents*. *Human relations*. 1987;40(4):219-35.
12. Sugito, Sugito., Suyitno, Y., Kuntoro, Kuntoro. Pengaruh Masa Kerja dan Motivasi Kerja terhadap Kinerja Guru Sekolah Dasar di Desa Samudra dan Samudra Kulon. *Dinamika Jurnal Ilmiah Pendidikan Dasar*. 2019;11(1):1-18.
13. Rhoades, Linda., Eisenberger, Robert. Perceived organizational support: a review of the literature. *Journal of applied psychology*. 2002;87(4):698.
14. Mubarak, Syahrul., Palutturi, Sukri., Zulkifli, Andi., Nuru, Hasanuddin. Factors Affecting Work Satisfaction of the Village Midwives at Sidenreng Rappang Regency, South Sulawesi Province, Indonesia. *International Journal of Health Sciences and Research (IJHSR)*. 2016;6(1):334-40.

# Basic Movement Standardization of the Pathol Sarang Martial Sport

Putra Budi Kutniawan<sup>1</sup>, Tandiyo Rahayu<sup>2</sup>, Heny Setyawati<sup>2</sup>, Mugiyo Hartono<sup>2</sup>

<sup>1</sup>Doctoral Student, Post Graduate Dept., Universitas Negeri Semarang, Indonesia,

<sup>2</sup>Lecture, Post Graduate Dept., Universitas Negeri Semarang, Indonesia

## Abstract

The purpose of this research is to make standardization of the basic movements of the pathol martial arts sport which is intended to identify the basic movements of the pathol martial arts by using logical science principles so that it can be used/played by everyone, then it can provide convenience in its development so that the traditional Pathol martial arts can be easily learned by the public. In general, the research approach used in this research is descriptive qualitative using a case study research design. This approach is used because the focus is on testing one phenomenon, namely the basic motion of the pathol nest martial arts. It takes careful preparation in determining participants, places, and data collection because this research is changing and developing according to changes in findings in the field. a place where researchers conduct research. This research was conducted in the coastal area of Sarang sub-district (Bajingjowo village, Temperak village, and Karangmangu village), which is the only area that still maintains the pathol nest martial arts. The focus of this research is to examine in depth the classification of the basic movements of pathol martial arts through identification and then analysis by paying attention to scientific principles that will produce standard pathol basic motion. This research is studied through philosophical studies, sociological studies, motor learning studies, sports biomechanics studies, and psychological studies. Standardization of the basic motion of the pathol is carried out by transforming the existing basic motion which is then developed to become a standard basic motion which is mutually agreed upon between the elders, midfielders, players and members of the pathol community so that it can be accepted by all levels.

**Keywords:** Basic Movement, PatholSarang, Self Defense.

## Introduction

Martial is derived from the word martial means to maintain or defend, while self means resting on the soles of the feet or it can also be interpreted physically or mentally. Martial arts can be interpreted as an effort to maintain survival, guard physically or mentally from external disturbances<sup>1</sup>. Martial arts are growing and developing throughout the world with each region having its own characteristics in its movements. The development of martial arts today is growing rapidly

with the number of martial arts that have become sports and are competed in sporting events at the SEA Games, Asian Games and Olympics. The Olympics are an important sports competition in the world. Martial arts such as boxing, judo, taekwondo, fencing, and wrestling account for 25 percent of all medals contested in the Olympics, and karate will be included in the Tokyo Olympics in 2020<sup>2</sup>. This does not mean that all martial arts are growing rapidly in various countries, there are still many traditional martial arts which is the national cultural heritage of each region that has not been known to the general public and even some have almost been eroded by time. The existence of traditional martial arts has begun to be eroded by the swift currents of modernization. The traditional martial arts is a marker of a different dimension, which is also a challenge for cultural elements and limited interactions between the imaginary and the body. Martial arts are examples of

---

### Corresponding Author:

**Putra Budi Kutniawan**

Doctoral Student, Post Graduate Dept., Universitas Negeri Semarang, Indonesia

e-mail: aguspurwanto.prof@gmail.com

body culture that are considered as collective symbolic assets, spread through several movement techniques and related to the habits of cultural or social groups. Martial arts combine uniqueness and adaptation with the cultural framework of a society, besides that it is a form of symbolic capital and a marker of values that are different from cultural legitimacy. Rembang Regency is one of the districts in Central Java, which is located on the north coast of Java Island and borders the province of East Java. Rembang Regency has a language, accent, and art which is a combination of the arts and customs of the provinces of Central Java and East Java. The majority of the people of Rembang Regency work as fishermen because it is a coastal area adjacent to the sea. One of the districts in Rembang district which is the largest producer of fish is the Sarang district<sup>3</sup>.

Sarang sub-district is one of the sub-districts in Rembang district which is located at the eastern tip of Central Java province and directly adjacent to East Java province. Sarang sub-district has a martial art which is a cultural heritage of Rembang district called pathol. Pathol used to be a traditional martial art that can be found throughout the coastal area from Rembang district to Lamongan district. As time goes by, pathol is currently only found in Sarang sub-district, so that pathol is better known as patholsarang. Pathol Sarang is a martial art similar to wrestling or sumo, which uses muscle strength to defeat its opponent. Patholsarang has a unique appearance that is not shared by other regions, namely the appearance of all male players. Until now, patholsarang function as entertainment, ritual means, performances and as an economic function<sup>4</sup>.

Pathol martial arts have survived to this day even though it has been crushed by the times. Based on the results of interviews with the elders of Patholbapak Sugiyanto on November 25, 2018, stated that beladiripathol is currently only performed in ritual events such as sea alms, anniversary events of Rembang district and events from the Tourism Office. Mr. Sugiyanto is one of the pathol elders who is also the principal of SD Negeri Temperak, Sarang sub-district, Rembang district. He plays an active role in preserving beladiripathol in order to survive and from generation to generation. Sugiyanto stated that the purpose of pathol today is different from the past. In the past, Pathol was used as a place to find the strongest warriors and a place to bet, but now Pathol aims to maintain its existence in order to survive amid the pressure of globalization. Pathol, which used to be scattered on the coasts of Central Java and East Java, is

now only left in the coastal areas of Sarang sub-district, this is due to the lack of elder figures who can pass on this martial art to their children and grandchildren. It was different from the Sarang sub-district which had an elder who was the strongest pathol at that time named Mbah Miran. MbahMiran together with mbah Imam Suwardi defended the pathol and eliminated the element of gambling by creating a “prisen” system in pathol. This system gave everyone who played Pathol the right to get prizes, both the winners and the losers with a ratio of the prizes that won were greater than the losers. This system can preserve beladiripathol until now in Sarang sub-district<sup>5</sup>.

Mbah Miran’s struggle in preserving pathol has been continued by Mr. Sugiyanto since 1990 by introducing pathol to the nation’s future generations by including it in extracurricular activities at SD Temperak, Sarang district. Pathol extracurricular activities still exist today, but they are still limited to SD Temperak and have not developed to other schools. This is due to limited time and energy in developing the teaching curriculum so that it cannot be developed by the related education office. The Ngudi Budoyo community provides pathol players to be featured in both government and private events. Ngudi Budoyo community members are pathol players who are always appointed to represent pathols, appearing in official and unofficial events, but in terms of activities this community does not have regular activities or meetings to discuss pathol conservation. This is because there has been no effort from the government to help preserve pathol. Until now, the local government has only made pathol as a routine display in every Rembang district anniversary event or other official events, the rest has not been given special attention to preserving either development or other efforts related to pathol preservation<sup>6</sup>.

The pathol martial arts played by the Ngudi Budoyo community are different from the pathol martial arts competed in sea alms events. Pathol martial arts by the NgudiBudoyo community emphasize the art of movement so that it is more beautiful to see because it is used for entertainment performances, while pathol martial arts at sea alms events use more technique and strength to beat opponents and become the strongest person. Pathol martial arts need to be developed for the preservation of the culture of Rembang district and Javanese coastal communities because culture contains elements of noble values that must be maintained and in the interest of the community at large. The current

condition of Pathol martial arts is decreasing and can only be found in Sarang sub-district, it takes efforts from various levels of society to the government, as quoted by the Ministry of Youth and Sports which states that traditional martial arts that are almost extinct must be developed and passed on to the nation's young generation, therefore the government central and regional as well as the community has an obligation to raise and re-develop traditional martial arts<sup>7</sup>

Pathol is a martial art that resembles wrestling using a belt. Several countries in the world also have traditional martial arts with similar playing characteristics to pathol which is more commonly referred to as "Alysh" belt wrestling. Belt wrestling has had the belt wrestling world championship followed by many countries. More than 50 countries took part in the belt wrestling world championship. Several countries that participated in this championship included Russia, Turkmenistan, Kyrgyzstan, Kazakhstan, Uzbekistan, Tajikistan, Ukraine, Mongolia, Azerbaijan, Moldavia, Georgia, Belarus. Belt wrestling in each developing country according to the characteristics and history of that country. "Alysh" has been competed in the belt wrestling world championship which began in 2002 until now<sup>8</sup>.

That waist belt wrestling has undergone many changes, related to compliance techniques, behavioral tactics during matches and competition organizational arrangements, but still retains its traditional character. Waist wrestling fulfills several socially defined functions, and first of all the function of the unity of international nations having different cultures and traditions. The difference between the "Alysh" Wrestling Belt and the pathol is that in the opponent's throwing/dropping motion, Alysh can use his feet to tackle while pathol is not allowed. The grip of the belt by the hands on Alysh is by wrapping the hands into the belt, while in pathol only wrapping the hands from the outside. Alysh martial arts are preserved by Kyrgyzstan, Turkey, Russia and the former Soviet Union and already have a world championship. Pathol martial arts are still underdeveloped and even threatened with extinction because currently it is only left in Sarang sub-district. The most striking difference is that pathol does not have basic movements, standard competition rules, and the organization that covers the pathol<sup>9</sup>. wrestling belt "Alysh", athletes compete in a standing position. Winning is awarded to the wrestler who makes the final technical action. All technical actions on the mat and ending on the mat are counted and scored. Belt tied at

chest level. The remaining fist space between the belt and chest. Athletes hold each other's belts by thrusting their hands under the opponent's belts from the outside and fastening them to the hands. Feet can be used to tackle your opponent.

Pathol martial arts are still believed by the public to have a mystical element that cannot be explained through scientific theory. The mystical element here is due to the belief that weight has no effect on the results of pathol matches so that there is no weighing that causes small players to fight big players. This also affects the difficulty of Pathol martial arts being accepted and studied by today's society. Pathol as a martial art does not yet have standardized basic movements because every Pathol player uses different method in the match to defeat his opponent. Until now, there has been no joint training to improve skills in fighting pathol because there is no clear classification of pathol movements to improve competing skills. Pathol players, in this case the community immediately follow the match without the need for special preparation. Pathol also does not have a forum or organization to support it, therefore beladiripathol has not yet been able to develop and is even almost extinct. Research is needed in order to scientifically study the standardization of the basic movements of beladiripathol so that the basic form of motion and basic exercises can be known in depth.<sup>10</sup>

The process of standardizing the basic pathol movements is intended to identify the basic movements of Pathol martial arts by using the rules of logical science so that it can be used/played by everyone, then it can provide convenience in its development so that the now traditional Pathol martial arts can be easily learned by the general public. The standardization of basic pathol martial arts movements is also intended to develop pathol martial arts teaching materials as an effort to disseminate Pathol martial arts. The standardization of the basic pathol movements begins with the gathering of pathol elders, midfielders/referees, and members of the NgudiBudoyo community to equalize perceptions about the rules and basic movements of the pathol, after which the recording of the pathol martial arts movements is carried out. The process of standardizing pathol is intended so that pathol has a standard basic motion and is in accordance with the rules of scientific studies so that it can be accepted by the millennial generation and remains sustainable and develops in other areas. The standardization of the basic pathol movements that will be carried out is in the form of standardizing the pathol

movement which will be dressed with more interesting artistic movements, as well as making standard rules and a clear pathol organizational structure so that the pathol is easier to find and learn by the general public<sup>11</sup>.

Problems in Pathol martial arts need to be solved through standardization of basic movements or basic techniques using sports science analysis while maintaining the characteristics of Pathol martial arts itself. The process of standardizing the basic motion of the pathol aims to preserve, develop, explore, and instill pathol as the culture of the Javanese coastal community. Standardization of the basic motion of the pathol is carried out by transforming the existing basic motion which is then developed to become a standard basic motion which is mutually agreed upon between the elders, midfielders, players and members of the pathol community so that it can be accepted by all levels. Research on the standardization of limited pathol basic movements reveals logical scientific elements in Pathol martial arts, ignoring mystical elements that cannot be explained through science<sup>12</sup>. Standardization is also carried out in the rules of class division in pathol matches so that they can be logically accepted by the general public. In accordance with the formulation of the problem put forward, the objectives of this study are:

1. Analyzing the philosophical basis of Sarang's pathol martial arts.
2. To analyze the sociological basis of Sarang's pathol martial arts.
3. To analyze the psychological basis of Sarang's pathol martial arts.
4. Analyzing the basic motion classification in Sarang pathol martial arts.
5. Analyze the basic motion standards in Sarang pathol martial arts.

## **Method**

The research approach used in this research is descriptive qualitative using a case study research design. Case study research focuses on one selected phenomenon and wants to be understood in depth by ignoring other phenomena. Case research only covers a very narrow area or subject, but in terms of the nature of the research, case research is more in-depth<sup>13</sup>. This approach is used because the focus is on testing one phenomenon, namely the basic motion of the pathol nest martial arts. It takes careful preparation in determining

participants, places, and data collection because this research is changing and developing according to changes in findings in the field. A place where researchers conduct research. This research was conducted in the coastal area of Sarang sub-district (Bajingjowo village, Temperak village, and Karangmangu village), which is the only area that still maintains the pathol nest martial arts. This research focuses on exploring data on pathol elders, pathol actors and coastal communities in Sarang sub-district. The focus of this research is to examine in depth the classification of the basic movements of pathol martial arts through identification and then analysis by paying attention to scientific principles that will produce standard pathol basic motion. This research is studied through philosophical studies, sociological studies, motor learning studies, sports biomechanics studies, and psychological studies<sup>14</sup>.

Subjects in the research concept refer to respondents, informants who want to be interested in information or extract data, while the object refers to the problem or theme that is being researched. The subjects in this study included the head of the Ngudi Budoyo community, elders of the nest pathol, pathol players, martial arts experts, cultural figures in Rembang district. The object of research is a scientific objective with specific objectives and uses to obtain certain data that has a different value, score or measure. The object of this research is Patholsarang martial arts. Sources of data in this study are divided into two parts, namely primary data sources and secondary data sources.

1. **Primary Data:** The data were obtained from pathol elders and community leaders Ngudi Budoyo. Primary data is the basic motion elements of pathol martial arts taken directly from the object, namely the elders of pathol through video recording which is then used to classify the basic motion of the pathol and analyzed by sports science.
2. **Secondary Data:** The data were obtained from members of the Ngudi Budoyo community and pathol players during performance practice and competitions to take videos and photos. Secondary data can also be obtained from coastal communities in Sarang sub-district, especially the villages of Karangmangu, Sarang Meduro, and Temperak.

This study uses several data collection techniques to avoid the weaknesses of one method with another so that accurate data is obtained. Data collection techniques used in this study were observation, interviews and documentation.



1. **Observation Technique:** The observations made in this study were the researchers took to the field to make direct observations of all activities and individual behavior at the research location. Researchers recorded and recorded everything that was obtained in the field using both structured and semistructured ways, namely by asking questions that you wanted to know and observing the basic movements of Pathol martial arts carried out by elders and pathol practitioners. In the observation technique, video recording of the basic motion of pathol martial arts was also carried out which would then be observed and analyzed through a sports science study<sup>15</sup>.
2. **Interview Techniques:** Interview techniques are used to determine the responses of pathol players in conducting pathol matches regarding movements in pathol, as well as the hopes of pathol players in facing the era of globalization so that pathol will survive and not disappear. This interview is also used to construct people, activities, events, motivation, organization, demands and concerns; reconstructing activities that have occurred in the past, projecting what is expected in the future; verify, modify and expand information obtained from both humans and non-humans (triangulation); and verify, modify, and expand the constructs developed by the researcher for checking members<sup>16</sup>.
3. **Documentation Techniques:** Documentation techniques aim to retrieve data through documents and records/videos of past events. Documents collected in this study were written materials related to pathol, both personal documents and official documents. Personal documents include a person's written notes or essays about his actions, experiences and beliefs (diaries, personal letters, and autobiographies regarding pathol), while official documents include internal documents (memos, announcements, instructions, rules of a community institution regarding pathol) and documents. external (magazines, bulletins, statements, and news broadcast by the mass media about pathol). Pathol record/video is used as supporting material in analyzing the basic motion study of pathol martial arts in biomechanics, motor learning and philosophy. The records here were not obtained at the request of the researcher, but rather the results from past videos about the implementation of Pathol.
  - a. **Data Validity Test:** Checking the validity of

the data in this study using triangulation techniques. Theory triangulation is carried out by cross-checking to ensure whether the data found in the field are appropriate. This technique is commonly used in qualitative research, because this technique reflects an attempt to gain a complete understanding of a phenomenon through examination from other sources. That is, researchers try to use multi-method so that the research is precise and more effective to increase the depth, breadth and strength of the research.

The triangulation technique in this study is that the researcher compares the observed data with the data from interviews with pathol elders, the head of the Ngudi Budoyo community, Pathol actors, and the coastal community of Sarang district, Rembang district. This study also recorded video to identify the basic motion of the pathol, then analyzed it using sports science and technology. Analysis of the components of pathol motion using Application Kinovea version: 0.8.15.0. The results of video recording were also compared with the basic motion video/pathol record of past documents<sup>17</sup>.

Data analysis is a process of systematically searching and compiling data obtained based on field notes, interviews and documentation by organizing data into categories, describing them into units, synthesizing, arranging them into patterns, choose which ones are important and which ones will be studied and make conclusions so that they are easily understood by oneself and others. Data analysis is done by organizing data, decomposing it into units, synthesizing it, arranging it into patterns, choosing which ones to share with others<sup>18</sup>.

The stages in this research, the data is processed from reduction, presentation (display), to drawing conclusions or verification. States that activities in qualitative data analysis take place continuously and are carried out interactively at each stage of the research to completion and until the data is saturated. Activities in data analysis, namely data reduction, display data, and conclusion drawing/verification<sup>19</sup>.

#### **Description of each of these activities, namely:**

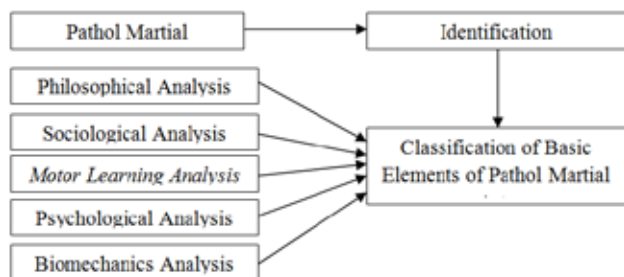
1. **Reduction:** Data reduction is a process of selecting, focusing on simplifying and transforming raw data that emerge from written records in the field. Data reduction begins when data collection is done by summarizing, coding, searching for themes, creating clusters, writing memos and so on with the intention of setting aside irrelevant data and information. The

data obtained from the field will be selected and sorted according to the object under study so that the data obtained is relevant.

- 2. Presentation of Data:** Data presentation or display is a description of a set of structured information that provides the possibility of drawing conclusions and taking action. The presentation of qualitative data is presented in the form of narrative text.

### Result and Discussion

The basic concept of the pathol nest martial arts is closely related to the concept of motion, where the concept of motion is related to the process of moving from the moving part of the body to how it moves. Movement in the pathol nest martial arts is studied through sports science and technology to determine its potential in martial arts, so that the relationship of the limbs and other body parts can be well known, where the body is a means of movement and is used as a weapon in martial arts both when attacking and defending.



**Figure 1. Thinking Framework**

Pathol is a traditional wrestling sport originating from Sarang sub-district, Rembang district, Central Java. Pathol martial arts have existed since the Majapahit era, which was originally a competition event to find the best knights who could guard Tuban harbor, which at that time was full of pirates. Patholsarang means ‘invincible’, being an ancient wrestling martial art native to coastal communities in Sarang sub-district., Rembang district. In ancient times Sarang was included in the Duchy of Lasem when the Majapahit kingdom was still victorious. At that time Lasem was led by Bhre Lasem who was the younger brother of King Hayam Wuruk. Lasem is a duchy that has a sea area, so a navy was formed to strengthen its territory. Selection was held in the process of selecting soldiers as a navy, where the selection technique was carried out by fighting between two people, each of which was wearing a scarf tied around his waist. If the opponent is able to slam his

opponent by holding the shawl tie, then he is declared the winner and escapes as a marine fleet soldier. Until now the patholsarang is still sustainable in the Sarang sub-district<sup>20</sup>.

Knowing the history of the patholsarang, we can see that the regional culture in Rembang district is still sustainable. The ancient culture inherited from the Majapahit kingdom has survived hundreds of years ago, not lost due to the times. This further proves that the people of Rembang, especially Sarang, really care about the preservation of local culture. They keep it and even continue to introduce it to the younger generation. Dubnewick (2018) states participating in traditional games can enhance the sports experience of Indigenous youth by (a) promoting cultural pride, (b) interacting with Elders, (c) supporting connections to the land, (d) develop personal characteristics, and (e) develop the basis of the movement. It advances sports literature and provides the necessary insight into traditional games for sports programmers and policymakers.

**Basic Movement of Nest Pathol:** The tide stance in Pathol martial arts is carried out by standing upright with the arms beside the body and the legs straight up, then the left leg is lifted forward with the front leg bent slightly and the hind leg straight. The next tide stance is to pull the right leg behind it to the right side in line with the left leg. position of the legs are not parallel to the legs of the opponent when paired with the legs of the middle stance. The position of the pairs is a sign that the pathol player is ready to compete and is waiting for a signal from the midfielder, as in the image below which starts in Figure 1 and then continues in Figure 2.



**Figure 2. Front mount**



Figure 3. Middle mount

**Stance:** The stance in the pathol martial arts includes the middle stance and the side stance. The stance is used for both attack and defense. The movement of the stance in Pathol martial arts requires strong leg strength and strength because the essence in Pathol martial arts is to knock down the opponent so that the coordination of the legs in the stance must be good so that it is difficult to slam down when defending and easily knocks the opponent down when attacking.



Figure 4. Middle easel



Figure 5. Side stance

**Step Pattern:** The pattern of steps in Pathol martial arts is carried out before the match and during the match. The pattern of steps before the match starts with stepping your left foot forward, then stepping your right foot sideways parallel to your left foot. This pattern of steps indicates the player is ready to start the match and is waiting for a signal from the midfielder. The stride pattern during the competition includes the forward, backward, right side, and left side step patterns. This pattern of steps is used when defending or slamming an opponent.

**Holding hands:** Hand holding in Pathol martial arts is done by inserting the hand into the udhet/belt through the bottom. Hand holding must be strong because it is used to slam the opponent, besides that it can also be used as defense. Pathol martial arts are dominated by hand grip movements so this movement is very important to master.



Figure 6. Hand holding

**Dings:** The kick motion in pathol martial arts is a movement to pull the opponent to the right and left with a strong force to eliminate the balance of the opponent so that the opponent falls. The motion of throwing can only be done by holding the udhet/belt of the opponent and not allowed to hold anything else. Slamming is also not allowed by tackling or using your feet to kick your opponent.

**Defences:** The defensive movement in Pathol martial arts is carried out by taking a stance to withstand the throw from the opponent. Horses are carried out to adjust the direction of the opponent's throw, if the direction of the opponent's throw is to the right, then defend using a stance to adjust that direction to the middle stance or side with all his might.

**Pathol Sarang Rules:** Patholsarang's performance begins with the opening music using instruments in

the form of a ciblon drum, kempul, bonangloro, saron, demung and slompret, thus inviting the audience to see Patholsarang's performance. The pathol performance which was witnessed by many people was only led by a midfielder or referee in the middle of the arena. The singer arrives after the music is beating and dances to the rhythm of the piece (the sound of the gamelan). The two midfielders stopped dancing after the music stopped (sirep), after which each midfielder called his champion to play a match.

The hero who is ready to compete then takes off all his clothes except for the trousers he is wearing. Each Pathol or hero who has been stripped of his clothes is then given an udhet like a cloth to hold during the match. The udhet is worn around the stomach like a belt. After fulfilling the requirements in the match, the person is ready to do the match. The competitor who is ready while waiting for his opponent to be invited to dance by the midfielder around the arena. The dance is interpreted as a challenge to the co-star. After the opponent is ready, the fight begins, but before the champions fight, they are invited to dance by the midfielders around the arena to the accompaniment of music. The dance of a pair of fighters and stargazers is defined as the readiness that each fighter is ready to fight for strength. The sound of the gamelan stops as a sign that the two fighters are ready to take their respective positions to fight. The fighter sets a stance, the fighter's hands hold the belt (udhet) worn by the opponent. The fighters began to show their strength to each other. They try to slam each other with the strength of their hands that only rest on the belt. During the match, the two midfielders dance to motivate their heroes so that they are excited and win. The music accompaniment was still beaten continuously, the atmosphere was getting tense because of the crowd's screams cheering the champion.

The procedure for a pathol match is that if one of the fighters falls or is slammed, the fallen fighter is declared defeated and the match for that round is declared complete. The fighter who is declared the winner is the fighter who manages to knock down his opponent. It is said to fall if the opponent's back has touched the sand (the ground where the pathol took place). If the opponent falls but has not touched the sand and is still able to get up again, then the fighter still has the right to continue the match, otherwise if each fighter falls and both backs do not touch the sand then the match is considered a draw (single), so that the match is repeated no longer. who win or lose. Games that last for a long time are sometimes

caused because neither fighter can beat the opponent at hand. Both fighters are equally strong and if something like that happens, the midfielder has the right to stop the match. The match that ended with the appearance of a winner was also very interesting. The losing fighters are immediately taken aside and out of the arena by their respective midfielders. The victorious fighter is also immediately invited to dance by the spectators in the arena. This dance of victory is a new form of challenge for opponents who lose and want to start the match again. The match will restart once there is an opponent who dares to beat the winner. The match goes on like the previous round until someone wins or loses. The match will not stop until someone is undefeated. The final winner in the match is called "Pathol", but if in the match neither win nor lose then the match is considered a draw (single) or both agree to stop and end the match led by the midfielder.

**The foundations for the basic elements of the pathol martial arts basic:** Patholsarang is a martial art such as wrestling or sumo which depicts a power battle between two bosses who are fighting over a kick. Tentang is a place to raise fish. Pathol was previously found along the coast of Rembang district to Lamongan. As time goes by, pathol is increasingly being abandoned so that now it can only be found in Sarang sub-district, Rembang district, therefore pathol is now better known as patholsarang. It is not impossible if the process of inheriting pathol martial arts in the nest does not go well, it will cause the pathol to disappear and become extinct from Indonesia because Sarang sub-district is currently the only area that still maintains pathol martial arts. Pathol martial arts inheritance is experiencing obstacles and is difficult to pass on to the current generation because the game system still uses elements beyond reason that believe in magic elements so that young people have difficulty accepting. The absence of a coaching system and a standard competition to regulate Pathol martial arts into modern ones that follow the times. The standardization of the pathol martial arts movement is an indispensable way of inheriting the pathol martial arts so that it can be easily accepted by all levels of society so as to avoid extinction. This standardization also aims to make it easier for the younger generation to learn Pathol martial arts that adapt to current developments. The standardization of the basic movement of the pathol nest martial arts is analyzed philosophically, sociologically, motor learning and biomechanics. The process of philosophical analysis

in the pathol nest martial arts is carried out by tracing data through interviews with pathol elders, Sarang sub-district communities and cultural observers so that it will be found how the forming factors of pathol martial arts can survive until now in Sarang sub-district. This data search was also used to explore the values contained in Pathol martial arts. This is very important because it can serve as a guide in practicing Pathol martial arts, so that everyone who practices and competes in Pathol can understand and apply the values contained therein where every aspect of Pathol martial arts is not only in the form of martial arts movements but also forms the human soul to become better.

### Conclusion

Pathol martial arts need to be developed for the preservation of the culture of Rembang district and Javanese coastal communities because culture contains elements of noble values that must be maintained and in the interest of the community at large. The condition of Pathol martial arts is currently decreasing and can only be found in Sarang sub-district, it takes efforts from various levels of society to the government, as quoted from the Ministry of Youth and Sports which states that traditional martial arts which are almost extinct must be developed and passed on to the young generation of the nation, therefore the government central and regional as well as the community has an obligation to raise and re-develop traditional martial arts. Pathol martial arts are still believed by the public to have a mystical element that cannot be explained through scientific theory. The mystical element here is due to the belief that weight has no effect on the results of pathol matches so that there is no weighing that causes small players to fight big players. This also affects the difficulty of Pathol martial arts being accepted and studied by today's society. Pathol as a martial art does not yet have standardized basic movements because every Pathol player uses different method in the match to defeat his opponent. Until now, there has been no joint training to improve skills in fighting pathol because there is no clear classification of pathol movements to improve competing skills. Pathol players, in this case the community immediately follow the match without the need for special preparation. Pathol also does not have a forum or organization to support it, therefore beladiripathol has not yet been able to develop and is even almost extinct. Research is needed in order to scientifically study the standardization of the basic movements of beladiripathol so that the basic form of motion and basic exercises can be known in depth. The

process of standardizing the basic pathol movements is intended to identify the basic movements of Pathol martial arts by using the rules of logical science so that it can be used/played by everyone, then it can provide convenience in its development so that the now traditional Pathol martial arts can be easily learned by the general public. The standardization of basic pathol martial arts movements is also intended to develop pathol martial arts teaching materials as an effort to disseminate Pathol martial arts. The standardization of the basic pathol movements begins with the gathering of pathol elders, midfielders/referees, and members of the NgudiBudoyo community to equalize perceptions about the rules and basic movements of the pathol, after which the recording of the pathol martial arts movements is carried out. The process of standardizing pathol is intended so that pathol has a standard basic motion and is in accordance with the rules of scientific studies so that it can be accepted by the millennial generation and remains sustainable and develops in other areas. The standardization of the basic pathol movements that will be carried out is in the form of standardizing the pathol movement which will be dressed with more interesting artistic movements, as well as making standard rules and a clear pathol organizational structure so that the pathol is easier to find and learn by the general public.

**Conflict of Interest:** None to declare

**Source of Funding:** Self

**Ethical Clearance:** Institutional Ethics Committee clearance obtained.

### References

1. Alfian, Muhammad. *Filsafat Kebudayaan*. Bandung: CV Pustaka Setia. 2013.
2. Arief, Gugun. *Bela Diri*. Yogyakarta: Insan Madani. 2007.
3. Arifin, Zainal. *Konsep dan Model Pengembangan Kurikulum*. Bandung: Rosdakarya. 2013.
4. Austin, Michael W. "Sport for the Sake of the Soul". *Journal Sport, Ethics and Philosophy*, 2017. .volume 12, issue 1: page 20-29
5. Bachtiar, Wardi. *Sosiologi Klasik*. Bandung: PT Remaja Rosdakarya. 2006. Bairner, Alan. 2012. "For a Sociology of Sport". *Sociology of Sport Journal*, volume 29, issue 1: Pages 102-117
6. Charles, Md. Alli Gipit, et al. "The Effectiveness of Traditional Games Intervention Program in the

- Improvement of Form One School-Age Children's Motor Skills Related Performance Components". *Journal of Physical Education And Sport*, volume 17 supplement issue 3, 2017. Art 141: pp. 925 – 930
7. Craig, Peter. *Sport Sociology*. Britain: Learning Matters LTD. 2010.
  8. Cynarski, Wojciech J. "Social Stratification in Japanese and Some Other Martial Arts: a comparison and discussion of changes". *Physical Culture and Sport, Studies and Research*, 2013.. volume 59, issue 1: page 49-59
  9. Dubnewick, Michael., et al. "There's a Cultural Pride Through Our Games": enhancing the sport experiences of indigenous youth in canada through participation in traditional games. *Journal of Sport and Social Issues*, 2018. .vol. 42, 4: pp. 207-226
  10. Fernandes, FM., et al. Biomechanical method applied in martial arts studies". *Journal of Morphological Sciences*, 2011. ". 28(3):141-144
  11. Franchini, et al. "Olympic Combat Sports Research Output in the Web of Science: a Sport Sciences Centered Analysis". *Journal of Martial Arts Anthropology*, 2018. vol 18, no. n3, pp 21-27
  12. Gaetano, Raiola. "Motor Learning and Didactics into Physical Education and Sport Documents in Middle School-First Cycle of Education In Italy". *Journal of Physical Education and Sport*, 2012.12(2), Art 25: pp.157 - 163
  13. Gamalii, Volodymyr, et al.."Practical Use of Biomechanical Principles of Movement Organization in the Analysis of Human Motor Action". *Journal of Physical Education and Sport*, 2018.18(2), Art 129: Pp. 874 – 877
  14. Gleaves, John. "Sport as Meaningful narratives". *Journal of the Philosophy of Sport*, 2017. volume 44 issue 1: pages 29-43
  15. Hadjarati, Hartono. "Identifikasi Teknik Dasar Beladiri Langga Gorontalo untuk Membangun Diri Daerah (Studi Kasus Di Provinsi Gorontalo)". *Prosiding Seminar Nasional Keolahragaan UNNES*, 2016. hal. 48-58
  16. Halak, Jan. "Beyond Things: The Ontological Importance of Play According to Eugen Fink". *Journal of the Philosophy of Sport*, 2016..volume 43 issue 2: pages 199-244
  17. Hanif, Achmad Sofyan. *Falsafah, Pengukuran, dan Teknik Dasar Shorinji Kempo*. Jakarta: PT Rajagrafindo Persada. 2017.
  18. Hidayat, Dasrun. "Permainan Tradisional dan Kearifan Lokal Kampung Dukuh Garut Selatan Jawa Barat". *Jurnal Academica Fisip Untad* Vol. 05 No. 02: 1057-1070.2013.
  19. Hindaryatiningsih, Nanik. "Model Proses Pewarisan Nilai-Nilai Budaya Lokal dalam Tradisi Masyarakat Buton". *Jurnal Sosiohumaniora*, 2016. Volume 18 No. 2: 108-115
  20. Hoel, Tore. "Interaction Between Standardisation and Research: a case study". *International Journal of Standardization Research*, 2018..16 (1): pages 22-38

# Legal Constraints on the Enforcement of Covid-19 Health Protocol in Indonesia

Husni<sup>1</sup>, Mahdi Syahbandir<sup>2</sup>, Muhammad Ya'kub Aiyub Kadir<sup>3</sup>, Teuku Ahmad Dadek<sup>4</sup>

<sup>1</sup>Senior Lecturer Faculty of Law Syiah Kuala University, <sup>2,3</sup>Lecturer Faculty of Law, Syiah Kuala University,

<sup>4</sup>Student Faculty of Law Syiah Kuala University, Aceh, Indonesia, Mahasiswa Doktor Ilmu Hukum Universitas Syiah Kuala (Banda Aceh, Indonesia)

## Abstract

The positive number of Covid-19 in Indonesia continues to increase and there are no signs of decreasing. This increase was triggered by the implementation of the new normal, long holidays and uncontrolled crowds. And none of this is accompanied by enforcement of health protocol laws (wearing masks, washing hands, maintaining distance and not crowding). This paper examines the legal constraints of enforcing health protocols with normative legal method through library research. The results of his research show firstly, the absence of positive laws that can be used as the basis for law enforcement of health protocols, causing bias in its implementation and health protocols regulated by the Minister of Health Regulation which is not part of the source of positive Indonesian law. Second, the recently issued legal regulations to regulate the enforcement of health protocols are not in accordance with the legal hierarchy prevailing in the Indonesian legal system. Third, specifically for crowd management, the police did not use their authority in accordance with the Criminal Code because it was not prepared to control the Covid-19 crowd, causing multiple interpretations and becoming polemic in the political realm. This study suggests that the Government of Indonesia enact a Government Regulation in Lieu of a Law on Health Protocol Enforcement and provide additional authority to regional heads (governors and regents/mayors) in determining disaster emergencies to also issue regional head regulations in lieu of regional regulations and so that district governments/city and province to propose regent/mayor and governor regulations to become regional regulations that get parliamentary approval.

**Keywords:** Positive Covid-19, Legal constraints, Health protocol.

## Introduction

Introduction from March 2 to 10, December, 2020 positive cases in Indonesia had reached 592,900 people, 487,445 (82.2%) confirmed cured, 18,171 (3.1%) people died, the rest received hospital care and independent isolation on the spot, non hospital<sup>1</sup>. This increase occurred due to three factors. First, it was triggered by the Indonesian Government's policy that announced a new normal on July 1, 2020 without a strong legal certainty

and legal relief approach in enforcing the Covid-19 health protocol. Across Indonesia, the new normal is interpreted as saying that Covid-19 has ended, which is shown by busy going to vacation spots, the culture of going home to a sharp increase, and many wedding parties are being held again. Second, during the Eid al-Adha holiday period on July 31, 2020, which runs from July 30 to August 2, 2020 and the long holiday from October 28 to November 1, 2020, where the government increases the holiday period for two days so that the holiday becomes four days<sup>2</sup>.

This Eid al-Adha holiday triggered population mobility (going home) and returning home so that there was community contact with the local community and led to local transmission and it was proven that 15 days later the Covid 19 number had increased sharply and this was also not accompanied by strict enforcement of

---

### Corresponding Author:

**Teuku Ahmad Dadek**

Student Faculty of Law Syiah Kuala University, Aceh, Indonesia

e-mail: tadadek@gmail.com

health protocol laws and monitoring population mobility. The government is considered weak in controlling the mobility of people, which is the easiest route for the spread of the Covid-19 virus. In fact, there are many studies that prove that controlling people's mobility through transportation modes is very essential in the spread of Covid-19<sup>3</sup>.

Third, the police did not use their authority seriously against Article 281 KHUP to disperse the crowd. The latest is the return of Habib Rizieq Shihab, chairman of the Islamic Liberation Front (FPI) who was picked up at Soekarno-Hatta Airport by nearly 50,000 people where the police could do nothing to disperse the crowd.

Health protocol enforcement can be carried out in two ways, namely socialization and law enforcement with imprisonment and fines. The Indonesian government is still taking socialization steps through printed media content, social media, distributing masks, and other activities. However, the number of Covid 19 continues to increase, this indicates that the socialization that was delivered to residents did not go according to expectations, in fact it was said that almost 70 percent of residents ignored this health protocol<sup>4</sup>.

Health protocol law enforcement based on definite and legal formal laws has not been implemented in a structured and systematic manner. This problem not only arises in areas that have not implemented Large-Scale Social Restrictions (PSBB), but also occurs in areas that are implementing PSBB, such as the Special Capital Region (DKI), Jakarta. Therefore, the Provincial Government of the Special Capital Region of Jakarta has proposed and ratified that the governor regulation (Pergub) be upgraded to a regional regulation (perda), because it is in accordance with the legal hierarchy in Indonesia<sup>5</sup>.

The Indonesian government strives to provide the meaning of legal certainty and legal legality for state officials that the health protocol can be enforced on a positive legal basis by issuing Presidential Instruction Number 6 of 2020 concerning Improved Discipline and Law Enforcement of Health Protocols in the Prevention and Control of Covid-19 which published on August 4, 2020 as an effort to provide legal certainty in health protocol law enforcement. The absence of legal regulations that are used as the basis for law enforcement is not yet available, causing a gray area, especially the uncertainty of legal regulations governing them, who is

the implementer of the law, and how is the procedural law<sup>5</sup>

Then, this condition is exacerbated by the lack of public awareness to comply with health protocols, not to mention that there is distrust that Covid-19 does exist and is attacking. Head of the National Disaster Management Agency (BNPB), Doni Monardo, said that 44 million or 17% of Indonesia's population does not believe that Covid-19 exists<sup>6</sup>. Carter said that the law has an important influence on disasters, namely 1) as a formal basis for disaster management, 2) allocating and distributing the responsibilities and roles of each party legally, 3) providing national guidance, 4) providing adequate support. it makes sense for reasonable measures such as regulations for provision of funds, 5) provides broad and definite benchmarks, and 6) minimizes legal conflicts, especially in the course of an emergency.<sup>7</sup>

The real and real legal relations to disaster management are: 1) the law strengthens the government's obligations in disaster management; 2) engineering the community to have a culture of disaster awareness; and 3) law formulates mechanisms, organization, participation and international relations. Disaster law is inseparable from the government's disaster law politics. Dadek et al. has defined the politics of disaster law as, "As the government's legal options to enforce or not enforce legal regulations in disaster affairs to protect citizens in order to obtain their rights in disaster risk reduction, in emergencies, as well as to secure rehabilitation and reconstruction guarantees for their lives, as well as regulate all obligations.

Community elements in disaster management, and regulating legal mechanisms between institutions and the community in the pre-disaster, emergency, and rehabilitation and reconstruction processes.<sup>8</sup> "Therefore, as a preventive measure so that it can be measured and has legal certainty to break the Covid-19 chain, as a rule of law, Indonesia must compile a health protocol in the form of legal regulation.<sup>9</sup> The Indonesian government faces legal obstacles in enforcing the Covid-19 health protocol because existing legal regulations cannot provide a solid basis for enforcing health protocols. Meanwhile, regulations specifically made to punish health protocols do not comply with the hierarchy of legal products in Indonesia. Then, the enforcement of health protocols through health promotion faces obstacles, such as there are still people who think that Covid-19 does not exist and is just a conspiracy, in addition to rejection based



on the Islamic view that death and the fate of humans have been determined by Almighty God. In fact, there is a hadith of the prophet which states that “if a country is stricken with a plague, then do not go out of the country and into that country.” The leader of the DayahDarul Mujahidin Aceh Utara, Tgk Muslim At-Thahiry asked Dayah Dayah in Aceh to refuse the distribution of masks from the Aceh Government.<sup>10</sup>

## **Materials and Method**

The specification of this research is normative legal research that seeks to describe the legal structure and strength of legal sanctions and to analyze secondary data on the enforcement of Indonesia’s Covid-19 health protocol. Sources of data in this study were obtained from literature studies and literature material studied in the form of statutory provisions, expert views, and related research results as well as current case developments. Literature review is carried out by examining legal materials (primary, secondary and tertiary legal materials) both in physical and electronic form. Data collected from library and field research were analyzed using legal and conceptual approaches. The regulatory approach is carried out on research results that have been regulated in statutory provisions, while the conceptual approach is carried out on research results that have not been regulated in statutory provisions.

## **Results and Discussion**

**Lack of Positive Law:** Why is law enforcement of Indonesia’s Covid-19 health protocol experiencing problems? One of the reasons is the unavailability of positive laws at the level of laws that specifically regulate health protocols (wearing masks, washing hands, maintaining distance and not crowding). While many health protocols are contained in the Decree or Regulation of the Minister of Health, and many health protocols are not only wearing masks, washing hands and maintaining distance, but also how to sneeze, change clothes at home and so on<sup>11</sup>.

In the Indonesian disaster management subsystem that is related to Covid-19, there are various laws such as; Law Number 24 of 2007 concerning Disaster Management (UUPB) as the main regulation, Law Number 23 of 2014 concerning Regional Government (UUPD) also regulates disaster issues, especially covering disaster-prone areas (Article 36), filing regulations in natural disasters (Article 239), emergency funds (Article 296), and division of authority in disaster

management between the central, provincial and district/city levels (attachment), Law Number 23 Year 1992 concerning Health (UUK) which regulates disasters, especially regarding infectious diseases (Articles 28, 29, and 30) and epidemics (Article 31), Law of the Republic of Indonesia Number 4 of 1984 concerning Communicable Disease Outbreaks (UUW) which regulates outbreak areas, countermeasures, rights and obligations, as well as criminal provisions, Law of the Republic of Indonesia Number 6 of 2018 concerning Health Quarantine (UUKK) which regulates quarantine issues, one of which is caused by infectious diseases.

Then, the government also used constitutional authority for “compelling precariousness” by issuing Government Regulation in Lieu of Law (Perpu) of the Republic of Indonesia Number 1 of 2020 concerning State Financial Policy and Financial System Stability for Handling Pandemic Coronavirus Disease 2019 (Covid-19) and/or In the Context of Facing Threats that Endanger the National Economy and/or Financial System Stability which regulates State Finances and Financial Stability. This second group is based on the principle of centralization in handling impacts, health emergency status, quarantine mechanisms, and so on.<sup>11</sup>

In the legal system for disaster management in Indonesia, there has not been a single article that can be used as a legal basis in enforcing the Covid-19 health protocol. However, there are several laws that can be used as a reference in criminal enforcement related to disasters which must be carried out through legal discovery by judges which require a long and long time and mechanism. First, in Law Number 24 of 2007 concerning Disaster Management there are also several criminal provisions and the imposition of fines, both for individuals and legal entities, namely in Articles 75 to 79.

The essence of the penalties of this law are high risk, which is not equipped with disaster risk analysis, b) deliberately hampers easy access during a disaster emergency, and c) deliberately misuses the management of disaster relief resources. Thus, this Disaster Management Law also cannot be used as a reference in enforcing the Covid-19 health protocol as a non-natural disaster in the form of an outbreak. Second, Law of the Republic of Indonesia Number 4 of 1984 concerning Outbreaks of Communicable Diseases which in Article 14 paragraph (1) regulates “punishment for a person who deliberately obstructs the implementation of epidemic

control, shall be punished with a maximum imprisonment 1 (one) year and/or a maximum fine of Rp. 1,000,000.00 (one million rupiah). “This verse is categorized as evil. Article paragraph (2) stipulates “whoever because of his/her negligence causes obstruction of the implementation of the prevention of the epidemic, shall be punished with a maximum imprisonment of 6 (six) months and/or a maximum fine of Rp. 500,000.00 (five hundred thousand rupiahs.”

This paragraph is categorized as a form of offense. What is meant by efforts to contain an infectious disease outbreak? Government Regulation of the Republic of Indonesia Number 40 of 1991 concerning Prevention of Communicable Disease Outbreaks in Article 10 states that “Efforts to contain epidemics include epidemiological investigations, examinations, treatment, treatment and isolation of sufferers, including quarantine measures, prevention and immunity, eradication of disease causes, handling of corpses. due to the epidemic, public outreach, and other prevention efforts. “Can the word “prevention” in this article legally be applied to those who do not wear masks while traveling outside the home? Or when holding a wedding party? In the explanation of number 13 of Government Regulation Number 40 of 1991 concerning Outbreak Management, it is stated that “What is meant by prevention and immunization are efforts to prevent and immunity people and their environment so that they do not contract the disease. These activities can be done through vaccination, spraying, and others. “

Thus, regulations regarding prevention by wearing masks, washing hands, and maintaining a distance cannot be fined by this article. This is because this article by law does not directly regulate the obligation to wear a mask and maintain a distance. A violation rule cannot be imposed on them without a clear legal basis regulating it in the law. Third, Law Number 23 Year 1992 concerning Health regulates criminal provisions in the terms of crime (Articles 80, 81, and 82) and offenses (Article 84).

Article 80 paragraph (1) regarding illegal medical actions, Article 82 concerning conducting illegal treatment and/or treatment, and illegal pharmaceutical actions, Article 84 crimes in circulating food and or drinks that are not marked or labeled and operating workplaces that do not meet standards, prevent people with mental disorders who will be treated and/or treated at health service facilities, from operating health facilities that do not meet the requirements. The Health Law also cannot be used as a basis for enforcement of

health protocols during the Covid-19 pandemic. Fourth, Law of the Republic of Indonesia Number 6 of 2018 concerning Health Quarantine in which Article 93 regulates non-compliance with the administration of health quarantine and/or obstructs the administration of health quarantine so as to cause a public health emergency to be punished with imprisonment of up to 1 (one) year and/or a maximum fine of Rp 100,000,000.00 (one hundred million rupiah).

Fifth, Perpu No.1/2020 which regulates the issue of health impacts on the economy. Supposedly, the government should not only contain financial matters for handling health, economic impacts, and social safety net, but also regulate legal matters of health protocol enforcement. Because there is no positive law regulating the enforcement of health protocols (wearing masks, washing hands and keeping your distance) which does not have legal certainty and based on the principle of legality, **first**, the government and its law enforcement officers are only able to enforce health protocols with social sanctions, not law. like singing clean the way to read the Koran.<sup>12-14</sup>

Second, the State, in this case represented by the President, still considers that the legal rules regarding the prevention of infectious disease outbreaks are not yet available in articles in the legal regulations that contain health protocols and cannot be implemented. This is evidenced by the issuance of Presidential Instruction Number 6 of 2020 concerning Increasing Discipline and Law Enforcement of Health Protocols in the Prevention and Control of Covid-19 which was issued on August 4, 2020 which aims to provide legal certainty and encourage regions to issue regional head regulations that contain legal sanctions.

**Violations of Health Protocols:** Third, there is a legal polemic in enforcing health protocols regarding which articles are most appropriate to be used in apprehending health protocol violators, as we will discuss in the case of Habib Rizieq Shihab, the High Imam of the Isla Defenders Front. Fourth, law enforcement changes to a political discourse so that health protocol enforcement is in an area where there is no legal certainty so that the authority is unclear between the central and regional governments. Contrary to the Legal Hierakis to provide legal certainty in enforcing health protocols legally, President Joko Widodo issued Presidential Instruction Number 6 of 2020 concerning Increasing Discipline and Law Enforcement of Health Protocols in the Prevention

and Control of Covid-19 as an effort to enforce the law by providing sanctions in the form of legal fines on August 4, 2020. In the first dictum the presidential instruction (inpres) stipulates that, "The Ministers of the Advanced Indonesian Cabinet, the Cabinet Secretary, the Commander of the Indonesian National Army, the Chief of the Indonesian National Police, the heads of non-ministerial government agencies, the governors and regents/mayors take steps -the steps needed are in accordance with their respective duties, functions and authorities in ensuring legal certainty, strengthening efforts and increasing the effectiveness of the prevention and control of Coronavirus Disease 2019 (Covid-19) in all provinces and districts/cities in Indonesia. "This Presidential Instruction also instructs regional heads to issue regional head regulations to contain sanctions in the form of: verbal warning or written warning, social work, administrative fines, or termination or temporary closure of business operations, whereas from the legal hierarchy point of view, regional head regulations are not justified. loading sanctions.

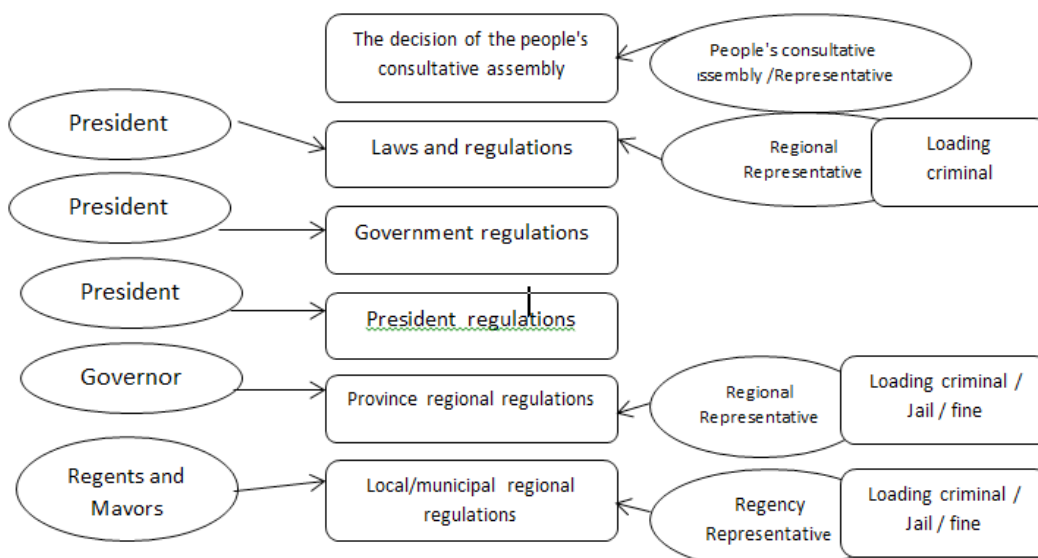
In the second dictum point 6 letter b of the presidential instruction, it states that the governor/regent/mayor drafts a governor regulation or regent/mayor regulation by including sanctions for violations of the Covid-19 Protocol committed by individuals, business actors, managers, organizers, or person in charge of public places and facilities. This Presidential Instruction includes a legal flaw in terms of both the legal hierarchy and the regulated material. First, the Inpres is not part of the hierarchy of legislation in Indonesia, but is part of what Ishviati Joenaini Koenti says is a complement to the principle of legality and is a form of discretion. This is due to the limitations and weaknesses of written law, namely: it is impossible for the law to be complete because of the complexity of society's problems and written regulations are static. Discretion is something that cannot be avoided, both for the application of law itself and in the implementation of government.<sup>15</sup>

Presidential Instruction Number 6 of 2020 contradicts Article 7 paragraph (1) of Law Number 15 of 2019 concerning Amendments to Law Number 12 of 2011 which has regulated the hierarchy of statutory regulations, in which presidential instructions and governor regulations, as well as regent regulations/mayor is not included in the hierarchy of the laws and regulations of the Republic of Indonesia. Second, based on this instruction, the Indonesian government issued regional head regulations, one of which is what the Aceh

Government implemented by issuing Aceh Governor Regulation Number 51 of 2020 concerning Improved Handling of Coronavirus Disease 2019 Implementation of Discipline and Law Enforcement of Health Protocols in Aceh on 7 September 2020.<sup>16</sup>

The regulation of the legal material for sanctions in the head regulation is contrary to Article 15 paragraph (1) which states that the contents of the criminal provisions can only be contained in: a. Constitution; b. provincial regional regulations; or c. district/city regional regulations. Meanwhile, the Presidential Instruction and Aceh Governor Regulations, as well as regent/mayor regulations are not laws and are not regional regulations and are contrary to Article 15 paragraph (3) which states that provincial regional regulations and district/city regional regulations can contain the threat of imprisonment or imprisonment. criminal fine. Regulations by governors and regents/mayors are not legal products that are justified in imposing sanctions in any form.

"The statutory regulations in the Republic of Indonesia consist of: a) The 1945 Constitution of the Republic of Indonesia, b) Decrees of the People's Consultative Assembly, c) Laws/government regulations in lieu of laws, d) Government regulations, e) Presidential regulations, f) Provincial regulations, and g) District/city regulations. "Whereas Article 14 of the law states, "the material contained in Provincial Regulations and Regency/City Regulations contains material in the framework of implementing regional autonomy and co-administration, as well as accommodating special regional conditions and/or further elaboration of higher laws and regulations. "Regarding crimes, Article 15 paragraph (1) states that "The contents of criminal provisions can only be contained in 1) Laws, 2) Provincial Regulations, 3) Regency/City Regulations." The criminal threat is "imprisonment for a maximum of 6 (six) months or a maximum fine of Rp.50,000,000.00 (fifty million rupiah)." Paragraph (2) regulates, "Provincial Regulations and Regency/City Regulations may contain the threat of imprisonment or fines other than those stipulated in other statutory regulations." However, the Presidential Instruction and the Aceh Governor Regulation are not laws, nor are they provincial regulations and district/city regional regulations, but are merely instructions and governor regulations that cannot contain sanctions.<sup>17,18</sup>



**Figure 1. Hierarchical Indonesian Legislations**

In Indonesia, a hierarchy of regulations has been regulated even though normatively it also adheres to unwritten customary law, but most legal cases decided by official Indonesian courts are based on written legal regulations issued or issued by state institutions. This means that Indonesia strictly adheres to the principle of legality, that is, all legal decisions based on regulations issued by government agencies in accordance with the authorities granted by law. The principle of legality is applied in criminal law.<sup>19</sup>

Article 1 paragraph (1) of the Criminal Code affirms that an act cannot be punished, except based on the strength of the existing criminal legislation. Anselm Von Feuerbach called it the principle of legality with the adage *Nullum delictum nullae poenae sine praevia lege poenali*. The principle of legality actually exists in the realm of State Administrative Law, which is a principle in which every administrative act must be based on law, both in making regulations and in stipulating and enforcing them. Indonesia strictly adheres to the principle of legality, that is, all legal decisions based on regulations issued by government agencies<sup>20</sup>.

The law demands legality, what is required is the implementation and obedience or the actions that are required on an obligatory basis. There are two principles that must be adhered to in the legal system, especially those that contain sanctions against society. First, the principle of legal certainty and the principle of legal legality, as well as the principle of democracy. Any

imposition on the community must be carried out with valid legal rules, the rules of which are discussed jointly between the executive and legislative branches, both at the level of the formation of laws, as well as the formation of provincial and district/city regional regulations<sup>21</sup>.

**Crowd Disbandment** One of the weaknesses of the Indonesian Government in deciding the spread of Covid-19 is the uncontrolled crowd. This is because first, the concept of generality in the Covid-19 context is different from the concept of generality as regulated in the Criminal Code. Second, the legal concept in the Criminal Code crowd was not prepared for the concept of generality in the Covid-19 context. Third, many health protocol settings are regulated in the minister of health regulations which are not part of the structure of positive sources of law in Indonesia. What differentiates the crowd in the Covid-19 context from the crowd in the Criminal Code? What is clear is that the generality in the Criminal Code is planned, structured and there are political elements in society voicing their interests (common interests of groups), while the concept of crowds in the Covid-19 context is spontaneous, uncoordinated and just a coincidence. Examples of crowd demonstrations and crowds of people in public places such as to markets, stations and so on.<sup>23</sup>

Therefore the Chief of Police of the Republic of Indonesia tried to attract and provide a legal definition so that the crowd in the Criminal Code can be interpreted as a crowd in the context of terminating the spread of

Covid-19. The announcement of the Chief of Police of the Republic of Indonesia Number: Mak/2/III/2020 concerning Compliance with Government Policy in Handling the Spread of the Corona Virus contains the first, “the principle of people’s safety is the highest law (Solus Populi Suprema Lex Esto)”, second, “do not hold social activities social gatherings that lead to mass gathering in large numbers, both in public places and in their own environment, such as 1) social, cultural, religious and religious gatherings in the form of seminars, workshops, gatherings, and other similar activities; 2) activities of music concerts, fairs, festivals, bazaars, night markets, exhibitions and family reception; 3) sports activities, arts and entertainment services; 4) demonstrations, parades, carnivals; and 5) other activities that bring together the masses.

“This announcement also provides another bias to the public that in “urgent circumstances it cannot be avoided, activities that involve many people are carried out by maintaining a constant distance and must follow government procedures related to preventing the spread of Covid-19.” This announcement is published on March 19, 2020. When crowds are allowed in Pilkada, the government has taken two different policies, even though one party crowd is protected by law, but when it applies during a pandemic, the crowd should not be enforced even with strict health protocols, because in fact every crowd in Indonesia health protocols are always being violated, especially wearing a mask and keeping your distance. This edict also cannot be used as a reference for positive law for two reasons. First, the announcement of the Chief of Police of the Republic of Indonesia is not positive law in the statutory system which is the basis of legal law in Indonesia. This regulation is only binding for the internal police, which is usually used to set internal operational standards for the police. Second, in content, the proclamation reopens the opportunity that crowds can be exercised for reasons of unavoidable interest, by not providing a legal definition of any “unavoidable circumstances”.

Meanwhile, crowd dispersal has been regulated in Article 218 of the Criminal Code (KUHP), but it is not used optimally by the police because this article has multiple interpretations and is indeed formed to control crowds related to demonstrations and is political in nature, and the legal sanctions are only dissolution only. First, the use of Articles 212, 216, and 218 of the Criminal Code which can be used as an ultimatum remedium in enforcing health protocol laws. Article 212 of this law

states that “Anyone with violence or threats of violence against an official who is carrying out a legitimate task, or who according to statutory obligations or at the request of the official to provide assistance to him, is threatened for fighting an official, with imprisonment. a maximum of one year and four months or a maximum fine of four thousand five hundred rupiahs. “

This article cannot be used as a basis for enforcement of the health protocol law, considering that this article contains elements of “violence” or “threats of violence” with the intention of “fighting” an “official” or “person providing help”. Meanwhile, not wearing a mask, not keeping your distance is not an act of threatening violence or not fulfilling the elements of the article. Although legal discovery efforts can be carried out, such discovery activities in the criminal law system must adhere to the principle of legality. Article 216 paragraph (1) stipulates; “Anyone who deliberately does not obey orders or requests made according to law by an official whose job is to supervise something, or by an official based on his duties, as well as those who are authorized to investigate or examine a criminal act; Likewise, any person who deliberately prevents, obstructs or thwarts action to enforce the provisions of the law by one of these officials, shall be punished by a maximum imprisonment of four months and two weeks or a maximum fine of nine thousand rupiahs. (2) Equal to the aforementioned criminal, any person who according to the provisions of law has been continuously or temporarily assigned the task of carrying out a public office.”

This article also cannot be used as a basis for fines and penalties, considering that there must be an “order” or “request” which must also be based on law. As is well known, there is not a single article in the law in Indonesia that contains articles that are clear about wearing masks, washing hands and keeping your distance. Article 218 stipulates, “Anyone who, when the people arrive in a crowd, deliberately does not leave immediately after being ordered three times by or on behalf of the competent authority, is threatened with participating in a grouping by a maximum imprisonment of four months and two weeks or a maximum fine of nine thousand. Rupiah”.

Article 218 also cannot be used as an attempt to convict a person or group of people who are gathering because it is not a crowd dealing with demonstrations or the like, but crowds because the factors of the epidemic are very different. Crowds like this are very common

in crowded centers. On what basis can the police use this article? In positive law in Indonesia, the matter of this crowd can be found in Article 216 and Article 218 of the Criminal Code. Article 216 paragraph (1) reads, “Whoever deliberately does not comply with orders or requests made according to law by an official whose job is to supervise something, or by an official based on his duties, as well as those who are authorized to investigate or examine a criminal act; Likewise, any person who deliberately prevents, obstructs or thwarts action to enforce the provisions of the law by one of these officials, shall be punished by a maximum imprisonment of four months and two weeks or a maximum fine of nine thousand rupiahs.<sup>23</sup>

Whereas Article 218 of the Criminal Code states, “Anyone who when the people come together deliberately does not leave immediately after being ordered three times by or on behalf of the competent authority, is threatened for participating in a grouping with a maximum imprisonment of four months and two weeks or a maximum fine nine thousand rupiah. “This article requires a long enforcement and trial mechanism in the Indonesian legal system and this article is aimed at crowds who are about to hold a demonstration using a mechanism that has been stipulated by law, especially Law Number 9 of 2008 concerning Freedom to Express Opinions in Public. This article was used to charge 27 workers with peaceful expression of opinions on October 30, 2015, on charges of “disrespecting the orders of the authorities recognized by law, namely police officers” and “not dissolving themselves after being warned three times by police officers. “So that on that basis the police officers forcibly dispersed and arrested 23 protesters and three lawyers/assistant public lawyers for LBH Jakarta.<sup>24</sup>

Second, many policies (discretion) are published, but in the Indonesian legal system discretion is not part of a legal product in the hierarchy of the statutory order. One of these discretions is the Minister of Home Affairs Regulation Number, Instruction of the Minister of Home Affairs No. 6 of 2020, Enforcement of the Health Protocol to Control the Spread of Covid-19 which contains the threat of removing regional heads in violation of the law<sup>25</sup>.

This Imendagri letter also caused polemics in the community about the power of law. Third, the legal uncertainty of the program has caused the handling of the crowd during the Covid-19 period to have no legal certainty for its implementation. Fourth, there are

differences in legal definitions between the crowd in the context of the law of freedom of expression and the crowd which is not in the context of freedom of opinion such as weddings, commemoration of the Prophet’s birthday, and so on. Then, the Minister of Home Affairs also issued the Minister of Home Affairs Instruction No. 6/2020 on the Enforcement of Health Protocols to Control the Spread of Covid-19 which contained the threat of removing regional heads in violation of the law. This Imendagri letter also caused polemics in the community about the power of law. The polemic surrounding the Imendagri is not included in Indonesia’s positive law, with the first reason that the process of dismissing regional heads is in accordance with statutory regulations, especially the Regional Government Law (UUPD), regional heads are elected by the people and determined by the General Election Commission (KPU) and the president have no right to refuse. Dismissal must be through the DPRD with an impeachment mechanism until the opportunity to defend oneself to the Supreme Court. Second, based on Law Number 15 of 2019 concerning the Compilation of Legislation, the Presidential Instruction is no longer included as a form of legislation. This is to put an end to doubts about the status of the Inpres that were very much published during President Soeharto.

This inability to apply sanctions and fines resulted in massive demonstrations during the pandemic such as the Omnibus Law demonstration of the Job Creation Act and finally RizieqShihab which resulted in the Head of the Jakarta and Banten Special Capital Region Police being removed from his position and this case has caused polemic laws ranging from criminalizing clerics, violating health protocols violating the Health Law, then Rizieq was detained under other legal regulations that have nothing to do with violating the Covid-19 health protocol but relating to incitement and fighting against the authorities. Finally, there was a shooting which killed six of Rizieq’s bodyguards<sup>26-31</sup>.

## Conclusion

Positive law that exists in Indonesia, there are no specific articles that can be applied to enforce health protocols (wearing masks, washing hands, keeping distance, and not crowding) so that implementation has created legal uncertainty and is not in accordance with the principle of legality, and tends to enter in a political versus legal interpretation. The Indonesian government is aware of the legal vacuum and the existence of legal uncertainty which results in the enforcement of health

protocols into legal polemic and has not been able to become a legal instrument with coercive power to suppress the positive number of Covid-19. The legal vacuum was then addressed by the central government by issuing Presidential Instruction Number 6 of 2020 which essentially wanted to provide legal certainty in terms of enforcing health protocols and the Instruction of the Minister of Home Affairs Number 6 of 2020 dated 18 November 2020, which essentially contained a threat to regional heads who violated laws and regulations can be dismissed. However, enforcement of health protocols remains a legal polemic, in other words, enforcement does not meet the requirements and legal certainty.

The Minister of Home Affairs has issued Circular Number 440/31660 dated May 15, 2020, which in its third point asks regional heads to prepare regional regulations that contain health protocols. As of November 2020, only DKI Jakarta has made it a regional regulation. There are several solutions that can be taken in solving this problem of legal certainty and so that there is a definite law enforcement. First, in the short term, the Government of Indonesia must immediately issue government regulations in lieu of laws (perppu) for the benefit of systematically enforcing health protocols so that health protocol enforcement has certainty, both material and formal laws, and law enforcement is certain, namely the police, prosecutors., and judiciary (court). Much must be regulated in the Government Regulation in Lieu of a Law, such as the use of Covid-19 patient data by the police, Second, for the short term, the governor and regent/mayor immediately propose to the parliament so that the governor regulations and regent/mayor regulations can be made into regional regulations/qanuns so that they have legal certainty in the imposition of fines and other sanctions.

Third, for the long term, the authority to determine disaster emergency status by governors, regents and mayors needs to be expanded, with the governors and regents/mayors being authorized to issue governor/regent/mayor regulations in lieu of regional regulations. This is analogous to the authority of the president, but governors and regents/mayors are given limits on their authority, namely only for disaster regulations, especially in imposing imprisonment and fines on residents who violate health protocols. Even the Chinese Government, which has tended to rely on the control of the communist political party since the last five years, especially under Xi Jinping, has developed the principle of legal legality, namely a very legalistic way, empowering

courts, emphasizing legal professionalism, in other words the principle of legality where no punishment can be imposed, unless there is positive law in writing regulating it. In other words, the Chinese authorities make more use of organizational capacity and legal legitimacy rather than circumventing the legal system.

**Ethical Clearance:** Taken from the University ethical committee

**Source of Funding:** Self

**Conflict of Interest:** We declare no conflict of interest within this research and publication

## References

1. Badan Nasional Penanggulangan Bencana Indonesia, 'Peta Sebaran', <https://Covid19.Go.Id/>, 2020 <<https://covid19.go.id/peta-sebaran>> [accessed 10 December 2020].
2. Roels Ni and others, 'Implementasi Konsep Responsible Tourism Marketing (Rtm) Di Desa Wisata Jatimulyo Kabupaten Kulonprogo Yogyakarta', 18.2 (2020) <<https://doi.org/10.36275/mws>>.
3. Muhammad Arfan and others, 'A Caputo Power Law Model Predicting the Spread of the COVID-19 Outbreak in Pakistan', *Alexandria Engineering Journal*, 2020 <<https://doi.org/10.1016/j.aej.2020.09.011>>.
4. Ihsanuddin, 'Kasus Covid-19 Tembus 300.000, Satgas: Masih Ada Warga Abai Protokol Kesehatan', *Kompas.Com*, 2020 <<https://nasional.kompas.com/read/2020/10/06/19275801/kasus-covid-19-tembus-300000-satgas-masih-ada-warga-abai-protokol-kesehatan>> [accessed 11 December 2020].
5. Ryana Aryadita Umasugi, 'Perda Penanganan Covid-19 Disahkan DPRD DKI', 2020 <<https://megapolitan.kompas.com/read/2020/10/19/15202321/perda-penanganan-covid-19-disahkan-dprd-dki>> [accessed 29 November 2020].
6. Arief Munandar, 'Doni Monardo: 44,9 Juta Orang Indonesia Tak Percaya Ada Covid-19', *Poskota*, 2020 <<https://poskota.co.id/2020/10/9/doni-monardo-sebut-449-juta-warga-masih-belum-percaya-covid-19>> [accessed 29 November 2020].
7. W. Nick. Carter, *Disaster Management A Disaster*

- Manager's Handbook, Asian Development Bank, 2008 <<https://www.think-asia.org/bitstream/handle/11540/5035/disaster-management-handbook.pdf?sequence=1>>.
8. Sulaiman Teuku A Dadek, Yanis Rinaldi, *Politik Hukum Bencana Indonesia, I* (Banda Aceh: Universitas Syiah Kuaa Banda Aceh, 2020).
  9. Anwar Mallongi, Agus Bintara Birawida, and Noer Bahri Noor, 'Study of Covid 19 Occurrence in Relation to Masks and Hand Sanitizers Use', 20.4 (2020), 1175–80.
  10. Ilham Pranata, 'Dayah Di Aceh Diminta Tolak Bantuan Masker Dari Pemerintah Aceh', *Info Aceh Timur*, 2020 <<https://www.infoacehtimur.com/2020/10/dayah-di-aceh-diminta-tolak-bantuan.html>>.
  11. Karni Ilyas, 'Vice Versa! Irmanputra Sidin: Kepala Daerah Bukan Oposisi Presiden, Begitupun Sebaliknya' (Indonesia: TVONE, 2020) <<https://www.youtube.com/watch?v=XZFxYEXPmMI>>.
  12. Muhajir Arifin, 'Langgar Protokol Kesehatan, 142 Warga Pasuruan Hanya Dihukum Nyanyi', *DetikNews*, 2020 <<https://news.detik.com/berita-jawa-timur/d-5127804/langgar-protokol-kesehatan-142-warga-pasuruan-hanya-dihukum-nyanyi>> [accessed 23 November 2020].
  13. Eleonora Padmasta Ekaristi Wijana | Muhammad Ilham Baktora, 'Langgar Protokol Kesehatan, 136 Orang Bersihkan Jalanan Di Malioboro', *Suarajogja.Go.Id*, 2020 <<https://jogja.suara.com/read/2020/09/15/184603/langgar-protokol-kesehatan-136-orang-bersihkan-jalanan-di-malioboro>> [accessed 23 November 2020].
  14. Rep: Antara/Red: Christyaningsih, 'Langgar Protokol Kesehatan Di Aceh Disanksi Baca Alquran', *Republika.Co.Id*, 2020 <<https://republika.co.id/berita/daerah/sumatra/qh1972459/langgar-protokol-kesehatan-di-aceh-disanksi-baca-alquran>> [accessed 23 November 2020].
  15. Ishviati Joenaini Koenti, 'Diskresi Dalam Penanggulangan Bencana Di DIY Dengan Paradigma Kontinjensi', *Jurnal Hukum IUS QUIA IUSTUM*, 23.3 (2016), 461–85 <<https://doi.org/10.20885/iustum.vol23.iss3.art6>>.
  16. Pemerintah Aceh, 'Dokumen Dan Informasi Hukum', 2020 <<http://jdih.acehprov.go.id/dih/detail/b81a0e8c-41d9-4a92-80c4-079492328933>> [accessed 29 November 2020].
  17. Satjipto Rahardjo, *Hukum Dalam Jagat Ketertiban, Pertama* (Jakarta: UKI Press, 2006).
  18. Peter Mahmud Marzuki, *Pengantar Ilmu Hukum, Pertama* (Jakarta: Kencana, 2011).
  19. Muhammad Bakri, *Pengantar Hukum Indonesia Jilid 2: Pembidangan Dan Asas-Asas Hukum* (Malang: Universitas Brawijaya Press, 2013). Hal 120
  20. Mercedes Pérez Manzano, Juan Antonio Lascuraín Sánchez, and Marina Mínguez Rosique, 'Multilevel Protection of the Principle of Legality in Criminal Law', *Multilevel Protection of the Principle of Legality in Criminal Law*, 2017, pp. 1–234 <<https://doi.org/10.1007/978-3-319-63865-2>>.
  21. Prajudi Atmo Sudirdjo, *Hukum Administrasi Negara* (Jakarta: Ghalia Indonesia, 1983).
  22. Kadek Melda Luxiana, 'Kapolri Terbitkan Maklumat Kepatuhan Protokol Kesehatan Pilkada 2020', *DetikNews*, 2020 <<https://news.detik.com/berita/d-5181773/kapolri-terbitkan-maklumat-kepatuhan-protokol-kesehatan-pilkada-2020>> [accessed 11 December 2020].
  23. Rindi Nuris Velarosdela, 'Ini Ancaman Hukuman Bagi Warga Yang Nekat Berkerumun Saat Ada Wabah Corona', *Kompas.Com*, 2020 <<https://megapolitan.kompas.com/read/2020/03/24/11074241/ini-ancaman-hukuman-bagi-warga-yang-nekat-berkerumun-saat-ada-wabah>> [accessed 11 December 2020].
  24. Ahmad Sofian, 'Tafsir Pasal 216 Dan 218 KUHP Dalam Kaitannya Dengan UU NO. 9 TAHUN 1998', 2020 <<https://business-law.binus.ac.id/2016/10/30/tafsir-pasal-216-dan-218-kuhp-dalam-kaitannya-dengan-uu-no-9-tahun-1998/>> [accessed 29 November 2020].
  25. Yusril Ihza Mahendra, 'Presiden Dan Mendagri Tidak Berhak Copot Kepala Daerah, Harus Dari Rakyat', *Https://Wartakota.Tribun*, 2020 <<https://wartakota.tribunnews.com/2020/11/20/yusril-ihza-mahendra-sebut-presiden-dan-mendagri-tidak-berhak-copot-kepala-daerah-harus-dari-rakyat>> [accessed 21 November 2020].
  26. Dandy Bayu Bramasta, 'Sederet Pejabat Yang Dicipot Karena Disebut Abaikan Protokol Kesehatan', *Kompas.Com*, 2020 <<https://www.kompas.com/tren/read/2020/11/24/100500065/sederet-pejabat-yang-dicipot-karena-disebut-abaikan-protokol-kesehatan?page=all>> [accessed



- 10 December 2020].
27. Matius Alfons, 'Habib Rizieq Tersangka, FPI Sebut Kriminalisasi', DetikNews, 2020 <[http://news.detik.com/berita/d-5289616/habib-rizieq-tersangka-fpi-sebut-kriminalisasi?utm\\_source=notifikasi & utm\\_campaign=browser & utm\\_medium=desktop](http://news.detik.com/berita/d-5289616/habib-rizieq-tersangka-fpi-sebut-kriminalisasi?utm_source=notifikasi&utm_campaign=browser&utm_medium=desktop)> [accessed 10 December 2020].
  28. Tim Redaksi Nusantara, 'Dituduh Langgar Protokol Kesehatan, Satpol PP DKI Denda Habib Rizieq Syihab', Kabarriau, 2020 <<https://www.kabarriau.com/berita/3777/dituduh-langgar-protokol-kesehatan-satpol-pp-dki-denda-habib-rizieq-syihab>>.
  29. Ctr/nma, 'Pakar Sebut Rizieq Tak Bisa Kena UU Kekarantinaan Kesehatan', Cnnindonesia, 2020.
  30. Ivany Atina Arbi, 'Rizieq Shihab Tersangka, Dituduh Lakukan Penghasutan Dan Melawan Aparat', Kompas, 2020 <<https://megapolitan.kompas.com/read/2020/12/10/13531581/rizieq-shihab-tersangka-dituduh-lakukan-penghasutan-dan-melawan-aparat>> [accessed 10 December 2020].
  31. Erick Tanjung, 'Enam Pengawal Rizieq Ditembak Mati, Polri Persilakan Komnas HAM Bentuk Tim', Suara.Com, 2020 <<https://www.suara.com/news/2020/12/08/183920/enam-pengawal-rizieq-ditembak-mati-polri-persilakan-komnas-ham-bentuk-tim>> [accessed 10 December 2020].

# Multipurpose Training Tool Development Branch of Artistic Gymnastics

Tubagus Herlambang<sup>1</sup>, Tandiyo Rahayu<sup>2</sup>, Sulaiman<sup>2</sup>, Tri Rustiadi<sup>2</sup>

<sup>1</sup>Doctoral Student, Post Graduate Dept., Universitas Negeri Semarang, Indonesia,

<sup>2</sup>Lecture, Post Graduate Dept., Universitas Negeri Semarang, Indonesia

## Abstract

The majority of sports organizations including gymnastics in Central Java Province still use school arenas which are quite small and not representative according to the rules of the Federation Internationale de Gymnastics (FIG). Meanwhile, athletes must train without the hindrance of external factors such as our facilities. Purpose of Study: To provide a solution that can be applied to a limited school area by conducting field analysis and designing a suitable model, especially for uneven rods in gymnastics. The material in this study is the school arena, the uneven bars. Observation and measurement are used to collect data, then analyze it using Computer Aided Design software. The data are presented as descriptive quantitative. Result: To facilitate uneven trunks it can be constructed using either a log or glass fiber with adjustable posts (lower: 1.61-1.70 meters; upper: 2.41-2.50 meters), and with grip properties such as tension: 13.64 Newton, displacement: 1.17 mm, strain: 4.428 m/m. Conclusion: The modified unmodified bar has been designed to optimize training sessions in a limited school area.

**Keywords:** *Sports technique, elite sports, gymnastics.*

## Introduction

Sport is a human physical activity, now it has become a necessity of life. As an activity that involves large muscles, sport can be used as a tool in meeting economic needs, maintaining fitness and rehabilitation, as a means of recreation, education, and of course achievement. Sports can be grouped into three areas, namely; educational sports, recreational sports, and achievement sports<sup>1</sup>. However, there is about the scope of this sport, as stated in the excerpt of the paper Sport Science in Indonesia, namely; physical education, health sports, competitive sports (sports), recreational sports, and dance. Of the various types of artistic gymnastics equipment requires a good construction design, because the equipment is expected not to change the position of the tool so that the gymnast's movement technique

during training and during competition does not change according to the assessment criteria<sup>2</sup>. For that in the use of training equipment for artistic gymnastics, requires the arrangement of mechanical installations is performance sports equipment, especially in gymnastics, both during training and for competition requires constant equipment conditions<sup>3</sup>. To help the calculation of constant equipment levels, one of them is by using CAD software (Computer Aided Design), because it is part of a multidisciplinary study between sports and engineering or what is called sports engineering. Likewise the need for sport engineering in artistic gymnastics based on the request of the Code of Points for various types of cutting-edge techniques<sup>4</sup>. The connotations of sport engineering are diverse, comprehensive and balanced. It is an extension of the latest techniques that must also adhere to this principle. To support the study of sports engineering in determining the conceptual design of building construction and sports equipment that can support the achievement of high-performance and sustainable sports facilities and infrastructure<sup>5</sup>. Based on the results of interviews with researchers with officials of the Central Java PersaniProv, of 35 existing Persani District and City Administrators, the use of gymnastic

---

### Corresponding Author:

**Tubagus Herlambang**

Doctoral Student, Post Graduate Dept., Universitas Negeri Semarang, Indonesia

e-mail: aguspurwanto.prof@gmail.com

training facilities on single and multilevel bars in Central Java has not been effective, because based on average data the tools used are using modification tools. and it is not yet known the level of constancy in these tools using CAD (Computer Aided Design). In addition, the main Persani organization in Central Java uses a school hall building as a gymnastic training place with a limited size of the school hall building, so that the arrangement of the facilities on single crossbar and multi-storey bars cannot be installed in the building because these tools use stakes to installation, so that it requires a large enough space, the parent organization Persani which uses modified equipment installed outside the room from 6 main organizations consisting of Grobogan, Karanganyar, Pati, Pemalang, Rembang and Temanggung districts<sup>6</sup>.

The equipment modified by the 6 parent organizations of different shapes and sizes, both from material specifications and operational use of multilevel cross bars, cannot be adapted to the needs of athletes, while the 25 main gymnastics organizations in Central Java do not have single crossbar and multilevel cross bars. This results in not running the training program because the equipment is installed outside the room so that external factors are disturbed, one of which is the weather. On the other hand, the price of one of the standard FIG gymnastics products for the AAI brand on the single crossbar reaches \$ 3,450 or around Rp. 48,300,000, -, while in the JannsenFritsen multilevel crossbar tool \$ 6,216 or around Rp. 87,024,000, -. The price of the equipment is not included in the cost of shipping and taxes, so that the procurement of gym equipment for single crossbar and multilevel bar with standard specifications at the regional level cannot be fulfilled because the price of the equipment can be said to be expensive and cannot be installed in a limited space because it requires land. which is quite extensive. To solve this problem, the researcher feels the need to conduct development research so that existing problems can be immediately resolved and the results of research in the form of a model product development of a multipurpose training tool for artistic gymnastics in the form of a modified single-bar and multilevel crossbar without using a stake that can be used on Limited training space and can be used as an alternative to training by gymnastics athletes and for coaching the parent organization Persani in Central Java. Through the model of developing a multi-purpose training tool for artistic gymnastics on a single crossbar and a multilevel bar, this can provide solutions to overcome the efforts

to improve skills in the aspects of motion related to the composition of requirements in assessment during competition, as well as the composition of requirements on single crossbar and multilevel bars referring to in Code of Points Artistic Gymnastics 2017-2020<sup>7</sup>. The development of a multipurpose training tool for artistic gymnastics on a single crossbar and a multilevel crossbar is hoped to be able to overcome the limitations of facilities and infrastructure to increase the level of effectiveness, efficiency and usefulness in the use and installation of artistic gymnastics equipment for motion training on single-bars and multilevel bars, assuming it can be used. installed in a space that is limited in size without the use of a rope staple and the level of constancy of the tool can be seen with CAD (Computer Aided Design) software<sup>7</sup>.

Based on the description above, the researcher needs to conduct research on the development of a multipurpose training tool for artistic gymnastics based on CAD (Computer Aided Design)<sup>8</sup>. The hope is that the product development model for a multipurpose training tool for artistic gymnastics that researchers will develop can be owned by each parent organization Persani in Central Java. at a very affordable price because the tool is designed with two tools into one tool called the development of a multipurpose training tool for artistic gymnastics on a single crossbar and a multilevel bar. So that the parent organization can carry out an exercise program programmed and can be a boost for coaches, athletes and the parent organization of the gymnastics branch as a means of training and training activities in Central Java. The purpose of this development is to produce a product for the development of a multipurpose training tool for artistic gymnastics as an alternative as a means of exercise through several steps, namely:

1. Developing a multipurpose training tool for artistic gymnastics on a single bar and a multilevel bar as needed and can be used with minimal facilities.
2. Developing a multipurpose training tool for artistic gymnastics on single-bar and multi-tiered bars which are effective for installation in limited building spaces.
3. The results of the model for developing a multipurpose training tool for artistic gymnastics can be accepted by trainers and athletes in Central Java.

## Method

Development research is research that aims to produce and develop a product in the form of a prototype. Research is to solve practical problems in gymnastics coaching in Central Java, the problems faced by athletes and coaches in implementing training programs, researchers are not for testing theories, testing hypotheses, or testing and perfecting products<sup>11</sup>. Research and development, usually called research-based development, is a type of research that is being increasingly used in solving practical problems in the world of research, especially educational research and learning. Research and development is a process used to develop or validate products used in learning education. Furthermore, it is stated that the research and development procedure basically consists of two main objectives, namely: (1) developing the product, and (2) testing the effectiveness of the product in achieving the goal. In this research, the development model used is a procedural development model, because this model is descriptive, which is a procedure that outlines the steps that must be followed in producing a product<sup>12</sup>. In each development can choose and find the most appropriate steps for research based on the conditions and constraints faced<sup>13</sup>. Define development research as a systematic assessment of design, development and learning programs, processes and products that must meet the criteria of validity, practicality and effectiveness<sup>14</sup>. The criteria “can show the added value of the three criteria. Research and development is a process used to develop or validate products used in education and learning. The development procedure carried out in designing, creating and evaluating (validation) in this study, using outcome measures adapted from Borg & Gall<sup>15</sup>

The trial was carried out to get responses and product revisions, so that the final product would be produced in the form of a development model for a multi-purpose training tool for artistic gymnastics on a single crossbar and a multilevel crossbar according to the needs of the athlete. The trials were carried out in small group trials and field trials. In this study, the trial design used was experimental design. Product development trials go through two stages, namely small group trials and field trials. The test subjects or respondents involved in this research are the parent organization PERSANI in Central Java which is divided into two stages consisting of small-scale trials and trials. field. The small-scale trials in this study included three parent organizations including Pati, Rembang and Grobogan districts with 12 athletes, with

details of each district consisting of 4 athletes. While the large-scale trial covers 7 regions in Central Java. The data used in this study are qualitative data. Qualitative data obtained from interviews in the form of criticism, suggestions from gymnastics experts and resource persons orally and in writing as constructive input for product revision materials. The instruments used to collect data in this study were observations, interviews, questionnaires, field observations and documentation. Questionnaires are used to collect information in a systematic and targeted manner from experts and resource persons. Meanwhile, questionnaires and field observations were used to determine the feasibility and acceptability of the product. The validity of the data is an important thing in research, because it is a guarantee of confidence in solving the problems being studied<sup>16</sup>. To determine the validity (trustworthiness) of data, an examination technique is needed. The implementation of inspection techniques is based on a number of certain criteria. There are four criteria used, namely the degree of trust (credibility), transferability (transferability), dependability (dependability), and certain (confirmability). In order for the data obtained to have a guarantee of trust, in this study the researcher used the criteria for the degree of trust (credibility). The author uses three data credibility checking techniques, namely triangulation, member checking, and peer discussion. Triangulation in credibility is defined as checking data from various ways, and various times. Thus there is triangulation of sources, triangulation of data collection techniques and triangulation of time. This research uses triangulation of sources and triangulation of data collection techniques<sup>17</sup>. Checking members by showing data or information, including the results of the researchers’ interpretations that have been written in the format of field notes or interview transcripts to other information deemed necessary. Comments, reactions or additional information data were used to revise field notes or interview transcripts. The data analysis technique used is the percentage to analyze and the assessment of the developer’s subject in assessing the feasibility, effectiveness and acceptability of the product to the development product. Respondents will be interpreted by the results they get, namely providing the results of tests that have been carried out. The data obtained through the testing activities were clarified, namely qualitative data. Qualitative data in the form of criticism of suggestions put forward by gymnastics experts and athletes are then collected for improvement.

## Result and Discussion

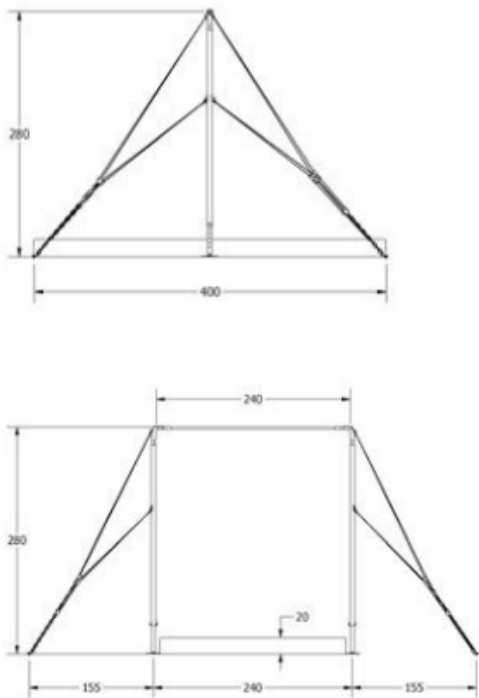
Based on the results of the survey that has been carried out, in the use of single crossbar and multilevel gymnastic tools in Central Java, the model of the tool used is still using a stake as a training facility, so that the tool cannot be installed in the building because it requires a large enough area. The parent gymnastics organization in Central Java does not yet have a multipurpose training tool for artistic gymnastics on a single bar and a multilevel bar as a training facility that can be installed in a limited size building space. The trainer cannot carry out the training program on the single crossbar and multilevel bar in the rainy season, so the athlete cannot do exercises to improve the movement skills on the single-bar and multilevel crossbar effectiveness in carrying out training programs and utilizing hall space as training infrastructure, it can be said that logically the choice of development of a multi-purpose training tool for artistic gymnastics is made on single-bar and multilevel bars. Based on a glimpse of the conditions described in the previous chapter, it is hoped that the development of single-beam and multi-tiered bars can run better. Trainers and athletes do not only do exercises outside the building but can develop the exercise process to be more creative and innovative, so that they can accommodate the activities needed by artistic gymnastics athletes based on understanding the rules on the aspect of the composition of requirements in the code of points artistic gymnastics. Gymnastics new 2D models of single bars including end point movements<sup>18</sup>. 2D modeling of single crossbar apparatus in men's gymnastics is reviewed. Parameter estimation is described regarding two problems, first, to determine the measurement demands posed by parameter estimation, and second, to find the need for new parameter estimation due to different single bars in the review. It is then used to evaluate the adequacy of the FIG (Federation Internationale de Gymnastique) requirements for high competitive standards. The model structure is developed and justified, using two different sets of single bars. Static and kinematic measurements show very different stiffness, damping and inertia characteristics in the vertical and horizontal directions, which is due to the spatial non-fixation of the end points of the horizontal bars, as they attach to the vertical posts connected to the floor. Horizontally, the end-point motion was found to add 30% to the measured motion of the bending of the rod, while vertically, the end-point motion was hardly measurable at all. Hence the two directions are modeled differently. Horizontally, two damped linear springs connected in series are

attached to the measurement data, whereas vertically only one spring is required, demanding a total of nine stiffness, damping and effective mass parameters for the model. It appears that only the parameter ratios are required to model the forced rod oscillations and that all nine parameters can be found from three parameter measurements, i.e. stiffness, and then curve fitting into a single cross bar self-oscillation in two directions to find the remaining. The parameter variation appears to be significant between the bars and finally, the adequacy of the FIG vertical stiffness requirements was found to be questionable.

The sports building design has a huge impact on top sports. This implies challenging tasks to meet performance requirements, including such as daylight/lighting factors, air conditions. Such factors have an impact on athlete performance and are difficult to control in large sports halls; their control is even more difficult when the public/audience is in a hall and requires different climatic conditions. While mechanical installations are often required during competitions to ensure constant conditions, conveying mechanical installations during daily and recreational use of the venue challenges medium or long term sustainability. A computational form-seeking approach can support the achievement of high-performance and sustainable sports buildings. In this regard, this paper discusses the use of multi-objective and multidisciplinary design optimization. This paper presents the concept of multidisciplinary and multi-objective design optimization techniques to support the trade-off decision between several conflicting design objectives and interdisciplinary design methodologies, during the conceptual design of sports buildings<sup>19</sup>. From the various sources of literature review above, a model for developing a multipurpose training tool for artistic gymnastics can be developed as an alternative to exercise which can increase the level of effectiveness, efficiency and usefulness in motion training on single and multilevel bars, assuming it can be installed in space. which size is limited without using a rope staple. Of the various types of gymnastics available, the following is a specification for a single crossbar and a multilevel bar which will be used as a reference by researchers in this development research, including the following:

**Single Cross:** The single crossbar is one of the six numbers of tools in the sport of gymnastics in men's art. The regulations set by the International Federation of Gymnastics (FIG) rods are made of stainless steel 2.4m long and 28mm in diameter, while a single bar is 2.50

m high over a mat with a thickness of 20 cm and is held in position by two supports which are stabilized by four stakes <sup>20</sup>



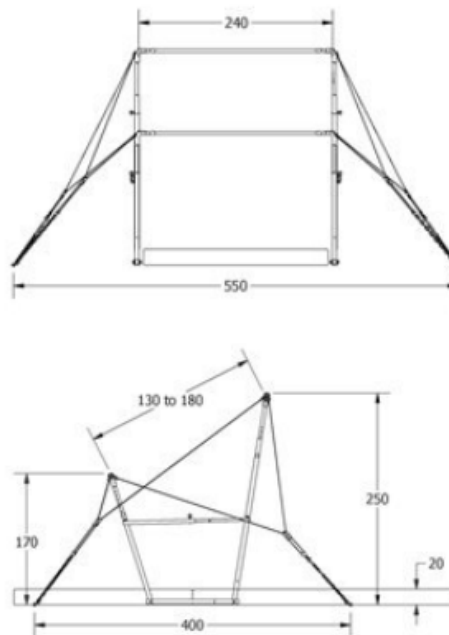
**Figure 1. Single Cross**

In a single crossbar, several types of motion aspects in the composition of requirements that refer to the code of points must be carried out by the gymnast which includes the giant swing, the skills of releasing, turning and changing direction, by using the momentum of the giant swing movement and sufficient height to be reached for dismounting.

**Multilevel Cross:** The multi-storey crossbar consists of two logs or fiberglass, each resting on a vertical support pole of different heights. The lower bar is 1.61 m to 1.70 m from the floor, while the upper beam is 2.41 m to 2 m., 50 m.



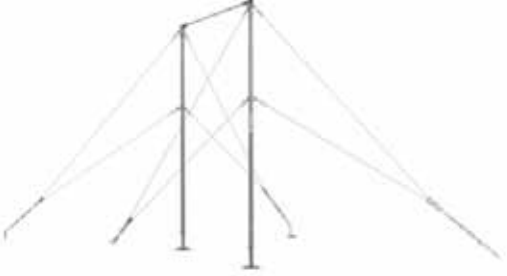

On a multilevel crossbar, the gymnast navigates two horizontal handles at different heights and a predetermined width, the gymnast performs swinging, turning, transitioning and releasing movements during the movement of the multilevel crossbar grip and ending with a dismount motion. The presentation of the exercise on a single crossbar and a multilevel bar must pay attention to the following matters: (1) The gymnast must start his training by doing kip which is an initial step performed by the gymnast. Motion assessment begins when the gymnast moves to kip on the handle of a single

bar or a graduated bar. (2) The gymnast must enter the composition of requirements in the code of points artistic gymnastics which is carried out by the gymnast with full safety and with a high degree of aesthetic and technical mastery according to the ability of their respective athletes. It is hoped that this single and multilevel bar can also improve the movement skills of the tool. With the development of a multipurpose training tool for artistic gymnastics on a single crossbar and a multilevel bar, it is hoped that athletes, coaches and coaches will be more active in making various training models, so that through the development model of developing multipurpose training tools for artistic gymnastics on single bars and bars multilevel can be increased and can create various kinds of model development tools that can be used with minimal facilities and can improve the skills of athletes in accordance with the expected goals. The product model developed by the researcher as an alternative training facility in the form of a multipurpose training tool for artistic gymnastics is based on a needs analysis and existing equipment specifications, namely the AAI brand for single bars and the Gymnova brand for multilevel bars.



**Figure 2. Multilevel Cross**

The product specifications for the development of a multipurpose training tool for artistic gymnastics developed by researchers can be seen in the table below: Table 1. Specifications for the development of a multipurpose training tool for artistic gymnastics on the single-bar and multilevel bars.

No.	Standard Tools	Tools developed
1		
2		



**Figure 3. The design of the multilevel crossbeam tool**

The image above is an initial design as a tool design that will be developed by the researcher, assuming the tool can be used for single crossbar and multilevel bars with an alternate use model, this is a design to accommodate the size of the hall which is limited in

size, so that the design of the tool is designed to be used multipurpose and at the same time to overcome the limited size of the existing hall, with the specifications of the materials used as follows:



**Figure 4. Design of the single crossbar tool**

**Table 6. Material Specifications for the Development of Multipurpose Training Tools for Artistic Gymnastics**

No	Material	<i>Uneven Bars Standard</i>	<i>Uneven Bars Developed</i>
1	High support pole pipe diameter	5,5 cm	62 cm
2	Plate press thickness diameter	6 mm	6 mm
3	The length of the base construction of the press	1,2 m	2 m
4	The width of the basic construction plate press	-	2,54 m
5	Pipe quill diameter	4,3 cm	5 cm
6	Stabilizer Pipe	4,3 cm	
7	High bar height	2,45 up to 2,5 m	2,45 up to 2,5 m
8	Low bar height	1,5 m up to 1,70 m	1,5 m up to 1,70 m
9	Handle diameter of uneven bars	4,1 cm	4,1 cm
10	Stabilizer cable diameter	5,5 mm	Do not use stabilizer cables

With the development of a multipurpose training tool for artistic gymnastics on a single crossbar and a multilevel bar, athletes can do exercises when it rains, because these tools can be installed in buildings without using stakes which require a large area. Optimized kip performance on single bar. The characteristics of a simple goal-directed task, such as a grabbing hand gesture, have been well studied from the perspective of optimization principles. However, it remains unclear what characteristics or control mechanisms of these movements are shared with the movements more generally, (Yamasaki, Gotoh, & Xin, 2010). This paper focuses on gymnastic maneuvers on a single bar, referred to as a kip movement. The kip movements of the expert gymnasts are represented only by the three-link planar model, and attempt to be reproduced under three optimization criteria: the minimum angle criterion; reported minimum torque change criteria to describe multiple joint reach motion; and minimum effort criteria. Numerical analysis shows that 1. there is no criterion which considers that only the starting and ending points can reproduce the measured movements of the gymnast; however, 2. the minimum torque change criterion which assumes a starting and ending point, and the corresponding points can almost reproduce the measured motion, which is the best predictor of the three criteria with the way-point. The results may indicate that the reach of the hand and certain parts of the kip motion share a general characteristic roughly explained by the minimum torque change criterion.

Effect of optimization constraint on multilevel crossbar on dismount swing simulation in the research

of Sheets AL and Hubbard M. Simulation of forward motion dynamics of multilevel crossbar on dismount swing preparation is optimized for observing errors in multilevel crossbar grip before dropping at dismount. Optimization constraints are classified as 1-anatomical/physiological; limiting the maximum hand strength on the crossbar grip before dismount, maximum joint range of motion and torque, muscle activation/deactivation time and 2 geometrics; avoids low-bar contact, and requires minimum landing distance. The gymnast model includes the torso/head, arm, and two leg segments connected by a loop, compliant shoulders, and a frictionless ball-and-socket hip joint. Maximum shoulder and hip torque is measured as a function of joint angle and angular velocity. Movement is driven by maximum torsion scaling with a joint torsion activation function of time that approaches the mean activation of all muscles crossing the joint causing extension/flexion, or adduction/abduction. The force bar accelerates the center of mass while doing muscle work to flex/lengthen the joints, and increase the gymnast's mechanical energy. The optimal technique for generating angular momentum in the giant rear is accelerated before dismounting (Hiley & Yeadon, 2003). In men's artistic gymnastics numbers, the rear giant on a single bar is used to generate the angular momentum needed for the gymnast to dismount in a rotating manner. Mounting from where the gymnast is performing two cartwheels in a layout position (straight body) requires the greatest angular momentum. However, there appear to be two different techniques used by elite gymnasts when performing a giant circle of retarded before the two-round layout while dismounting. The "traditional" techniques have been replaced by those currently used



by the majority of elite gymnasts. To determine whether the scooped technique is better at generating angular momentum, a simulation model is used to optimize the angular momentum about the center of mass when released. The model was evaluated using data obtained from the video force analysis of an accelerated giant. Two optimals were found that are characteristic of the two giant circle techniques used by elite gymnasts. The traditional technique generates more angular momentum than the scoop technique although both techniques are capable of generating sufficient angular momentum for a layout of multiple dismount rotation. As a consequence, elite gymnast preference for scooped technique should be based on factors other than angular momentum production<sup>21</sup>.

Determination of the dynamic elastic modulus of polymer materials under high strain loads using the Hopkinson technique (SHPB) of pressure on a stratified crossbar<sup>22</sup>. The associated factors, namely, the influence of the pressure imbalance in the specimen, the indentation of the stratified bar due to the specimen and the slope between the specimen and the stratified bar, are widely studied. The study of the crossbar material shows that for specimens the size of the specific elastic modulus and diameter of the size is very important for the degree of influence in this study. However, polymers with low modulus of elasticity can still be measured accurately regardless of the curvature shown. Numerical investigations of the tilt effect show that imperfect contact conditions greatly affect the accuracy of the measured modulus of elasticity. This problem can be fixed by the newly proposed vertical SHPB. This can significantly improve the contact conditions between the rod and the specimen and offer an acceptable accurate measurement of the dynamic elastic modulus of the polymer material. Measurement of dynamic force on a single bar using 3D motion capture<sup>23</sup>. The calibrated single-bar displacement is used as a measure for the force acting on the single bar itself during a dynamic gymnast look in artistic gymnastics. A single bar is loaded with a known force and the displacement is observed using the Vicon motion observation system. The calibration results are installed according to EulerBernoulli's beam theory. After calibration, the force can be directly measured by multiplying the displacement of a single bar with the specified fit parameter. This approach can also take into account the application of non-central force (two hands on the handle of a single bar) and the effect of single-bar inertia. The uncertainty in the measured strength was

assessed plus an additional 1% for the unknown weight distribution between the hands.

## Conclusion

With the development of a multipurpose training tool for artistic gymnastics on a single crossbar and a multilevel crossbar, athletes can exercise when it rains, because these tools can be installed in buildings without using stakes which require a large area. Optimization of kip performance on the bars single .. Numerical analysis shows that 1 there is no criterion which considers only the starting and ending points that can reproduce the measured movements of the gymnast; however, 2. the minimum torque change criterion which assumes a starting and ending point, and the corresponding points can almost reproduce the measured motion, which is the best predictor of the three criteria with the way-point. The results may indicate that the reach of the hand and certain parts of the kip motion share a general characteristic roughly explained by the minimum torque change criterion. Optimization constraints are classified as 1-anatomical/physiological; limiting the maximum hand strength on the crossbar grip before dismount, maximum joint range of motion and torque, muscle activation/deactivation time and 2 geometries; avoids low-bar contact, and requires minimum landing distance. The gymnast model includes the torso/head, arm, and two leg segments connected by a loop, compliant shoulders, and a frictionless ball-and-socket hip joint. Maximum shoulder and hip torque is measured as a function of joint angle and angular velocity. Movement is driven by maximum torsion scaling with a joint torsion activation function of time that approaches the mean activation of all muscles crossing the joint causing extension/flexion, or adduction/abduction. The force bar accelerates the center of mass while doing muscle work to flex/lengthen the joints, and increase the gymnast's mechanical energy. Therefore, the stratified bar constraints and forces inherently limit the performance by limiting the ability to carry out movement and reducing the energy of the system when releasing the grip on the multilevel bars. The calibration results are fitted according to EulerBernoulli's beam theory. After calibration, the force can be directly measured by multiplying the displacement of a single bar with the specified fit parameter. This approach can also take into account the application of non-central force (two hands on the handle of a single bar) and the effect of single-bar inertia. The uncertainty in the measured strength was

assessed plus an additional 1% for the unknown weight distribution between the hands.

**Conflict of Interest:** None to declare

**Source of Funding:** Self

**Ethical Clearance:** Institutional Ethics Committee clearance obtained.

### References

1. Agus Mahendra. Pembelajaran Senam di Sekolah Dasar. Jakarta: Departemen Pendidikan Nasional. 2001
2. Ā, A. L. S., & Hubbard, M.. Evaluation of a subject-specific female gymnast model and simulation of an uneven parallel bar swing, 2008.41, 3139–3144. <https://doi.org/10.1016/j.jbiomech.2008.08.027>
3. Cagran, C. Ā., Huber, P., & M, W. Dynamic force measurements for a high bar using 3D motion capturing, 2010.43, 767–770. <https://doi.org/10.1016/j.jbiomech.2009.10.035>
4. Āuk, I., & Almir Atiković, M. T.. Science Of Gymnastics, 5–13.
5. D, X. D. H. D. (2016). Oduwlq +xghf, 2009.161, 1393–1397. <https://doi.org/10.1016/j.proeng.2016.08.599>
6. Dallas, G., & Kirialanis, P. Judges ' Evaluation Of Routines In Men Artistic Gymnastics,2015. (November 2009).
7. Gert-PeterBrüggemann, A. (n.d.). Mechanical energetic processes during the giant swing exercise before dismounts and flight elements on the high bar and the uneven parallel bars.
8. Giubilato, F., Petrone, N., & Franch, V. A method for the quantitative correlation between quality requirements and product characteristics of sport equipment . Procedia Engineering, 2013.60, 403–408. <https://doi.org/10.1016/j.proeng.2013.07.029>
9. Gymnastique, R. I. D. E. 2017 – 2020 Code Of Points Women ' s Artistic Gymnastics.2017
10. Hiley, M. J., & Yeadon, M. R. F. Optimum Technique for Generating Angular Momentum in Accelerated Backward Giant Circles Prior to a Dismount, 2013.119–130.
11. Irwin, G., Exell, T. A., Manning, M. L., & Kerwin, D. G. Functional phases and angular momentum characteristics of Tkatchev and Kovacs, (May), 2016.
12. Jenkins, P. E., Plaseied, A., & Khodae, M. Procedia Engineering,2010.2(2), 2757–2762. <https://doi.org/10.1016/j.proeng.2010.04.062>
13. Kerwin, D. G., & Hiley, M. J. (. Estimation of reaction forces in high bar swinging. Isea, 2003.21–22.
14. Kerwin, D. G., & Hiley, M. J. Estimation of reaction forces in high bar swinging, 21–30.2003
15. Liang, C., & Liang, X. Dynamic Mechanism of Sports Cutting-edge Technique Development and Innovation, 2012.34, 337–342. <https://doi.org/10.1016/j.proeng.2012.04.058>
16. Linge, S., & Hallingstad, O. Gymnastics – a new 2D model of the high bar including endpoint movement, 2002.81–92.
17. Men Ā<sup>TM</sup> s Artistic Gymnastics : A new high bar-gymnast model with sensitivity analysis. (2011), 14(September), 12283. <https://doi.org/10.1007/s12283-011-0069-0>
18. Miao, Y., Li, Y., Liu, H., Deng, Q., & Shen, L. International Journal of Mechanical Sciences Determination of dynamic elastic modulus of polymeric materials using vertical split Hopkinson pressure bar. International Journal of Mechanical Sciences, 2016.108–109, 188–196. <https://doi.org/10.1016/j.ijmecsci.2016.02.005>
19. Pan, W., Turrin, M., Louter, C., Sariyildiz, S., & Sun, Y. Integrating multi-functional space and long-span structure in the early design stage of indoor sports arenas by using parametric modelling and multi-objective optimization. Journal of Building Engineering, 2019.22(January), 464–485. <https://doi.org/10.1016/j.job.2019.01.006>
20. Rydakov, R., Nyashin, Y., Ilyalov, O., & Podgaets, R.. Procedia Engineering, 2010.2(2), 2763–2768. <https://doi.org/10.1016/j.proeng.2010.04.063>
21. Sheets, A., Hubbard, M., & Sheets, A.. A dynamic approximation of balanced gymnastics, 2007.209–210.
22. Sheets AL1, H. M. A. Influence of optimization constraints in uneven parallel bar dismount swing simulations . J Biomech, 2009. 42(11), 19457485. <https://doi.org/10.1016/j.jbiomech.2009.04.014>
23. Turrin, M., Yang, D., Aquilio, A. D., Sileryte, R., & Sun, Y. Computational Design for Sport Buildings. Procedia Engineering, 2016. 147, 878–883. <https://doi.org/10.1016/j.proeng.2016.06.285>

# Management of Occupational Hygiene Therapy on the Ability to Perform Self-Care on Deficient Self-Care Patients Who are Cared for in RSKD, South Sulawesi Province

Syahrir<sup>1</sup>, Fatmawati<sup>2</sup>

<sup>1</sup>Lecturers of University of Islam Makassar, Indonesia

## Abstract

Occupational therapy is a therapy that directs a person to participate in carrying out certain tasks that have been given or assigned, occupational hygiene therapy forms a person to be independent, not dependent on the help of others. So that clients with self-care deficits can do ADL such as eating, dressing, grooming, defecating, and getting pregnant independently. This study aims to determine the effect of occupational hygiene therapy on the ability to perform self-care for deficient self-care patients who are treated at RSKD, South Sulawesi Province. This research is a quantitative research with a quasi-experimental approach with pre-post test one group test which was conducted at the Hospital of South Sulawesi Province. The sample size in this study was 10 respondents. Based on the results of the study, it was found that the effect of personal hygiene occupational therapy on the ability to perform self-care in patients with self-care deficits, the p value of bathing needs: 0.004, the need to dress and dress = 0.004, eating and drinking = 0.004 and defecation = 0.006 using the Wilcoxon rank test. Occupational therapy needs to be applied to self-care deficit clients because this therapy teaches the introduction of existing abilities in a person so that clients can return to independence.

**Keywords:** Occupational therapy, Self-care deficits, Personal hygiene.

## Introduction

Mental health is a feeling of being healthy and happy and being able to overcome life's challenges, being able to accept other people as they are and having a positive attitude towards oneself and others 1. About 35 million people affected by depression, 60 million people with bipolar disorder, 21 million affected by schizophrenia, and 47.5 million affected by dementia<sup>2,3</sup>. In Indonesia, with a variety of biological, psychological and social factors with a diverse population, the number of cases of mental disorders continues to increase which has an impact on increasing the burden on the country and decreasing human productivity in the long term.

Riskesdas 2018 data shows the prevalence of mental emotional disturbance which is indicated by symptoms of depression and anxiety for ages 15 and over reaching around 14 million people or 6% of the total population of Indonesia. Meanwhile, the prevalence of serious mental disorders, such as schizophrenia, reaches around 400,000 people or 1.7 per 1,000 population<sup>3,4</sup>. According to Riskesdas in 2018, South Sulawesi was among the top five people with mental disorders after Aceh Province and the special area of Yogyakarta, the prevalence of mental disorders in South Sulawesi was 2.7 per thousand people with a female prevalence ratio of 7.4 compared to 4.5 for men. Mental disorders begin with unresolved stress, this condition is a physical and psychological reaction to any demands that cause tension and disrupt the stability of everyday life<sup>5</sup>. Continuous stress conditions will cause individuals to suffer from schizophrenia, which is a condition where there is a serious mental disorder characterized by decline in communication due to loss of contact with reality and deterioration in work functions, social relationships or self-care from the previous level<sup>6</sup>.

---

### Corresponding Author:

Syahrir

Lecturers of University of Islam Makassar, Indonesia

e-mail: syahrir-mail01@gmail.com

Group activity therapy is carried out in a group manner, where each participant must have the same problem. While occupational therapy can be carried out in groups and individually so that the therapist can provide intervention to therapy participants in detail according to the needs of the client compared to using group activity therapy<sup>7</sup>. The further rehabilitation process in patients who experience cognitive decline, the inability to interpret stimuli so that reactions to stimuli are unnatural and who are easier to express feelings through activities and who are easier to understand the learning process in direct practice should be done individually<sup>8</sup>.

### Materials and Method

This type of research is a quasi-experimental quantitative study with a one group pretest posttest design approach carried out in RSKD South Sulawesi Province with a sample size of 10 respondents who were taken using purposive sampling method.

### Results

In this study using the Wilcoxon Runk Test with a significance level of  $\alpha = 0.01$  this is because the observation data is not normally distributed which is determined by looking at the Shapiro-Wilk value of 0,000 so it does not meet the requirements for using the t test, if the p-value is obtained smaller than the  $\alpha$  value,  $p < \alpha = 0.01$  then  $H_0$  is rejected or  $H_a$  is accepted. If the p-value obtained is greater than the value of  $\alpha$   $p > \alpha = 0.01$ , then  $H_0$  is accepted or  $H_a$  is rejected. From the results of data processing carried out, it is presented in the form of demographic data on the characteristics of the respondents as follows:

**Table 1. Distribution of the frequency of respondents based on education for deficient self-care patients who are treated at the Regional Special Hospital of South Sulawesi Province in 2020**

Education Level	n	%
Basic	5	50.0
Junior high school	3	30.0
Senior high school	2	20.0
<b>Total</b>	<b>10</b>	<b>100.0</b>

From Table 1, it shows that the frequency of education of the most respondents was at the elementary level of education as many as 5 (50.0%) respondents and the least was in the high school education group as many as 2 (20.0%) respondents.

**Table 2. Frequency distribution of respondents based on age in patients with deficit self-care who are treated in the ylang room at the Regional Special Hospital of South Sulawesi Province in 2020**

Age	n	%
Early mature	3	30,0
Elder mature	6	60,0
Adult	1	10,0
<b>Total</b>	<b>10</b>	<b>100.0</b>

From Table 2, it shows that the age frequency of the most respondents is in late adulthood as many as 6 (60.0%) of respondents and the least in the early adolescent age group is 1 (10.0%) of respondents.

**Table 3. Frequency distribution of respondents based on length of stay in clients with self-care deficits in the ylang room at the South Sulawesi Provincial Special Hospital in 2020**

Length of stay	n	%
1 month	6	60,0
2 month	3	30,0
3 month	1	10,0
<b>Total</b>	<b>10</b>	<b>100.0</b>

From Table 3, it shows that the frequency of length of stay of respondents at most is in the length of stay of 1 month as many as 6 (60.0%) of respondents and the least is the length of stay of 3 months as much as 1 (10.0%).

**Table 4. Frequency distribution of respondents based on the need for bathing before intervention in clients with self-care deficits in the ylang room at the Regional Special Hospital of South Sulawesi Province in 2020**

Need for bathing before intervention	n	%
Fully assisted	7	70.0
Partially assisted	3	30.0
<b>Total</b>	<b>10</b>	<b>100.0</b>

From Table 4. The frequency distribution of respondents based on the need for bathing before the intervention in clients with self-care deficits in the cananga room of the Regional Special Hospital of South Sulawesi Province, showed that respondents who were less fortunate based on the need for bathing that were partially assisted were 3 (30.0%) of respondents and those who needed to be helped a total of 7 (70.0%) respondents.

**Table 5. Frequency distribution of respondents based on the need for bathing after intervention in clients with self-care deficits in the ylang room at the South Sulawesi Provincial Special Hospital in 2020**

Need for bathing before intervention	n	%
Partially assisted	2	20,0
Self	8	80,0
<b>Total</b>	<b>10</b>	<b>100.0</b>

From Table 5. Frequency distribution of respondents based on the need for bathing after the intervention. In the self-care deficit in the ylang room at the Regional Special Hospital of South Sulawesi Province, it shows that respondents who need bathing are partially assisted by 2 (20.0%) of respondents and those who need a bath who are able to independently as many as 8 (80.0%) respondents.

**Table 6. Frequency distribution of respondents based on the need to dress and dress before the intervention in clients with self-care deficits in the Kenanga room at the Regional Special Hospital of South Sulawesi Province in 2020**

The need to dress and dress before the intervention	n	%
Fully assisted	8	80,0
Partially assisted	2	20,0
<b>Total</b>	<b>10</b>	<b>100.0</b>

From Table 6, the frequency distribution of respondents based on the need to dress up and dress before the intervention for clients with self-care deficits in the cananga room of the Regional Special Hospital of South Sulawesi Province shows that respondents who are based on the need to dress and dress assisted by a total of 8 (80.0%) respondents and Partially assisted were 2 (20.0%) respondents.

**Table 7. Frequency distribution of respondents based on the need to dress and dress after the intervention in clients with self-care deficits in the ylang room at the Regional Special Hospital of South Sulawesi Province in 2020**

Dress up and dress after intervention	n	%
Partially assisted	5	50,0%
Self	5	50,0%
<b>Total</b>	<b>10</b>	<b>100.0</b>

From Table 7, the frequency distribution of respondents based on the need to dress up and dress after intervention in clients with self-care deficits in the ylang room of the South Sulawesi Provincial Special Hospital in 2018 shows that respondents who need to dress and dress are partially assisted and who are able to be independent as many as 5 (50, 0%) of respondents.

## Discussion

**Needs a Shower:** From the frequency distribution of respondents based on the need for bathing before the intervention to deficient clients of self-care in the Kenanga Room at the Special Regional Hospital of South Sulawesi Province, it shows that respondents who are less fortunate based on the need for bathing who are partially assisted are 3 (30.0%) respondents. From the data, it was found that respondents were not able to apply bathing twice a day in the morning and evening, and were unable to brush their teeth at least 2 times a day. Meanwhile, respondents with the need for bathing were assisted by 7 (70.0%) respondents. From the data obtained, the client was unable to apply the need for bathing 2 times a day, using shampoo, and the client was also unable to brush their teeth at least 2 times a day.

The client's inability is because some clients are patients with social problems with social isolation so that the client is lazy to do activities, the client just lies on his bed so that other needs are not done. Clients need special guidance from officers to direct so that their needs can be met. From the frequency distribution of respondents based on the need for bathing after the intervention on self-care deficits in the cananga room of the Regional Special Hospital of South Sulawesi Province, it shows that respondents who need bathing are partially assisted by 2 (20.0%) respondents. This is because the data obtained by the client is not able to apply bathing 2 times a day, is not able to brush their teeth twice a day and is not able to prepare toiletries independently, so that respondents still need guidance in fulfilling their bathing needs. The inability of the respondent to apply a bath twice a day is supported by a feeling of laziness to take a bath, and the respondent feels that he does not need to take a shower in the afternoon because he does not have activities outside the room. In addition, the inadequate change of clothes available in the room makes patients lazy to take a shower because there are no changing clothes for the afternoon available after the patient has bathed.

Meanwhile, 8 (80.0%) respondents who need independent bathing have been able to take care of their bath needs, but there is one need that has not been able to be implemented, namely bathing 2 times a day in the morning and evening. Respondents only showered in the morning because they did not feel smelly and dirty. In addition, the unavailability of toiletries in the room such as soap, toothbrush, toothpaste, shampoo and towels makes patients lazy to take a shower in the afternoon. The condition of the fully closed bathroom makes it difficult for officers to guide patients in the bathroom as well as the number of bathrooms that do not match the number of patients so that it takes a long time to complete bathing activities for patients in the ward. While the client's toiletries are in the treatment room, this is because there are patients who cannot be oriented in terms of recognizing toiletries so it is dangerous if they are placed in the patient's room ward or in the bathroom. Based on the results of the study, it can be seen that schizophrenic clients who experience self-care deficits before doing activity therapy, the perception stimulation group is less able to perform personal hygiene care with an average value of 8.05. This is due to the lack of motivation given to clients regarding personal hygiene care to be done at any time so that clients think that personal hygiene care is not so important to him based on research conducted<sup>9-12</sup>.

As a nurse, what you can do is discuss it with patients, check the needs of patient hygiene practices and provide accurate and adequate information to patients. This illustrates that the level of independence of the need for bathing after after occupational therapy with the partially assisted category has increased to the independent category, and overall assistance has increased to the partially assisted category. The increase in patient independence is due to the patient's concern for himself and because the patient's understanding of what has been taught by nurses and researchers so that it can be applied properly by patients. Needs to dress up and dress. From the frequency distribution of respondents based on the need to dress up and dress before the intervention, clients with self-care deficits in the recall room of the Regional Special Hospital of South Sulawesi Province, it shows that respondents who are based on the need to dress and dress assisted are 8 (80.0%) respondents.

The data obtained from respondents are not able to do the need to button and zip their own clothes and are unable to apply combing their hair, this is because

the client is still confused, unable to remember and restore the abilities he had before he was sick so that clients need special guidance from nurses or officers in the room. Meanwhile, the respondents who needed some assistance were 2 (20.0%) respondents, the client was only able to choose and prepare the clothes to be used, the suitability of clothes for the time, and to use sandals if they were prepared. The client's inability to fulfill other needs is influenced by the client's awareness that he has not fully recovered so that the client still sometimes experiences disorientation towards reality, so that the client needs special guidance from the nurse or officer in the room to restore his basic abilities. From the frequency distribution of respondents based on the need to dress and dress after the intervention in clients with self-care deficits in the Kenanga Room at the Regional Special Hospital of South Sulawesi Province, it shows that respondents who need to dress and dress are assisted in part by 5 (50%) respondents, the data is obtained that the client has not able to choose and prepare clothes to be used, and not able to adjust the clothes to be used with the time of use.

The client's inability to orientate towards reality is still lacking even though the client has received special guidance from a nurse or officer in the room, this is due to the length of time the client has had mental disorders, so it requires a long time and continuous guidance during rehabilitation. There were 5 (50.0%) respondents who had been able to be independent, the data was obtained that overall they were able to make grooming and dressing needs, but there is one need that has not been able to be applied, namely the mismatch between the clothes you want to use and the time. The need for clothes at the hospital is provided in the same container between one patient and another patient with a sufficiently minimal number of clothes, so that the patient is clothed with shared clothes, making it difficult to assess the patient's independence in sorting and wearing clothes according to time. In the activity of implementing occupational therapy, the researcher prepares his own clothes with several kinds of clothes which are then chosen by the patient so that the researcher can assess the patient's independence in terms of dressing, for the purposes of dressing the client is also in the treatment room. the recognition of dress up tools so that they are dangerous if placed in the patient ward.

The results of this study are in line with research conducted by Prasetyo, 2018 concerning the application of personal hygiene occupational therapy in

schizophrenic patients with nursing problems with self-care deficits at the Menur Mental Hospital, Surabaya. In 6 days, the client was cooperative, the appearance was neat, the client looked confident, there was eye contact, the client was able to self-care independently. So that the more frequent personal hygiene occupational therapy is done, the client will always be more accustomed to being independent in terms of self-care, especially in terms of appearance.

1. Needs to eat/drink From the frequency distribution of respondents based on the need to eat/drink before the intervention to clients with self-care deficits in the Kenanga room at the Regional Special Hospital of South Sulawesi Province, it shows that respondents who need to eat/drink who are assisted are 6 (60.0%) respondents from the data obtained by clients. unable to apply washing hands before eating and after food and taking food from the container and putting it in the mouth. Loss of memory and confusion that is felt due to mental disorders experienced causes a reduction in the patient's basic abilities in small things such as feeding food into the mouth, so that when the patient eats, the patient's food is scattered. Meanwhile, 4 (40.0%) respondents were partially assisted, the client was only able to take the food that had been provided by himself, eat in the space provided, and be able to chew the food. The client's inability to implement other needs such as washing hands is due to only one wastapel in the room, so it requires a long queue to wash hands, this causes respondents to be lazy to wait for washing hands besides the habit patterns that have been implemented make respondents accustomed to eating without washing their hands first .

Independence is the ability or situation in which individuals are able to manage or overcome their own interests without depending on other people. The independence of an elderly person can be seen from the quality of life itself, where the quality of life can be assessed by the ability to carry out daily activities. The independence referred to in this study is the independence of patients in taking care of themselves such as eating, dressing, defecating/urinating, and bathing in reaction with fellow patients. Occupational therapy or occupational therapy is the science and art of directing one's participation to carry out certain predetermined tasks. This therapy focuses on the introduction of abilities that still exist in a person, maintenance and improvement aims to form a person to be independent, not dependent on the help of others.

The purpose of occupational therapy is to restore mental function to create certain conditions so that clients can develop the ability to be able to relate to other people and the surrounding community, as well as restore physical function, increase movement, muscles, joints, and teach ADL such as eating, dressing, defecating and so on<sup>14-19</sup>.

By giving directions to clients to help adjust themselves, improve their abilities, provide various activities for clients to try to find out their mental and physical abilities, habits, social skills, direct talents and hobbies to be used after the client returns to the community, it is hoped that the client can become more independent. This study explains that self-care occupational therapy has a positive impact on changing the client's ability to meet daily needs independently, this is because okupai therapy focuses on routine problems carried out by respondents in the form of directions that are carried out repeatedly so as to help clients change their behavior from being unable to become independent. However, the application of this therapy must be done repeatedly in terms of direct guidance to patients. The facilities that support the implementation of this activity greatly contribute to the development of the respondent's capacity. So that consideration of facilities is very important before doing therapy to patients.<sup>19-21</sup>

## Conclusion

1. The results obtained prior to occupational therapy show that most of the respondents were assisted partly in terms of bathing needs and overall assistance in terms of grooming and dressing needs, food/drinking needs and defecation needs.
2. The results were obtained after occupational therapy, most of the respondents were able to be independent in terms of bathing needs and eating/drinking needs and most of them were partially assisted in dressing and dressing and defecation needs.
3. There is an effect of occupational hygiene therapy with the ability to perform self-care for deficient self-care patients who are treated at RSKD, South Sulawesi Province.

**Ethical Clearance:** Obtained from the University of Islam Makassar ethical committee

**Source of Funding:** Self

**Conflict of Interest:** Nil

## References

- Dalami, E. *Konsep dasar keperawatan kesehatan jiwa*. CV. Trans info media. Jakarta timur. 2018
- IDI. penyebab terjadinya gangguan jiwa. <http://www.idionline.org/berita/hari-kesehatan-jiwa-sedunia-penyebab-munculnya-gangguan-kesehatan-jiwa>. diakses 2 oktober 2019.
- Kemenkes RI, Peran keluarga dukung kesehatan jiwa masyarakat, <http://www.depkes.go.id/article/view/16100700005/peran-keluarga-dukung-kesehatan-jiwa-masyarakat.html>, (Online) diakses tanggal 12 juni 2019
- IPKJI. Panduan Role Play Strategi Pelaksanaan Komunikasi Keperawatan Jiwa "Isolasi Sosial" Seminar & Workshop Keperawatan Jiwa. Makassar. 2018.
- Priyoto. *Konsep manajemen stress*. Nuha medical. Yogyakarta. 2017.
- Aprilistyawati, A. *Keperawatan psikiatri dan kesehatan jiwa*. Imperium. Yogyakarta. 2018
- Prabowo, E. *Konsep dan Aplikasi Asuhan Keperawatan Jiwa*. Yogyakarta: Medical Book. Numed. 2019.
- Direja, S, H, A. *Asuhan keperawatan jiwa*. Medical book. Yogyakarta. 2017.
- Keliat, A, B. *Keperawatan jiwa terapan modalitas kelompok*. Jakarta: EGC. 2019
- Keliat, A, B. *Model Praktek Keperawatan Profesional Jiwa*. Jakarta: EGC. 2017.
- Lukaningsih, L, Z. *Psikologi Kesehatan*. Nuha Medika, Yogyakarta. 2018
- Muhith, A. *Pendidikan Keperawatan Jiwa Teoridan Aplikasi*. Yogyakarta: Penerbit Andi. 2018
- Devianti, *Terapi okupasi (behavior modification) dengan deficit perawat mandiri* <http://eprintslib.ummgl.ac.id/diakses> 2 oktober 2019. 815/1/16.0601.0070\_bab%20i\_bab%20ii\_bab%20iii\_bab%20v\_daftar%20pustaka.pdf. 2019
- M N Massi S Wahyuni, H Halik, Anita, I Yusuf, F J Leong, T Dick, S Phyu ., Drug resistance among tuberculosis patients attending diagnostic and treatment centres in Makassar, Indonesia., *Int J Tuberc Lung Dis*. 2011 Apr;15(4):489-95. doi: 10.5588/ijtld.09.0730.
- Purwaningsi, W. *Asuhan Keperawatan Jiwa dilengkapiterapi modalitas dan standar operasional procedure (SOP)*. Nuha Medika, Yogyakarta. 2018
- Agusta, D. Pengaruh Terapi Aktifitas Kelompok (Tak) Stimulasi Persepsi Sessi 1-3 Terhadap Kemampuan Mengendalikan Halusinasi Pada Pasien Skizofrenia Hebefrenik. <http://ejournal.stikesnh.ac.id/index.php/jikd/article/view/2>. Online. Diakses pada tanggal 10 November 2019.
- Aminuddin Syam, Sukri Palutturi, Nurhaedar Djafar, Budu, Nurpudji Astuti and Abdul Razak Thaha., Micronutrients, Academic Performance and Concentration Of Study: A Literature Review, 2016; *I J A B E R*, Vol. 14, No. 5, : 2831-2843
- Mallongi, A., Indra, R., Arief, M.U., Fais Satrianegara, M., Environmental pollution and health problems due to forest fires with CO<sub>2</sub> parameters., *Medico-Legal Update* Volume 20, Issue 3, July-September 2020, Pages 888-892.
- Mallongi, A., Puspitasari, A., Ikhtiar, M., Arman, Arsunan, A.A., Analysis of risk on the incidence of scabies Personal Hygiene in Boarding School Darul Arqam Gombara Makassar., *Indian Journal of Public Health Research and Development.*, Volume 9, Issue 4, April 2018, Pages 227-231
- Masriadi, Azis, R., Sumantri, E., Mallongi, A., Effectiveness of non pharmacologic therapy through surveillance approach to blood pressure degradation in primary hypertension patients, Indonesia., *Indian Journal of Public Health Research and Development*. Volume 9, Issue 4, April 2018, Pages 249-255
- Posmaningsih, D.A., Aryasih, G.A.M., Hadi, M.C., Marwati, N.M., Mallongi, A. The influence of media booklet in behavior change of waste management in elementary school students, South Denpasar, Bali., *Indian Journal of Public Health Research and Development*. Volume 9, Issue 8, August 2018, Pages 1506-1511



# The Effect of Massage Therapy Method, Inventory Levels and Stress Levels on Kinase Creatine Levels

Zainul Aziz<sup>1</sup>, Soegiyanto<sup>2</sup>, OktiaWoro K. Handayani<sup>2</sup>, Mugiyo Hartono<sup>2</sup>

<sup>1</sup>Doctoral Student, Post Graduate Dept., Universitas Negeri Semarang, Indonesia,

<sup>2</sup>Lecture, Post Graduate Dept., Universitas Negeri Semarang, Indonesia

## Abstract

The aim of this research is to explain the effect of massage effriction therapy and frirage therapy in helping creatine kinase levels in patients who have experienced injuries I and II with high and low stress levels. The method in this research is quasi-experimental with factorials. The treatments are effriction massage therapy and frirage massage. The two types of therapy that are used are a combination of the two massage method. Effriction massage is massage therapy that is dominated by efflurage and there is pressure to deep tissue. Frirage massage is a massage therapy that is dominated by the thumb and moves to grind but not deep due to scouring combined with efflurage. Both types of therapy are used in this study to obtain maximum results in lowering creatine kinase levels. Effriction therapy and frirage therapy were intervened with a duration of 15 minutes with the criteria for the sample who had level I and grade II injuries, and high and low stress levels. physical assessment test instruments for grade I and grade II injuries by looking at the results of the MRI lab, CT scan or by using a drower test. For the stress level, the instrument used is DASS to determine the level of stress. To measure creatine kinase levels by laboratory tests in collaboration with the pharmaceutical chemistry laboratory in Semarang. The conclusion of this study is that effriction massage therapy and frirage massage therapy can reduce creatine kinase so that it can be used for the therapy of grade I and grade II injuries, high and low stress levels, especially effriction massage therapy as a therapy that has better effectiveness than frirage in reducing creatine levels kinase for cases of knee injury, because one group in the effriction group experienced a significant reduction

Keywords: Massage Therapy, Injury Level, Stress Level, Creatine Kinase Levels.

**Keywords:** .....

## Introduction

Along with the development of this sport it has become a lifestyle that is not only practiced by professional athletes, but also by the general public. One of the sports is used as a means to improve and maintain body fitness. There are many types and alternative choices of sports that can be done by sports players, usually people exercise according to their

hobbies and preferences for certain sports. By doing regular exercise, it can indeed nourish the brain<sup>1</sup>. This is due to the smooth circulation of oxygen flowing to the brain. The brain always produces new cells every time humans enter the growth and development phase. Since humans were born, their brains have never been the same and are always changing. When the brain is assigned different tasks, it will form new connections between brain cells. Synapses or junctions between two nerve cells will reconnect. Physical exercise involves the five human senses. That is why it can provide the brain with more information to integrate<sup>2</sup>. In addition, regular and controlled exercise can improve blood circulation, stimulate the dopamine hormone to increase its secretion so that the brain will get a signal to always feel good. Exercise is good for cardiovascular function which is good for the heart. A good heart will keep

---

### Corresponding Author:

**Zainul Aziz**

Doctoral Student, Post Graduate Dept., Universitas Negeri Semarang, Indonesia

e-mail: aguspurwanto.prof@gmail.com

the brain in good shape, because it reduces the risk of blockage so you avoid strokes, and increases energy use. A large increase in energy use with varying exercise doses will lead to physiological adaptations for the body with exercise records starting with low intensity to high intensity which are systematically programmed<sup>3</sup>. Physical exercise performed with high intensity and long enough duration can cause changes to occur at the cellular level<sup>4</sup>. Changes in the body in carrying out various kinds of metabolism will also produce various kinds of waste products, one of which is creatinine and is followed by an increase in the enzyme creatine kinase<sup>5</sup>. Creatine kinase is a molecular chemical enzyme produced from muscle metabolism, for creatine kinase tips. CK-M. Creatine kinase is transported through the bloodstream to the kidneys. Creatine kinase levels are determined by the amount of muscle mass (protein catabolism rate), in addition to how our body's metabolic activity, for example, increases when we are sick (heat/infection) and triggers an increase in stress in the body, the increase in stress is in the form of metabolic stress or stress. mechanics. The stress that occurs in the body will trigger damage to muscle tissue structures and an inflammatory reaction. Damage to muscle tissue that occurs can cause an increase in serum creatine kinase (CK) levels and pain due to inflammatory reactions. The mechanism of increased creatine kinase is due to creatine produced during skeletal muscle contraction through the breakdown of creatinine phosphate<sup>6</sup>

Creatine kinase levels are predictors of biomarkers that are often studied to determine the degree of structural damage to muscle tissue. A person's creatine kinase activity can be influenced by age, gender, muscle mass, physical activity and weather or climate conditions<sup>7</sup>. Total serum creatine kinase activity was recorded to have increased 24 hours after physical exercise and would decrease when athletes rest<sup>8</sup>. One of the important things that need attention in sports injuries is recovery for muscles that have damaged tissue or inflammation in the muscles<sup>9</sup>. The mechanisms that occur in the body after injury are the initial critical events in the inflammatory process that occur within hours of injury. The initial critical event in the inflammatory process is the accumulation of white blood cells, namely neutrophils, at the site of injury. Practical injuries based on their lightness can be divided into three parts, namely: (1) Level I injuries are injuries that are not followed by significant damage to body tissues, causing movement disorders in the recovery process, and The

pain caused is negligible during activities and will heal on its own after a period of rest. (2) Level II injury is the level of tissue damage that is more significant, affects the athlete's performance, complaints can be in the form of pain, swelling, impaired function of signs of inflammation, for example muscle width, grade II muscle strain, sprain, tendons, torn ligaments (sprain grade). (3) Grade III (serious injury) is a serious injury, which is characterized by tissue damage in the body, for example torn muscles, ligaments or tendon breaks or fractures or fractures. Recovery is useful for giving the body the opportunity to adapt after an injury. Several methods are used in an effort to speed up recovery in an injury, one of which is the first by stopping this exercise which is passive recovery, ice compresses are the first treatment when a new injury occurs. So it can be said that passive recovery is carried out at the beginning of an injury with the aim of maintaining performance, stabilizing acid-base balance, and reducing fatigue<sup>10</sup>. The next method is massage therapy which aims to be restorative for the injured. Before being treated by a professional when an acute inflammatory injury occurs, it is usually neglected and considered as no problem because the predicted level of injury is grade I and II. Even though the neglected injury actually makes the sufferer not free to do sports both in training and in competitions and sports injury sufferers experience stress<sup>11</sup>. After the 2x24 hour injury, it turns out that they do not experience optimal recovery so as to recover. Injuries experienced by people engaging in sports require professional help<sup>12</sup>. Professional treatment, one of which is massage therapy to restore the condition of the muscles, the injuries suffered are given treatment with massage therapy, repositioned and it is hoped that stress reduction will occur because the injuries experienced are handled properly to help the recovery process<sup>13</sup>. The method used to provide massage treatment to injuries are few. In general the techniques used are efflurage, petrissage, tapotement, vibration techniques with a treatment duration of more than 15 minutes to reduce post-exercise pain. Not for injury recovery. For the treatment of injury, the technique used is a combination of existing techniques, namely the Swedish massage technique on the grounds that when providing treatment at least 2 combined techniques can provide time efficiency in treatment, so effriction and frirage techniques are selected<sup>14</sup>.

The use of effriction was chosen because it is a combination of fluragefriction in the implementation of the treatment, there is rubbing with the palms of

the hands, there is speed and massage pressure in the surface area that is being treated. Meanwhile, frirage is a combination of friction and efflurage, but the dominant treatment is the pressing of the thumb and there is no speed in rubbing the surface of the treated area. Frirage is a combination of massage techniques or manipulation of friction (scour) and effleurage (rubbing) which are carried out simultaneously in doing massage<sup>15</sup>. The hope of massage therapy that is carried out with the duration of treatment time is that athletes and sportsmen will not return to the same injury in the near future<sup>16</sup>. Based on the facts in the field, it was found that the prevalence of injuries was 86% in sportsmen obtained in the preliminary study, and 73.5% of these injuries did not heal completely (Litbang KONI DIY, 2008). In some cases, injuries make a sportsman forced to retire early from the world of performance sports. Tennis player Angelique Wijaya is one example of a case of stopping a sports career due to an injury that did not heal completely. In America, approximately 20% of children and adolescents who participate in sports are injured each year. One in four cases of injury that occur is a serious injury (Konin, 2009). Massage therapy as a method of recovery is believed to be able to prevent muscle damage or wider tissue damage<sup>17</sup>. Massage interventions are carried out when the acute period of injury has passed, ie 3-6 days after injury. When the intervention was carried out, the response that occurred from the massage intervention was swelling of pain in the part that was receiving massage treatment, besides that there was also sties in the muscles. Although this therapy caused inflammation during massage therapy, after the intervention was carried out there was a change, namely a comfortable feeling marked by a decrease in pain when instructed to move the injured part and the wider ring of motion<sup>18</sup>. Based on the above background and the research conducted by the researchers, there has been no research on the effect of massage on injuries that have a level of injury and experience stress that has been carried out in Indonesia, especially in sports players. Therefore, the researcher tries to find out how massage, injury level and stress level affect creatine kinase in sports players who experience injury<sup>19</sup>.

## Method

This study consisted of three kinds of factors or variables, which examined their effects on the dependent variable, namely the results of creatine kinase levels. The independent variables include the type of effriction and frirage therapy. While the attribute variable is the

stress level, namely the level of injury I and II. Each independent variable has two levels, namely: 1) injury level: injury level I and II, 2) stress level: high and low category. This study used an experimental method with a factorial design. Therefore, the design in this study is a factorial experimental design in block design because the experimental units in the block are relatively homogeneous and the number of experimental units in a block is the same as the many treatments being studied. This study uses a 2 x 2 factorial design. x 2 because it consists of 3 independent variables and each independent variable consists of 2 levels<sup>20</sup>. Based on the literature review and the problems described above, the research hypothesis is as follows:

1. There is an effect of effriction therapy with injury level I with high stress levels on creatine kinase.
2. There is an effect of effriction therapy with level II injury with high stress levels on creatine kinase.
3. There is an effect of injury level I effriction therapy with low stress levels on creatine kinase.
4. There is an effect of effriction therapy with level II injury with a low stress level on creatine kinase.
5. There is an effect of Frirage Therapy with injury level I with high stress levels on creatine kinase.
6. There is an effect of Frirage Therapy with injury level II with high stress levels on creatine kinase.
7. There is an effect of frirage therapy with injury level II with high stress levels on creatine kinase.
8. There is an effect of frirage therapy with injury level II with high stress levels on creatine kinase.
9. There is an interaction of effriction massage therapy, frirage massage therapy at level I injury level and high stress level on creatine kinase level.
10. There is an interaction of effriction massage therapy, frirage massage therapy at level I injury level and low stress level on creatine kinase level.
11. There is an interaction of effriction massage therapy, frirage massage therapy at level II injury levels and high stress levels on creatine kinase levels
12. There is an interaction of effriction massage therapy, frirage massage therapy at level II injury levels and low stress levels on creatine kinase levels.

The population of this study were people who were active in sports or athletes who suffered injuries,

namely levels I and II, and who experienced low and high stress. The sample in this study were people who suffered injuries with homogeneous characteristics, namely injuries caused by sports activities, with almost the same level of injury, the attribute variable age was 18-35 years, male gender. The sampling technique was purposive sampling. The samples that had met the inclusion and exclusion requirements were 40 athletes. From this number, 40 are taken, then put into groups based on the criteria required by each group. Of these 40, a psychological test was carried out to determine the level of stress and to see the completeness of the required data, namely by bringing the CT scan or MRI or Xray results, the data stated that there was no broken ligament in the knee, if there was no supporting data for the athlete or athlete who was injured. performed a test with a drawer test with the results that there was no shaking, no swelling was still stable but there was pain around the knee. There are 3 variables in this study, namely the independent variable that is manipulated, the attribute variable and the dependent variable. To avoid differences in the interpretation of terms on the variables contained in the study, it is necessary to describe the definitions of each variable in this study<sup>21</sup>.

- a. There are 2 independent variables that are manipulated, namely (a) In this study, the independent variable (independent) consists of (1) massage therapy with the effriction and frirage method. This therapy method is intended as a therapeutic method that will be applied as an integral part of this research. The use of two therapeutic method using effriction and frirage therapy method is intended as a medium for different therapeutic programs to be grouped into research objects. (b) The form of the load is in the form of free weight and machine weight.
- b. The attribute variables in this study are Idan II injury level, and stress levels in the form of low and high stress levels. The intended stress level is the overall result of the selection of tests from athletes who have been selected as objects in this study.
- c. The dependent variable in this study is creatine kinase

This level of stress can be measured by many scales. One of them is to use the Depression Anxiety Stress Scale 42 (DASS 42) or more which is summarized as the Depression Anxiety Stress Scale 21 (DASS 21) by Lovibond & Lovibond (1995). Psychometric

Properties of The Depression Anxiety Stress Scale 42 (DASS) consists of 42 items and Depression Anxiety Stress Scale 21 consists of 21 items. The DASS is a 42-item questionnaire that includes three self-report scales designed to measure negative emotional states of depression, anxiety and stress. Each of the three scales contains 14 items, divided into subscales of 2-5 items with content equivalent ratings. The Depression Scale assesses dysphoria, hopelessness, devaluation of life, self-depreciation, lack of interest/involvement, anhedonia, and inertia<sup>22</sup>. The Anxiety Scale assesses autonomic arousal, skeletal muscle effects, situational anxiety, and subjective experiences affecting anxiety. The Stress Scale (item) sensitive to non-specific chronic levels of arousal. It assesses difficulty relaxing, nervous arousal, and irritability/restlessness, irritability/over-reactivity and impatience<sup>23</sup>. Respondents were asked to use a 4-point severity/frequency scale to rate the extent to which they had experienced each country during the past week. Where the research was conducted; 1) a sports injury massage therapy site, checking the level of injury, distributing a questionnaire to measure stress and taking blood samples at the Ngijo Sports Injury Massage clinic: the study population was taken from people who came for massage therapy at the Ngijo Sports Injury Massage therapy clinic who had a knee injury in 2019. To analyze the results of blood samples to determine serum creatine levels, it was carried out at Kimia Farma Semarang laboratory. The study began with a pre-test, in data collection starting in September and ending in December 2019 by conducting a direct post-test at one time when getting patients when getting patients from September to December and until the desired number of sample targets were met. Explanation of the research problem to the research subjects, then proceed with sampling by purposive sampling. Data was processed using SPSSversion 25 software. The difference in measurement results between before and after the intervention in the effriction massage therapy group and the frirage massage therapy group and analyzed using the paired t-test. Measurements after recovery between the effriction therapy group and the effriction massage group were analyzed using an independent t-test. The significance level was set at  $p < 0.05$ .

## **Result and Discussion**

This study was conducted on 48 respondents who were divided into two groups of stress levels, namely high stress levels and low stress levels. Each implementation of massage therapy is always carried out

pre-test and post-test because the pre-test and post-test and massage interventions are given directly at one time. Respondents were verified as the target population when they had a therapy schedule, at the time of scheduling there was already a screening process so that someone who was injured would be the study sample. At the time of the study, researchers used sportsmen or athletes, it was expected that injuries were an effect of the sport they were doing. The results of this study were to look at serum creatine levels after massage therapy was carried out on athletes or athletes who had experienced grade II level injuries and those with high stress and low stress.

**Effect of Effriction Therapy with Injury Level I with High Stress on Creatine Kinase** Analysis of research data to determine the effect of effriction therapy with injury level I and high stress levels in this group with a total sample of 6 people who were given intervention in the form of effriction therapy for 15 minutes, the significance was 0.043. The test results are known to be smaller than 0.05 ( $0.043 < 0.05$ ) so that the hypothesis is accepted, meaning that there is a significant effect of massage effriction therapy on high level I injuries at high stress levels. From these results it can be interpreted that massage effriction therapy significantly reduces creatine levels in grade I injuries with high stress levels. Based on the data, the creatine kinase level in the first level injury group and the high stress level of the pre-test, all samples were in normal condition, namely the target of 130U/L, after being given the effriction massage therapy intervention, there was a decrease and in normal conditions, when analyzed by t test between pre test and There was a significant reduction in post test, meaning that massage effriction therapy helped the process of decreasing creatine kinase significantly in the injury level I group with high stress levels. Effriction massage therapy at the time of intervention even though it gives a painful effect at the time of massage therapy. In the section given effriction massage therapy intervention. So it can be concluded that massage effriction therapy can be given to patients who have level I injury and with high stress conditions

**Effect of effriction therapy with injury grade II with high stress levels on creatine kinase.:** Analysis of research data to determine the effect of effriction therapy with injury level II and high stress levels with the number of samples in the group with a sample size of 6 people who were given intervention in the form of effriction therapy for 15 minutes, that the significance was obtained 0.188. The test results are known to be greater than 0.05

( $0.188 > 0.05$ ) so that the hypothesis is rejected, meaning that there is no significant effect of massage effriction therapy on level II injuries at high stress levels. The creatine kinase levels in this group were normal, i.e. they did not cross the reference limit for creatine kinase, but between the pre-test and post-test there was no increase or decrease in creatine kinase, even though at the time of massage effriction therapy intervention, there was a decrease in pain perception received by patients who were given therapeutic intervention.

Massaseffriction, meaning that although there was no decrease in the creatine kinase pain received by the sample at the time of intervention was not part of the tissue damage at the time of injury, this was evidenced by the absence of an increase in creatine kinase levels in the blood at the time of the post test for the group with grade II injury and high stress levels. **Effect of injury rate I effriction therapy with low stress levels on creatine kinase** Analysis of research data to determine the effect of effriction therapy with injury level I and low stress levels in the group with a sample size of 6 people who were given intervention in the form of effriction therapy for 15 minutes, it was known that the significance was 0.061. The test results are known to be greater than 0.05 ( $0.061 > 0.05$ ) so the hypothesis is rejected, meaning that there is no significant effect of massage effriction therapy on high level I injuries at low stress levels. Effriction massage therapy that was intervened in the group with low stress level I injury did not experience a significant reduction in creatine kinase levels. This means that the creatine kinase level in the injury level I group and the low stress level under normal conditions, namely in the category in reference so that between the pre test and post test does not experience a significant decrease, if it is analyzed statistically, other influencing factors need to be studied in depth because it can be assumed that with low stress levels in this group the knee injuries occurring are negligible and the likelihood of an increase in injury from grade I to grade II has a high potential. **Effect of effriction therapy with low stress level II injury to creatine kinase** Analysis of research data to determine the effect of effriction therapy with injury level II and low stress levels in the group with a sample size of 6 people who were given intervention in the form of effriction therapy for 15 minutes, the significance was 0.089. The test results are known to be greater than 0.05 ( $0.089 > 0.05$ ) so that the hypothesis is rejected, meaning that there is no significant effect of massage effriction therapy on high level II injuries at low stress levels. In the

effriction intervention group with injury level II and low stress levels there was also a decrease but not significant because in the pre test the creatine kinase level was obtained in normal conditions and after the intervention massage therapy, there was a decrease but not significant so that if analyzed there was no significant decrease in kratin levels. kinase. So that during the intervention process of massage effriction therapy, if there is pain during the intervention it can be assumed that the pain that arises is not due to inflammation in the muscle tissue or in the joints, so looking at creatine levels that are still in a normal state means that massage therapy can still be intervened even though it does not experience it. a significant reduction in creatine levels.

**Effect of frirage therapy with injury level I with high stress levels on creatine kinase** Analysis of research data to determine the effect of frirage therapy with injury level I and high stress levels in this group with a total sample of 6 people who were given intervention in the form of frirage therapy for 15 minutes, that the significance was 0.056. The test results are known to be smaller than 0.056 ( $0.056 > 0.05$ ) so that the hypothesis is rejected, meaning that there is no significant effect of frirage massage therapy on level I injuries at high stress levels. The creatine kinase level in the group that received the frirage massage therapy intervention did not decrease significantly, although it was not significant between the pre-test and post-test, the creatine kinase level in the reference group was in the normal category. The difference with effriction massage therapy, frirage massage therapy is only on the surface and takes a long time because based on observations of frirage massage therapy, according to the researcher, it is assumed that the technique is intended for parts of the body with a low level of muscle tissue thickness, such as the shoulder so that the creatine kinase level is decreased in the group. this is not optimal. **Effect of frirage therapy with injury grade II with high stress levels on creatine kinase** Analysis of research data to determine the effect of frirage therapy with injury levels II and high stress levels in the group with a sample size of 6 people who were given intervention in the form of frirage therapy for 15 minutes, that the significance was 0.188. The test results are known to be greater than 0.05 ( $0.188 < 0.05$ ) so that the hypothesis is rejected, meaning that there is no significant effect of frirage massage therapy on level II injuries at high stress levels. The creatine kinase levels in this group were normal, which did not exceed the creatine kinase reference limit, but

between the pre-test and post-test there was no increase or decrease in creatine kinase, even though at the time of the frirage massage therapy intervention there was no pain perception received by the patient at the time of the intervention. Frirage massage therapy, because basically frirage massage therapy is only a rubbing that rubs and does not cause pain perception in patients who are treated with massage. This means that even though there is no decrease in creatine kinase and do not feel the pain received by the sample, there is no inflammation like during an injury during an acute condition, this is evidenced by the absence of an increase in creatine kinase levels in the blood at the time of the post test for the group with level injuries. II and high stress levels.

**Effect of frirage therapy with injury level I with low stress levels on creatine kinase** Analysis of research data to determine the effect of frirage therapy with injury level I and high stress levels in the group with a sample size of 6 people who were given intervention in the form of effriction therapy for 15 minutes, it was known that the significance was 0.079. The test results are known to be greater than 0.05 ( $0.079 < 0.05$ ) so that the hypothesis is rejected, meaning that there is no significant effect of frirage massage therapy on high level I injuries at low stress levels. The creatine kinase level in this group was normal, that is, it did not cross the reference limit for creatine kinase, but between the pre-test and post-test there was no increase or decrease in creatine kinase, even though at the time of the frirage massage therapy intervention there was no pain perception received by the patient at the time of the intervention. Frirage massage therapy, because basically frirage massage therapy is only a rubbing that rubs and does not cause the perception of pain in patients who are treated with massage. This means that even though there is no decrease in creatine kinase and do not feel the pain received by the sample, there is no inflammation like during an injury during an acute condition, this is evidenced by the absence of an increase in creatine kinase levels in the blood at the time of the post test for the group with level injury. I wish low stress levels.

Due to the possibility that in this group with low stress levels, it is assumed that the sample who suffered knee injuries ignored the injuries they experienced because during the activity it was not too disturbing and was considered to be able to recover on its own, it turned out that they did not immediately recover and eventually needed therapy to help the recovery process from the injury suffered. **Effect of Frirage Therapy with Low**

**Level II Injury Stress on Creatine Kinase** Analysis of research data to determine the effect of frirage therapy with injury level I and low stress levels in a group with a sample size of 6 people who were given intervention in the form of effriction therapy for 15 minutes, it is known that the significance is 0.091. The test results are known to be greater than 0.05 ( $0.091 > 0.05$ ) so that the hypothesis is rejected, meaning that there is no significant effect of frirage massage therapy on high level II injuries at low stress levels. In this group the intervention with frirage massage therapy with injury level II and low stress levels decreased but not significant because in the pre-test, creatine kinase levels were found in normal conditions and after intervention, frirage massage therapy decreased

but not significant so that if analyzed there was no significant decrease. cratin kinase levels. So that when the interventional process of frirage massage therapy does not occur pain during the intervention, it can be assumed that there is no expansion of muscle tissue or ligament damage in the joints after the acute period, so looking at creatine levels that are still in a normal state means that massage therapy can still be intervened even though it has not decreased. creatine levels significantly. To determine the effectiveness of each intervention and to find out the difference in a significant reduction in the effect of the intervention, it can be seen in the following table:

**Table 1 Factorial test of the effect of massage therapy, injury levels and stress levels on creatine kinase**

Tests of Between-Subjects Effects					
Dependent Variable:Creatin_kinase					
Source	Type III Sum of Squares	Df	Mean Square	F	Sig.
Corrected Model	1307.250 <sup>a</sup>	7	186.750	4.692	.001
Intercept	330.750	1	330.750	8.310	.006
JT	420.083	1	420.083	10.555	.002
TC	290.083	1	290.083	7.289	.010
TS	126.750	1	126.750	3.185	.082
JT * TC	374.083	1	374.083	9.399	.004
JT * TS	.083	1	.083	.002	.964
TC * TS	44.083	1	44.083	1.108	.299
JT * TC * TS	52.083	1	52.083	1.309	.259
Error	1592.000	40	39.800		
Total	3230.000	48			
Corrected Total	2899.250	47			
a. R Squared =.451 (Adjusted R Squared =.355)					

Based on the table of important values, it can be concluded as follows: The effect of all independent variables on the type of massage, level of injury, level of stress and levels of keratin kinase. The level of injury concurrently against the dependent variable (keratin kinase levels). If Significance (Sig.)  $< 0.05$  (Alfa) = Significant. Based on the table, the significance (Sig.) Of the Corrected Model shows 0.001 means that the model is valid independent, the dependent variable can change its value. If Significance (Sig.)  $< 0.05$  (Alfa) = Significant. Based on the Significance Table (Sig.) Of the Intercept, it shows 0.006 means that the Intercept is

significant. The error value of the model, the smaller the model the better. The value of multiple determination of all independent variables with the dependent. Based on the R Squared Table shows 0.451 which is close to 1, which means strong influence.

**Conclusion**

The conclusion of this study is that effriction massage therapy and frirage massage therapy can reduce creatine kinase so that it can be used for the therapy of grade I and grade II injuries, high and low stress levels,

especially effriction massage therapy as a therapy that has better effectiveness than frirage in reducing creatine levels. kinase for knee injury cases, because one group in the effriction group experienced a significant reduction. The effect of all independent variables on the type of massage, level of injury, level of stress and levels of keratin kinase. The level of injury concurrently against the dependent variable (keratin kinase levels).

**Conflict of Interest:** None to declare

**Source of Funding:** Self

**Ethical Clearance:** Institutional Ethics Committee clearance obtained.

### References

- Adelman, D, Casale. T. Corren J. Manual of allergy & immunology, 4<sup>th</sup> ed. USA Lippincott Williams & Wilkins. 2002
- Agustine, S. D. Identifikasi Kasus-Kasus Cedera Pada Pasien Putri Physical Therapy Clinic, 2013. 1-6.
- Ali Satia Graha, Bambang Priyonoadi..Terapi Masase Frirage. Yogyakarta. 2012
- Andreato, L. V., Franchini, E., Branco, B. H. M., Santos, .I. F. da S., Fukuda, D. H., & Esteves. J. V. D. C. The Effects of Hyperbaric Oxygen Therapy on Post-Training Recovery in Jiu-Jitsu Athletes. Plos One, (2016). .11(3), e0150517. <https://doi.org/10.1371/journal.pone.0150517>
- Aprizal Lukman. Mekanisme Dan Regulasi Hormon Glukokortikoid Pada Manusia. (2008). 1(1), 2-4. 1
- Ardabili, F. M., Purhajari. S., Najafi Ghezalje. T., & Haghani, H. The effect of shiatsu massage on pain reduction in burn patients. World journal of plastic surgerj., (2014). 3(2), 115-118. Diambil dari <http://www.ncbi.nlm.nih.gov/pubmed/25489534> <http://www.pubmedcentral.nih.gov/articlerender.fcgi?artid=PMC4236994>
- Arovah, dr. N. I. Duser-dasar fisioterapi pada cedera olahraga (1 sted) Yogyakarta. (2010).
- Arovah, N. I. (2010). DIAGNOSIS DAN MANAJEMEN CEDERA OLARAHAGA dr. Novita Intan Arovah, MPH Dosen Jurusan Pendidikan Kesehatandan Rekreasi FIK UNY. Diagnosis Dan Manajemen Cedera Olahraga, 1-11.
- Arumsari, A., Budisulistyo, T., & Widodo, Y. Hubungan Tingkat Stres Seseorang Dengan Perubahan Intensitas Nyeri Punggung Bawah (Npb) Di Rsup Dr ., (2016). 5(4), 347-358.
- Baird, M. F., Graham, S. M., Baker, J. S., & Bickerstaff, G. F. Creatine Kinase- and Exercise-Related Muscle Damage Implications for Muscle Performance and Recovery, 2012. <https://doi.org/10.1155/2012/960363>
- Brancaccio, P., Maffulli, N., & Limongelli, F. M. Creative kinase monitoring in sport medicine, (February 2007). <https://doi.org/10.1093/bmb/ldm014>
- Gigir, L., Pristiwa, G., & Nuqul, F. L. (2018). Gambaran Kecemasan Atlet Mahasiswa: Studi pada Unit Kegiatan Mahasiswa (UKM) Olah Raga Universitas Islam Maulana Malik Ibrahim Malang, 6,50-61.
- Hauswirth, C., Louis, J., Bieuzen, F., Pournot, H., Fournier, J., Filliard, J. R., & Brisswalter, J. Effects of whole-body cryotherapy vs. far-infrared vs. passive modalities on recovery from exercise-induced muscle damage in highly-trained runners. PLoS ONE, (2011). 6(12). <https://doi.org/10.1371/journal.pone.0027749>
- Hazar, M., Otag, A., Otag, I., Sezen, M., & Sever, O. Effect of Increasing Maximal Aerobic Exercise on Serum Muscles Enzymes in Professional Field Hockey Players. Global Journal of Health Science, (2014). 7(3). 69-74. <https://doi.org/10.5539/gjhs.v7n3p69>
- Irawan, M. A. (2007). Metabolisme Energi Tubuh & Olahraga. Polton Sports Science & Performance Lab, 1(7), 1-4.
- Jay, K., Sundstrup. E., Sondergaard, S. D., Behm, D., Brandt. M., Swrvoll. C. A., ... Andersen, L. L. Specific and cross over effects of massage for muscle soreness: randomized controlled trial. International journal of sports physical therapy, (2014)., 9(1), 82-91. Diambil dari <http://www.ncbi.nlm.nih.gov/pubmed/24567859> <http://www.pubmedcentral.nih.gov/articlerender.fcgi?artid=PMC3924612>
- Karuniawati. D. W. I. A. Hubungan lama rawat inpatient dengan tingkat stres anakakibathospitalisasi di rumah sakit pku Muhammadiyah Yogyakarta. (2011).
- Kazue Kanda. Kaoru Sugama, Jun Sakuma, Yasuo Kawakami, K. S. Evaluation of serum leaking enzymes and investigation into new



- biomarkers for exercise induced muscle damage. *Exercise Immunology Review*, (2014). 20, 39-54. Diambildari <http://www.embase.com/search/results?subaction=viewrecord & from=export & id=L611842578>
19. Keating, M. N., Holbert. D., Spru, D. I., Mccammon, M. R., Smith, S. S., & Israel, R. C. The Effects of Athletic Massage on Delayed Onset Muscle Soreness, Creatine Kinase, and Neutrophil Count-]': A Preliminary Report. (1994). .(41), 94.
  20. Kindermann, W. Creatine Kinase Levels After Exercise. *Deutsches Aerzteblatt Online* (3), (2018). .344-346. <https://doi.org/10.3238/arztebl.2016.0344a>
  21. Koch, A. J., Pereira. R., & Machado, M. The creative kinase response to resistance exercise. *Journal of Musculoskeletal Neuronal Interactions*, 2014.14(1). 68-77.
  22. Liu, X., Zhen. L., Zhou. Y., Chen, Y., Chen, P., & Xiao, W. BMSC Transplantation Aggravates Inflammation, Oxidative Stress, and Fibrosis and Impairs Skeletal Muscle Regeneration. *Frontiers in Physiology*, 2019. .10(February), 87. <https://doi.org/10.3389/fphys.2019.00087>
  23. Machado. M., Pereira. R., Sampaio-jorge, F., Knifis, F., & Hackney, A. Creative supplementation: effects on blood creatine kinase activity responses to resistance exercise and creatine kinase activity measurement. 45.2009.
  24. Mira Hayu Nindyowatidan Bambang Priyonoadi. (2016). Tingkat kecemasan atlet aeromodelling kelas free flight setelah mengalami cidera bahum menjelang pertandingan, 69-84.2016.

# Detection of Anti-GAD65 Antibodies in Sera of Diabetic Patients Using a Home-Made Latex Agglutination Kit

Alaa S. Alattabi<sup>1</sup>, Dhamiaa M. Hamza<sup>1</sup>, Khalid Khalil Alaaraji<sup>1</sup>,  
Sawsan M. Jabbar<sup>1</sup>, Abeer Thaher Naji AL-Hasnawi<sup>1</sup>, Ali Mansoor Jasim<sup>1</sup>

<sup>1</sup>Assist. Prof., Kerbala University, College of Medicine

## Abstract

**Objectives:** Compare sensitivity of anti-GAD65 result detected by ELISA with that one detected by home-made latex agglutination kit.

**Patients and Method:** Thirty seven patients were enrolled in this study from January, 2019 to March, 2019. The sample had been taken from patients attended diabetic unit in Imam Hussain medical city in kerbala. Informed consent was taken from each participant in the study. Serum samples were tested by ELISA technique (GAD65 ELISA Kit, CUSABIO BIOTECH CO., LTD. USA) and by home-made latex agglutination for anti-GAD 65.

**Results:** Data from the current study showed that readings of the home-made latex test are consistent with those detected by ELISA as a confirmatory test. When analyzed, results showed sensitivity 94.44% specificity 78.95%, positive predictive value 80.95%, negative predictive value 3.75%, positive likelihood 4.49, negative likelihood 0.07.

**Conclusion:** This home-made latex agglutination kit sensitive as ELISA could be used as a reliable test to detect anti GAD65 in diabetic patients.

**Keywords:** *Homemade latex kit, Anti-GAD56 antibody, LADA.*

## Introduction

Diabetes mellitus is a long standing metabolic disorder due to insufficient insulin secretion or no response for insulin result in increased blood glucose level leading to multiple signs and symptoms<sup>(1,2)</sup>. From etiological aspect Diabetes mellitus divide into four classes, class 1 diabetes mellitus, class 2 diabetes mellitus, gestational diabetes and other class of diabetes. The most common classes of diabetes are class 1 and class 2<sup>(3,4)</sup>. Regarding class latent autoimmune diabetes in adult (LADA), clinically similar to class 2 diabetes but still has shared character with class 1 diabetes which has most autoantibodies present in class 1 diabetes<sup>(5,6)</sup>. Age

of onset is commonly start after age of 35 years, at the beginning there is no need for insulin treatment<sup>(7)</sup>. The latent autoimmune diabetes in adult constitute around ten to thirty percent of classes 2 diabetes also refer as one and half class of diabetes or class 1.5 diabetes<sup>(5,8)</sup>. One of these antibody is **Glutamic acid decarboxylase autoantibodies (GADA)** which is neither beta cell nor islet specific, GADA firstly discovered in the serum of patients complaining from stiff man syndrome which is a rare neurological disorder<sup>(9)</sup>. In the neurons and pancreatic beta cells the glutamic acid convert to g-aminobutyric acid (GABA) by enzyme Glutamic Acid Decarboxylase<sup>(10)</sup>. Which can be measured to evaluate human disease<sup>(11)</sup> by different method like ELISA . Using latex particles coated with IgG is well known test currently applied for immunoassay investigation. In this study we compare sensitivity of GAD 65 result detected by ELISA with that one detected by home made latex agglutination kit.

---

### Corresponding Author:

**Alaa S. Alattabi**

Assist. Prof., Kerbala University, College of Medicine  
e-mail: alattabi486@gmail.com

## Patients and Method:

Thirty seven patient were enrolled in this study from January, 2019 to March,2019 all patients were attended diabetic unit in Imam Hussain medical city Ethically, all consents from patients and kerbala health director had been taken .

### Homemade latex agglutination test kit preparation:

A homemade latex agglutination test kit for the detection of anti-GAD 65 antibodies in serum was developed as follows:

- 1. Latex beads preparation:** These were purified from a latex kit for testing C-reactive protein (CRP). Simply, the beads were separated from the CRP antibody by elevating the pH (up to 9) by adding 1 M NaOH solution to the latex-antibody complex of the CRP kit content. Thereafter, incubation for 1 hour at 37 °C was done. This was shown to be enough to unbind the antibody from the latex beads. In order to purify the beads, mixture was centrifuged 10000 Xg for 30 minutes. Then, we got a clear supernatant and a pellet of beads which were harvested by discarding the supernatant. This was followed by three times wash-spin step with PBS and the beads were suspended in PBS to be read ready to bind the new antibody. A test was done for CRP using the positive control of CRP kit content and the reading was negative. This step was done to ensure that no anti-CRP antibody remnant was left behind.
- 2. Preparation of latex-antibody solution:** The detection antibody of anti-GAD 65 was ordered from (Abcam). Beads were mixed with the antibody (1 microgram/ml final conc.), pH was optimized at 7, and the mixture was incubated at 37°C for 20 hours. After that, the mixture was ready for use as

latex agglutination test reagent for the detection of anti-GAD 65 antibodies and stored at 4°C. [(Hideki et al. 2000), with some modifications]<sup>(12)</sup>.

### Homemade latex agglutination test kit evaluation:

A homemade latex agglutination test kit for serum detection of anti-GAD 65 antibodies was evaluated together with a commercially available enzyme-linked immunosorbent assay (ELISA) kit for their use for detection of anti-GAD 65. All patient serum samples were tested by ELISA technique (GAD65 ELISA Kit, CUSABIO BIOTECH CO.,LTD.USA) and by home-made latex agglutination for anti-GAD 65.

**Statistical Analysis:** To confirm the home-made latex kit results with those obtained by ELISA. Indicators like specificity, sensitivity, predictive values and likelihood determination were obtained when readings of both kits were analyzed using the biostatistic software Graph Pad Prism and Bayes Theorem Online Calculator.

## Results

Data from the current study showed that readings of the home-made latex test are consistent with those detected by ELISA as a confirmatory test. Number of patients that showed positive anti-GAD65 result for latex technique were 21 of 37 patients while those positive GAD65 tested by ELISA technique were 18 of 37 patients as showed in table (1). Number of patients that showed positive serum for anti-GAD65 antibody by both technique latex and ELISA were 17 patients while those showed positive serum for anti-GAD 65 antibody by latex technique only and negative for ELISA were 4 patients and only one patients positive serum for anti-GAD 65antibody by ELISA technique only as showed in table (2) . Sensitivity 94.44%, specificity 78.95%, positive predictive value 80.95%, negative predictive value 93.75%, positive likelihood 4.49, negative likelihood 0.07, accuracy 86.49%.

**Table (1): Seropositivity for Anti- GAD 65 antibody**

Anti-GAD65 +ve by ELISA	Anti-GAD 65 -ve by ELISA	Anti-GAD65 +ve by latex	Anti-GAD65 -ve by latex
18	19	21	16

**Table (2): Seropositivity for anti-GAD 65 antibody by latex and ELISA technique**

	Latex+ve anti-GAD 65	Latex-ve GAD 65	P value
ELISA+ve GAD65	17	1	0.00001
ELISA-ve GAD 65	4	15	

	<b>Latex+ve anti-GAD 65</b>	<b>Latex-ve GAD 65</b>	<b>P value</b>
Sensitivity of latex/ELISA	94.44%		
Specificity	78.95%		
Positive likelihood ratio	4.49		
Negative likelihood ratio	0.07		
Positive predictive value	80.95		
Negative predictive value	93.75%		
Accuracy	86.49%		

## Discussion

This homemade rapid latex test provide fast results, less expensive than ELISA and can easily be applied in routine laboratories in order to detect anti-GAD 65 antibodies thus facilitating the diagnosis of diabetes mellitus with a relatively high level of reliability

## Conclusion

This home-made latex agglutination kit sensitive as ELISA could be used as a reliable test to detect anti GAD65 in diabetic patients.

**Recommendation:** It is highly recommended to follow this technique in order to prepare homemade latex agglutination test kits for the detection of other important diagnostic and prognostic markers in diabetes and even other clinical conditions.

**Ethical Clearance:** The Research Ethical Committee at scientific research by ethical approval of both environmental and health and higher education and scientific research ministries in Iraq

**Conflict of Interest:** The authors declare that they have no conflict of interest.

**Funding:** Self-funding

## References

- Jayakumar A. Greenspan's Basic and Clinical Endocrinology. The Yale Journal of Biology and Medicine. 2012 Dec;85(4):559.
- American Diabetes Association. Standards of medical care in diabetes--2014. Diabetes care. 2014 Jan;37:S14.
- American Diabetes Association. Diagnosis and classification of diabetes mellitus. Diabetes care. 2009 Jan 1;32(Supplement 1):S62-7.
- Canadian Diabetes Association Clinical Practice Guidelines Expert Committee (2013). Definition, diagnosis and classification of diabetes mellitus prediabetes and metabolic syndrome 2013; 37: S8-S11.
- Stenström G, Gottsäter A, Bakhtadze E, Berger B, Sundkvist G. Latent autoimmune diabetes in adults: definition, prevalence,  $\beta$ -cell function, and treatment. Diabetes. 2005 Dec 1;54(suppl 2):S68-72.
- Krause S, Landherr U, Agardh CD, Hausmann S, Link K, Hansen JM, Lynch KF, Powell M, Furmaniak J, Rees-Smith B, Bonifacio E. GAD autoantibody affinity in adult patients with latent autoimmune diabetes, the study participants of a GAD65 vaccination trial. Diabetes Care. 2014 Jun 1;37(6):1675-80.
- Goel A, Chiu H, Felton J, Palmer JP, Brooks-Worrell B. T-cell responses to islet antigens improves detection of autoimmune diabetes and identifies patients with more severe  $\beta$ -cell lesions in phenotypic type 2 diabetes. Diabetes. 2007 Aug 1;56(8):2110-5.
- Palmer JP, Hampe CS, Chiu H, Goel A, Brooks-Worrell BM. Is latent autoimmune diabetes in adults distinct from type 1 diabetes or just type 1 diabetes at an older age?. Diabetes. 2005 Dec 1;54(suppl 2):S62-7.
- De Aizpurua HJ, Wilson YM, Harrison LC. Glutamic acid decarboxylase autoantibodies in preclinical insulin-dependent diabetes. Proceedings of the National Academy of Sciences. 1992 Oct 15;89(20):9841-5.
- Sorenson RL, Garry DG, Brelje TC. Structural and functional considerations of GABA in islets of Langerhans:  $\beta$ -cells and nerves. Diabetes. 1991 Nov 1;40(11):1365-74.

11. Pihoker C, Gilliam LK, Hampe CS, Lernmark Å. Autoantibodies in diabetes. *Diabetes*. 2005 Dec 1;54 (suppl 2):S52-61.
12. Kohno H, Akihara S, Nishio O, Ushihima H. Development of a simple and rapid latex test for rotavirus in stool samples. *Pediatrics International*. 2000 Aug 16;42(4):395-400.

# Effect of Polycythemia on Serum Lipid Profile and Oxidative Stress

Zainab Qasim<sup>1</sup>, Muhammad Al-Yasiri<sup>1</sup>

<sup>1</sup>Assistant Lect., Biology Department, College of Education for Girls, DhiQar University, Iraq

## Abstract

Polycythemia is generally known as a disorder that affects the stem cells in the bone marrow and is characterized by a high and excessive production of red blood cells. The current study was designed to investigate and investigate the relationship between the serum lipid profile and oxidative stress in polycythemia patients., The study included examining 85 blood samples from both gender, males and females, for patients coming to Shatra General Hospital. During the study period, all of (Hb, PCV, MDA, TC, TG, HDL, LDL, and VLDL) were examined for both patients and control groups.

The current study showed an increase in the incidence of polycythemia in males, while it decreased in females, and the study showed that the incidence of polycythemia increased with age until it reached its peak in the third age group 41-50 years, then the percentage gradually decreased to a minimum in the fifth age group 61-70 years .

The results of the study recorded a significant increase  $P < 0.05$  in both the concentration of hemoglobin Hb and the packed cell volume PCV in patients with polycythemia, both real and secondary, when compared with the control group. Also, the results of the present study showed: a significant decrease  $P < 0.05$  in cholesterol concentration in the group of true polycythemia compared with the control group. A significant increase  $P < 0.05$  in concentration of triglycerides (TG) was higher in the true polycythemia group and a high significant  $P < 0.05$  in the secondary polycythemia group compared with the control group.

The results indicated that there was a significant decrease  $P < 0.05$  in LDL concentration in the true polycythemia group, and a significant increase of  $P < 0.05$  in the secondary polycythemia group compared with the control group. The results of the study also recorded a high significant decrease  $P < 0.05$  in the true polycythemia group and a significant decrease  $P < 0.05$  in the secondary polycythemia group compared to the control group. The results also showed a significant increase  $P < 0.05$  with the concentration of VLDL in the group of true polycythemia and high Significant  $p < 0.05$  in the secondary polycythemia group compared with the control group.

The results showed a significant increase  $P < 0.05$  in MDA concentration in polycythemia patients compared with the control group.

**Keywords:** *Polycythemia, lipid profile, oxidative stress.*

## Introduction

**Polycythemia:** Polycythemia is generally defined as a disorder of the stem cells in the bone marrow

characterized by the abnormally high and excessive production of red blood cells<sup>(1)</sup>.

Polycythemia is a Greek term synonymous with Erythrocytosis, and literally translates to many cells in the blood<sup>(2)</sup>. Polycythemia is an uncommon clinical discovery, and one of its most important features is an increase in the number of red blood cells, as well as an increase in the concentration of hemoglobin (Hb) .and packed cell volume (PCV)<sup>(3,4)</sup>.

---

### Corresponding Author:

**Zainab Qasim**

Assistant Lect., Biology Department, College of Education for Girls, DhiQar University, Iraq  
e-mail: ssarizvi06@gmail.com

Blood cells are formed by the process of erythropoiesis, and this process is controlled by the feedback mechanism, as erythropoiesis is inhibited when the number of blood cells exceeds the normal limit, and the process stimulates when a decrease in the number of red blood cells occurs as in anemia or in the case of lack of oxygen and this control depends on the hormone circulating in the blood called erythropoietin, which is secreted primarily by the kidneys, where the bone marrow receptors respond to it, stimulating the production of red blood cells in it, which soon leaves it into the bloodstream to start its cycle and function in the gas transport, and thus the red blood cell count in the blood remains almost constant and the capacity of transporting oxygen in the blood is always sufficient for the body's needs, although red blood cells are affected by many factors such as age, gender, nutritional status, health status, and height above sea level<sup>(5)</sup>

### **Polycythemia is classified into two types:**

1. **Relative Polycythemia:** The relative polycythemia has been called: (Pseudo-polycythemia) is a condition in which an increase in the size of PCV cells occurs while the total mass of red blood cells (RCM) remains within normal limits and this occurs as a result of fluid deficiency and dehydration that lead to a decrease in blood plasma compared to cells as in the case of dehydration, diarrhea, vomiting and use of diuretics, capillary leak syndrome, and severe burns<sup>(6)</sup>.

2. **Absolute polycythemia:** It means the occurrence of a primary or secondary increase in the proportion of the volume of packed cell volume PCV, and there is a real increase in the mass of red RCM<sup>(7)</sup>, and it is of two types:

A. **Primary polycythemia (Polycythemia Vera):** True polycythemia (PV) is due to intrinsic factors of red cell precursors and bone marrow with increased numbers of red blood cells, as well as leukocytes and platelets. The disease begins with a latent thrombotic stage and is associated with an increased incidence of venous thromboembolism<sup>(1)</sup>.

It was found that there is a mutation that causes true polycythemia vera disease, which occurs in a gene called (The Janus kinase "JAK" 2), in exon 14 of chromosome 9, and this mutation was discovered in approximately 95% of patients with polycythemia vera and about 50% of people with Essential thrombocythosis and primary myelofibrosis<sup>(2)</sup>.

There was no accurate understanding of these thrombotic tendencies and the level of hematocrit (PCV) was, the only laboratory factor that showed a clear association with thrombosis and clinical symptoms to a large extent of increased erythropoiesis<sup>(3)</sup>.

B. **Secondary polycythemia:** Erythropoietin plays an essential role in controlling the production of red blood cells and is under the influence of partial pressure of oxygen gas (PO<sub>2</sub>). This hormone has a primary role in the excessive production of red blood cells (Polycythemia) by increasing the sensitivity of the bone marrow to this hormone or an increase in its production by the cells; in the kidneys due to the increase in the effectiveness of these cells, regardless of the partial pressure of oxygen, Secondary erythrocytosis occurs as a result of some diseases such as congenital heart disease, chronic respiratory disease, smoking, and living at altitudes where oxygen is lacking<sup>(1)</sup>. On the other hand, secondary polycythemia has a lower risk of blood clotting; despite higher hematocrit levels<sup>(4)</sup>.

Polycythemia can also increase blood viscosity, however there are no standard indicators of the disease to predict vascular events. The oxidative stress that has been detected in many patients occurs due to an imbalance between the generation of active oxygen species and other free radicals and antioxidants, the blood becomes more viscous and less able to flow through the blood vessels and organs of the body, and this slow blood flow is responsible for much of the symptoms of this disease<sup>(2)</sup>.

**Aim of Study:** In light of the above, we decided to conduct the current study in order to investigate the effect of polycythemia on the serum lipid profile and oxidative stress by studying the following criteria:

1. Measuring the serum lipid profile represented by CHO, TG, HDL, LDL and VLDL.
2. Measuring of serum MDA as biomarker for the oxidative stress.
3. Measuring the packed cell volume (PCV) ratio.
4. Measurement of hemoglobin Hb level in the blood.
5. Identify the largest infection rate among different age groups.
6. Comparing the infection rate between the two, gender and investigating the causes.

## Materials and Method

- 1. Blood Samples:** Blood samples were, collected from Polycythemia patients during their visit, to Shatra General Hospital/Laboratory Unit. (85) samples, were obtained from these patients distributed between. two sexes during the research period, their ages ranged between (20 - 70) years., and they were examined in the hematology and biochemistry laboratories.;

For the period from November./2017 to June/.2018, when 5 ml of blood was taken for each sample., 2 ml of the blood sample drawn in a test tube containing an anticoagulant. were placed for them to be tested for hemoglobin (Hb). and the percentage. of packed cell volume (PCV) in the hematology laboratory, 3 ml were placed, in an anticoagulant-free test tube. Serum was obtained by placing these tubes in a centrifuge; at a speed of 3000 rpm for 15 minutes. The serum was separated from the. thrombus by a micro pipette. Serum was placed in the labeled Eppendorf tubes., For the purpose of performing serum lipid profile (VLDL, LDL, HDL, TG, TC) and oxidative stress index .(MDA) tests, the same amount of blood was drawn from;healthy people (40) samples and the same tests were performed. for them for comparison purposes as they are control samples.

- 2. Hemoglobin and PCV Measurement:** Hemoglobin and packed cell volume, (PCV) were measured using a blood tester Coulter Horiba The Emerald Company of French origin.
- 3. Measurement of serum Lipid profile.**

**3-1.Measurement of Total Cholesterol (TC):** The total cholesterol concentration was measured in the blood serum samples by using a colorimetric reflectance spectrophotometric method,.. according to the method of <sup>(8)</sup> . By following the in.,structions attached to the measuring. kit prepared by Randox - UK, which contains several solutions,. The concentration of, total cholesterol in the blood serum is measured after it has been oxidized and hydrolysed, by enzymes, as the index., quinonemine, consists of,hydrogen peroxide H<sub>2</sub>O<sub>2</sub> and 4-aminoantipyrine in the presence, of phenol and peroxidase.. The amount of Quinonemine formed with a red pigment,gives the cholesterol concentration.

**3-2.Measurement of Triglycerides (T.G):** The concentration of T.G was measured in the serum samples,by colorimetric reflectance spectrophotometry; according to the method<sup>(9)</sup>., by following the instructions attached. to the test kit for measuring the concentration of, T.G, imported from Randox UK, this kit contains several solutions, The principle. of measuring the concentration of T.G in serum is based on the hydrolysis of. enzymes to glycerol.

**3-3.Measurement of High-density lipoprotein (HDL):** HDL concentration. was measured directlyin serum samples. by colorimetric reflectance spectrophotometry. by following the instructions attached to the. test kit for measuring, the concentration of. HDL, imported from Randox UK, this kit contains. many solutions and reagents.

**3-4. Estimation of low-density lipoprotein (LDL) and very low-density lipoprotein (VLDL):** Its concentrations were calculated based on the Friedewald equation and according. to <sup>(10)</sup> as follows:

$$\text{LDL} = \text{TC} - (\text{HDL} + \text{VLDL})$$

$$\text{VLDL} = \text{TG}/5$$

- 4. Estimation oxidative stress:**

**4-1.Malondialdehyde (MDA) assay:** The MDA concentration .(nmol/ml) in serum samples, for patients and control was measured .as biomarker for the oxidative stress, which is, Lipid Peroxidation Product. in human serum, it was determined by using the, method which described by <sup>(11)</sup>.

- 5. Determining the incidence of Polycythemia among males and females:**

$$\text{(Percentage of Polycythemia incidence)\%} = \frac{\text{(Class number/The total number)} * 100}{}$$

- 6. Divide Polycythemia patients into five age groups:**

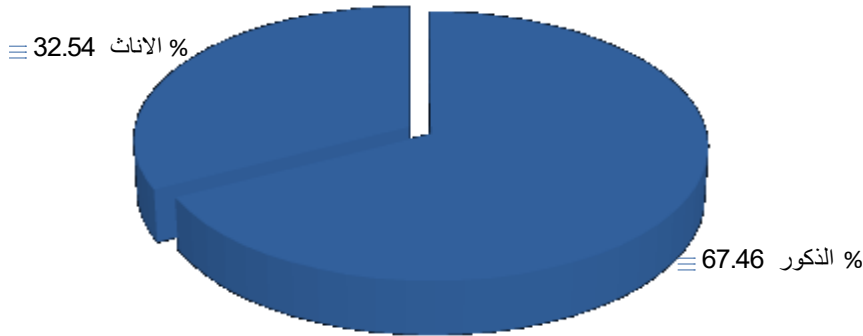
- The first age group. (20-30) years.
- The second age group, (31-40) years.
- The third age group, (41-50) years.
- The fourth age group, (51-60) years.
- The Fifth age group, (61-70) years.



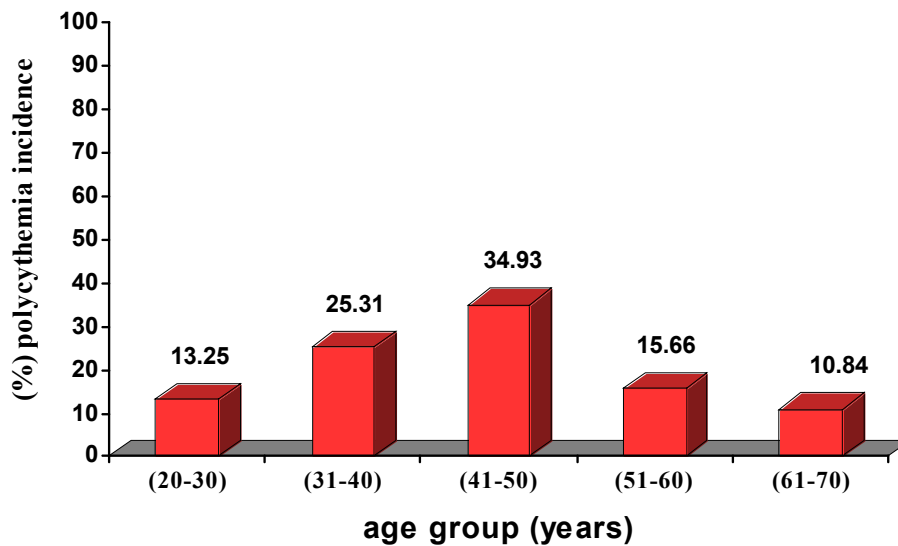
7. **Statistical analysis:** Statistical data, analysis was performed on SPSS 17.0 to determine the mean, standard deviation., and other variables . *p* value less than 0.05 was considered statistically significant.

**Results**

**Polycythemia relationship with gender:** The current study showed an increase in the percentage of polycythemia infection. in males, which was 67.46%, while it decreased in females to 32.54%.



**Figure 1: Polycythemia incidence, depending on gender.**



**Figure 2: Distribution of age groups in polycythemia patients.**

**Polycythemia relationship with age:** The current study showed, that the incidence of polycythemia .increased with age until it reached its peak in the third age group (41-50) years., and the rate was (34.93), then, the percentage gradually decreased to the lowest level, in the fifth age group (61-70) years., and it was (10.84).

**Effect of, polycythemia on concentration of hemoglobin and the PCV:** The results of the current, study recorded a significant increase (*P* <0.05) in the hemoglobin concentration (Hb) in patients with true and secondary polycythemia, : PV group (2) and non-

PV group (3), so the hemoglobin concentrations were.  $17.48 \pm 1.30$ ,  $17.15 \pm 1.24$  Respectively, compared to; the control group (1), where the Hb concentration was,  $14.39 \pm 1.06$ .

The results. also showed a significant increase (*P* <0.05) in (The packed cell volume (PCV) in patients. with true and secondary polycythemia, group (2) and group (3), so the PCV percentage, was  $56.70 \pm 2.42$ ,  $55.68 \pm 2.32$ , respectively, compared with the control. Group (1), which amounted to  $41.84 \pm 1.61$ , as shown in Table (1) below.

**Table (1): Effect of polycythemia on concentration of hemoglobin. and the PCV:**

Studied Parameters Groups	Hb (g/dL)	PCV (%)	Number of samples
(1) Control group	14.39±1.06 <sup>b</sup>	41.84±1.61 <sup>c</sup>	40
(2) PV group	17.15±1.24 <sup>a</sup>	56.70±2.42 <sup>a</sup>	40
(3) Non- PV group	17.48±1.30 <sup>a</sup>	55.68±2.32 <sup>b</sup>	45
LSD	0.34	0.59	-

- The values represent the mean ± the standard deviation.
- The letters a, b, c indicate a significant difference (P <0.05) between the studied groups depending on the value of LSD.

**Effect of polycythemia on serum Lipid profile:**

The, results of the current study showed through Table (2) that there was a significant decrease (P <0.05) in total cholesterol, TC concentration in group (2) it was 159.20 ± 22.59 compared; with the control group 193.02 ± 5.92, while the values of group (3) were 197.27 ± 15.96 An approach to a control (1).

The results; also recorded a significant increase (P <0.05) with the concentration of triglycerides TG in group (2) 148.59 ± 43.27 and a high, significant increase (P <0.05) in group (3) 179.56 ± 61.71 compared, to the control group (1) 119.83 ± 10.77.

The results indicated; a significant decrease (P <0.05) with LDL concentration in group (2) 92.45 ±

21.67 and a significant increase. (P <0.05) in group (3) 124.77 ± 44.52 compared; with the control group (1) 113.69 ± 27.76.

The results of the study,also recorded a high significant decrease (P <0.05) of HDL concentration in group (2) 42.02 ± 10.35;and a significant decrease (P <0.05) in group (3) 51.41 ± 6.60 compared, to the control group (1) 56.49 ± 2.18.

The results also showed, that there was a significant increase (P <0.05) with VLDL concentration in group (2) 29.86 ± 8.06 and; a high significant increase (P <0.05) in group (3) 35.92 ± 9.42,compared with the control group (1) 24.03 ± 4.53.

**Table (2): Effect of polycythemia on serum Lipid profile:**

Groups Studied Parameters	(1) Control group	(2) True polycythemia (PV group)	(3) Secondary polycythemia (Non- PV group)	LSD
TC (mg/dL)	193.02±5.92 <sup>a</sup>	159.20±22.59 <sup>b</sup>	197.27±15.96 <sup>a</sup>	5.11
TG (mg/dL)	119.83±10.77 <sup>c</sup>	148.59±43.27 <sup>b</sup>	179.56±61.71 <sup>a</sup>	14.78
LDL (mg/dL)	113.69±27.76 <sup>b</sup>	92.45±21.67 <sup>c</sup>	124.77±44.52 <sup>a</sup>	10.67
HDL (mg/dL)	56.49±2.18 <sup>a</sup>	42.02±10.35 <sup>c</sup>	51.41±6.60 <sup>b</sup>	1.91
VLDL (mg/dL)	24.03±4.53 <sup>c</sup>	29.86±8.06 <sup>b</sup>	35.92±9.42 <sup>a</sup>	2.64

- The values represent the mean ± the standard deviation.
- The letters a, b, c indicate a significant difference (P <0.05) between the studied groups depending on the value of LSD.

**Effect of polycythemia on Oxidative stress:** The results of the current, study showed through Table (3) that there was a significant increase (P <0.05) in the MDA

concentration,(nmol/ml) for a group of polycythemia patients, it was; (0.49 ± 0.04) compared to the control group that amounted to (0.07 ± 0.01).

**Table (3): Effect of polycythemia on Oxidative stress**

Groups Studied Parameter	(1) Control group	(2) Patients group	p value <sup>a</sup>
MDA (nmol/ml)	0.07 ± 0.01 <sup>b</sup>	0.49 ± 0.04 <sup>a</sup>	<0.05
Number of samples	40	85	-

Values are,expressed as mean ± SD.

a,b For significant comparison, between control and Patients groups.

## Discussion

**Polycythemia relationship with gender:** Figure (1) shows that the percentage, of polycythemia infection in males increased to 67.46%, while; it decreased in females to 32.54%. The reason for this may be attributed to smoking,as this phenomenon is more common among males than in females.

There is also a relationship, between smoking and an increase in blood viscosity, as smoking causes a significant, increase in the total hemoglobin concentration in smokers compared to nonsmokers. This may be attributed to the, fact that smoking .leads to a decrease in the volume of blood plasma, which causes an increase in the mass of,red blood cells as a result of poor blood supply with oxygen and the lack of,hemoglobin binding With oxygen (Hb-O), thus causing blood poisoning and increasing; its viscosity, the condition worsens with the increase in the duration. and number of smoking. These results are identical to those of<sup>(12)</sup>.

Smoking in all its; forms is considered one of the biggest pests that afflict society and has been described, by the Centers for Health Control and Prevention in the United States as the only preventable. and most important threat to human; health in developed .countries and is the most important cause of premature death worldwide<sup>(13)</sup>.

As polycythemia is an increase in the number of red blood cells in the blood that usually affects adults over the age of fifty, but it may affect people; in the age group between,fifteen to ninety, and it is more in men compared .to women. It is the abnormal,increase in the number of red blood cells; The percentage of PCV hematocrit reaches more than 52%,in men and more than 47% in women. Which leads to an increase in blood viscosity and the consequent,risks of complications<sup>(7)</sup>.

**Polycythemia relationship with age:** The current study indicates through Figure,(2) that the incidence of polycythemia,increased with age, until it reached its.

peak in the third age group (41-50) years old, as the rate was, (34.93), after which the percentage gradually decreased; to a minimum in the fifth age group (61-70) years, it was (10.84). The reason for this may be due to taking some medications, as it was observed that the hemoglobin level increased,significantly when diuretics were taken,, which leads to dehydration,. Also, an increase in the level was observed in severe burns. And stress<sup>(14)</sup>, high blood pressure, and also during long-term tobacco. smoking, as well as the increase, in psychological pressures and difficulties of life and the increase in responsibilities, in this particular age group and the accompanying. psychological and physical stress<sup>(15)</sup>.

This increase. is true or primary when it includes an increase in the number of white blood cells and platelets in addition' to an increase in red cells, then it is called;(polycythemia vera), This occurs as a result of infection with some diseases such as congenital heart; disease and chronic respiratory disease, as well as smoking,, and living on altitudes where oxygen is lacking<sup>(1)</sup>. The cause of polycythemia; may also be a defect in the production of the hormone Erythropoietin, which. regulates the production of red blood cells, as in the case of various,body tumors such as those affecting the kidneys, liver, lung, brain and uterus, And the people at risk. of developing erythropoiesis are smokers and those with heart or lung disease And people exposed, to psychological,and physical stress, and people with a family history; of infection<sup>(2)</sup>.

As for the. gradual decrease in the incidence rate after this group, it may be due to the increase in deaths as an inevitable result after suffering, the afflicted person with many;diseases that exhausted his health and;claimed his life<sup>(6)</sup>.

**Effect of polycythemia on concentration of hemoglobin and the PCV:** The results; of the current study recorded through Table No. (1) the presence of a significant, increase (P <0.05) in both the concentration

of hemoglobin. (Hb) and the PCV packed cell volume, in patients with both types of real and secondary compared to the control group because these two indicators. are the most important characteristics of polycythemia As well as increasing the number of red blood cells., this is in agreement with a study presented by (7).

Polycythemia vera is, a myeloproliferative disorder, when the. body intensively produces red blood cells without. affecting the hormone erythropoietin,. While secondary polycythemia, is characterized by an increase in hemoglobin due to the effect. of that hormone<sup>(2)</sup>.

#### **Effect of polycythemia on serum Lipid profile:**

Table (2) shows that there, was a significant decrease ( $P < 0.05$ ) in the total cholesterol TC concentration. in group (2) true polycythemia, compared with control group,(1) While a non-significant increase was found in group (3) secondary polycythemia;compared to control group .

This is in agreement, with the study Fujita, H. *et al.*<sup>(16)</sup> where polycythemia PV is classified as necrotic tumors of the bone, marrow that reduce the level of cholesterol, as a result of the. increased demand for cholesterol by the damaged cell membranes in the bone. marrow <sup>(17)</sup>.

Also, there is a relationship; between the free cholesterol and the red blood cell count RBC, Hb and PCV, It is expected, that the cause of the lack of cholesterol associated with polycythemia vera is the;retention and isolation of cholesterol spread coinciding, with an increase in RBC numbers, This does not occur in secondary, polycythemia due to an increase in all blood components without exception. and not RBC alone as in the case of polycythemia vera <sup>(16)</sup>.

The results; also recorded a significant increase ( $P < 0.05$ ) in the .concentration of triglycerides TG in group (2) and a high significant increase ( $P < 0.05$ ) in group (3) compared, to the control group (1). The reason for this may be due to smoking as well, as many indicated, From studies; to the presence of an increase; in the concentration of serum fats in the blood of smokers<sup>(12)</sup>.

The reason for this increase may be attributed to the fact that smoking works on the presence of different; mechanisms that lead to a change in the level of fats, the .most important of which are: Nicotine stimulates the, sympathetic nerves in the adrenergic gland, which leads to an increase, in the secretion of hormones (Epinephrine and norepinephrine), which leads to an

increase; in the lipase enzyme and the concentration; of free fatty acids (FFA) in the plasma, and this leads to an increase in the secretion of (TC) and triglycerides, in the bloodstream<sup>(18)</sup>.

The results indicated; a significant decrease ( $P < 0.05$ ) in the concentration of low-density lipoprotein LDL, in group (2) and a significant increase ( $P < 0.05$ ) in its concentration. in group (3) compared with the control group (1). The cause of the high fat may be the, consumption of diets rich in fat and cholesterol as well as a diet low in fiber and grain content.<sup>(14)</sup>.

As for the reason for the decrease in group (2), it may be attributed to the decrease in the cholesterol level of people with true polycythemia due to the presence of a close; association between them <sup>(19)</sup> .

The results of the study; also recorded a high significant decrease ( $P < 0.05$ ) in the concentration of, HDL lipoprotein in group (2) and a significant decrease ( $P < 0.05$ ) in group (3) compared, with the control group (1) and the reason may be that lipid metabolism can be It is altered by acute and chronic. infections that participate in increasing, plasma concentrations of cytokines, Studies have shown that a number of cytokines, such as tumor necrosis factor (TNF- $\alpha$ ) and interleukin (IL-1 $\beta$ ) are believed; to have effects on lipid metabolism and blood change dynamically <sup>(20)</sup>.

Lipolysis increases in adipose tissue, as is the removal of triglycerides neutralized, cholesterol (TG) and low-density lipoproteins (LDL) due to the decrease in the .activity of the lipoprotein lipase enzyme. Thus, any case, raises the level of, cytokines (TNF- $\alpha$ ) and interleukin (IL-1 $\beta$ .) In the blood .that has the potential; to cause lipid-raising <sup>(14)</sup>.

The main features; of this catabolic state are lipid peroxidation, elevation of free fatty acids, elevated. cholesterol, level of neutrophilic triglycerides (T.G), and level of low-density, lipoproteins (LDL) <sup>(14)</sup>.

The increased concentration; of LDL in the blood of these, patients leads to the possibility of its deposition in the arteries unites with calcium, and leads to narrowing and hardening of .the arteries, and consequently the occurrence of thrombosis, and arteriosclerosis <sup>(19)</sup>.

High-density .lipoproteins levels (HDL) in the current study showed a significant decrease compared with, the control group. The reason for this may be

attributed to the oxidative stress occurring in the;patients as a result of lipid peroxidation, which is,evident by the high concentration of MDA, and this is consistent with the .findings of Hamza et. al. (21), which promotes lipolysis in .adipose tissues, and the plasma concentration of; free fatty acids increases as it moves to the liver and muscles, and in the liver. some free fatty acids are oxidized; and most of them are returned The process of esterification into (TG) increases. the level of (TG) in the blood and the level of HDL decreases (20).

The results; also showed a significant increase (P <0.05) with the .concentration of very low density, lipoprotein (VLDL) in group (2) and a high significant increase (P <0.05) in group (3) compared with the; control group (1). The reason for this may be attributed to the increase. In triglycerides, because there is a close relationship. between them, according to the equation(21):

$$\text{VLDL} = \text{TG}/5.$$

It was found that; a high level of triglycerides neutralized .cholesterol (TG) leads to an increase in the .level of very low-density lipoprotein (VLDL) because they contain a large proportion of triglycerides neutralized to cholesterol and thus lower, levels of high-density lipoproteins associated with cholesterol, HDL-C(14).

#### **Effect of polycythemia on Oxidative stress:**

The results of the current study showed a significant increase in malondialdehyde, (MDA) concentration in polycythemia,patients compared with the control .group, which expresses the presence of oxidative; stress status as the final,product of lipid peroxidation., This is in agreement with results presented by Pérez - Rodríguez L, et al.(14) that .demonstrated,that lipid peroxidation index levels,(plasma levels of MDA and hydroperoxidase) contrast with levels of circulating lipids (triglycerides and cholesterol) .

We studied MDA as an oxidative .stress parameter in polycythemia patients and found that there is a close correlation. between the lipid profile and the increased oxidative stress, which believed that, lead to conventional cardiovascular risk factors, and that the increase in lipid;peroxidation is due to the oxidative stress that occurs when peroxides override the antioxidant mechanism and the dynamic balance between oxidants and,antioxidants is disturbed(15).

Several studies have confirmed the .presence of a change in the serum lipid profile during oxidative stress, as well as; a relationship between atherosclerosis and coronary heart disease in patients .with polycythemia (1).

Oxidative stress is caused by an increase. reactive oxygen radicals inside cells, Which in turn,leads to lipid peroxidation, Thus causing cell damage and then death, determination of serum MDA level gives an indication of lipid peroxidation levels(14).

A study presented by Vener *et al.* (6) show that the patients with polycythemia they have an increase in oxidative,stress and that this increase was associated with a high level of,homocysteine.

It has been suggested that increased, oxidative stress may be correlated with vascular .events in as well as the mutagenesis such as JAK2V617F .mutation in PV patients (1).

Aliyazicioglu Y, *et al.* (22)shown. that JAK2V617F mutation played a major role in the pathogenesis of .myeloproliferative diseases, particularly PV, while some studies suggest, that JAK2V617F mutation .may not be the initiator of the disease, It has been found that oxidative stress, parameters were similar in patients who were negative and positive,for the JAK2V617F mutation(2). They considered that it is late;genetic event can occur in patients with myeloproliferative disease, and The role played by free radicals which causing DNA damage and cellular oxidative,damage pathways(14).

### **Conclusions**

1. The incidence of polycythemia is more common in males compared to females.
2. The age group (41-50) years is,the most likely to have polycythemia.
3. Increased hemoglobin Hb concentration; and compressed cell volume in patients with polycythemia, both true,and secondary types, PCV.
4. Decrease in cholesterol,concentration .in true polycythemia patients compared with the control group.
5. An increase in the concentration .of triglycerides TG in patients with polycythemia.
6. Decreased concentration of HDL for people with polycythemia.

7. The high concentration of low-density lipoprotein (LDL) in patients with secondary polycythemia .and lower in those with true polycythemia.
8. The high concentration of MDA in patients with polycythemia.
9. There is a strong correlation;between oxidative stress and the lipid profile.

#### **Recommendations:**

1. Refrain from smoking .because smoking,leads to an increase in the non-oxidized .hemoglobin,to more than 10% of the total hemoglobin rate, and this is accompanied by an increase in the number of .red blood .cells to compensate for the inability of the cells to transport oxygen.
2. Conducting a PCV analysis, the volume of compressed cells, as well as knowing, the percentage of hemoglobin in the blood, and constantly testing the complete blood picture;for patients with polycythemia to avoid the deterioration of the disease and try to correct it.
3. The existence. of a special record for every .family that has people with this disease to know the extent of the possibility of,transmitting it genetically.
4. Donating blood from time to time for people; with polycythemia.
5. Using aspirin under. the supervision of a doctor to reduce blood clotting and increase, its liquidity, and thus reduce the incidence of stroke or coronary heart disease.
6. The patient is advised to drink sufficient quantities of water regularly to maintain. the normal amount of fluids in the body and maintain. the health of the kidneys.
7. We advise the patient. to follow healthy eating method rich in antioxidants and to return to the food pyramid. And leave or reduce the. eating of red meat.

**Ethical Clearance:** The Research Ethical Committee at scientific research by ethical approval of both environmental and health and higher education and scientific research ministries in Iraq

**Conflict of Interest:** The authors declare that they have no conflict of interest. **Funding:** Self-funding

#### **References**

1. Durmus A, Mentese A, Yilmaz M, Sumer A, Akalin I, Topal C, et al. The thrombotic events in polycythemia vera patients may be related to increased oxidative stress. *Medical Principles and Practice.* 2014;23(3):253–258.
2. Akalin I, Armangil D, DURMUŞ A. Neonatal polycythemia may be free of JAK2V617F mutation. *Türkiye Klinikleri Tıp Bilimleri Dergisi.* 2013;33(1):132–137.
3. Kilpivaara O, Levine RL. JAK2 and MPL mutations in myeloproliferative neoplasms: discovery and science. *Leukemia.* 2008;22(10):1813–1817.
4. Policitemia GIS. Polycythemia vera: the natural history of 1213 patients followed for 20 years. *Annals of Internal Medicine.* 1995;123(9):656–664.
5. Eroschenko VP, Di Fiore MS. DiFiore’s atlas of histology with functional correlations. Lippincott Williams & Wilkins; 2013.
6. Vener C, Novembrino C, Catena FB, Fracchiolla NS, Gianelli U, Savi F, et al. Oxidative stress is increased in primary and post- polycythemia vera myelofibrosis. *Experimental hematology.* 2010;38(11):1058–1065.
7. McMullin MF. Idiopathic erythrocytosis: a disappearing entity. *ASH Education Program Book.* 2009;2009(1):629–635.
8. Allain CC, Poon LS, Chan CS, Richmond W, Fu PC. Enzymatic determination of total serum cholesterol. *Clinical chemistry.* 1974;20(4):470–475.
9. Coxon B, Schaffer R. Characterization and quantitative analysis of D-glucose for use in clinical analysis. *Analytical chemistry.* 1971;43(12):1565–1570.
10. Friedewald WT, Levy RI, Fredrickson DS. Estimation of the concentration of low-density lipoprotein cholesterol in plasma, without use of the preparative ultracentrifuge. *Clinical chemistry.* 1972;18(6):499–502.
11. Yagi K. Lipid peroxides and related radicals in clinical medicine. In: *Free radicals in diagnostic medicine.* Springer; 1994. p. 1–15.
12. Waqar A. Effect of tobacco smoking on the lipid profile of teenage male population in Lahore City. *International Journal of Medicine and Medical*

- Sciences. 2010;2(6):171–177.
13. El-Nachef WN, Hammond SK. Exhaled carbon monoxide with waterpipe use in US students. *JAMA*. 2008;299(1):36–38.
  14. Pérez-Rodríguez L, Romero-Haro AA, Sternalski A, Muriel J, Mougeot F, Gil D, et al. Measuring oxidative stress: the confounding effect of lipid concentration in measures of lipid peroxidation. *Physiological and Biochemical Zoology*. 2015;88(3):345–351.
  15. Birben E, Sahiner UM, Sackesen C, Erzurum S, Kalayci O. Oxidative stress and antioxidant defense. *World Allergy Organization Journal*. 2012;5(1):9–19.
  16. Fujita H, Hamaki T, Handa N, Ohwada A, Tomiyama J, Nishimura S. Hypcholesterolemia in patients with polycythemia vera. *Journal of Clinical and Experimental Hematopathology*. 2012; 52(2):85–89.
  17. Vardiman JW, Thiele J, Arber DA, Brunning RD, Borowitz MJ, Porwit A, et al. The 2008 revision of the World Health Organization (WHO) classification of myeloid neoplasms and acute leukemia: rationale and important changes. *Blood*. 2009;114(5):937–951.
  18. Shai I, Rimm EB, Hankinson SE, Curhan G, Manson JE, Rifai N, et al. Multivariate assessment of lipid parameters as predictors of coronary heart disease among postmenopausal women: potential implications for clinical guidelines. *Circulation*. 2004;110(18):2824–2830.
  19. Grundy SM. Role of low-density lipoproteins in atherogenesis and development of coronary heart disease. *Clinical chemistry*. 1995;41(1):139–146.
  20. Kontush A, Guérin M, Chapman MJ. Spotlight on HDL-raising therapies: insights from the torcetrapib trials. *Nature Clinical Practice Cardiovascular Medicine*. 2008;5(6):329–336.
  21. Hamza MA, Abdulla IT, Hamza EA. Effect of oxidative stress on lipid profile and blood parameters to a sample of students at university of Zakho during exams. *Tikrit Journal of Pure Science*. 2018;23(1):78–82.
  22. Aliyazicioglu Y, Demir S, Turan I, Cakiroglu TN, Akalin I, Deger O, et al. Preventive and protective effects of Turkish propolis on H<sub>2</sub>O<sub>2</sub>-induced DNA damage in foreskin fibroblast cell lines. *Acta Biologica Hungarica*. 2011;62(4):388–396.

# The Significance of Serum Albumin Level as an Indicator for Severity of Hypertensive Disorders in Pregnancy in Samawa City

Wurood Mahdi Sale<sup>1</sup>, Ryam Falih<sup>2</sup>, Ayat Mohammad<sup>2</sup>

<sup>1</sup>Lect., Department of Gynecology & Obstetrics, College of Medicine, Al-Muthanna University, Iraq,

<sup>2</sup>Researcher, Al Muthanna Health Directorate Al-hussein Teaching Hospital, M.B.Ch.B.

## Abstract

**Background:** This study is concerned with determining the severity of preeclampsia according to the value of serum albumin. Materials and Method : 100 women were divided into 4 groups according to their blood pressure [control (n=22), gestational hypertension (n=25), mild preeclampsia (n=29), severe preeclampsia (n=24)]. Concerning about comparison of serum albumin level for each woman. Also the following informations were taken in consideration: age, gestational age, parity, systolic blood pressure and diastolic blood pressure. Results : comparing serum albumin level between the groups shows a significant difference ( $p < 0.05$ ). Analysis of data shows a significant difference in age between control and severe preeclampsia ( $p = 0.04$ ). The difference in gestational age was significant between control and other groups ( $p < 0.05$ ) and a statistically significant difference in systolic and diastolic blood pressure between the groups ( $p < 0.05$ ). Conclusion: This study showed that serum albumin level is lower in mild and severe preeclampsia in comparison with normal and hypertensive cases.

**Keywords:** *Pregnancy; Preeclampsia; Severe preeclampsia; Serum albumin.*

## Introduction

Preeclampsia is a hypertensive disorder with multisystem involvement, usually occurs after 20 weeks of gestation<sup>(1)</sup>. Hypertension approximately occurs in 12-22% of pregnancies<sup>(2)</sup>. The general prevalence of preeclampsia in pregnancy is between 2-8 % of all pregnancies<sup>(3)</sup>. Incidence of eclampsia in Baghdad; Iraq according to World Health organization research in 2010 was 20.28%<sup>(4)</sup>. Perinatal mortality rates are increased 2- to 3- folds in hypertensive mothers and early onset preeclampsia is associated with a 4- folds increased in stillbirth risk<sup>(1)</sup>. During the past two decades, the incidence of preeclampsia has increased by 25% in the united states<sup>(5)</sup>.

Preeclampsia is characterized by an elevated blood pressure equal to or more than 140/90 mmHg on two separated occasions in a previously normotensive woman, accompanied by proteinuria (300 mg in 24 hours) and blood pressure normalizes by six weeks postpartum<sup>(6)</sup>. Severe preeclampsia is diagnosed in the presence of these criteria: -(1) systolic blood pressure greater than 160 mmHg or diastolic blood pressure greater than 110 mmHg (2) thrombocytopenia – platelet counts less than 100,000 $\mu$ L-; (3) epigastric pain or liver transaminase levels twice normal; (4) pulmonary edema; (5) retinal hemorrhages or papilledema<sup>(1)</sup>.

Hypertensive disorders of pregnancy include : gestational hypertension, preeclampsia, eclampsia and chronic hypertension<sup>(7)</sup>. Gestational hypertension characterized by raised blood pressure of  $\geq 140/90$  mmHg without proteinuria ( $< 300$ mg per 24 hours) . Preeclampsia is defined as raised blood pressure of  $\geq 140/90$  mmHg on two separated readings, that is first discovered in the second trimester of pregnancy and proteinuria  $\geq 300$  per 24 hours . Eclampsia is preeclampsia

---

### Corresponding Author:

**Wurood Mahdi Sale**

Lect., Department of Gynecology & Obstetrics, College of Medicine, Al-Muthanna University, Iraq  
e-mail: mustafa7salah@gmail.com



superimposed by convulsions . Chronic hypertension is a hypertension diagnosed before pregnancy<sup>(3)</sup>.

The mechanisms of hypertension in pregnancy are largely unknown<sup>(2)</sup>. The pathophysiology of preeclampsia is thought to be placental<sup>(3)</sup>. Women with abnormal pregnancies e.g. hydatiform mole, suggesting that the presence of trophoblast tissue provides a trigger for the illness . Biopsies of placental bed reveal a patchy trophoblastic invasion in preeclampsia. The cause is not known but may reflect abnormal adaptation of maternal immune system<sup>(6)</sup>. The specific risk factors that predispose to preeclampsia:

- 1) First pregnancy
- 2) Preeclampsia in any previous pregnancy
- 3) family history of preeclampsia
- 4) Age  $\geq$  40 years
- 5) Body mass index  $\geq$  35
- 6) Multiple pregnancy
- 7) Proteinuria  $\geq$  0.3g/24 hour or diastolic blood pressure  $\geq$  80 mmHg at booking visit
- 8) preexisting diseases including e.g. renal disease, diabetes, antiphospholipid syndrome, chronic hypertension and autoimmune disease<sup>(6,8)</sup>.

Prevention of preeclampsia is best started before 16 weeks gestation in which most of the transformation of the spiral arteries occurs, to avoid the maternal and perinatal complication<sup>(9)</sup>.

1. Dietary changes and exercise: Interventions include aerobic exercise and weight loss, reduce salt intake, increase potassium intake, zinc supplementation and magnesium supplementation<sup>(3,9)</sup>.
2. Trial of aspirin: A trial of aspirin (150 mg) might be effective in prevention of preeclampsia if used at week 16 till the end of 32 weeks of pregnancy<sup>(3)</sup>.
3. Vitamin D may have a protective role against preeclampsia<sup>(9)</sup>.
4. Antioxidant vitamins: A high dose of antioxidants e.g. vitamins E and C can be used for preeclampsia prevention<sup>(3)</sup>.

## **Complication of preeclampsia<sup>(10)</sup>:**

### **A. Maternal Complication**

1. Seizure
2. Hypertensive encephalopathy or cerebral edema due to vasospasm and hypoxia
3. Intracranial hemorrhage
4. Renal dysfunction
5. Retinal detachment
6. HELLP syndrome (defined as : hemolysis, elevated liver enzyme levels and low platelet levels) .
7. Placental abruption
8. Systolic and diastolic myocardia dysfunction and pulmonary edema .
9. DIC and hemorrhage
10. Death

**B. Perinatal Complication:** Including stillbirth or neonatal death, bronchopulmonary dysplasia, oligohydramnios and fetal growth restriction, it has been estimated that 9-20 % of stillbirth is directly related to hypertensive disorder of pregnancy. Preeclampsia is a significant contributor to iatrogenic preterm birth and neonatal morbidity<sup>(11)</sup>.

## **Material and Method**

This cohort study was done in Al Samawah maternal and child teaching hospital, enrolled between August 2018 and November 2018 . Total 100 women, age between 17-26 years who participated in the study were divided into 4 groups:

1. Control group; 22 women having no hypertension.
2. 25 women with hypertension and no protein in urine.
3. 29 women with mild preeclampsia.
4. Severe preeclampsia group consist of 24 women.

This study was approved the medical ethics committee of the college of medicine university of Al Muthanah . In the selected cases we exclude chronic illnesses such as chronic kidney diseases, chronic hypertension and diabetes mellitus.

We are concerned about the age, weeks of gestation, systolic blood pressure and diastolic blood pressure for each woman in this study . A blood samples were aspirated for the estimation of serum albumin level and the reference value is 3.40 g/dl – 4.8 g/dl . For estimation of albumin in urine, a random urine specimen was collected and a dipstick urine measurement for albumin was done . To evaluate the distribution of blood pressure and serum albumin we divided the groups into

2 subgroups according to the age : G1(17-21) years and G2 (22-26) years.

**Results**

The results of the distribution of blood pressure and serum albumin are shown in Table (1). There was no significant difference between the age groups (p>0.05) for all our involved groups.

**Table (1): Distribution of systolic,diastolic blood pressure and serum albumin according to age groups for control, Gestational hypertension, mild preeclampsia and sever preeclampsia groups.**

Sever Preeclampsia			Mild Preeclampsia			Gestational Hypertension			Control			Age groups (years)
Serum albumin g/dl	DBP	SBP	Serum albumin g/dl	DBP	SBP	Serum albumin g/dl	DBP	SBP	Serum albumin g/dl	DBP	SBP	
2.855±0.050	113.56±3.358	163.44±2.651	3.136±0.087	103.50±2.309	152.56±1.788	3.44±0.04	94.75±3.38	142.58±2.021	3.621±0.111	79.00±1.12	114.75±4.35	G1 17-21
2.841±0.044	116.60±3.680	166.40±3.776	3.167±0.078	104.46±2.634	153.23±2.242	3.415±0.053	97.15±2.57	144.38±2.181	3.616±0.112	78.10±0.99	115.9±3.87	G2 22-26
0.649	0.857	0.212	0.463	0.445	0.468	0.065	0.431	0.90	0.979	0.750	0.102	P value

\*Represents a significant difference at p≤0.05 using independent sample T test. Data are expressed as Mean ±SD .SBP=Systolic blood pressure (mmHg).DBP=Diastolic blood pressure (mmHg).

**Maternal Characteristics Analysis:** The clinical characteristics of 100 pregnant women are shown in Table (2). There were no significant differences in age between control group and gestational hypertension (p= 0.65), control group and mild preeclampsia group (p=0.9) . But there was a significant difference between control group and severe preeclampsia group (p =0.04).

The analysis of parity shows no significant between control and gestational hypertension, mild preeclampsia and sever preeclampsia (p= 0.84, p = 0.51 and p= 0.23 respectively) .

Gestational age analysis shows the following results; the differences between control and the other groups were significant (p < 0.05).

**Table (2): Comparison of maternal characteristics between control,gestational hypertension, mild and sever preeclampsia groups.**

Number	Control	Gestational hypertension	Mild Preeclampsia	Sever Preeclampsia	P value
	22	25	29	24	
Age (years)	21.091±1.477	21.320±1.2819	21.034±2.3827	22.125±1.4283	a-0.111 b-0.65 c-0.9 d-0.04
Parity	0.818±0.795	0.76±0.83	1.00±1.10	1.167±1.12	a-0.47 b-0.84 c-0.51 d-0.23
Gestational age (weeks)	39.045±0.7854	37.8±0.7638	36.00±0.8018	36.00±0.978	0.000

\*Represents a significant difference at p ≤ 0.05 using ANOVA. Data are expressed as Mean ± SD./=statistical analysis is not implemented. a-represents the total difference between the groups, b-represents the difference between control and gestational hypertension, c-represents the difference between control and mild preeclampsia,d-represents the difference between control and sever preeclampsia. NS = not significant.

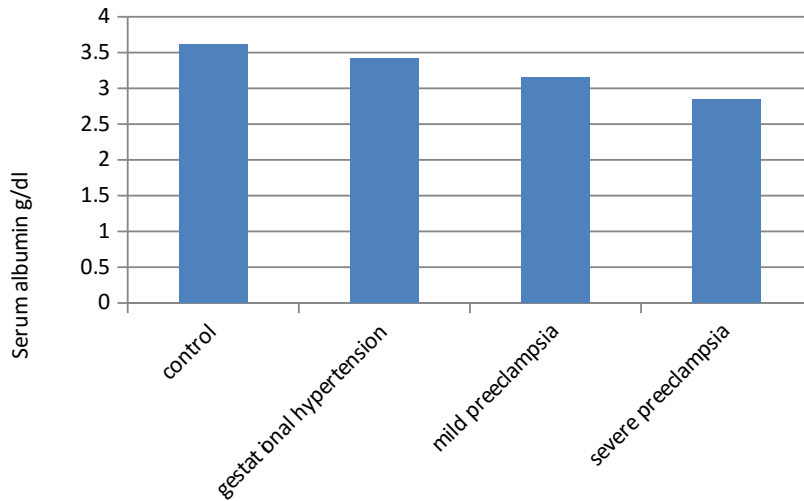
**Serum albumin and blood pressure analysis:** The results are shown in Table (3) . The analysis shows a statistically significant difference in serum albumin level between control,gestational hypertension,mild preeclampsia and sever preeclampsia ( $p<0.05$ )

There was a statically significant difference in systolic and diastolic blood pressure between control and the other groups ( $p<0.05$ ).

**Table (3): Comparison of serum albumin,systolic and diastolic blood pressure between the studied groups.**

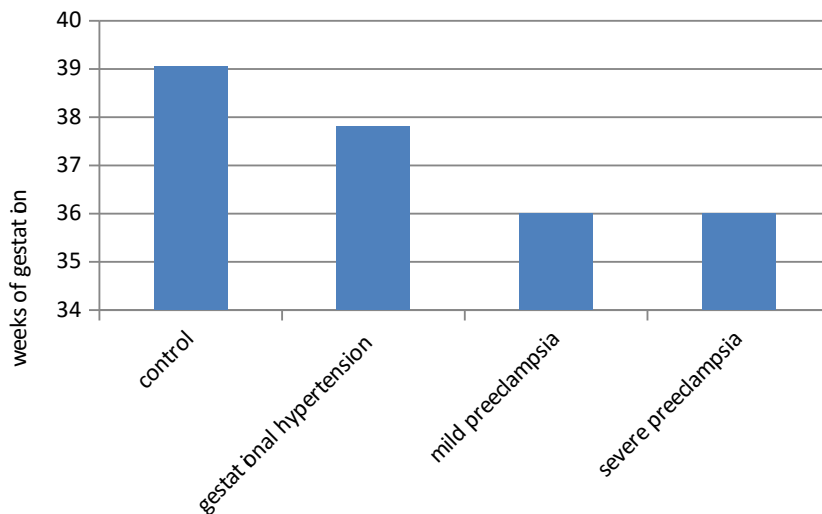
	Control	Gestational Hypertension	Mild preeclampsia	Sever preeclampsia	P value
S. albumin g/dl	3.61±0.109	3.42±0.048	3.15±0.0831	2.84±0.046	0.000
Systolic blood pressure (mmHg)	115.27±4.18	143.52±2.256	152.86±2.38	165.29±3.64	0.000
Diastolic blood pressure (mmHg)	78.59±1.14	96.00±3.17	103.931±2.46	115.458±3.79	0.000

\*Represents a significant difference at  $p \leq 0.05$  using ANOVA. Data are expressed as Mean ± SD.

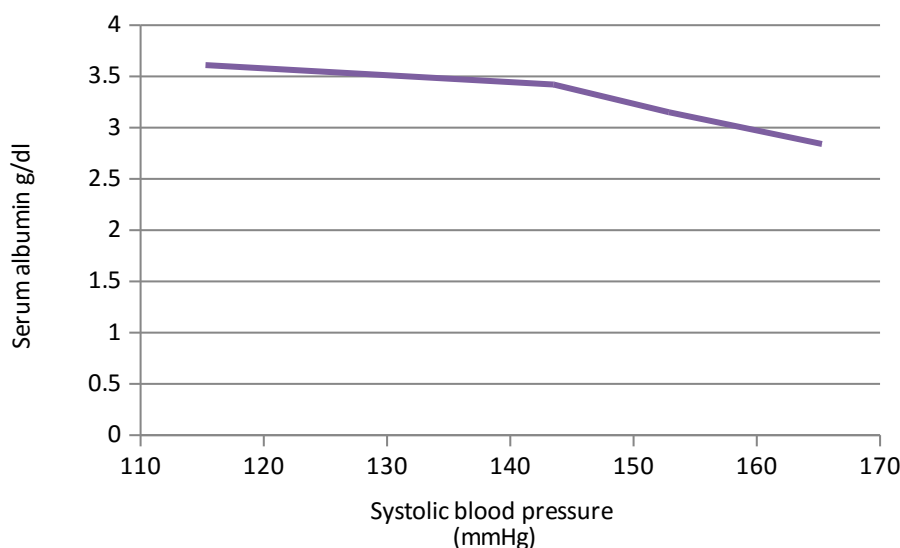


**Figure (1): Bar chart shows serum albumin level in each group**

As shown in Figure (2); women with mild and sever preeclampsia will give birth preterm.



**Figure (2): Bar chart shows gestational age in each group**



**Figure (3): The correlation between systolic blood pressure and serum albumin level**

### Discussion

Preeclampsia remain a leading cause of maternal morbidity and mortality . This study has shown a significant relation between severe preeclampsia and low gestational age either due to iatrogenic termination of pregnancy or due to preterm labour . This agreed by Cruz, et al<sup>(12)</sup> and Chen H,et al<sup>(13)</sup>. This study found that serum albumin level is significantly related to the severity of preeclampsia . This agreed by Gojnic, et al<sup>(14)</sup> where 60 patients diagnosed as preeclampsia and nearly all severe cases had albumin values below 3g/dl .According to this results parity is not related to the severity of preeclampsia . This is agreed by a study done by Basima Al Ghazali, et al<sup>(15)</sup> where 100 patients were divided into 4 groups and found that no significant difference in parity when comparing between the groups.

### Conclusion and Recommendation

This study showed that serum albumin level is lower in mild and sever preeclampsia comparing with normal and hypertensive cases. Prediction of severity of hypertensive disorders in pregnant women is possible with serum albumin level and they should have their Serum albumin level measured .

**Ethical Clearance:** The Research Ethical Committee at scientific research by ethical approval of both environmental and health and higher education and scientific research ministries in Iraq.

**Conflict of Interest:** The authors declare that they have no conflict of interest.

**Funding:** Self-funding

### References

1. American College of Obstetricians and Gynecologists, Task Force on Hypertension in Pregnancy. Hypertension in pregnancy. Report of the American College of Obstetricians and Gynecologists' Task Force on Hypertension in Pregnancy. *Obstet Gynecol.* 2013 Nov; 122(5):1122–31.
2. ACOG Committee on Obstetric Practice. ACOG practice bulletin. Diagnosis and management of preeclampsia and eclampsia. Number 33, January 2002. American College of Obstetricians and Gynecologists. *Int J Gynaecol Obstet.* 2002 Apr; 77(1):67–75.
3. Duley L. Pre-eclampsia and the hypertensive disorders of pregnancy. *Br Med Bull.* 2003 Dec 1;67(1):161–76.
4. Jabir M, Abdul-Salam I, Suheil DM, Al-Hilli W, Abul-Hassan S, Al-Zuheiri A, et al. Maternal near miss and quality of maternal health care in Baghdad, Iraq. *BMC Pregnancy and Childbirth.* 2013 Jan 16;13(1):11.
5. Wallis AB, Saftlas AF, Hsia J, Atrash HK. Secular trends in the rates of preeclampsia, eclampsia, and

- gestational hypertension, United States, 1987-2004. *Am J Hypertens*. 2008 May;21(5):521-6.
6. Kenny LC. Pre-eclampsia and other disorders of placentation. *Obstetrics by Ten Teachers*. 2011;18:156-161.
  7. Prevalence rate for hypertensive disorders of pregnancy and correlates for women admitted to the maternity ward of a tertiary hospital in Zambia [Internet]. Asian Digital Library. [cited 2020 Sep 24]. Available from: <https://theadl.com/detail.php?id=7076 & vol=0>
  8. Duckitt K, Harrington D. Risk factors for pre-eclampsia at antenatal booking: systematic review of controlled studies. *BMJ*. 2005 Mar 12;330(7491):565.
  9. Han A, Bujold E, Belizán M, Jaime J, Belizán J, Sharma S, et al. Preventing pre-eclampsia and its complications. :22.
  10. MacKay AP, Berg CJ, Atrash HK. Pregnancy-related mortality from preeclampsia and eclampsia. *Obstet Gynecol*. 2001 Apr;97(4):533-8.
  11. Magee LA. The FIGO textbook of pregnancy hypertension: an evidence-based guide to monitoring, prevention and management. 2016.
  12. Cruz MO, Gao W, Hibbard JU. Obstetrical and perinatal outcomes among women with gestational hypertension, mild preeclampsia, and mild chronic hypertension. *Am J Obstet Gynecol*. 2011 Sep;205(3):260.e1-9.
  13. Chen H, Tao F, Fang X, Wang X. Association of hypoproteinemia in preeclampsia with maternal and perinatal outcomes: A retrospective analysis of high-risk women. *J Res Med Sci* [Internet]. 2016 Nov 2 [cited 2020 Sep 24];21. Available from: <https://www.ncbi.nlm.nih.gov/pmc/articles/PMC5244641/>
  14. Gojnic M, Petkovic S, Papic M, Mostic T, Jeremic K, Vilendecic Z, et al. Plasma albumin level as an indicator of severity of preeclampsia. *Clin Exp Obstet Gynecol*. 2004;31(3):209-10.
  15. Al Ghazali B, Al-Taie AA-H, Hameed RJ. Study of the clinical significance of serum albumin level in preeclampsia and in the detection of its severity. *Am J BioMed*. 2014;2:964-74.

# Real-Time-PCR Assay Based on Phosphoglycerate Kinase Gene for Detection of *Entamoeba histolytica* Trophozoites in Stool Samples in Holy Karbala, Iraq

Dhamiaa Maki Hamza<sup>1</sup>, Saba Fadhil Ali Malaa<sup>2</sup>, Khalid Khalil Alaaraji<sup>3</sup>

<sup>1</sup>Assist. Prof., University of Kerbala, Collage of Medicine, <sup>2</sup>Assist. Prof., Al-Furat AL-Awsat Technical University, <sup>3</sup>Assist. Prof., University of Kerbala, Collage of Medicine, Iraq

## Abstract

Amebiasis is an important cause of diarrheal disease worldwide and has been associated with childhood malnutrition. *E. histolytica* diagnosed usually by microscope, which consider as traditional diagnosis and are neither sensitive nor specific detection of *Entamoeba histolytica*<sup>(1)</sup>. Real-time PCR assay developed for sensitive and specific detection of the intestinal Protozoan parasites *Entamoeba histolytica* directly from human feces<sup>(2)</sup>. The RT-PCR assay was able to detect as little as 0.1 parasite per g of feces<sup>(3)</sup>. The current study based on Phosphoglycerate kinase gene (PGK) is a major enzyme used in glycolysis, in the first ATP-generating step of the glycolytic pathway so the PGK is an enzyme that catalyzes the reversible transfer of a phosphate group from 1,3-bisphosphoglycerate (1,3-BPG) to ADP producing 3-phosphoglycerate (3-PG) and ATP<sup>(4)</sup>. In our study, depend on PGK as target for Real time PCR assay for detection the trophozoite stage of *E. histolytica* in stool samples of infected persons.

In the current study, a total of 300 human fecal samples were collected from children (less than one year-15 year) that suspected to infection with *amoebiasis* which admitted to hospitals and primary care centers in the city center, Al-Hindiya district and Nahiat Al -Hurr (100 samples from each region) during the period from February 2019 to January 2020. Fecal samples processed by direct wet smear and formalin ethyl acetate concentration method followed by iodine staining and was microscopically examined for *E. histolytica*. Microscopically positive samples were then subject to Real-time PCR. This is the first study in Iraq using the Phosphoglyceratekinase gene as target for molecular techniques to determine the presence of *E. histolytica* trophozoites.in stool samples.

**Keywords:** *Entamoeba histolytica*, Real-Time PCR, Phosphoglycerate kinase gene.

## Introduction

*Entamoeba histolytica* is an intestinal protozoon of humans. Several species of the genus *Entamoeba* infect humans, includes: *Entamoeba histolytica*, *Entamoeba coli*, *Entamoeba dispar*, *Entamoeba polecki*, *Entamoeba gingivalis* and *Entamoeba hartmani*<sup>(5)</sup>. Among these, only *E. histolytica* considered as pathogenic organism for human and the disease it causes is called amoebiasis or amoebic dysentery<sup>(6)</sup>. *Entamoeba histolytica* is an enteric parasite, its normal habitat in the human intestinal lumen and has the capacity to invade the epithelium. Amoebic dysentery occurs when *E. histolytica* trophozoites invade the walls of large intestines and multiply in the mucosa, forming ulcers. Most frequent manifestations of infection are dysentery, weight loss, fatigue, flatulent

stomach, colitis, and abdominal pain. A common outcome of invasion of the amoeba into tissues is liver abscesses, which can be fatal. *E. histolytica* has ability to secretes tissue lytic enzyme, histolysin which caused damage to the mucosal epithelium<sup>(6)</sup>, which digest the intestinal wall tissue of the infected individual hence the Latin name, is to (tissue) lytica (destruction)<sup>(7)</sup>.

The traditional laboratory diagnosis of *Entamoeba* infections via microscopic examination of stool samples, fresh or fixed. The pathogenic amoeba, *E. histolytica* is indistinguishable from *E. dispar* and *E. moshkovskii*, the non-pathogenic species<sup>(8)</sup>. It has also been shown that the sensitivity and specificity of microscopy is less optimal in differentiating the various species of *Entamoeba* <sup>(9)</sup>.

Real-time PCR is a very attractive methodology for laboratory diagnosis of infectious diseases because of a lack of requirement for post-PCR analysis, resulting in shorter turnaround times and reduces the risk of amplicon contamination<sup>(10)</sup>. This reflects evident progress in diagnostics, in which the contaminated of amplicon consider as the major reason of false-positive results in PCR assay<sup>(11)</sup> Also the real-time PCR is a quantitative method and capable of identified the parasites number in various samples<sup>(12)</sup>.

The human parasite *E. histolytica*, depends only on glycolysis for its ATP supply because it lacks the Krebs cycle and oxidative phosphorylation pathways<sup>(13,14)</sup>. The glycolytic enzymes of the parasite are highly divergent from the enzymes present in the human host; they include an AMP-inhibited hexokinase<sup>(15,16)</sup>, and the non-allosteric and pyrophosphate-dependent enzymes phosphofructokinase ATP-PFK-1 and pyruvate kinase in the host<sup>(17)</sup>.

The importance of glycolysis for parasite survival and the differences found in the glycolytic enzymes compared with those of the human host, make this pathway a suitable target for molecular techniques such as RT-PCR assay<sup>(18)</sup>.

## Materials and Method

- 1. Sample collection:** Fecal specimens included in this study were from children admitted to hospitals and primary care centers in the center of the city, Al-Hindiyah district and Nahiat Al -Hurr (100 samples from each region collected from children aged less than one year to 15 years) during the period from February 2019 to January 2020. All positive samples that detected microscopically were stored at  $-70^{\circ}\text{C}$  until used in RT-PCR assay.
- 2. Conventional Microscopy:** One drop of fecal suspension transferred to a microscope slide with a cover slip. Each slide examined as a direct mount at 40- magnification and presence or absence of *E. histolyticatrophozoites* were recorded. For further confirmation, formal-ether concentration technique was performed<sup>(19)</sup>.
- 3. DNA extraction:** Genomic DNA was extracted from trophozoites. The trophozoite's DNA extracted using AccuPrep® Stool DNA Extraction Kit (Bioneer, Korea) according to the manufacturer's instruction with some modification and used as template for RT-PCR assay. Extraction of genomic

DNA from *E. histolyticatroph.* was carried out according to our previous published paper<sup>(19)</sup>.

- 4. RT-PCR amplification:** One set of primers was design to use against the coding region of the Phosphoglycerate kinase gene (in *E. histolyticatrophozoites*) a 119bp fragment was amplified using the forward primer (ACCCAA GCT GGT GTTTTGAC) and the reverse primer (AG TTCA AGT GATGC TCC T CCTC) To amplify the DNA by used of the forward and reverse primers which designed by NCBI site.
- 5. RT-PCR protocols:** Real-Time PCR was performed for detection of trophozoites stage of *E. histolytica* by using the primers and TaqMan probe specific for Phosphoglycerate kinase gene In the DNA technique was carried out according to method described by<sup>(3)</sup>.
- 6. Real-Time PCR master mix preparation:** Real-Time PCR master mix prepared by one-step Reverse Transcription and Real-Time PCR detection kit (AccuPower Rocket ScriptRT-PCR PreMix, Bioneer. Korea), and done according to company instructions.

The RT-PCR master mix reaction components that mentioned in were added into standard qPCR tube containing (8 wells strips tubes which containing Rocket Script reverse transcriptase and TaqMan probe premix). Then all strips tubes vortexing for mixed the components and centrifuge for 3000 rpm for 3 minutes in Exispin centrifuge, after that transferred into Exicycler Real-Time PCR thermocycler<sup>(3)</sup>.

- 7. Real-Time PCR Thermocycler conditions:** Real-Time PCR thermocycler conditions was set up according to primer annealing temperature and RT-PCR Taq Man kit instructions.

Thermal cycles were applied to inspect the Real-Time PCR and relying on instructions AccuPower® 2X GreenStar™ qPCR Master Mix as well as by calculating the degree  $T_m$  prefixes using the device MiniOpticon Real-Time PCR system BioRad/USA.

- 8. Real-Time PCR Data analysis:** RT-PCR data analysis performed by calculation the threshold cycle number (CT value) that presented the positive amplification of gene in Real-time cycle number (20).

**Statistical Analysis:** The results were analyzed statistically by Chi-squared test, significant results were

attributed to probability values  $P < 0.05$  by using SPSS program.

### Results

This study included 300 stool samples of diarrhea collected from children suspected infected with

*E.histolytica*, the microscopic detection appeared 194 positive samples(100 samples from Kerbala center showed 55 positive samples (55%), 100 samples from Al-Hindiya district showed 62 positive samples(62%) and 100 samples from Nahiat Al -Hurr appeared 77 positive samples(77%)

**Table 1. Frequencies and percentages of Socio-demographical characteristics (N. of positive samples=194/300)**

Socio-Demographical Characteristics	Groups	F	Percentage (%)
Gender	Male	107	55.2
	Female	87	44.8
Age Groups	< 1 year	23	11.9
	1- 5	67	34.5
	6-10	72	37.1
	11-15	32	16.5
Region	Kerbala center	55	28.6
	Al-Hindiya	62	32
	Al -Hurr	77	39.7
Education Levels	Nursery school	23	11.9
	Kindergarten	49	25.3
	Primary school	78	40.2
	Secondary school	21	10.8
	School dropout	23	11.9

\*F. =frequency

**Comparison of microscope diagnosis with RT-PCR assay:** The microscopic examination results of showed for 300 stool samples showed that only 194 samples contained the Trophozoite stage of *E.histolytica* in the percentage (64.7%) while (35.3%) of the samples were negative for the parasite. The molecular examination by RT-PCR of the same samples revealed that the positive samples was 243 and the percentage was (81%) while the percentage of samples negative was (19%). (Table:2)

**Table (2) Infection percentage of parasitic *E.histolytica* by microscopic examination and RT - PCR results.**

Negative (%)	Positive (%)	Method of examination
106(35.3%)	194(64.7%)	Microscope
57(19%)	243(81%)	RT-PCR

**Molecular identification using the Real Time – PCR assay:** The results of molecular examination by using of RT-PCR appeared that the number of positive samples are 243(81%) from 300 suspected infected samples, depending on this technique the distribution of infection with *E.histolytica* in three region illustrated in table(3).

**Table (3): The percentage of the infected with *E.histolytica* in the city center, Al-Hindiya and Al – Hurr which diagnosed by RT-PCR assay.**

Region	Positive samples	Percentage
Karbala center	63	25.9%
Al-Hindiya	86	35.4%
Al -Hurr	94	38.7
<b>Total</b>	<b>243</b>	



The used of RT-PCR assay in the specific detection of *E.histolytica* showed a fluorescence of SYBER Green dye which appeared very clear through formed

of amplification plot to the positive samples during the cycle 30 as shows in the fig. (1).

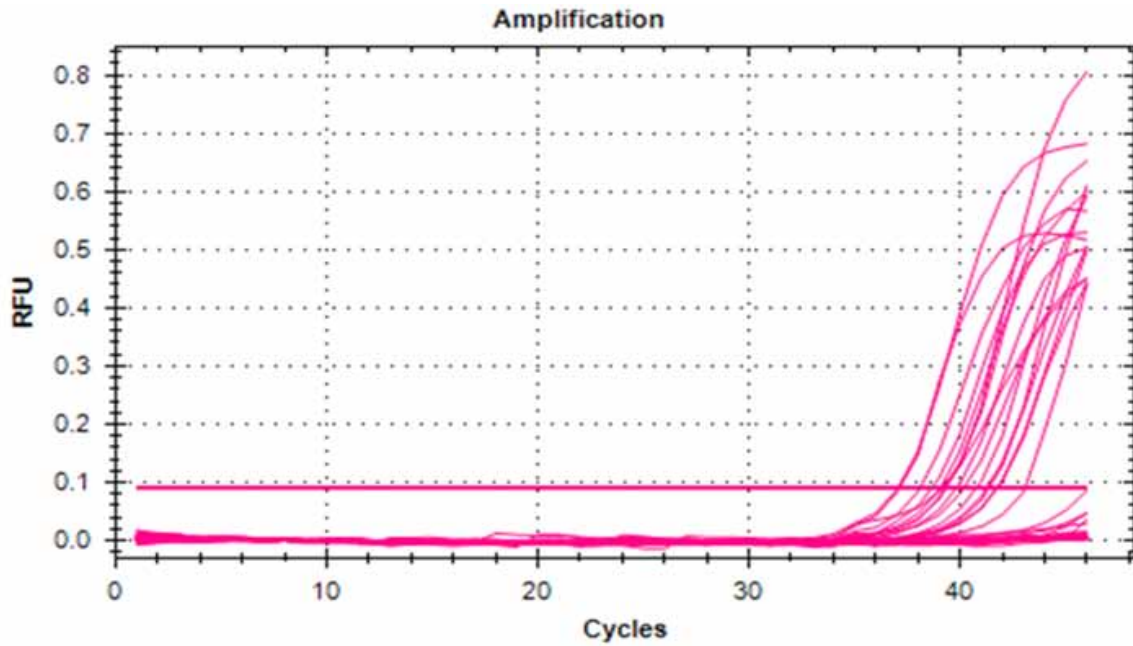


Figure (1): Amplification Plot of Phosphoglycerate kinase gene, in which the fluorescence of the dye SYBER Green represent samples positive located above of threshold while the negative samples located below the threshold.

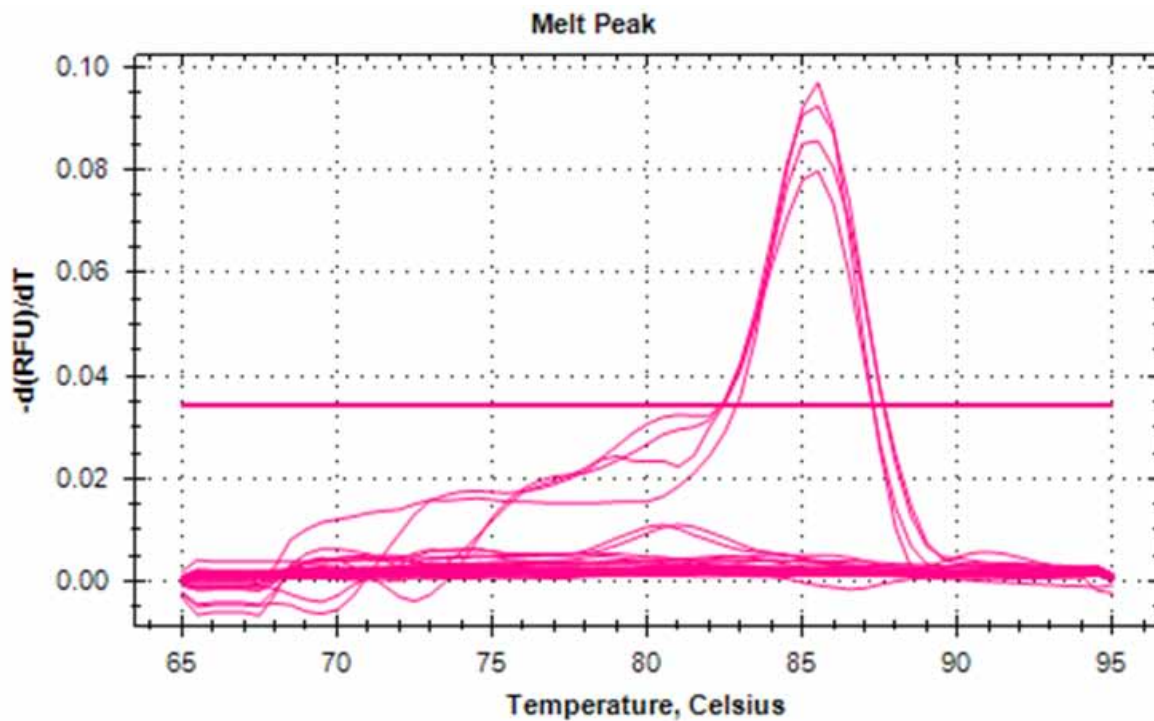
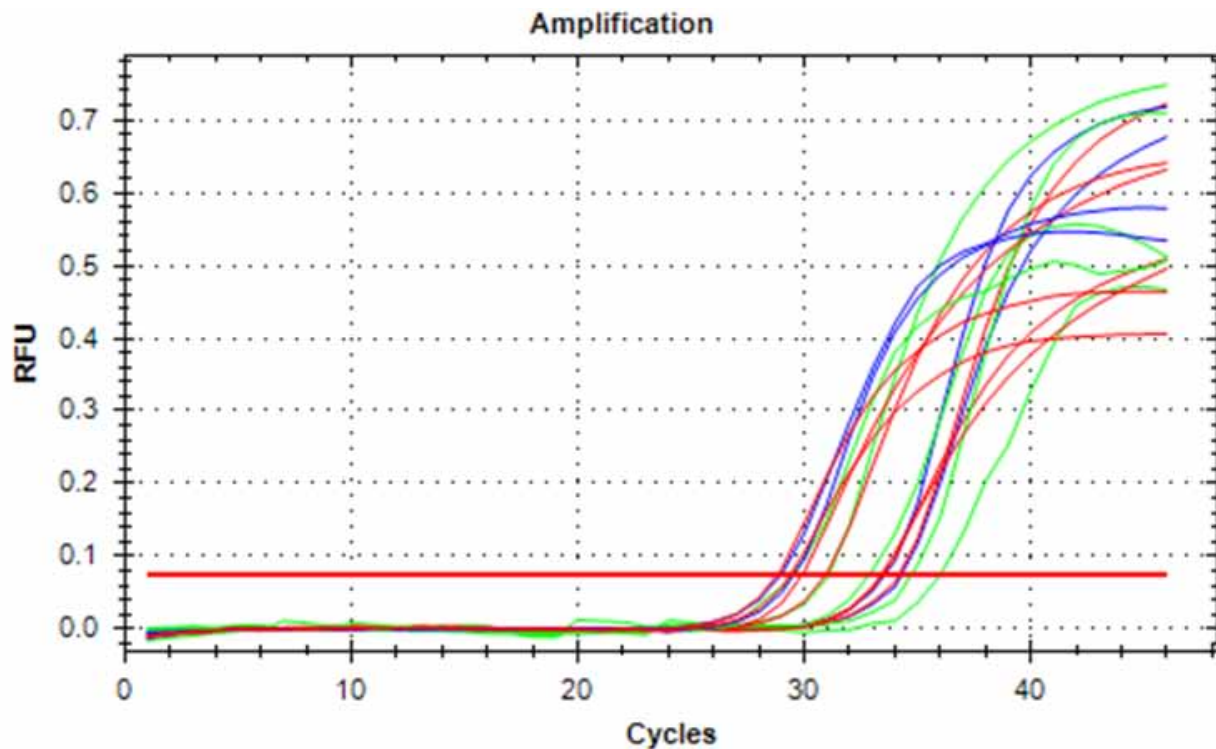


Figure (2): Melt peak curves from real-time PCR amplification of Phosphoglycerate kinase gene. Positive samples indicated in the curves (shown above of Threshold, and negative samples shown under the threshold).



**Figure (3): Amplification plot of Phosphoglycerate kinase gene appeared the positive samples of *E.histolytica* trophozoites in the three region: \*The center of the city(Red curves), Al –Hurr (Blue curves) and Al-Hindiyah (Green curves).**

## Discussion

Amoebiasis is a human disease caused by species of protozoa *Entamoeba histolytica*, which causes widespread morbidity and mortality worldwide distribution occurred diarrheal disease and abscess in several parenchymal tissues such as liver, lung, and brain. The true prevalence of infection is unknown for most countries due to the difficulty to characterize *Entamoeba histolytica* from other non-pathogenic amoebas, which have, resemble morphology, like *Entamoeba moshkovskii* and *Entamoeba dispar*<sup>(21)</sup>.

**Socio-demographic characteristics:** The current study appeared the prevalence of *E.histolytica* was 64.7%. From the diarrheal samples that collected from suspected infected patients. This prevalence considered high rate when compared to other survey studies conducted in other countries in the world, for instance, a study in Nigeria show the prevalence of *E.histolytica* infection in the 183 child examined 78 (42.62%) were infected with *Entamoeba histolytica*<sup>(22)</sup>. Also a survey was carried out in Pakistan to determine the prevalence of human amebiasis. During the study, 1360 fecal

samples were examined 295 (21.69%) were infected with *E. histolytica*<sup>(23)</sup>.

In other study results showed that the prevalence of *E.histolytica* was (2.2%) in 576 fecal samples were collected from children suffering from acute diarrhea in Saudi Arabia<sup>(24)</sup>. Also our results is closely related to<sup>(25)</sup>, where it was 53.18% in her study to diagnose *E.histolytica* in patients with gastrointestinal symptoms in an endemic region in Turkey. While our results were higher than results of Erbil (2.33%)<sup>(26)</sup> and in Babylon (17.4%)<sup>(27)</sup>. They are several reasons of the high prevalence of the *E.histolytica* may be due to direct transmission by contaminated food and water, insufficient attention to hygiene<sup>(28)</sup>. The difference of the results in the present study compared to other studies may be due to the difference in the sewer efficiency, personal hygiene, the density of population, geographical location, the number of test samples, the different duration of the study, different in the living style and different ages<sup>(29)</sup>.

In the current study found the prevalence rate of *E. histolytica* in males (55.2%) was higher than females

(44.8%) and there is no significant relationship ( $p < 0.05$ ). These results may be due to that, males are more susceptible than females to infections, because males generally exhibit reduced immune responses and increased intensity of infection compared to females<sup>(30)</sup>. These differences are usually due to physiological and ecological factors, which is usually hormonal in origin. Ecological factors include differential exposure to pathogens because of sex-specific behavior or morphology<sup>(31)</sup>. Other close cause of variation in ability to infection between two sexes is due to differences in endocrine-immune interactions. Male sexually mature are often more susceptible to infection, because sex steroids, specifically estrogens in females and androgens in males, modulate several aspects of host immunity. In addition to affecting host immunity, sex steroid hormones also alter genes and behaviors that influence susceptibility and resistance to infection. Thus, males may be more susceptible to infection than females not only because androgens reduce immune competence, but because sex steroid hormones affect disease resistance genes and behaviors that make males more susceptible to infection<sup>(32)</sup>.

The highest prevalence of infection according to the age was (37.1%) in the age group (6-10) years. The difference between the age groups in term of infection distribution in this study was statistically significant ( $P > 0.05$ ) while the results of research done in Erbil province find the highest infection rate was in the age (4-6)<sup>(32)</sup>. Another study revealed the relationship between age and *E. histolytica*, there was a highest prevalence (30.82%) in age group of (1 day to 15) years<sup>(33)</sup>. while a study results in Kenya appeared no significant association between prevalence of *E. histolytica* and age<sup>(34)</sup>. Also our results in agreement with<sup>(35)</sup> who confirmed that children in northern Pakistan under 15 years of age are very susceptible to infection by *E. histolytica*. They obtained 27% prevalence of the disease in children under 15 years of age perhaps the reason is due to they are less care for hygiene compared to adults, also the high incidence of Parasitic infection among school children may be due to the poor sanitary conditions in the most of the schools<sup>(36)</sup>, also they do not take care of their personal hygiene and not washing hands before eating, while some studies showed a reduced risk for infection with intestinal diseases among children who follow health instruction<sup>(37)</sup>.

The current study aims also to compare infection rates among three regions in holy Kerbala province, the

first region was the Kerbala center, the second region was Al-Hindiya and the third region was Al-Hurr.

The findings of this study, the highest rate of infection was (39.7%) in Al-Hurr region compared to the Kerbala center (28.6) and Al-Hindiya (32%) was statistically not significant ( $P < 0.05$ ) and this variation may be due to many interacted factors like, low education of mothers, sanitary service, improper water supply because *E. histolytica* can be transmitted orally by drinking water and it is one of the environmental contaminants of the water supply<sup>(38)</sup> also malnutrition and absence of regular hygiene toilets, which significantly increases susceptibility to *Entamoeba histolytica* in children, in addition to environmental, economic and social factors are also playing a role in this matter<sup>(39)</sup>.

**Comparison of microscope diagnosis with RT-PCR assay:** Fecal samples collected from suspected infected children with *E. histolytica* which first subjected to microscope that showed 194 positive samples then subjected to PCR analysis. Prevalence of *E. histolytica* was found to be 64.7% (194/300) samples based on microscopy versus 81% (243/300) according to the results of RT-PCR. Remarkably, all samples positive by microscopy were also positive by RT-PCR which was more sensitivities than the microscope detection. The data show that prevalence of *E. histolytica* in Kerbala is higher when specific diagnosis method are used instead of traditional microscopy, allowing to differentiate between morphologically identical human amoeba's species. Microscope detection has always been used to diagnosed of *E. histolytica* in fecal samples. Despite its inability to distinguish and differentiate *E. histolytica* from the morphologically identical nonpathogenic species *E. moshkovskii* and *E. dispar*. This has resulted in the unnecessary treatment of a large number of individuals with anti-amoebic drugs as well as providing an inaccurate picture of the epidemiology of the organism and the disease<sup>(40)</sup>.

The REAL-TIME assay have been shown to be directly comparable in terms of sensitivity and robustness, capable of detecting 10 parasite genomes but not one, unaffected by the presence of DNA derived from the host or the other test species<sup>(41)</sup>. In our study we depend on different gene Phosphoglycerate kinase gene is a major enzyme used in glycolysis in *E. histolytica* trophozoites, the researches regarding on this gene was rare, so we used this gene to improved if it could be adopted as diagnostic gene so we searched and used this

gene as a target of RT-PCR and the results showed a high sensitive of this technique to detected this gene in trophozoites stage .

## Conclusions

**The following conclusions were conducted from the present study:**

1. Although the routine tests such as clinical examination, macroscopic and microscopic diagnosis important, but it is unable to qualitative diagnosis of intestinal amoeba species and differentiated among them.
2. Using of the molecular method such as REAL-TIME PCR which characterized by highly accuracy, but these method expensive economically compared to routine method.
3. The use of specific primers in RT-PCR for diagnosis of Phosphoglycerate kinase gene are proven for diagnosis of *E.histolytica* trophozoites that isolated from stool samples of suspected children infection with *E.histolytica*.

**Ethical Clearance:** The Research Ethical Committee at scientific research by ethical approval of both environmental and health and higher education and scientific research ministries in Iraq.

**Conflict of Interest:** The authors declare that they have no conflict of interest.

**Funding:** Self-funding

## References

1. Moon JH, Cho SH, Yu JR, Lee WJ, Cheun HI. PCR diagnosis of Entamoeba histolytica cysts in stool samples. The Korean journal of parasitology. 2011 Sep;49(3):281.
2. Roy S, Kabir M, Mondal D, Ali IK, Petri WA, Haque R. Real-time-PCR assay for diagnosis of Entamoeba histolytica infection. Journal of clinical microbiology. 2005 May 1;43(5):2168-72.
3. Mala SF, Hamza DM. Real-time PCR Assay for Diagnosis of Eukaryotic Peptide Chain Release Factor Subunit 1 Gene in the Stages of Giardia duodenalis. Journal of University of Babylon. 2016;24(5):1234-45.
4. Encalada R, Rojo-Domínguez A, Rodríguez-Zavala JS, Pardo JP, Quezada H, Moreno-Sánchez R, Saavedra E. Molecular basis of the unusual catalytic preference for GDP/GTP in Entamoeba histolytica 3-phosphoglycerate kinase. The FEBS Journal. 2009 Apr;276(7):2037-47.
5. Ash LR, Orihel TC. Atlas of human parasitology: American Society of Clinical Pathologists.
6. Paniker CJ, Ghosh S. Paniker's textbook of medical parasitology. JP Medical Ltd; 2017 Sep 14.
7. Stanley Jr SL. Amoebiasis. The lancet. 2003 Mar 22;361(9362):1025-34.
8. Clark CG, Cunnick CC, Diamond LS. Entamoeba histolytica: Is conversion of "nonpathogenic" amebae to the "pathogenic" form a real phenomenon?. Experimental parasitology. 1992 May 1;74(3):307-14.
9. Roy S, Kabir M, Mondal D, Ali IK, Petri WA, Haque R. Real-time-PCR assay for diagnosis of Entamoeba histolytica infection. Journal of clinical microbiology. 2005 May 1;43(5):2168-72.
10. Blessmann J, Buss H, Nu PA, Dinh BT, Ngo QT, Le Van A, Abd Alla MD, Jackson TF, Ravdin JI, Tannich E. Real-time PCR for detection and differentiation of Entamoeba histolytica and Entamoeba dispar in fecal samples. Journal of Clinical Microbiology. 2002 Dec 1;40(12):4413-7.
11. Dagci H, Erdogan DD, OzensoyToz S, Kurt O, Ustun S, Akarca U. Differentiation of Entamoeba histolytica and Entamoeba dispar by PCR: A preliminary study in Izmir, Turkey. The new microbiologica. 2007 Jan 1;30(1):45.
12. Gonin P, Trudel L. Detection and differentiation of Entamoeba histolytica and Entamoeba dispar isolates in clinical samples by PCR and enzyme-linked immunosorbent assay. Journal of Clinical Microbiology. 2003 Jan 1;41(1):237-41.
13. Reeves RE. Metabolism of Entamoeba histolytica schaudinn, 1903. In Advances in parasitology 1985 Jan 1 (Vol. 23, pp. 105-142). Academic Press.
14. McLaughlin J, Aley S. The Biochemistry and Functional Morphology of the Entamoeba 1. The Journal of protozoology. 1985 May;32(2):221-40.
15. Reeves RE, Montalvo F, Sillero A. Glucokinase from Entamoeba histolytica and related organisms. Biochemistry. 1967 Jun 1;6(6):1752-60.
16. Saavedra E, Encalada R, Pineda E, Jasso-Chávez R, Moreno-Sánchez R. Glycolysis in Entamoeba histolytica: biochemical characterization of recombinant glycolytic enzymes and flux control

- analysis. *The FEBS journal*. 2005 Apr;272(7):1767-83.
17. Encalada R, Rojo-Domínguez A, Rodríguez-Zavala JS, Pardo JP, Quezada H, Moreno-Sánchez R, Saavedra E. Molecular basis of the unusual catalytic preference for GDP/GTP in *Entamoeba histolytica* 3-phosphoglycerate kinase. *The FEBS Journal*. 2009 Apr;276(7):2037-47.
  18. Saavedra E, Encalada R, Pineda E, Jasso-Chávez R, Moreno-Sánchez R. Glycolysis in *Entamoeba histolytica*: biochemical characterization of recombinant glycolytic enzymes and flux control analysis. *The FEBS journal*. 2005 Apr;272(7):1767-83.
  19. Hamza DM, Al-Massodi RH, Jeddoa MA. Molecular detection and discrimination of three poultry *Eimeria* species in Kerbala and Babylon provinces, Iraq. *International Journal of Current Research and Review*. 2015 Jun 1;7(11):13.
  20. Mala SF, Hamza DM. Real-time PCR Assay for Diagnosis of Eukaryotic Peptide Chain Release Factor Subunit 1 Gene in the Stages of *Giardia duodenalis*. *Journal of University of Babylon*. 2016;24(5):1234-45.
  21. Al-abodi HR. Phylogenetic sequencing for some species of *Entamoeba* sp. Al-Qadisiya Province. Ph. D. thesis, College of Sciences, University of Al-qadisiyah. 2015.
  22. Obadiah HI. Review of the survey of *Entamoeba histolytica* in Children a Brief Focus on Nigeria Situation. *Journal of Physiology and Pharmacology Advances*. 2012;2(3):150-7.
  23. Tasawar Z, Kausar S, Lashari MH. Prevalence of *Entamoeba histolytica* in humans. *Pakistan journal of pharmaceutical sciences*. 2010 Jun 1;23.
  24. El-Sheikh SM, El-Assouli SM. Prevalence of viral, bacterial and parasitic enteropathogens among young children with acute diarrhoea in Jeddah, Saudi Arabia. *Journal of Health, Population and Nutrition*. 2001 Mar 1:25-30.
  25. Zeyrek FY, Turgay N, Ünver A, ÜSTÜN S, Akarca U, Töz S. Differentiation of *Entamoeba histolytica*/*Entamoeba dispar* by the polymerase chain reaction in stool samples of patients with gastrointestinal symptoms in the Sanliurfa Province. *Türkiye Parazitoloji Dergisi*. 2013 Sep 1;37(3):174.
  26. Hama AA, Rahemo ZI. Intestinal parasitosis in relation to haemoglobin concentration among primary school children in Erbil province kurdistan-Iraq. *Isj*. 2014;1(1):96-9.
  27. Al-Shalah SA. Diagnostic study of *Entamoebahistolytica* and attenuated of parasitic by Gamma radiation (Doctoral dissertation, Msc. Thesis. College of medicine. University of Babylon).
  28. Aljanabi MA, Altikrity IA. The spread of *Entamoeba histolytica* infection among children attended the central child hospital in Baghdad city. *Iraqi J Sci*. 2014;55:979-85.
  29. Kurt O, Demirel M, Ostan I, Sevil NR, Mandiracioglu A, Tanyuksel M, Ak M, Dagci H. Investigation of the prevalence of amoebiasis in Izmir province and determination of *Entamoeba* spp. using PCR and enzyme immunoassay. *The new microbiologica*. 2008 Jul 1;31(3):393.
  30. Klein SL. The effects of hormones on sex differences in infection: from genes to behavior. *Neuroscience & Biobehavioral Reviews*. 2000 Aug 1;24(6):627-38.
  31. Zuk M, McKean KA. Sex differences in parasite infections: patterns and processes. *International journal for parasitology*. 1996 Oct 1;26(10):1009-24.
  32. Hamad NR, Ramzy IA. Epidemiology of *Entamoeba histolytica* among children in Erbil province, Kurdistan Region-Iraq. *J Res Biol*. 2012;2(1):57-62.
  33. Tasawar Z, Kausar S, Lashari MH. Prevalence of *Entamoeba histolytica* in humans. *Pakistan journal of pharmaceutical sciences*. 2010 Jun 1;23.
  34. David M. Prevalence of *Entamoeba Histolytica* Infections among the Children Attending Primary Schools in Kyuso Zone, Kyuso District, Kitui County, Kenya (Doctoral dissertation, Kenyatta University).
  35. Zuk M, McKean KA. Sex differences in parasite infections: patterns and processes. *International journal for parasitology*. 1996 Oct 1;26(10):1009-24.
  36. Oguntibeju O. (2006), "Prevalence of intestinal parasites in HIV/AIDS Positive patients". *Malaysian Journal of Medical Sciences* 13:68-73.
  37. Daryani A, Hosseini-Teshnizi S. Intestinal parasitic infections in Iranian preschool and. *Parasitol. Res*. 2006;98:38-43.

38. Al-haidare DM, Mala SF. PCR technique for detection of Giardia lamblia in microscopically positive stool samples of the patients in Al-Diwaniyah hospital/Iraq. *Al-Qadisiyah Journal of pure science (quarterly)*. 2017;22(2):94-101.
39. Roy S, Kabir M, Mondal D, Ali IK, Petri WA, Haque R. Real-time-PCR assay for diagnosis of Entamoeba histolytica infection. *Journal of clinical microbiology*. 2005 May 1;43(5):2168-72.
40. Kebede A, Verweij JJ, Endeshaw T, Messele T, Tasew G, Petros B, Polderman AM. The use of real-time PCR to identify Entamoeba histolytica and E. dispar infections in prisoners and primary-school children in Ethiopia. *Annals of Tropical Medicine & Parasitology*. 2004 Jan 1;98(1):43-8.
41. Roy S, Kabir M, Mondal D, Ali IK, Petri WA, Haque R. Real-time-PCR assay for diagnosis of Entamoeba histolytica infection. *Journal of clinical microbiology*. 2005 May 1;43(5):2168-72.

# Determining the Endpoint of Sediment Titrations by Smartphones

Muhaned Mohammed Eteya

*Assistant Lecturer, Department of Chemistry, Thi-Qar Education Directorate, Thi-Qar, Iraq.*

## Abstract

In this research work, we have used the image processing technique for determining the end of sodium sulphate with standard barium chloride in precipitation titration. The white precipitate of barium sulphate produced by the reaction of barium chloride and sodium sulphate was dispersed in deionized water by magnetic stirrer and its images were taken by mobile phone camera. The resulting pictures were analyzed by Photoshop Software which shows that the intensity of magenta colour has maximum sensitivity by changing the mass of barium sulphate. Therefore; magenta colour was selected as the optimum colour. Also, to depict the calibration curve of sulphate anion, different concentrations of sulphate were prepared in buffered solutions and by addition of barium chloride to them, the intensity of magenta colour was calculated. The results show that the calibration curve was linear in the range of 5-75 mg.L<sup>-1</sup> of sulphate with a correlation coefficient of 0.973. Finally, by titration of different real samples such as Tap, river and mineral waters containing sulphate anion with standard barium chloride, the variation of magenta colour was recorded and the concentration of sulphate anion was determined.

**Keywords:** *Image Processing, Sulphate determination, Precipitation reaction.*

## Introduction

**Sedimentary Titration:** Sedimentary titration is one of the strongest titration techniques, which belongs to the middle the year is 1800 AD. The endpoint in these titrations is based on sudden changes in the physical properties of the solution. There are many method for determining the endpoint in titration method, among which we can mention three common and widely used method. Determining the endpoint by a sudden change in the conduction of voltage or current between two electrodes and the determination of the endpoint is determined visually by changes in the color of the solution made by the detector. And determining the endpoint by changing the absorption of light by titrant or analyte<sup>(1)</sup>. It should be noted, however, that this method

does not apply to sedimentary titrations it is essential to select a standard method or method for determining the concentration of ions in solutions.

Hence, for anions such as halides, gravimetric and sedimentation titration method can be used. However, it should be noted that in general, the gravimetric method can be used only when the solution contains only analytes and is free of disturbing species. For example, when several halide ions are present in the system, the gravimetric method can only obtain the total concentration of ions but can not differentiate between them<sup>(2)</sup>. In contrast to this method, with the deposition titration method, partial halide ions can be measured separately by sedimentation titration method (due to the difference in their solubility in water). Therefore, sedimentation titration techniques are superior to gravimetric techniques. Since the co-precipitation process occurs frequently in sedimentary method and it is also difficult to detect the endpoint of sedimentary titrations in dye solutions, potentiometric method are mainly used to detect endpoints in sedimentary titrations<sup>(3)</sup>. In decomposition chemistry, Riley et al.<sup>(4,5)</sup> for the first time used a small amount of dye solution

---

### Corresponding Author:

**Muhaned Mohammed Eteya**

Assistant Lecturer, Department of Chemistry, Thi-Qar Education Directorate, Thi-Qar, Iraq

e-mail: thafmoh111@gmail.com

instead of a detector in titration method. Based on this, different method based on color intensity changes were used for acid and base reactions<sup>(6-10)</sup> and metal detectors<sup>(7,7,9,11-16)</sup>.

Today, one of the most important anions to measure is the sulfate ion. Sulfate is one of the major anions in drinking water and may be present in natural waters in concentrations ranging from a few milligrams to several thousand millilitres per litre. The presence of sulfate in drinking water can give it a bitter taste and very high amounts can cause gastrointestinal upset in humans<sup>(17)</sup>.

Determining the correct concentration of sulfate ions in each water source is one of the basic tests in assessing chemical quality. Therefore, measurements that can determine valid data according to the conditions of each laboratory and available water sources are important. Measurement of sulfate ion concentration in drinking water samples is often done by two method of turbidity measurement and iodometric titrations, each of which has certain advantages and disadvantages.

#### **The experimental method of measuring sulfate:**

To calculate the actual amounts of sulfate anion in the samples and compare with the proposed method. The following technique was used. One of the most common method is turbidity measurement to measure sulfate in the range 1- 40 mg per litre is suitable. Sulfate ion in the acidic environment by chlorobarium. The standard is in the form of insoluble barium sulfate and the amount of light absorbed by the solution. Barium sulfate suspension is measured using a standard sulfate concentration curve is calculated<sup>(18)</sup>.

And there is a way too simple and inexpensive way to measure sulfate anion in samples in this study of a new method. Different blue has been used. After preparation of barium sulfate from the reaction of barium chloride and sodium. A certain mass of it is dispersed in 1 ml of distilled water and sulfate by the phone camera. The smart is photographed from the solution. The intensity of the purple colour was determined through image analysis. Barium sulfate shows the greatest changes with mass change. So purple too optimal title selected. By recording changes in the intensity of purple colour according to the change in the concentration of sulfate anion, it was determined that the curve calibration is linear in the range of 5-75 mg/L and has a relative standard deviation of 743%. By examining the effect of other ions, it was found that this method can measure

sulfate in surface water samples. Finally, this method was used to measure sulfate in river and mineral water. Samples of different waters such as city water.

#### **Reagents and working solutions:**

**Chemicals used:** Deionized water was used in all stages of the experiment to prepare samples. Sodium salt/solution with a concentration of 1000 mg/L of sulfate ion was prepared by dissolving 0.1485 sulfates of German mercury in 100 ml of deionized water. Barium chloride from acetate company) of German mercury was prepared. To make a buffer from magnesium chloride salts (Merck Germany) Sodium German Merck (and Potassium Nitrate) Sigma Aldrich USA (with acetic acid) German Merck (used).

**Used devices:** Samsung Note 3 camera was used to capture images. Also from the application Company Designed and built and shown in Figure 1.



**Figure 1. The internal layout of the lightbox used to capture images**



**Basis of the method:** As mentioned in the previous chapter, this project is based on determining the endpoint of sedimentary titrations. It is concentrated by 9.16 g of barium chloride and 5.32 sodium sulfate by smartphones. For this purpose. We weigh sodium sulfate and then perform the following steps:

Add 250 ml of distilled water to sodium sulfate and 250 ml of distilled water to barium Chloride. Add sodium sulfate solution to barium chloride solution and then stir for two the watch. After mixing the mixture, leave it for 24 hours to get a white deposit the deposition is BaSO<sub>4</sub>. After precipitation BaSO<sub>4</sub> should be stored at 40 °C for 72 hours to be ready to use. The buffer solution was prepared according to the following instructions. 3 g of MgCl<sub>2</sub> , 0.5 g of 0.1 g of KNO<sub>3</sub> sodium acetate salt and 2 ml of 99% acetic acid solution in a 100 ml jouette balloon to prepare the desired buffer. To 0.001 g of barium sulfate precipitate 1 ml to optimize different parameters, it was first added distilled water and in a small cell (5 ml) was stirred for 2 minutes with a stirrer,

then the intensity of purple colour was processed to examine its changes. It should be noted that to measure sulfate in real samples, the titration method is used. The buffer solution is added then by adding 0.5 ml of sample 0.2 in which different volumes of distilled water and barium chloride record the intensity of purple colour in the resulting turbid mixture.

## Discussion of Results and Optimization

### Optimization of various parameters:

#### Optimizing the intensity of different colours:

Turquoise , Yellow , Mix of three colours red, green, blue , Blue , Green , Different colours including red-purple and black to find the colour with the highest sensitivity to the mass of barium sulfate were studied, the results of which are shown in Table 3- 1. As it is known purple colour because it is more intense for different amounts of barium sulfate, Was selected as the optimal colour. As a result, this colour was used in the measurements.

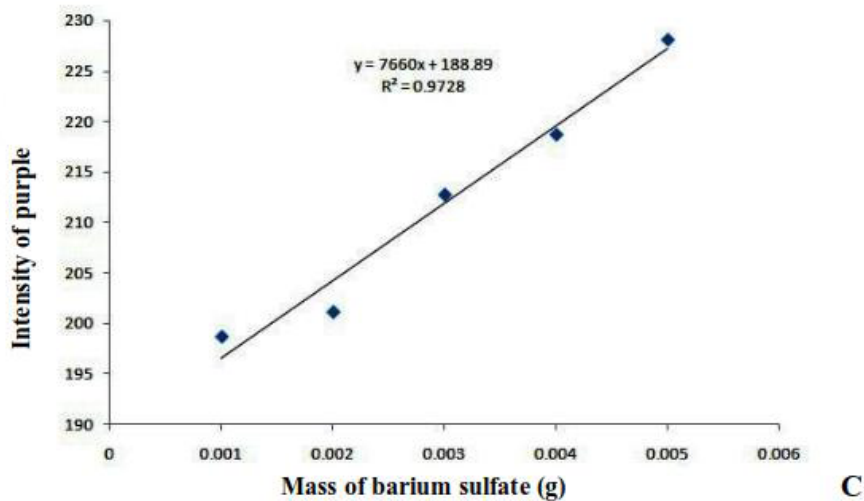
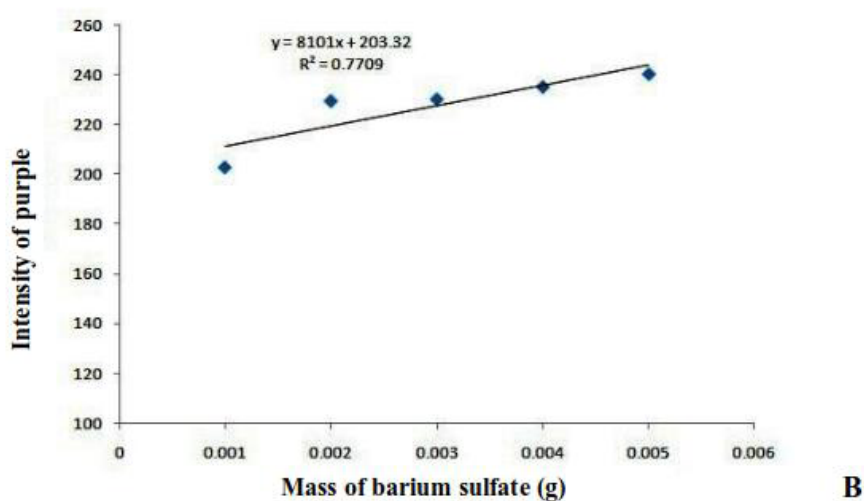
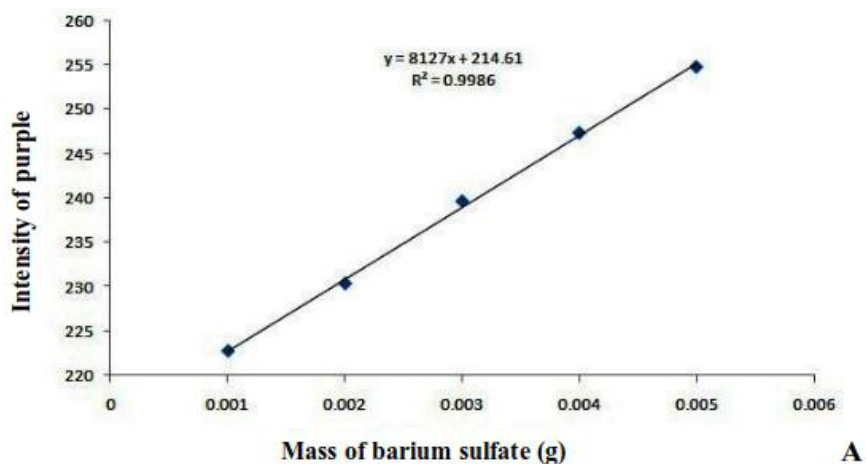
**Table 3-1. The slight intensity of different colors for barium sulfate**

Sample number	g	K1	Y2	M3	C4	Sample RGB5	Sample B6	Sample G7	Sample R8
1	0.001	255	217.1	222.72	210.38	197.78	196.457	199.788	197.347
2	0.002	255	219.69	230.35	211.13	219.393	217.64	222.042	218.544
3	0.003	255	236.31	239.65	234.9	231.257	228.731	233.11	231.882
4	0.004	255	236.24	247.38	241.28	231.787	228.416	233.825	232.676
5	0.005	255	252.48	254.84	254.46	224.272	221.493	226.478	224.633

Indicates the intensity of black, indicates the intensity of yellow, indicates the intensity of purple shows, indicates the intensity of turquoise, indicates the colour combination of three colours, Shows the intensity of blue, Shows the intensity of green, Shows the intensity of red.

#### Optimization of vial volume and distilled water:

Different masses of barium sulfate are used to optimize the volume of the vial and distilled water Medium and large by in vials with small volumes (0.001–0.005 g) range 1 and 2 ml volumes of distilled water were dispersed and photographed by the camera. Graph of purple colour intensity by mass of barium sulfate in volume 1ml (Figures 2), large (5 ml) Medium (10 ml) Distilled water in small vials (15 ml).



**Figure 2. Image analysis results in containers (1) 5ml (2) 10ml (3) 15ml litres containing 1 ml of distilled water**

**Mass Optimization BaCl<sub>2</sub>:** Its different masses in the range 0.1- 0.5 of were investigated to optimize the weight of barium chloride. As shown in Table 2-3,

the intensity of purple colour in of barium chloride was selected as the optimal mass/range and therefore became 0.1.

**Table 3-2. Results related to the change of purple color intensity with the change of barium chloride mass. 50 ml of Samples containing sulfate ions: 45 mg/L**

Barium chloride mass (g)	0.1	0.2	0.3	0.4	0.5
Intensity of purple	164.81	164.38	164.84	165.77	165.45

**Optimization of used lamps:** Because purple dye has the highest sensitivity to measure sulfate green and blue at intervals of 'white' to optimize the lamp used by different types such as yellow 10 cm and close 5 cm were examined. Results in (Figures 3) blue is shown at

a distance of 5 cm (Figure 4, 5,6). As can be seen, has a wider range of color intensity change and uniformity with changing the volume of barium chloride is. As a result, use a blue lamp at a distance of 5 cm for further measurements took.

**Disturbing ions:** To evaluate the applicability of the method in real samples, different ions such as aluminium ( $Al^{+3}$ ) Cobalt ( $Co^{+2}$ ), copper ( $Cu^{+2}$ ), in a solution containing sulfate ions at a concentration of 1000 mg/L were reduced by barium chloride to 1000 mg/L. The titration curves in Figures 7 to 8, 9 are shown. Also, the percentage of relative error of the disturbing ions mentioned in Table 3-3 shows that a very good percentage of relative error is observed in most cases.

**Table 3-3. Results of disturbance ion analysis in the measurement of sulfate ions. Sulfate ion concentration 35 mg/L and the concentration of disturbing ions is 200 mg/L**

Disturbing ions	The color intensity in the absence of disturbing ions	The color intensity in the presence of disturbing ions	Relative error percentage
$Al^{+3}$	158.39	168.83	6.6
$Cu^{+2}$	141.3	136.52	3.4-
$Ca^{+2}$	179.26	169.83	5.3-

**Titration Method:** In this method, first, the sample is titrated with barium chloride and through the volume of the endpoint of sulfate concentration in the sample we calculate.

**River Water:** To measure the sulfate ion, the titration method was used, the diagram of which is shown in Figure 10 is the amount of sulfate obtained/shown. Given that the final volume is 0.70 it is 37 mg/L, which is in very good agreement with the actual amount (38 mg/L)

**Mineral Water:** Figure 11 Spike mineral water titration curve with a specified amount of sulfate (500 mg/L) shows the endpoint in volume 0.74. The concentration of sulfate in the mineral water sample is 30 mg/L, which is compared to the amount Real (31 mg/L) is in great agreement.

**Water City:** Figure 12 shows the spiked titration curves of city water. Given that the point is the amount of sulfate obtained in this method is 76 mg/L final 0.78 ml. Which is in good agreement with its actual amount (80 mg/L).

## Conclusion

In this project, a new processing-based method has been used to measure sulfate anions in aqueous samples. By diluting different masses of barium sulfate in distilled water, it was found that changes in the intensity of purple color show the greatest sensitivity and was selected as the optimal color. By optimizing various parameters such as vial volume and distilled water, barium chloride mass and type and distance of the lamp, it was determined that the calibration curve is in the range of 5-75 mg/L linear. One of the main advantages of this method is that it does not require advanced devices, and since photography is done using a simple smartphone camera, it makes the application of this method easy and low cost. Also, the effect of disturbance study of other ions showed that only disturbing species are measured in fluoride and carbonate ions. Also, this method was used to measure barium sulfate and also sulfate anion in city water samples, and mineral water by standardization method and sediment titration.

**Ethical Clearance:** The Research Ethical Committee at scientific research by ethical approval of

both environmental and health and higher education and scientific research ministries in Iraq

**Conflict of Interest:** The authors declare that they have no conflict of interest.

**Funding:** Self-funding

### Reference

1. Skoog DA, Holler FJ, Crouch SR. Instrumental analysis. Vol. 47. Brooks/Cole, Cengage Learning Belmont; 2007.
2. Ellwood MJ, Hunter KA, Cunninghame RG. Elimination of equivalence point errors in the potentiometric titration of chloride, bromide and iodide mixtures with silver nitrate. *Microchemical journal*. 2003;74(2):187–192.
3. Ni Y, Wu A. Simultaneous determination of halide and thiocyanate ions by potentiometric precipitation titration and multivariate calibration. *Analytica chimica acta*. 1999;390(1–3):117–123.
4. Reilley CN, Flaschka HA, Laurent S, Laurent B. Characterization of the color quality of indicator transition. *Complementary tristimulus colorimetry*. *Analytical Chemistry*. 1960;32(10):1218–1232.
5. Reilley CN, Smith EM. Chemical applications of complementary tristimulus colorimetry. *Analytical Chemistry*. 1960;32(10):1233–1240.
6. Bhuchar VM, Kukreja VP, Das SR. Evaluation of color changes of indicators. Specific color discrimination of phthalein and sulfonephthalein indicators. *Analytical Chemistry*. 1971;43(13):1847–1853.
7. Cacho J, Nerin C, Ruberte L, Rivas E. Evaluation of color changes of indicators. *Analytical Chemistry*. 1982;54(8):1446–1449.
8. Fernandez AC, Chozas MG. Colour specification of pyridine-2-aldehyde and 6-methylpyridine-2-aldehyde p-nitrophenylhydrazones as indicators for pH determination. *Talanta*. 1987;34(7):673–676.
9. KOTRLÝ S, VYTRÁS K. COLOUR CHANGES OF ION-COMBINATION INDICATORS. In: *Essays on Analytical Chemistry*. Elsevier; 1977. p. 259–280.
10. Bhuchar VM, Agrawal AK. Evaluation of colour changes of sulphamphthalein indicators: synthesis, purification and characterisation of phenol-and o-cresolsulphamphthalein. *Analyst*. 1982;107(1281):1439–1450.
11. Cacho J, López-Molinero A, Castells JE. Comparative study of metallochromic indicators for magnesium. *Analyst*. 1987;112(12):1723–1729.
12. Cacho J, Garnica A, Nerin C. Critical study of metallochromic indicators for calcium. *Analytica chimica acta*. 1984;162:113–122.
13. Calatayud JM, Marti MP, Vives SS. Screened indicators for the direct chelometric titration of lead (II). *Analyst*. 1985;110(7):837–839.
14. Prasad KK, Raheem S. Evaluation of colour changes of indicators in the titration of cadmium with EDTA. *Analytica chimica acta*. 1992;264(1):137–140.
15. Prasad KK, Raheem S, Vijayalekshmi P, Sastri CK. Basic aspects and applications of tristimulus colorimetry. *Talanta*. 1996;43(8):1187–1206.
16. Raheem S, Prasad KK. Evaluation of colour quality of complexometric indicators in the titration of Nickel (II) with EDTA by tristimulus colorimetry. *Talanta*. 1993;40(12):1809–1814.
17. Heizer WD, Sandler RS, Seal E, Murray SC, Busby MG, Schliebe BG, et al. Intestinal effects of sulfate in drinking water on normal human subjects. *Digestive diseases and sciences*. 1997;42(5):1055–1061.
18. Ouyang S, Kikugawa N, Chen D, Zou Z, Ye J. A systematical study on photocatalytic properties of AgMO<sub>2</sub> (M= Al, Ga, In): effects of chemical compositions, crystal structures, and electronic structures. *The Journal of Physical Chemistry C*. 2009;113(4):1560–1566.

# Deleted













# Mammogenesis Effect of Hot Aqueous Extract of *Mentha spicata* Leaves on Mammary Tissue of Ovariectomized Rabbits

Sinaa Jaboury Al-Bazii<sup>1</sup>, Ashwaq Kadhem Obeid<sup>2</sup>, Rana Majeed Hameed<sup>3</sup>

<sup>1</sup>Assistant Professor, Department of Anatomy, Medicine College, Kerbala University, Kerbala, Iraq, <sup>2</sup>Assistant Professor, Department of Biology, Education College for Pure Sciences, Kerbala University, Kerbala, Iraq,

<sup>3</sup>Assistant Professor, Department of Biochemistry, Medicine College, Kerbala University, Kerbala, Iraq

## Abstract

**Background:** Plants are highly rich in phytochemicals being used to treat various conditions, and a rich source of polyphenols is Spearmint (*Mentha spicata* L). Such polyphenols have demonstrated multiple bioactivities. This study aims to investigate the effects of the intake of hot-aqueous extracts of spearmint leaves on mammary gland development and growth

**Method:** Thirty six female rabbits were divided into two main groups (18 rabbits/group): (virgin and lactating). Each group was further subdivided into three subgroups (Control, Ovariectomized (OVX) and Spearmint, (6 rabbits/group). All three groups tissues were examined for histological, histochemical and biochemical enzymatic analysis.

**Result:** Spearmint-treated ovariectomized virgin animals demonstrated an increase in the size of lobules that affected the alveolar bud. In the ovariectomized lactating group treated with spearmint, it was shown that the lobules were enlarged and produced more branching alveoli. The stain (PAS) and ALP showed positive reaction in the spearmint group treated with lactation.

**Conclusion:** The hot methanol extract of the spearmint *Mentha spicata* leaves have a beneficial effect on mammary gland growth and development.

**Keywords:** *Mentha spicata*, Ovariectomy, mammary gland virgin, lactating, rabbit.

## Introduction

The mammary glands are complex tubuloalveolar glands which main function is to produce and secrete milk, it plays a major role in human nutrition either through oral feeding or via the food industry<sup>1</sup>. Mother's milk plays an significant role in neonatal survival, proper development and growth<sup>2</sup>. Mammary glands begin to develop in females at puberty and achieve maximum functional status after pregnancy. Ovarian

steroids (estradiol and progesterone) play a crucial role as regulators of the different stages of mammogenesis and mammalian development<sup>3</sup>. Menopause is defined as the point in time after consecutive months of amenorrhea and refers to changes occurring in the hypothalamic-pituitary-ovarian axis<sup>4</sup>.

Many females actively looking for alternative menopausal medications such as herbal nutritional supplements in attempting for relieving the weakness, depression anxiety, extreme fatigue, joint pain and insomnia<sup>5</sup>. Herbal plants are an important source of herbal care and often form the basis of indigenous or traditional healing systems, which are still commonly used by the majority of populations in many countries<sup>6,7</sup>. The Lamiaceae family of *Mentha* is widely distributed in Europe, Asia, Africa, Australia and North America<sup>8,9</sup>. Extracts of this genus are traditionally used foods and

---

### Corresponding Author:

Sinaa Jaboury Al-Bazii

Assistant Professor, Department of Anatomy, Medicine College, Kerbala University, Kerbala, Iraq

e-mail: sinajabouri@gmail.com

are highly valued due to the presence of large amounts of antioxidant such as phenolic bioactive compounds<sup>10</sup>. Bazii *et al*, 2013 showed that the *Mentha spicata* leaves have mammagens activity without any toxicity effect<sup>11</sup>. Probably, it is because of the anti-androgen spearmint action, which increased serum oestrogen levels, luteinizing hormone (LH) and follicle stimulating hormone (FSH)<sup>12,13</sup>. Accordingly, The aim was to shed light on the stimulating ability of spearmint in the mammary tissue of ovariectomised rabbits.

## Material and Method

**Animals preparation:** Thirty-six healthy virgin and lactating female rabbits from the ages of approximately 5-12 months old were used. The animals were housed 4/cage in a facility with a constant temperature of 22°C with consistent humidity and 12/12 hours light/dark cycle in Animal Housing Department/vet. Collage/ Karbala University. The rabbits were fed on green vegetables and tap water ad libitum. All female rabbits were divided into two main groups (18 rabbits/group): The G1 group contained the virgin rats. While the G2 group examined the lactating rabbits. Each group was further divided into three subgroups (6 rabbits per subgroup): The control group was intubated tap water orally while the bilateral ovariectomy group were intubated orally with 5.25 ml/kg b.w<sup>14</sup>, serving as spearmint group for the duration of one month.

**Preparation of the hot Aqueous Extracts:** Spearmint leaves had been bought from the local market. Soaking method was used to produce plant extracts<sup>15</sup>.

**Surgical operation:** After routine preparation of the site of operation (midline region), the general anesthesia was induced with diazepam in dose 1mg/kg b.w. after 10 minutes as a preanesthetic. Then xylazine was injected in doses of 10 mg/kg b.w. while ketamine, in 50 mg/kg b.w. Both injections were performed intramuscularly according to open operation<sup>16</sup>

**Tissue sampling and processing:** The tissue samples obtained from the mammary gland of all rabbits from both groups were anesthetized with chloroform directly after being sacrificed. Routinely stained histological slides with hematoxyl, eosin stain and the Periodic Acid Schiff's Stain Was achieved through the procedure that described by Lawrence<sup>17</sup>

**Alkaline Phosphatase Activity:** Most mammary gland ALPs are in the myoepithelial cells, Epithelial

secretory cells have low levels of ALP activity, which could play a role in milk secretion. This enzyme relates to mammary function and may be concerned with nutrient transport. Therefore the activity of ALP was measured to demonstrate the alkaline phosphatase activity based on modified procedure described by<sup>18</sup>.

## Results

### Histological Studies:

**Virgin Rabbits:** In the Control group Haematoxylin-eosin stained tissues illustrated the lobules were packed with alveolar buds and intralobular ducts. While small lobules scattered among huge amount of adipose tissue were examined in the OXV group. In Spearmint group there was an increase in the size of lobules when compared with the OVX group Fig.1(a,b and c) respectively.

**Lactating Rabbits:** The histological examination in OXV group showed an increase in the lobular size with corresponding decrease in the adipose tissue. The alveoli and ducts were dilated and filled with secretory products. Figure 2b and 2c illustrated the spearmint group which showcased that lobules were increased in size, packed with branching alveoli and filled with secretory products. In the OXV and Spearmint groups greatly, narrow lobules containing little branching and non-dilated alveoli in compared with Control group (Fig.2a).

**Periodic Acid Schiff's Staining:** Staining with Periodic Acid Schiff's (PAS) stain gives identical features to those stained with Hematoxylin and Eosin stain, these results included:

**Virgin Rabbits:** The histological examination of mammary gland sections in control, OXV and Spearmint groups showed negative reaction to the PAS stain as illustrated in (Fig.3a, b, and c) respectively.

**Lactating Rabbits:** Positive reactions to the PAS stain were noticed in the histological sections of mammary gland that were obtained from the Control group. Similar results were reported in the mammary tissue of lactating rabbits treated with OXV and Spearmint as seen in (Fig.4a, b, and c) respectively.

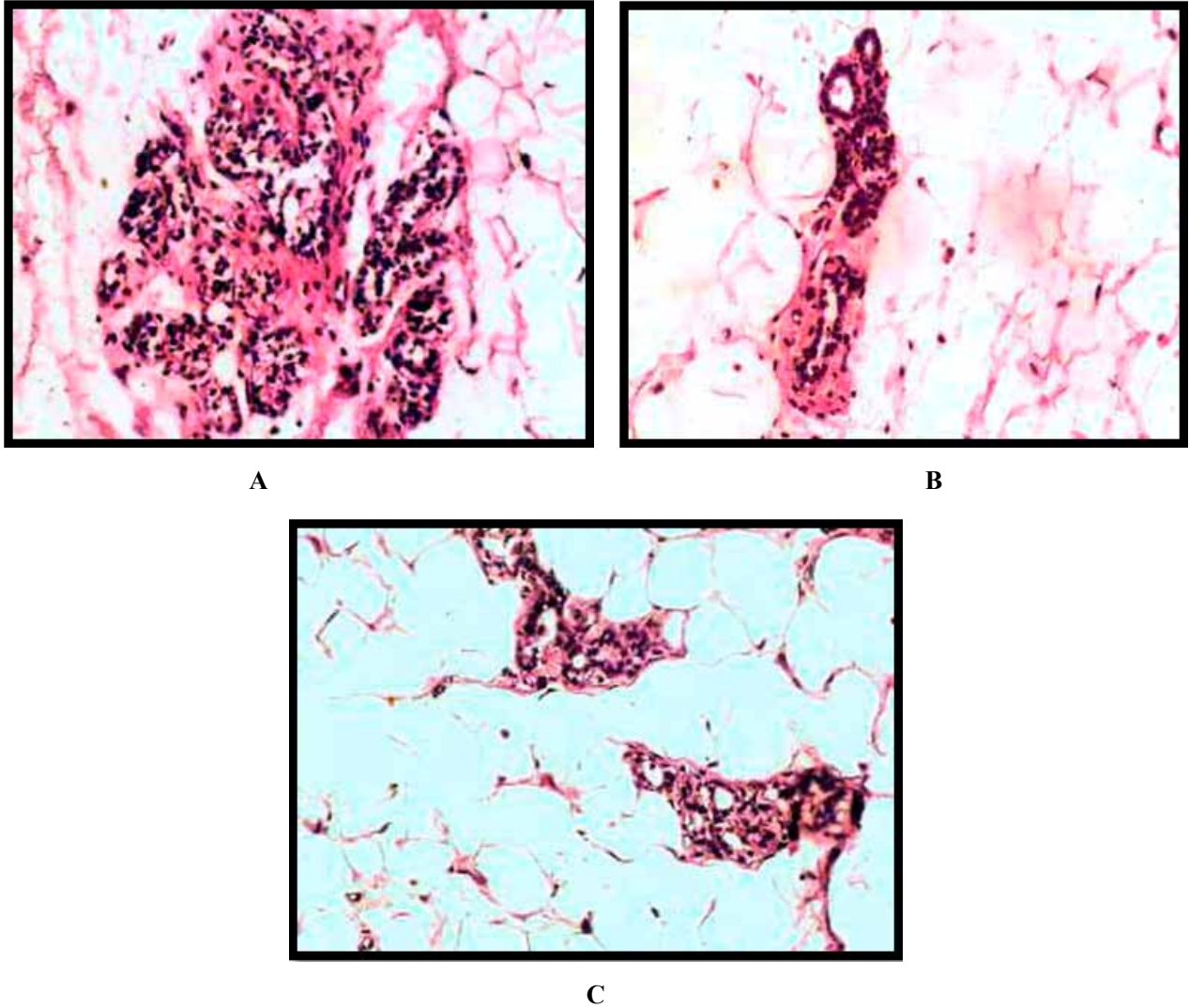
### Alkaline Phosphatase:

**Virgin Rabbits:** Mammary tissue sections of rabbits treated with hot aqueous extract of Spearmint, OXV and Control group were showed negative expression of

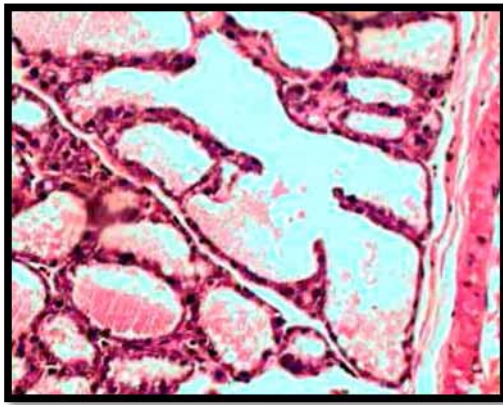
ALP activity around the intralobular ducts (i.e. positive activity of ALP in the myoepithelial cells) as illustrate on (Fig.5a, b and c).

**Lactating Rabbits:** Microscopic examination to sections of mammary gland of rabbits in spearmint

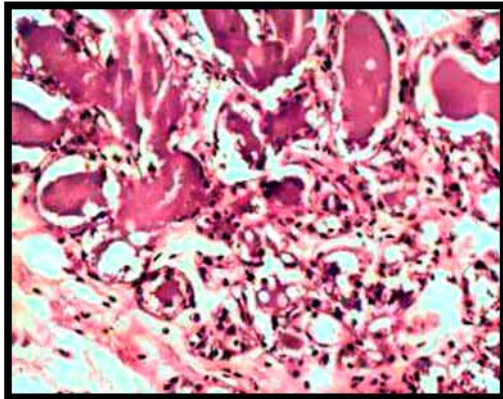
showed moderate activity of ALP of the myoepithelial cell (Fig.6c). On the other hand, the mammary tissue of lactating rabbits of control group showed more dense activity to ALP (Fig.6a) compared to OXV group which showed weak expression (Fig.6b).



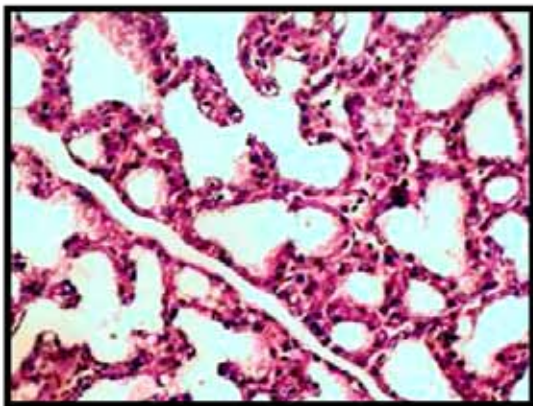
**Figure 1: Virgin groups. A. Sham group showed lobules (arrow) with alveolar buds. B. OVX group show small lobules (arrow) scattered among huge amount of adipose tissue C. Spearmint group show an expansion in the size of lobules (arrow) in comparison with the OVX group (H & E) (200X).**



A

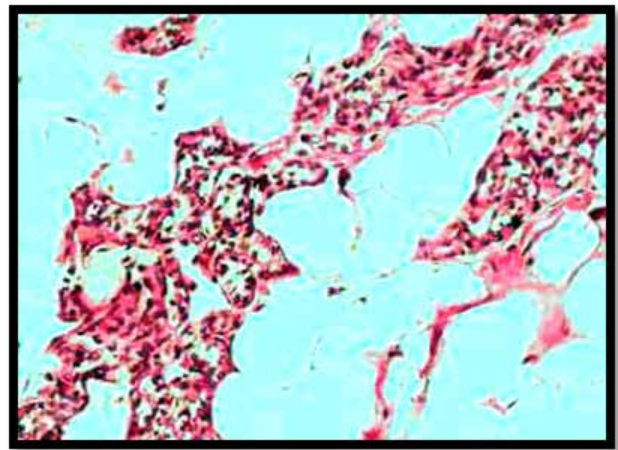


B

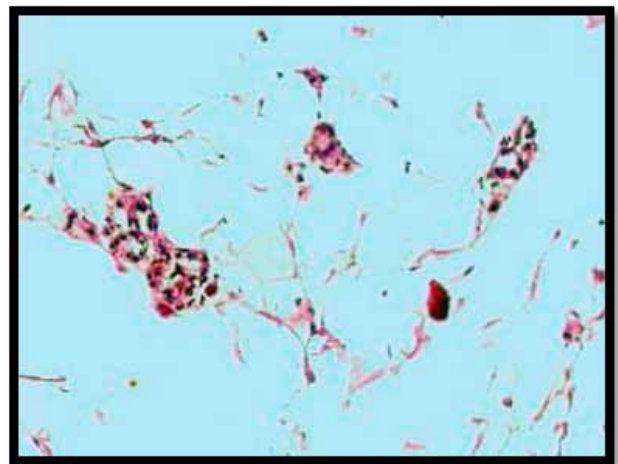


C

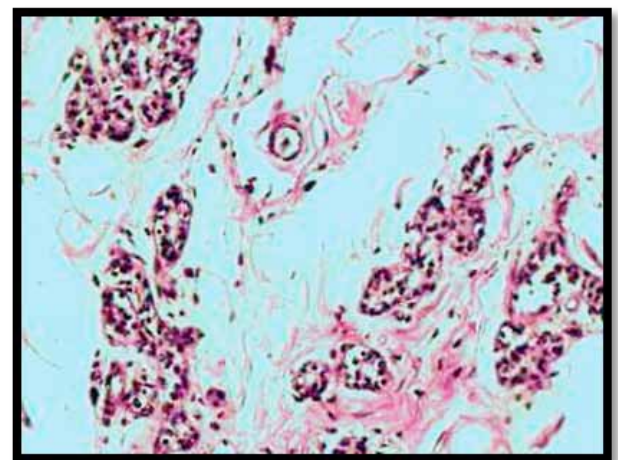
**Figure 2: Lactating groups. A. Sham group noted expanded lobules (arrow) Contains dilated and branched alveoli with low epithelial tissue (curved arrow). B. OXV group showed an increase in the lobular size (arrow) with corresponding decrease in the adipose tissue. The alveoli and ducts were dilated and filled with secretory products) C. Spearmint group showed more increased in the size of lobules, packed with branching alveoli (H & E) (200X).**



A

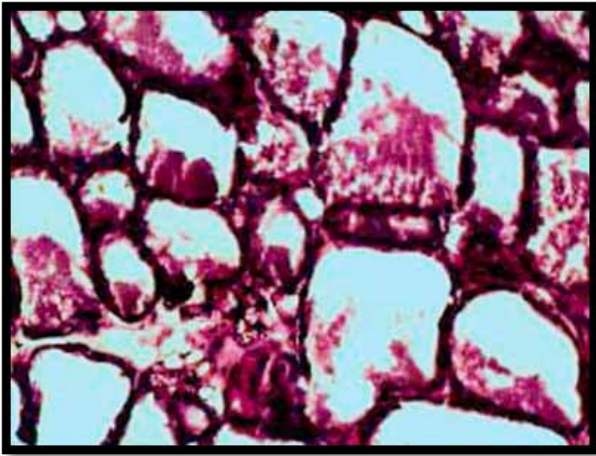


B



C

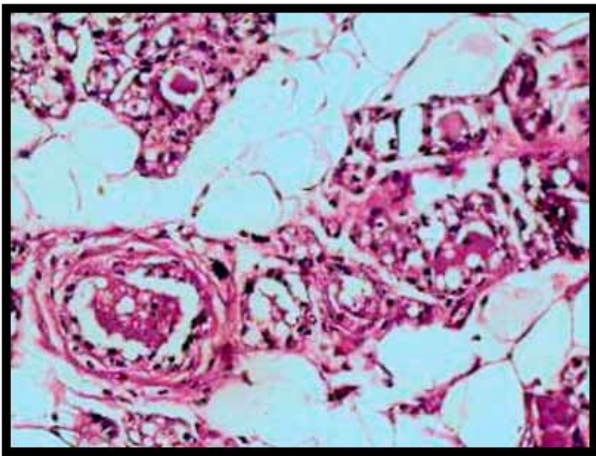
**Figure 3: Virgin groups. Sham group (A), OXV group (B) and Spearmint group (C) showed negative reaction (PAS)(200X).**



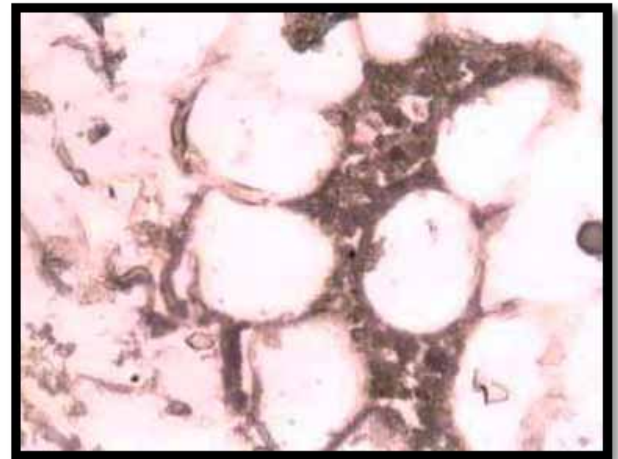
A



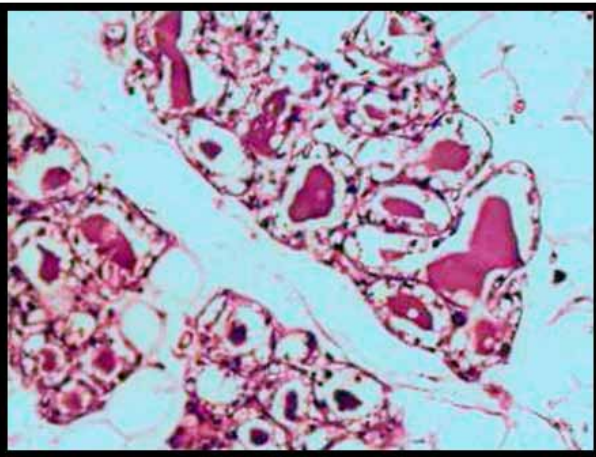
A



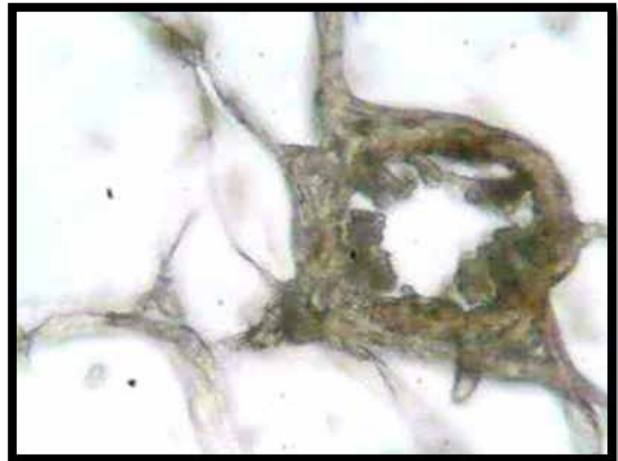
B



B



C



C

**Figure 4: lactating groups. sham group (A), OXV group (B) and Spearmint group (C) showed positive reaction (head of arrow) (PAS) (200X).**

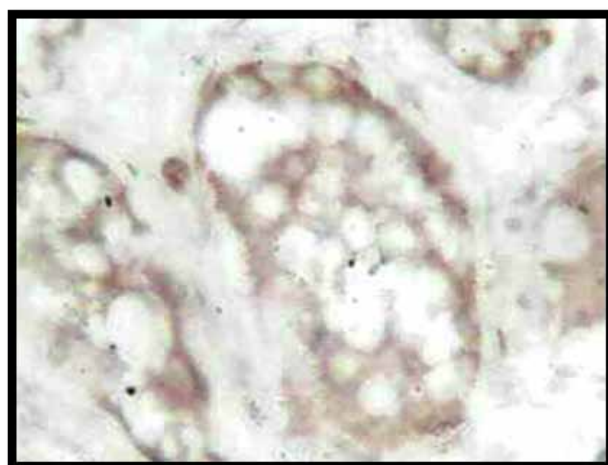
**Figure 5: Virgin Rgroups. Sham group (A), OXV group (B) and Spearmint groups (C) showed negative reaction of myoepithelial cells to the ALP (400X).**



A



B



C

**Figure 6: Lactating groups. Sham group (A), OXV group (B) and Spearmint group (C) showed positive reaction of myoepithelial to the ALP (head of arrow) (400X).**

## Discussion

Histological results showed a decrease in the size of the lobules and alveoli of mammary gland with less dilation in OVX virgin rabbits when compared to the sham group, this suggested that synthesized estrogen by the ovaries was very low in concentration of OVX animals due to the development of the mammary gland during the adult period<sup>19</sup>. Ovariectomized lactating rabbits showed decreased in the mammary parenchyma with an increase in the connective tissue. In contrast, the alveoli were rudimentary in ovariectomized animals when compared with the Control group, that might be because the estrogen produced by ovaries is very low in levels of ovariectomy rabbits<sup>20</sup>. Ovariectomy showed an impact on epithelial cell and induced a deep morphological disorganization of the mammary tissue<sup>19</sup>. The current study revealed that the intubation of female rabbits of all groups with 5.25 ml/kg b.w of hot aqueous extract of spearmint caused expansion in the size of lobules and number of alveoli, especially during lactation stages when compared with OXV group. These results revealed that the spearmint treated group had the ability to induce mammogenesis in virgin and lactating rabbits. Some studies concluded that in addition to estrogen and progesterone hormones, entire differentiation of the rabbit mammary gland development requires additional action of prolactin. The terminal stage of mammary gland development, lobuloalveolar growth is regulated by the production of prolactin hormone<sup>21,22</sup>. During early pregnancy the prolactin regulation the stimulation of ovarian progesterone in addition to assist in maintaining the required levels of progesterone<sup>23,24</sup>. Prolactin and progesterone up-regulation of PR expression suggest that those hormones can interact synergistically to regulate the alveolar growth. The prolactin stimulation compounds may raise the prolactin secretion via dropping levels of prolactin inhibitory factors<sup>25,26</sup>, such compounds are found in spearmint. Carvon is one of the compounds that resembles the chemical structure of dopamine (prolactin inhibitory compound) and competes with dopamine receptors which leads to prolactin secretion<sup>27,28</sup>. The results also revealed that spearmint had estrogen like effects. The estrogen hormone play important role in Proliferation of luminal epithelium, their differentiation and survival in mammary gland during pregnancy, lactation and virgin stages through its receptor ER $\alpha$ <sup>29</sup>. In addition, progesterone receptor and cyclin D1 are the downstream estrogen receptors. The progesterone receptor regulates the cyclin D<sub>1</sub> that has positive



feedback on is required for transcriptional activity of ER $\alpha$  in mammary gland development. On other hand, the progesterone receptor required for epithelial differentiation and morphogenesis<sup>29,30</sup>.

Moreover, the mammary stem cell might be ER positive<sup>31</sup>. This cell has the capability to produce whole mammary gland tissues; where the primary mammary stem cell leads by different processes to produce different cells found in the mammary parenchyma<sup>32,33</sup>. Accordingly, when estrogen hormones bind to estrogen receptor in stem cells of mammary gland that will induce the growth in mammary tissue constituent<sup>34</sup>. The proliferation effect of spearmint in mammary gland tissue may result from the ability of spearmint to decline the level of androgen hormone that causes suppression in growth of mammary gland with increase in estrogen hormone level<sup>35</sup>. Additionally, the hyperactivity of the experimental mammary gland in this study proposed to be due to biotransformation of saponin compound into sex hormones, where spearmint is capable of inducing<sup>36</sup>. The ALP enzyme plays an important role in the transport mechanism of phosphate, cell division, phosphorylation and dephosphorylation of other substances<sup>37</sup>, the mammary gland tissue of rabbits treated with spearmint hot aqueous extract seems to be strongly activated by the ALP enzymes in all physiological stages. This finding supported by the growth and development of mammary glands which attributed to an increase in the proliferation of mammary gland cells in rabbits<sup>22</sup>.

### Conclusion

The hot aqueous extracts of spearmint *Mentha spicata* leaves have Mammogenesis effect of mammary glands during virgin and lactating stages in ovariectomized rabbits.

**Conflict of Interest:** The authors declare that there was no conflict of interest

**Ethical Clearance:** Taken from Helsinki Declaration of 1975, as revised in 2000 committee.

**Source of Funding:** Self

### Reference

1. Bath D, Dickinson F, Tucker H, Appleman R. Dairy cattle: principles, practices, problem, profits., 3rd ed. The Iowa State Univ:press, Ames. 1985.
2. Lawrence R. Induced lactation and re-lactation (including nursing the adopted baby). In Breast feeding : A guide for the medical profession . 2nd ed., Philadelphia :Mosby Co.; 1985
3. Mescher AL. Junqueira's Basic histology text and atlas .14th ed .United State: McGraw-Hill; 2016.
4. Alexander, I.M., Andrist, L.C. In: Women's Gynecologic Health. Schuiling, K.D., Likis, F.E. (Eds.). Jones and Bartlett Publishers, Sudbury, 2006, 253-4.
5. Mahady, G.B., Huang, Y., Doyle, B., Locklear, T.D. Black cohosh (*Actaea racemosa*) for the mitigation of menopausal symptoms: Recent developments in clinical safety and efficacy. J Womens Health 2006, 2(5): 773-8
6. Sharifi-Rad, J.; Tayeboon, G.S.; Niknam, F.; Sharifi-Rad, M.; Mohajeri, M.; Salehi, B.; Iriti, M.; Sharifi-Rad, M. Veronica persica Poir. Extract-antibacterial, antifungal and scolicidal activities, and inhibitory potential on acetylcholinesterase, tyrosinase, lipoxygenase and xanthine oxidase. Cell. Mol. Biol. (Noisy-le-Grand France) 2018, 64, 50–56.
7. Sharifi-Rad, J.; Iriti, M.; Setzer, W.N.; Sharifi-Rad, M.; Roojintan, A.; Salehi, B. Antiviral activity of Veronica persica Poir. on herpes virus infection. Cell. Mol. Biol. (Noisy-le-Grand France) 2018, 64, 11–17.
8. Lawrence, B.M. Mint: The Genus *Mentha*; CRC Press: Boca Raton, FL, USA, 2006.
9. Mamadaliyeva, N.Z.; Akramov, D.K.; Ovidi, E.; Tiezzi, A.; Nahar, L.; Azimova, S.S.; Sarker, S.D. Aromatic medicinal plants of the Lamiaceae family from Uzbekistan: Ethnopharmacology, essential oils composition, and biological activities. Medicines 2017, 4, 8.
10. Salehi B; 'c-Radi'c Z; Mateji'c J; Sharopov F; Antolak H; Kręgiel D ID; Sen S; Sharifi-Rad M, Acharya K; Sharifi-Rad K; Martorell M; ID, Sureda A, Martins N ID and Sharifi-Rad J. Plants of Genus *Mentha*: From Farm to Food Factory. Plants. 2018, &, 7(02): 2-36.
11. Al bazii s, J; Al-Tu'ma, F J and Al-Obaidi. S R . Study the effects of Spearmint *Mentha Spicata* Extracts on Mammary Gland in Female Rats 2013 . Journal of Kerbala University, Scientific .11, 3 198-206

12. Akdogan, M.; Ozunger, M.; Aydin, G. and Gokalp, O. (2004). Investigation of biochemical and histological effect of menthe piperita and *Mentha spicata* on liver tissue in rat. *Human Toxicol.*, 23(1): 21-28.
13. Akdogan, M.; Tamer, E.; Cure, B.; Koroglu, B. and Delibas, N. (2007). Effect of *Mentha spicata* Labiate teas on Androgen level in women with hirsutism. *Phytother. Res.*, 21: 444-447
14. Al-Bazii SJ. Some Histological, Histochemical, Immunohistochemical and Functional Effects of Spearmint and Barley Extracts on Mammary Gland in Female Rats .Biology,[Ph.D thesis ]. Education of pure science,Kerbala University;2013.
15. Newall A, Linda A,Phillipson D .Herbal medicines:A guide for health-care profess-Iionals. London: The Pharmaceutical press; 1996.
16. Albozachri JM, Hameed FM, AL-Tomah HM, Muhammid H A . Evaluation of tow general anesthetic regimeby use xylazine and ketamine with atropine and diazepam in rabbits . *Journal of University of kerbala*.2017,15: 21-30
17. Suvarna SK, Layto C, Bancroft J D. Bancroft's Theory and Practice of Histological Techniques. 7<sup>th</sup> ed.China:Churchill Livingstone Elsevier;2013.
18. Pearse A, Reis J. The Histochemical Demonstration of a Specific Phosphatase (5-Nucleotidase). *Biochemical J*.1951, 50 (4) : 534-536.
19. Dessauge F, Finot L, Wiart S,Aubry J, Ellis, S.Effect of ovariectomy prepubrtal goat . *J. physiol. and Pharma.*,2009,60:127-133.
20. Obeid AK .Study histological and physiological effects of ovariectomy on pituitary, uterus and mammary gland in local rabbits (*Oryctologus cuniculus*).[PhD thesis] .Education college for pure sciences, Kerbala university;2018.
21. Ouedrago ZL, Heide DV, Beek EM, Swarts HJ, Mattheij JA, Sawadogo L.Effect of aqueous extract of *Acacia nilotica* ssp *adansonii* on milk production and prolactin release in the rat. *J Endocrinol*,2004,182 : 257-66.
22. Macias H, Hinck L. Mammary Gland Development. *Wiley Interdiscip Rev Dev Biol.*, 2012,1(4): 533–557.
23. Binart N, Helloco C, Ormandy CJ, Barra J, Clement-Lacroix P, Baran N, Kelly P.Rescue of preimplantatory egg development and embryo implantation in prolactin receptor-deficient mice after progesterone administration. *Endocr.*,2000, 141 : 2691-2697.
24. Tenorio FC, Simões MJ, Teixeira VW, Tixeira AC . Effects of melatonin and prolactin in reproduction: review of literature. *Rev AssocMed Bras.*, 2015, 61(3):269-274.
25. Speroff L, Class R, KaseN. The breast . In : clinical gynecologic endocrinology and infertility . 3<sup>rd</sup> ed.USA:Williams and Wilkers;1983
26. Ben-Jonathan N, Hnasko R . Dopamine as a Prolactin (PRL) Inhibitor. *Endocrine Reviews*, 2001, 22(6):724–763.
27. Albert-puleo M. Fennel and anis as estrogenic agent.*J.Ethnopharmacol*, 1986, 2 : 334-337.
28. Parveen T, Amin N, Saleem D, Razi F, Haider S, Haleem D . Antistress effect of *Mentha piperita* in rats and the role of brain serotonin andDopamine. *Asian J Pharm Biol Res.*,2012, 2 (1):73-78.
29. Feng Y.Mechanism of estrogen receptor-alpha action and the consequence of its conditional deletion on mammary gland development and function. [Ph.D.thesis].College of Medicine,University of Cincinnati;2007.
30. Surmacz E, Bartucci M. Role of estrogen receptor alpha in modulating IGF-I receptor signaling and function in breast cancer. *J Exp Clin Cancer Res.*,2004, 23 : 385-394.
31. Clarke RB, Spence K, Anderson E, Howell A, Okano H, Potten CS.A putative human breast stem cell population is enriched for steroid receptor-positive cells. *Dev Biol.*,2005, 277: 443-456.
32. Smalley MJ, Clarke RB. The mammary gland “side population”: a putative stem/progenitor cell marker?. *J Mammary Gland Biol Neoplasia*, 2005, 10 :37-47.
33. Stingl J, Raouf A, Emerman JT, Eaves CJ. Epithelial progenitors in the normal human mammary gland. *J Mammary Gland Biol Neoplasia*,2005, 10:49-59.
34. Aupperlee M, Haslam, S .Differential hormonal regulation and function of progesterone receptor isoforms in normal adult mouse mammary gland. *Endocr.*, 2007,148: 2290–2300.
35. Akdogan M, Tamer M, Cüre E, Cüre M, Köroglu B, Delibat N. Effect of Spearmint (*Mentha spicata* Labiatae) Teas on Androgen Levels in Women with Hirsutism. *Phytother. Res.*,2007, 21 :444–447.

36. Baraaj A, Al-Khateeb H, Al-Mahdawi F. Morphological studies on the effect of *Nigella sativa* seed on the ammary gland of mature male Norway rat. *Um-Salama Science Journal*, 2009, 6(1):123-127.
37. Murray R, Granner D, Mayes P, Rodwell V. *Harper's Illustrated Biochemistry*. 26<sup>ed</sup>. USA: The McGraw-Hill Companies, In;2003.

# Treatment of Postpartum Metritis in Dairy Cattle

Audaisabah Asker<sup>1</sup>, Ammar Rahem Mansoor<sup>2</sup>, A.A. Omar<sup>3</sup>, A.F. Majeed<sup>4</sup>

<sup>1</sup>Assist. Prof., <sup>2</sup>Lect., Animal Production, College of Agriculture, University of Anbar, Anbar, Iraq,

<sup>3</sup>Assist. Prof., <sup>4</sup>Prof., College of Veterinary Medicine, University of Fallujah Anbar, Iraq

## Abstract

After delivery uterine function usually exposed by bacterial contamination of the uterine lumen. This study was conducted on 21 cows of Holstein-Friesian breed, aged between 4-6 years, with parity of 2-4 times suffered from postpartum metritis. The disease diagnosed according to the clinical symptoms and vaginal examination. Animals divided into 3 equal groups. 1<sup>st</sup> group treated with PGF<sub>2</sub>α 20 mg/im., 2<sup>nd</sup> group treated with 2% lugol's Iodine Intra Uterine, while the 3<sup>rd</sup> group treated with lotagen 2% I.U. The results showed that the treatment with PGF<sub>2</sub>α give high efficacy rate 100% (7/7) than that with lugol's Iodine 57% (4/7) and with lotagen 71% (5/7). There was a significant difference (P≤0.05) in treatment with PGF<sub>2</sub>α as compared with other treatments, it was concluded from this study that PGF<sub>2</sub>α give the best results in postpartum metritis treatment.

**Keywords:** Postpartum metritis, dairy cows, PGF<sub>2</sub>α lugol's Iodine, lotagen.

## Introduction

Metritis defined as inflammation of whole layers of the uterus. It is most commonly occurs in the postpartum period of dairy cattle within 10-14 days after parturition<sup>(1)</sup>. Postpartum (pp.) contamination of the uterus with bacteria regarded as a causative criterion for infection<sup>(2,3)</sup>. It causes a great economical loss to the farmers especially in multiparous dairy cattle as a results of decrease of reproductive performance due to delayed uterine involution, increase calving interval, open days, number of service per conception<sup>(4-6)</sup>. There are many factors makes the cows more susceptible to metritis. These factors includes; Immune response, genetic factors, management factors, infections factors and nutritional and metabolic factors<sup>(5)</sup> There are several method to treat postpartum metritis reported by several authors<sup>(7-15)</sup>. Postpartum metritis is commonly treated with hormones or antibiotics or antiseptics alone or in combination<sup>(4,10,12)</sup>. The hormonal treatments

include; PGF<sub>2</sub>α, oxytocin and oestrogens<sup>(9,12,13)</sup>. The antiseptics includes lugol's Iodine solution, Bovidine and lotagen<sup>(12,13,16)</sup>. The antibiotic therapy includes; oxytetracycline, gentamycin, chloramphenicol and penicillin- streptomycin<sup>(4,12,13,16)</sup>. The study was aimed to investigate the response of treatment of postpartum metritis in dairy cattle with the PGF<sub>2</sub>α, Lugol's Iodine and lotagen.

## Materials and Method

The study was conducted on 21 cows of Holstein-Friesian breed aged between 4-6 years with parity of 2-4 in numbers, suffered from postpartum metritis, presented in the farm of coll. Vet. Med., Baghdad University. The postpartum metritis was diagnosed according to the clinical signs (mucopurulent discharge expelled through vagina) and vaginal speculum. Animals were divided into three equal groups. The 1<sup>st</sup> group (T<sub>1</sub>) were treated with prostaglandin PGF<sub>2</sub>α (Lutalyase, Upjohn co. USA). 20mg/im. The 2<sup>nd</sup> group (T<sub>2</sub>) were treated with 50ml Lugol's Iodine 2% (stock solution; 8 gm pot. Iodied; 4 gm crystal Iodine in 100 ml distal water) Intra Uterine (I.U.), three times per a week (one day and another). The 3<sup>rd</sup> group (T<sub>3</sub>) were treated with 2% Lotagen (Bioveta, a. s., Ukrainian,) I.U., three times per a week (one day and another). Animal showed normal estrus without vaginal discharge within 10-14 days after the treatment

---

### Corresponding Author:

**A.A. Omar**

Assist. Prof., College of Veterinary Medicine,  
University of Fallujah Anbar, Iraq  
e-mail: salahalabd79@gmail.com

regarded as positive response. Statistical analysis using chi-square.

## Results and Discussion

The main goal of treatment of postpartum metritis was to eliminate bacterial infection, stimulate uterine defense mechanism and increase hyperemia of the uterus. Also treated drug showed increase uterine muscle contraction to clear and evacuate uterine content<sup>(12-14,16)</sup>. The pharmacological therapy should not cause adulteration of milk and having antibacterial activity and do not cause a resistance<sup>(12,13)</sup>. Table -1 showed the effect of different method to treat postpartum metritis and the response and efficacy of each medication. There was a significant different ( $P \leq 0.05$ ) between treated groups in the response to the treatment.  $\text{PGF}_2\alpha$  which used in  $T_1$  showed an efficacy of 100% (7/7) while the treatment with Lugol's Iodine and Lotagen showed an efficacy of 57.1% (4/7) and 71.1% (5/7) for  $T_2$  and  $T_3$  respectively. The higher response obtained with  $\text{PGF}_2\alpha$  in treated animals might be due to the fact that  $\text{PGF}_2\alpha$  cause luteolysis to the corpus luteum that leads to decrease progesterone which inhibits uterine defense mechanism (UDM), oestrogen secretion that stimulate UDM., and  $\text{PGF}_2\alpha$  stimulate myometrial contraction that evacuate the uterine lumen from lochia, blood clot, cellular debris, exudate, pus and remnant of fetal membranes. Also  $\text{PGF}_2\alpha$  induce phagocytosis by attraction of leukocytes<sup>(12,13,17)</sup>. Similar observation has been made by several workers<sup>(12,14,16,18)</sup>. It has been reported that the  $\text{PGF}_2\alpha$  the most effective drug for metritis<sup>(19)</sup>, while others showed no improvement of the subclinical metritis<sup>(20,21)</sup>. It has been observed that administration of 25 mg/im of Dinoprost (synthetic  $\text{PGF}_2\alpha$ ) had an effect on reduction of the size of the uterus<sup>(22)</sup>. The low response in  $T_1$  and  $T_2$  which treated with lugol's Iodine and Lotagen respectively it might be due to that intrauterine infusions treated with these antiseptics leads to irritation and necrosis of endometrial wall and may cause damages to the endometrial glands. Similar results have been reported by many authors<sup>(12,13,16,23)</sup>, or it might cause inflammatory reactions that leads to fibrosis of endometrium<sup>(23)</sup>. It has been observed that the use of lugol's Iodine intrauterine have no beneficial effect on reproductive performance in cows with reproductive problems<sup>(24)</sup>. It has been explained that the use of 1% lugol's Iodine solution intrauterine in cows showed improvement against uterine infection due to its bactericidal and the slight hyperemia to the uterine mucosa that increased blood circulation and

enhance the uterine defense mechanism<sup>(23,25)</sup>. Also the chemotherapeutic with intrauterine infusion with chemicals might lead to unwanted effects to the uterus and damage of the oviduct may be occurred<sup>(16)</sup>.

**Table 1. Effect of different treatments on pp. metritis in dairy cattle.**

Type of treatment	No. of animals	Positive response	Efficacy %
( $T_1$ ) $\text{PGF}_2\alpha$ 20mg I.M.	7	7	100% a
( $T_2$ ) Lugol's Iodine 5%I.U.	7	4	57.1% b
( $T_3$ ) Lotagen 2% I.U.	7	5	71.4 %b
<b>Total</b>	<b>21</b>	<b>-</b>	<b>76.19</b>

Different small manuscripts mean significant difference at ( $p \leq 0.05$ ).

## Conclusion

It could be concluded from this study that  $\text{PGF}_2\alpha$  injection have a beneficial effect on treatment of postpartum metritis.

**Ethical Clearance:** The Research Ethical Committee at scientific research by ethical approval of both environmental and health and higher education and scientific research ministries in Iraq.

**Conflict of Interest:** The authors declare that they have no conflict of interest.

**Funding:** Self-funding

## References

1. Drillich M, Wagener K. Pathogenesis of uterine diseases in dairy cattle and implications for fertility. AR. 2018;15(Supplement 1):879–85.
2. Wagener K, Prunner I, Pothmann H, Drillich M, Ehling-Schulz M. Diversity and health status specific fluctuations of intrauterine microbial communities in postpartum dairy cows. Vet Microbiol. 2015;175(2–4):286–93.
3. Ahmed MN, Ynzeel JH, Majeed AF. Bacterial study of vagina in Awassi ewes treated with prostaglandin ( $\text{PGF}_2$   $\text{S}\alpha\text{S}$ ) and oxytocin. AJVS. 2017;10(1):96–9.
4. Noakes DE, Parkinson TJ, England GCW. Prolapse of the Cervix and Vagina. Vet ReprodObstet 9th Ed Saunders Elsevier Ltd Pub Balliere Tindall Engl. 2009;(Part 2):146–53.

5. Molina-Coto R, Lucy MC. Uterine inflammation affects the reproductive performance of dairy cows: A review. *Agron Mesoam*. 2018;29(2):449–68.
6. Toni F, Vincenti L, Ricci A, Schukken YH. Postpartum uterine diseases and their impacts on conception and days open in dairy herds in Italy. *Theriogenology*. 2015;84(7):1206–14.
7. Adnane M, Kaidi R, Hanzen C, England GCW. Risk factors of clinical and subclinical endometritis in cattle: a review. *TURK J VET ANIM SCI*. 2017;41(1):1–11.
8. Heuwieser W, Tenhagen BA, Tischler M, Lühr J, Blum H. Effect of three programmes for the treatment of endometritis on the reproductive performance of a dairy herd. *Vet Rec*. 2000;146(12):338–41.
9. Palmer C. Postpartum metritis in cattle: A review of the condition and the treatment. *Large Anim Vet Rounds*. 2003;3(8):1–6.
10. Szenci O. Recent possibilities for diagnosis and treatment of post parturient uterine diseases in dairy cow. *J FertilVitr IVF Worldw Reprod Med Genet Stem Cell Biol*. 2016;4:170.
11. Pecsí A, Foldi J, Szabo J, Nagy P, Kulcsar M, Huszenicza G. Efficacy of different antimicrobial therapeutic protocols for the treatment of puerperal metritis and endometritis in dairy cows. *Magy Allatorvosok Lapja*. 2007;129(10):590–9.
12. Deori S, Phookan A. Bovine postpartum metritis and its therapeutics: A Review. *Indian J Sci Technol*. 2015;8(23):1.
13. Paisley LG, Mickelsen W, Anderson PB. Mechanisms and therapy for retained fetal membranes and uterine infections of cows: a review. *Theriogenology*. 1986;25(3):353–81.
14. Hussain AM. Bovine uterine defense mechanisms: a review. *ZBL VET MED B*. 1989;36(9):641–51.
15. Giuliodori MJ, Magnasco RP, Becu-Villalobos D, Lacau-Mengido IM, Risco CA, de la Sota RL. Metritis in dairy cows: Risk factors and reproductive performance. *Int J Dairy Sci*. 2013;96(6):3621–31.
16. Pulfer KW, Riese RL. Treatment of postpartum metritis in dairy cows. *Iowa State Univ Vet*. 1991; 53(1):6.
17. Dhaliwal GS, Murray RD, Woldehiwet Z. Some aspects of immunology of the bovine uterus related to treatments for endometritis. *Anim Reprod Sci*. 2001;67(3–4):135–52.
18. Ahmed MN, Ynzeel JH, Majeed AF. Ultrasonographic study of uterine involution in of Awassi ewes in Iraq. *AJVS*. 2016;9(1):16–21.
19. Drillich M, Raab D, Wittke M, Heuwieser W. Treatment of chronic endometritis in dairy cows with an intrauterine application of enzymes: A field trial. *Theriogenology*. 2005;63(7):1811–23.
20. Galvão KN, Frajblat M, Brittin SB, Butler WR, Guard CL, Gilbert RO. Effect of prostaglandin F<sub>2α</sub> on subclinical endometritis and fertility in dairy cows. *J Dairy Sci*. 2009;92(10):4906–13.
21. Dubuc J, Duffield TF, Leslie KE, Walton JS, LeBlanc SJ. Randomized clinical trial of antibiotic and prostaglandin treatments for uterine health and reproductive performance in dairy cows. *J Dairy Sci*. 2011;94(3):1325–38.
22. Masoumi R, Badiei A, Mousakhani F, Dirandeh E, Zhandi M, Stear M. Quantification of the uterine involution and dimensions, hormonal response and reproductive performance of pyometric and healthy dairy cows treated with Dinoprost. *S Afr J Anim Sci*. 2018;48(2):222–33.
23. Melia J, Sadri B, Siregar TN, Riady G, Asmilia N, Hanafiah M, et al. The Effectiveness of Lugol for Endometritis Therapy in Aceh Cow. In: *E3S Web Conf*. 2020. p. 1008.
24. Drillich M, others. An update on uterine infections in dairy cattle. *SLOV VET RES*. 2006;43(1):11–5.
25. Sarkar AK. Therapeutic Management of Anoestrus Cows with Diluted Logul's Iodine and Massage on Reproductive Organs-uncontrolled Case Study. *ResJAnim Vet Sci*. 2006;1(1):30–2.

# Human Rights and Legal Protection of Persons with Disabilities in Aviation Industry in Indonesia

Adya Paramita Prabandari<sup>1</sup>, Elfia Farida<sup>1</sup>, Rahayu<sup>1</sup>

<sup>1</sup>Lecturer at Diponegoro University, Indonesia

## Abstract

Various matters relating to persons with disabilities are often overlooked and often lead to discrimination against them in various fields of life. Likewise, in Indonesia there is often discrimination against persons with disabilities in various aspects of life, including in aviation. For this reason, it is very important to analyze the protection of the rights of persons with disabilities in Indonesian aviation. The method used is a normative juridical method using a statute approach and conceptual approach to analyze secondary data obtained through library research. The government as a duty bearer is fully responsible for ensuring good and accessible service quality and providing facilities for persons with disabilities in flight. Likewise, airport and airline operators as air transport service providers should have SOPs of services that are in accordance with Government policy in order to provide maximum and equal services for persons with disabilities, as a form of protection for the rights possessed by persons with disabilities.

**Keywords:** Protection, rights of disabilities, aviation, Indonesia.

## Introduction

Globalization is a very rapid and fundamental change in the structure of human life that has occurred since the beginning of the 21st century, and brings enormous changes in various fields, including the field of transportation. The development of transportation technology is very rapid, where the current movement of people, capital, and goods, both between countries and between regions in various parts of the world takes place more quickly with the support of aircraft transportation modes. Modes of aircraft transportation are not only used by people with normal conditions, but are also carried out by people who have different abilities and conditions from normal and reasonable of people with disabilities. In Indonesia, problems relating to persons with disabilities are often ignored and often lead to discrimination against them in various fields of life.

Likewise in civil aviation, where there are several times discrimination against persons with disabilities carried out by airlines, even the case reaches the legal domain<sup>1</sup>.

In aviation industry, there are some incidences discriminating persons with disabilities in flight, although WHO has stated that disability is a human condition, and is not a type/form of disease<sup>2</sup>. In addition, another form of discrimination carried out by airlines against persons with disabilities is the obligation to bring a companion for persons with visual impairments and other persons with disabilities, due to the notion that aircraft are not directly accessible for people with mobility disabilities<sup>3</sup>. Persons with disabilities, as members of the community and Indonesian citizens, truly have the same position, rights and obligations as other Indonesian citizens, although it cannot be denied that persons with disabilities have physical and/or mental disorders that can interfere or constitute obstacles to carrying out activities like people without disabilities. This paper explores the protection of persons with disabilities in Indonesian aviation by using human rights perspective.

---

## Corresponding Author:

**Adya Paramita Prabandari**

Lecturer at Faculty of Law, Diponegoro University, Jl. Prof. Soedarto, Tembalang, Semarang, Central Java-50275, Indonesia

e-mail: adyaprabandari@gmail.com

## Research Method

The research method used in this paper is a normative juridical method<sup>4</sup>, using a statute approach and

conceptual approach<sup>5</sup>. The data used are secondary data obtained through library research. The data is processed and analyzed using qualitative analysis method and then presented in the form of systematic writing.

**The Perspectives of Human Rights of People with Disabilities:** Article 1 of the Convention on the Rights of Persons with Disabilities describes that persons with disabilities include those who have long-term physical, mental, intellectual or sensory impairments which in interaction with various barriers may hinder their full and effective participation in society on an equal basis with others. Meanwhile, according to the International Classification of Functioning, Disability, and Health, disability is defined as problems in the body function or structure such as a significant deviation or loss, a reduction, an increase, or an excess<sup>6</sup>. People with disabilities can be classified some, which are mobility and physical impairments, spinal cord disability, acquired brain injury, vision disability, hearing disability, cognitive or learning disabilities, psychological disorders and invisible disabilities.

Human rights are rights possessed by humans, solely because he is human. Humans have human rights not because they are given to them by the community or based on positive law, but merely based on their dignity as human beings<sup>7,8</sup>. Human rights are fundamental rights in human beings. The institutionalization of human rights began with the enactment of various human rights instruments in various countries in the form of laws and declarative instruments containing provisions on human rights, including: Bill of Rights) in England in 1688; Declaration of Independence in 1776; and Declaration des Droits de l'homme et du Citoyen in France in 1789<sup>9</sup>. These instruments are the starting point for the discussion of human rights instruments so that they finally produce the Universal Declaration of Human Rights (UDHR) which is a document of international recognition of human rights prepared by the UN Human Rights Commission. This declaration was accepted by United Nations General Assembly Resolution Number: 217A (III) on 10 December 1948.

In the First Paragraph of the Opening of the UDHR it was stated that while recognition of the inherent dignity and of the equal and inalienable rights of all members of the human family is the foundation of freedom, justice and peace in the world. This is an affirmation that human rights are the basis of freedom, justice and peace in the world. Furthermore, Article 3 of the UDHR states that

everyone has the right to life, liberty and security of person. The human rights inherent in every human being affirmed in Article 3 of the UDHR are of course also inherent in persons with disabilities. As part of humanity and having the same human rights as other people who do not have barriers and disabilities, an important milestone in the recognition, respect and protection of human rights is the ratification of the Convention on the Rights of Persons with Disabilities (CRPD) on December 13 2006 in the 61st Session of the UN General Assembly with resolution A/RES/61/106. This convention came into force on May 3, 2008. CRPD is a convention based on the concept of modern equality that has developed in various phases of equality law with different ideas of equality<sup>10</sup>.

The purpose of CRPD is to promote, protect, and ensure the full and equal enjoyment of all human rights and fundamental freedoms by all persons with disabilities, and to promote respect for their inherent dignity. States are required to report regularly about the implementation of the rights of disabled people to enable the Committee to monitor the implementation of the Convention from time to time<sup>11</sup>. For this reason, the States Parties to this convention have obligations which include guarantee and promote the full realization of all human rights and fundamental freedoms for all persons with disabilities without discrimination in any form that is based on disability; prohibit all discrimination based on disability and ensure equal and effective legal protection for persons with disabilities against discrimination based on any reason; adopt policies that are immediate, effective, and appropriate to increase awareness of the whole community, including at the family level, regarding persons with disabilities, and to maintain respect for the rights and dignity of persons with disabilities; and to combat stereotypes, prejudices, and harmful practices concerning persons with disabilities, including those based on gender and age, in all aspects of life; take appropriate policies to ensure access for persons with disabilities, on an equal basis with others, to the physical environment, transportation of information and communication, including information and communication technology and systems, and to other facilities and services that are open or available to the public, both in urban and rural areas.

**Legal Protection of Persons with Disabilities in Indonesian Regulations:** In human rights law, the State or Government has a duty bearer covering 3 (three) obligations, that are obligation to respect, obligation



to fulfill and obligation to Protect<sup>9</sup>. With regard to human rights owned by persons with disabilities and the Government of Indonesia as a duty bearer, the Government of Indonesia on February 28, 1997 has enacted Law No. 4 of 1997 concerning Disabled Persons, which among others regulates the rights and obligations of persons with disabilities, equality of opportunities owned by persons with disabilities in every aspect of life, as well as criminal provisions for offenders and administrative sanctions.

Along with the development of the times and the evolution of thought in society, especially in medicine, in the international world the term and concept of impairment, then changed to disability, which is considered more complex and comprehensive than impairment<sup>12</sup>. Furthermore, impairment is instead a component of disability, in the Disability Component Categorization such as impairment, limited activity and participation, individual characteristics and environment and individual effects<sup>13,12</sup>. Impairment is only one component of the four categories of disability components. In this case, the social environment is also a component that plays a role in creating social and cultural barriers for persons with disabilities to be able to live equally as members of the community. The community also has the responsibility to remove these barriers so that the mobility of persons with disabilities becomes more spacious and more free to be able to access and utilize the potential resources around them for the development of their potential to be able to realize their independence.

Changes in the mindset and concept of impairment to use the term “disability” in the international community inevitably lead to changes in the policy orientation of the Government of Indonesia. This was proven by the participation of Indonesia as one of the signatory States that signed the Convention on the Rights of Persons with Disabilities on March 30, 2007, and then ratified it with Law Number 19 of 2011 concerning Ratification of the Convention on the Rights of Persons with Disabilities which took effect on November 10, 2011. This was followed by the enactment of Law No. 8 of 2016 concerning Disabled Persons, which replaced Law No. 4 of 1997 concerning Disabled People because it no longer complies with the paradigm of the needs of persons with disabilities. In addition, the Government also includes elements of protection for persons with disabilities in various laws and regulations in Indonesia, including those relating to aviation.

In various laws and regulations regarding aviation and air transportation, the Government of Indonesia has included rules regarding services and handling for persons with disabilities. First, Law No. 1 of 2009 concerning Aviation stated that the holder of a commercial air transportation business permit is obliged to serve prospective passengers fairly without discrimination on the basis of ethnicity, religion, race, class, and economic and social status. This article regulates the right of persons with disabilities to receive services in the form of special treatment and facilities from commercial air transport businesses. Services in the form of special treatment and facilities include at least to provide priority to additional seats; provision of facilities for boarding and alighting from aircraft and facilities while in the aircraft; the availability of personnel who can communicate with people with disabilities; and the availability of manuals on flight safety and security for aircraft passengers and other facilities that can be understood by persons with disabilities. Additional treatment and facilities are free of charge. Services in the form of special treatment and facilities for passengers with disabilities or sick people are intended so that they can also enjoy proper transportation services. Moreover, Article 239 stipulates that persons with disabilities are entitled to receive services in the form of special treatment and facilities from an airport business entity or airport operating unit.

Second, the protection is specified in Minister of Transportation Regulation No. PM 98 of 2017 concerning Accessibility for Persons with Disabilities and Sick People in Transportation Facilities and Infrastructure. The Regulation regulates that public transportation service providers are required to provide accessible service facilities and infrastructure for service users with special needs such as assistive devices to move up and down from and to transportation facilities, audio/visual information about travel that is easily accessible, priority seating and easily accessible toilets, and the provision of specific signs or instructions in the service area at the means of transportation. Transportation service providers are also required to provide information centers and personnel equipped with relevant training in order to help service users with special needs. Minister of Transportation Regulation No. 38 of 2015 concerning Domestic Air Transport Passenger Service Standards regulates to persons with disabilities that passengers with special needs are passengers because of their physical condition and/or special requests for

passengers who need special facilities and treatment, such as persons with disabilities, elderly people, children, pregnant women and sick people. The air transport service providers in providing services for air transport passengers must have a reference in the form of air transport passenger service standards. The service standard starts at the time of entering the airport gate until the passenger exits from the airport gate after the flight. Domestic air passenger service standards at airports must contain the following components: safety services; security services; reliability service; comfort service; convenience services; and equality services. Even indicators and benchmarks for the fulfillment of the equality service components have been provided in Attachment I to this Ministerial Regulation. The service standards for domestic air transport passengers while on board aircraft that contain the same components as the domestic air passenger service standard components at airports. The air transport passenger service provider is required to prepare a standard service document in accordance with the specified components, and the document must be approved by the Director General of Civil Aviation.

In addition, Minister of Transportation Regulation No. 77 of 2015 concerning Airport Facility Standardization and Certification regarding passengers with special needs regulated in Article 9, stated that airport facilities for passengers with special needs must be able to provide services to passengers with special needs with or without the help of others, safely and comfortably. However, there is still a variety of discrimination against persons with disabilities in Indonesian civil aviation and other public sectors.<sup>14,15</sup> This is often caused by a lack of socialization and information received and understood, both by airport officials and airline staff (ground-staff and cabin crew), regarding the rules of non-discriminatory service standards for persons with disabilities, both rules in statutory regulations which are government policies, as well as airline service standards issued by each airline as an air transport business entity.

### Conclusion

The Indonesian Constitution provides for the recognition, guarantees and protection of the human rights of all its citizens, including persons with disabilities who are also human beings who have fundamental and human rights like other humans in general who are inherent from their birth and cannot be taken away or violated by anyone. Therefore, the Government of Indonesia as a

duty bearer has the obligation and responsibility to fulfill the human rights inherent in persons with disabilities. Various government policies, especially in the field of aviation, have also accommodated and provided special rules regarding matters relating to persons with disabilities. For example, standardization of services and treatment of persons with disabilities. However, in practice it cannot be denied that there are still many violations and discrimination against people with disabilities. Existing regulations are still not very well known to all airport operators and air transport business entities (airlines), so they have not been able to apply effectively in practice. Therefore, the government should be the duty bearer who is authorized to issue regulations, fully responsible for ensuring good and accessible service quality and providing facilities for persons with disabilities. Likewise, airport and airline operators as air transport service providers should have SOPs of services that are in accordance with Government policies in order to provide maximum and equal services for persons with disabilities, as a form of protection for the rights possessed by persons with disabilities.

**Ethical Clearance:** This research was ethically approved by Faculty of Law, Universitas Diponegoro, Semarang, Indonesia

**Funding:** The research was financially funded by Faculty of Law, Diponegoro University from the 2020 fiscal year.

**Conflict of Interests:** There are no conflict of interests.

### References

1. Prabandari AP, Susetyorini P, Hartono D. The urgency of ratification of the 2010 Beijing convention concerning enforcement of unlawful acts against international civil aviation. *Academic Journal of Interdisciplinary Studies*. 2020;9(2): 31-35.
2. World Health Organization. *World report on disability 2011*. WHO;2011.
3. Darcy S. (Dis) embodied air travel experiences: Disability, discrimination and the effect of a discontinuous air travel chain. *Journal of Hospitality and Tourism Management*. 2012;19:50.
4. SoemitroRH. *Legal research methodology and jurisprudence*. Ghalia Indonesia;1990..

5. Ibrahim J. Theory and methodology of normative legal research. Bayumedia;2006.
6. Silva TN, Guarda JB, Silva LL, Figueiredo JP, Menegon NL. Passengers with disabilities in the Brazilian air transport: different actors and similar perspectives. *Gestão & Produção*. 2017 Apr;24(1):136-47.
7. Donnely J. Universal human rights. Theory and Practice; 2003.
8. Smith RK, Asplund KD, Marzuki S. Human rights law. Center for the Study of Human Rights, UII;2008.
9. Rahayu. Human Rights Law. Semarang: Diponegoro University Press;2015.
10. Degener T. Disability in a human rights context. *Laws*. 2016;5(3):35.
11. Chouinard V. Living on the global peripheries of law: Disability human rights law in principle and in practice in the global south. *Laws*. 2018;7(1):8.
12. Prasetyo FA. Disability and health issues: between the evolution of concepts, human rights, complexity of problems, and challenges. Jakarta: Ministry of Health; 2014.
13. Dempsey IJ, Nankervis K. Community disability services: An evidence-based approach to practice. Purdue University Press;2006.
14. Silalahi W, Hamzah G, Saraswati R, Tyesta L. Controversy of the capability of voters with mental health disorder in the general election. *Medico-Legal Update*. 2020;20(2):703-707
15. Utami NS, Prasetyoningsih N, Hidayat A, (...), Saraswati R, Budiono A. Equality of the political rights of people with mental disorders (PWMD) in general elections. *Indian Journal of Forensic Medicine and Toxicology*. 2019;13(4):1571-1575.

# Preparation and Identification of Metal Ions Complexes for 4-(P-Phenyl azo sulfonic acid)-1-Naphthol Dye

Haider S. Mohammed<sup>1</sup>, Shaimaa H. Mallah<sup>2</sup>

<sup>1</sup>Lecturer, <sup>2</sup>Ass. Lecturer, Department of Chemistry, College of Science, Al Muthanna University, Al Samawa City-66001, Iraq

## Abstract

The organic reagent, 4-(p-phenyl azo sulfonic acid)-1-naphthol, was found to be sensitive and selective reagent for the spectrophotometric determination of trace amounts of Cobalt and Nickle. The prepared complexes and azo reagent were characterized using FT-IR and UV-Vis spectroscopic method. The complexes have a maximum absorption at (453) nm and (446) nm for both Cobalt (II) and Nickle (II) (respectively, Beer's law was obeyed in the range (0.5-2.5) ppm of Cobalt and molar absorptivity  $\epsilon = 3.24 \times 10^4$  L.mole<sup>-1</sup>.cm<sup>-1</sup>, as for Nickle, the range was (0.1-2) ppm and molar absorptivity  $\epsilon = 0.96 \times 10^4$  (L.mol<sup>-1</sup>.cm<sup>-1</sup>. The accuracy and reproducibility of the determination method for various known amounts of cobalt (II) and Nickle (II) (were tested). The results obtained are both precise (RSD was better than 1.6 %, 3 %) for both Cobalt (II) and Nickle (II) (respectively and accurate (relative error was better than 1 %, 2 %) for both Cobalt (II) and Nickle (II) (respectively).

**Keyword:** Metal Ions Complexes, 4-(P-Phenyl azo sulfonic acid)-1- naphthol Dye.

## Introduction

Essential elements are of important in many biological functions. Metals can be found in enzymes and cofactors required for various processes [1]. Nickel is a constituent of the enzyme urease and considered to be essential to plants and some domestic animals [2]. The deficiency of nickel may lead to health risks such as bone deformities but excess nickel can cause lung cancer and cardiovascular [3]. Cobalt is an essential element for enzymatic functions in all mammals and it is part of vitamin B12, which is important in protein formation and DNA regulation [4]. Exposures to a high level of cobalt lead to serious public health problems and are responsible for several diseases in human such as asthma, pneumonia, and cardiomyopathy [5]. The consumption of large quantities of nickel and cobalt-containing products

in industry inevitably leads to environmental pollution at all stages of production, recycling and disposal. Thus, the determination of trace levels of nickel and cobalt in biological and environmental samples is an important analytical task. The determination of nickel and cobalt in water samples of environmental interest in which it is found at very low concentrations requires the use of pre-concentration method coupled to spectroscopic method [6,7].

In the present study we wish to introduce this reagent as a selective reagent in spectrophotometric determination of micro amounts of cobalt (II) and nickel (II) in simple and sensitive method.

**Apparatus:** A Shimadzu double-beam UV-visible Spectrophotometer model UV-1650 (Japan) equipped with 1.00 cm quartz cells is used for the scanning study of absorption spectra of the complexes formed. FT-IR Absorption spectra were taken on (Test scan Shimadzu FT-IR 8000 series). Measurements of pH were made using an (Hanna, HI9811-5 pH – meter) equipped with a glass - saturated calomel combined electrode. Melting points of ligand and complexes were obtained with an electro thermal melting point apparatus. Conductivities

---

### Corresponding Author:

**Haider S. Mohammed**

Lecturer, Department of Chemistry, College of Science, Al Muthanna University, Al Samawa City-66001, Iraq  
e-mail : haidersmohammad97@gmail.com

were measured for  $10^{-3}$  M of complexes in DMSO at  $25^{\circ}\text{C}$  using (Alpha digital conductivity model -800).

**Standard solutions of copper(II) and Nickel (II):** A stock solution of  $\text{Co}^{2+}$  and  $\text{Ni}^{2+}$  (100 ppm) were prepared by dissolving (0.0025g) of  $\text{CoCl}_2 \cdot 6\text{H}_2\text{O}$  and (0.0035 g) of  $\text{NiCl}_2 \cdot 2\text{H}_2\text{O}$  in 100 mL distilled water, other working standard solutions were prepared by simple dilution of the appropriate volume of the stock solution with distilled water .

**4-(p-phenylazo sulfonic acid)-1-naphthol solutions:** 4-(p-phenylazo sulfonic acid)-1-naphthol) was synthesized and recrystallized according to the method mentioned in previous study [8] A stock solution ( $1 \times 10^{-3}\text{M}$ ) was prepared by dissolving 0.082 g of reagent in 250 mL of ethanol. More dilute solution of the reagent was prepared as required.

**Preparation of complexes:** The complex was prepared by stoichiometric amount from ligand in 100 mL of ethanol then added drop wise with stirring to a stoichiometric amount 2:1 for metal salt in 50 mL distilled water. The mixture was stirred at room temperature for 5 min. The pH of solution was adjusted to optimum pH then left for 24 hr. The solid product thus formed off,

washed with distilled water, and recrystallized from ethanol.

**General Procedure:** In to a series of 10 mL calibrated flask, transfer increasing volumes of Co (II) and Ni(II) working solutions ( $10 \mu\text{g mL}^{-1}$ ) to the range of the calibration curve, add 1.5 mL and 2.5 mL of  $1 \times 10^{-3}$  M of 4-(p-phenylazo sulfonic acid)-1-naphthol) solution for Co (II) and Ni(II) respectively . The pH (7.6,9.0) for Co (II) and Ni (II) was adjusted with dilute hydrochloric acid and sodium hydroxide solutions. The complexes formed were solubilized in water and diluted up to 10 mL with distilled water. Measure the absorbance at 446 nm for Co (II) and at 453 nm for Ni(II) complexes against a reagent blank .

## Results and Discussion

### Spectra photometric studies:

**I-Absorption spectra:** The absorption spectra for Co (II) and Ni (II) complexes with 4-(p-phenylazo sulfonic acid)-1-naphthol) against blank solution are shown in Fig. 2, 3. The maximum wavelengths of two complexes are 453nm and 446 nm, respectively.

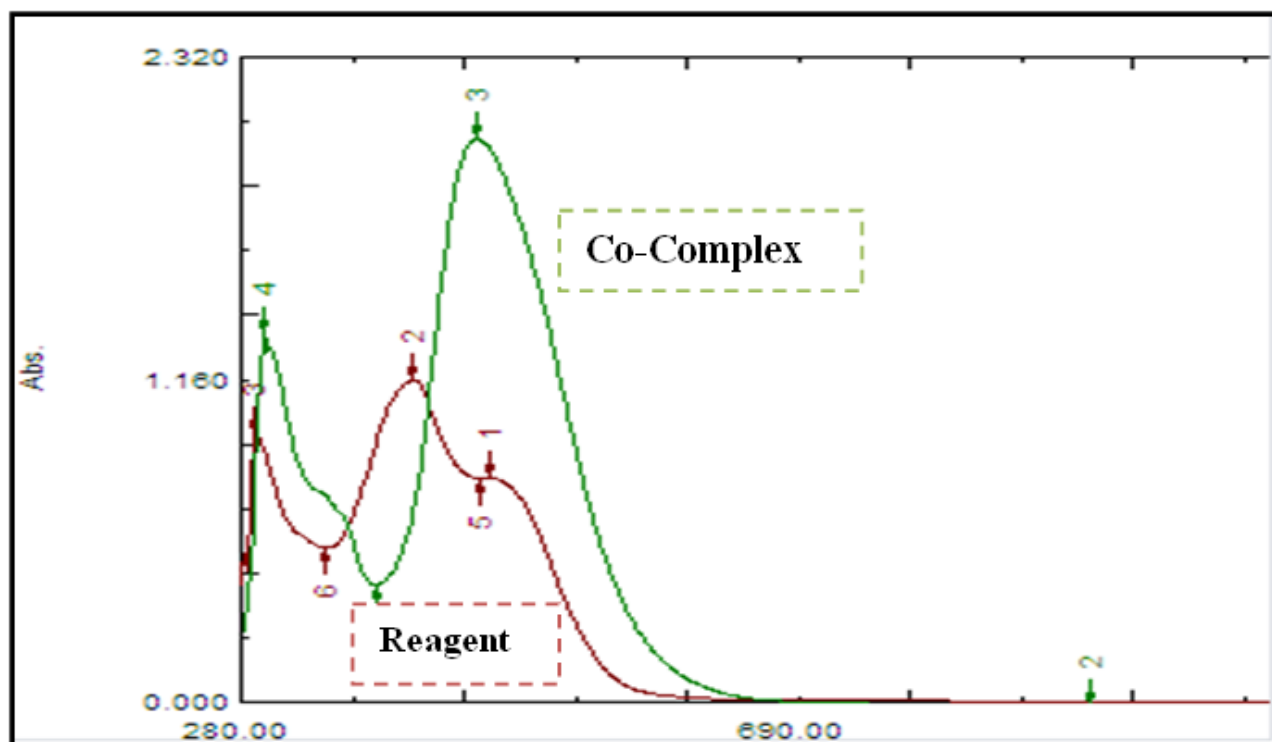
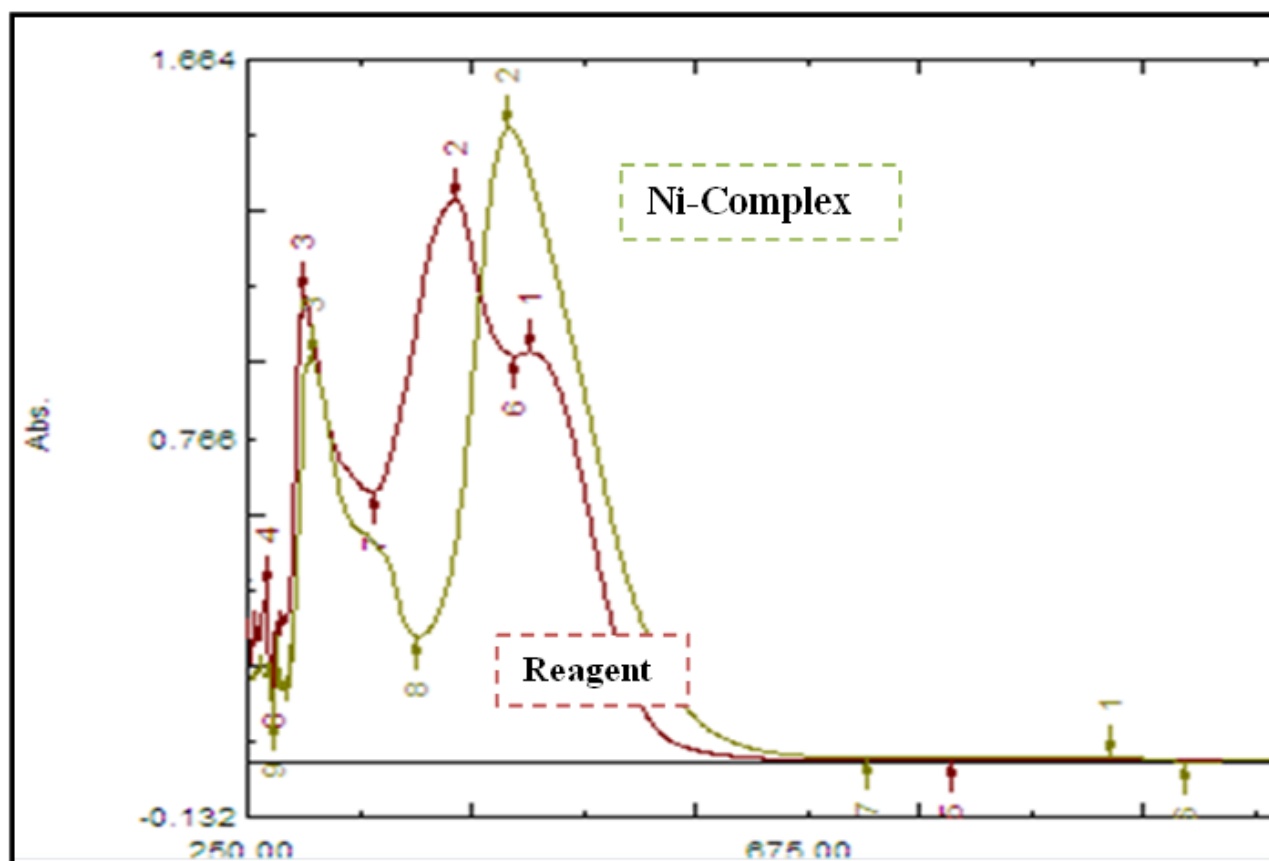


Fig. 2: Absorption spectra of [Co (II) + 4-(p-phenylazo sulfonic acid)-1-naphthol)] treated as described under procedure and against reagent solution as blank.



**Fig. 3: Absorption spectra of [Ni (II) + 4-(p-phenylazo sulfonic acid)-1-naphthol] treated as described under procedure and against reagent solution as blank.**

**II-Infrared Spectra:** The FT.IR of the free ligand and its complexes with Co (II) and Ni (II) ions are given in Table.1. The IR spectrum of ligand exhibited broad band at  $3437.26\text{ cm}^{-1}$ , has been assigned to the naphtholic OH group<sup>[9]</sup>. In the spectra of Co(II)-Complex and Ni(II)-Complex the broad weak absorption band around  $3392.90\text{ cm}^{-1}$  and  $3230.87\text{ cm}^{-1}$  respectively indicates the presence of water in these complexes<sup>[10]</sup>. Two absorption bands are observed at  $1450.52\text{ cm}^{-1}$  and  $1384.94\text{ cm}^{-1}$  in the reagent spectrum, which are due to the azo group  $\nu(\text{N}=\text{N})$ . These bands shifted in complexes, which suggest engagement of this group in the coordination with the metal ion<sup>[11,12]</sup>. The weak bands observed at  $2968\text{ cm}^{-1}$  in the spectrum of reagent which are due to  $\nu(\text{C}-\text{H})$  aromatic. These bands are stable in position in both reagent and metal complexes. The appearance of new bands around (500-400) due to (M-N)<sup>[13,14]</sup>.

To optimize the conditions for determination of Cobalt (II) and Nickel (II) (such factors as The pH of the solution, the concentration of 4-(p-phenyl azo sulfonic

acid)-1-naphthol) and composition of complexes were evaluated.

**Table 1: Selected FT.IR data of reagent and its complex with Co (II)**

Compound	$\nu(\text{OH})$	$\nu(\text{C}-\text{H})$ arom.	$\nu(\text{N}=\text{N})$	$\nu(\text{M}-\text{N})$
HL	$3437.26\text{ m}$	$2968\text{ w}$	$1450.52\text{ m}$ $1384.94\text{ s}$	–
[Co (L)]	$3392.90\text{ w}$	$2968\text{ w}$	$1490\text{ m}$ $1460\text{ s}$	$550\text{ w}$
[Ni (L)]	$3230.87\text{ w}$	$2968\text{ w}$	$1500\text{ m}$ $1411\text{ s}$	$520\text{ w}$

S: sharp; m: medium; w: weak

**Effect of pH:** The effect of pH was also studied at pH range (5 - 10) and the absorbance- pH curves for each complexes measured at certain ( $\lambda_{\text{max}}$ ) were plotted. Fig.(4) showed a selective pH- absorbance curves. The plateau of the curves represent the completion of the reaction and consequently represent the optimum pH.

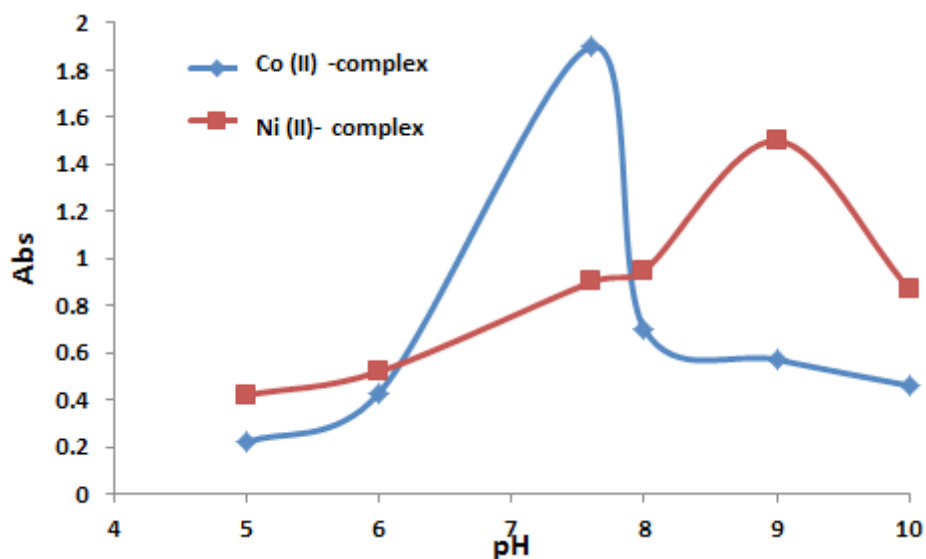


Fig. 4: Effect of PH on complex formation

Table 2: Analytical characteristics of complexes.

Characteristic	Co (II) – complex	Ni (II) – complex
Maximum Absorption peak (nm)	453	446
Beer's law validity range (ppm)	(0.5–2.5)	(0.1–2)
pH range	(6–8)	(8–10)
Sandell's sensitivity $\mu\text{g} \cdot \text{cm}^{-2}$	0.0018	0.0062
Molar absorptivity ( $\text{L} \cdot \text{mol}^{-1} \cdot \text{cm}^{-1}$ )	$3.24 \times 10^4$	$0.96 \times 10^4$
Melting point for complex	$283\text{C}^0$	$242\text{C}^0$
Relative Standard Deviation (n= 6)	1.6%	3%

**Effect of reagent concentration:** Keeping a constant concentration ( $10 \mu\text{g} \cdot \text{mL}^{-1}$ ) of Co(II) and Ni(II) solutions, the effect of reagent concentration ( $1.0 \times 10^{-3}$  M) on absorbance of the complexes was studied by varying the amount of the volume of reagent (0.5-4.0) mL. The required volumes of 4-(p-phenyl azo sulfonic acid)-1-naphthol were found to be 1.5 mL and 2.5 mL to complete the reaction of Co (II) and Ni (II) respectively. The result are shown in fig.5.

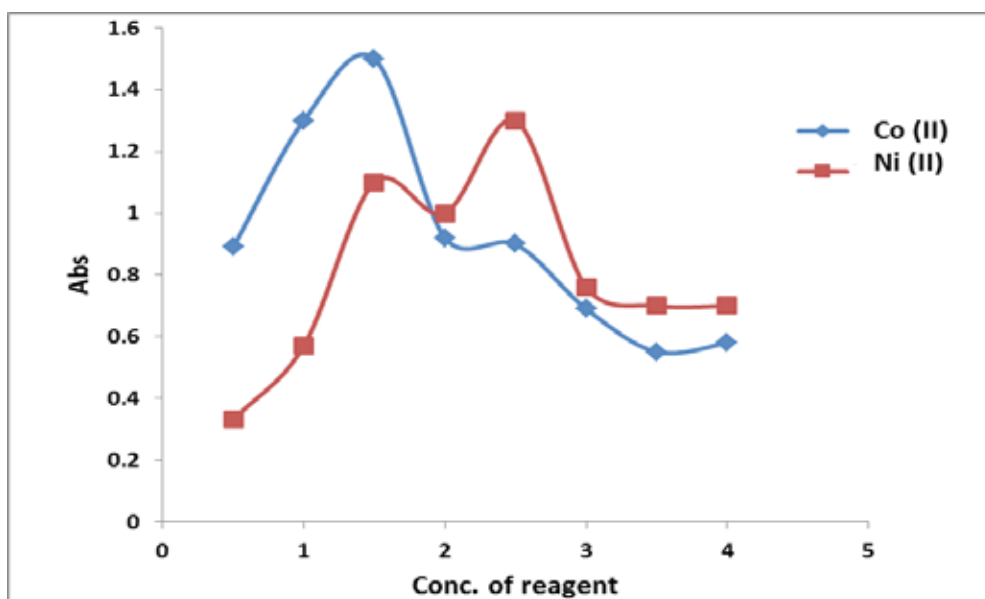


Fig. 5: Effect of reagent concentration

**Calibration Graph:** The calibration curves obtained show a linear relationship between absorbance and concentration held over range of 0.5-2.5  $\mu\text{g mL}^{-1}$  and 0.1-2  $\mu\text{g mL}^{-1}$  for cobalt and Nickle respectively. The molar absorptivity and Sandell's sensitivity are given in Table.1 .

**Composition of the complexes:** Job's method of continuous variations<sup>[15]</sup> was chosen to study the ratio of metal to reagent, results illustrated in Figures 6. The method indicated that the ratio of metal ion to reagent molecules (M:L) was (1:2) at optimum pH.

### Conclusion:

In this study it was shown that 4-(p-phenylazo sulfonic acid)-1-naphthol) could be used as a reagent for the Spectrophotometric determination of Cobalt (II) and Nickle (II). It offers advantages like reliability and reproducibility in addition to its simplicity.

**Ethical Clearance:** The Research Ethical Committee at scientific research by ethical approval of both environmental and health and higher education and scientific research ministries in Iraq

**Conflict of Interest:** The authors declare that they have no conflict of interest.

**Funding:** Self-funding

### References

- Ombaka O, Gichumbi JM. Spectrophotometric determination of cobalt (ii) in low concentrations using hydroxytriazene as selective chelating agents. *African Journal of Pure and Applied Chemistry*. 2011 Dec 10;5(15):494-502.
- Poonkothai M., Vijayavathi BS. Nickel as an essential element and a toxicant. *International Journal of Environmental Sciences*. 2012;1(4):285-288.
- Vuong ND, Minh ND, Tong NX. Simultaneous spectrophotometric determination of Cu (II), Co (II), Ni (II), using 1-(2 pyridylazo)-2 (naphthol (PAN) be chemometric method. 2015;4(4): 135-141.
- Malik AK, Kaul KN, Lark BS, Faubel W, Rao AL J. Spectrophotometric determination of cobalt, nickel palladium, copper, ruthenium and molybdenum using sodium isoamylxanthate in presence of surfactants. *Turkish Journal of Chemistry*. 2001;25:99-105.
- Veerachalee N, Taweema P, Songsasen A. Complexation and Spectrophotometric Determination of Cobalt (II) Ion with 3-(2'-thiazolylazo)-2, 6-diaminopyridine. *Agriculture and Natural Resources*. 2007 Dec 30; 41(4):675-80.
- Modawe NM, Eltayeb MA. H-point standard addition method for simultaneous spectrophotometric determination of cobalt (II) and nickel (II). *Advances in Analytical Chemistry*. 2013; 3(1): 1-7.
- Safavi A, Abdollahi H, Nezhad MH, Kamali R. Cloud point extraction, preconcentration and simultaneous spectrophotometric determination of nickel and cobalt in water samples. *Spectrochimica Acta Part A: Molecular and Biomolecular Spectroscopy*. 2004 Oct 1;60(12):2897-901.
- Mohammed HS., Yasir AM. The Study Preparation and Identification New Dye of Azo Dyes. *International Journal of Advanced Research*. 2017 5(5): 164-169.
- Dhahir SA, Bakir SR. Cloud point extraction spectrophotometric determination of nickel, copper, cobalt and chromium by 4-HBDA1, 5DPHP as reagent in wastewater of Iraq. *Environ. Sci*. 2015;10(4):150-160.
- Mallah SH, Mohammed HJ. Spectrophotometric determination of Micro amount of Cobalt (II) by Using (Antipyriyl azo 1-Nitroso-2-naphthol) as New reagent in raw Milk. *International Journal of Engineering & Technology* .2014, 14(2):102–111 .
- Shaheed I M.,Hussein A F., Hatamb R S. Spectrophotometric Study for Determination of Cobalt (II) by the Reagent [2-(4-Methoxyphenyl) Azo(4,5-Diphenylimidazole)](MPAI). *International Journal of Pharmacy and Pharmaceutical Research*. 2016, 6 (4): 671-683.
- Ali AM., Mohammed HJ.; Synthesis and solvatochromic studies of 2- amino-3-phenolazo1-(4-sulfophenyl)-3-methyi-5-pyrozolone and use it for the determination of trace amount of Nickel (II) in blood samples. *International Journal of Bioassay*.2016 5.10, 4920:4926 .
- Al-Jibouri MN. Synthesis and characterization of transition metal complexes with azo ligand derived from 4-hydroxy-6-methyl-2-pyranone. *Eur. Chem. Bull*. 2014 Apr 7;3(5):447-451.



14. Mezaal EN, Sadiq KA, Mohammed MA, Rumez RM. Spectrophotometric Determination of Co (II) by Using Ethyl Cyano (2-Methyl Carboxylate Phenyl Azo Acetate)(ECA). *International Journal of Applied Chemistry*. 2016;12(4):699-711.
15. Ravichandran C, Benzil D, Ramachandraiah C, Chandrasekha KB. Extraction and spectrophotometric determination of nickel in water, alloys and edible oil samples. *Tayin aralıkları ( $\mu\text{g mL}^{-1}$ ) Yöntemlerin dikkat çekici noktaları Kaynak*. 2015 4.11, 4468:4472.

# The Effectiveness of 7 Counselor Contacts in Health Facility at the First Level to Increase Exclusive Breastfeeding Coverage in Tangerang

Marthia Ikhlasiah<sup>1</sup>, Atnesia Ajeng<sup>1</sup>, Ika Oktaviani<sup>1</sup>

<sup>1</sup>Lecturers of University of Muhamadiyah Tangerang, Banten, Indonesia

## Abstract

Breast milk is really beneficial for baby's nerves and brain system development so it can be optimal and it can decrease infection risk. This is not directly proportional with exclusive breastfeeding coverage score in Indonesia, which reached 42% and it is still below of WHO standard one of factors which affects the success of giving breast milk was an availability of counselor in Health Service Facility. The objective of the research is to know how deep the beneficial of breastfeeding counseling through 7 counselor contacts based on WHO standard onto mothers and family, especially in increasing breastfeeding coverage score. The research methodology used was quasi experiment. The subject of the research was pregnant women up to the phase of breastfeeding in Health Facility at the First Level in Tangerang. The used sampling technique was purposive sampling. The amount of sample was 30 mothers. The statistical analysis used was t-test paired test. The result shows that all of the samples who got treatment of having 7 counselor contacts reached 100% of breastfeeding until it last to the end. Meanwhile, t test result of counselor contacts with baby's weight was having average differences of newly born baby's weight and in the day 1-3, it was proved with significance score 0,000. The average score of baby's weight who were newly born got 3, 16 kg and in the day of 1-3, got 3, 08kg, means decreased. However, for the t-test paired test, the baby's weight in the day of 1-3, day of 7, day of 14 and day of 40, had average differences with significance score 0,000. The average score of baby's weight in the day of 1-3, in the day of 7, in the day of 14, and in the day of 40 got increased. It can be concluded that the implementation of 7 counselor contacts of breastfeeding based on WHO standard was effective to increase exclusive breastfeeding coverage score and increase baby's weight in Health Facility at the First Level. This research is supposed to be implemented in all of Health Facilities at the First Level, so the score of exclusive breastfeeding coverage increased.

**Keywords:** *Counselor, Breastfeeding, Breast milk, Exclusive.*

## Introduction

The amount of baby's death in Indonesia based on Survey of SDKI shows 23 deaths per live birth. The degree of society's health from the death amount was really far from the SDGS target, that was 12 per 1000 live birth. One of the efforts that can be done to decrease infant mortality rate is giving breastfeeding.<sup>1</sup>

According to the report of Provincial Health Office, coverage distribution of exclusive breastfeeding for baby aged 0-6 months was 54.3%, meanwhile, the percentage in Banten province was still 47.9% below, means it is far from WHO standard (80%). The result of systematic view about the breastfeeding impact in short term and in long term, shows that it can decrease risk of diarrhea, chest infection, asthma, dermatitis atopic, obesity, leukemia, baby sudden death syndrome<sup>2</sup>

---

### Corresponding Author:

**Marthia Ikhlasiah**

Lecturers of University of Muhamadiyah Tangerang,  
Banten, Indonesia

e-mail: marthiaik@gmail.com

Breastfeeding is a precious gift from a mother given to her baby where it refers to process of giving breast milk to baby or to a child from mother's breast. The baby uses reflex of suction to get and to swallow breast

milk. The breastfeeding process has prolactin reflex and letdown reflex<sup>3</sup>. Breast milk has many fruitful things such as through 16 times of breastfeeding given to baby, tends to be rare of being hospitalized, and it has many specific nutrients which enroll in brain development such as dokosaheksaenoat and arachidonic acid for brain and retina development and choline to increase memory<sup>4</sup>.

Some factors that annoyed breastfeeding succeed is the lack of mother’s knowledge about breast milk advantageous, the lack of physic and mental of mother’s preparation, the lack of family support and environment, the lack of health service facility<sup>3</sup>. Therefore, a mother must seek information, so she can do breastfeeding in optimal way. For the mother who wants to succeed of breastfeeding, must dig information from trusted source. Once she gets the information, then she must seek the truth of the information through books or medical staff, such as doctor, midwife, and breast milk counselor<sup>5</sup>

Lactation counselor is (either medic or non-medic background) someone who has followed lactation counselor training based on WHO-40 hours module. Counseling aspect which becomes main activity from a lactation counselor consists of 2 components: listening and accepting opinion or mother’s point of view without judging; and help them to decide the best choice based on relevant information and also suggestions that have been given by a lactation Counselor<sup>5</sup>

The lactation Counselor practices all of the skills and the competences that is supposed to have, especially the skill of communication ability as what has been explained above. The lactation counselor and breastfeeding mother and also family work together to discuss and decide the best thing that will be done by the mother that suits with relevant information and also suggestions that have been given by the lactation counselor regards to the condition of that breastfeeding mother.

The research that is conducted by the researcher that entitles “ The implementation of breast milk counseling for the pregnant mothers shows the result that they tend to be more patient and more confident to feed breast milk for their baby within the early 3 days of babies born. In the previous research, there is no treatment done through 7 standard counselor contacts of WHO-based and the research time does not answer the succeed of feeding breast milk exclusively within at least 40 days after having the last counselor contact.

Therefore, it needs to do a continuous research through 7 counselor contacts based on WHO standard

which is started from 28 weeks of pregnancy age until 40 days of babies’ born age. The research is urgent to do since it is very important of giving breastfeeding counseling in order to increase the coverage rate of exclusive breastfeeding

### Materials and Method

This experimental quasi research aims at describing the cause effect relation to see the effectiveness of breastfeeding counseling through 7 counselor contacts based on WHO standard. The subject of this research were the coverage rate of exclusive breastfeeding. The object of the research was breastfeeding counseling through 7 counselor contacts. The population in the research was the pregnant mothers. The sample taken in this research used purposive sampling, whose respondents were taken based on specific purpose. This research took 30 sample of mothers.

The quantitative data collection for the breastfeeding counseling consist of: a.) The implementation of 7 counselor contacts for 28 weeks of pregnant mothers, 36 weeks of pregnant mothers, when the baby was newly born, 1-3 days of baby’s newly born, parturition within seven days, parturition within fourteen days, parturition within forty days) b.)The observation of exclusive breastfeeding: Made checklist list of the succeed of exclusive breastfeeding mothers. C)the growth of baby’s weight: it was done through weigh babys’weight within the contact given in parturition of BBI (contact 3 (IMD)), BB2 (Contact 4 (1-3 days period of hospitalized). BB3 (contact 5 (parturition of day 7) BB4 (contact 6 (parturition of day 14)BB5 (contact 7 (parturition of day 40). The data analysis used was T test require data coming from normal distribution and homogeny. T test used was Paired T-test.

### Results

#### a. The descriptive result of Counsellor contact

**Table 1 Counsellor contact with breast milk**

7 Counsellor Contact	n	Breast Milk
Meeting I (28 weeks of pregnancy)	30	-
Meeting II (36 weeks of pregnancy)	30	-
Meeting III Newly born baby (IMD)	30	100%
Meeting IV 1-3 days of newly born baby	30	100%
Meeting V Parturition within 7 days	30	100%
Meeting VI Parturition within 14 days	30	100%
Meeting VII Parturition within 40days	30	100%

**b. The descriptive result of Counselor contact with baby’s weight**

**Table 2 Contact with baby’s weight**

	<b>n</b>	<b>Minimum</b>	<b>Maximum</b>	<b>Mean</b>
BB1 {Third contact (IMD)}	30	2.80	3.60	3.1567
BB2 {Fourth contact (1-3 days of being hospitalized)}	30	2.70	3.50	3.0767
BB3 {Fifth contact (Parturition within 7 days)}	30	2.80	3.60	3.1800
BB4 {Sixth contact (Parturition within 14 days)}	30	3.00	3.80	3.3700
BB5 {Seventh contact (Parturition within 40 days)}	30	3.20	4.00	3.5633
Valid N (list wise)	30			

1. The average score of baby’s weight in the third contact was 3.16 kg and in the fourth contact, the baby’s weight was 3.08. It means decreased
  2. The average score of baby’s weight in the fourth contact was 3.08 kg and in the seventh contact, the baby’s weight was 3.18. It means increased
  3. The average score of baby’s weight in the seventh contact was 3.18 kg and in the fourteenth contact, the baby’s weight was 3.37. It means increased
  4. The average score of baby’s weight in the fourteenth contact was 3.37 kg and in the fourth contact, the baby’s weight was 3.56. It means increased
- c. The Normality test of Counselor contact with baby’s weight

**Table 3 Normality Test**

<b>Statistic</b>	<b>Df</b>	<b>Sig.</b>
BB1 {The third contact (IMD)}	30	.200*
BB2 {The fourth contact (1-3 days of baby’s born being hospitalized)}	30	.194
<b>Levene Statistic</b>	<b>Sig.</b>	
BB1-BB2	Based on Mean	.845
	Based on Median	.850
	Based on Median and with adjusted df	.850
	Based on trimmed mean	.842
BB2-BB3	Based on Mean	.798
	Based on Median	.765
	Based on Median and with adjusted df	.765
	Based on trimmed mean	.800
BB3-BB4	Based on Mean	.316
	Based on Median	.348
	Based on Median and with adjusted df	.348
	Based on trimmed mean	.316
BB4-BB5	Based on Mean	.937
	Based on Median	.844
	Based on Median and with adjusted df	.844
	Based on trimmed mean	.927
BB3 {The fifth contact (Parturition within seven days)}	30	.170
BB4 {The sixth contact (Parturition within 14 days)}	30	.151
BB5 {The seventh contact 7 (Parturition within 40 days)}	30	.051

In the normality test, the data will be normally distributed if the significance score was higher than 0.05. The normality test result shows that significance score was higher than 0.05. It means it can be assumed that it fulfils to do parametric test.

**d. The homogeneity test of counselor contact with baby’s weight**

**Homogeneity Test:** The homogeneity test, if the significance score from levene statisticis higher than

0.05. Homogeneity test is to do to know whether the data coming from the same population or not. The above result shows the all of data groups have the significance score higher than 0.05. It can be said that it is homogeny. Therefore, the assumption of homogeneity was fulfilled, then parametric test can be tested. The used parametric test was paired t test.

**e. Paired TTest**

**Table 4. Paired Samples Test**

	<b>T</b>	<b>Df</b>	<b>Sig. (2-tailed)</b>
Pair 1 BB1 {The third contact (IMD)} – BB2 {The fourth contact (1-3 days of babies born being hospitalized)}	5.442	29	.000
Pair 2 BB2 {The fourth contact (1-3 days of babies born being hospitalized)} – BB3 {The fifth contact (Parturition within seven days)}	-13.676	29	.000
Pair 3 BB3 The fifth contact (Parturition within seven days) – BB4{The sixth contact (Parturition within 14 days)}	-7.577	29	.000
Pair 4 BB4 {The sixth contact (Parturition within 14 days)} – BB5{The seventh contact (Parturition within 40 days)}	-29.000	29	.000

1. There is significance average differences of baby’s weight in scale of day if the significance score was lower than 0.05
2. There is significance average differences of baby’s weight in day 3 and day 4 which is proved with the significance score 0.000 (sig<0.005)
3. There is significance average differences of baby’s weight in day 4 and 7 which is proved with the significance score 0.000 (sig<0.005)
4. There is significance average differences of baby’s weight in day 7 and 14 which is proved with the significance score 0.000 (sig<0.005)
5. There is significance average differences of baby’s weight in day 14 and day 40 which is proved with the significance score 0.000 (sig<0.005)

**Discussion**

From the data collection shows that the 7 counselor contacts have been executed with 100% coverage and the baby’s weight was 100% normal > 2500gram. The baby’s weight average after being born, mean was 3.100

gram, it is upper from the normal line of the lowest data 2.800 gram and the higher data when baby just being born was 3.600 gr, then the baby’s weight increased from each step of counselor activity. The breast milk was given simultaneously and continuously. However, there was a decrease of baby’s’ weight average score in the third contact, that was 3.16 kg and in the fourth contact 3.08. This decrease was about 2.5%. This happened was not merely caused the lack nutrition of breast milk, but it happened because of the theoretically stated it was normal weight decrease. For the newly born baby, the normal decrease of weight was estimated 5-7%, then it must be a weight gain at least reach 20 gram per day. The content of breast milk has protective factor and proper nutrientthat guarantee the nutrition status of baby and also illness and death of babies were decreased. Some epidemiology research result that breast milk can protect baby from infection illness. The early introduction about foods that are low in nutrients and energy served in unhygienic can decrease children’s nutrition and can have low body endurance<sup>6</sup>.

The research about nutrition counseling and intensive lactation and husband’s support about exclusive

breastfeeding until the baby's age reach 1 month conducted by Ramlan<sup>7</sup> Shows that there is significant difference between control group and experiment group with  $p=0.000$

The same research was done by Febriani<sup>8</sup> explained that all of respondents, 66 persons and from 35 respondents who did 7 breast milk counselor contacts in UPTD Puskesmas Lingkar Barat Bengkulu were 27 persons succeed giving exclusive breastfeeding (77, 1%), the succeed of breastfeeding with  $p$  value chi square test  $p=0,000 (<0.05)$ . In American Journal of Health Promotion 2013 "The Effectiveness of multilevel promotion of exclusive breastfeeding in rural Indonesia" explained that structured health promotion can increase breastfeeding. BMC journal entitles "Developing a workplace lactation promotion model in Indonesia using Delphi Technique" explained that a wisdom of a company which provides breastfeeding counselor can increase human resource. By the existence of counselor, an employee can work properly if need of the baby's breast milk is fulfilled.

The research conducted by Mulyani<sup>9</sup> explained that by giving counseling of breastfeeding, it can increase the attitude of post-partum mother's breastfeeding effectively after being given the counseling in the period of prenatal, intranatal, and postnatal. The research about breastfeeding counseling toward baby's weight was also conducted by Ni Putu<sup>10</sup>. The result shows that the counseling can increase mother's knowledge about breastfeeding, so it affects mother's awareness to give exclusive breast milk and it also affects baby's weight gain. Therefore, from the result of the research, it can be said that 7 counselor contacts have run effectively, so Health facility in the First Level and Health Staff actually hold strategic role to increase coverage of exclusive breastfeeding until the baby's age reach 6 months<sup>11-14</sup>.

### Conclusion

It can be concluded that the implementation of seven counselor contacts based on WHO standard in Health facility at the First Level, affect baby's weight gain. It also increase score of coverage of exclusive breastfeeding by seeing baby's weight gain. The implementation of this research hopefully for all of Health Facilities at the First Level use 7 counselor contacts, so score of coverage of exclusive breastfeeding increased based on WHO standard.

**Acknowledgement:** We express gratitude feeling to RistekBRIN for the grant funds given to this research. We also thank to Az Zahra Clinic for permission given to do this research there. Moreover, we thank to many people who have helped the research until it last to the article written.

**Ethical Clearance:** Taken from the university ethical committee

**Conflict of Interest:** Nil

### References

1. Info Datin, Pusat Data dan Informasi Kementerian Kesehatan RI. Situasi dan Analisis ASI Eksklusif, <http://www.depkes.go.id/folder/view/01/structure-publikasi-pusdatin-info-datin.html>. 2014.
2. Maria Polard. ASI Asuhan Berbasis Bukti. Jakarta: EGC. 2017.
3. Maryunanai, Anik, Inisiasi Menyusu Dini, ASI Eksklusif, dan Manajemen Laktasi. Jakarta: Trans Info Media. 2015,
4. Roesli, Utami, Panduan Inisiasi Menyusu Dini plus ASI eksklusif. Jakarta: Pustaka Bunda. 2012.
5. Adiningrum, H. 2014. Buku Pintar ASI Eksklusif. Jakarta: Salsabila Pustaka Al Kaustsar Group.
6. Riskesdas., Lembaga Penerbitan Balitbangkes Kementerian Republik Indonesia. 2010.
7. Ramlandkk Pengaruh Konseling Gizi dan Laktasi Intensif dan Dukungan Asuhan Laktasi Terhadap Pemberian Air Susu Ibu (ASI) Eksklusif sampai umur 1 Bulan, *Jurnal Gizi Indonesia*, 2012; Vol. 3, No.2, hal 101-107
8. Febriani A, Kamsiah, Marleni W. Pelaksanaan 7 kontak ASI pada keberhasilan menyusui. *Jurnal Media Kesehatan*, 2018.; Volume 11 Nomor 1 Juni 2018.
9. Mulyani Sri, Pengaruh Konseling Menyusui terhadap sikap menyusui ibu post partum yang dirawat. *JMJ*. Volume 4 nomor 1 Mei 2016. hal 28-36.
10. Ni Putu, Pengaruh Konseling Pemberian ASI Eksklusif Terhadap Peningkatan Berat Badan Bayi di Puskesmas Karang Pule Tahun 2017, *Jurnal Kedokteran* 2018; YARSI 26 (1) : 034-044
11. Ariyanti Saleh, Veni Hadju., Baby Nutritional Status Improvement Through Mother Empowerment in Baby Care in South Sulawesi Indonesia, *Pakistan Journal Nutrition*. 2017.

12. Mallongi, A., Stang, Syamsuar, Natsir, M.F., Astuti, R.D.P., Rauf, A.U., Rachmat, M., Muhith, A., Potential ecological risks of mercury contamination along communities area in tonasa cement industry Pangkep, Indonesia, *Enfermeria clinica.*, Volume 30, 1 June 2020, Pages 119-122
13. Masriadi, Azis, R., Sumantri, E., Mallongi, A., Effectiveness of non pharmacologic therapy through surveillance approach to blood pressure degradation in primary hypertension patients, Indonesia., *Indian Journal of Public Health Research and Development.* Volume 9, Issue 4, April 2018, Pages 249-255
14. Muhith A, Winarti E, Perdana SSI, Haryuni S, Rahayu KIN, Mallongi A. Internal Locus of Control as a Driving Factor of Early Detection Behavior of Cervical Cancer by Inspection Visual of Acetic Acid Method. *Open Access Maced J Med Sci.* 2020 Apr 20; 8(E):113-116. <https://doi.org/10.3889/oamjms.2020.4341>.

# Survey of Registered Nurses Working in the Metropolitan Hospitals on Bullying Experiences at Workplace in South Korea

Kwang Ok Lee

*Associate Professor, Department of Nursing, Sangmyung University, South Korea*

## Abstract

This study aimed to identify the bullying experiences and coping patterns experienced by clinical nurses. A total of 215 nurses who had worked at 10 hospitals in Seoul from 3 September 2019 to 20 October participated, but two of them had missing data. Ultimately, 213 subjects were included. The collected data were analyzed using the SPSS/WIN20.O program which were analyzed using the mean and standard deviation. Subjects who experienced bullying accounted for 110 out of 213 (51.6%) in which 66.3% were experienced nurses and 21.8% were new nurses. To talk to a colleague was 57.3%, to work with a feeling of hurt but remain calm was 56.4%, to forget by thinking about something else or doing something was 50%. The study on the coping response after bullying has not been revealed in previous Korean reports, and it is expected to be a useful information for preventing workplace bullying in the future and establishing an immediate and active coping system.

**Keywords:** *Registered Nurses, Metropolitan hospital, bullying experience.*

## Introduction

Persistent bullying in the workplace can have a serious impact on physical, psychological, and social health conditions. Anxiety, depression and stress, insomnia, weight loss, low self-esteem, and psychological atrophy are the most severe reactions. Traumatic stress disorder may also occur<sup>1</sup>.

Persistent bullying in the workplace can have a serious impact on physical, psychological, and social health conditions.

Anxiety, depression and stress, insomnia, weight loss, low self-esteem, and psychological atrophy are the most severe reactions. Traumatic stress disorder may also occur<sup>1</sup>.

Workplace bullying can also lead to burnout, leading to decision-making<sup>2</sup>. Workplace bullying not only causes physical and mental damage to individuals; it also leads to business mistakes, reduced productivity, and turnover in the organization.

The bullying of nurses in Korea has been studied, but the study on how to cope with the situation of bullying has been seldom conducted. In addition, bullying among new nurses has been largely reported, but no bullying experiences in career nurses have been studied. Therefore, this study examined the bullying experiences of career nurses as well as the new nurses. It also confirmed the violence status as a basic information for generalizing the occupational violence reporting system and prepared guidelines for creating a safe working environment. Hence, these steps are immensely necessary.

**Purpose of Research:** This study aimed to investigate the bullying status, post-bullying reactions, and coping patterns experienced by clinical nurses.

First, we investigated the bullying experiences experienced by nurses. Second, we examined the

---

### Corresponding Author:

**Kwang Ok Lee**

Associate Professor, Department of Nursing,  
SangMyung University, South Korea  
e-mail: kolee@smu.ac.kr



differences in bullying experienced by nurses. Third, we investigated the coping behavior according to the bullying situation experienced by the nurses.

**Method**

**Design and Sample:** This study used the descriptive research method to determine the status of bullying experienced by nurses and the reaction and coping patterns they demonstrated after being bullied.

**Data Collection:** This study was approved by the Institutional Review Board of Institutional Review Board (IRB C-2019-003). The research coordinator contacted the staff in each hospital to explain the purpose and procedure of the study and then sent a website address and a questionnaire. The nurses could freely choose on whether to answer in a questionnaire or through the website, and then the data were collected. A total of 215 nurses who had worked at 10 hospitals in Seoul from 3 September 2019 to 20 October participated, but two of them had missing data. Ultimately, 213 subjects were included

**Instrument:**

**Negative Acts Questionnaire-Revised (NAQ-R):** The NAQ-R tool was developed by Einarsen and Raknes<sup>3</sup>, but it was translated by Nam et al. The self-report questionnaire consists of 22 questions. It is divided

into three sub-domains, namely, personal harassment, physical threat, and work harassment. A high score of 22 to 110 indicates that more negative behavior was experienced.

**Coping with Bullying:** This instrument, which consists of 13 questions, was created by modifying and supplementing the coping measures for violence presented by Kim and Kwon [18]. The questions can be answered with either yes or no.

**Data Analysis:** The collected data were analyzed using the SPSS/WIN20.O program. The subjects' general characteristics, job-related characteristics, post-violent coping behavior, and failure to report were analyzed using the mean and standard deviation.

**Results**

**General Characteristics of Subjects:** The 213 subjects were composed of 5.2% male and 94.8% female. The age of patients ranged between 25 and 53 years, with a mean of 29.7±7.22 years. The average work experience of nurses was 5.58±7.26 years in which 26.3%, 64.8%, and 7.5% were new nurses (worked for less than a year), experienced nurses, and other nurses, respectively. The medical wards were followed by internal medical wards (25.4%), surgical wards (17.8%), intensive care unit (17.4%), and outpatient (13.6%) (Table 1).

**Table 1. Participant Demographic Characteristics (N=213)**

Characteristics	Categories	N(%)	M±SD
Gender	Male	11(5.2)	
	Female	202(94.8)	
Age (yr)	25-29	152(71.4)	29.7±7.22
	30-34	27(12.7)	
	35-39	9(4.2)	
	40-53	25(11.7)	
Working experience (yr)	<2	79(37.1)	5.58±7.26
	2 - 4	56(26.3)	
	4 - 6	30(14.1)	
	>6	48(22.5)	
Current position	New Graduate Nurse	56(26.3)	
	Registered Nurse	138(64.8)	
	Unit Manager	16(7.5)	
	Clinical Nurse Educator	3(1.4)	

Characteristics	Categories	N(%)	M±SD
Working area	Medical Ward	54(25.4)	
	Surgical Ward	38(17.8)	
	Intensive Care Unit	37(17.4)	
	Out Patient Department	29(13.6)	
	Emergency Room	19(8.9)	
	Other	36(16.9)	

**Bullying Experience Related to Characteristics:** Subjects who experienced bullying accounted for 110 out of 213 (51.6%) in which 66.3% were experienced nurses and 21.8% were new nurses. Furthermore, 50% of

the respondents took immediate action after the bullying experience, and 51.8% thought of leaving the job after the bullying experience (Table 2).

**Table 2. Bullying experience related to characteristics (N=110)**

Characteristics	Bullying	n(%)	X <sup>2</sup> (p)
Current position	New graduate RN	24(21.8)	3.96 (.265)
	Registered Nurse	73(66.3)	
	Unit manager	11(0.1)	
	Clinical nurse educator	2(1.8)	
Action after report bullying	Immediately action	55(50.0)	
	No action	55(50.0)	
Turnover intention related bullying	Yes	57(51.8%)	
	No	53(48.2%)	

**Ways of Coping:** To talk to a colleague was 57.3%, to work with a feeling of hurt but remain calm was 56.4%, to forget by thinking about something else or doing something was 50%, to talk to friends or family was 46.4%, to avoid eye contact was 41.8%, and to remain inactive (attractive) was 40.9% (Table 3).

**Table 3. Ways of Coping (N=110)**

Variables	n(%)
Report to Administrator	16(14.5)
Talking to friends or family	51(46.4)
Talk to a colleague	63(57.3)
Creates an incident log	8(7.3)
Rport to the police	3(2.7)
Inactive (attractive)	45(40.9)
To forget while thinking about something else or doing something	55(50)
Consultant found	6(5.5)
Indirect expression of displeasure	23(20.9)

Variables	n(%)
Ask someone close to you for help	21(19.1)
Avoid eye contact	46(41.8)
Trying to understand the other person	34(30.9)
To work with a feeling of hurt, but calm down	62(56.4)
Drinking alcohol	34(30.9)
I don't know what to do. I don't know what to do.	30(27.3)

### Discussion

In addition, violence was reported in 75% of Australian nurses<sup>5</sup> and 33% of Canadian nurses<sup>6</sup>. Nurses have been experiencing bullying at various sites, such as emergency rooms<sup>7</sup>, psychiatric wards<sup>8</sup>, and communities<sup>9</sup>.

This study found that coping with bullying involved talking to colleagues most frequently. This result is similar to that of Kang Hee Sun<sup>9</sup>. Therefore, the training should include guidance on how to cope with co-worker bullying.

In previous studies<sup>10</sup>, older nurses experienced more workplace harassment, but in the current study, 26.3% of new nurses and 64.8% of experienced nurses experienced more workplace harassment. According to the nurse's career, the shorter the experience of working as a nurse, the more frequent the bully experiences<sup>11</sup>. Meanwhile, the findings were similar to studies reported by nurses in medical wards experiencing more workplace harassment<sup>10,11</sup>.

In recent years, an incident has been reported that nurses' workplace bullying has resulted in death; thus, the Ministry of Health and Welfare urgently needs to discuss on the strong implementation of education and preventive measures against bullying. In addition, in the event of bullying, a systematic incident reporting system should be in place and encouraged to respond proactively.

In Korea, various activities, such as 100-day ceremonies and one-year ceremonies to adapt to new nurses, are implemented; however, support programs for career nurses are not well run. Therefore, running support programs for them is necessary.

In addition, considering that nurses who experience workplace bullying may later become perpetrators<sup>12</sup>, preventative interventions and policies according to the ladder system of new nurses and experienced nurses are necessary to be established. The main influencing factors of workplace bullying are organizational factors instead of individual ones<sup>11</sup>. Moreover, the development and training of such preventive programs, the encouragement of reporting systems after bullying, instruction and guideline education, and immediate and active response programs should be actively and continuously operated.

### Conclusion

Not only new nurses but also experienced nurses and unit managers were exposed to workplace bullying. Recently, nurses who died from workplace bullying encountered industrial accidents and were aware of the guidelines for preventing bullying. However, they did not have specific training for harassment prevention, reporting system, and guidelines. Preventive education and immediate action in case of bullying should be strengthened starting from the nursing college days. Furthermore, the safety guidelines should be reinforced through education and include the contents of annual nurse remuneration education to support legal and institutional safe working conditions.

The study on the coping response after bullying has not been revealed in previous Korean reports, and it is expected to be a useful information for preventing workplace bullying in the future and establishing an immediate and active coping system.

**Conflict of Interest:** Nil

**Ethical Clearance:** Done

**Source of Funding:** Self

### References

1. Spence, Laschinger, H.K., & Nosko, A. Exposure to workplace bullying and post-traumatic stress disorder symptomology: The role of protective psychological resources. *Journal of Nursing Management*. 2015;23(2):252-262.
2. Kang, J.Y., & Yun, S.Y. A Grounded Theory Approach on Nurses' Experience with Workplace Bullying. *Journal of Korean Academy of Nursing*. 2016;46(2): 226-237.
3. Ko, J., & Kang, K.A. Relations between perceiving a calling and job satisfaction in probation officers: Testing a mediated effect of work meaning and career commitment. *Korean Journal of Occupational Health Nursing*. 2015;24(3):194-203.
4. Kim, K.S., Cha, J.E., & Kim, Y.I. Effects of Workplace Bullying, Health Promotion Lifestyle, and Physical Symptoms on Occupational Stress of New Nurses in General Hospitals. *Korean Journal of Occupational Health Nursing*. 2019;28(1):12-20.
5. Chapman, R., Styles, L., Perry, L., & Combs, S. Examining the characteristics of workplace violence in one non-tertiary hospital. *Journal of Clinical Nursing*. 2010;19(3-4):479-488.
6. Cho, E.K., Kim, M.J. The Influence of Human Rights Sensitivity and the Nursing Work Environment on Workplace Bullying Victimization among Nurses in Small and Medium sized Hospitals. *The Korean Journal of Health Service Management*. 2019; 13(3):27-38.
7. Gacki-Smith, J., Juarez, A.M., Boyett, L., Homeyer, C., Robinson, L., & MacLean, S.L. Violence against nurses working in US emergency department. *Journal of Healthcare Protection Management*. 2010;26(1):81-99.
8. Rodriguez-Acosta, R.L., Myers, D.J., Richardson, D.B., Lipscomb, H.J., Chen, J.C., & Demet, J.M.

- Physical assault among nursing staff employed in acute care. *Work*. 2010;35(2):191-200.
9. Lee, Y.S., Lee, K.O., Kang, H.S., & Park, Y.H. Violent Experiences and Coping among Home Visiting Health Care Workers in Korea. *Journal of Korean academy Nursing*. 2012;42(1):66-75.
  10. Lee, Y.O., Kang, J.Y., Yun, S.Y., Lee, Y.H., Kim, B.J. A methodological triangulation study on the experience of horizontal violence in intensive care unit nurses. *Journal of Korean Critical Care Nursing*. 2013;6(2): 37-50.
  11. Kang, J.Y., & Lee, M.J. The Related Factors to Workplace Bullying in Nursing: A systematic review and Meta-analysis. *Korean Journal of Adult Nursing*. 2016; 28(4):399-414.
  12. Woelfle, C.Y., McCaffrey, R. Nurses on nurse. *Nursing Forum*. 2007;42(3):123-31.

# Right to Life of a Child in India: An Overview

Arunima Mishra<sup>1</sup>, Smita Satapathy<sup>2</sup>

<sup>1</sup>Assistant Professor, Faculty of Legal Studies, Siksha 'O' Anusandhan, Bhubaneswar, Odisha, India,

<sup>2</sup>Ph.D. Research Scholar, Faculty of Legal Studies, Siksha 'O' Anusandhan, Bhubaneswar, Odisha, India

## Abstract

It would not be an exaggeration of words if it is said that children are the future of a nation. They are the representatives of the older generation in the upcoming world. They are filled with innocence and their innocence should be nurtured so as to make it persistent and to make the society free of corruption. Their level of curiosity is very high and if it is preserved and explored then every child may become a research-oriented scientist, doctor, engineer or likewise. The most prominent international instrument through which the child right has got recognition is the Convention on Rights of Child, 1989. India being a signatory to it is complying with the standards laid down in it.

**Keywords:** Child right; right to life, identity and education; convention; Pre-natal injuries.

## Introduction-

*“There is no trust more sacred than the one the world holds with children. There is no duty more important than ensuring that their rights are respected, that their welfare is protected, that their lives are free from fear and want and that they can grow up in peace.”*  
–Kofi Annan

Children are the backbone of a country. If they are not brought up properly, the nation will have to pay for it. It is quite evident from the world history that as *Adolf Hitler*(1889-1945), in his childhood had grown hatred feelings against the Jews because he could not enter drawing school due to them. Those days the top places were only occupied by the Jews. With his growing age, the hatred feeling has also grown up. Millions of children have no access to education, proper sanitation, immunization, food and health care; instead they have to work for long hours under hazardous conditions and are forced to serve as soldiers in armed conflicts across the globe. And it is very devastating to admit that in many cases, they are abused by the very individuals responsible

for their care.<sup>1</sup> Abusing the rights of the children is a much aggravated form of activity in comparison to that against adult people. Spoiling the childhood will lead towards generating anti-social elements and consequently it will spoil the society at large.

## Objective:

The purpose of research on this topic is-

1. To know the correlation between the right to life under Article 21 of the Indian Constitution and provisions under the Convention on Rights of Child.
2. To understand children's right to life in India.
3. To know how the judiciary is tackling these types of cases relating to various child rights.

**Various Rights of Children:** There is no doubt that children are entitled to all the facets of human rights, but as they are unable to take care of themselves, are representing a very vulnerable and sensitive group they are entitled to some additional rights. According to United Nations Convention on the Rights of the Children (adopted by the United Nations General Assembly on 20<sup>th</sup> November, 1989 and came into force on 2<sup>nd</sup> September, 1990) which has been ratified by India in 1992 (Till now 196 member countries have ratified to it except USA) – all children are born with fundamental rights. If right to life of a child is considered then it is having three important facets, namely-

---

## Corresponding Author:

**Smita Satapathy**

Ph.D. Research Scholar, Faculty of Legal Studies,  
Siksha 'O' Anusandhan, Bhubaneswar, Odisha, India  
e-mail: smitasatapathy@soa.ac.in

- Right to existence which definitely includes right to born alive,
- Right to identity which in turn ensures the liability of the state to take care of the child and its rights, and
- Right to education which enables the child to live a life like a social being with due dignity.

**Juvenile Delinquency as a By-Product of Violation of Child Rights:** If anyone has a look to the factors contributing to juvenile offences- they are poor school attendance, poor educational standard, violence at homes, violence in the social circle, bad peer group and their pressure, socioeconomic causes, lack of moral guidance, lack of basic amenities, adolescent instabilities and impulses, early sexual experiences, mental conflicts, child marriages and media and artificial intelligence etc. among the aforesaid factors except few psychological factors every other factor has a direct connectivity with the serious violation of child right. However it can also be said that most of the psychological factors are the outcome of violation of child rights at a very early childhood.

**Important Provisions of Convention on Rights of Child:** The history of children's rights dates from the 19th century. In ancient times and up to the middle Ages, though it is very devastating to admit still in some parts of the world parents even had the power of life or death over their children. For the first time in Europe, laws were passed governing child labour.<sup>2</sup> In 1919, the League of Nations created a committee for the protection of children. Five years later, it adopted the Geneva Declaration, first international treaty on children's rights, then after the Second World War there was rapid growth in the concern regarding child rights. In 1948 the Universal Declaration on Human Rights stipulated that the motherhood and childhood are entitled to special care and assistance. Then finally on 20th November 1989 the Convention on the Rights of the Child (CRC) was unanimously adopted by the United Nations General Assembly. In 2000 the Convention got more strength due to adoption of the two optional Protocols on the sale of children, child prostitution and child pornography, and child involvement in armed conflicts. In 2011 the third optional protocol was adopted introducing a mechanism by which children may submit complaints to the Committee on the Rights of the Child. 2014 is the year of 25th anniversary of the Convention and now it has been ratified by 193 member states of the United

Nations. Only the United States and Somalia, who have both signed the treaty, have not ratified it.

Article 1 of the 1989 Convention provides the definition of a child on the basis of age. According to the provision children below the age of 18 years are entitled to the rights enumerated under the Convention, but autonomy is also given to the member countries to formulate a definite and uniform age. But still India is having no uniform law regarding this. Article 2 provides for non-discriminatory treatment to the children. Protection of the child rights are provided under Article 4. Among other important provisions are parental guidance under Article 5, respect for the views of the child (Article 12), freedom of speech and expression (Article 13) and freedom of thought, conscience and religion (Article 14) and right to education including goals of education under Article 28 and Article 29 etc. As provided under Article 42 the member countries should take the appropriate steps to make the adults and children know about the rights of the children as provided. Articles 43 to 54 deal with the implementation mechanism.

**Implementation in India:** To start with every child has a right to be born alive and then to the basic amenities of life those are- food, clothes and shelter and of course including right to health care including immunization. The right to born alive abandons all forms of foeticide. A child needs to be taken care of in a proper manner while inside the mother's womb. The judiciary of some countries like California (*Scott vs. Mc Pheeters*, 33 Cal App), Louisiana (*Cooper vs. Blanck*, 39 so, 2d 352), Canada (*Montereal Tramways vs. Leveille* 4 (1933)) and Columbia (*Bonbrest vs. Kotz* 65F Supp 138 (1946)) are allowing actionable claims in case of pre-natal injuries though in *Walker vs. Great Northern Railway, Ireland* [(Q.B. Div) 69 (1891)] the same was denied against the defendant's Railway Company when a child was born deformed because of the railway accident of his mother. But Indian judiciary is far behind regarding these kinds of claims. India has no statute dealing with prenatal injuries unlike United Kingdom. Under the Congenital Disabilities (Civil Liabilities) Act, 1976 of England—

- (a) The action is allowed if the child is born alive, but deformed;
- (b) Damages for the loss of expectation of life of a victim child can be claimed if the child lives at least 48 hours after birth;

- (c) Civil liability towards the child can be however restricted or excluded by a contract made with the parents;
- (d) Contributory negligence of the parents can be pleaded as a defence;
- (e) It is permitted to bring an action for injury to the child even against the mother if the cause of action arises due to the negligent driving of the mother.

Indian Courts when faced with the question of liability of the mother to her child in the womb for injuries caused by negligence have the following options-

- (1) They hold the mother liable for negligence generally in all cases; or
- (2) There is denial to impose any liability for negligence in any case; or
- (3) Holding the mother liable for negligence only in motor accident cases

In the case of *Union Carbide Corporation vs. Union of India* (AIR 1992 SC 248) it was held by the Apex Court that if the congenital defect of a child is traceable to be caused by noxious gas leaked during the Bhopal Gas Leak Disaster then compensation would be allowed. This pronouncement by Apex court can only be served as a directive and is not exactly backed by any statute or it can be utilized authoritatively. However, legal liability can never be imposed upon a mother to take care of the foetus in utero. Judicial or legal definition of "reasonable standard of care" which a mother owes to her foetus would be very difficult to articulate as myriad of financial capacities, educational qualifications, access to health services and ethnic backgrounds of the women can be seen in the Indian society under which imposition of such liability is almost impossible.

However Sec. 140(2) of the Motor Vehicle Act, 1988 (Act No. 59 of 1988) provides for a compensation of Rs 25,000 to an accident victim who sustains permanent disability because of the accident. This liability is covered under the insurance policy against third party risk<sup>3</sup> subject to condition that a foetus must be covered under the definition of 3<sup>rd</sup> party. But actually who can be included within the term 3<sup>rd</sup> party is not comprehensively provided under the said Act. However the right to file a civil claim of tort is still preserved<sup>4</sup>. Indian Transfer of Property Act, 1882 recognises an unborn person in whose favour property can be transferred<sup>5</sup>.

Regarding nutrition and health Indian Government and various state governments have taken various policy measures. Many schemes like Mid-day meal Scheme, Sarva Sikhya Abhiyana Scheme, Integrated Programme for Street Children, Balika Samriddhi Yojana and so on. Right of the children to development includes right to education as well as right to leisure, recreation and care. However how to ensure the entitlement, extent and enjoyment of these rights is a big question. Article 8 of the CRC 1989 provides for Preservation of identity of a child. It enshrined that children have the right to an identity. Governments should respect children's right to a name, a nationality and family ties. Indian government has passed the Aadhaar (Targeted Delivery of Financial and other Subsidies, Benefits and Services) Act (No. 18 of 2016) was passed in 2016. The compliance of the Act by Aadhar registration of children is still in question due to various contradictory judgements of the Supreme Court. The only option left is birth registration in concerned municipalities under the Registration of Births and Deaths, Act 1969 (Act No. 18 of 1969). But till now each and every birth is not registered. Particularly the children taking birth in slums, brothels and of parents in begging or any kind of nomadic profession are not having their children's births registered.<sup>6</sup> As this is purely a duty of parents, uneducated and illiterate parents need to be trained continuously regarding registration process as well as the significance of it.

If the right to education and goal of education provided under A. 28 and A. 29 of the 1989 Convention are considered then India has taken two important statutory steps as follows-

- Insertion of Art 21A and Art 51A(k) to the Constitution in 86<sup>th</sup> Amendment to the Indian Constitution in 2002; and
- Passing of Right to Free and Compulsory Education, Act 2009 (Act No. 35 of 2009)

Article 21A gives the right to education the status of a fundamental right and art 51A(k) casts a duty upon the parents of the children within 6 to 14 year of age to send them to school. But the beneficiaries of art 21A are minors and they are unable to enforce the same and as it is known to everyone that it is very difficult to ensure the compliance with a fundamental duty. The Right to Education Act provides for the:

- Completion of elementary education (i.e. up to standard VIII) within 6 to 14 year of age;

- Standard student-teacher ratio, infrastructural facility, teachers' working hour including schools' working hours;
- Appointment of appropriately qualified and well trained teachers; and
- Prohibition of punishment or harassment in any form, strict admission procedure by screening, imposing high fees by private schools, employment of teachers for non-academic purposes like elections, relief, census etc, engagement of full-time teachers as private tutors, etc. Many more provisions are there to ensure the nourishment of the potentials of every child.

**Right to Education and the Reality:** Now three kinds of course curricula are running in India specifically in the elementary level. Those are ICSE (Indian Certificate of Secondary Education), CBSE (Central Board of Secondary Education) and education provided by local or state Board. In the ICSE course pattern the papers are many and the books are very huge in volume and very much information oriented. Automatically the examination needs to be memory-based and it evaluates only the memorisation aspect of a child.<sup>7</sup> No thought provoking questions are ever asked. The students need to learn everything by heart. So students are so extraordinarily burdened that no room is left for their creativity and decide what is moral and what is immoral and perhaps that's why students are competing like anything in getting a seat in a good college and a good job, but fraction of a second is taken for a government servant to be corrupted.<sup>8</sup>

The ground reality in Indian context is that now a day people belonging to the middle and lower middle class have become more conscious regarding the education of their children, but they have become so ambitious that their children have to pay for it.<sup>9</sup> The significance of education as understood by their children is that good education is meant to secure good marks, then consequently to get a good job and finally to get good salary.<sup>10</sup> In these cases more often it is seen that the children are unable to accept their failure and develop suicidal tendencies which shows a growing escapist attitude.<sup>11</sup>

**Findings:** In order to ensure that every child will enjoy the right to education parents also need to be conscious. The duties of the government are to-

- Attach the birth registration with the census by some

statutory or policy measures so that every birth can be registered and the child population can be assessed properly.

- There should be a uniform law regarding the age of the beneficiaries of child rights.
- To bring amendment in the Right to Education Act, 2009 to lessen the burden of the courses so that the child can enjoy the studies.
- The examination system is so modified by the policy measures that the proper evaluation of the child could be possible by,
  - o Finding the problem or the huddle for the child; and
  - o Finding the real potential of the child which can further be explored.
- Parents should not be imposing their wishes upon their children realising the fact that their children are separate individuals.

## Conclusion

The children are not the responsibility of the state only. The society, the parents and every relatives, kiths and kin, the quasi parents or teachers whoever are custodian of a child for howsoever small period it may be should think that they are a part and parcel of the process of child up-bringing. So a child is everyone's responsibility.

**Ethical Clearance:** Not required, as the article is entirely based on the doctrinal or non-empirical method of study taken.

**Source of Funding:** Self

**Conflict of Interest:** Nil

## References

1. Bhakhry Dr Savita. Children in India and their Rights [Internet]. New Delhi: NATIONAL HUMAN RIGHTS COMMISSION; 2006. 75 p. Available from: <http://nhrc.nic.in/sites/default/files/ChildrenRights.pdf>
2. Muse WT, Spinella NA. Right of Infant to Recover for Prenatal Injury. *Virginia Law Rev* [Internet]. 1950 Jun; 36(5):611-624. Available from: <https://www.jstor.org/stable/1069403> DOI: 10.2307/1069403



3. The Motor Vehicle Act, 1988. Bare Act. Universal Publication. 2016. 97-98.
4. The Motor Vehicle Act, 1988. Bare Act. Universal Publication. 2016. 95-96.
5. Sinha Dr R.K. The Transfer of Property Act. 14th Ed. Central law Agency. 2013. 95-99
6. Pandey Dr J.N. Constitutional Law of India. 42nd Ed. Central law Agency. 2005. 350
7. Midlock JA. Prenatal Injuries Caused by Negligence Prior to Conception: An Expansion of Tort Liability. Kent L Rev [Internet]. 1977;54: 568-595. Available from: <http://scholarship.kentlaw.iit.edu/cklawreview/vol54/iss2/13>
8. Child's Right of Action for Prenatal Injuries. Indiana L J [Internet]. 1949; 25(1): 91-95. Available from: <http://www.repository.law.indiana.edu/ilj/vol25/iss1/8>
9. Roy Chandan. Child rights & child development in India: a regional analysis. Ind Jour Reg S [Internet]. 2013;45:103-118. Available from: [https://www.researchgate.net/publication/267633481\\_Child\\_rights\\_child\\_development\\_in\\_India\\_a\\_regional\\_analysis](https://www.researchgate.net/publication/267633481_Child_rights_child_development_in_India_a_regional_analysis)
10. Deb S, Sun J, Gireesan A, Kumar A, Majumdar A. Child Rights As Perceived by the Community Members in India. Int L Res [Internet]. 2015. Available from: [https://www.researchgate.net/publication/288179252\\_Child\\_Rights\\_As\\_Perceived\\_by\\_the\\_Community\\_Members\\_in\\_India](https://www.researchgate.net/publication/288179252_Child_Rights_As_Perceived_by_the_Community_Members_in_India)
11. Sangwan A. Child Labour Policy and Empowerment: A Study. IRJMSH [Internet]. 2018; 9 (7): 150-159. Available from: [https://www.academia.edu/38130566/CHILD\\_LABOUR\\_POLICY\\_AND\\_EMPOWERMENT\\_A\\_STUDY](https://www.academia.edu/38130566/CHILD_LABOUR_POLICY_AND_EMPOWERMENT_A_STUDY)

# Influences of Mothers' Parenting Attitude, Parenting Efficacy, and Stress Levels on Children's Social Skills

Kwang Ok Lee<sup>1</sup>, Hyun Ju Chae<sup>2</sup>

<sup>1</sup>Associate Professor, Department of Nursing, Sangmyung University, South Korea,

<sup>2</sup>Associate Professor, Department of Nursing, Jungbu University, South Korea

## Abstract

This study aimed to identify the influences of mothers' parenting attitude, parenting efficacy, and stress levels on children's social skills. A total of 117 mothers rearing 4–7-year-old children were included in this study. Data were collected using a self-administered questionnaire from November 13 to 26, 2011. Collected data were analyzed using the IBM SPSS 20.0 program with descriptive statistics, t-test, one-way analysis of variance (scheffetestforpost-hoc), Pearson's correlation, and multiple regressions. Mothers' parenting attitude (permission) and efficacy were positively correlated, whereas mothers' stress level was negatively correlated with children's social skills. Children's social skills were influenced by mothers' parenting and marital stress levels and children's gender and birth order. In addition, mothers' occupational stress influences children's social skills. These results indicated that differences in gender and birth order should be considered in providing interventions for mothers' stress management.

**Keywords:** Parenting efficacy, parenting attitude, stress, children, social skill.

## Introduction

Individuals should interact with others and make social relationships when growing up<sup>1</sup>. Intimate relationships are the most important factors for a happy life, which require social skills to form and maintain<sup>1</sup>. The importance of social skills for successful lives has increased nowadays as compared to the past, which is expected to be greater as human relations become more complex and diverse<sup>1</sup>.

Social skills can be defined as socially acceptable learned behaviors for the successful completion of social task such as peer-group entry, having a conversation, making friends, and playing games with peers<sup>2</sup>. These skills are intrinsic to children's psychosocial well-being<sup>3</sup> and related to their positive behavioral, social,

and academic outcomes<sup>4</sup>. Young children's social skills are an important precursor in their development for school readiness and peer acceptance and considered as academic enablers because they facilitated academic achievement<sup>4</sup>.

Children grow up as socialized adults through learning and practicing social skills by considering, conferring, and cooperating with each other in various social relations<sup>1</sup>. Children with good social skills are more likely to participate in cooperative play, which enhances their social skills<sup>5</sup> and makes them adapt well socially, whereas those lacking social skills are more likely to play alone, which promotes insufficient opportunity to learn social skills<sup>5</sup>. These children are more likely to experience difficulty in resolving conflicts arising from various social relationships and show socially maladaptive behavioral problems<sup>5</sup>. These negative experiences can affect their overall development and last until adulthood<sup>1</sup>. Therefore, children's social skills should be increased by identifying the influencing factors.

Children's social skills are influenced by environmental and individual factors<sup>6</sup>. Environmental

---

### Corresponding Author:

Hyun Ju Chae

Associate Professor, Department of Nursing, Jungbu University, South Korea  
e-mail: hjchae@jbm.ac.kr

factors include parents or teachers, such as parenting attitude and behavior<sup>7</sup>, mother-child attachment, stress coping mechanism, and teacher-child interaction<sup>2</sup>. Individual factors include temperament, sex, and emotional intelligence<sup>8</sup>. Among these factors, parents are considered to closely influence the development of children's social skills, especially mothers' parenting<sup>6</sup>. Children begin to learn social skills through relationships with their mothers, which is the primary basis of children's social relationships<sup>9</sup>.

Therefore, the relationship between factors related to mothers' parenting and children's social skills should be identified. Previous studies reported that mothers' parenting attitude and stress levels were related to children's social skills<sup>6</sup>. However, children's social skills were evaluated by teachers in most studies and by parents in some studies<sup>1</sup>. Teachers are more likely to observe and evaluate children objectively; however, their observations are limited within educational institutions. Mothers may lack objectivity as compared to teachers; however, they have been able to provide diverse and accurate information about their children because of their intensive observation in various situations for a long time<sup>1</sup>. Therefore, mothers' evaluation should also be considered in order to understand children's social skills. In addition, mothers' stress level can also affect children's social skills because of its association with parenting behaviors. Mothers' parenting efficacy can also affect children's social skills for the same reason; however, studies on these issues are limited.

Therefore, this study aimed to investigate children's social skills evaluated by their mothers and to identify the effects of mothers' parenting attitude, parenting efficacy, and stress levels.

## Materials And Method

**Design and Participants:** This research survey was conducted to identify influences of mothers' parenting attitude, parenting efficacy, and stress levels on children's social skills.

Study participants consisted of 117 mothers rearing 4-7-year-old children recruited at daycare centers in Seoul, Jeonbuk, and Chungnam. Data were collected using a self-administered questionnaire from November 13 to 26, 2011.

**Research Tools:** Mothers' parenting attitude was measured using a modified Kim's parenting behavior

scale<sup>10</sup>. This scale consisted of 3 categories (permission, acceptance, and restriction), and each category consisted of 6 items. Each item was rated on a 4-point Likert scale (1-4), with higher score indicating higher permissive, acceptance, and restrictive behaviors. The internal consistency reliability was Cronbach's  $\alpha = .76-.90$  in Kim's study and  $.82-.90$  in this study.

Mothers' parenting efficacy was measured using a modified parenting efficacy scale developed by Choi and Chung<sup>11</sup>. This scale consisted of 20 items, and each item was rated on a 4-point Likert scale (1-4), with higher score indicating higher parenting efficacy. The internal consistency reliability was Cronbach's  $\alpha = .92$  in Choi and Chung's study and  $.91$  in this study.

Mothers' stress level was measured using a scale developed by researchers. This scale consisted of 3 categories (parenting, economic, and marital stress levels), and each category consisted of 4 items. Each item was rated on a 4-point Likert scale (1-4), with higher score indicating higher stress levels. The validity of this scale was verified by three nursing professors, and the internal consistency reliability was Cronbach's  $\alpha = .85-.91$ .

Children's social skills was measured using a modified Kim's scale<sup>12</sup>, translated from the Social Skill Rating developed by Gresham & Elliott. This scale consisted of 3 categories (assertiveness, self-control, and cooperation), and assertiveness consisted of 10 items and the others consisted of 8 items. Each item was rated on a 4-point Likert scale (1-4), with higher score indicating higher social skills. The internal consistency reliability was Cronbach's  $\alpha = .82-.94$  in Kim's study and  $.90-.92$  in this study.

**Data Analysis:** The IBM SPSS 21.0 program was used for data analyses. Descriptive statistics was used for the participants' general characteristics and study variables. T-test or one-way analysis of variance was used to determine differences in children's social skills according to general characteristics. Pearson's correlation was used to identify the relationship between research variables, and multiple regression was used to identify the influencing factors of children's social skills.

## Results

**General Characteristics:** The general characteristics of study subjects are shown in Table 1. Majority of mothers are in their 30s (70.1%) and

graduated from university (48.7%). The number of mothers without job was higher than those with job, and majority had a monthly income of approximately 2–3 million won (44.4%).

Majority of children aged 6 years (35.9%); then number of female children (50.4%) was higher than that of male children; and most of them were firstborn (52.1%).

**Table 1: General characteristics**

Characteristics	Categories	n (%)
Mother Age (Years)	20~29	13(11.1)
	30~39	82(70.1)
	40	22(18.8)
Education	Middle school	2(1.7)
	High school	54(46.2)
	University	57(48.7)
	> University	4(3.4)
Occupation	Yes	44(37.6)
	No	73(62.4)
Income (10, 000 won/month)	< 200	27(23.1)
	200~300	52(44.4)
	300	38(32.5)
Child Age (Years)	4	15(12.8)
	5	22(18.8)
	6	42(35.9)
	7	38(32.5)
Gender	Male	58(49.6)
	Female	59(50.4)
Birth Order	1st	61(52.1)
	2nd	44(37.6)
	3rd	9(7.7)
	4th	3(2.6)

**Study Variables:** Table 2 shows the study variables of this study. As regards the mothers’ parenting attitude, acceptance attitude has the highest (19.49 out of 24), whereas restrictive attitude has the lowest (16.63 out of 24) points. Mothers’ parenting efficacy was 65.51 out of 80 points. Mothers’ stress level was highest in parenting (9.55 out of 16 points) and lowest in economic stress levels (7.91 out of 16 points). Children’s social skill was highest in assertiveness (27.64 out of 40 points, i.e., 69.1 out of 100 points) and lowest in cooperation (21.02 out of 32 points, i.e., 65.69 out of 100 points).

**Table 2: Study variables**

Parenting Attitude	Possible Range	
	Range	M±SD
Restriction	6~24	7~24 16.63±3.36
Permission	6~24	8~24 17.09±2.65
Acceptance	6~24	10~24 19.49±2.88
Parenting efficacy	20~80	35~78 65.51±7.35
Stress	12~48	15~36 26.50±5.35
Parenting stress	4~16	4~15 9.55±2.24
Economic stress	4~16	4~14 7.91±2.59
Marital stress	4~16	4~16 9.03±2.51
Social skill	26~104	33~96 70.18±13.44
Assertiveness	10~40	11~38 27.64±5.94
Self-control	8~32	8~31 21.50±4.36
Cooperation	8~32	11~29 21.02±4.07

Correlation of parenting attitude, marital stress levels ( $r=-.209, p=.024$ ) were negatively correlated with children’s assertiveness.

Mothers’ parenting attitude (permission) ( $r=.229, p=.013$ ) and parenting efficacy ( $r=.251, p=.006$ ) were positively correlated with children’s self-control. Mothers’ parenting ( $r=-.350, p<.001$ ) and marital stress levels ( $r=-.289, p=.002$ ) were negatively correlated with children’s self-control.

Mothers’ parenting attitude (permission) ( $r=.269, p=.003$ ) and parenting efficacy ( $r=.311, p=.001$ ) were positively correlated, whereas mothers’ parenting ( $r=-.395, p<.001$ ) and economic stress levels ( $r=-.239, p=.009$ ) were negatively correlated with children’s cooperation.

**Table 3. Correlation**

	Assertiveness	Self-control	Cooperation
Parenting attitude - Restriction	.169(.069)	.087(.352)	138(.137)
Parenting attitude - Permission	.099(.291)	.229(.013)	.269(.003)
Parenting attitude - Acceptance	.040(.668)	.057(.543)	.090(.333)
Parenting efficacy	.198(.033)	.251(.006)	.311 (.001)
Parenting stress	-.347(<.001)	-.350(<.001)	-.395(<.001)
Economic stress	-.238(.010)	-.176(.057)	-.239(.009)
Marital stress	-.209(.024)	-.289(.002)	-.164(.077)

**Factors influencing children’s social skill**

Factors influencing children’s social skill

**Parenting efficacy, and stress levels of mothers on their children’s social skills**

Correlation of parenting attitude, parenting efficacy, and stress of mothers on their children’s social skill is shown in Table 3. Mothers’ parenting efficacy was positively correlated with children’s assertiveness

( $r=.198, p=.033$ ). Mothers’ parenting ( $r=-.347, p<.001$ ), economic ( $r=-.238, p=.010$ ), and are shown in Table 4. Children’s assertiveness was influenced by children’s gender and mothers’ parenting stress levels, which accounted for 23.9%; self-control was influenced by children’s gender and birth order and mothers’ parenting and marital stress levels, which accounted for 29.3%; and cooperation was influenced by children’s gender and birth order and mothers’ presence of occupation and parenting stress levels, which accounted for 38.1%.

**Table 4. Influencing Factor**

		<b>B</b>	<b>SD</b>	<b>β</b>	<b>t</b>	<b>p</b>
Assertiveness	Constant	38.24	5.87		6.52	<.001
	Gender of child	-3.39	.99	-.29	-3.44	.001
	Parenting stress	-.65	.25	-.24	-2.58	.011
	Economic stress	-.13	.21	-.06	-0.59	.556
	Marital stress	-.36	.21	-.15	-1.75	.083
	Parenting efficacy	.08	.07	.09	1.10	.272
	R <sup>2</sup> =.239, adjusted R <sup>2</sup> =.205 F=6.971, p<.001					
Self-control	Constant	27.43	4.79		5.72	<.001
	Age of mother	-.02	.70	-.003	-.03	.975
	Gender of child	-1.73	.72	-.199	-2.40	.018
	Birth order of child	-1.63	.79	-.188	-2.07	.041
	Parenting stress	-.44	.17	-.223	-2.57	.012
	Marital stress	-.46	.15	-.266	-3.17	.002
	Parenting attitude : Permission	.12	.15	.072	.78	.436
	Parenting efficacy	.09	.05	.144	1.57	.120
R <sup>2</sup> =.293, adjusted R <sup>2</sup> =.248 F=6.464, p<.001						
Cooperation	Constant	27.48	4.12		6.67	<.001
	Occupation of mother	-1.95	.64	-.233	-3.03	.003
	Gender of child	-1.86	.62	-.230	-2.99	.003
	Birth order of child	-1.86	.64	-.229	-2.89	.005
	Parenting stress	-.53	.155	-.29	-3.41	.001
	Economic stress	-.11	.13	-.068	-.82	.416
	Parenting attitude: permission	.22	.14	.140	1.59	.114
	Parenting efficacy	.07	.05	.129	1.50	.136
R <sup>2</sup> =.381, adjusted R <sup>2</sup> =.341 F=9.582, p<.001						

**Conclusions**

In this study, mothers’ parenting attitude (permission) and parenting efficacy were positively correlated, whereas their stress levels were negatively

correlated with children’s social skills. Children’s social skills were influenced by mothers’ parenting and marital stress levels and children’s gender and birth order, as well as mothers’ occupation. These results indicated that

mothers' stress level was an important factor influencing children's social skill; therefore, interventions to reduce mothers' stress levels should be provided. In addition, general characteristics such as children's gender and birth order and mothers' presence of occupation were also factors influencing children's social skills. Therefore, these differences should be considered in providing educational interventions on parenting.

**Conflict of Interest:** Nil

**Ethical Clearance:** None

**Source of Funding:** Self

### References

1. Song, S. A., Nam, K. W. The longitudinal effect of mother's social parenting behavior and children's sociability on children's social skills. *Early Childhood Education Research and Review*. 2017; 21:325-349.
2. Karami, T., Afsha, J. M., Rezaian, F. Investigate the relationship between personality traits coach with social skills and creativity pre- schoolers. *International Journal of Education & Management*. 2017;7(1):64-67.
3. Hinkely, T., Teychenn, M., Downing, K. L., Ball, K., Salmon, J., Hesketh, K.D. Early childhood physical activity, sedentary behaviors and psychosocial well-being: A systematic review. *Preventive Medicine(Prev Med)*. 2014; 62:182-192.
4. Gresham, F. M. Social skills assessment and intervention for children and youth. *Cambridge Journal of Education*. 2016;21:348-360.
5. Han, S. J. The study of relationships between peer interactions, social skills and social play behaviors of 7 years old children. *The Journal of the Korean Education Forum*, 9(3), 19-38. *Forum*. 2010; 9(3):19- 38.
6. Kang, E. J., Yi, Y. J., Lee, J. R. The effects of parenting behavior, parenting stress, and usage frequencies of cultural infrastructure on young children's social skills. *Korean Journal of Child Care and Education*. 2016;98:29-49.
7. Lianos, P. G. Parenting and social competence in school: The role of preadolescents' personality trait. *Journal of Adolescence (J Adolesc)*. 2015;41:109-120.
8. Lee, O, K., Lee, J.H. Structural equation model on the relationship between children's emotion knowledge and their social and basic academic abilities. *The Journal of Korea Open Association for Early Childhood Education*. 2015;20(5):347-370.
9. Jang, Y.A., Lee, Y.J. Influence of maternal parenting behavior, parenting stress, and marital conflict on infant aggression. *Korean Journal of Family Therapy*. 2012; 20:357-373.
10. Kim, M. J. Relationships among parental child-rearing attitudes perceived by children, self-efficacy, and stress coping behaviors. Master's thesis, Sungshin Women's University, Seoul. 2003.
11. Choi, H.S., Chung, O.B. The development of an inventory for measuring the parenting self- efficacy of Korean mothers. *Korean Journal of Child Studies*. 2001;22(3):1-15.
12. Kim, Y. Y. Relationships of aggression and related factors of children and early children. Master's thesis, Kyungwon University, Seongnam. 2008.

# Relationships between Body Image Perception and Body Esteem and Sexual Assertiveness of Female College Students: Comparison of Nursing Students and Non-nursing Students

Hyun Ju Chae<sup>1</sup>, Kwang Ok Lee<sup>2</sup>

<sup>1</sup>Assistant Professor, Department of Nursing, Jungbu University, South Korea,

<sup>2</sup>Associate Professor, Department of Nursing, Sangmyung University, South Korea

## Abstract

This study aimed to identify the relationships between body image perception and body esteem and sexual assertiveness of 296 female college students of university in Chungnam province: 150 nursing and 146 non-nursing students. Data were collected using a self-administered questionnaire from November 1 to September 10, 2018. The IBM SPSS 20.0 program was used to analyze collected data, including descriptive statistics, t-test, one way ANOVA (Scheffe test for post-hoc) and Pearson's correlation. Sexual assertiveness did not differ between nursing and non-nursing students. In nursing students, the higher the appearance esteem, the higher the sexual assertiveness; however, differences in sexual assertiveness according to body image perception were not significant. In non-nursing students, the higher the appearance esteem, attribution esteem, and body weight esteem, the higher the sexual assertiveness, which was also higher in students who underestimate their body than those who did not. These results indicated that appearance esteem of female students were related to sexual assertiveness. Therefore, various interventions to increase the appearance esteem and promote positive perception about their body should be provided to increase the sexual assertiveness of female college students.

**Keywords:** *Body image, Body esteem, Sexual Assertiveness, Female college student.*

## Introduction

Sexual assertiveness is defined as the ability to express one's feeling related to sexual desire and refuse unwanted sexual behavior<sup>1</sup>. This definition implies that everyone has the right to make decisions regarding one's own bodies and sexual experience and should not be forced to do any unwanted sexual activities<sup>2</sup>. Sexual assertiveness can be expressed in various ways, such as initiating sex, rejecting unwanted sex, and insisting on condom use<sup>2,3</sup>. Men or women with high sexual assertiveness can maintain sexual health by appropriately

expressing sexual needs and controlling sexual impulses<sup>4</sup>, whereas, those with low sexual assertiveness can experience sexual problems such as unwanted pregnancy or sexually transmitted infections due to their inability to refuse unwanted sexual behavior or demand preventive sexual practices<sup>2</sup>. Therefore, sexual assertiveness is a vital element to protect and maintain sexual health in sexual situation<sup>5</sup>.

Despite the importance of sexual assertiveness, women have difficulties in expressing their sexual desires and needs or rejecting unwanted sexual behaviors and are more likely to respond to unwanted sexual intercourse than men<sup>6</sup>. However, women can potentially play an active role rather than a passive role in their sexual relationships with men<sup>7</sup>. Therefore, various interventions should be provided for the improvement of women's sexual assertiveness to help them play a practically active role in sexual relations. To provide interventions for improvement of women's sexual assertiveness, it is

---

### Corresponding Author:

**Kwang Ok Lee**

Associate Professor, Department of Nursing,  
Sangmyung University, South Korea

Contact No.: 82415505432

e-mail: kolee@smu.ac.kr

necessary to identify the influencing factors of women's sexual assertiveness. In previous studies, women's sexual assertiveness is related to various factors such as age, sexual intercourse experience, gender role stereotype, self-esteem, and emotional intelligence<sup>6, 8</sup>. However, studies on the effects of body image on sexual assertiveness have been limited because the attention is focused on the body during a sexual encounter<sup>2, 8</sup>.

Body image is a subjective perception or evaluation of one's own body. Previous studies regarding relationships between body image and sexual health reported that women who are ashamed of their body and anxious about their appearance tend to feel more self-consciousness during sexual behaviors and more likely experience sexual problems<sup>9</sup>.

In additions, these studies reported that women with poor body image initiate sex less and have more unprotected sex or risky sexual behaviors<sup>2, 10</sup>. However, whether these women think they have the right to sexual assertiveness and they have the conviction to act on that right remains to be elucidated<sup>2</sup>. In other words, whether these women's sexual behaviors are related to sexual assertiveness remains unknown. Therefore, relationships between women's body image and sexual assertiveness should be identified.

In this study, the relationship between female college students' body image and sexual assertiveness was examined to provide practical and efficient intervention for enhancing sexual assertiveness of female college students. In additions, in this study body image was measured using both a single-item questionnaire and the body esteem scale. Body image is often evaluated using uni-dimensional measures, but it consists of multiple dimensions<sup>2</sup>. Considering these facts, in this study body image was measured using both a single-item questionnaire on body image perception and the body esteem scale, which are multidimensionally constructed.

## Method

**Design and Subject:** This survey study was conducted to identify the relationships between body image perception and body esteem and sexual assertiveness of female college students.

Participants consisted of 296 female students of university in Chungnam province: 150 nursing students and 146 non-nursing students.

Data were collected using a self-administered questionnaire from November 1 to September 10, 2018. Participants were fully explained on the purpose of this study, and the questionnaire was administered only if they agreed to participate in the study.

**Measurements:** Body image perception was measured using a single item subjective body image perception questionnaire designed to self-evaluate whether the female students was thin, normal, obese. Body image distortion was calculated by comparing body image perception and body mass index.

Body esteem was measured using a Park's<sup>11</sup> body esteem scale, a translated body esteem scale developed by Mendelson, Mendelson and White<sup>12</sup>. This scale consisted of 23 items and three subcategories (appearance, body weight, and attribution). Each items was rated on 5-point Likert scale (1-5), with higher score indicating higher body esteem. The internal consistency reliability was Cronbach's  $\alpha = .82\sim.90$  in Park's<sup>11</sup> study and .82 in this study.

Sexual assertiveness was measured using a sexual assertiveness scale developed by Chae<sup>8</sup>. The scale was designed to measure the expression of one's needs and rejection of others' needs for seven sexual behaviors. This scale consisted of 18 items and each item was rated on 5-point Likert scale (1-5), with higher score indicating the higher sexual assertiveness. The internal consistency reliability at the time of development was Cronbach's  $\alpha = .87$ <sup>8</sup> and .88 in this study.

**Data Analysis:** The IBM SPSS 20.0 program was used to analyze the collected data. Descriptive statistics was used for general characteristics, body image related characteristics, body esteem, and sexual assertiveness. X<sup>2</sup>-test, t-test, and ANCOVA were used to determine differences among general and body image related characteristics and body esteem and sexual assertiveness between nursing and non-nursing students. T-test and one way ANOVA were used to test differences in sexual assertiveness according to general and body image related characteristics. Pearson's correlation was used to identify the relationships between body esteem and sexual assertiveness.

## Results

**General Characteristics:** Participants' general characteristics are shown in Table 1. Regarding their grade, nursing students had higher grades than non-



nursing students ( $\chi^2=21.79, p<.001$ ). The experience of relationship ( $\chi^2=8.11, p=.004$ ) and intercourse ( $\chi^2=7.15, p=.009$ ) were higher in non-nursing students than in nursing students. Religion and time of the first relationship were not different between them.

**Body image perception and body esteem:** Body image perception and body esteem are shown in Table 2. As regards the difference in body image perceptions, nursing students were less likely to perceive their body

shape as normal, but were more likely to perceive them as thin or obese than non-nursing students. ( $\chi^2=7.79, p=.020$ ). Body mass index and body image distortion were not different between them. As regards the difference in body esteem, appearance esteem was higher in nursing students than non-nursing students ( $t=2.98, p=.003$ ). Attribution and body weight esteem, the other two subcategories of body esteem, were not different between them.

**Table 1. General characteristics (N = 296)**

Characteristics	Categories	Nursing Students (n=150)	Non-nursing students (n=146)	$\chi^2(p)$
		n (%)	n (%)	
Grade	Freshman	25(16.7)	34 (23.3)	21.79 ( $<.001$ )
	Sophomore	36 (24.0)	33 (22.6)	
	Junior	44 (29.3)	65 (44.5)	
	Senior	45 (30.0)	14 (9.6)	
Religion	No	85 (56.7)	84 (57.5)	0.02 (.880)
	Yes	65 (43.3)	62 (42.5)	
Relationship	No	29 (19.3)	11 (7.5)	8.11 (.004)
	Yes	121 (80.7)	135 (92.5)	
First relationship	Before university	83 (68.6)	106 (78.5)	3.25 (.087)
	University	38 (31.4)	29 (21.5)	
Intercourse	No	100 (82.6)	92 (68.1)	7.15 (.009)
	Yes	21 (17.4)	43 (31.9)	

**Table 2. Body image perception and body esteem (N = 296)**

Characteristics	Categories	Nursing students (n=150)	Non-nursing Students (n=146)	$\chi^2$ or t (p)
		n(%) or M±SD	n(%) or M±SD	
Body mass index	Low weight	28 (19.4)	34 (25.6)	5.60 (.061)
	Normal	99 (68.8)	93 (69.9)	
	> Normal	17 (11.8)	6 (4.5)	
Body image perception	Thin	27 (18.0)	16 (11.0)	7.79 (.020)
	Normal	77 (51.3)	98 (67.1)	
	Obese	46 (30.7)	32 (21.9)	
Body image distortion	Under perception	11 (7.6)	6 (4.5)	2.94 (.230)
	Right perception	98 (68.1)	84 (63.2)	
	Over perception	35 (24.3)	43 (32.3)	
Body esteem	Appearance	30.91±4.87	29.30±4.35	2.98 (.003)
	Attribution	14.06±2.99	14.56±3.46	-1.32 (.189)
	Body weight	23.46±5.38	22.39±4.18	1.88 (.061)
	Sum	68.32±10.33	66.23±9.64	1.76 (.079)

**Table 3. Sexual assertiveness (N=296)**

Variables	Total	Range	Nursing Students (n=150)			Non-nursing Students (n=146)			F (P)
			Min	Max	M±SD	Min	Max	M±SD	
Sexual assertiveness	90	18~90	34	90	66.86±9.53	35	90	67.29±10.84	0.28 (.599)

**Sexual Assertiveness:** Sexual assertiveness is as shown in Table 3. Tables 1 and Table 2 show variables with statistically significant differences in general characteristics, body image related characteristics, and body esteem of nursing and non-nursing students. Therefore, the difference in sexual assertiveness between them was analyzed using ANCOVA to control these variables.

After controlling these variables, sexual assertiveness was not different between nursing and non-nursing students (F=.028, p=.599).

**Sexual assertiveness according to general characteristics and body image perception:** Sexual assertiveness according to the general characteristics and body image perception is shown in Table 4. In nursing students, sexual assertiveness was not different according to general characteristics and body image perception, whereas in non-nursing students, it was higher in those who underperceive than those who overperceive or right perceive their body image (F=4.28, p=.016).

**Correlations between body esteem and sexual assertiveness:** Table 5 shows the correlations between body esteem and sexual assertiveness. In nursing students, the higher the appearance esteem, the higher sexual assertiveness (r=.18, p=.026), whereas in non-nursing students, the higher the appearance esteem (r=.22, p=.008), attribution esteem (r=.20, p=.021), and body weight esteem (r=.20, p=.002), the higher sexual assertiveness.

### Conclusions

This study showed that sexual assertiveness did not differ between nursing students and non-nursing students. This result indicated that interventions related to sexual assertiveness for female college students should focus more on their characteristics than their major. However, studies on differences in sexual assertiveness of female college students according to their major are insufficient. Therefore, further studies are warranted.

Relationships between body image perception and body esteem and sexual assertiveness of female college students were analyzed according to their major. In nursing students, the higher the appearance esteem among all body esteem variables,

**Table 4. Sexual assertiveness according to general characteristics and body image perception (N=296)**

Characteristics	Nursing Students (n=150)	Non-nursing Students (n=146)
	M±SD	M±SD
<b>Grade</b>		
Freshman	68.04±8.91	66.73±9.95
Sophomore	68.37±10.72	67.44±10.68
Junior	64.88±9.21	67.94±11.18
Senior	66.93±9.16	65.36±12.50
F (p)	1.04 (.377)	0.25 (.860)
<b>Religion</b>		
No	65.59±9.06	67.26±11.95
Yes	68.59±9.93	67.34±9.25
t (p)	-1.91 (.058)	-0.05 (.962)
<b>Relationship</b>		
No	63.82±10.72	65.45±15.46
Yes	67.58±9.13	67.45±10.44
t (p)	-1.89 (.060)	-0.58 (.560)
<b>First Relationship</b>		
Before university	68.54±9.45	66.89±10.47
University	65.50±8.13	68.52±11.38
t (p)	1.71 (.090)	-0.72 (.470)
<b>Intercourse</b>		
No	68.07±9.01	67.25±10.42
Yes	65.24±9.55	67.88±10.59
t (p)	1.30 (.198)	-0.32 (.751)
<b>BMI</b>		
Low weight	64.33±8.88	67.76±8.43
Normal	68.28±9.95	67.30±11.53

Characteristics	Nursing Students (n=150)	Non-nursing Students (n=146)
	M±SD	M±SD
> Normal	63.76±5.31	69.67±18.28
F (p)	3.06 (.050)	0.14 (.873)
<b>BIP</b>		
Thin	66.89±10.13	70.69±8.51
Normal	67.53±10.25	67.74±10.78
Obesity	65.73±7.85	64.16±11.65
F (p)	0.50 (.609)	2.19 (.115)
<b>BID</b>		
Under perception	68.91±11.33	79.33±6.89 <sup>a</sup>
Right perception	66.99±9.71	67.68±11.28 <sup>b</sup>
Over perception	66.41±8.27	65.55±10.28 <sup>b</sup>
F (p)	0.29 (.751)	4.28 (.016) <sup>a&gt;b</sup>

BMI = body mass index; BIP = body image perception; BID=body image distortion

The higher the sexual assertiveness; however, differences in sexual assertiveness according to body image perception were not significant. In non-nursing students, the higher the appearance esteem, attribution esteem, and body weight esteem, the higher the sexual assertiveness and sexual assertiveness was higher in students who underestimate their body than those who did not. These results indicated that appearance esteem of female college students were related to sexual assertiveness. Therefore, various interventions to increase the appearance esteem and promote positive perception about their body should be provided to female college students to increase their sexual assertiveness. In additions, studies on the relationships between body image perception and sexual assertiveness of female college students are also insufficient, therefore, this should be investigated further.

**Table 5. Correlations between body esteem and sexual assertiveness (N=296)**

		Body esteem : appearance r (p)	Body esteem : attribution r (p)	Body esteem : body weight r (p)	Body esteem : sum r (p)	Sexual assertiveness r (p)
Nursing students (n=150)	Body Esteem : Appearance	1				
	Body Esteem : Attribution	.48(<.001)	1			
	Body Esteem : Body Weight	.37(<.001)	.37(<.001)	1		
	Body Esteem : Sum	.80(<.001)	.71(<.001)	.80(<.001)	1	
	Sexual Assertiveness	.18(.026)	.11(.204)	.08(.351)	.16(.055)	1
Non-nursing students (n=146)	Body Esteem : Appearance	1				
	Body Esteem : Attribution	.39(<.001)	1			
	Body Esteem : Body Weight	.59(<.001)	.34(<.001)	1		
	Body Esteem : Sum	.86(<.001)	.69(<.001)	.83(<.001)	1	
	Sexual Assertiveness	.22(.008)	.20(.021)	.20(.021)	.26(.002)	1

**Conflict of Interest:** Nil

**Ethical Clearance:** None

**Source of Funding:** Self

**References**

- Rostok SS, Dekhtyar O, Cupp PK, Anderman EM. Sexual self-concept and sexual self-efficacy in adolescents: A possible clue to promoting sexual health? Journal of Sex Research. 2008;45:277-286.
- Auslander BA, Baker J, Short MB. The connection between young women’s body esteem and sexual assertiveness. Journal of Pediatric and Adolescent Gynecology. 2012;25(2):127-130.
- Hatfield EC, Luckhurst C, Rapson, RL. Sexual motives: The impact of gender, personality and sexual motives on sexual behavior-especially risky sexual behavior. Interpersona. 2011;5:95-133.
- Kim KW, Kang KH, Jeong GH. Self efficacy and sexual autonomy among university students.

- Journal of Korean Public Health Nursing. 2012;26(1):51-59.
5. Zerubavel N, Messman-Moore TL. Sexual victimization, fear of sexual powerlessness, and cognitive emotion dysregulation as barriers to sexual assertiveness in college women. *Violence Against Women*. 2013;19(12):1518-1537.
  6. Asadi M, Siavoshi H, Shiralipour A, Nazry AM, Miri M, Shayad S. The relationship between aggression and communication belief with sexual assertiveness on women. *Procedia-Social and Behavioral Sciences*. 2011;15:922-926.
  7. Azmoud E, Firoozi M, Sadeghi Sahebzaad E, Asgharipour N. Relationship between gender roles and sexual assertiveness in married women. *International Journal of Community based Nursing and Midwifery*. 2016;4(4):363-373.
  8. Chae HY. Relationships between body type perception and emotional intelligence and sexual assertiveness of female college students. *Journal of Digital Convergence*. 2019;17(7):197-205.
  9. Steer A, Tiggemann M. The role of self-objectification in women's sexual functioning. *Journal of Social and Clinical Psychology*. 2008;27(3):205-225.
  10. Woertman L, van den Brink F. Body image and female sexual functioning and behavior. A review. *Journal of Sex Research*. 2012;49(2-3), 184-211.
  11. Park WC. The effect of adolescent's body mass index, self-esteem, family criticism and media exposure on their body image [master's thesis]. [Seoul]:Yonsei University. 2009.
  12. Mendelson BK, Mendelson MJ, White DR. Body esteem scale for adolescents and adults. *Journal of Personality Assessment*. 2001;76:90-106.

# Study of Multiple Genotypes in the *XPD* gene for A/C Lys751Gln and Lung Cancer in Samples from Baghdad–Iraq

Maiss Adnan Al-Ward<sup>1</sup>, Mohammed Mahdi Jawad<sup>1</sup>

<sup>1</sup>University of Baghdad, College of Education/Ibn Al-Haitham Department of Biology/Iraq

## Abstract

The chance of treating lung cancer is very low due to late diagnosis of metastasis. Therefore, the study of lung cancer and its related genetic patterns is of great importance in early diagnosis of infected individuals. This study analyzes the replication of A/C Lys751Gln polymorphisms of the *XPD* gene in the Iraqi population and the risk of its association with lung cancer. The results suggest that the heterozygous genotype Lys/Gln increases the risk of lung cancer, while Lys/Lys reduces at least the risk of lung cancer, WhileGln/Gln genotype does not show any significant increase in the risk of lung cancer. These types of studies help experts in timely diagnosis and use of effective remedial procedures especially in individuals who have patients from family members, relatives and couples in the case of endogamy . We hope that the association between these forms and lung cancer will be more clearly determined with statistical analyses in different populations as well as we suggest using this technique as a diagnostic biomarker in lung cancer patients. This study aimed to assess the effect of polymorphism on genotypes in the *XPD* gene on the susceptibility of lung cancer in Iraqi patients.

**Keywords:** *XPD*, Lung Cancer, Iraq, Polymorphism, RFLP.

## Introduction

Lung cancer is the most common type of cancer and the leading cause of cancer-related deaths worldwide. According to recent statistics, there are more than 25.4 million cases of lung cancer that caused 1.2 million deaths during the period 1990-2016 [1].

In Iraq, lung cancer ranks second among the top ten types of cancer in Iraqi society, with 8.1% of all cancers diagnosed [2]. Lung cancer is a multivariate disease with both internal and external causes, the most common cause of which is smoking, which responsible for 90% of cases in males and 65% of cases in females[3]. This does not mean that non-smokers are safe from the disease, because internal factors as well as other environmental

factors play an important role in causing the disease. One of the serious problems in lung cancer is its diagnosis in the late stages (Metastasis), which makes treatment difficult, so analysis of the agents of this type of cancer is of great importance [4].Lung cancer studies have shown a high rate of DNA damage and thus reduced repair capability and increased risk of lung cancer [5]. Studies have shown a defect in the DNA repair system and thus reduced repair capacity and increased risk of lung cancer[6,7].That means that lung cancer is a multi-cause disease (external and internal factors), different variables may affect the DNA repair gene and thus cause damage to the DNA.

One of the most important nuclear repair systems is Nucleotide excision repair (NER) [8],and one of the most effective genes in DNA repair is excision repair cross complementing (ERCC2), also known as the Xerodermapigmentosum group D (*XPD*) [9]. This gene encodes one of the important repair enzymes, and it is believed that the polymorphism in this gene is important in the risk of lung cancer. Studies have confirmed that individuals who have Lys751Gln polymorphism of the *XPD* gene have low repair ability for DNA damage.

---

### Corresponding Author:

Maiss Adnan Al-Ward

University of Baghdad, College of Education/Ibn Al-Haitham Department of Biology/Iraq

e-mail: dafai66@yahoo.com

The *XPB* gene is located on the long arm of chromosome 19 (9q13.32) and has a length of approximately 15KD. The protein encoder is a member of the TF11H, a 761 amino acid protein, and contains ATP dependent 5' to 3' helicase activity of the damaged DNA chain and temporarily reduce the correlation<sup>[10, 11]</sup>. Studies suggest that polymorphisms in the *XPB* gene affect the efficiency and ability to repair DNA damage<sup>[12]</sup>. In Lys751Gln, the Gln amino acid in the codon CAG (C allele) is replaced by the primary Lys amino acid in AAG (A allele)<sup>[13]</sup>. Thus, polymorphisms in this gene alter the C-terminal terminal structure, which in turn increases the risk of lung cancer by altering the function of the *XPB* protein<sup>[14]</sup>.

In Iraq there are no previous studies on the model *XPB* Lys751Gln and its relationship to lung cancer by RFLP method, and therefore the study was conducted, and aims to verify its relationship with lung cancer.

## Materials and Method

**Samples:** The current study included 63 Iraqi patients diagnosed with lung cancer ranging in age (30-80) years, including 49 smokers and 14 non-smokers, as well as 24 healthy people as a control group. Blood samples were collected from the visitor patients at the Teaching Oncology Hospital in the Medical City/Baghdad for the period from September 2018 to January 2019. After obtaining the moral permission from the hospital and the patients to conduct the study with the help of the consultant doctors, 3 ml of venous blood using by a disposable syringe in sterile conditions are kept in tubes containing EDTA at a temperature of -20°C until use.

**Genomic DNA Extraction:** Blood samples were collected with the aim of extracting DNA using the gSYNC™ DNA extraction Kit from Taiwanese company Genaid.

**Genomic DNA:** 5 µl of extracted DNA mixed with loading dye and loaded in the wells of 1.5% agarose gel at 75 V for an hour. The results were documented using a UV source at a wavelength of 350 nm<sup>[15]</sup>. Determination of the required segment of the studied genes (target segment) accomplished by using polymerase chain reaction technique, the segment of the *XPB* gene was 476 bp appeared by using a pair of specific primers according to<sup>[16]</sup> (Table 1), from Bioneer (Korea) in a lyophilized form. A certain volume of nuclease-free water was added to primer tubes depending on the concentration of the primer recommended by the leaflet accompanied and the reaction started in the PCR machine according to the program (Table 2) by mixing 5 µl of Pre-mix solution of the kit (Bioneer-Korea) with 3 µl of extracted DNA, 2 µl of each primer and 13 µl of Nuclease-free distilled water to make the volume up to 25 microliters.

**Determination of purity and concentration of DNA:** DNA samples centrifuged by the centrifuge device to ensure their homogeneity. The estimation was performed using the Nanodrop device, 2 microliters of the extracted DNA placed in the space assigned to the device and the order of measurement is given and recorded, which ranged from 1.5-1.8 ng per microliters to all samples.

**Table 1: Sequence of the pair of primers used in this study.**

Reference	Product size	Sequence (5' - 3')		gene
(16)	476 bp	5'-ATCCTGTCCCTACTGGCCATTC-3'	Forward	XPB
		5'-CCACTAACGTCCAGTGAAGTGC-3'	Reverse	

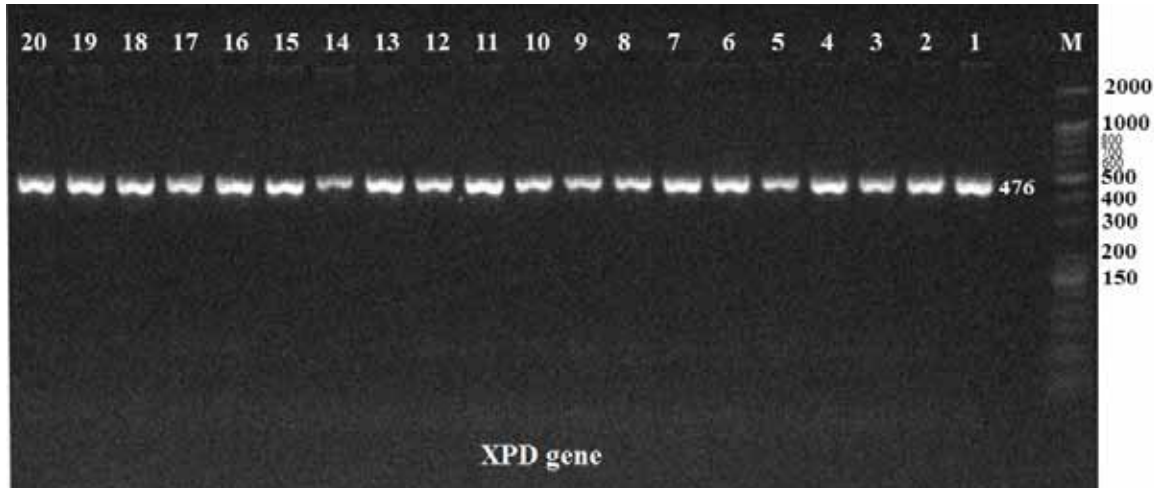
**Table 2: Optimal conditions for PCR reaction**

No. of cycles	Time	Temperature (C°)	Steps
1	5 minute	94	Initial Denaturation
3	30 second	94	Denaturation
	30 second	62	Annealing
	30 second	72	Extension
1	5 minute	72	Final Extension

## Results and Discussions

Analysis of the results of polymerase chain reaction: The molecular size of the PCR product was determined in comparison to (25-2000bp) DNA Molecular weight marker from Bioneer (Korea), 5 µl of the product and 5

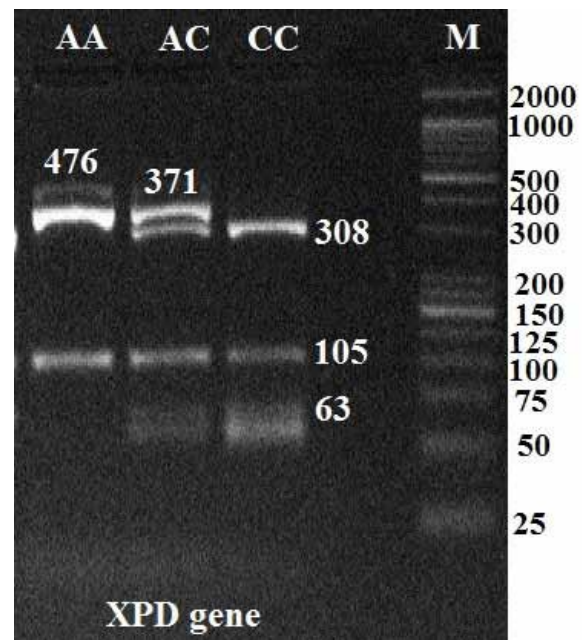
DNA ladder on the 2% agarose gel. The voltage was 80V for an hour, and the results of the electrophoresis using the gel imaging unit was photographed under UV light, the molecular weights were measured and the band that magnified by PCR technique is in 476 bp location (Fig. 1).



**Figure 1:** band resulting from amplification of a segment of the *XPD* gene for a number of studied samples (M) Molecular weight marker 25-2000bp from Bioneer/Korea, 1-20 are samples studied, size of the amplified fragment is 476 bp.

**Enzymatic digestion:** 10 microliters of PCR product were taken to be cut by 1 µl of *Pst* I restriction enzyme after adding the other additions came with the enzyme kit, the mixture incubated at 37 °C for 1 h and electrophoresed on 3% agarose gel and 80 volts for 1.5 hours.

There is one site to identify the enzyme *Pst* I in allele A, so the allele A is expected to display two bands of DNA in sizes 105, 371 bp, while three bands were expected to appear in the C allele due to the site of the additional cutting. These bands were 63, 105 and 308 bp respectively. Individuals with different alleles of zygote were expected to exhibit a combination of two different alleles (Fig. 2).



**Figure 2:** Electrophoresis of PCR-RFLP amplification products using the *Pst* I to analyze Lys751Gln A/C Genotyping, M molecular weight marker 25-2000 base pairs from Bioneer/Korea, CC, AC and AA Genotypes resulting from cutting after amplification of a fragment of the *XPD* gene by PCR technology.

**Statistical analysis:** The statistical analysis system SAS (2012) was used to analyze the various factors in the study. The Chi square law was used to find the range of equilibrium between observed and expected samples. The Hardy–Weinberg equilibrium was used in the population genetics to investigate whether the samples represented the community in real terms. [17].

**Distribution of XPD (Lys751Gln) polymorphisms in samples:** The genetic polymorphism of a fragment of XPD gene was observed in three hereditary structures (CC, AC, and AA) in patients, and in the absence of XPD genotypes CC in control sample. The homozygous genotype AA recorded the higher percentage in control (53.88%) against that of patients (30.16%) and that of a significant difference ( $P < 0.01$ ). The percentage of

the heterozygous genotype AC is (63.49%), and that is higher than in control (46.15%) with a significant difference ( $P < 0.01$ ), while the homozygous genotype GG was recorded in patients (36.35%) and not noticed in control.

The frequency percentage of A allele was (0.62%) in patients and (0.79%) in control, while the frequency percentage of allele C in patients was (0.38%) and in control was (0.21%), and the results of observed values in patients were not consistent with expected values in Hardy-Weinberg equilibrium. In addition, the odds ratio (OR) for the genotype AA was (1.24) and the ratio of (OR) for heterozygous AC genotype was (1.80) and for the homozygous CC was (0.438) (Table 3).

**Table 3: Distribution and allele frequencies of XPD gene in control and lung cancer groups.**

Genotype	Groups		Chi-Square ( $X^2$ )	P-Value (O.R.)
	Control No (%)	Lung cancer No (%)		
AA	14 (53.85%)	19 (30.16%)	8.28**	0.0057(1.24)
AC	10 (6.15%)	40 (63.49%)	6.19**	0.0091 (1.80)
CC	0 (0.00%)	4 (6.35%)	2.63 NS	0.072 (0.438)
Total	24	63	-	-
<b>Allele frequency</b>				
A	0.79	0.62	-	-
C	0.21	0.38	-	-

\*\*( $P < 0.01$ ), NS: Non-Significant

According to statistical analysis, the risk of lung cancer in individuals with polymorphism Lys751Gln (Odd Ratio = 1.80) is greater than that of Lys/Lys genotype, where Gln/Gln genotype is not associated with the risk of lung cancer.

The current study shows that there is a significant difference between patient groups and control in the distribution of AC genotype polymorphism, and C alleles frequency in the Iraqi patient group is more than the control group, so we suggest that this difference could be due to the presence of allele C along with allele A in AC, and molecular interaction between them. These results are consistent with Zhan *et al.* 2010 [18], who suggested that the AC genotype of the XPD gene was associated with lung cancer risk and that the C allele in AC genotype of XPD gene was an increased risk factor for developing lung cancer in the meta-analysis studies, as

well as consistent with the results of Feng *et al.* 2011 [19], who suggested that the AC genotype may contribute to the susceptibility of lung cancer and the high risk of infection with the presence of C allele significantly. It is also consistent with the results of Motovali-Bashietal. 2010 [16], which showed that the proportion of the AC gene was higher in patients compared to the rest of people and that the AA genotype is probably reduces the seriousness. According to a study conducted by Liang *et al.* [20], who mentioned that individuals who have a heterozygous CC genotype, show lung cancer about 2.7 times more than individuals who have an AA genotype.

### Conclusion

This study indicates that most of the infections diagnosed occurred for Lys/Gln AC patients. Lys/Lys individuals is likely to reduce its risk with them.



**Ethical Clearance:** The Research Ethical Committee at scientific research by ethical approval of both environmental and health and higher education and scientific research ministries in Iraq

**Conflict of Interest:** The authors declare that they have no conflict of interest.

**Funding:** Self-funding

## References

1. Global Burden of Disease Cancer Collaboration. Global, regional, and national cancer incidence, mortality, years of life lost, years lived with disability, and disability adjusted life-years for 32 cancer groups, 1900 to 2016: a systematic analysis for the global burden of disease study. *JAMA Oncol.* 2018; 4(11): 1553-1568.
2. Iraqi Cancer registry center publications, (2015). Ministry of Health, Iraqi Cancer Board/Baghda.
3. Xie, A.; Croce, B.; Tian, D. H. Smoking and lung cancer. *Ann Cardiothorac Surg.* 2014; 3(2):221-228.
4. Shanbeh, Z.; Vidar, S. Single nucleotide polymorphisms susceptibility, prognostic and therapeutic markers of non small cell lung cancer. *Lung Cancer.* 2012; 3: 1-14.
5. Wu, X.; Roth, J. A.; Zhao, H. Spitz M.R., et al. Cell cycle checkpoints, DNA damage/repair, and lung cancer risk. *Cancer Res.* 2005; 65: 349-357.
6. Wei, Q.; Cheng, L.; Hong, W.K.; Spitz M. R. Reduced DNA repair capacity in lung cancer patients. *Cancer Res.*, 1996; 56(18): 4103-4107.
7. Spitz M. R.; Wei, Q.; Dong, Q.; Amos C. I.; Wu, X. Genetic susceptibility to lung cancer: the role of DNA damage and repair. *Cancer Epidemiol Biomarkers Prev.*, 2003; 12(8): 689-698.
8. De Boer, J.; Hoeijmakers, J. H. Nucleotide excision repair and human syndromes. *Carcinogenesis.* 2000; 21(3): 453-460
9. Banescu, C.; Trifa, A.P.; Demian, S. et al. Polymorphism of XRCC3, and XPD genes and risk of chronic myeloid leukemia. *BioMed Res Int* 2014; 2014: 1D213790.
10. Leibel, D.; Lapse, P.; Emmert S. Nucleotide excision repair and cancer. *J MolHistol.* 2006; 37(5-7): 225-238.
11. Behamou, S.; Sarasin, A. ERCC2/XPD gene polymorphisms and lung cancer: A HuGE review. *Am J Epidemiol.* 2005; 16(1): 1-14.
12. Spitz, M. R.; WY, X.; Wang, Y.; Wang, L.E.; Shete, S.; Amos, C.I., et al. Modulation of nucleotide excision repair capacity by XPD polymorphisms in lung cancer patients. *Cancer Res.* 2001; 61(4): 1354-1357.
13. Butkiewicz, D.; Rusin, M.; Enewold, L.; Shields, P. G.; Chorazy, M.; Harris, C. C. Genetic polymorphisms in DNA repair genes and risk of lung cancer. *Carcinogenesis.* 2001; 22(4): 593-597.
14. Monaco, R.; Rosal, R.; Dolan, M. R.; Freyer, G.; Brandt-rauf P. W. Conformational effects of a common codon 751 polymorphism on c-terminal domain of xerodermapigmentosum D protein. *J Carcinog.* 2009; 8: 12.
15. Maniatis, T.; Fritsch, E. F. & Sambrook. (2001). In vitro applications of DNA by the polymerase chain reaction, in molecular cloning: A laboratory manual. 2nd ed., Cold Spring Harbor lab.
16. Motovali-Bashi, M.; Rezaei, H.; Dehghanian, F.; Rezaei, H. Association between XPD (Lys751Gln) polymorphism and lung cancer risk: a population-based study in Iran. *Cell J.* 2014; 16(3): 309-314.
17. SAS. (2012). Statistical analysis system, users guides. Statistical Version 9.1th ed. SAS. Inst. Inc. Cary. N. C. USA.
18. Zhan, P.; Wang, Q.; Wei, S.Z.; Wang, J.; Qian, Q.; Yu, L.K.; Song, Y. ERCC2/XPD Lys751Gln and Asp312Asn gene polymorphism and lung cancer risk: a meta-analysis involving 22 case-control studies. *J. ThoracOncol.* 2010; 5(9): 1337-1345.
19. Feng, Z.; Ni, Y.; Dong, W.; Shen, H. and Du, J. Association of ERCC2/XPD polymorphisms and interaction with tobacco smoking in lung cancer susceptibility: a systemic review and meta-analysis. *Mol. Biol. Rep.* 2011; 39(1): 57-69.
20. Liang, G.; Xing. D.; Miao, X.; Tan, W.; Yu, C.; Lu, W., et al. Sequence variations in DNA repair gene XPD and risk of lung cancer in a Chinese population. *Int J Cancer.* 2003; 105(5): 669-673.

# Assessment of Risk Factors of Asthma in Health Institutions in Maysan Governorate, Iraq

Ali Abdulwahed AbdulJabbar<sup>1</sup>, Buthaina Ateyah Rashid<sup>2</sup>

<sup>1</sup>M.Sc. Student, <sup>2</sup>Assist Prof., Middle Technical University College of Health & Medical Technology, Baghdad, Iraq

## Abstract

**Background:** Asthma is a common chronic lung disease in which the airways (bronchi) become inflamed and are abnormally sensitive to certain triggers. Asthma can affect people of all races and ages, and although there is no known cure, there are many ways to control it. The symptoms of asthma include coughing, shortness of breath, wheezing and chest tightness.

**Materials and Method:** This is A case-control study conducted in Consultation Center for Chest and Respiratory Diseases at Al-Sadr Teaching Hospital in Maysan Governorate Data was collected over a period of five months between the 1<sup>st</sup> of November 2019 to the 1<sup>st</sup> of April 2020.

**Results:** The commonest risk factors that had been found causes asthma in cases was family history of asthma with OR=5.127, CI=(2.77-9.49), upper respiratory tract infection with OR=5.059, CI=(2.29-8.76), active smoker with OR=2.145, CI=(1.18-3.91) Occupational exposure to dust with OR = 4.660, CI= (2.68-8.10), skin allergy with OR =2.77, CI=(1.28-6.03).

**Conclusion:** Significant association was found between (Family history of asthma, upper respiratory tract infection, active smoking, occupational exposure to dust, chemical, fumes, and gases, allergies and the used of NSAIDs before the onset of asthma) and asthma in adults in maysan governorate.

**Keywords:** Risk Factors; Asthma; chronic lung disease; Maysan.

## Introduction

Asthma is a common chronic respiratory disease and is a major public health problem worldwide, and affects people of all races and genders. Reports indicate that the number of asthma sufferers worldwide may exceed 334 million, according to a report published by the World Asthma Network in 2014<sup>(1)</sup>. Many studies have shown that the prevalence of asthma varies between countries and within countries, and is directly proportional to different allergies, where different lifestyles are adopted and societies become civilized, and this trend is expected

to continue during the next two decades<sup>(2)</sup>. For people who suffer from asthma, it can cause them a major disability and affect the quality of life significantly<sup>(1)(2)</sup>. The significant increase in the prevalence of asthma and other allergies (for example, eczema) cannot be explained over the past several decades by relying on genetic factors alone, and this leads to an increased focus on other risk factors such as environmental exposure, for example, and it is expected that cases will rise Asthma to over 400 million cases globally in 2025<sup>(3)</sup>. due to climate change, increased exposure to air pollution, urbanization, changing the immune response and changing lifestyle<sup>(3)</sup> <sup>(4)</sup>. in the UK receiving approximately 4.3 million adults treating from asthma<sup>(5)</sup>.

---

### Corresponding Author:

Ali Abdulwahed AbdulJabbar

M.Sc. Student, Middle Technical University College of Health & Medical Technology, Baghdad, Iraq  
e-mail: drnihadkhalawe@gmail.com

**Aim of Study:** To assess the major risk factors of asthma in adult in health institutions in maysan governorate.

## Patients and Method

A case-control study was conducted in Consultation Center for Chest and Respiratory Diseases at Al-Sadr Teaching Hospital in Maysan Governorate (one of the 18 Iraqi governorates located in south of Iraq the number of persons 1 million and characteristics with Marshes and oil) It is a center for the diagnosis and treatment of respiratory diseases and is located in the center of the city of Amara and provides care and treatment to respiratory patients from all its districts and aspects of Maysan Governorate. The center provides services to an average of 50 patients daily with respiratory diseases of them about 2-3 patients with asthma daily for 5 days in a week. The daily center activities include history taking, clinical examination, laboratory investigations, management, the follow-up to asthma patients, health education, also

different respiratory cases for management, and follow up. Data was collected over a period of five months between the 1<sup>st</sup> of November 2019 to the 1<sup>st</sup> of April 2020.

**Statistical Analysis:** Analysis of data was carried out using the available statistical package of SPSS-25 (Statistical Packages for Social Sciences- version 25).

**Finding:** The results in table 1 showed the distribution of age and gender among cases and controls and there was no statistically significant difference between the two groups ( $p > 0.05$ ) the higher percentage of cases was in age groups (40-49) years (27.5%). the higher percentage of controls was in the age group (30-39) years (30.8%). Predominantly males (36.7%) and females (63.3%) in both cases and controls.

**Table (1): Distribution of cases and controls according to age and gender.**

		Asthmatic patients		Controls		P value
		No	%	No	%	
Gender	Male	44	36.7	44	36.7	
	Female	76	63.3	76	63.3	
Age (years)	<20 years	7	5.8	4	3.3	0.356
	20---29	12	10.0	21	17.5	
	30---39	30	25.0	37	30.8	
	40---49	33	27.5	27	22.5	
	50---59	20	16.7	18	15.0	
	=>60 years	18	15.0	13	10.8	

The results in (table 2) shows persons that used electrical heating system protected from asthma with low significant association  $OR=0.553, CI=(0.32-0.95)$ . Persons that use oil heating system at risk (5 times) to have asthma with highly statistical significant  $OR=4.846, CI=(2.40-9.80)$ . Regarding dampness on the wall, the percentage of the cases was 73.3%, and

controls were 65.0%, with no statistical differences between the two groups ( $p\text{-value}=0.162$ ). Regarding household pets, the percentage of cases was 19.2% and controls were 15.0% with no statistical significant  $P\text{-Value}=0.162$ . persons that allow pets in bed at risk 5 times to have asthma with significant association  $OR=5.46, CI=(1.24-24.09)$ .

**Table (2) : Distribution of cases and controls according to heating system inside the house, dampness on the wall and household pets.**

Type of heating system inside the house		Asthmatic patients		Controls		P value	OR (95% CI)
		No	%	No	%		
Electrical	Yes	34	28.3	50	41.7	0.030*	0.553 (0.32-0.95)
	No	86	71.7	70	58.3		

Type of heating system inside the house		Asthmatic patients		Controls		P value	OR (95% CI)
		No	%	No	%		
Oil	Yes	108	90.0	78	65.0	0.0001*	4.846 (2.40-9.80)
	No	12	10.0	42	35.0		
Is there dampness on the wall	Yes	88	73.3	78	65.0	0.162	1.481 (0.85-2.57)
	No	32	26.7	42	35.0		
You have household pets	Yes	23	19.2	18	15.0	0.391	1.344 (0.68-2.64)
	No	97	80.8	102	85.0		
Allow pets be in bed	Yes	12	52.2	3	16.7	0.019*	5.46 (1.24-24.09)
	No	11	47.8	15	83.3		

This table shows the persons that have a family history of asthma at risk 5 times to have asthma compared with none with highly significant association OR=5.127,CI=(2.77-9.49). the high percentage of family history in cases was 18.3% in mother, and in controls was 7.5% in sister.

These results shows persons that have upper respiratory tract infection at risk five times to

have asthma with highly significant association OR=5.059,CI=(2.29-8.76). this table shows persons that have an infection from 6-11 months at risk 8 times to have asthma with highly significant association OR=8.25,CI=(1.80-37.91), persons that have infections =>12 months at risk 4 times to have asthma with highly significant association OR=4.29,CI=(1.48-12.41).

**Table (3) : Distribution of cases and controls according to family history and upper respiratory tract infection.**

		Asthmatic patients		Controls		P value	OR (95% CI)
		No	%	No	%		
Family history of asthma	Yes	57	47.5	18	15.0	0.0001*	5.127 (2.77-9.49)
	No	63	52.5	102	85.0		
The relationship with the person in the family has asthma	Brother	3	2.5	3	2.5		
	Father	17	14.2	2	1.7		
	Grandfather	4	3.3	-	-		
	Mother	23	18.3	3	2.5		
	Sister	3	2.5	9	7.5		
	Sons	-	-	1	0.8		
	Uncle	7	5.8	1	0.8		
Have URT infection before asthma onset	Yes	86	71.7	40	33.3	0.0001*	5.059 (2.29-8.76)
	No	34	28.3	80	66.7		
Duration of infection	<6 months	40	46.5	33	82.5	0.001*	-
	6---11	20	23.3	2	5.0		
	=>12 months	26	30.2	5	12.5		

The results in table 4 show persons that are an active smoker before the onset of asthma at risk 2 times to have asthma from non-smoker with significant association

OR=2.145,CI=(1.18-3.91). the high percentage of cigarettes packet/day was 56.4% of cases and 72.7%of controls were in 1 packet/day, With statistically no

significant (p-value = 0.433). the high percentage of the duration of smoking of cases was 43.6% in duration (=>15 years), for controls were 40.9% in duration

(10---14 years). Regarding second-hand smoke, the percentage of cases was 50.8% and controls were 49.2% with statistically no significant (p-value = 0.796).

**Table (4) : Distribution of cases and controls according to smoker and second hand smoke.**

		Asthmatic patients		Controls		P value	OR (95% CI)
		No	%	No	%		
Smoker before onset asthma	Yes	39	32.5	22	18.3	0.012*	2.145 (1.18-3.91)
	No	81	67.5	98	81.7		
Cigarettes packet/day	1	22	56.4	16	72.7	0.433	
	2	15	38.5	5	22.8		
	3	2	5.1	1	4.5		
Duration of smoking	<5 years	5	12.8	1	4.5	0.530	
	5---9	7	17.9	4	18.2		
	10---14	10	25.6	9	40.9		
	=>15 years	17	43.6	8	36.4		
Second hand smoke	Yes	61	50.8	59	49.2	0.796	1.069 (0.64-1.77)
	No	59	49.2	61	50.8		

The results in(table 5) show persons that are overweight that have BMI(25-29.9) at risk 1 time to have asthma but with no significant association OR=1.42,CI=(0.78-2.58). Persons that are Obese I that have BMI (30-34.9) at risk 3 times to have asthma

with significant association OR=2.54,CI=(1.15-5.63). persons that are Obese II that have BMI(=>35) at risk 5 times to have asthma with significant association OR=4.89,CI=(1.77-13.53).

**Table (5) : Distribution of cases and controls according to BMI.**

		Asthmatic patients		Controls		P value	OR (95% CI)
		No	%	No	%		
BMI (Kg/m <sup>2</sup> )	Normal (18.5-24.9)	33	27.5	51	42.5	0.005*	-
	Overweight (25-29.9)	45	37.5	49	40.8		1.42 (0.78-2.58)
	Obese I (30-34.9)	23	19.2	14	11.7		2.54 (1.15-5.63)
	Obese II (=>35) Total	19120	15.8100	6120	5.0100		4.89 (1.77-13.53)

**Discussion**

Regarding the age, the results in this study demonstrated that the higher percentage was in the age group between (40-49) years with no significant association (p-value =0.356). it disagrees with the study that reported by Abdhussian, 2015 in Basrah that found most of the study samples were among age group (30-44) years with no significant association (p-value =0.730)<sup>(6)</sup>. In the current study, this results demonstrated

that the higher percentage of gender in females 63.3% in compared with males 36.7%.which is in agreement with the result that done by Abdhussian, 2015 in Basrah that found most of the study samples were among females 62.5% in compared with males 37.5%<sup>(6)</sup>.

Regarding the type of heating system inside the house the results of current study shows that the higher percentage was 90.0% in cases and 65.0% in controls were oil, which it disagrees with the result of study

done by Esmail Idani, 2019 in Iran which found that the higher percentage of cases was 98.3% , and controls were 98.4% were Gas<sup>(7)</sup> . This disagreement may be due to the type of fuel available in Iraq compared to other countries, Also, it may be due to economic and environmental matters.

In this study regarding dampness on the wall, this result demonstrate that the percentage of the cases was 73.3%, and controls were 65.0%, with no statistical differences between the two groups (p-value= 0.162). which is in agreement with the result of study done by Esmail Idani, 2019 in Iran that found that the percentage of cases was 51.1% and controls were 49.2% with no statistical differences between the two groups (p-value= 0.433)<sup>(7)</sup>.

regarding household pets, the current study demonstrate that the percentage of cases have household pets was 19.2% and controls were 15.0%, and this results shows the percentage of allowing pets in bed was 52.2% in cases and 16.7% in controls with statistical significance (p-value = 0.019). which is in agreement with the results of study done by Esmail Idani, 2019 in Iran that found the percentage of cases have household pets was 8.5%, and controls were 7.9%, and the percentage of allowing pets in bed was 2.8% in cases and 0.9% in controls with statistical significance (p-value <0.001)<sup>(7)</sup>.

The present study demonstrate that the percentage of cases have family history of asthma was 47.5% and for controls 15.0%, which is in agreement with results of study that done by Elfaki NK, 2017 in Saudi Arabia. That found that the percentage of cases have family history of asthma was 66.8%. and for controls 40.2%<sup>(8)</sup>.

The current study demonstrate that the percentage of cases have upper respiratory tract infection was 71.7%, and for controls were 32.5% with highly statistically significant (OR= 5.253 , CI=3.03-9.11) . which is in agreement with the results of study that reported by Al-Mazam, A., 2001 in Saudi Arabia that found that the percentage of cases have upper respiratory tract infection was 61.8%, and for controls were 13.6% that found to be an independent risk factor for bronchial asthma (OR=10.5, CI=5.11-21.89)<sup>(9)</sup>.

Regarding active smoker this study shows that the percentage of the active smoker was 32.5% among cases and 18.3 among controls , which is in agreement with the results of study done by Elfaki, N. K., 2017 in Saudi

Arabia that found the percentage of cases are active smokers was 26.6% and for controls were 22.8%<sup>(8)</sup>.

Regarding second-hand smoke, this study shows that the percentage of cases was 50.8%, and for controls were 49.2%. which is in agreement with the results of study done by Elfaki, N. K., 2017 in Saudi Arabia. that found the percentage of cases was 66.3% and for controls were 56.0%<sup>(8)</sup>.

Regarding BMI (Body Mass Index) this study shows that the higher percentage of cases was 37.5% were overweight (25-29.9), and the lower percentage of cases was 15.8% were obese II(=>35). which is in agreement with the results of study done by Muhammed, S. M et al, 2012 in Baghdad which found that the higher percentage of asthmatic patients was 45.7% were overweight (25-29.9). and the lower percentage of cases was 2.3% were obese II(=>35)<sup>(10)</sup>. But, it is disagreed with the results of study done by Rönmark, E. et al, 2005 in northern Sweden that found that the higher percentage of cases was 42.1% were normal (20-24.9)<sup>(11)</sup>. This disagreement may be due to a different lifestyle in Iraq than in other countries.

## Conclusions

Statistically significant was found between the type of heating system inside the house and asthma in adults. Also, between patients who had a family history of asthma and asthma in adults. So Positive association was found between upper respiratory tract infection and asthma in adults.

**Conflict of Interest:** None

**Funding-self or Other Source:** None

**Ethical Clearance:** None

## References

1. Asher MI, Ellwood P. The global asthma report 2014. 2014.
2. Cruz AA. Global surveillance, prevention and control of chronic respiratory diseases: a comprehensive approach. World Health Organization; 2007.
3. Pawankar R, Canonica GW, Holgate ST, Lockey RF. WAO White Book on Allergy: World Allergy Organization. Philadelphia: Lippincott; 2011.

4. Moses L, Morrissey K, Sharpe RA, Taylor T. Exposure to indoor mouldy odour increases the risk of asthma in older adults living in social housing. *Int J Environ Res Public Health*. 2019;16(14):2600.
5. Janes C, Andrews T, Abdel-Maguid M. Designing an Augmented Reality Smartphone Application for the Enhancement of Asthma Care Education. In: *Interactive Mobile Communication, Technologies and Learning*. Springer; 2017. p. 11–7.
6. Sherhan AOMAA. Risk factors of bronchial asthma among adults in Basrah. *Med J Basrah Univ*. 2018;36(1):16–21.
7. Idani E, Raji H, Maraghi E, Aghababaeian H, Madadzadeh F, Dastoorpoor M. Risk factors associated with asthma among adults in Khuzestan, southwest Iran. *Clin Epidemiol Glob Heal*. 2020; 8(2):350–5.
8. Elfaki NK, Shiby AY. Risk factors associated with asthma among Saudi adults in Najran. *J Clin Respir Dis Care*. 2017;3(133):1247–2472.
9. Al-Mazam A, Mohamed AG. Risk factors of bronchial asthma in Bahrah, Saudi Arabia. *J Family Community Med*. 2001;8(1):33.
10. Muhammed SM, Sultan KM, Abdulrazaq MY. Asthma in adults; epidemiology, risk factor and patterns of presentation: a cross sectional, questionnaire based study in Baghdad Teaching. *Karbala J Med*. 2012;5(11):1255–61.
11. Rönmark E, Andersson C, Nyström L, Forsberg B, Järholm B, Lundbäck B. Obesity increases the risk of incident asthma among adults. *Eur Respir J*. 2005;25(2):282-8.

# The Determinant of Coping Mechanisms among Breast Cancer Patients in Sidoarjo Regency, Indonesia

Masruroh<sup>1,2</sup>, Ah Yusuf<sup>3</sup>, Agung Dwi Laksono<sup>4</sup>

<sup>1</sup>Doctoral Program, Faculty of Public Health, Universitas Airlangga, Surabaya Indonesia, <sup>2</sup>Faculty of Health Science Universitas Pesantren Tinggi Darul Ulum, Jombang, Indonesia, <sup>3</sup>Faculty of Nursing, Universitas Airlangga, Surabaya Indonesia, <sup>4</sup>National Institute of Health Research and Development, Indonesia Ministry of Health, Jakarta, Indonesia

## Abstract

Breast cancer patients need coping mechanisms to adapt to changes due to breast cancer. The constructive coping mechanism is very influential on the attitude, response, decision making towards breast cancer management, and quality of life. The study aimed to determine the determinants of coping mechanisms of breast cancer patients in Sidoarjo Regency, Indonesia. The sample size was 98 breast cancer patients. The variables analyzed included coping mechanism, age, educational, marital, work, time diagnosed, genetic, stage of cancer, therapy, social support, and spiritual need. The results found that breast cancer patients with higher education had a 51.200 times chance compared to breast cancer patients with no education to have adaptive coping mechanisms. Therapy for breast cancer patients has a positive effect on adaptive coping mechanisms. Social support has a positive influence on breast cancer patients to have an adaptive coping mechanism. The higher the social support provided, the more adaptive coping mechanism is for breast cancer patients. Three variables have proven to be significant as determinants of coping mechanisms among breast cancer patients in the Sidoarjo Regency, namely education, therapy, and social support.

**Keywords:** *Breast cancer, coping mechanisms, spiritual needs, social support, education.*

## Introduction

Breast cancer is a malignant tumor originating from breast cells. Breast cancer can originate from cells that produce mammary glands (lobular), glandular ducts from lobular to nipple (ducts), and supporting breast tissue that surrounds the lobular, ducts, blood vessels, and lymph vessels, but does not include breast skin<sup>1</sup>.

Breast cancer is the highest type of cancer in women in the world. The incidence of breast cancer increased from 26 per 100,000 to 38 per 100,000 women. This prevalence is above cervical cancer with a record of 16 per 100,000 women<sup>2</sup>. In Indonesia, the prevalence

of cancer is 1.4 per 1,000 population and is the 7th leading cause of death (5.7%) of all causes of death. The estimated incidence of breast cancer in Indonesia is 40 per 100,000 and cervical cancer 17 per 100,000 women<sup>2</sup>. While breast cancer incidence in East Java was ranked first in Indonesia<sup>3</sup>.

Cancer diagnosis and management are stressors that affect all aspects of a patient's life. Changes occur in the physical, psychological, social, and spiritual of the patient<sup>4</sup>. Diagnosis and treatment of breast cancer is the highest stress, and causes of psychosocial disorders. Breast cancer patients face uncertainty and fear of cancer diagnosis, management, and recovery. Individuals diagnosed with breast cancer generally face a variety of invasive medical procedures with many potential negative side effects (eg pain, nausea, vomiting, lymphedema, hair loss). High-stress levels can cause long-term negative effects on psychosocial breast cancer patients<sup>5</sup>. Other psychological reactions that commonly occur due to a diagnosis of breast cancer are distress,

---

### Corresponding Author:

**Agung Dwi Laksono**

National Institute of Health Research and Development,  
Indonesia Ministry of Health, Jakarta, Indonesia  
e-mail: agung.dwi.laksono-2016@fkm.unair.ac.id



shock, impaired self-concept, anxiety, depression, loss of control, helplessness, difficulty concentrating, despair, loss of zest for life. The psychological impact of breast cancer 80% causes the patient to distress, 16% feel close to death, 3% angry, and 1% can accept the condition<sup>6</sup>. The impact of breast cancer also results in physiological incapability, psychological disequilibrium, social relationship misbehavior, spiritual values disparity, and life of courage<sup>7</sup>. These changes will have an impact on the quality of life of breast cancer patients.

Breast cancer patients need coping mechanisms to adapt to changes due to breast cancer. The constructive coping mechanism is very influential on the attitude, response, decision making towards breast cancer management, and quality of life<sup>8</sup>. Identifying the factors that influence coping mechanisms is important. Some factors that influence coping mechanisms are age, sex, perception of disease, personality, and social and cultural conditions, spiritual needs, social support, and demographic factor<sup>8,9</sup>. Previous research found that the constructive coping mechanism is very influential on the quality of life of breast cancer patients. Identifying factors that influence the coping mechanism for breast cancer patients can provide specific interventions to overcome psychosocial problems that occur in breast cancer patients<sup>10</sup>. Based on the background description, the study aimed to determine the determinants of coping mechanisms of breast cancer patients at Sidoarjo Regency, Indonesia.

## Materials and Method

This study was an observational analytic study with a cross-sectional design. The study population was all patients who had been diagnosed with breast cancer by a doctor in Sidoarjo Regency. The number of samples was 98 patients with a diagnosis of breast cancer. The dependent variable is the coping mechanism, which consists of adaptive and maladaptive coping mechanisms. The independent variables are age group, educational level, marital status, work status, time diagnosed, the genetic, stadium of cancer, therapy, social support, and spiritual need. The final stage was analyzed multivariate with binary logistic regression.

Coping mechanisms are cognitive and behavioral changes that are constant to overcome certain internal or external demands that are tiring or exceed individual sources<sup>11</sup>. The coping mechanism can be described as handling related to problems and situations<sup>12</sup>. An

adaptive coping mechanism is a coping mechanism that supports the function of integration, growth, learning and achieving goals. Adaptive coping mechanisms include talking to others about the problem being faced to find alternative solutions, trying to find more information about the problem being faced, praying, doing physical exercises to reduce the tension of the problem, making various alternative actions to reduce the situation, and feel confident that all will return to stable, take lessons from past events or experiences. Maladaptive coping mechanisms are coping mechanisms that inhibit the function of integration, solve growth, reduce autonomy, and tend to control the environment. Maladaptive behavior includes aggressive behavior and withdrawal. physically and psychologically individuals consciously leave the environment that is the source of stressors such as individuals fleeing from sources of stress<sup>13</sup>.

Social support is any form of effort provided by others, close relatives, breast cancer patient peer groups in adapting to their illness, which includes emotional, judgment, information, instrumental. Emotional support is any effort given by family and closest people to breast cancer patients through feelings of care, attention, affection, and love, so that breast cancer patients feel comfortable. Appraisal support is any form of support carried out by family and loved ones through positive expressions, positive support for breast cancer patients. Information support is support from health workers and families to breast cancer patients through the provision of information about the disease so that patients understand the disease and its condition. Instrumental support is the support given by the family in the form of material to breast cancer patients.

Spiritual needs in sufferers of chronic diseases include relationships, peace, meaning/purpose, and transcendence, which can be related to the psychosocial, emotional, existential, and religious needs that underlie them. Spiritual needs are the need for trust, the need to express personal trust, the need to maintain the spiritual practice, and trust in God. Questionnaire to measure the spiritual needs of patients, using the Spiritual Needs Questionnaire<sup>14</sup>.

## Results and Discussion

Table 1 displays descriptive statistics of breast cancer patients in Sidoarjo Regency, Indonesia. Based on the age group, the two types of coping mechanisms are dominated by patients in the 46-55 age group. Based

on education level, breast cancer patients who are maladaptive in the coping mechanism are dominated by patients who have primary education, while breast cancer patients who are adaptive in the coping mechanism are dominated by patients who have higher education, secondary education. Based on marital status, the two types of coping mechanisms are dominated by married patients. Based on work status, both types of coping mechanisms are dominated by patients having work.

Based on time diagnosed, breast cancer patients who are maladaptive in the coping mechanism are dominated

by patients diagnosed for less than 1 year, while adaptive breast cancer patients in the coping mechanism are dominated by patients who are diagnosed for more than 1 year. Based on genetic variables, both types of coping mechanisms are dominated by patients who have breast cancer lineage. Based on therapy, breast cancer patients who are maladaptive in the coping mechanism are dominated by patients who have not done therapy, while breast cancer patients who are adaptive in the coping mechanism are dominated by patients who have finished doing therapy.

**Table 1. Descriptive statistics of the breast cancer patient in Sidoarjo Regency, Indonesia, 2019 (n=98)**

Variable	Coping Mechanism				P
	Maladaptive		Adaptive		
	n	%	n	%	
Age groups					0.468
<26	2	4.3%	1	1.9%	
26-35	5	10.9%	1	1.9%	
36-45	13	28.3%	17	32.7%	
46-55	16	34.8%	21	40.4%	
56-65	7	15.2%	10	19.2%	
>65	3	6.5%	2	3.8%	
Education					*0.011
No education	6	13.0%	1	1.9%	
Primary	21	45.7%	14	26.9%	
Secondary	14	30.4%	23	44.2%	
Higher	5	10.9%	14	26.9%	
Marital					0.900
Single	2	4.3%	2	3.8%	
Married	44	95.7%	50	96.2%	
Work status					0.528
Not work	30	65.2%	37	71.2%	
Work	16	34.8%	15	28.8%	
Time diagnosed					**0.001
≤1 year	27	58.7%	13	25.0%	
>1 year	19	41.3%	39	75.0%	
Genetik					0.907
No	20	43.5%	22	42.3%	
Yes	26	56.5%	30	57.7%	
Stadium					*0.019
≤2	22	47.8%	13	25.0%	

Variable	Coping Mechanism				P
	Maladaptive		Adaptive		
	n	%	n	%	
≥3	24	52.2%	39	75.0%	
Therapy					***<0.001
Not yet	22	47.8%	6	11.5%	
On progress	12	26.1%	11	21.2%	
Finished	12	26.1%	35	67.3%	
Social support					***<0.001
Low	23	50.0%	4	7.7%	
Medium	20	43.5%	26	50.0%	
High	3	6.5%	22	42.3%	
Spiritual needs					**0.007
Low	10	21.7%	2	3.8%	
Medium	20	43.5%	19	36.5%	
High	16	34.8%	31	59.6%	

Note: \*p <0.05; \*\*p <0.01; \*\*\*p <0.001.

Based on social support, breast cancer patients who are maladaptive in the coping mechanism are dominated by patients who have low social support, while breast cancer patients who are adaptive in the coping mechanism are dominated by patients who have social support medium. Based on spiritual needs, breast cancer patients who are maladaptive in the coping mechanism are dominated by patients who have spiritual needs medium category, while breast cancer patients who are adaptive in the coping mechanism are dominated by patients who have spiritual needs high category.

Table 2 shows the results of the binary logistic regression of coping mechanisms among breast cancer patients. Based on the level of education, it appears that breast cancer patients with higher education have 51.200 times chance compared to breast cancer patients with no education to have an adaptive coping mechanism (OR 51.200; 95% CI 1.575-1664.335). The results of this analysis inform us that the level of education has a positive influence on coping mechanisms that are adaptive for breast cancer patients.

**Tabel 2. The result of binary logistic regression of coping mechanism among breast cancer patient in Sidoarjo Regency, Indonesia, 2019 (n=98)**

Predictors	Sig.	Coping Mechanism		
		OR	LB	UB
Education: No education	-	-	-	-
Education: Primary	0.433	2.855	0.208	39.259
Education: Secondary	0.484	2.643	0.174	40.115
Education: Higher	*0.027	51.200	1.575	1664.335
Time diagnosed: ≤1 year	-	-	-	-
Time diagnosed: >1 year	0.060	6.737	0.920	49.317
Stadium: ≤2	-	-	-	-
Stadium: ≥3	0.228	3.067	0.496	18.952
Therapy: Not yet	-	-	-	-

Predictors	Sig.	Coping Mechanism		
		OR	LB	UB
Therapy: On progress	*0.022	12.467	1.429	108.736
Therapy: Finished	**0.006	14.958	2.213	101.105
Social support: Low	-	-	-	-
Social support: Medium	*0.016	7.561	1.469	38.916
Social support: High	***<0.001	225.419	14.154	3589.974
Spiritual needs: Low	-	-	-	-
Spiritual needs: Medium	0.919	1.128	0.109	11.706
Spiritual needs: High	0.349	3.119	0.289	33.636

Note: \*p<0.05; \*\*p<0.01; \*\*\*p<0.001.

The better level of education makes breast cancer patients more receptive to the conditions that are undergoing higher education are more likely to be able to adapt to breast cancer, this is possible because access to sources of information is easier to do. These results are consistent with research conducted in Iran showing that higher education is more likely to be able to adapt to breast cancer, this is possible because access to information sources is easier to do. This finding is in line with several previous studies in Norway proving that educational level was the most important contributor to social support, Educational was positively related to instrumental-oriented coping<sup>15</sup>. Previous studies have suggested that education are often found to have a positive impact on various programs in the health sector<sup>16-19</sup>.

The breast cancer patient who is undergoing therapy has a 12.467 times chance compared to breast cancer patients who have not undergone therapy to have an adaptive coping mechanism (OR 12.467; 95% CI 1.429-108.736). Breast cancer patients who have finished therapy have a 14.958 times chance compared to breast cancer patients who have not yet undergone therapy to have an adaptive coping mechanism (OR 14.958; 95% CI 2.213-101.105). The results of this analysis inform that therapy for breast cancer patients has a positive influence on adaptive coping mechanisms.

Therapy provides a calming effect for breast cancer patients. Breast cancer patients who have not been and are undergoing chemotherapy experience anxiety, depression, nausea, vomiting tend to ooze in their disorder. Breast cancer patients who have finished undergoing chemotherapy using coping mechanisms are more effective. The coping approach is mainly used by

patients who see their disease as a challenge. Behavioral and cognitive aspects of coping decrease with the level of difficulty experienced by individuals<sup>9</sup>.

Breast cancer patients who received medium category social support had a 7.561 chance compared to breast cancer patients who received low category social support to have an adaptive coping mechanism (OR 7.561; 95% CI 1.469-38.916). Breast cancer patients who received high category social support had 225.419 times the chance of breast cancer patients who received category low social support to have an adaptive coping mechanism (OR 225.419; 95% CI 14.154-3589.974). The results of this analysis inform that social support has a positive influence on breast cancer patients to have adaptive coping mechanisms. The higher the social support provided, the more adaptive the coping mechanism is for breast cancer patients' adaptive coping mechanism breast cancer patients.

This finding reinforces the findings of previous studies that took the same theme. Other studies show social support for breast cancer patients not only directly increases emotional well-being, but also indirectly influences emotional well-being by influencing coping strategies<sup>10</sup>. Research in Norway also shows that social support is considered an undeniable resource when dealing with difficult life situations. Social support was positively related to instrumental-oriented coping and emotion-focused coping<sup>15</sup>.

## Conclusions

Based on the results of the analysis found that 3 variables prove to be significant as determinants of coping mechanism among breast cancer patients in

Sidoarjo Regency, Indonesia. The three determinants are education level, therapy, and social support.

**Acknowledgments:** The author thanks to the scholarship provider, the Educational Fund Management Institute of the Republic of Indonesia through the Indonesian Flagship Scholarship in Indonesia (BUDI DN).

**Source of Funding:** Educational Fund Management Institute of the Republic of Indonesia through the Indonesian Flagship Scholarship in Indonesia (BUDI DN).

**Conflict of Interests:** Nil

**Ethical Clearance:** This study has been approved and passed the ethical test from the Faculty of Nursing, Airlangga University, Surabaya (No: 1255-KEPK). Respondents have provided written approval for their involvement in the study.

## References

1. Charles Swanton SRDJ. Handbook of Metastatic Breast Cancer. 2nd ed. Informa,Healthcare; 2011.
2. Globocan. 2012. No Title Estimated Cancer Incidence, Mortality,Prevalence and Disability-adjusted life years (DALYs) Worldwide in 2008. 2012;
3. Kemenkes RI, Informasi P data dan. Bulan Peduli Kanker Payudara\_2016.pdf. Jakarta; 2016.
4. Lesley Fallowfield AC. Breast cancer. Ray Fitzpatrick and Stanton Newman, editor. London and New York: This edition published in the Taylor & Francis e-Library, 2002.; 2002.
5. Luecken LJ, Compas BE. Stress, coping, and immune function in breast cancer. *Ann Behav Med.* 2002;24(4):336–44.
6. Shaheen G, Arshad M, Shamim T, Arshad S, Akram M, Yasmeeen Z. Study Design Breast cancer patients referred to BINO were eligible to take part in the study . Base line demographic information was obtained on age , diagnosis ; length of time since diagnosis and effects of treatment on physical and psychological health. 2011;(1):236–43.7. Nurachmah E. Dampak Kanker Payudara dan Pengobatannya Terhadap Aspek Biopsiko-spiritual Klien yang Berpartisipasi Dalam Kelompok Pendukung Elly Nurachmah. 1996;(c).
8. Sutarna FN, Celine E, Tancherla A, Nathania R, Putri H, Dharmaraja F, et al. The Association of Social Support and Coping Mechanisms in Breast Cancer Patients. *Ann Oncol.* 2019;30(October):vi147.
9. Cordella M, Poiani A. Behavioural Oncology. *Behavioural Oncology.* 2014.
10. Kim J, Han JY, Shaw B, McTavish F, Gustafson D. The roles of social support and coping strategies in predicting breast cancer patients' emotional well-being: testing mediation and moderation models. *J Health Psychol.* 2010 May;15(4):543–52.
11. Lazarus RS, Folkman S. Stress, appraisal and coping. New York: Springer Publishing Company New York; 1984.
12. Koziar EBS (2004). Fundamental of nursing: Concepts, process, and practice. Seventh Ed. New Jersey : Pearson Education. Inc.; 2004.
13. Stuart, G.W., and Laraia MT 2009., St. E, Book L: MY. Principles and practice of psychiatric nursing 9 Th. 9 th ed. St. Louis : Mosby Year Book; 2009.
14. Sharma RK, Astrow AB, Texeira K, Sulmasy DP. The spiritual needs assessment for patients (SNAP): Development and validation of a comprehensive instrument to assess unmet spiritual needs. *J Pain Symptom Manage.* 2012;44(1):44–51.
15. Drageset S, Lindstrøm TC. Coping with a possible breast cancer diagnosis: Demographic factors and social support. *J Adv Nurs.* 2005;51(3):217–26.
16. Wulandari RD, Laksono AD. Education as predictor of the knowledge of pregnancy danger signs in Rural Indonesia. *Int J Innov Creat Chang.* 2020;13(1):1037–51.
17. Wulandari RD, Laksono AD. Determinants of knowledge of pregnancy danger signs in Indonesia. *PLoS One.* 2020;15(5):Article number e0232550.
18. Rohmah N, Yusuf A, Hargono R, Laksono AD, Masruroh, Ibrahim I, et al. Determinants of teenage pregnancy in Indonesia. *Indian J Forensic Med Toxicol.* 2020;14(3):2080–5.
19. Ipa M, Widawati M, Laksono AD, Kusriani I, Dhewantara PW. Variation of preventive practices and its association with malaria infection in eastern Indonesia: Findings from community-based survey. *PLoS One.* 2020;15(5):e0232909.

# Application of Care Bundle Approach for Preventing Device Associated Infections: A Training Program for Pediatric and Neonatal Nurses

Amal M. Ibrahim<sup>1</sup>, Safy S. Al-Rafay<sup>2</sup>, Hyam R. Tantawi<sup>2</sup>

<sup>1</sup>Specialist Infection Control, Ain Shams University Specialized Hospital, Cairo, Egypt,

<sup>2</sup>Professor of Pediatric Nursing, Faculty of Nursing, Ain Shams University, Cairo, Egypt

## Abstract

**Background:** Care bundle implementation as a small set of evidence-based interventions together was used in this study for giving better outcomes for defined nurses; caring for pediatric and neonatal patients are faced with increased risks of the device-associated infections and life-threatening conditions during exposure to many invasive devices in intensive care units.

**Objective:** To assess the influence of the application of care bundle approach training program on pediatric and neonatal nurses for preventing device-associated infection.

**Methodology:** A quasi-experimental study was used. This study was conducted in pediatric and neonatal intensive care units at Ain Shams University Specialized Hospital (ASUSH) in Cairo. A convenient sample of 70 nurses were involved for data collection by two method; **First:** An interviewing questionnaire divided into two parts: Part 1. Nurses demographic data, Part 2. Assessment of nurses' knowledge. **Second:** Observation checklist for assessing nursing performance regarding the bundle of care.

**Results:** Less than one quarters (21.40%) of the studied nurses had satisfied knowledge preprogram intervention, compared with more than 85.70% of them has a satisfied post-program intervention regarding the level of total knowledge about the bundle of care; Also, 15.70% of the studied nurses had competent total performance regarding the bundle of care pre-program intervention compared with nearly 72.9% of them had a competent performance post-program intervention.

**Conclusion:** Application of training program reported remarkable improvement in pediatric and neonatal intensive care nurses' knowledge and performance toward the care bundle approach for preventing device-associated infection.

**Keywords:** *Pediatric and neonatal intensive care, bundle of care, Nurses performance.*

## Introduction

The pediatric and neonatal patients are faced with increased risks of the Device Associated Infections (DAIs) and life-threatening conditions because of the

low immunity to many pathogens, and exposure to many invasive devices, parenteral nutrition, prolonged hospitalization, and persistent processes in Intensive Care Unit (ICU) are among the risk factors associated with Hospital Acquired Infection (HAI)<sup>1</sup>. Compliance of pediatric nurses in pediatric and neonatal ICUs with the Standard Precautions (SPs) and the bundle of care an efficient means to prevent and control (DAIs)<sup>2</sup>. The main types of HAIs are DAIs, including the following: Ventilator-Associated Pneumonia (VAP), Central Line-Associated Bloodstream Infection (CLABSI), and Catheter-Associated Urinary Tract Infection (CAUTI)<sup>3</sup>.

---

### Corresponding Author:

**Amal M. Ibrahim**

Specialist Infection Control, Ain Shams University  
Specialized Hospital, Cairo, Egypt

e-mail: amal.ibrahim10@yahoo.com

Invasive devices in pediatric ICUs (PICUs) are the utmost common threat factors for HAI and applying the bundle strategy is recommended for the avoidance of invasive device-related infections. Prevention Control (PC) bundles have been implemented includes three to five key Infection Prevention Control (IPC) elements based on evidence or coming from well-accepted guidelines<sup>4</sup>. So, ICUs guidelines will review important considerations for infection prevention specifically for VAP, CLABSI, and CAUTI.

Bundles of care are practicable, are easy to implement and adhere to, and are effective in reducing the HAI rates constitutively across the world including developed and developing countries. Following evidence-based bundles that are tailor-made to suit the performance<sup>5</sup>.

Pediatric and neonatal nurses in ICUs are in the best position to apply evidence-based guidelines into the performance as they are at the pediatric patient's bedside 24 hours daily providing nursing care and therefore performs a vital role in the prevention of HAIs. Nevertheless, pediatric nurses need to have an awareness of the problem as well as knowledge on current research evidence to adhere to such practices lack of knowledge<sup>6</sup>.

In Egypt, Device Associated Infections (DAIs) was 24.5% per 1,000 ICU-days. (VAP) rate was 15.8/1,000 ventilator days, (CLABSI) rate was 6.8/1,000 central line days, and (CAUTI) rate was 6.3/1,000 urinary catheter days in different developing countries<sup>7</sup>. These infections are potentially preventable and can be reduced through implementing care bundles. Bundles are sets of evidence-based interventions, which are designed to improve pediatric patient's health and prevent complications from (DAIs)<sup>8</sup>. Bundles of care are commonly practical tools in ICUs consist of three to a maximum of six evidence-based 'elements,' for patients in the health care setting. The elements should be practical together to all pediatric and neonatal patients. The power of bundling is to confirm that all elements function together in every pediatric patient to advance pediatric patient health outcomes<sup>9</sup>.

**Aim of the Study:** This study aimed to assess the influence of the application of care bundle approach training program on pediatric and neonatal nurses for preventing device-associated infection

## Methodology

**Design of Study:** A quasi-experimental design was

used to achieve the aim of this study. The study was conducted in pediatric and neonatal ICUs (PICU and NICU) at Ain Shams University Specialized Hospital (ASUSH) in Cairo, Egypt. The PICU unit consists of four units (unit zero, one, two, and three). Unit zero consists from two beds for hemodialysis patients, unit one consists of four beds for post-operative cardiac surgery, unit two consists from four beds, and unit three divided by glass partition into two parts and each part consists of five beds, the total beds in the two units is 20 beds. The NICU consists of one unit divided by glass partition into two parts, and closed room equipped by one incubator for isolation cases, the total incubators in the unit are fifteen incubators one of them is portable. Additionally, both units (PICU and NICU) are equipped with separate ventilator and monitor for each incubator or bed.

**Sampling:** A convenient sample of all available nurses (70 nurses) from the above-mentioned settings regardless their educational levels, or years of experience, over a period of 6 months. Forty-five nurses from the PICU and 35 nurses were from the NICU.

**Tools for data collection:** After reviewing of the recent related literatures was adapted from *De Neef et al. (2019)*, *Holzmann (2019)*, *Mack et al. (2017)*, *The Egyptian Ministry of Health and Population (2016)*<sup>(10,11,12,13)</sup>. and it include two tools were used for data collection as follows:

**First tool: An interviewing questionnaire:** It was designed by the researchers. This tool was written in Arabic language and divided into two parts.

**Part 1:** Nurses' characteristics such as: Age, gender, qualification, years of experience, and training of bundle of care for preventing DAIs.

**Part 2:** Nurses knowledge assessment about DAIs bundle of care pre/post -test:

This part was completed by nurses before and after the program implementation, it was comprised of (51) questions distributed on:

**Knowledge about HAI:** (6) questions concerned with: Definition of HAI, types of microbes, causes of HAI, modes of infection, the effect of premature patient on HAI, and component of the chain of infection.

**Knowledge about SPs:** (13 questions) related to: Definition of SPs, measures of SPs, hand hygiene

(types of hand hygiene, types of hand hygiene in case of diarrhea, indication of hand hygiene, required time), and PPE (types in hospital and insertion of a urinary catheter).

### **Knowledge about bundles of care:**

- (A):** Knowledge about bundle of care to prevent (VAP) (13 questions) related to: Definition of VAP, angle of the elevated head of bed, oral care, the purpose of elevating the head of bed, changing of air vent humidifier, filling of a humidifier, importance of preventing of deep thrombosis in the legs, indication of uses of peptic ulcer drugs, changing of ventilator circuits, emptying suction bottle, using of much sedative drugs and using of saline solution for the suction.
- (B):** Knowledge about bundle of care to prevent (CLABSI) (8 questions) related to: Definition of CLABSI time of changing transparent dressing and disinfectant of skin prior insertion for less and more than 1000 grams, changing the line system, changing sterile gauze, disinfect the access port and changing the line system in case of changing the solution.
- (C):** Knowledge about bundle of care to prevent (CAUTI) (11 questions) related to: Component of CAUTI bundle, definition of (CAUTI), symptoms of urinary tract infection, indication of secured urinary catheter, method of urinal disinfectant, caring of pubic area, placing of the urinary bag, relation of rate of urinary tract infection and urinary catheter, irrigation of urinary catheter in case of obstruction and importance of antibiotic ointment.

**Scoring System:** Nurses' knowledge assessment was scored according to the key answer as follows: A correct answer scored as one and an incorrect answer scored zero. These scores were converted into a percentage score. Scores of all questions (50 points) were summed up and accordingly the total scoring was categorized into:

**Unsatisfactory knowledge (<75%).**

**Satisfactory knowledge (≥ 75%).**

**Second Tool:** Observation checklists pre/post-program intervention:

This tool was used with permission from the director of each pediatric and neonatal ICUs for assessing nursing performance regarding the bundle of care according to standers of checklists. Observational checklists covered the following 5 procedures:

1. Ventilator Associated Pneumonia (VAP) (6) items.
2. Central Line Associated Blood Stream Infection (CLABSI) (6) items.
3. Catheter Associated Urinary Tract Infection (CAUTI) (6) items.
4. Hand hygiene (10) items.
5. Personal protective equipment.

**Scoring System:** Each step of a procedure was scored according to the weighing of this step that makes a total score (33 items equal 100%). If any item was done correctly, getting one score while zero score was allotted to the wrong or not done step.

The total scoring system of nurses' performance was classified into:

**“Competent”** was considered for  $\geq 80\%$  and above.

**“Incompetent”** were considered for  $< 80\%$ .

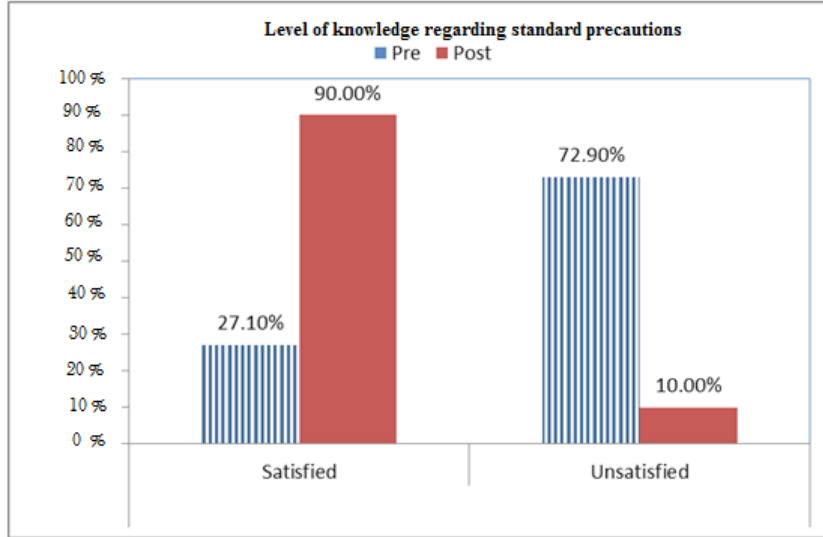
## **Results**

A total of 70 nurses (Forty- five nurses from the PICU and 35 nurses were from the NICU) were enrolled at this study.

**Part (1): Demographic characteristics of the studied nurses:** The mean age and SD of the studied nursing staff age was  $30.19 \pm 6.34$ , and the majority of them (91.4%) were females. It was found that 35.7% of them were a technical institute, and 38.6% have  $\geq 10$  years of experience. Also, less than one third of them (32.9%) attended a training program on the bundle of care.

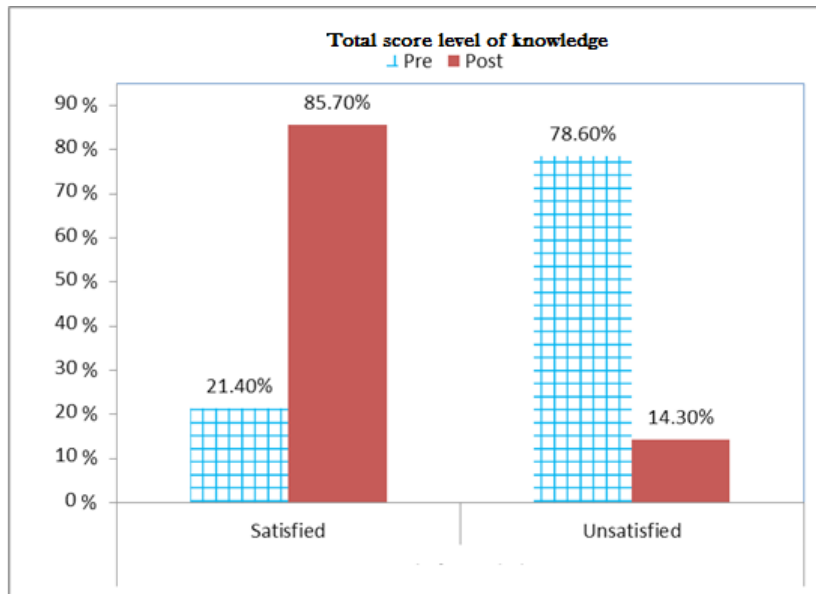


**Part II: Knowledge of the studied nurses about bundle of care.**



**Figure (1): Distribution of the studied nurses according to their knowledge regarding Standard Precautions (SPs) (N=70).**

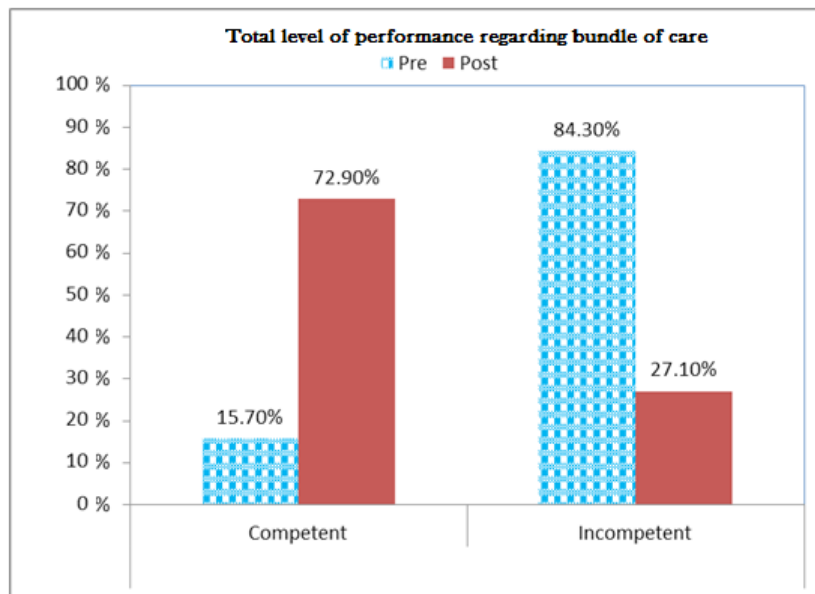
Less than one third of the studied nurse (27.10%) had satisfied knowledge regarding SPs preprogram intervention when compared with the majority (90%) of them had satisfactory knowledge post program intervention. This reflects a statistically significant difference between pre and post application of SPs (p-value <0.001).



**Figure (2): Distribution of the studied nurses' according to their level of knowledge about bundle of care pre post program intervention (N=70).**

Less than one quarters (21.40%) of the studied nurses had satisfied knowledge preprogram intervention, compared with more than three fourths (85.70%) of them has a satisfied post program intervention regarding the level of total knowledge about the bundle of care. Also, there was a statistically significant difference between pre and post regarding level of total knowledge about bundle of care (p-value <0.001).

**Part III: Practice of the studied nurses about bundle of care.**



**Figure (3): Distribution of the studied nurses according to their total performance regarding bundle of care Pre/post program intervention (N=70).**

One quarter (15.70%) of the studied nurses had competent total level of performance regarding bundle of care preprogram intervention compared with nearly three quarters (72.9%) of them had a competent performance post program intervention, there was a statistically significant difference between pre and post -program intervention regarding nurses levels of performance (p-value <0.001).

**Part IV: Relation between the studied variables:**  
The studied nurses’ total level of knowledge and their demographic data, namely educational level, years of experience, and training courses were statistically significant with p-value (p<0.05).

There were statistically significant relations between the studied nurse’s total level of performance about the bundle of care and their demographic data namely educational level, years of experience, and training courses, with p-value (p<0.05).

**Table (1): Relation between nurses’ level of knowledge and level of performance pre/ post program (N=70)**

	Level of performance	Level of Knowledge				Total		Chi-square test	
		Satisfied		Unsatisfied		No.	%	$\chi^2$	p-value
		No.	%	No.	%				
Pre intervention	Competent	11	73.3%	0	0.0%	11	15.7%	47.853	<0.001**
	Incompetent	4	26.7%	55	100.0%	59	84.3%		
	<b>Total</b>	<b>15</b>	<b>100.0%</b>	<b>55</b>	<b>100.0%</b>	<b>70</b>	<b>100.0%</b>		
Post intervention	Competent	51	85.0%	0	0.0%	51	72.9%	31.316	<0.001**
	Incompetent	9	15.0%	10	100.0%	19	27.1%		
	<b>Total</b>	<b>60</b>	<b>100.0%</b>	<b>10</b>	<b>100.0%</b>	<b>70</b>	<b>100.0%</b>		

\*\*p-value <0.001 HS

The studied nurses’ level of knowledge pre and post level of performance were highly statistically significant (p<0.001).

**Table (2): Correlation between the total score of knowledge and total score of performance pre / post program intervention (N=70).**

Total score of performance	Total score of Knowledge	
	Rs	p-value
Pre	0.481	<0.001**
Post	0.625	<0.001**

\*\*p-value <0.001 HS

There is a positive correlation and significant relation between total score of knowledge and their total score of performance regarding bundle of care pre-program and post-program intervention with (p-value<0.001).

### Discussion

Pediatric intensive care unit patients develop life-threatening (HAIs) more frequently than other old patients due to their acute illness and invasive device procedures. So, device-associated infections remain a major issue of pediatric patient health safety and outcomes<sup>14</sup>. A care bundle is defined as a group of evidence-based interventions related to a specific condition when applied together significantly improves pediatric patient outcomes. And prevent DAIs in pediatric and neonatal intensive care units<sup>15</sup>.

The finding of study nurses was in the age group  $\geq 35$  years and more with the mean age and SD of the studied nursing age was 30.19, SD  $\pm 6.34$ . These findings were not supported by **Eskander et al.(2013)**<sup>16</sup>. Also, our study revealed that more than one-third of them were technical institute. These findings are not supported by **Mohammed (2016)**<sup>17</sup>. This may be due to the presence of a technical nursing institute among the hospital and the most of nursing working in the hospital graduated from it. Additionally, our study revealed that more than one-third of them have  $\geq 10$  years' experience. These findings are not supported by **Abolwafa et al.(2013)**<sup>18</sup> due to most of the studied nursing age more than 35 years and working in ICU since graduation. Regarding the training program, less than one -third of them attended a training program on the bundle of care. This goes in the same line with **Ebied (2011)**<sup>19</sup>.

Concerning gender, the current study demonstrated the dominance of females than males which in agreement with **Atalla et al.(2016)**<sup>20</sup>, this result may be due to female were the majority of nursing staff in this hospital and also no male nurses were working in the NICU.

Regarding nurses total knowledge about SPs, the current study revealed that less than one- third of the studied nurse had satisfied knowledge regarding SPs preprogram intervention when compared with the majority of them had satisfactory knowledge post-program intervention statistically significant difference between pre and post regarding level of knowledge on the application of SPs (p-value <0.001).This results in the same line with **Mahmoud et al. (2020)**<sup>21</sup>. Indeed, our study showed less than one- quarters of the studied nurses had satisfied knowledge preprogram intervention, improved to more than three- fourths of them post -program intervention This finding is consistent with **Sodhi, (2013)**<sup>22</sup>. Which agreed with our opinion that suggests that the knowledge of the studied nurses increased due to effective program and the availability of handbooks.

According to the total level of performance of the studied nurses, the present study showed that the education program was successful in updating and enhancing their total performance regarding bundle of care to prevent DAI in PICU and NICU. In addition, this study showed that one quarter of the studied nurses had a competent total level of performance regarding bundle of care preprogram intervention compared to nearly three quarters of them post- program intervention. Also, there was a statistically significant difference between pre- and post- program intervention regarding level of performance (p-value <0.001). This finding was supported by **Ceballos et al.(2013)**<sup>23</sup>.

The present study showed that there were significant relations between the studied nurse's total level of knowledge and their demographic data, namely educational level, years of experience, and training courses, with p-value (p<0.05) which was in the same line with **Chen et al. (2011)** and **Prasanna (2015)**<sup>(24,25)</sup>, on the other hand it is contradicted with **Mukakamanzi (2017)**<sup>26</sup>, who found no significant relation between nurses' knowledge or performance and training on infection control. Also, a significant relation between (qualification) level of education and nurses' level of performance was proven in agreement with a study conducted by **Esposito et al.(2017)**<sup>27</sup>.As regards nurses' knowledge and their level of performance regarding bundle of care, there were highly statistically significant relations (p<0.001). This result in accordance with a study conducted by **El Sayed Ghonemy et al.(2018)**<sup>28</sup>. The researcher opinion suggests that, as the pediatric nurses' knowledge rises up, their performance increase.

Finally, In Egypt; there is a shortage of nursing staff and professionals. So, knowledgeable nurses are considerably important and required to make perfect performance in pediatric and neonatal care and diminish the hazards of HAI<sup>(29,30)</sup>. Indeed, Nurses must perform all appropriate preventative evidence-based practice interventions as presented in multiple bundles of care guidelines in order to do these roles, nurses must be well educated on the preventative strategies and be able to translate that knowledge into performance.

### Conclusion

Based on the results of the present study, there is a positive correlation and significant relation between the total score of knowledge and their total score performance regarding bundle of care pre and post program intervention. In conclusion, the educational training program reported remarkable improvement in pediatric and neonatal nurse's knowledge and performance toward a bundle of care.

**Acknowledgements:** We greatly appreciated the help of Dr. Eslam Adly from Faculty of Science, Ain Shams University, Egypt, for kindly help and advice.

### References

- 1 Ibrahim MFM, Mohamed HA, Abdelfattah M, ElTatawy SS. Device associated infections among neonates in neonatal intensive care units: a single unit survey study in Cairo, Egypt. *International Journal of Contemporary Pediatrics*, 2020; 7(4), 739.
- 2 Sun Y, Bao Z, Guo Y, Yuan X. Positive effect of care bundles on patients with central venous catheter insertions at a tertiary hospital in Beijing, China. *Journal of International Medical Research*, 2020; 48(7), 0300060520942113.
- 3 Huis A, Schouten J, Lescure D, Krein S, Ratz D, Saint S, Greene MT. Infection prevention practices in the Netherlands: results from a National Survey. *Antimicrobial Resistance & Infection Control*, 2020; 9(1), 1-7.
- 4 Alp E, Cookson B, Erdem H, Rello J, Akhvlediani T, Akkoyunlu Y, Candevir-Ulu A. Infection control bundles in intensive care: an international cross-sectional survey in low-and middle-income countries. *Journal of Hospital Infection*, 2019; 101(3), 248-256.
- 5 Divatia JV, Pulinilkunnathil JG, Myatra SN. Nosocomial Infections and Ventilator-Associated Pneumonia in Cancer Patients. *Oncologic Critical Care*, 2020; 1419-1439.
- 6 Gomes VP. Knowledge of intensive care nurses on evidence-based guidelines for prevention of ventilator associated pneumonia (Doctoral dissertation), 2010.
- 7 Hassan R, El-Gilany AH, El-Mashad N. Device-associated infection rates in different intensive care units in a tertiary care hospital in Egypt. *American Journal of Preventive Medicine*, 2019; 4(1), 1-7.
- 8 Dehghanrad F, Nobakht-e-Ghalati Z, Zand F, Gholamzadeh S, Ghorbani M, Rosenthal V. Effect of instruction and implementation of a preventive urinary tract infection bundle on the incidence of catheter associated urinary tract infection in intensive care unit patients. *Electronic Journal of General Medicine*, 2019; 16(2).
- 9 Resar R, Griffin FA, Haraden C. Using Care Bundles to Improve Health Care Quality. IHI Innovation Series White Paper. 2012 Cambridge, MA. Institute for Healthcare Improvement. Available at: <http://www.ihorg/resources/Pages/IHIWhitePapers/UsingCareBundles.aspx>. Accessed 2017; November, 15.
- 10 De Neef M, Bakker L, Dijkstra S, Raymakers-Janssen P, Vileito A, Ista E. Effectiveness of a Ventilator Care Bundle to Prevent Ventilator-Associated Pneumonia at the PICU: A Systematic Review and Meta-Analysis. *Pediatric Critical Care Medicine*; 2019; 20(5):474-80.
- 11 Holzmann-Pazgal G. Central Line-Associated Blood-Stream Infection (CLABSI). In *Healthcare-Associated Infections in Children*, 2019; (pp. 95-106). Springer, Cham.
- 12 Mack EH, Stem CT. Prevention of CAUTIs, CLABSIs, and VAPs in Children. *Current Treatment Options in Pediatrics*, 2017; 3(3), 221-235.
- 13 The Egyptian Ministry of Health and Population. National guidelines for infection control part 1. Cairo: MOHP, 2016; 1-229 p
- 14 Stoclin A, Rotolo F, Hicheri Y, Mons M, Chachaty E, Gachot B, Blot F. Ventilator-associated pneumonia and bloodstream infections in intensive care unit cancer patients: a retrospective 12-year study on 3388 prospectively monitored patients. *Supportive Care in Cancer*, 2020; 28(1), 193-200.

- 15 Gamage RJ. Audit on compliance of ventilator associated pneumonia care bundle in Intensive Care units in National Hospital Sri Lanka. *Sri Lankan Journal of Anaesthesiology*, 2019; 27(1)‡
- 16 Eskander HG, Morsy WY, Elfeky HA. Intensive care nurses knowledge & practices regarding infection control standard precautions at a selected Egyptian Cancer Hospital. *Prevention*, 2013; 4(19), 160-174‡
- 17 Mohammed SA. Nursing Guidelines and Its Effects on Nurses' Knowledge and Patient Safety Regarding Nosocomial Infection Control Measures in Burn Unit. *IOSR Journal of Nursing and Health Science*, 2016; 5(05), 06-16‡
- 18 Abolwafa NF, Ouda WE, Mohammed FZ, Masoed ES. Developing educational program for nurses related to infection control of invasive procedures in neonatal units at EL-Minia University and General Hospitals. *Journal of American Science*, 2013; 9(10), 286-293‡
- 19 Ebied E. Impact of blood-borne diseases prevention program on compliance with infection control standard precautions among nurses in family health centers, El Fayoum Governorate, Egypt. 2011.
- 20 Atalla HR, Aboalizm SE, Shaban HA. Effect of nursing guidelines compliance to infection control among nursing student. *J Nurs Health Sci*, 2016; 5(1), 23-34‡
- 21 Mahmoud EAEN, EL-shafie OAEG, Abdel-Aziz MA. Effect of Educational Program for Nurses Performance Regarding Infection Control Precautions, toward patient on Mechanical Ventilation. *Assiut Scientific Nursing Journal*, 2020; 8(20), 94-104‡
- 22 Sodhi K, Shrivastava A, Arya M, Kumar M. Knowledge of infection control practices among intensive care nurses in a tertiary care hospital. *Journal of infection and public health*, 2013; 6(4), 269-275‡
- 23 Ceballos K, Waterman K, Hulett T, Flynn Makic MB. Nurse-driven quality improvement interventions to reduce hospital-acquired infection in the NICU. *Advances in Neonatal Care*, 2013; 13(3), 154– 163. <https://doi.org/10.1097/ANC.0b013e318285fe70> .
- 24 Chen S, Yao J, Chen J, Liu L, Miu A, Jiang Y, Chen Y. Knowledge of “guidelines for the prevention of intravascular catheter-related infections (2011)”: A survey of intensive care unit nursing staffs in china. *International Journal of Nursing Sciences*, 2015; 2(4), 383-388.
- 25 Prasanna K, Radhika M. Knowledge regarding catheter care among staff nurses. *International Journal of Applied Research*, 2015; 1(8): 182-186‡
- 26 Mukakamanzi J. Knowledge, attitude and practices of nurses towards the prevention of catheter-associated urinary tract infection in selected Referral Hospitals in Rwanda, 2017; (Doctoral dissertation, University of Rwanda)‡
- 27 Esposito MR, Guillari A, Angelillo IF. Knowledge, attitudes, and practice on the prevention of central line-associated bloodstream infections among nurses in oncological care: A cross-sectional study in an area of southern Italy. *PLoS One*, 2017; 12(6): 1-11.
- 28 El Sayed Ghonemy S, Salah Eldin Al Rafey S, Amin Mohammed E, El Sayed Hassan S. Instructional Module for Nurses regarding Care of Children with Hemophilia. *Egyptian Journal of Health Care*, 2018; 9(3), 163-174.
- 29 Braun SE. The Effects of Staff Education on Ventilator-Associated Pneumonia in the Intensive Care Unit: A Literature Review. 2019; *MMWR* 2011; 60:182.
- 30 Zed SAFA, Mohammed AA. Impact of nursing guidelines on nurses' knowledge and performance regarding to prevention of ventilator associated pneumonia in neonates. *Journal of Nursing Education and Practice*, 2019; 9(10).

# Effects of Modified-Continuous Ambulatory Peritoneal Dialysis (CAPD) Patient's Handling Process on Nurse's Knowledge, Perceived Benefits and Performance in CAPD Care

Prichavijij Promjak<sup>1</sup>, Samlee Plianbangchan<sup>2</sup>, Ratana Somrongthong<sup>3</sup>, Wongs Laohasiriwong<sup>4</sup>

<sup>1</sup>Registered Nurse, Nan hospital, Ministry of Public Health, Thailand, <sup>2</sup>Distinguished scholar, College of Public Health Sciences, Chulalongkorn University, Thailand, <sup>3</sup>Associate Professor, College of Public Health Sciences, Chulalongkorn University, Thailand, <sup>4</sup>Associate Professor, Faculty of Public Health, Khon Kaen University, Thailand

## Abstract

Continuous Ambulatory Peritoneal Dialysis (CAPD) is one of kidney replacement therapy with advantage of home therapy and much cheaper than hemodialysis. Nevertheless, CAPD patients need integrated health care by primary care health facilities to maintain CAPD effectiveness of which has never been assessed and improved. Therefore, this study aims to assess the effect of modified CAPD patient's handling process among nurses at the primary care level. This quasi-experimental study, 47 nurses in sub-district health promoting hospitals (HPHs) of Nan general hospital renal node which completed the standard protocol were assigned to an experimental group, which received the modified-continuous ambulatory peritoneal dialysis (CAPD) patient's handling process intervention. The intervention covered both a case management (CM) and a CAPD web-based program. The comparative groups were 45 nurses in sub-district health promoting hospitals of Pua Crown Prince Hospital renal node. The main outcomes were improvement in knowledge, perceived benefits and CAPD patients care performances of which assessed by t-test, and ANCOVA. There were significant higher scores of knowledge, perceived benefits and performances of nurses in the experimental group applying the "Modified CAPD patient's handling process" than those of the comparative group. Therefore, this intervention should be implemented in other primary care facilities to improve qualities of care for CAPD patients.

**Keywords:** *Continuous Ambulatory Peritoneal Dialysis, CAPD, Nurses Case Management, web-based program.*

## Introduction

End-stage renal disease (ESRD) is a chronic illness which is the most crisis and most expensive stage of chronic kidney disease (CKD). ESRD requires renal replacement therapies including hemodialysis (HD), peritoneal dialysis (PD) and kidney transplantation (KT) treatment modalities<sup>1</sup>. The renal replacement therapies (RRT) are expensive therapy, accounting for 1–2 percent of healthcare spending especially in high-income countries with the rising incidence and prevalence of end-stage renal disease (ESRD) modalities treatment<sup>2</sup>. Dialysis modality consisting of HD and PD is one of the most expensive available therapies for ESRD treatment. Hence, the cost of health care is borne by healthcare funder, individual patient and/or their family, making

chronic illness a cause as well as a consequence of poverty by household's health expenditure<sup>3</sup> especially among patients with chronic conditions because the health care delivered in a hospital is the costliest aspect of this therapy. Hence, the argument for this approach extends beyond immediately financial benefits to the desire to promote patients' empowerment and autonomy. In most chronic diseases, a component of self-care is essential to use the cost-effectiveness of therapy and the best clinical outcomes<sup>4</sup>. At present with the advantage of home therapy for PD which is less costly than hemodialysis, many governments are encouraging the provision of PD treatment in the community and promoting home dialysis<sup>5</sup>. For frail, elderly patients, the cost of thrice-weekly transport to and from a dialysis facility can be

the most expensive component of their care. Also, the delivery of dialysis in the home environment can create a more favorable ‘traveling time’ versus ‘treatment time’ or patient’s quality of life trade-off<sup>6,7</sup>. Several research method including a literature review on the CAPD patients on the societal perspective, life-long costs of PD and quality of life reveal that: on societal perspective, PD had a higher cost-effective and cost-utility than HD for all age groups of Thai ESRD patients and treatments provided to younger age groups of ESRD patients with better outcomes and higher cost-effective and cost-utility than those offered to the elderly patients. Therefore, PD is more cost-effective for the Thai government to invest in the economic point of view, societal perspectives such as human rights, equity in health, and humanity concern<sup>8</sup>.

Nan province located in the North of Thailand has the main challenges of chronic NCDs especially CKD which was the 4th cause of death of 38.09 per 100,000 population, which was higher than average cause of death with chronic renal disease of the North (average of 27.83 per 100,000 population). In addition, Nan has an increasing trend of ESRD with increased cases of HD and PD from 398 cases in 2010 to 1,488 cases in 2015. Peritoneal dialysis modality in Nan province after the first case in 2009 was increased to 653 cases in 2016 under two renal nodes of dialysis provision in Nan province including Nan general hospital renal node and Pua Crown Prince hospital renal node. The potential advantage of peritoneal dialysis is the home therapy which promotes patient autonomy with less traveling costs for patients than with in-center hemodialysis. However, patients with end-stage renal failure (ESRF) face lifelong physical, psychological and social problems related to their illnesses and treatments. This chronic and irreversible failure of kidney function poses a challenge to nurses and practitioners of related disciplines in the healthcare system at all levels. Dialysis is the major treatment modality to sustain the lives of patients waiting for kidney transplantation. Although the treatment can prolong life expectancy, it impacts the patient’s physical, psychological, and social well-being and may impose a considerable burden on patients and families especially the continuous ambulatory peritoneal dialysis (CAPD) which required advance and holistic care by multi-disciplinary teams at all levels for integrated care with various approaches, including patient empowerment, education and counseling sessions, and involvement of family members. CAPD nodes in tertiary and secondary

care hospitals have been suggested for improving treatment adherence and outcomes by manager of patient care in community. The previous study was not covered the case management of CAPD care by nurses in the primary care units. In addition, there were few studies that evaluated the effect of case management in CAPD care in renal node hospital only.

The purpose of this study was to examine the effects of modified-continuous ambulatory peritoneal dialysis (CAPD) patient’s handling process implement in primary care level by community nurse case management and web-based program that was increased the knowledge, perceived benefits and performance on CAPD care of nurses in a primary care unit (sub-district health promoting hospital) and improved patient care in the long run.

## Materials and Method

The quasi-experimental research aimed to implement and assess the effectiveness of the modified-continuous ambulatory peritoneal dialysis (CAPD) patient’s handling process in the primary care unit (sub-district health promoting hospital). This CAPD patient’s handling process program was based on case management (CM) and integrated with CAPD web-based program. There were two study renal nodes in Nan province including the Nan general hospital renal node and the Pua Crown Prince hospital renal node. They were allocated as an experimental and comparison groups. Additionally, all the sub-district health promoting hospitals were recruited as research setting with the inclusion criteria of 1) providing care for CAPD patients in the community, 2) access to internet. Consequently, nurses in those sub-district health promoting hospitals were recruited as the participants of this research. 47 nurses of 8 sub-district health promoting hospitals of Nan general hospital who met inclusion criteria were sequentially allocated to the experimental group, whereas 45 nurses in 7 sub-district health promoting hospitals of the Pua Crown Prince hospital renal node who met the inclusion criteria were allocated to the comparison group.

This study conducted for 18 months. There were three steps including: the first step was the model development based on context of the patients and health facilities, GAP analysis, and systems analysis on CAPD care in the primary care unit. This phase was aimed to develop a new program on CAPD patient’s handling process based on case management (CM) with integrated web-based

program. The second step was the formulation and did pretest of both experimental and control groups. The implementation of the modified-continuous ambulatory peritoneal dialysis (CAPD) patient's handling process was applied among nurses in 8 sub-district health promoting hospital of Nan general hospital renal node. The third step was to assess the effectiveness of the implemented program of (CAPD) patient's handling process among nurses in the intervention group and compared with the control group which were nurses in 7 sub-district health promoting hospital in the Pua Crown Prince renal node. The research main outcomes were knowledge, perceived benefits and the performance on CAPD care of nurses at the primary care level.

**Intervention:** A comprehensive intervention protocol was developed by the researcher and reviewed by nephrologists and experienced renal nurses in Nan general hospital renal node, with further revisions according to their advice. These Modified-CAPD patient's handling process intervention protocol was design covering patient's assessment, nursing care planning, communication, advocacy and health education, health resource management, and service facilitation by the collaboration of multidisciplinary team by Care-map and Clinical Practice Guideline (CPG), and added-up with Web-based program for patient's information and monitoring of CAPD care among hospital renal node and sub-district health promoting hospitals.

The patients in the experimental group received the CAPD standard care and our comprehensive CAPD cares. The clinical practice guideline of CAPD care was the research protocol for nurses in primary care unit as well as a comprehensive assessment of the patient's physical, social, cognitive and emotional needs based on the clinical practice guideline. An individualized education program was conducted by the case manager nurse covering exercise regimen, medication, fluid and diet adherence behaviors, technical procedures for home peritoneal dialysis and prevention of infection. The case manager nurses received a 12-hour training program which included a theoretical input, case training, and web-based program. The nurse set scheduled for home visits and used their professional judgment to define the frequency, intensity, and focus of contacts to meet patient's and caregiver's needs and did follow up the patients for care and assess the patient's progress. If a CAPD patient was at risk of unstable conditions, a referral to the main renal node will be done for proper assessment, investigation, and medical treatment. If

needed lastly, referral to the emergency department for urgent treatment was the next step.

The web-based program which links information of CAPD patient was introduced for patient's care plan among main hospital renal node, community hospital, and primary care unit for CAPD care. This web-based program provided a physical assessment of medical information which linked between main renal node and primary care unit procedure treatment, effective care and monitoring. Both comparison and experimental groups, patients received the same routine care during hospitalization. This modified-continuous ambulatory peritoneal dialysis (CAPD) patient's handling process in the primary care unit intervention were an advanced health care technology program combined with diminishing resources for an increased demand for qualified nurse case managers in primary care level who can manage complex cases for the best interests of the CAPD patients that could save time, money, improved quality of life and treatment outcomes of the patients.

**Data collection and measurement tools:** Measurement tools of CAPD care among nurses were questionnaires to assess knowledge, perceived benefits of CAPD care. The questionnaire consisted of two parts. The first part was the participant demographic and socioeconomic information including age, gender, and education level. The second part was knowledge and perceived benefits of CAPD. The performance of CAPD care was assessed by a check list questionnaire which assess the medical record and health service program in each sub-district health promoting hospital.

All of assessment tools were developed by the researcher. The analysis of Item-objective congruence index (IOC) was conducted for content validity of the questionnaire and was revised based on the expert's recommendation. The reliability was tested among 30 participants who had similar characteristics with the study population at the primary care level. The Cronbach alpha coefficient of the questionnaire was 0.86 scores.

**Data Analysis:** The Chi-square test was used to compare the differences in demographic data (Category variable) between experimental and comparison groups. The t-test was utilized to compare the difference of the sum of knowledge score, perception, and performance of CAPD care. In addition, the ANCOVA was used to assess the effectiveness of the CAPD handling process program covering baseline and post-intervention



period while the statistically significant ( $p < .05$ ) were considered significant.

**Ethical Consideration:** This research was approved by the Chulalongkorn University's Ethics Review Board. The certificate of approval number was COA. No.096.1/59 Additionally, office of Nan Provincial Public Health also has permission for this study in Nan province and also all study participants were signed informed consent forms before data collection and implementation of the intervention. The information in these studies were analyzed, synthesized and presented for academics only.

## Results

A total of 92 nurses were included in the analysis, 47 among the experiment and 45 among the comparison group. Among these participants, 94.57% were female. Their ages ranged from 25 to 56 years, with a mean of 43.34 years (S.D. 7.03) in experimental group whereas it was 40.71 years (S.D. 7.08) in the comparison group. Almost all of them finished bachelor's degree in nursing (95.74% among experimental and 95.56% among comparison groups. Only 4.26% in experiment and 4.44% in comparison groups graduated a master's degree in nursing. The personal characteristics of experimental and comparison groups including sex, age, marital status, education, official status, received community nursing training, and experience of work in community were comparable ( $p > 0.05$ ).

**Table 1 Socio-demographic characteristics of nurses in the experimental and the comparison groups at baseline**

Characteristics	Experimental Group 47 participants		Comparison Group 45 participants		t-test/ $\chi^2$	p value
	Number	(%)	Number	(%)		
Sex					4.868 <sup>a</sup>	0.181
Male	2	4.26	3	6.67		
Female	45	95.74	42	93.33		
<b>Age</b>						
30 and below	3	6.38	1	2.22		
31 – 40	13	27.66	22	48.89		
41 – 50	24	51.06	16	35.56		
51 - 60	7	14.89	6	13.33		
Mean (S.D.)	43.34 (7.03)		40.71 (7.08)		1.79 <sup>b</sup>	0.077
Median (Min, Max)	40 (30, 56)		44 (25, 56)			
<b>Marital Status</b>					1.352 <sup>a</sup>	0.857
Single	10	21.28	12	26.67		
Married	34	72.34	31	68.89		
Widowed	2	4.26	2	4.44		
Divorced	1	2.13	0	0.00		
Separate	0	0.00	0	0.00		
<b>Education</b>					0.002 <sup>a</sup>	0.965
Bachelor	45	95.74	43	95.56		
Master	2	4.26	2	4.44		
Ph.D.	0	0.00	0	0.00		
<b>Official Status</b>						
Government official	47	100.00	45	100.00		
<b>Certificated nursing training</b>						
Certificated trained	47	100.00	45	100.00		

Characteristics	Experimental Group 47 participants		Comparison Group 45 participants		t-test/ $\chi^2$	p value
	Number	(%)	Number	(%)		
<b>Experience of work</b>						
Less than 10 years	4	8.51	6	13.33		
11 – 20 years	17	36.17	23	51.11		
21 – 30 years	23	48.94	12	26.67		
More than 30 years	3	6.38	4	8.89		
Mean (S.D.)	21.34 (7.08)		18.71 (7.03)		1.787 <sup>b</sup>	0.077
Median (Min, Max)	22 (3, 34)		18 (8, 34)			
<b>Experience of work in HPH</b>						
Less than 5 years	1	2.13	0	.00		
6 – 10 years	5	10.64	9	20.00		
11 – 15 years	23	48.94	23	51.11		
16 – 20 years	16	34.04	6	13.33		
21 – 25 years	2	4.26	6	13.33		
26 – 30 years	0	.00	1	2.22		
More than 30 years	0	0.00	0	0.00		
Mean (S.D.)	14.49 (3.95)		14.56 (4.95)		0.071 <sup>b</sup>	0.943
Median (Min, Max)	15 (3, 23)		24 (8, 27)			

(a) = Chi square, (b) = independent t-test

**Knowledge of CAPD care Assessment:** The knowledge assessment covered PD exchange, steps for PD exchange, activity of CAPD patient, drugs use and health education for self-care of CAPD patient, home visit care and knowledge on drug use such as erythropoietin injection for anemia treatment from iron deficiency in chronic renal disease patients. The level of knowledge on CAPD care of the experimental and comparison groups at baseline, the highest proportion

of both groups was at average level (34.04% among experiment and 35.56% among comparison groups). However, after intervention, the level of on knowledge CAPD care in the experimental group were much more improved than the comparison group. All of the nurses in the experimental group had high level of knowledge whereas only 46.67 % of the comparison group had high level of knowledge, followed by 40.00 % with average level and 13.33 % had low level of knowledge (Table 2).

**Table 2 Level of knowledge on CAPD of experimental and comparison groups at baseline and after intervention**

Level of knowledge assessment on CAPD care	Baseline				After intervention			
	Experimental Group 47 participants		Comparison Group 45 participants		Experimental Group 47 participants		Comparison Group 45 participants	
	Number	(%)	Number	(%)	Number	(%)	Number	(%)
Low (<60 scores )	10	21.25	5	11.11	0	0.00	6	13.33
Average (60-79 scores)	21	44.68	24	53.33	0	0.00	18	40.00
High (≥ 80 scores)	16	34.04	16	35.56	47	100.00	21	46.67

**Perceived Benefits of CAPD care:** Baseline information of perceived benefits of CAPD care illustrated no significant difference between nurses in experimental and comparison groups. The highest proportion of perceived benefits of CAPD care at baseline was at fair level (40.43 % among experiment and 33.33% among comparison groups) followed by good perception on benefits (29.79 % and 28.89 among experimental and comparison groups) and similar

proportion had poor perceived benefits (29.79% in experiment and 37.78% in Control groups). However, after intervention, the perceived benefits of CAPD care in the experimental group was much higher, of which all the nurses in this group had good level of perceived benefits when compared with 55.56% of good level, and 44.44% of fair level in the control group respectively (Table 3).

**Table 3 Level of perceived benefits of CAPD care between experimental and comparison groups at baseline and after intervention**

Level of Perceived benefits of CAPD care	Baseline				After intervention			
	Experimental Group 47 participants		Comparison Group 45 participants		Experimental Group 47 participants		Comparison Group 45 participants	
	Number	(%)	Number	(%)	Number	(%)	Number	(%)
Poor (<60 scores)	14	29.79	17	37.78	0	0	0	0
Fair (60-79 scores)	19	40.43	15	33.33	0	0	20	44.44
Good (≥80 scores)	14	29.79	13	28.89	47	100.00	25	55.56

**Effect of the program on knowledge, perceived benefits of CAPD care and performance on CAPD care:** At baseline the level of knowledge on CAPD among comparison group was not significantly higher than that of the experimental group, whereas the perceived benefit score and performance of CAPD care among the experimental was non significantly higher than the comparison’s group. The model using ANCOVA with controlling for covariate variables including age of nurses, training in nursing and duration of working experience in sub-district health promoting hospital between the experimental and comparison groups at baseline and post intervention (4 months after

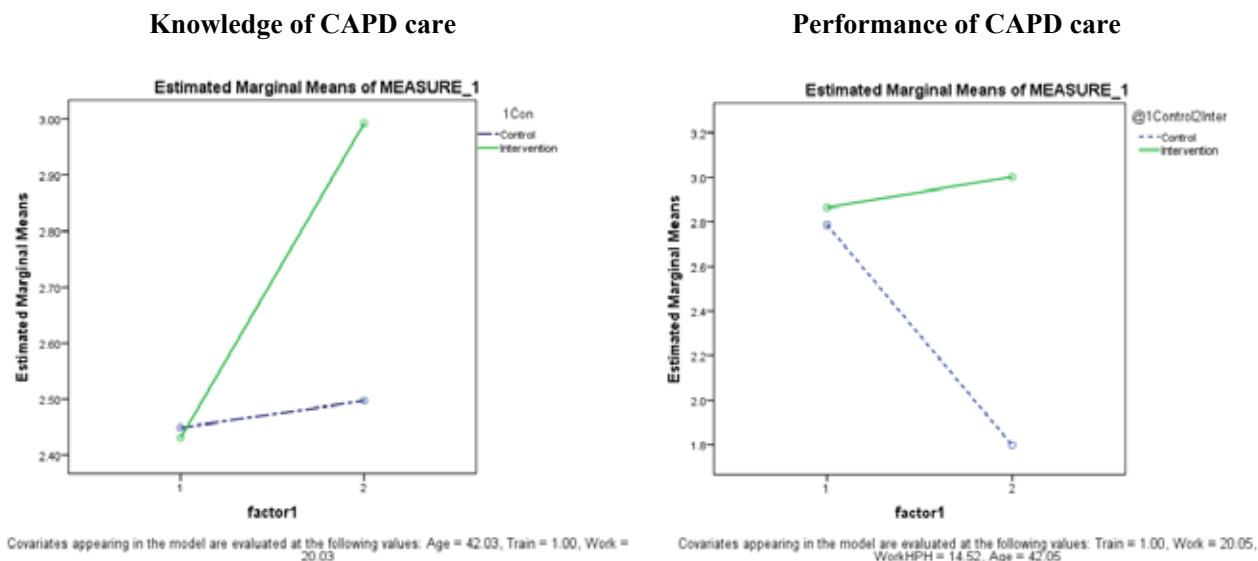
applied intervention program). There was a statistically significant difference between the intervention and control groups (p-value<.05). Both knowledge and perceived benefits of CAPD care were significantly higher in the experimental than that of the control groups at similar magnitudes with the mean difference of 4.41 (3.73-5.09 scores) on knowledge and 3.77 (3.21-4.44 scores) on perceived benefits of CAPD care. There was more improvement on CAPD care performance among the experimental group when compared with the controls with the mean difference of 17.12 (14.51-19.73 scores) (Table 4).

**Table 4 Mean difference adjusted for baseline measurements, sex age, educational status, training in nursing, duration of working experience as a nurse and duration of working experience in sub-district health promoting hospital for experimental and comparison groups using the analysis of covariance (ANCOVA) on Knowledge, Perceived benefits and Performance of CAPD care.**

Variable	Duration	Experimental Group		Comparison Group		Mean difference	Adj. Mean difference	95% CI	P-value
		Mean	S.D.	Mean	S.D.				
Knowledge of CAPD care	Baseline	14.06	2.83	14.44	2.55	-0.38	NA	NA	NA
	After	19.10	1.04	14.91	2.73	4.19	4.41	3.73 - 5.09	<0.001
Perception of CAPD care	Baseline	25.31	2.68	25.04	1.97	0.27	NA	NA	NA
	After	34.02	1.07	30.13	1.54	3.88	3.77	3.21 - 4.33	<0.001
Performance of CAPD care	Baseline	80.10	16.87	78.28	17.69	1.81	NA	NA	NA
	After	111.17	2.79	94.31	7.88	16.85	17.12	14.51-19.73	<0.001

Despite increasing the knowledge of CAPD care in all intervention and the control group but strongly increasing in the intervention group. Nevertheless,

the performance of CAPD care was increasing in the intervention group only (Figure 1).



**Figure 1 Change over times on Knowledge and Performance of CAPD care scores between the intervention and control group**

### Discussion

This study developed and implemented as well as determined the effectiveness of the CAPD handling process program on knowledge, perceived benefits and performances of CAPD care among nurses in order to strengthen the performance of CAPD care in primary care level. The research results indicated statistically significantly increase in knowledge of nurse in sub-district health promoting hospital. Considering the baseline knowledge on CAPD care of community nurses, the intervention and the control groups were not significant difference. It may be because all nurses acquired knowledge on CAPD care on annual training from hospital renal node. The experimental group had a little lower knowledge level more than the comparison group at baseline. However, after intervention, all of nurses in the experimental group had hid high level knowledge on CAPD care whereas less than half of those in the control group had high level. It may be because the intervention group received additional trainings as well as applied eHealth by web-based application<sup>9</sup> for nurses in primary care level which linked information from nephrologist and CAPD nurses in hospital renal node. This finding is similar with the study of web-based learning in practice settings among nurses in United

Kingdom<sup>10</sup> that increased their knowledge of patient care. In addition, the nurses also reported an increase in their ability to transfer their knowledge to practice through improved emotional and psychological support of patients and their relatives. The participants in the experimental group also worked in an integrated health care procedure with specialist in hospital renal node by setting the CAPD care systems in sub-district health promoting hospitals.

The assessment on perceived benefits of CAPD care among nurses in sub-district health promoting hospitals illustrated a significant increase in perceived benefits of CAPD care in the intervention group. This might help improving their performance on CAPD care. In 2017, the Ministry of Public Health launched the policy on service plan to increase quality of care in critical diseases especially the service plan for CKD of which improvement of standard of CKD care among excellence center well as primary care level are essential. Most importantly, the performance of CAPD care was much improved in the experimental group after intervention which was similar with a study among case manager nurses conducted by Tao X, Chow SK, Wong FK<sup>11</sup> reported the improvement of care performance for hemodialysis patients in community as well as the

practice guideline for community nurse with increased competency for patient care in community as well<sup>12</sup>.

### Conclusion

The “Modified CAPD patient’s handling process” intervention which included both the program of case manager nurse and web-based program of eHealth was effective in improving the nurse’s knowledge and perceived benefits of CAPD care as well nurse’s CAPD care performances among nurses who worked in primary care level. However, it is recommended to implement the Modified CAPD patient’s handling process in other setting with the aim of improvement to be fit with wider context. This study developed a CAPD patient’s handling process as an additional existing standard CAPD care with case management of community nurse for CAPD care as well as a CAPD web-based program which is the online operation. This technology might be restricted to primary care unit with poor resource internet.

**Funding:** The sources of funding of this project were Chulalongkorn University 90<sup>th</sup> and National Research Council of Thailand.

**Conflict of Interest:** No conflict of interest has been declared.

### References

- Jayaraman R, Van der Voort J. Principles of management of chronic kidney disease. *Paediatrics and Child Health*. 2010 Jun 1;20(6):291-6.
- Shaw C, Simms RJ, Pitcher D, Sandford R. Epidemiology of patients in England and Wales with autosomal dominant polycystic kidney disease and end-stage renal failure. *Nephrology Dialysis Transplantation*. 2014 Oct 1;29(10):1910-8.
- Stenvinkel P, Heimbürger O, Lindholm B, Kaysen GA, Bergström J. Are there two types of malnutrition in chronic renal failure? Evidence for relationships between malnutrition, inflammation and atherosclerosis (MIA syndrome). *Nephrology Dialysis Transplantation*. 2000 Jul 1;15(7):953-60.
- Shepperd S, Doll H, Angus RM, Clarke MJ, Iliffe S, Kalra L, Ricauda NA, Tibaldi V, Wilson AD. Avoiding hospital admission through provision of hospital care at home: a systematic review and meta-analysis of individual patient data. *Cmaj*. 2009 Jan 20;180(2):175-82.
- El Nahas AM, Bello AK. Chronic kidney disease: the global challenge. *The Lancet*. 2005 Jan 22;365(9456):331-40.
- Baiardi F, Degli EE, Cocchi R, Fabbri A, Sturani A, Valpiani G, Fusarol M. Effects of clinical and individual variables on quality of life in chronic renal failure patients. *Journal of Nephrology*. 2002;15(1):61-7.
- Frank A, Auslander GK, Weissgarten J. Quality of life of patients with end-stage renal disease at various stages of the illness. *Social Work in Health Care*. 2004 Feb 24;38(2):1-27.
- Sakthong P, Kasemsup V. Health-related quality of life in Thai peritoneal dialysis patients. *Asian Biomedicine*. 2011 Dec 1;5(6):799-806.
- McGuigan D, Moule P. A multi-method approach to explore nurses’ experiences of using a web-based learning package in cancer care and its impact on patient care. *UWE*. 2006 Dec 1.
- Kwon PJ, Kim H, Kim U. A study on the web-based intelligent self-diagnosis medical system. *Advances in Engineering Software*. 2009 Jun 1;40(6):402-6.
- Tao X, Chow SK, Wong FK. A nurse-led case management program on home exercise training for hemodialysis patients: A randomized controlled trial. *International journal of nursing studies*. 2015 Jun 1;52(6):1029-41.
- Moule P, Armoogum J, Dodd E, Donskoy AL, Douglass E, Taylor J, Turton P. Practical guidance on undertaking a service evaluation. *Nursing Standard*. 2016 Jul 6;30(45).

# Harmonization Over the Regulations of Electronic Medical Records and its Potential to be Abused

Maskun<sup>1</sup>, Rian Nugraha<sup>1</sup>, Hasbi Assidiq<sup>1,2</sup>, Muhammad Tayyib<sup>1</sup>, Armelia Syafira<sup>1</sup>

<sup>1</sup>Faculty of Law, Hasanuddin University,

<sup>2</sup>Faculty of Law, Hasanuddin University, Makassar, South Sulawesi, Indonesia

## Abstract

The rapid development of information and communication technology has brought changes to the mechanism for storing electronic medical records (EMR). EMR is very important to protect and provide comfort and convenience for health services. However, it is very susceptible to be abused by hackers. This study aims to harmonize amongst relevant laws on EMR and to identify the legal protection of EMR from abuse by hackers. This research uses a normative research method to harmonize legal norms and regulations related to EMR that already exist in Indonesia. Legal protection of EMR in Indonesia has not been implemented proportionally even though the regulation on EMR has been stipulated clearly in the Minister of Health Regulation No. 269/ 2008 concerning Medical Records and various relevant Laws on it. There are no derivative laws related to EMR as mandated by the Minister of Health Regulation No. 269/2008 which becomes an obstacle to the effective implementation of EMR. The existence of an EMR is Also very susceptible to be abused by hackers. So, cyber security is needed for health workers, both individually and institutionally to protect EMR. In conclusion, EMR has been regulated in Indonesian Laws, but it has not been governed into derivative laws to be implemented a proportionally. Therefore, harmonization those laws will narrow the gaps amongst them. Further norms and regulations regarding EMR are needed to create cybersecurity which is potential to be hacked.

**Keywords:** *Legal Protection; Electronic Medical Records; Hackers.*

## Introduction

The development of information technology today gives a colour to the world of health. The use of electronic medical records (EMR) is one form of these developments. EMR is a form of innovation in responding to the challenges of the times in the health sector. Medical records in the past are identical to paper administrative documents containing the patient's identity, history and actions given by a doctor to a patient. With EMR, health workers can obtain patient medical history data more easily, regardless of distance and time, the application of EMR has even been adopted in hospitals in various countries since 1999<sup>1</sup>.

In 2003, RAND Health Information Technology (HIT) began conducting research related to the role and importance of EMR in improving health services and informing the government to maximize the benefits of EMR and increase its use. The results of this study indicate the benefit of implementation of EMR and its

network can save more than 81 million dollars per year, which can increase productivity and efficiency in health care<sup>2</sup>. However, it remains to be aware that the use of systems based on electronics and the internet is very vulnerable to be abused and hacked by irresponsible parties.

EMR consists of notes and documents including the patient's identity, examination results, medications that have been given, and other actions and services that have been provided to patients<sup>3</sup>. The presence of multiple personal identities stored in the EMR is very susceptible to the misuse of data by parties who are not responsible. This can be taken place because the EMR repository can be accessed by the third parties – called hacker – and the tool to access it is computer and internet as a media. Therefore, some actions shall be done to protect on patient data, including regulation approach.

In general, regulations related to EMR has been governed in the Minister of Health Regulation

Number 269 of 2008 concerning on Medical Records (Permenkes Medical Records). In this regulation, it is explained that EMR documents, which is the data are qualified as personal data of a person need to be maintained and kept confidential to avoid data misuses. The content of a patient's medical record, basically, contains juridical consequences in the form of the patient's personal identity. It must, then, be kept confidential<sup>3</sup>. All information in medical records is confidential, therefore, its use must be with the patient's consent, except<sup>3</sup> for the purposes of education and research which are implemented for the benefit of the state

EMR is the use of information technology tools for collecting, storing, processing and accessing data stored in patient medical records in hospitals in a database management system that collects various sources of medical data<sup>4</sup>. Some modern hospitals have even combined EMR with the Hospital Management Information System (SIMRS) application which is the main application that not only contains EMR but also has added features such as administration, billing, nursing documentation, reporting and a score card dashboard.

If you look more deeply, the use of technology, namely computers and the internet, allows cybercrime to occur against patient EMR. Therefore, it is considered important to protect the EMR of patients, where this protection aims to safeguard personal data and broadly protect national health system data from abuse and cybercrime by those who want to hack. In general, the implementation of EMR has been categorized as an electronic document as stipulated in the Law Number 11 of 2008 as amended by the Law Number 19 of 2016 concerning Information and Electronic Transaction. It means that EMR as a norm and law has been accommodated in this Law, although it has not been specifically explained regarding EMR<sup>5</sup>.

Misuse of EMR is a legal issue to be discussed by among legal practitioners in this modern era, including in Indonesia. Some debates coming from many parties that EMR does not have a clear legal standing, especially with regard to guaranteeing against elements of privacy, confidentiality and information security in general<sup>4</sup>. The result of this controversy raises a distrust of the EMR system. As it is known that a person's data, especially medical history data, is very private and will be a danger if it is accessed by irresponsible parties. Of course, this will be very detrimental to the victim, particular in this

case of the patient's data has leaked to the party who should be prohibited from accessing the information.

Therefore, the focus of this paper is to analyse various regulations related to the implementation of EMR. Starting from general regulations such as the Law Number 29 of 2004 concerning Medical Practice (Law on Medical Practice) and the Law Number 11 of 2008 as amended by the Law Number 19 of 2016 concerning Information and Electronic Transaction, to specific regulation as if the Permenkes Medical Records. Those laws then shall be harmonized in order to carry out the important reasons why EMR is pivotal in medical practice and why it shall be protected. Indeed, the last point to be underlined in this paper is the identification of various cyber-rime vulnerabilities that will occur from misuse in the EMR.

## Materials and Method

This study is a normative study to analyze various EMR regulation, which is well adapted to the analysis of relevant norms and principles. Those regulation are reference sources coming from legal materials called laws and the principles of law, and a scientific journal. All those legal materials will be analyzed qualitatively to deal with the EMR legal issues. The various materials obtained are then analyzed qualitatively to lay down EMR in the right position as an advanced development of medical records, before technology gets involved in the area of medical records.

## Result and Discussion

### Harmonization of Medical Records Law:

**Obligation to Make Medical Records:** Medical records refer to the Law Number 29 of 2004 concerning Medical Practice. Article 46 paragraph (1) of the Law Number 29 of 2004 states that an obligation for doctors and dentists to have medical records of the patients in carrying out their medical practice. In the explanatory of the Article 46 paragraph (1) further explains the definition of "medical record" as a file containing notes and documents about the patient's identity, examination, treatment, actions and other services that have been provided to patients. Medical records should be equipped with the affix name, time, and signature of the person who provides services or actions.

Furthermore, Article 47 of the Law Number 29 of 2004 explains that<sup>6</sup>: Medical record documents as

referred to in Article 46 belong to a doctor, dentist, or health service facility, while the contents of the medical record are the property of the patient. Due to the contents of the medical record is belong to the patient, it is the duty of the doctor or dentist and the head of health service facilities to keep and maintain its confidentiality.

As it is known, medical records have a very important role and become an indicator of good and responsible medical practice, which shows the good performance and discipline of health workers. The medical record contains various data in the form of patient identity and all actions taken (from the beginning) to patients in the context of providing health services. The recording must be listed chronologically, systematically and accurately, so that it can provide a description of a person's disease information, investigative actions carried out on him/her, information on management plans, observational records, clinical and treatment results, approval or rejection, and summary of discharge<sup>7</sup>.

Regarding to EMR, it is specifically regulated in the Minister of Health Regulation (Permenkes) Number 269 of 2008 concerning Medical Records (Permenkes Medical Records). Even though in the explanatory of article 46 paragraph 3 of the Medical Practice Law has provided space for the implementation of EMR, the clear position of EMR basically is stipulated in the Permenkes on Medical Records. This Permenkes states that if the medical records created in electronic form, the signature of the doctor or dentist or other health professionals can be replaced by using a personal identification number. This is very important because Article 2 of the Permenkes provides a legality basis for the implementation of medical records which must be written, complete and clear or electronically<sup>3</sup>. It means that the contents of the medical record should be in written form and is belong to the patient which consisting of notes and documents regarding the patient's identity, examination, treatment, actions and other services that have been provided to the patient<sup>3</sup>. According to the Permenkes, the contents of medical records can be categorized as categories for out-patients, in-patients, emergency services, disaster situations and for the services of a specialist doctor or specialist dentist. The medical records have minimally contents such as personal identity, complaints of illness, and health measures are necessary<sup>3</sup>.

Nowadays, the implementation of EMR has been able to be synergised to a hospital information system (SIRS) electronically. The SIRS may be contained

various applications such as: (a) Application of Mobile and Web; ( b ) Server Applications; (c) Receptionist Application; (d) Telemedicine applications; (e) Update Medical Registration; (f) Application in the Medical Registration Room; (g) Application of Hospital Information Systems; (h) Application for Recording Doctor's Salary; (i) Result of Pathology Laboratory Test; and (j) Application of Radiology Test Results. With data storage based on Cloud Computing, this can make it easier for hospitals to store large data<sup>8</sup>.

According to WimmieHandiwidjojo, the use of EMR has enabled information technology equipment for the collection, storage, processing, and accessing data stored in the EMR of patients in hospitals within a database management system that collects various sources of medical data, since 2009. Even some modern hospitals have combined EMR with the Hospital Management Information System (SIMRS) application which is the main application that not only contains EMR but has added features such as administration, *billing*, nursing documentation, reporting and a score card dashboard<sup>9</sup>.

**EMR as an Electronic Document:** The existence of EMR is a development of technological advances in the health sector which is also part of the mandate of the Indonesian Medical Code of Ethics. Article 21 of the Code of Ethics explains that it requires doctors to keep developments in medical or health science and technology. According to IkaMeilia, every doctor should be willing and able to document patient management carried out in the EMR in accordance with applicable regulations<sup>1</sup>. As an implication of the development of electronic technology, the provisions in EMR are closely related to electronic documents stipulated in the Law Number 11 of 2008 as amended by the Law Number 19 of 2016 concerning Information and Electronic Transaction.

Article a point 4 of the Law Number 11 of 2008 as amended by the Law Number 19 of 2016 concerning Information and Electronic Transaction (the Information and Electronic Transaction Law) stipulates that electronic documents are defined as "any electronic information that is created, forwarded, sent, received, or stored in analogue, digital, electromagnetic, optical, or the like, which can be seen, displayed, and / or heard through a computer or electronic system, including but not limited to writing, sound, images, maps, designs, photographs or the like, letters, signs, numbers, access codes, symbols or perforations that have meaning or meaning or can be



understood by those who are able to understand them.” Referring to the document electronic as stipulated in the Article 1 of the law Number 11 of 2008, EMR can be categorized as an electronic document. The legal implication of this is that the regulations related to EMR have an intersection stipulated in the Information and Electronic Transaction Law. So that all legal actions related to the abuse of this EMR can be subjected to sanctions of the Information and Electronic Transaction Law.

The crucial point from the harmonisation of the EMR as stipulated above, it cannot be denied, then, the protection of medical records is very necessary to neglect EMR misuse from unauthorized parties and for the sake of legal evidence<sup>10</sup>. However unfortunately, after 12 years since this legal basis was established, there are no derivative regulations of the Permenkes to become the legal basis for the enforcement of EMR in Indonesia as stated in Article 2 paragraph (2) the Permenkes on Medical Records. Even though this is very important to strengthen the legality of EMR implementation<sup>7</sup>.

**Abuse Vulnerability of EMR:** EMR collect various medical history data, patient care or medication and it is very personal to the patient. The existence of various personal identities stored in EMR is very vulnerable to misuse of data by irresponsible parties. Medical record documents, both conventional and electronic, are confidential documents belonging to patients, so they must be protected as best as possible. In this case, the family or other parties who want to know this medical record need to get the consent of the patient or the patient’s attorney. So that privacy of patient is very much guarded. (Rokhim 2020) EMR can be stored in an electronic device such as a computer or other electronic data storage device, including the Cloud.

EMR has at least two forms of security against the privacy of medical records, namely authentication and authorization. Authentication is a form of ensuring that the party authorized to enter and use the system. It can be in the form of a password, access card or more sophisticated with biometrics such as fingerprints. Meanwhile, in terms of authorization, only certain parties have the authority to access EMR. It means that not every officer in the health facility is allowed to use the existing EMR network system. Each user also has different access authority restrictions. This can increase EMR’s privacy security<sup>1</sup>.

In general, the misuse of EMR data can be categorized as cyber-crime. It is classified into two forms, namely; (a) crimes via computer media, Flash-disk- or various other hard storage devices; and (b) crime via hacking by the EMR Cloud based system. To guarantee the legal protection of patient data, therefore, it is very important to understand these two things to prevent and take legal measures that can be taken to protect EMR from misuse by the irresponsible party.

Some scholars use the terms “computer misuse”, “computer abuse”, “computer fraud”, “computer-related crime”, “computer-assisted crime”, or “computer crime”. However, scholars at that time generally accepted the use of the term “computer crime”. It was because it was considered more extensive and commonly used in international relations. The British Law Commission defines “computer fraud” as computer manipulation in any way done in bad faith to obtain money, goods or other benefits or intended to cause harm to other parties (Suhariyanto 2012)<sup>11</sup>.

In this case, those who can obtain EMR data are those who can legally access the data, such as health workers and patients themselves in accordance with applicable regulations. One such case was at Howard University Hospital, Washington in which data security is not properly guaranteed causes data leakage. In this case, a staff member at the hospital has access to patient data, name, address and patient medical record number and sells the information to insurers. Another case is a worker managed to steal a laptop and download 34,000 patient data on his personal laptop in a hospital. EMR data is not encrypted. It means that anyone can guess the data password and can access patient data. Based on this, according to Meilia, it becomes a challenge in the medical world to improve the safety of patient EMR data<sup>1</sup>. In this context, the EMR abused can be categorized as Computer Crime because it uses a computer device as a tool to conduct crime. In this case a computer is a tool to commit a crime to gain certain advantages that harm other parties.

Storage system based EMR Cloud computing is one of development technology. In this context, to store EMR no longer requires a separate server because it has been supported by the virtual server. This cloud-based storage method can save infrastructure costs and can easily share data with various health care facilities. However, on the other hand, EMR data storage based on the Cloud is very vulnerable to the risk of hacking<sup>11</sup>. As

it is known, a hacker can hack a network system so that it is possible to access data from a network system that has been hacked. This applies to any network system that is open and accessible to anyone. If EMR data exists in an internet network such as those based on the cloud, then there is a great potential that these data can be hacked.

In the typology of cybercrime, hackers against cloud-based EMR systems can be categorized as occurring, namely: (a) offenses against the confidentiality, integrity and availability of computer data and systems, such as illegal access (hacking / cracking), illegal data acquisition (data espionage), Illegal interception, data interference, system interference<sup>12</sup>. To reduce this risk, it is necessary to have a cybersecurity system that is qualified and evaluated and tested regularly network security<sup>10</sup>.

Regarding to abused EMR via hacking, in Article 30 paragraph (1), paragraph (2) and Paragraph (3) jo. Article 46 paragraph (1), paragraph (2) and paragraph (3) of Law No. 11 of 2008 concerning Electronic Information and Transactions as amended by Law No. 19 of 2016 concerning Amendments to Law No. 11 of 2008 concerning Information and Electronic Transactions have regulated legal sanctions on hackers, or people who deliberately access other people's computers or certain electronic systems unlawfully, with various criminal sanctions and fines that can be prosecuted to hackers. Referring to those articles on the Information and Electronic Transaction Law, which is then linked to EMR, it is an electronic information and / or electronic document and anyone who misuses a patient's EMR data can be subject to the article. However, this is a step when the criminal act has occurred. Even though there should be preventive steps beIn EMR practice, debate on legal standing of EMR is still taking place. Some regulation such as the Medical Practice Law and/or the Permenkes on Medical Records do not derive to lower regulation to show EMR position to be more practical. Article 2 paragraph (2) Permenkes on Medical Records states that EMR as an alternative to recording medical records will be regulated in a separate regulation, but until today the regulation has not yet existed. Even though EMR system has been used by several hospitals in Indonesia such as Dr. Soetomo Hospital<sup>13</sup> Surabaya and RS Paru Jember<sup>14</sup>

The absence of a clear legal standing in EMR security system is indicative of a lack of trust in the security of patient data. On July 20, 2018, for example, hackers pretend to be patients visited the clinic database

and clinic of SingHealth, the largest health operator in Singapore. The hackers then illegally accessed and downloaded data on 1 May 2015-4 July 2018. The medical information data of 1.5 million Singaporeans including data belonging to Prime Minister Lee Hsien Loong was hacked into<sup>15</sup>.

## Conclusion

Harmonization of law is required related to the protection of EMR data, which has a legal basis as stipulated in the Medical Practice Law, and specifically in the Permenkes on Medical Records. As an electronic document, EMR's position is also directly regulated in the Information and Electronic Transaction Law. In addition, special regulations are needed related to EMR itself which is the mandate of the Permenkes on Medical Records. The aim of derivative regulation to strengthen the legal standing of the EMR and to neglect abuse of EMR done by the irresponsible parties either via computer crime or via hacking.

**Conflict of Interest:** The Authors declare that there is no conflict of Interest.

**Source of Funding:** Nil

**Ethical Clearance:** Taken from Medical Record Committee as stipulated by the Ministry of Health Regulation No. 269/Menkes/Per/III/2008.

## Reference

1. Meilia PDI, Christianto GM, Librianty N. Buah Simalakama Rekam Medis Elektronik: Manfaat Versus Dilema Etik (The Horns of a Dilemma of Electronic Medical Records: Benefit vs Ethical Dilemma). *Jurnal Etika Kedokteran Indonesia* 2019;3(2). p.61.
2. Hillestad R, et. Al. Can Electronic Medical Record Systems Transform Health Care? Potential Health Benefits, Savings, And Costs. *Health Affairs* 2005;24(5)
3. Ministry of Health of the Republic of Indonesia Regulation No. 269/MENKES/PER/III/2008 concerning on Medical Records.
4. Sudjana. Aspek Hukum Rekam Medis atau Rekam Medis Elektronik sebagai Alat Bukti Dalam Transaksi Teurapetik (Legal Aspect of Medical Record or Electronic Medical Record as Evidence in Therapeutic Transaction). *Veritas et Justicia* 2017;3(2). p. 369

5. Wahjuni E, Sari NK. Legal Aspects of Electronic Medical Records. *Jurnal Dinamika Hukum* 2017;17(3). p. 9
6. Law No. 29 of 2004 Concerning on Medical Practice. Art. 47
7. Samandari NA, Chandrawila W, Rahim AH. Kekuatan Pembuktian Rekam Medis Konvensional dan Elektronik (The Evidence Power of Conventional and Electronic Medical Records) . *SOEPRA Journal of Health Law* 2016;2(2). p. 155
8. Kartika AR, Yusuf A, Rohman AD, Sudirja S. Sistem Rekam Medik Berbasis Cloud Computing dan Identifikasi Frekuensi Radio (Cloud Computing Based Medical Record System and Radio Frequency Identification). *National Seminar on Information and Multimedia Technology, STMIK AMIKOM Yogyakarta* 2014;2(1) p.30
9. Handiwidjojo W. Rekam Medis Elektronik (Electronic Medical Records). *EKSIS Journal* 2009;2(1). p.38
10. Budiyantri RT, Arso SP, Herlambang PM. Rekam Medis Elektronik Berbasis Cloud dalam Perspektif Etika dan Hukum di Indonesia (Cloud-Based Electronic Medical Record in the Perspective of Ethics and Law in Indonesia). *Cermin Dunia Kedokteran* 2018;45(9). p.695
11. Suhariyanto B. Tindak Pidana Teknologi Informasi (Cybercrime): Urgensi Pengaturan dan Celah Hukumnya (Technology Information Crime Regulatory Urgencies and Legal Loopholes). Jakarta: PT RajagrafindoPersada; 2012, p.9
12. Gercke M. Understanding Cybercrime: Phenomena, Challenges, and Legal Response. ITU Telecommunication Development Sector; 2012. pp. 12–33
13. BUANA. Membangun Implementasi Rekam Medik Elektronik (RME) “Terintegrasi di Rumah Sakit (Developing “Integrated” Electronic Medical Record (EMR) in Hospital) <http://www.bvk.co.id/artikel/berita/159-membangun-implementasi-rekam-medik-elektronik-rme-terintegr-di-rumah-sakit> (accessed).
14. RS Paru Jember. Studi Banding Rekam Medis Elektronik RSUD Prof. dr. Soekandar Mojokerto di RS Paru Jember (Comparative Study on Electronic Medical Records at Regional Public Hospital Prof. dr. Soekandar Mojokerto at Pulmonary Hospital Jember) <http://rspjember.jatimprov.go.id/berita/studi-banding-rekam-medis-elektronik-rsud-prof-dr-soekandar-mojokerto-di-rs-paru-jember.html?page=3> (accessed)
15. Yon Yoseph. Data Medis 1,5 Juta Masyarakat Singapura Dibobol Peretas (1.5 Million Medical Record of Singaporeans was breached by hacker) <https://dunia.tempo.co/read/1109140/data-medis-15-juta-masyarakat-singapura-dibobol-peretas> (accessed) Fore this happens.

## Call for Papers / Article Submission

Medico-Legal Update invites articles, case reports, newspaper clippings, report medico legal activities to update the knowledge of readers in scientific disciplines such as Forensic Medicine, Forensic Sciences, Environmental Hazards, Toxicology, odontology, Anatomy and law etc.

### The following guidelines should be noted:

- The article must be submitted by e-mail only. Hard copy not needed. Send article as attachment in e-mail.
- The article should be accompanied by a declaration from all authors that it is an original work and has not been sent to any other journal for publication.
- As a policy matter, journal encourages articles regarding new concepts and new information.
- Article should have a Title
- Names of authors
- Your Affiliation (designations with college address)
- Abstract
- Key words
- Introduction or back ground
- Material and Methods
- Findings
- Conclusion
- Discussion
- Acknowledgements
- Interest of conflict
- References in Vancouver style.
- Please quote references in text by superscripting
- Word limit 2500-3000 words, MSWORD Format, single file

All articles should be sent to: [medicolegalupdate@gmail.com](mailto:medicolegalupdate@gmail.com)

### *Our Contact info:*

#### **Institute of Medico-Legal Publications**

Logix Office Tower, Unit No. 1704, Logix City Centre Mall

Sector- 32, Noida - 201 301 (Uttar Pradesh)

Mob: 09971888542, Ph. 0120- 429 4015, Email: [medicolegalupdate@gmail.com](mailto:medicolegalupdate@gmail.com)

Website: [www.medicolegalupdate.org](http://www.medicolegalupdate.org)



# Medico-Legal Update

Logix Office Tower, Unit No. 1704, Logix City Centre Mall  
Sector- 32, Noida - 201 301 (Uttar Pradesh)  
Mob: 09971888542, Ph. 0120- 429 4015,  
Email: medicolegalupdate@gmail.com,  
Website: www.medicolegalupdate.org

## CALL FOR SUBSCRIPTIONS

### About The Journal

Print-ISSN:0971-720X, Electronic - ISSN:0974-1283, Frequency: Quarterly (4 issues in a year)

**Medico Legal Update** is a journal which brings latest knowledge regarding changing medico legal scenario to its readers. The journal caters to specialties of Forensic Medicine, Forensic Science, D. N. A. fingerprinting, Toxicology, Environmental hazards, Sexual Medicine etc. The journal has been assigned international standard serial number (ISSN) 0971-720X. The journal is registered with Registrar of Newspapers for India vide registration numbers 63757/96 under Press and Registration of Books act, 1867. The journal is also covered by EMBASE (Excerpta Medica Database) from 1997 and by INDEX COPERNICUS, POLAND.

**Medico-Legal Update** is a quarterly peer reviewed journal. The journal has also been assigned E- ISSN 0974-1283 (Electronic version). The first issue of the journal was published in 1996.

Journal Title	Print Only
Medico-Legal Update	INR 9000

### NOTE FOR SUBSCRIBERS

- Advance payment required by cheque/demand draft in the name of **"Institute of Medico-Legal Publications"** payable at New Delhi.
- Cancellation not allowed except for duplicate payment.
- Claim must be made within six months from issue date.
- A free copy can be forwarded on request.

### Bank Details

Name of account : **Institute of Medico-Legal Publications Pvt Ltd**  
Bank: **HDFC Bank**  
Branch: **Sector-50, Noida-201 301**  
Account number: **09307630000146**  
Type of Account: **Current Account**  
MICR Code: **110240113**  
RTGS/NEFT/IFSC Code: **HDFC0000728**  
Please quote reference number.

**Send all payment to :**

### **Institute of Medico-Legal Publications**

Logix Office Tower, Unit No. 1704, Logix City Centre Mall  
Sector- 32, Noida - 201 301 (Uttar Pradesh) Mob: 09971888542, Ph. 0120- 429 4015,  
Email: medicolegalupdate@gmail.com, Website: www.medicolegalupdate.org

---

**Published, Printed and Owned: Dr. R.K. Sharma**

**Printed at: Printpack Electrostat G-2, Eros Apartment, 56, Nehru Place, New Delhi-110019**

**Published at: Institute of Medico-Legal Publications: Logix Office Tower, Unit No. 1704,**

**Logix City Centre Mall, Sector- 32, Noida - 201 301 (Uttar Pradesh), Ph. +91 120 429 4015, +91 9971888542**