

urnal_of_Analytical_Chemistry,_
Vol_8,_No.1,_2013_,_Pages_17-
pdf
by

Submission date: 27-Jun-2023 05:59PM (UTC+0700)

Submission ID: 2123424766

File name: urnal_of_Analytical_Chemistry,_Vol_8,_No.1,_2013_,_Pages_17-.pdf (386.87K)

Word count: 3704

Character count: 18910

Gas-Liquid Separator Integrated to HG-QFAAS Method for Determination of Tin at Trace Levels in the Water Samples

Aman Sentosa Panggabean^{a*}, Subur P. Pasaribu^a, M. Bachri Amran^b, Buchari^b

^aDepartment of Chemistry, FMIPA-University of Mulawarman Samarinda Indonesia-75119*

^bDivision of Analytical Chemistry, FMIPA ITB, Jl. Ganesa 10 Bandung Indonesia-40132

Received: 30/07/2011; Accepted: 07/10/2011

Abstract

The determination of tin (Sn) ion at trace levels using integrated gas-liquid separator with hydride generation-quartz furnace atomic absorption spectrophotometer (HG-QFAAS) has been done. This modified gas-liquid separator at various sizes was able to increase sensitivity in the determination of Sn in solution. The acid reagent mixing techniques, sample and reductant optimally occurs in a coil reaction before they are going to the gas-liquid separators. The optimum conditions of parameter measurement in the determination of Sn ion with HG method are influenced by type and concentration of acid, and the concentration of reductant has been evaluated. These optimum parameters can increase of analytical performance simultanly, which is shown by detection limit $3.74 \mu\text{g L}^{-1}$ for 100 μL injection volume (3.74 pg Sn). The accuracy of measurement shown by the percentage of recovery of the Sn determination in natural water sample at $>95 \%$, indicate this technique is good to be applied for tin analysis at picogram level.

Keywords:

Sn, hydride generation, gas-liquid separator, QFAAS

1. Introduction

Tin (Stannum, Sn) is one of the elements having biological, environmental and technological importance. Tin commonly found in nature as SnO_2 . Tin is a soft metal, and also corrosion resistant. Tin is widely used as food wrapper and drinks in food industry because of these physical properties. Tin is also used in metal alloy. Tin can make covalent bond with one or more carbon atom to form an organometallic which commonly called organotin [1,2]. One of the most useful organotins is tributyltin (TBT). This compound is widely used as anti fouling agent because of its biocide property [3]. Hence, the developing of an easy, sensitive, precise method is desired for the determination of trace tin.

In recent years, several analytical techniques and methods have been used to determine total tin in environmental and biological samples. Some more sensitive detectors have been used to enhance the tin detection, they are ICP-MS [4], ICP-AES [5,6], ETAAS [7,8], and GFAAS [9,10]. The sensitivity of ICP-MS is the highest, however, ICP-MS is not an option method in the determination of trace amounts of tin in complex matrices, because it would most likely suffer from severe matrix interferences [11]. Many researchers prefer atomic absorption spectrometry, owing to its simpler and less expensive instrumentation. Despite the sensitivity and accuracy inherent in AAS, many analysts have found tin determinations to be

* Corresponding Author

E-mail: S304gabe@mail.chem.itb.ac.id

ISSN: 1306-3057

Moment Publication ©2013

troublesome. In the case of tin determination by GFAAS, the direct determination has been fraught with problems, such as volatilization loss, interaction with the graphite tube, and vapor phase interference [9].

As one of the few high sensitivity determination techniques, hydride generation atomic absorption spectrometry (HG-AAS) has become a popular method for the determination of As, Bi, Ge, Pb, Sb, Sn, Hg, Te and Se [11,12], since the analyte is separated from the matrix elements in solution. The fundamental principle of this method is the formation of metal-hydride by reductant NaBH_4 or NaBEt_4 in gas-liquid separator placed in hydride generator system. The metal-hydride formed will then going to a quartz cell placed on either the AAS flame or heating mantle. The atomization occurred in the quartz cell is caused by the light from hollow cathode that passes it through. The advantage of HG-QFAAS method is that the detection limit and sensitiveness can be enhanced because the metals have been separated from each other in their hydride forms. That is why the atomization can be done at temperature 1000°C [13,14]. Through this process the loss of the atomization can be minimalized, and the most important is that this process can be done in laboratories with limited equipment and low cost.

Tin in natural waters is generally present at very low concentrations. Quantitative analysis of trace tin requires a method that either has extremely lower detection limit or involves a preconcentration step. Derivative measurement technique coupling with hydride generation AAS had been developed for the direct determination of selenium, tellurium and lead with very higher sensitivity and lower detection limit without preconcentration [15].

The aim of this work is to establish a new method for the direct determination of trace tin in water samples by HG-QFAAS coupling with derivative signal processing without preconcentration. The proposed method was applied to the determination of trace tin in water samples.

2. Experimental

2.1. Instrumentation and Reagents

A set of construction hydride generator equipment by peristaltic pump and gas-liquid separator, atomic Absorption Spectrometer double beam GBC-Avanta 6506 equipment with quartz furnace (EHG-3000), recorder system, and data analyzer Origin™ 7.0., was used for all measurements.

All reagents were of analytical-reagent grade. A stock $1000\ \mu\text{g mL}^{-1}$ of Sn (II) was prepared by dissolving 1.9008 g of $\text{SnCl}_2 \cdot 2\text{H}_2\text{O}$ (Merck) in aquabidest (HPLC grade, 18 M Ω) and was diluted to 1000 mL. CH_3COOH , H_2SO_4 , NH_4OH , HCl , NaBH_4 0.4 % (dissolved in NaOH 0.05 %, v/v) (Merck).

2.2. Procedures

2.2.1. Gas-liquid separator construction in hydride generator system

The gas-liquid separator is host to the metal hydride formation process prior continuation to AAS flame. The geometric of the gas-liquid separator was regulated by varying the length and diameter of the cylinder at $9.0 \times 3.0\ \text{cm}$; $7.5 \times 2.5\ \text{cm}$ and $6.0 \times 2.0\ \text{cm}$ respectively. The diameter of the sample injection tube, acid and reductant was 0.5 mm, as seen in Fig. 1. The sample and reductant were inserted into the separator through a peristaltic pump with flow injection analysis (FIA) system [16].

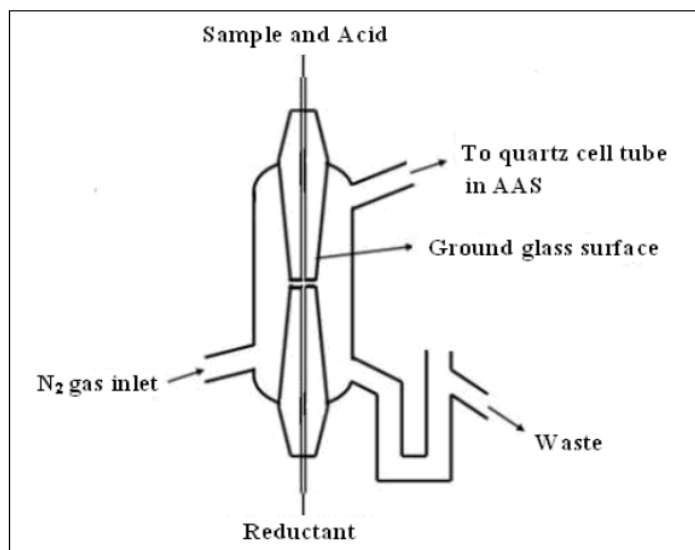

Fig. 1. Gas-liquid Separator hydride generator

2.2.2. Optimization of gas-liquid separator integrated into HG-AAS system

The previously made gas-liquid separator was integrated as in Fig. 2. The resulting hydride formation occurring in the gas-liquid separator flowed into the quartz cell tube placed on top on the AAS flame with ultra-pure nitrogen gas. The absorbance was recorder with a computer integrated system and then processed with a converter analysis data analyzer Origin™ 7.0. The analytical condition of AAS parameters at time of measures can be seen below in Table 1.

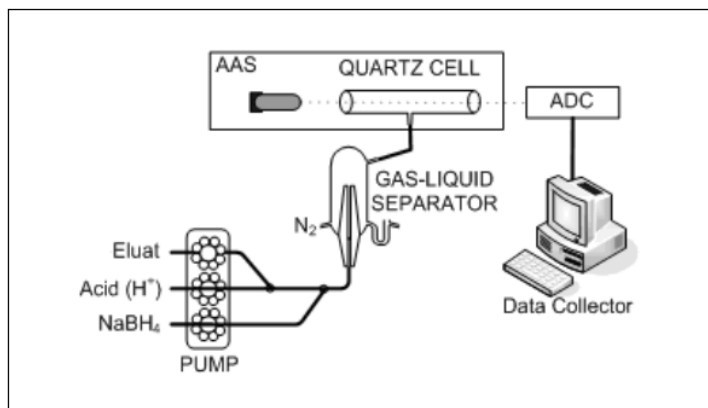

Fig.2. Equipment of the HG-QFAAS system

In effect to determine the optimum geometric form on the gas-liquid separator, the absorption of the 100 ppb Sn(II) standard was measured, with concentrations of 0,5 M HCl and 0,6 % NaBH₄, with a acid and reductant flow rate made constant for each gas-liquid separator geometric. The geometric form resulting in the largest absorbance was used in further experimentation.

Table 1. The analytical condition of AAS parameters at time measures

AAS GBC• - Avanta 6506	
Hollow cathode lamp	Sn
Wavelength	224.6 nm
SBW	0.7 nm
Lamp current	6 mA
Rate of flow acetylene	2 L/ment
Rate of flow oxygen	7 L/ment
Rate of flow nitrogen	5 L/ment

2.2.3. Determination of optimum conditions for Sn(II) measurement with HG-AAS method

Optimalization of Sn(II) ion determination was preformed using hydride generator equipment connected quartz cell tube placed above the AAS flame (as in the Fig. 2). In this experiment was preformed with a variety of parameters such as the sample volume injection, type and concentration of the acid HCl, HNO₃, H₂SO₄, and CH₃COOH, and NaBH₄ of concentration as a reductant.

Analytical Performance of the HG-AAS for determination of Sn(II) concentration

The analytical performance determination encompassed of the linearity of area (calibration curve), detection limit, reproducibility and application of these method in determining Sn(II) concentrations in natural water samples, utilizing the optimal conditions attained in previous procedure.

3. Results And Discussion

To enhance the detection limit of Sn (II) measurement using AAS, the hydride generation method can be used. Sn (II) was firstly derivatized into hydride form then atomized in the AAS flame [12] according to reactions below;

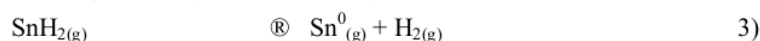
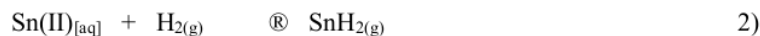
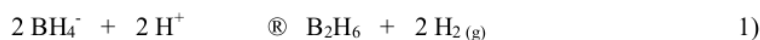

The hydride generation occurred in the hydride generator (HG) separator. The optimal geometric of the separator had to be found to get the optimum measurement.

3.1. Optimation of Gas-Liquid Separator Geometric Size

In this optimation process, the absorbance of 100 ppb Sn(II) solution was measured by using several sizes of the home made gas-liquid separator. In this process the concentration of acetic acid and reductant are constant variables. There were two ways to mix the reactant; mixing in the coil before going to gas-liquid separator and mixing in the gas-liquid separator.

3.1.1. Mixing in the coil before going to gas-liquid separator

In this technique, the interactions between sample, acid, and reductant take place in the coil. The hydride formed would then go to gas-liquid separator and introduced into the quartz cell in AAS. The result showed that the bigger the geometric size of the gas-liquid separator

the bigger the absorbance read. It happened because the bigger the geometric size of the gas-liquid separator the bigger the volume expansion, thus the separation of gas and liquid aerosol can occur perfectly in the separator. Therefore, the population of the hydride formed would be higher, as shown in the Fig. 3.

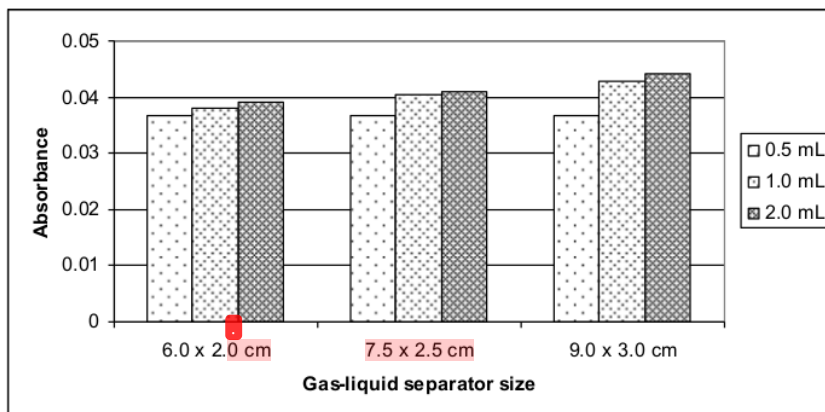

Fig. 3. Absorbance curve of Sn(II) standard at mixing system in reaction coil

3.1.2. Mixing in the gas-liquid separator

This study showed that the smaller the geometric size, the bigger the absorbance yielded. This is because the bigger the separator tube, the slower the transfer into AAS, thus the signal yielded would be smaller and wider. This result is shown by the Fig. 4.

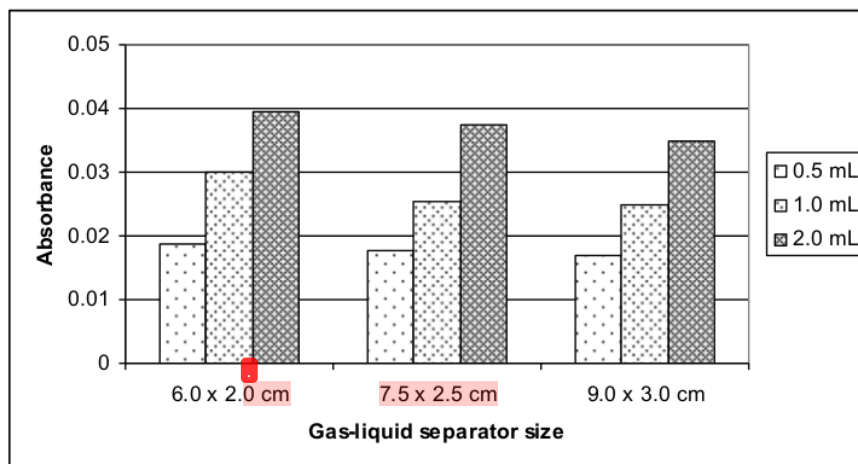

Fig. 4. Absorbance curve of Sn(II) standard at mixing system in gas-liquid separator

From the two methods above, we can conclude that the mixing in the coil before introduced to the separator is better than the mixing in the separator. This is proved by the bigger absorbance yielded and the good shape of the peak.

3.2. Optimisation of the acid used

In this step the type of acid is varied while the concentration is a constant variable. The purpose is to find the acid which produces the optimum hydride. The result is shown by this Fig. 5.

In the determination of Sn ions with HG-QFAAS methods, the use of H_2SO_4 and HNO_3 as the acid atmosphere maker was not optimal. This is because both these acids are oxidizing, which can interfere with the process of oxidation-reduction reactions in metal-hydride formation in the gas-liquid separator. At the same concentration, H_2SO_4 and HNO_3 pH lower than CH_3COOH . This shows the process of oxidation-reduction reactions in the gas-liquid separator is strongly influenced by the pH of the solution. At lower pH, the quality-metal hydride produced will decrease. From Fig. 5, can be known, CH_3COOH gives a better signal than the other types of acid. For further work these acids are used in the process of hydride formation.

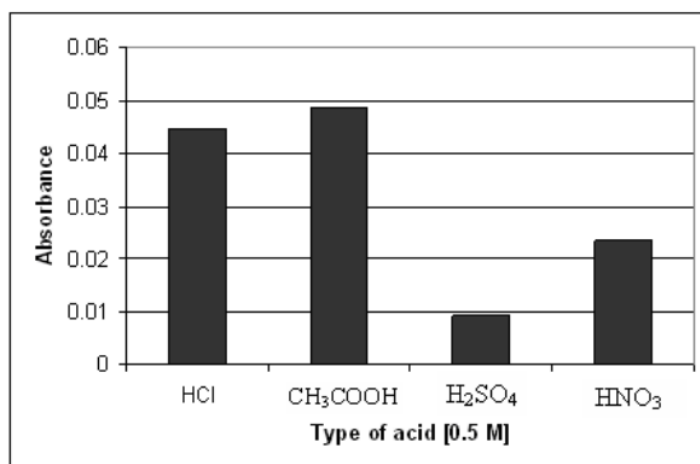

Fig. 5. Effect of acid type towards Sn(II) determination with HG-QFAAS method

3.3. Optimisation of acetic acid concentration

The acid concentration uses an important rule in the hydride generation. In this research, the acetic acid concentration is varied while the concentration of tin standard and reductant are settled to be constant. The result is shown by the Fig.6.

The optimum concentration of CH_3COOH is 0.3 M. In the acid concentration is too large, there will be dilution of the reaction, because the ratio between the amounts of H_2 gas produced the amount of Sn atoms are too large (there is an excess H_2 gas). The dilution of this product may cause reduced signal intensity. Other assumptions show the acid concentrations higher gas produces more CO_2 . CO_2 gas that is formed will interfere with the process of formation-metal hydride, so the formation of hydride-Sn population was not optimal [11,17].

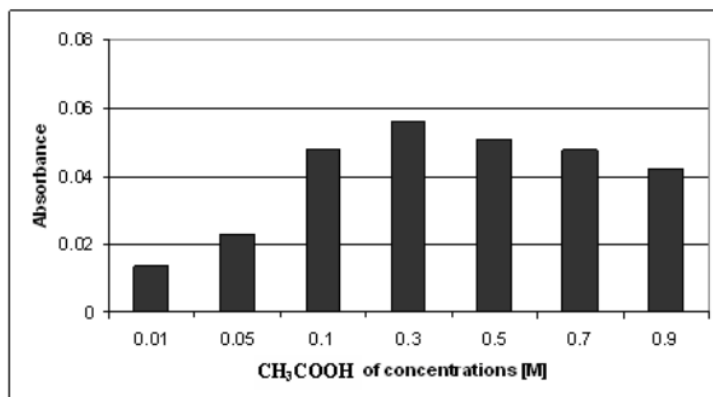

Fig. 6. Effect of CH₃COOH concentration in Sn(II) determination with HG-QFAAS method

3.4. Influence of NaBH₄ concentration

To find out the influence of NaBH₄ concentration to the hydride generation, an experiment by varied of the NaBH₄ concentration was held, while the concentration of acid and tin standard are settled to be constant. The result is shown by Fig.7.

From Fig. 7, NaBH₄ concentration indicated that the optimum in this study was 0.4%. Increasing concentration of the NaBH₄ would cause the over production of H₂ gas is formed, so as to reduce the population metal-hydride formed. In this case the reaction would go too fast, so there are a number of participating water vapor into the flame AAS, which can interfere atomization process.

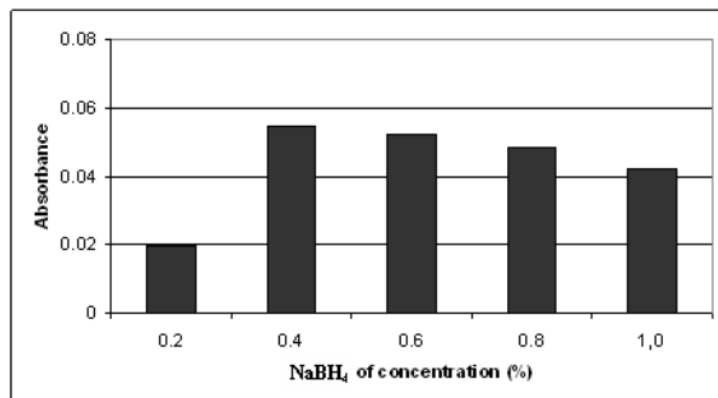

Fig. 7. Effect of NaBH₄ concentration in Sn(II) determination with HG-QFAAS method

3.5. Analytical Performance of HG-QFAAS Method in Determination of Sn (II) Concentration

Based on the optimizations which have been done before, the analytical performance of the HG-QFAAS method for Sn(II) analysis can be stated as below.

3.5.1. Determination of Calibration Curve

Measurement of variant concentration of Sn(II) was done at the optimum condition. The result is shown by Fig. 8. The concentrations of Sn(II) standards are in range 10-200 ppb.

The linear regression equation is $Y = 0.0001X + 0.0031$, $R = 0.9963$. This result proved that the method is good to be used in Sn(II) analysis.

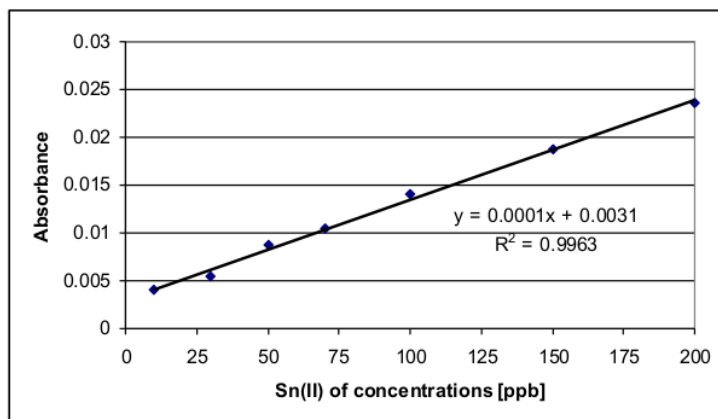

Fig. 8. Calibration curve Sn(II) for determination with HG-QFAAS method

3.5.2. Determination of Detection Limit

The detection limit is determined by measuring the smallest absorbance of sample that can be distinguished from the blank signal in a few measurements. The detection limit is shown as the ratio of standard signal (S) against the blank signal (B) or $S/N = 3$.

The result showed that the detection limit of Sn(II) determination with HG-QFAAS method is 3.74 $\mu\text{g/L}$ for sample injection volume 100 μL (mass minimum of detected is 3.74 $\mu\text{g Sn}$). When compared with the ion measurements Sn(II) directly by FAAS and HG-FAAS method, shown in Table 2. From Table 2 shown the HG-QFAAS technique integrated to gas-liquid separator modified was developed to increase the sensitivity of measurement is 1200 times better than compared to direct measurement with FAAS. This shows that the method developed very well used in the analysis of Sn(II) ion in a trace of concentration.

Table 2. Comparison of detection limit of Sn(II) determination at various methods

Method	Limit of detection ($\mu\text{g/L}$)	Mass minimum detected ($\mu\text{g Sn}$)
Direct of AAS	4650	4650
HG-FAAS	71.06	71.06
HG-QFAAS integrated	3.74	3.74

3.5.3. Determination of Measurement Reproducibility

The reproducibility is determined by measuring the absorbance of Sn(II) standard solution 100 ppb for several times under the optimum condition. The reproducibility is shown as percentage of CV (coefficient of variance). From the result of experiment, the % CV of Sn(II) determination with HG-QFAAS method is 1.12 %. These results show a good performance for the analysis of Sn(II) at traces of concentration.

3.5.4. Signal of Enrichment

Signal of enrichment is done by comparing the absorbance produced by the gas-liquid reactor-separator modified with a gas-liquid reactor-separator commercially available (from

the factory-made, EHG 3000 GBC) at concentrations of Sn(II) standard of 50 and 100 ppb. Measurement results as shown in Fig. 10. From the results of this research data showed that the reactor-gas-liquid separator is integrated to give the signal for an increase to 1.55 times for 50 ppb and 1.51 times for 100 ppb Sn(II) standard. Increased occurrence of significant signal was partly due to the effective function of the gas-liquid reactor-separator integrated which has developed.

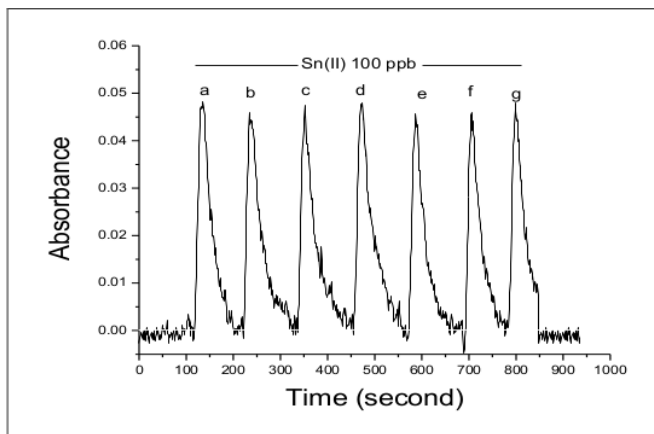

Fig. 9. Analytical signal profile for 100 ppb Sn(II) reproducibility at various measurement

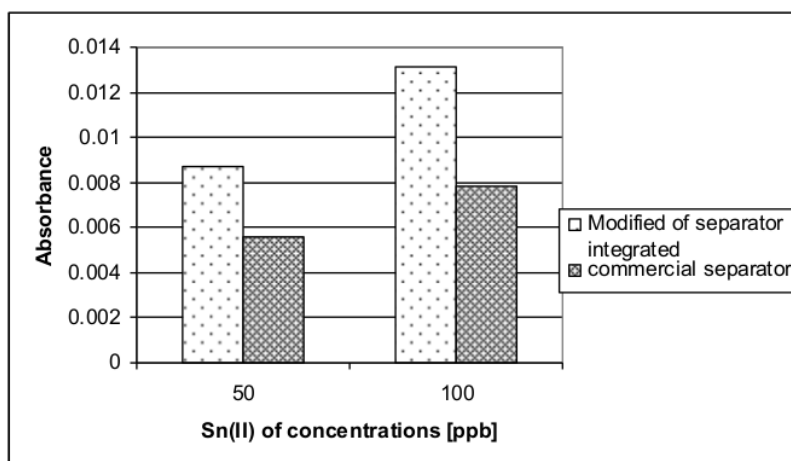

Fig. 10. Comparison of gas-liquid separator integrated and commercial separator

3.6. Application of HG-QFAAS in Measuring the Natural Water Sample

The gas-liquid separator that has been made and evaluated was then used in analysis of Sn(II) concentration in water samples from the nature. Spike method was used to see the matrix influence to the measurement. The percentage of recovery was >95 %, as shown in Table 3.

Table 3. Results of determination of Sn(II) in water samples.

Samples	Sn(II), $\mu\text{g L}^{-1}$		Recovery %
	Added	Found	
Bottled drinking water	0	nd*	-
	50	49.24±0.12	98.48±0.03
Ground water	0	nd*	-
	50	47.73±1.85	95.73±0.19
River water	0	nd*	-
	50	48.56±0.41	97.11±0.50
Sea water	0	41.44±1.67	-
	50	87.89±2.06	96.11±1.87
Sediment	0	271.44±2.31	-
	50	311.12±3.76	96.78±3.07

* nd: not detected

Conclusion

The modified gas-liquid reactor-separator integrated to HG-QFAAS method has been proven to enhance the sensitivity of tin determination in liquid samples. The analytical performance in this method is good, indicate this technique is good to be applied for tin analysis at picogram level.

Acknowledgement

We thank to DP₂M-DIKTI Jakarta for the *Penelitian Hibah Bersaing XV 2007-2008* project for the financial support.

References

- Greenwood, N.N., Earnshaw, A. (1989). Chemistry of Elements. Pergamon Press. Oxford.
- Leroy M.J.F., Quevauviller., Donard, O.F.X., Astruc, M., (1998). Determination of Tin Species in Environmental Samples. *Pure & Appl. Chem.*, **70**. pp 2051-2064.
- Hirose, A., Takagi, A., Nishimura, T., Kanno, J., Ema, M. (2004). Review of Reproductive and Developmental Toxicity Induced by Organotins in Aquatic Organisms and Experimental Animals. *Organohalogen Compounds*. Vol. **66**. pp. 3042-3047.
- Garcia, E.S., Alonso, J.L.G., dan Medel, A.S. (1995). Determination of Butyltin Compounds by Means of Hydride Generation/Cold Trapping Gas Chromatography coupled to inductively Coupled Plasma Mass Spectrometric Detection, *Journal of Mass Spectrometry*, **32**, 542 – 549.
- Rauret, G., Rubio, R., dan Padro, A. (1991). Arsenic speciation using HPLC-HG-ICP-AES with gas-liquid separator, *Fresenius Journal of Analytical Chemistry*, **340**, 157 – 162.
- Velitchkova N, Pentcheva E N, Daskalova N (2004). Determination of arsenic, mercury, selenium, thallium, tin and bismuth in environmental materials by inductively coupled plasma emission spectrometry, *Spectrochim Acta Part B*. **59**: pp. 871-878.
- Grotti, M., Rivaro, P., dan Frache, R. (2001). Determination of Butyltin Compounds by High Performance Liquid Chromatography-Hydride Generation-Electrothermal Atomization Atomic Absorption Spectrometry, *Journal Analytical Atomic Spectrometry*. **16**. pp. 270-274.
- Moreda-Piñeiro, J., López-Mahía, P., Muniategui-Lorenzo, M., Fernández-Fernández, E., Prada-Rodríguez, D. (2002). Tin determination in marine sediment, soil, coal fly ash and

- coal slurried samples by hydride generation-electrothermal atomic absorption spectrometry *Anal. Chim. Acta.* **461**, pp. 261–271.
9. Subramanian K S. (1989). Determination of tin in lead/tin solders leachates from copper piping by graphite platform furnace atomic-absorption spectrometry, *Talanta.* **36**(11). Pp. 1075-1080.
 10. Haug, H.O. dan Yiping, L. (1995). Automated Determination of Tin by Hydride Generation using in situ Trapping on Stable Coatings in Graphite Furnace Atomic Absorption Spectrometry, *Spectrochimica Acta Part B.*, **50**, pp. 1311 – 1324.
 11. Pohl, P., Zyrnicki, W. (2002). Study of chemical and spectral interferences in the simultaneous determination of As, Bi, Sb, Se and Sn by hydride generation inductively coupled plasma atomic emission spectrometry *Anal. Chim. Acta.* **468**, pp. 71–79.
 12. Kumar, A.R. dan Riyazuddin, P. (2005). Mechanism of Volatile Hydride Formation and Their Atomization in Hydride Generation Atomic Absorption Spectrometry, *Analytical Sciences*, **21**, pp. 1401-1410.
 13. Anthemidis, A.N., Zachariadis, G.A., Stratis, J.A. (2005). Determination of arsenic(III) and total inorganic arsenic in water samples using an on-line sequential insertion system and hydride generation atomic absorption spectrometry. *Anal. Chim. Acta.* **547** pp. 237–242
 14. Nakahara, T. (2005). Development of Gas-Phase Sample-Introduction Techniques fore Analytical Atomic Spectrometry, *Analytical Sciences*, **21**. 477 – 484.
 15. Puri, B.K., Muñoz-Olivas, R., Ca'mara, C. (2004). A new polymeric adsorbent for screening and pre-concentration of organotin compounds in sediments and seawater samples, *Spectrochimica Acta Part B.* **59** pp. 209–214.
 16. Ritschdorff, E.T., Fitzgerald, N., McLaughlin, R.G.J., dan Brindle, I.D. (2005). The Use Modified Multimode Sample Introduction System for the Simple and rapid Determination of Cadmium by Chemical Vapour Generation Atomic Absorption Spectrometry, *Spectrochimica Acta Part B.*, **60**, pp. 139 – 143.
 17. Grutter, U.M., Hitzke, M., Kresimon, J., and Hirner, A.V. (2001). Derivatization of Organometal(loid) Species by Sodium Borohydride Problems and Solutions. *Journal of Chromatography A.*, **938**, pp. 225 – 236.

ORIGINALITY REPORT

17%

SIMILARITY INDEX

13%

INTERNET SOURCES

10%

PUBLICATIONS

0%

STUDENT PAPERS

MATCH ALL SOURCES (ONLY SELECTED SOURCE PRINTED)

6%

★ doaj.org

Internet Source

Exclude quotes Off

Exclude matches Off

Exclude bibliography On